

# Panasonic®

## Owner's Manual for advanced features

Digital Camera

Model No. **DMC-SZ1**  
**DMC-SZ02**  
**DMC-FH8**

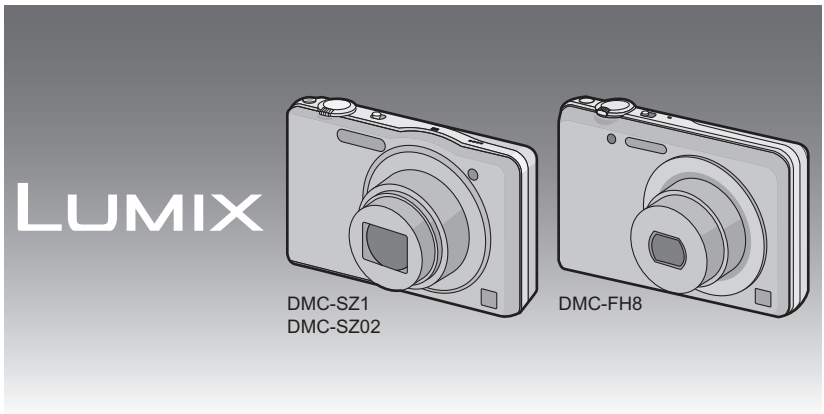

Before connecting, operating or adjusting this product,  
please read the instructions completely.



VQT3Z52  
F1211WT0

# Contents

---

---

## Before Use

---

---

Care of the camera .....	4
Standard Accessories .....	5
Names and Functions of Main Parts .....	6

---

---

## Preparation

---

---

Charging the Battery .....	9
• Inserting the Battery .....	10
• Charging .....	11
• Approximate operating time and number of recordable pictures .....	13
Inserting and Removing the Card (optional) .....	15
About the Built-in Memory/the Card .....	16
• Approximate number of recordable pictures and available recording time .....	18
Setting Date/Time (Clock Set).....	19
• Changing the Clock Setting .....	20
Tips for taking good pictures .....	21
• Fit the strap and hold the camera carefully .....	21
• Preventing jitter (camera shake).....	21

---

---

## Basic

---

---

Selecting the Recording Mode .....	22
Taking pictures using the automatic function (Intelligent Auto Mode) .....	23
• Changing the settings .....	25
Taking pictures with your favorite settings (Normal Picture Mode).....	26
Focusing.....	27
Recording Motion Pictures .....	29
• Recording still pictures while recording motion pictures .....	31
Playing Back Pictures ([Normal Play]) .....	32
• Selecting a picture .....	32
• Displaying Multiple Screens (Multi Playback) .....	33
• Using the Playback Zoom .....	33
Playing Back Motion Pictures.....	34
Deleting Pictures .....	35
• To delete a single picture.....	35
• To delete multiple pictures (up to 50) or all the pictures .....	36

Setting the Menu .....	37
• Setting menu items .....	37
• Using the Quick Menu .....	38
About the Setup Menu.....	39

---

---

## Recording

---

---

About the LCD Monitor .....	46
Using the Zoom .....	47
• Using the Optical Zoom/ Using the Extended Optical Zoom (EZ)/ Using the Intelligent Zoom/ Using the Digital Zoom .....	47
Taking Pictures Using the Built-in Flash.....	49
• Switching to the appropriate flash setting .....	49
Taking Close-up Pictures ([AF Macro]/[Macro Zoom]) .....	52
Taking Pictures with the Self-timer .....	53
Compensating the Exposure .....	54
Record pictures that look like dioramas (Miniature Effect Mode).....	55
Taking pictures that match the scene being recorded (Scene Mode).....	56
• [Portrait].....	57
• [Soft Skin] .....	57
• [Scenery] .....	57
• [Panorama Shot] .....	58
• [Sports] .....	60
• [Night Portrait] .....	60
• [Night Scenery].....	60
• [Food] .....	60
• [Baby1]/[Baby2] .....	61
• [Pet].....	62
• [Sunset].....	62
• [High Sens.].....	62
• [Glass Through].....	62
• [Photo Frame] .....	62
Entering Text.....	63
Using the [Rec] Menu .....	64
• [Picture Size] .....	64
• [Sensitivity] .....	65
• [White Balance] .....	66
• [AF Mode] .....	68
• [i.Exposure] .....	70
• [i.Resolution] .....	70
• [Digital Zoom] .....	70
• [Burst] .....	71
• [Color Mode].....	73
• [AF Assist Lamp] .....	74
• [Red-Eye Removal] .....	74
• [Stabilizer] .....	75
• [Date Stamp] .....	75

• [Clock Set].....	75
Using the [Motion Picture] Menu .....	76
• [Rec Quality] .....	76
• [Continuous AF] .....	76

## Playback/Editing

Various methods of playback .....	77
• [Slide Show] .....	78
• [Filtering Play] .....	80
• [Calendar] .....	81
Having Fun with Recorded Pictures .....	82
• [Auto Retouch] .....	82
• [Beauty Retouch] <b>DMC-FH8</b> .....	83
Using the [Playback] Menu .....	85
• [Upload Set] .....	85
• [Text Stamp] .....	87
• [Video Divide] .....	89
• [Resize] .....	90
• [Cropping] .....	91
• [Favorite] .....	92
• [Print Set] .....	93
• [Protect] .....	95
• [Copy] .....	96

## Connecting to other equipment

Playing Back Pictures on a TV Screen .....	97
Saving the Recorded Still Pictures and Motion Pictures .....	98
• Copy by inserting the SD card into the recorder .....	98
• Copy the playback image using an AV cable .....	99
• Copying to a PC using "PHOTOfunSTUDIO" .....	100
Connecting to a PC .....	101
• Loading still pictures or motion pictures .....	102
• Uploading the images to sharing sites .....	104
Printing the Pictures .....	105
• Selecting a single picture and printing it .....	106
• Selecting multiple pictures and printing them .....	106
• Print Settings .....	107

## Others

Screen Display .....	110
Cautions for Use .....	112
Message Display .....	117
Troubleshooting .....	119

• Please note that the actual controls and components, menu items, and other information for your digital camera may differ from those in the illustrations and screens provided in this manual. When operation or other information is more or less the same between models, **DMC-SZ1** are used as examples for the instructions provided in this manual.

• The operations, procedures, or functions that differ among models are indicated separately, together with the relevant model number.

e.g.:

**DMC-SZ1**

**DMC-FH8**

## Care of the camera

### Do not subject to strong vibration, shock, or pressure.

- The lens, LCD monitor, or external case may be damaged if used in the following conditions.
  - Drop or hit the camera.
  - Sit down with the camera in your trousers pocket or forcefully insert it into a full or tight bag, etc.
  - Attach any items such as accessories to the strap attached to the camera.
  - Press hard on the lens or the LCD monitor.

### This camera is not dust/splash/water proof.

#### Avoid using the camera in places with a lot of dust, water, sand, etc.

- Liquid, sand and other foreign material may get into the space around the lens, buttons, etc. Be particularly careful since it may not just cause malfunctions, but it may also become irreparable.
  - Places with a lot of sand or dust.
  - Places where water can come into contact with this unit, such as when using it on a rainy day or at the beach.



### ■ About Condensation (When the lens is fogged up)

- Condensation occurs when the ambient temperature or humidity changes. Be careful of condensation since it causes lens stains, fungus and camera malfunction.
- If condensation occurs, turn the camera off and leave it for about 2 hours. The fog will disappear naturally when the temperature of the camera becomes close to the ambient temperature.



## Standard Accessories

Check that all the accessories are supplied before using the camera.

- The accessories and their shape will differ depending on the country or area where the camera was purchased.  
For details on the accessories, refer to Basic Owner's Manual.
- Battery Pack is indicated as **battery pack** or **battery** in the text.
- SD Memory Card, SDHC Memory Card and SDXC Memory Card are indicated as **card** in the text.
- **The card is optional.**  
**You can record or play back pictures on the built-in memory when you are not using a card.**
- If any accessories are lost, customers in the USA and Puerto Rico should contact Panasonic's parts department at 1-800-833-9626 and customers in Canada should contact 1-800-99-LUMIX (1-800-995-8649) for further information about obtaining replacement parts.

## Names and Functions of Main Parts

- 1 Flash (P49)
- 2 Lens (P4, 113)
- 3 Self-timer indicator (P53)  
AF Assist Lamp (P74)

DMC-SZ1 DMC-SZ02

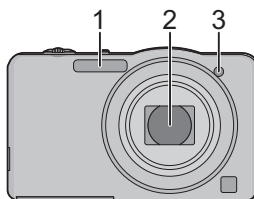

DMC-FH8

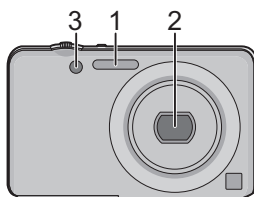

- 4 LCD monitor (P46, 110, 113)
- 5 [MENU/SET] button (P37)
- 6 [DISP.] button (P46)
- 7 [Q.MENU] (P38)/[/↵] (Delete/Cancel) button (P35)
- 8 [MODE] button (P22, 77)
- 9 REC/PLAY switch (P22, 32)
- 10 Charging lamp (P11)

DMC-SZ1 DMC-SZ02

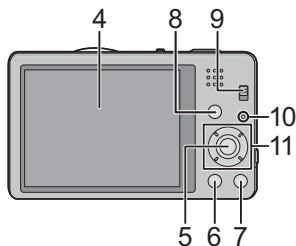

DMC-FH8

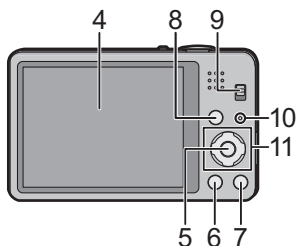

11 Cursor buttons

- (A): ▲/Exposure compensation (P54)
- (B): ▼/Macro Mode (P52)  
AF Tracking (P69)
- (C): ◀/Self-timer (P53)
- (D): ▶/Flash setting (P49)

DMC-SZ1 DMC-SZ02

DMC-FH8

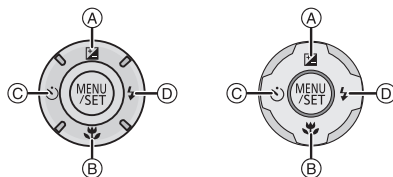

In this owner's manual, the cursor buttons are described as shown in the figure below or described with ▲/▼/◀/▶.  
e.g.: When you press the ▼ (down) button

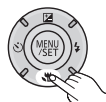

or Press ▼

12 Strap eyelet

- Be sure to attach the strap when using the camera to ensure that you will not drop it.

13 Lens barrel

14 [AV OUT/DIGITAL] socket (P11, 97, 102, 105)

DMC-SZ1 DMC-SZ02

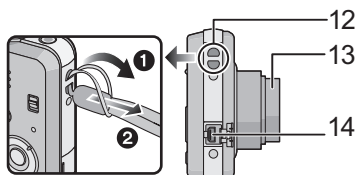

DMC-FH8

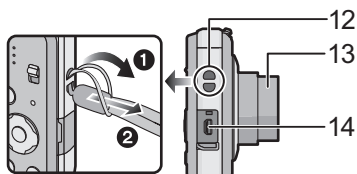

- 15 Speaker (P41)
- Be careful not to cover the speaker with your finger. Doing so may make sound difficult to hear.
- 16 Camera ON/OFF switch (P19)
- 17 Zoom lever (P47)
- 18 Microphone
- 19 Shutter button (P23, 26)
- 20 Motion picture button (P29)
- 21 Tripod receptacle
- 22 Card/Battery door (P10, 15)
- 23 Release lever (P10, 15)

**DMC-SZ1** **DMC-SZ02**

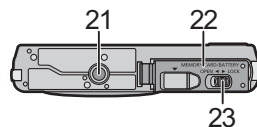
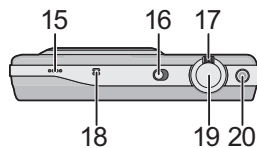

**DMC-FH8**

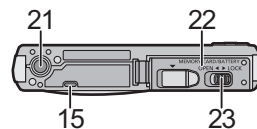
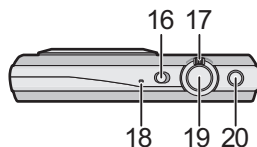



## Charging the Battery

Use the dedicated AC adaptor (supplied), USB connection cable (supplied) and battery.

- The battery is not charged when the camera is shipped. Charge the battery before use.
- Charge the battery only when it is inserted in the camera.

Camera conditions	Charge
Power off (or [Sleep Mode] (P42) is activated)	○
Power on	—*

- \* The camera can be supplied with power from a power outlet via the USB connection cable (supplied) only during playback mode. (The battery is not charged.)
- When there is no remaining battery power, charging may be performed regardless of whether the power switch is [ON] or [OFF].
- If no battery is inserted, no charging or power is supplied.

### ■ About batteries that you can use with this unit

It has been found that counterfeit battery packs which look very similar to the genuine product are made available for purchase in some markets. Some of these battery packs are not adequately protected with internal protection to meet the requirements of appropriate safety standards. There is a possibility that these battery packs may lead to fire or explosion. Please be advised that we are not liable for any accident or failure occurring as a result of use of a counterfeit battery pack. To ensure that safe products are used, we recommend that a genuine Panasonic battery pack is used.

## Inserting the Battery

Insert the battery into the camera to charge it.

- Check that this unit is turned off.

- 1** Slide the release lever in the direction of the arrow and open the card/battery door.

- Always use genuine Panasonic batteries.
- If you use other batteries, we cannot guarantee the quality of this product.

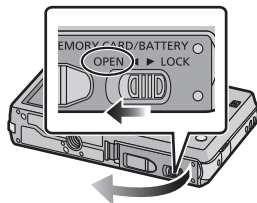

- 2** Being careful about the battery orientation, insert all the way until you hear a locking sound and then check that it is locked by lever (A). Pull the lever (A) in the direction of the arrow to remove the battery.

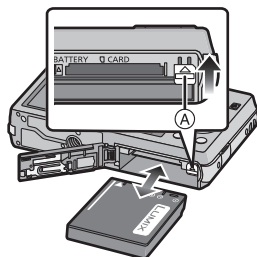

- 3** **1**: Close the card/battery door.

- 2**: Slide the release lever in the direction of the arrow.

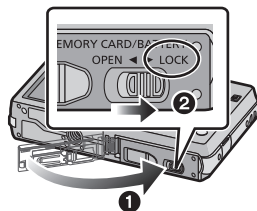

### Note

- Turn the camera off and wait for the "LUMIX" display on the LCD monitor to clear before removing the battery. (Otherwise, this unit may no longer operate normally and the card itself may be damaged or the recorded pictures may be lost.)

## Charging

- Charge the battery in areas with an ambient temperature, between 10 °C and 30 °C (50 °F and 86 °F) (same as the battery temperature), is recommended.

**Check that this unit is turned off.**

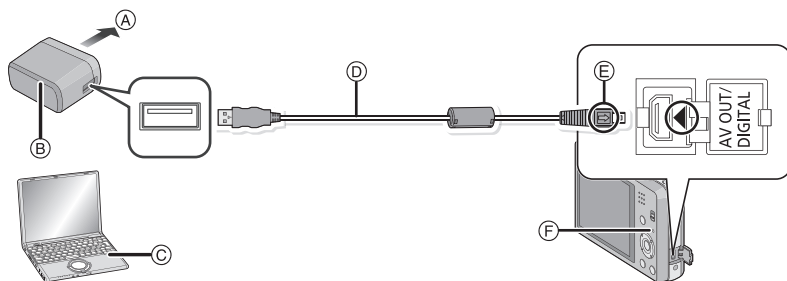

- (A) To power outlet
- (B) AC adaptor (supplied)
- (C) PC (Turn the power on)
- (D) USB connection cable (supplied)
  - Check the directions of the connectors, and plug them straight in or unplug them straight out. (Otherwise the connectors may bend out of shape, which may cause malfunction.)
- (E) Align the marks, and insert.
- (F) Charging lamp

### (Charging from the power outlet)

**Connect the AC adaptor (supplied) and this camera with the USB connection cable (supplied), and insert the AC adaptor (supplied) into the power outlet.**

- Use the AC adaptor (supplied) indoors.

### (Charging from a computer)

**Connect the computer and this camera with the USB connection cable (supplied).**

- Charging may not be possible depending on computer specifications.
- If the computer enters a suspended state while charging the battery, charging will stop.
- Connecting this camera to a notebook computer that is not connected to a power outlet will cause the notebook computer battery to drain faster. Do not leave the camera connected for extended periods of time.
- Be sure to always connect the camera to a computer USB terminal. Do not connect the camera to a monitor, keyboard or printer USB terminal, or a USB hub.

## ■ About the charging lamp

**On:** Charging.

**Off:** Charging has completed. (When charging is complete, disconnect the camera from the power outlet or computer.)

## ■ Charging time

When using the AC adaptor (supplied)

Charging time	Approx. 180 min
---------------	-----------------

- The indicated charging time is for when the battery has been discharged completely. The charging time may vary depending on how the battery has been used. The charging time for the battery in hot/cold environments or a battery that has not been used for a long time may be longer than normal.
- The charging time when connected to the computer depends on the computer's performance.

## ■ Battery indication

The battery indication is displayed on the LCD monitor.



- The indication turns red and blinks if the remaining battery power is low. Recharge the battery or replace it with a fully charged battery.

### Note

- **Do not leave any metal items (such as clips) near the contact areas of the power plug. Otherwise, a fire and/or electric shocks may be caused by short-circuiting or the resulting heat generated.**
- Do not use any other USB connection cables except the supplied one. Use of cables other than the supplied USB connection cable may cause malfunction.
- Do not use a USB extension cable.
- The AC adaptor (supplied) and USB connection cable (supplied) are for this camera only. Do not use them with other devices.
- Remove the battery after use. (The battery will be exhausted if left for a long period of time after being charged.)
- The battery becomes warm after using and during and after charging. The camera also becomes warm during use. This is not a malfunction.
- The battery can be recharged even when it still has some power left, but it is not recommended that the battery charge be frequently topped up while the battery is fully charged. (Since characteristic swelling may occur.)
- If a problem occurs in the power outlet, such as a power outage, charging may not be completed normally. If this happens, disconnect the USB connection cable (supplied) and connect it again.
- If the charging lamp does not turn on or blinks when you connect the AC adaptor (supplied) or PC, this indicates that the charging has been stopped because the unit is not in a temperature range suitable for charging, and does not indicate a fault. Reconnect the USB connection cable (supplied) in a location where the ambient temperature (and the temperature of battery) is in a 10 °C to 30 °C (50 °F to 86 °F) range, and try charging again.

## Approximate operating time and number of recordable pictures

### ■ Recording still pictures

DMC-SZ1

DMC-SZ02

<b>Number of recordable pictures</b>	<b>Approx. 250 pictures</b>	By CIPA standard in Normal Picture Mode
<b>Recording time</b>	<b>Approx. 125 min</b>	

DMC-FH8

<b>Number of recordable pictures</b>	<b>Approx. 260 pictures</b>	By CIPA standard in Normal Picture Mode
<b>Recording time</b>	<b>Approx. 130 min</b>	

### Recording conditions by CIPA standard

- CIPA is an abbreviation of [Camera & Imaging Products Association].
- Temperature: 23 °C (73.4 °F)/Humidity: 50%RH when LCD monitor is on.
- Using a Panasonic SD Memory Card (32 MB).
- Using the supplied battery.
- Starting recording 30 seconds after the camera is turned on. (When the Optical Image Stabilizer function is set to [ON].)
- **Recording once every 30 seconds** using full flash every second recording.
- Rotating the zoom lever from Tele to Wide or vice versa in every recording.
- Turning the camera off every 10 recordings and leaving it until the temperature of the battery decreases.

**The number of recordable pictures varies depending on the recording interval time. As the recording interval time becomes longer, the number of recordable pictures decreases. [For example, if you were to take one picture every two minutes, then the number of pictures would be reduced to approximately one-quarter of the number of pictures given above (based upon one picture taken every 30 seconds).]**

### ■ Recording motion pictures

When recording with picture quality set to [HD]

<b>Recordable time</b>	<b>Approx. 90 min</b>
<b>Actual recordable time</b>	<b>Approx. 45 min</b>

- These times are for an ambient temperature of 23 °C (73.4 °F) and a humidity of 50%RH. Please be aware that these times are approximate.
- Actual recordable time is the time available for recording when repeating actions such as switching the power supply [ON]/[OFF], starting/stopping recording, zoom operation, etc.
- Maximum time to record motion pictures continuously is 29 minutes 59 seconds. The maximum available recording time continuously is displayed on the screen.

## ■ Playback

Playback time

Approx. 240 min

 Note

- **The operating times and number of recordable pictures will differ according to the environment and the operating conditions.**

For example, in the following cases, the operating times will shorten and the number of recordable pictures is reduced:

- In low-temperature environments, such as on ski slopes.
  - When using [LCD Mode].
  - When operations such as flash and zoom are used repeatedly.
- When the operating time of the camera becomes extremely short even after properly charging the battery, the life of the battery may have expired. Buy a new battery.

## Inserting and Removing the Card (optional)

- Check that this unit is turned off.
- We recommend using a Panasonic card.

**1** Slide the release lever in the direction of the arrow and open the card/battery door.

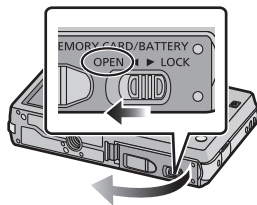

**2** Push it securely all the way until you hear a “click” while being careful about the direction in which you insert it.

To remove the card, push the card until it clicks, then pull the card out upright.

(A): Do not touch the connection terminals of the card.

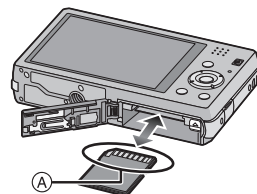

**3** **1**: Close the card/battery door.

**2**: Slide the release lever in the direction of the arrow.

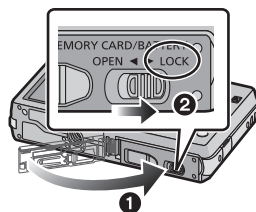

### Note

- Turn the camera off and wait for the “LUMIX” display on the LCD monitor to clear before removing the card. (Otherwise, this unit may no longer operate normally and the card itself may be damaged or the recorded pictures may be lost.)

## About the Built-in Memory/the Card

The following operations can be performed using this unit:

When a card has not been inserted	Pictures can be recorded on the built-in memory and played back.
When a card has been inserted	Pictures can be recorded on the card and played back.

### • When using the built-in memory:

 →  (access indication\*)

### • When using the card:

 (access indication\*)

\* The access indication is displayed in red when pictures are being recorded on the built-in memory (or the card).



## Built-in Memory

- You can copy the recorded pictures to a card. (P96)
- **Memory size: Approx. 70 MB**
- The access time for the built-in memory may be longer than the access time for a card.

## Card

The following cards, which conform to the SD video standard, can be used with this unit. (These cards are indicated as **card** in the text.)

	Remarks
<b>SD Memory Card</b> (8 MB to 2 GB)	<ul style="list-style-type: none"> <li>• Use a card with SD Speed Class* with "Class 4" or higher when recording motion pictures.</li> <li>• SDHC Memory Card can be used with SDHC Memory Card or SDXC Memory Card compatible equipment.</li> <li>• SDXC Memory Card can only be used with SDXC Memory Card compatible equipment.</li> <li>• Check that the PC and other equipment are compatible when using the SDXC Memory Cards. <a href="http://panasonic.net/avc/sdcard/information/SDXC.html">http://panasonic.net/avc/sdcard/information/SDXC.html</a></li> <li>• Only the cards with capacity listed left can be used.</li> </ul>
<b>SDHC Memory Card</b> (4 GB to 32 GB)	
<b>SDXC Memory Card</b> (48 GB, 64 GB)	

\* SD Speed Class is the speed standard regarding continuous writing. Check via the label on the card, etc.

e.g.:

CLASS 



- Please confirm the latest information on the following website.

<http://panasonic.jp/support/global/cs/dsc/>

(This site is English only.)



 **Note**

- During access (image writing, reading and deleting, formatting etc.), do not turn off the power, remove the battery, card or disconnect the AC adaptor (supplied). Furthermore, do not subject the camera to vibration, impact or static electricity. The card or the data on the card may be damaged, and this unit may no longer operate normally.

**If operation fails due to vibration, impact or static electricity, perform the operation again.**

- Write-Protect switch (A) provided (When this switch is set to the [LOCK] position, no further data writing, deletion or formatting is possible. The ability to write, delete and format data is restored when the switch is returned to its original position.)
- The data on the built-in memory or the card may be damaged or lost due to electromagnetic waves, static electricity or breakdown of the camera or the card. We recommend storing important data on a PC etc.
- Do not format the card on your PC or other equipment. Format it on the camera only to ensure proper operation. (P44)
- Keep the Memory Card out of reach of children to prevent swallowing.

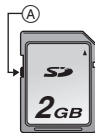

## Approximate number of recordable pictures and available recording time

### ■ About the display of the number of recordable pictures and available recording time

- To switch between the display of number of recordable pictures and available recording time, press [DISP.] several times. (P46)

- (A) Number of recordable pictures
- (B) Available recording time



- The number of recordable pictures and the available recording time are an approximation. (These vary depending on the recording conditions and the type of card.)
- The number of recordable pictures and the available recording time varies depending on the subjects.

### ■ Number of recordable pictures

- [+99999] is displayed if there are more than 100,000 pictures remaining.

**DMC-SZ1**

**DMC-SZ02**

Picture size	Built-in Memory (Approx. 70 MB)	2 GB	32 GB	64 GB
16M (4:3)	11	300	4910	9880
5M (4:3)	25	650	10620	21490
0.3M (4:3)	390	10050	162960	247150

**DMC-FH8**

Picture size	Built-in Memory (Approx. 70 MB)	2 GB	32 GB	64 GB
16M (4:3)	10	300	4910	9880
5M (4:3)	24	650	10620	21490
0.3M (4:3)	380	10050	162960	247160

### ■ Available recording time (when recording motion pictures)

- “h” is an abbreviation for hour, “m” for minute and “s” for second.

Recording quality setting	Built-in Memory (Approx. 70 MB)	2 GB	32 GB	64 GB
HD	—	23m33s	6h28m3s	13h5m5s
VGA	1m42s	51m50s	14h14m1s	28h47m50s

### Note

- Number of recordable pictures/available recording time for the card may decrease when [Upload Set] is performed.
- Maximum time to record motion pictures continuously is 29 minutes 59 seconds. The maximum available recording time continuously is displayed on the screen.

## Setting Date/Time (Clock Set)

- The clock is not set when the camera is shipped.

**1** Slide the REC/PLAY switch to [📷] and then turn the camera on.

- If the language select screen is not displayed, proceed to step 4.

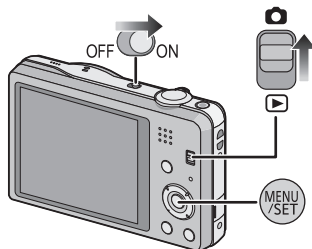

**2** Press [MENU/SET].

**3** Press ▲/▼ to select the language, and press [MENU/SET].

**4** Press [MENU/SET].



**5** Press ◀/▶ to select the items (year, month, day, hour, minute, display sequence or time display format), and press ▲/▼ to set.

(A): Time at the home area

(B): Time at the travel destination

- You can cancel without setting the clock by pressing [🗑️/↩️].

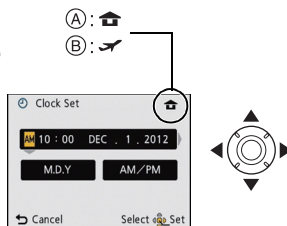

**6** Press [MENU/SET] to set.

**7** Press [MENU/SET].

## Changing the Clock Setting

Select **[Clock Set]** in the **[Rec]** or **[Setup]** menu, and press **[MENU/SET]**. (P37)

- The clock can be reset as shown in steps **5** and **6**.
- **The clock setting is maintained for 3 months using the built-in clock battery even without the battery. (Leave the charged battery in the unit for 24 hours to charge the built-in battery.)**

### Note

- If the clock is not set, the correct date cannot be printed when you order a photo studio to print the picture, or when you stamp the date on the pictures with **[Date Stamp]** or **[Text Stamp]**.
- If the clock is set, the correct date can be printed even if the date is not displayed on the screen of the camera.

## Tips for taking good pictures

### Fit the strap and hold the camera carefully

**Hold the camera gently with both hands, keep your arms still at your side and stand with your feet slightly apart.**

• To prevent dropping, be sure to attach the supplied strap and fit it to your wrist. (P7)

• Be careful not to move the camera when you press the shutter button.

• Be careful not to put your fingers on the flash, AF assist lamp, microphone, speaker or lens etc.

DMC-SZ1

DMC-SZ02

DMC-FH8

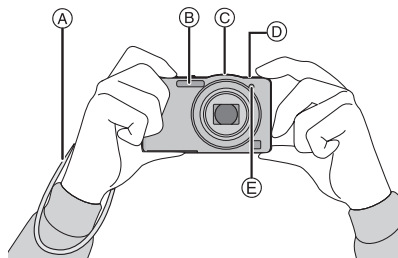

- (A) Strap
- (B) Flash
- (C) Microphone

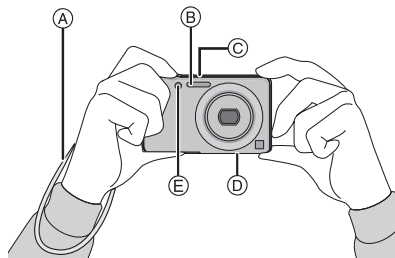

- (D) Speaker
- (E) AF assist lamp

### ■ Direction Detection Function ([Rotate Disp.])

Pictures recorded with the camera held vertically are played back vertically (rotated). (Only when [Rotate Disp.] (P44) is set)

- When the camera is held vertically and tilted up and down to record pictures, the Direction Detection function may not work correctly.
- Motion pictures taken with the camera held vertically are not displayed vertically.

### Preventing jitter (camera shake)

When the Jitter alert ([ⓘ]) appears, use [Stabilizer] (P75), a tripod or the Self-timer (P53).

• Shutter speed will be slower particularly in the following cases. Keep the camera still from the moment the shutter button is pressed until the picture appears on the screen. We recommend using a tripod.

- Slow sync./Red-Eye Reduction
- In [Night Portrait] or [Night Scenery] in Scene Mode

## Selecting the Recording Mode

- 1 Slide the REC/PLAY switch to [📷].
- 2 Press [MODE].

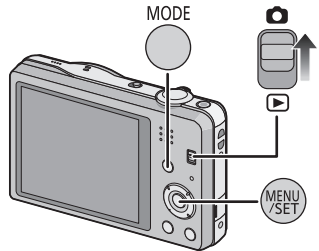

- 3 Press ▲/▼/◀/▶ to select the Recording Mode.
- 4 Press [MENU/SET].

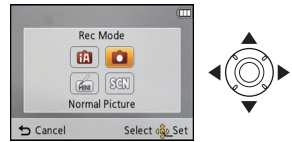

### ■ List of Recording Modes

<b>iA Intelligent Auto Mode (P23)</b>
The subjects are recorded using settings automatically selected by the camera.
<b>📷 Normal Picture Mode (P26)</b>
The subjects are recorded using your own settings.
<b>📷 Miniature Effect Mode (P55)</b>
This is an imaging effect which defocuses the surroundings to make it look like a diorama. (also known as Tilt Shift Focus)
<b>SCN Scene Mode (P56)</b>
This allows you to take pictures that match the scene being recorded.

### Note

- When the mode has been switched from Playback Mode to Recording Mode, the previously set Recording Mode will be set.

Recording Mode: 

## Taking pictures using the automatic function (Intelligent Auto Mode)

The camera will set the most appropriate settings to match the subject and the recording conditions so we recommend this mode for beginners or those who want to leave the settings to the camera and take pictures easily.

- The following functions are activated automatically.
  - Scene Detection/Backlight Compensation/Intelligent ISO sensitivity control/Auto White Balance/Face Detection/[i.Exposure]/[i.Resolution]/[i.ZOOM]/[AF Assist Lamp]/[Red-Eye Removal]/[Stabilizer]/[Continuous AF]

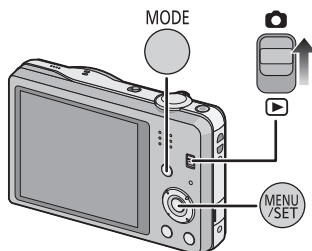

- Slide the REC/PLAY switch to , and then press [MODE].



- Press /// to select [Intelligent Auto], and then press [MENU/SET].



- Press the shutter button halfway to focus.

- The focus indication ① (green) lights when the subject is focused.
- The AF area ② is displayed around the subject's face by the Face Detection function. In other cases, it is displayed at the point on the subject which is in focus.
- The minimal distance (how close you can be to the subject) will change depending on the zoom factor. Please check with the recordable range display on the screen. (P27)
- You can set the AF tracking by pressing . For details, refer to P69. (AF tracking is canceled by pressing  again)

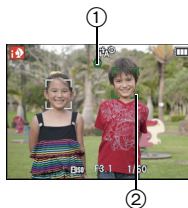







- Press the shutter button fully (push it in further), and take the picture.



## Scene Detection





When the camera identifies the optimum scene, the icon of the scene concerned is displayed in blue for 2 seconds, after which its color changes to the usual red.

### When taking pictures

iA →	 [i-Portrait]	 [i-Scenery]
	 [i-Macro]	 [i-Night Portrait]*
	 [i-Night Scenery]	 [i-Sunset]

\* Only when [iA] is selected.

### When recording motion pictures

iA →	 [i-Portrait]	 [i-Scenery]
	 [i-Low Light]	 [i-Macro]

- [iA] is set if none of the scenes are applicable, and the standard settings are set.
- When [iA] or [iA] is selected, the camera automatically detects a person's face, and it will adjust the focus and exposure. **(Face Detection)**
- If a tripod is used, for instance, and the camera has judged that camera shake is minimal when the Scene Mode has been identified as [iA], the shutter speed will be set to a maximum of 8 seconds. Take care not to move the camera while taking pictures.
- Due to conditions such as the ones below, a different scene may be identified for the same subject.
  - Subject conditions: When the face is bright or dark, the size of the subject, the color of the subject, the distance to the subject, the contrast of the subject, when the subject is moving
  - Recording conditions: Sunset, sunrise, under low brightness conditions, when the camera is shaken, when zoom is used
- For the best results, it is recommended that you take pictures in the appropriate Recording Mode.
- **The Backlight Compensation**
  - Backlight refers to when light comes from the back of a subject. In this case, the subject will become dark, so this function compensates the backlight by brightening the picture. In Intelligent Auto Mode, backlight compensation works automatically. The [iA] is displayed on the screen when backlighting is detected. The actual backlighting conditions and [iA] may not always match.



## Changing the settings

Following menus can be set.

Menu	Item
[Rec]	[Picture Size]*/[Burst]*/[Color Mode]*
[Motion Picture]	[Rec Quality]
[Setup]	[Clock Set]/[World Time]/[Beep]*/[Language]/[Stabilizer Demo.]

• For the setting method of the menu, refer to [P37](#).

\* Settings may be different from other Recording Modes.

• **Menus specific to Intelligent Auto Mode**

– Color setting of [Happy] is available in [Color Mode]. It is possible to automatically take a picture with a higher level of brilliance for the color brightness and vividness.

### About the flash (P49)

- When [i↔A] is selected, [i↔A], [i↔A⊙], [i↔S⊙] or [i↔S] is set depending on the type of subject and brightness.
- When [i↔A⊙], [i↔S⊙] is set, Digital Red-Eye Correction is enabled.
- Shutter speed will be slower during [i↔S⊙] or [i↔S].

Recording Mode: 

## Taking pictures with your favorite settings (Normal Picture Mode)

The camera automatically sets the shutter speed and the aperture value according to the brightness of the subject.

You can take pictures with greater freedom by changing various settings in the [Rec] menu.

- Slide the REC/PLAY switch to , and then press [MODE].

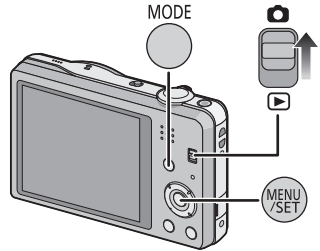

- Press /// to select [Normal Picture], and then press [MENU/SET].



- Aim the AF area at the point you want to focus on.

- Press the shutter button halfway to focus and then press it fully to take the picture.

- (A) ISO sensitivity
- (B) Aperture value
- (C) Shutter speed

- Aperture value and shutter speed is displayed in red when correct exposure is not achieved. (Exclude when using a flash)



- (A) ISO sensitivity
- (B) Aperture value
- (C) Shutter speed

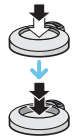

# Focusing

Aim the AF area at the subject, and then press the shutter button halfway.

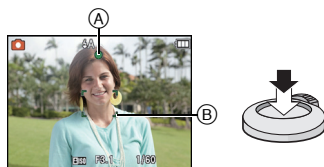

Focus	When the subject is focused	When the subject is not focused
Focus indication (A)	On	Blinks
AF area (B)	White → Green	White → Red
Sound	Beeps 2 times	Beeps 4 times

- The AF area may be displayed larger for certain zoom magnifications and in dark places.

## ■ About focus range

The focus range is displayed when operating the zoom.

- The focus range is displayed in red when it is not focused after pressing the shutter button halfway.

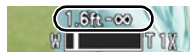

The focus range may change gradually depending on the zoom position.

e.g.: Range of focus during the Intelligent Auto Mode

DMC-SZ1

DMC-SZ02

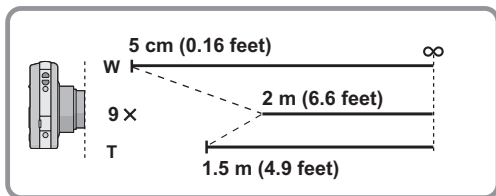

DMC-FH8

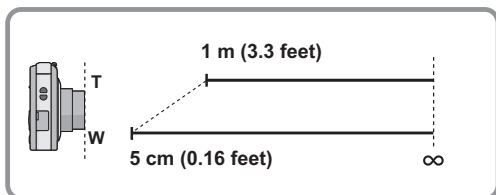

■ When the subject is not in focus (such as when it is not in the center of the composition of the picture you want to take)

- 1 Aim the AF area at the subject, and press the shutter button half way to fix the focus and exposure.
- 2 Press and hold the shutter button half way while moving the camera as you compose the picture.

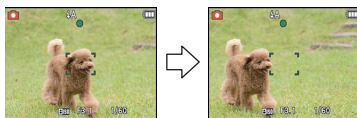

- You can repeatedly retry the actions in step 1 before pressing the shutter button fully.

■ Subject and recording conditions which are difficult to focus in

- Fast-moving subjects, extremely bright subjects or subjects without contrast
- When recording subjects through windows or near shiny objects
- When it is dark or when jitter occurs
- When the camera is too close to the subject or when taking a picture of both distant and near subjects

Applicable modes:    SCN

## Recording Motion Pictures

### 1 Start recording by pressing the motion picture button.

(A) Available recording time

(B) Elapsed recording time

- You can record motion pictures fitting each Recording Mode.
- Release the motion picture button right after you press it.
- The recording state indicator (red) (C) will flash while recording motion pictures.
- For the setting of [Rec Quality], refer to P76.



### 2 Stop the recording by pressing the motion picture button again.

#### ■ About the recording format for recording motion pictures

This unit can record motion pictures in MP4 format.

#### MP4:

This is a simpler video format best used when extensive editing is needed, or when uploading videos to the internet.

#### ■ About the compatibility of the recorded motion pictures

Even if a compatible MP4 playback device is used, the video or sound quality of the recorded motion pictures may be poor, or they may not be able to be played. There may also be times when the recorded data is not displayed properly. If you experience such issues, please play back the video on this camera.

- For details on MP4 compatible devices, refer to the support sites below.

<http://panasonic.jp/support/global/cs/dsc/>

(This Site is English only.)

 **Note**

- When recording to the built-in memory, [Rec Quality] is fixed to [VGA].
- The available recording time displayed on the screen may not decrease regularly.
- Depending on the type of the card, the card access indication may appear for a while after recording motion pictures. This is not a malfunction.
- The screen may be blacked out momentarily, or the unit may record noise due to static electricity or electromagnetic waves etc. depending on the environment of the motion picture recording.
- Even if the aspect ratio setting is the same in still pictures and motion pictures, the angle of view may change at the start of the motion picture recording.  
When [Video Rec Area] (P42) is set to [ON], angle of view during motion picture recording is displayed.
- **About zooming while recording motion pictures**
  - If the Extended Optical Zoom was used before pressing the motion picture button, settings will be canceled, and the recordable range will change drastically.
  - If you operate the zoom etc. while recording motion pictures, the sound of the operation may be recorded.
  - **DMC-SZ1** **DMC-SZ02**  
The zoom speed will be slower than usual when recording motion pictures.
  - **DMC-SZ1** **DMC-SZ02**  
Operating the zoom while recording motion pictures can take time for the image to come into focus.
  - **DMC-FH8**  
The optical zoom magnification cannot be changed after starting to record motion pictures. However, Intelligent Zoom can be used by setting [i.Resolution] (P70) in the [Rec] menu to [i.ZOOM]. Also, the Digital Zoom can be used by setting the [Digital Zoom] (P70) in the [Rec] menu to [ON]. For details about the zoom range, refer to P47. If motion picture recording was started within the optical zoom area, the zoom setting returns to the original magnification when motion picture recording is finished.
- If you end motion picture recording after a short time when using Miniature Effect Mode, the camera may go on recording for a certain period. Continue to hold the camera until the recording ends.
- It is recommended to use a fully charged battery when recording motion pictures.
- Motion pictures cannot be recorded with [Panorama Shot] in Scene Mode.
- It will be recorded in following categories for certain Scene Modes. A motion picture recording matching each scene will be performed for the ones not listed below.

Selected Scene Mode	Scene Mode while recording motion picture
[Baby1]/[Baby2]	Portrait Mode
[Night Portrait], [Night Scenery]	Low Light Mode
[Sports], [Pet], [Photo Frame]	Normal motion picture

## Recording still pictures while recording motion pictures

Still pictures can be recorded even while recording a motion picture. (Simultaneous recording)

**During motion picture recording, press the shutter button fully to record a still picture.**

### Note

- You can record up to 5 pictures per motion picture recording.
- The picture size is fixed to 3.5M (16:9).
- Simultaneous recording is not possible when [Rec Quality] is set to [VGA].
- If you press the shutter button halfway to take a picture while recording a motion picture, the camera will refocus and the refocus movement will be recorded to the motion picture. To prioritize the motion picture image, taking still pictures by fully pressing the shutter button is recommended.
- Picture size and number of recordable pictures are displayed by pressing the shutter button halfway.
- Recording of motion picture will continue after taking the still picture.
- In Miniature Effect Mode, recording will begin shortly after pressing the shutter button fully.
- Zooming may stop when a picture is recorded while zooming.
- Operation sound of the shutter button may be recorded when a picture is taken during motion picture recording.
- **The flash setting is fixed to [⊕].**
- When the subject has a bright part, reddish stripes may appear on the LCD monitor. Alternatively, part or all of the LCD monitor may turn a reddish color.

## Playing Back Pictures ([Normal Play])

Slide the REC/PLAY switch to [▶].

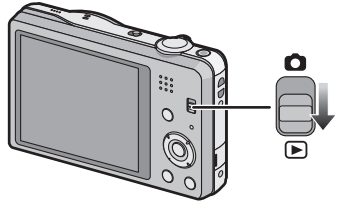

### Note

- This camera complies with the DCF standard “Design rule for Camera File system” established by JEITA “Japan Electronics and Information Technology Industries Association” and with Exif “Exchangeable Image File Format”. Files that do not comply with the DCF standard cannot be played back.
- Pictures recorded with another camera may not be able to play back on this unit.
- The lens barrel retracts about 15 seconds after switching from Recording Mode to Playback Mode.

## Selecting a picture

Press ◀ or ▶.

- ◀: Play back the previous picture
- ▶: Play back the next picture

- Ⓐ File number
- Ⓑ Picture number

- If you press and hold ◀/▶, you can play back the pictures in succession.
- Speed of picture Forwarding/Rewinding changes depending on the playback status.

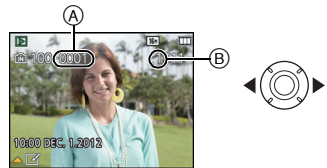



## Displaying Multiple Screens (Multi Playback)

### Rotate the zoom lever towards [ ] (W).

1 screen → 12 screens → 30 screens → Calendar screen display

(A) Number of the selected picture and the total number of recorded pictures

- Rotate the zoom lever towards [Q] (T) to return to the previous screen.
- Pictures displayed using [ ] cannot be played back.

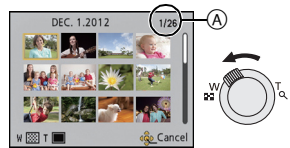

### ■ To return to normal playback

Press ▲/▼/◀/▶ to select a picture and then press [MENU/SET].

## Using the Playback Zoom

### Rotate the zoom lever towards [Q] (T).

1× → 2× → 4× → 8× → 16×

- When you rotate the zoom lever towards [ ] (W) after enlarging the picture, the magnification becomes lower.
- When you change the magnification, the zoom position indication (B) appears for about 2 seconds, and the position of the enlarged section can be moved by pressing ▲/▼/◀/▶.
- The more a picture is enlarged, the more its quality deteriorates.

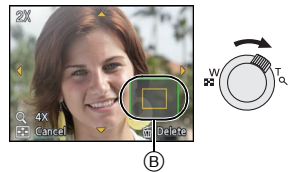

## Playing Back Motion Pictures

This unit was designed to play motion pictures using the MP4 and QuickTime Motion JPEG formats.

Press ◀/▶ to select a picture with a Motion Picture icon (such as [MP4 VGA]), and then press ▲ to play back.

(A) Motion picture icon

(B) Motion picture recording time

• After playback starts, the elapsed playback time is displayed on the screen.

For example, 8 minutes and 30 seconds is displayed as [8m30s].



### ■ Operations performed during Motion Picture Playback

The cursor displayed during playback is the same as ▲/▼/◀/▶.

▲	Play/Pause	
▼	Stop	
◀	Fast rewind*/ Frame-by-frame rewind (while pausing)	
▶	Fast forward*/ Frame-by-frame forward (while pausing)	
[W]	Reduce volume level	
[T]	Increase volume level	

\* The fast forward/rewind speed increases if you press ▶/◀ again.

### Note



- When using a high capacity card, it is possible that fast rewinding may be slower than usual.
- To play back the motion pictures recorded by this unit on a PC, use the "PHOTOfunSTUDIO" software on the CD-ROM (supplied).
- Motion pictures recorded with other camera may not be able to play back on this unit.
- Be careful not to block the speaker of the camera during playback.
- Motion pictures recorded in Miniature Effect Mode play back at approximately 10 times speed.

## Deleting Pictures

**Once deleted, pictures cannot be recovered.**

- Pictures on the built-in memory or the card that are being played back will be deleted.
- Pictures that are not in the DCF standard or those that are protected cannot be deleted.

### To delete a single picture

**Select the picture to be deleted, and then press [  /  ].**

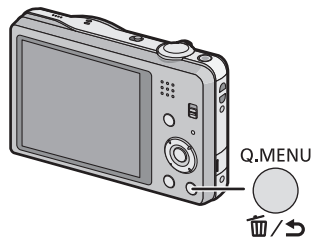

- Confirmation screen is displayed.  
Picture is deleted by selecting [Yes].



## To delete multiple pictures (up to 50) or all the pictures

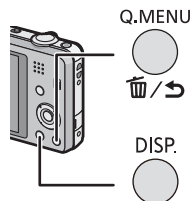



**1** Press [  /  ].



**2** Press  /  to select [Delete Multi] or [Delete All] and then press [MENU/SET].

- [Delete All] → Confirmation screen is displayed. Pictures are deleted by selecting [Yes].
- It is possible to delete all pictures except the ones set as favorite when [All Delete Except Favorite] is selected with the [Delete All] set.



**3** (When [Delete Multi] is selected) Press  /  /  /  to select the picture, and then press [DISP.] to set. (Repeat this step.)

-  appears on the selected pictures. If [DISP.] is pressed again, the setting is canceled.

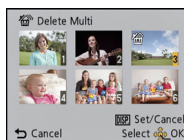

**4** (When [Delete Multi] is selected) Press [MENU/SET].

- Confirmation screen is displayed. Pictures are deleted by selecting [Yes].



### Note

- Do not turn the camera off while deleting. Use a battery with sufficient battery power.
- Depending on the number of pictures to be deleted, it may take some time to delete them.

## Setting the Menu

The camera comes with menus that allow you to choose the settings for taking pictures and playing them back just as you like and menus that enable you to have more fun with the camera and use it more easily.

In particular, the [Setup] menu contains some important settings relating to the camera's clock and power. Check the settings of this menu before proceeding to use the camera.

### Setting menu items

Example: In the [Rec] menu, change [AF Mode] from [■] ([1-Area]) to [👤] ([Face Detection])

**1** Press [MENU/SET].

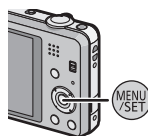

**2** Press ◀/▶ to select menu and then press [MENU/SET].



Menu	Description of settings
<b>[Rec] (P64 to 75)</b> (Recording Mode only)	The menu lets you set the Coloring, Sensitivity or Number of pixels, etc. of pictures you are recording.
<b>[Motion Picture] (P76)</b> (Recording Mode only)	This menu lets you set the setting for motion pictures such as recording quality.
<b>[Playback] (P85 to 96)</b> (Playback Mode only)	This menu lets you set the Protection, Cropping or Print Settings, etc. of recorded pictures.
<b>[Setup] (P39 to 45)</b>	This menu lets you perform the clock settings, beep tone settings and other settings which make it easier for you to operate the camera.

### 3 Press ▲/▼ to select the menu item and then press [MENU/SET].

(A) Menu screen page

- It will switch to the next page when you reach the bottom. (It will also switch by rotating the zoom lever)

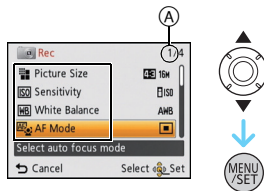

### 4 Press ▲/▼ to select the setting and then press [MENU/SET].

- Depending on the menu item, its setting may not appear or it may be displayed in a different way.

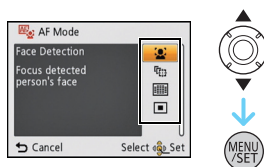

#### ■ Close the menu

Press [Q.MENU] several times or press the shutter button halfway.

#### Note

- There are functions that cannot be set or used depending on the modes or menu settings being used on the camera due to the specifications.

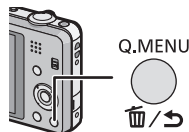

## Using the Quick Menu

By using the Quick Menu, some of the menu settings can be easily found.

- The features that can be adjusted using Quick Menu are determined by the mode or a display style the camera is in.

### 1 Press [Q.MENU] when recording.

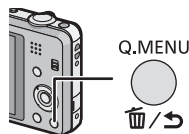

### 2 Press ▲/▼/◀/▶ to select the menu item and the setting and then press [MENU/SET] to close the menu.

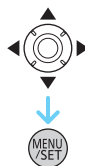



## About the Setup Menu

[Clock Set], [Sleep Mode] and [Auto Review] are important items. Check their settings before using them.

For details on how to select the [Setup] menu settings, refer to P37.

⌚ [Clock Set]	Setting Date/Time.
---------------	--------------------

- Refer to P19 for details.

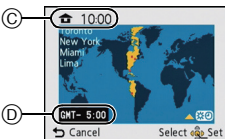
 [World Time]	<p>Set the time in your home area and travel destination. You can display the local times at the travel destinations and record them on the pictures you take.</p> <p><b>After selecting [Destination] or [Home], press ◀/▶ to select an area, and press [MENU/SET] to set.</b></p> <ul style="list-style-type: none"> <li>• Set [Home] first thing after purchasing. [Destination] can be set after setting up [Home].</li> </ul> <p><b>✈ [Destination]:</b> Travel destination area</p> <p>(A) Current time of the destination area (B) Time difference from home area</p> <p><b>🏠 [Home]:</b> Your home area</p> <p>(C) Current time (D) Time difference from GMT (Greenwich Mean Time)</p>	
		

- Press ▲ if you are using Summer Time [☀]. (The time will move forward by 1 hour.) Press ▲ once more to return to the normal time.
- If you cannot find the travel destination in the areas displayed on the screen, set by the time difference from the home area.

 <b>[Travel Date]</b>	<p>Departure date and return date of the travel as well as the name of the travel destination can be set.</p> <p>You can display the number of days that have passed when playing back the pictures and stamp it on the recorded pictures with [Text Stamp] (P87).</p>
	<p><b>[Travel Setup]:</b></p> <p><b>[SET]:</b></p> <p>Departure date and return date are set. Elapsed days (how many days after) of the travel are recorded.</p> <p><b>[OFF]:</b></p> <p>Elapsed days are not recorded.</p> <ul style="list-style-type: none"> <li>• The travel date is automatically canceled if the current date is after the return date. If the [Travel Setup] is set to [OFF], [Location] will also be set to [OFF].</li> </ul>
	<p><b>[Location]:</b></p> <p><b>[SET]:</b></p> <p>Travel destination is recorded at the time of recording.</p> <p><b>[OFF]</b></p> <ul style="list-style-type: none"> <li>• For details on how to enter characters, refer to “Entering Text” on P63.</li> </ul>

- The number of days that have passed since the departure date can be printed out using the “PHOTOfunSTUDIO” bundled software on the CD-ROM (supplied).
- The travel date is calculated using the date in the clock setting and the departure date you set. If you set [World Time] to the travel destination, the travel date is calculated using the date in the clock setting and the travel destination setting.
- The travel date setting is memorized even if the camera is turned off.
- The number of days that have passed since the departure date is not recorded before the departure date.
- [Location] cannot be recorded when taking motion pictures.
- [Travel Date] cannot be set in the Intelligent Auto Mode. Setting of other Recording Mode will be reflected.



<b>•••) [Beep]</b>	This allows you to set the beep and shutter sound.	
	<b>•••) [Beep Level]:</b> [c(] ([Low]) [c(•) ([High]) [X] ([OFF]) <b>•••) [Beep Tone]:</b> [•] [•] [•] [•] [•] [•]	<b>♪ [Shutter Vol.]:</b> [♪] ([Low]) [♪•] ([High]) [♪X] ([OFF]) <b>♪• [Shutter Tone]:</b> [•] [•] [•] [•] [•] [•]

<b>[c(•) [Volume]</b>	Adjust the volume of the speaker to any of the 7 levels.
-----------------------	--

- When you connect the camera to a TV, the volume of the TV speakers does not change. Also, when connected, no sound is output from the camera speakers.

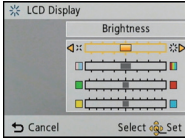

<b>✧ [LCD Display]</b>	Brightness, color, or red or blue tint of the LCD monitor is adjusted.	
	<b>[Brightness]:</b> Adjust the brightness. <b>[Contrast · Saturation]:</b> Adjust the contrast or clarity of colors. <b>[Red Tint]:</b> Adjust the red tint. <b>[Blue Tint]:</b> Adjust the blue tint.	
	<ol style="list-style-type: none"> <li><b>1 Select the settings by pressing ▲/▼, and adjust with ◀/▶.</b></li> <li><b>2 Press [MENU/SET] to set.</b></li> </ol>	

- Some subjects may appear differently from actuality on the LCD monitor. However, this does not affect the recorded pictures.
- When [LCD Mode] is set to [High Angle], [Brightness] and [Contrast · Saturation] cannot be adjusted.

 <b>[LCD Mode]</b>	These menu settings make it easier to see the LCD monitor when you are in bright places or when you are holding the camera high above your head.
	<b>[A*]</b> ([Auto Power LCD])*: The brightness is adjusted automatically depending on how bright it is around the camera.
	<b>[*]</b> ([Power LCD]): The LCD monitor becomes brighter and easier to see even when taking pictures outdoors.
	<b>[Q*]</b> ([High Angle])*: The LCD monitor is easier to see when taking pictures with the camera held high above your head. <b>[OFF]</b>

\* Can be set only when Recording Mode is set.

- High Angle Mode is also canceled if you turn the camera off or [Sleep Mode] is activated.
- The brightness of the pictures displayed on the LCD monitor is increased so some subjects may appear different from real life on the LCD monitor. However, this does not affect the recorded pictures.
- The LCD monitor automatically returns to normal brightness after 30 seconds when recording in Power LCD Mode. Press any button to make the LCD monitor bright again.
- When [LCD Mode] is set, the usage time is reduced.

 <b>[Focus Icon]</b>	Change the focus icon.
	

 <b>[Video Rec Area]</b>	Angle of view for motion picture recording can be checked.
	<b>[ON]/[OFF]</b>

- Motion picture recording area display is only an approximation.
- Recording area display may disappear when zooming to Tele depending on the picture size setting.
- It will be fixed to [OFF] during the Intelligent Auto Mode.

 <b>[Sleep Mode]</b>	The camera is automatically turned off if the camera has not been used for the time selected on the setting.
	<b>[2MIN.]</b>
	<b>[5MIN.]</b>
	<b>[10MIN.]</b>
	<b>[OFF]</b>





- Press the shutter button halfway or turn the camera off and on to cancel [Sleep Mode].
- [Sleep Mode] is set to [5MIN.] in the Intelligent Auto Mode.
- [Sleep Mode] does not work in the following cases.
  - When using the AC adaptor (supplied)
  - When connecting to a PC or a printer
  - When recording or playing back motion pictures
  - During a Slide Show
  - [Auto Demo]

 <b>[Auto Review]</b>	Set the length of time that the picture is displayed after taking the still picture.
	<b>[1SEC.]</b> <b>[2SEC.]</b> <b>[HOLD]:</b> The pictures are displayed until one of the buttons is pressed. <b>[OFF]</b>



- [Auto Review] is activated regardless of its setting in the following cases.
  - When using [Burst].
- In Intelligent Auto Mode or [Panorama Shot] and [Photo Frame] in Scene Mode, the Auto Review function is fixed to [2SEC.].
- [Auto Review] does not work when recording motion pictures.

 <b>[Reset]</b>	The [Rec] or [Setup] menu settings are reset to the initial settings.
--	---

- When the [Reset] setting is selected during recording, the operation that resets the lens is also performed at the same time. You will hear the sound of the lens operating but this is normal and not indicative of malfunctioning.
- When [Setup] menu settings are reset, the following settings are also reset.
  - The birthday and name settings for [Baby1]/[Baby2] and [Pet] in Scene Mode.
  - The [Travel Date] setting. (Departure date, return date, destination)
  - The [World Time] setting.
- The folder number and the clock setting are not changed.

 <b>[Output]</b>	Set to match the type of TV.
	<b>[]</b> ( <b>[TV Aspect]:</b> <b>[]</b> : When connecting to a 16:9 screen TV. <b>[]</b> : When connecting to a 4:3 screen TV.

- This will work when the AV cable ([P97](#)) is connected.

 [Rotate Disp.]	This mode allows you to display pictures vertically if they were recorded holding the camera vertically.	
	 ([On]):	Rotate pictures on a TV and the LCD display so that they are displayed vertically.
	 ((External Only)):	Rotate only the picture on a TV so that it is displayed vertically.
	[OFF]	

- Refer to P32 for information about how to play back pictures.
- When you play back pictures on a PC, they cannot be displayed in the rotated direction unless the OS or software is compatible with Exif. Exif is a file format for still pictures which allows recording information etc. to be added. It was established by "JEITA (Japan Electronics and Information Technology Industries Association)".
- It may not be possible to rotate pictures that have been recorded with other equipment.
- The display is not rotated during Multi Playback.

Ver. [Version Disp.]	It is possible to check which version of firmware is on the camera.
----------------------	---

 [Format]	The built-in memory or card is formatted. <b>Formatting irretrievably deletes all the data so check the data carefully before formatting.</b>
--	---

- Use a battery with sufficient battery power when formatting. Do not turn the camera off during formatting.
- If a card has been inserted, only the card is formatted. To format the built-in memory, remove the card.
- If the card has been formatted on a PC or other equipment, format it on the camera again.
- It may take longer to format the built-in memory than the card.
- If the built-in memory or the card cannot be formatted, consult your nearest Service Center.

For USA and Puerto Rico assistance, please call:  
1-800-211-PANA(7262) or, contact us via the web at:  
<http://www.panasonic.com/contactinfo>

For Canadian assistance, please call:  
1-800-99-LUMIX (1-800-995-8649) or  
send e-mail to: [lumixconciierge@ca.panasonic.com](mailto:lumixconciierge@ca.panasonic.com)

 [Language]	Set the language displayed on the screen.
---	---

- If you set a different language by mistake, select [] from the menu icons to set the desired language.

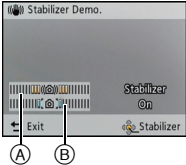
DEMO <b>[Demo Mode]</b>	<p>Displays the amount of jitter the camera has detected. ([Stabilizer Demo.]) The camera's features are displayed as slide shows. ([Auto Demo])</p>
	<p><b>[Stabilizer Demo.]:</b>          (A) Amount of jitter          (B) Amount of jitter after correction</p> <div style="text-align: right;">  </div> <p><b>[Auto Demo]:</b>  <b>[ON]</b>  <b>[OFF]</b></p>

- The Stabilizer function is switched between [On] and [Off] every time [MENU/SET] is pressed during the [Stabilizer Demo.].
- In Playback Mode, [Stabilizer Demo.] cannot be displayed.
- [Stabilizer Demo.] is an approximation.
- [Auto Demo] is not output to the television.

## About the LCD Monitor

### Press [DISP.] to change.

(A) LCD monitor

- When the menu screen appears, the [DISP.] button is not activated. During Playback Zoom, while playing back motion pictures and during a slide show, you can only select "Normal display (H)" or "No display (J)".

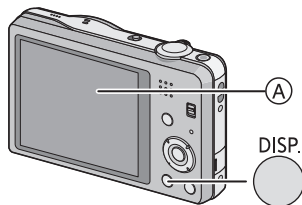

### In Recording Mode

- (B) Normal display
- (C) Number of recordable pictures
- (D) Normal display
- (E) Available recording time
- (F) No display
- (G) No display (Recording guideline)

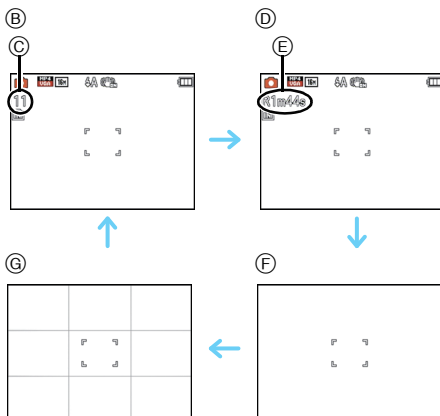

### In Playback Mode



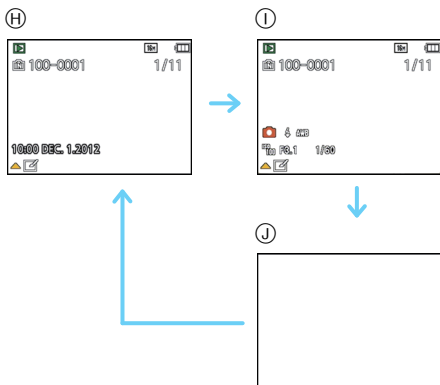

- (H) Normal display
- (I) Display with recording information
- (J) No display



### ■ Recording guideline

This is used as a reference of composition, such as balance, while taking a picture.

- In [Panorama Shot] or [Photo Frame] in Scene Mode, the guideline is not displayed.

Applicable modes:    

## Using the Zoom

### Using the Optical Zoom/Using the Extended Optical Zoom (EZ)/Using the Intelligent Zoom/Using the Digital Zoom

You can zoom in to make people and objects appear closer or zoom out to record landscapes in wide angle.

Setting the number of pixels to 10M or less will operate the Extended Optical Zoom to take zoomed pictures without affecting quality.

**To make subjects appear closer use (Tele)**

**Rotate the zoom lever towards Tele.**



**To make subjects appear further away use (Wide)**

**Rotate the zoom lever towards Wide.**



#### ■ Types of zooms

Feature	Optical Zoom	Extended Optical Zoom (EZ)
Maximum magnification	<b>DMC-SZ1</b> <b>DMC-SZ02</b> 10×	<b>DMC-SZ1</b> <b>DMC-SZ02</b> 22.5×*1
	<b>DMC-FH8</b> 5×	<b>DMC-FH8</b> 11.3×*1
Picture quality	No deterioration	No deterioration
Conditions	None	[Picture Size] with <b>F7</b> (P64) is selected.

\*1 This includes the optical zoom magnification. The magnification level differs depending on [Picture Size] setting.

The zoom functions below can also be used to further increase the zoom magnification.

Feature	Intelligent Zoom	Digital Zoom
Maximum magnification	2×	4×*2
Picture quality	Zoom in while limiting deterioration	The higher the magnification level, the greater the deterioration.
Conditions	[i.Resolution] (P70) on the [Rec] menu is set to [i.ZOOM].	[Digital Zoom] (P70) on the [Rec] menu is set to [ON].

\*2 This is 2× magnification when [i.Resolution] in [Rec] menu is set to [i.ZOOM].

## ■ Screen display

- (A) Extended Optical Zoom indication
- (B) Optical Zoom range
- (C) Intelligent Zoom range
- (D) Digital Zoom range
- (E) Zoom magnification





- When using the Zoom function, an estimate of the focus range will appear in conjunction with the zoom display bar. [Example: 0.5 m (1.6 ft.) –∞]

### Note

- The indicated zoom magnification is an approximation.
- “EZ” is an abbreviation of “Extended Optical Zoom”. It is possible to take more magnified pictures with the optical zoom.
- The lens barrel extends or retracts according to the zoom position. Be sure not to interrupt the motion of the lens barrel while the zoom lever is rotated.
- When using the Digital Zoom, we recommend using a tripod and the Self-timer (P53) for taking pictures.
- For details about using the zoom while recording motion pictures, refer to P30.
- The Extended Optical Zoom cannot be used in the following cases:
  - In Macro Zoom Mode
  - In [High Sens.] or [Photo Frame] in Scene Mode
  - When [Burst] in the [Rec] menu is set to [ ] or [ ]
  - When recording motion pictures
- The Intelligent Zoom cannot be used in the following cases:
  - In Macro Zoom Mode
  - In [High Sens.] in Scene Mode
  - When [Burst] in the [Rec] menu is set to [ ] or [ ]
- [Digital Zoom] cannot be used in the following cases:
  - In Intelligent Auto Mode
  - In Miniature Effect Mode
  - In [High Sens.] or [Photo Frame] in Scene Mode
  - When [Burst] in the [Rec] menu is set to [ ] or [ ]



Applicable modes:    

## Taking Pictures Using the Built-in Flash





### A Photo flash

Do not cover it with your fingers or other objects.





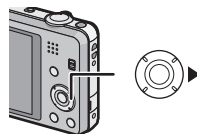

### Switching to the appropriate flash setting

Set the flash to match the recording.

**1** Press  .

**2** Press / to select the item and then press **[MENU/SET]**.



Item	Description of settings
 <b>[A]</b> ([Auto])  <b>[iA]</b> ([iAuto])*1	The flash is automatically activated when the recording conditions make it necessary.
 <b>[A⊙]</b> ([Auto/Red-Eye])*2	The flash is automatically activated when the recording conditions make it necessary. It is activated once before the actual recording to reduce the red-eye phenomenon (eyes of the subject appearing red in the picture) and then activated again for the actual recording. • <b>Use this when you take pictures of people in low lighting conditions.</b>
 <b>[⚡]</b> ([Forced Flash On])	The flash is activated every time regardless of the recording conditions. • <b>Use this when your subject is back-lit or under fluorescent light.</b>
 <b>[⚡⊙]</b> ([Slow Sync./Red-Eye])*2	If you take a picture with a dark background landscape, this feature will slow the shutter speed when the flash is activated so that the dark background will become bright. Simultaneously, it reduces the red-eye phenomenon. • <b>Use this when you take pictures of people in front of a dark background.</b>
 <b>[⊙]</b> ([Forced Flash Off])	The flash is not activated in any recording conditions. • <b>Use this when you take pictures in places where the use of flash is not permitted.</b>

\*1 This can be set only when Intelligent Auto Mode is set.

\*2 **The flash is activated twice. The subject should not move until the second flash is activated. Interval until the second flash depends on the brightness of the subject.** [Red-Eye Removal] (P74) on the [Rec] menu is set to [ON],  appears on the flash icon.

## ■ Available Flash Settings in Recording Mode

The available flash settings depend on the Recording Mode.

(○: Available, —: Not available, ●: Scene Mode initial setting)

	⚡A	⚡AⓄ	⚡	⚡SⓄ	Ⓞ
	○*	—	—	—	○
	○	○	○	—	○
	○	●	○	—	○
	—	—	—	—	●
	●	—	○	—	○
	—	—	—	●	○
	○	—	○	—	●
	●	○	○	—	○

\* [i⚡A] is displayed.

- The flash setting may change if the Recording Mode is changed. Set the flash setting again if necessary.
- The flash setting is memorized even if the camera is turned off. However, the Scene Mode flash setting is reset to the initial setting when the Scene Mode is changed.
- Flash will not be activated when recording motion picture.

## ■ The available flash range

DMC-SZ1

DMC-SZ02

	Wide	Tele
In [ISO] in [Sensitivity]	60 cm (2.0 feet) to 5.6 m (18 feet)	1.5 m (4.9 feet) to 2.9 m (9.5 feet)

DMC-FH8

	Wide	Tele
In [ISO] in [Sensitivity]	40 cm (1.3 feet) to 5.6 m (18 feet)	1.0 m (3.3 feet) to 2.1 m (6.9 feet)

## ■ Shutter speed for each flash setting

Flash setting	Shutter speed (Sec.)
⚡A	1/60 to 1/1600
⚡A⊙	
⚡	

Flash setting	Shutter speed (Sec.)
⚡S⊙	1 or 1/8 to 1/1600*1 1 or 1/4 to 1/1600*2
⊙	



\*1 The shutter speed changes depending on the [Stabilizer] setting.

\*2 When [ISO] in [Sensitivity] is set.

- \*1, 2: The shutter speed becomes a maximum of 1 second in the following cases.
  - When the Optical Image Stabilizer is set to [OFF].
  - When the camera has determined that there is very little jitter when the Optical Image Stabilizer is set to [ON].
- In Intelligent Auto Mode, shutter speed changes depending on the identified scene.
- In Scene Mode, shutter speed will be different from the above table.

### Note

- If you bring the Flash too close to an object, the object may be distorted or discolored by the heat or lighting from the Flash.
- Recording a subject from too close, or without sufficient flash will not provide the appropriate level of exposure, and may result in a picture that is too white or dark.
- When the Flash is being charged, the Flash icon blinks red, and you cannot take a picture even when you press the shutter button fully.
- If recording a subject without sufficient flash, the White Balance may not be properly adjusted.
- The effects of the flash may not be adequately achieved under the following conditions.
  - When [Burst] is set to [ ]
  - When the shutter speed is too fast
- It may take time to charge the Flash if you repeatedly take pictures. Take a picture after the access indication disappears.
- The Red-Eye Reduction effect differs between people. Also, if the subject is far away from the camera or was not looking at the first Flash, the effect may not be evident.

Applicable modes:   



## Taking Close-up Pictures ([AF Macro]/[Macro Zoom])

This mode allows you to take close-up pictures of a subject, e.g. when taking pictures of flowers.

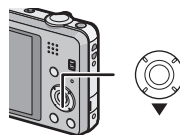



**1** Press  .







**2** Press / to select the item and then press **[MENU/SET]**.

Item	Description of settings
<b>[AF </b> ] ([AF Macro])	You can take pictures of a subject as close as 5 cm (0.16 feet) from the lens by rotating the zoom lever upmost to Wide (1×).
<b>[]</b> ([Macro Zoom])	Use this setting to get close to the subject and then further enlarge when taking the picture. You can take a picture with the Digital Zoom up to 3× while maintaining the distance to the subject for the extreme Wide position [5 cm (0.16 feet)]. • The image quality is poorer than during normal recording. • Zoom range will be displayed in blue. (digital zoom range)
<b>[OFF]</b>	—

### Note

- We recommend using a tripod and the Self-timer.
- We recommend setting the flash to  when you take pictures at close range.
- If the distance between the camera and the subject is beyond the focus range of the camera, the picture may not be properly focused even if the focus indication lights.
- When a subject is close to the camera, the effective focus range is significantly narrowed. Therefore, if the distance between the camera and the subject is changed after focusing on the subject, it may become difficult to focus on it again.
- Macro Mode gives priority to a subject close to the camera. Therefore, if the distance between the camera and the subject is far, it takes longer to focus on it.
- When you take pictures at close range, the resolution of the periphery of the picture may decrease slightly. This is not a malfunction.
- [Macro Zoom] cannot be set in the following cases.
  - When in Miniature Effect Mode
  - When [AF Mode] is set to 
  - When [Burst] is set to  or 

Applicable modes:     SCN

## Taking Pictures with the Self-timer

1 Press ◀ [⏸].

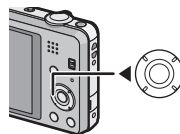

2 Press ▲/▼ to select the item and then press [MENU/SET].

Item	Description of settings
[⏸ <sub>10</sub> ] ([10sec.])	Picture is taken 10 seconds after shutter is pressed.
[⏸ <sub>2</sub> ] ([2sec.])	Picture is taken 2 seconds after shutter is pressed. • When using a tripod, etc., this setting is a convenient way to avoid the jitter caused by pressing the shutter button.
[OFF]	—

3 Press the shutter button halfway to focus and then press it fully to take the picture.

- The self-timer indicator (A) blinks and the shutter is activated after 10 seconds (or 2 seconds).



DMC-SZ1

DMC-SZ02

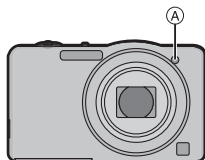

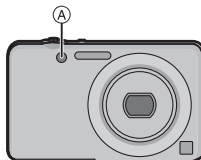

DMC-FH8



### Note

- When you press the shutter button once fully, the subject is automatically focused just before recording. In dark places, the Self-timer indicator will blink and then may turn on brightly, operating as an AF Assist Lamp to allow the camera to focus on the subject.
- We recommend using a tripod when recording with the Self-timer.
- The self-timer cannot be set when recording motion pictures.

Applicable modes:    

## Compensating the Exposure

Use this function when you cannot achieve appropriate exposure due to the difference in brightness between the subject and the background. Look at the following examples.

**Underexposed**



Compensate the exposure towards positive.

**Properly exposed**





**Overexposed**

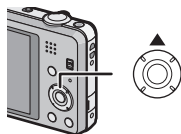

Compensate the exposure towards negative.

**1** Press   until [Exposure] appears.



**2** Press   to compensate the exposure and then press [MENU/SET].

- The exposure compensation value appears on the screen.
- Select [0 EV] to return to the original exposure.



### Note

- EV is an abbreviation of [Exposure Value], a unit indicating the amount of exposure. The EV changes with the aperture value or the shutter speed.
- The set exposure value is memorized even if the camera is turned off.
- The compensation range of the exposure will be limited depending on the brightness of the subject.

Recording Mode: 

## Record pictures that look like dioramas (Miniature Effect Mode)

By creating areas that are blurred and areas that are not, the picture will look like that of a miniature model. Motion pictures can also be recorded with diorama effects that appear to be played back in fast forward.

**1** Slide the REC/PLAY switch to , and then press [MODE].

**2** Press  to select [Miniature Effect], and then press [MENU/SET].

### Note

- Display of the recording screen will be delayed more than usual and the screen will look as if frames are dropping.
- No sound is recorded in motion pictures.
- Approximately 1/10 of the time period is recorded. (If you record for 10 minutes, the resulting motion picture recording will be approximately 1 minute long.)  
The displayed available recording time is approximately 10 times. When switching to Recording Mode, please check the available recording time.
- When taking pictures of a large size, the screen may turn black after taking the picture because of signal processing. This is not a malfunction.

Recording Mode: **SCN**

## Taking pictures that match the scene being recorded (Scene Mode)

When you select a Scene Mode to match the subject and recording situation, the camera sets the optimal exposure and hue to obtain the desired picture.

- 1** Slide the REC/PLAY switch to [📷], and then press [MODE].
- 2** Press ▲/▼/◀/▶ to select [Scene Mode], and then press [MENU/SET].
- 3** Press ▲/▼/◀/▶ to select the Scene Mode and then press [MENU/SET].

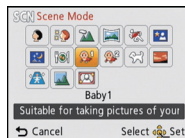

### Note

- To change the Scene Mode, press [MENU/SET], select [Scene Mode] using ▲/▼/◀/▶, and then press [MENU/SET].
- The following cannot be set in Scene Mode as the camera adjusts automatically.
  - [Sensitivity]
  - [i.Exposure]
  - [i.Resolution]
  - [Color Mode]



## [Portrait]

When taking pictures of people outdoors during the daytime, this mode allows you to improve the appearance and make their skin tones look healthier.

### ■ Technique for Portrait Mode

To make this mode more effective:

- ① Rotate the zoom lever as far as possible to Tele.
- ② Move close to the subject to make this mode more effective.

## [Soft Skin]

When taking pictures of people outdoors during the daytime, this mode enables the texture of their skin to appear even softer than with [Portrait]. (It is effective when taking pictures of people from the chest up.)

### ■ Technique for Soft Skin Mode

To make this mode more effective:

- ① Rotate the zoom lever as far as possible to Tele.
- ② Move close to the subject to make this mode more effective.



### Note

- If a part of the background etc. is a color close to skin color, this part is also smoothed.
- This mode may not be effective when there is insufficient brightness.

## [Scenery]

This allows you to take pictures of a wide landscape.

## [Panorama Shot]

Pictures are recorded continuously while moving the camera horizontally or vertically, and are combined to make a single panorama picture.

- 1 Press ▲/▼ to select the recording direction and then press [MENU/SET].**

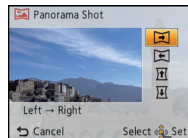

- 2 After confirming the recording direction, press [MENU/SET].**

- The horizontal/vertical guideline will be displayed.

- 3 Press the shutter button halfway to focus.**

- 4 Press the shutter button fully and record a picture while moving the camera in a small circle in the direction selected in Step 1.**

### ■ Technique for Panorama Shot Mode

Recording from left to right

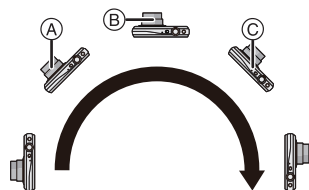

Move the camera in a single swirling motion for about 8 seconds.

- Move the camera at a constant speed. Pictures may not be able to be recorded properly if the camera is moved too fast or too slow.

- (A) 1 second
- (B) 2 seconds
- (C) 3 seconds

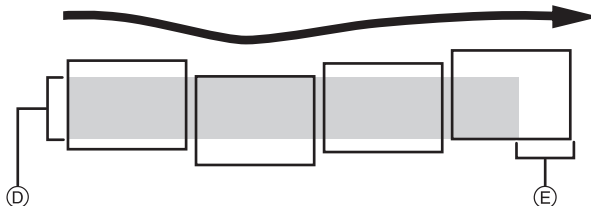

- (D) Move the camera in the recording direction without shaking it. If the camera shakes too much, pictures may not be able to be recorded, or the recorded panorama picture may become narrower (smaller)
- (E) Move the camera towards the edge of the range you wish to record. (The edge of the range will not be recorded in the last frame)

- 5 Press the shutter button once again to end the still picture recording.**

- Recording can also be canceled by keeping the camera still while recording.

### Note

- The zoom position is fixed to Wide.
- The focus, white balance, and exposure are fixed at the optimum values for the first picture. As a result, if the focus or brightness changes substantially during recording, the entire panorama picture may not be recorded at the suitable focus or brightness.
- When multiple pictures are combined to create a single panorama picture, the subject may appear distorted or the connection points may be noticeable in some cases.
- The number of recording pixels in the horizontal and vertical directions of the panorama picture varies depending on the recording direction and the number of combined pictures. The maximum number of pixels is shown below.

Recording direction	Horizontal Resolution	Vertical Resolution
Horizontal	8000 pixels	1080 pixels
Vertical	1440 pixels	8000 pixels

- A panorama picture may not be able to be created, or the pictures may not be combined properly when recording the following subjects or under the recording conditions below.
  - Subjects with a single, uniform color or repetitive pattern (such as the sky or a beach)
  - Moving subjects (person, pet, car, waves, flowers blowing in the breeze, etc.)
  - Subjects where the color or patterns change in a short time (such as an image appearing on a display)
  - Dark places
  - Locations with flickering light sources such as fluorescent lights or candles

### About playback

Playback zoom can be performed even for pictures that were recorded using [Panorama Shot].

Also, if ▲ is pressed during playback, the screen will automatically scroll in the same direction during recording.

The cursor displayed during playback is the same as ▲/▼/◀/▶.

▲	Start/Pause*	
▼	Stop	

- \* You can perform frame-by-frame forward/rewind by pressing ▶/◀ during a pause.

## [Sports]

Setting for when you want to take pictures of sports scenes or other fast-moving events.

### Note

- Shutter speed may slow down for up to 1 second.
- This mode is suitable for taking pictures of subjects at distances of 5 m (16 feet) or more.

## [Night Portrait]

This allows you to take pictures of a person and the background with near real-life brightness.

### ■ Technique for Night Portrait Mode

- **Use the flash. (You can set to [  ].)**
- Ask the subject not to move while taking a picture.

### Note

- We recommend using a tripod and the Self-timer for taking pictures.
- Shutter speed may slow down for up to 8 seconds.
- The shutter may remain closed (max. about 8 sec.) after taking the picture because of signal processing. This is not a malfunction.
- Noise may become visible when you take pictures in dark places.

## [Night Scenery]

This allows you to take vivid pictures of the nightscape.

### Note

- We recommend using a tripod and the Self-timer for taking pictures.
- Shutter speed may slow down for up to 8 seconds.
- The shutter may remain closed (max. about 8 sec.) after taking the picture because of signal processing. This is not a malfunction.
- Noise may become visible when you take pictures in dark places.

## [Food]

This mode allows you to take pictures of food with a natural hue without being affected by the ambient light in restaurants, etc.

**[Baby1]/[Baby2]**

This takes pictures of a baby with a healthy complexion. When you use the flash, the light from it is weaker than usual.

It is possible to set different birthdays and names for [Baby1] and [Baby2]. You can select to have these appear at the time of playback, or have them stamped on the recorded image using [Text Stamp] (P87).

### ■ Birthday/Name setting

**1** Press **▲/▼** to select [Age] or [Name] and then press [MENU/SET].

**2** Press **▲/▼** to select [SET] and then press [MENU/SET].

**3** Enter the birthday or name.

Birthday: **◀/▶**: Select the items (year/month/day)

**▲/▼**: Setting

[MENU/SET]: Set

Name: For details on how to enter characters, refer to “Entering Text” on P63.

- When the birthday or name is set, [Age] or [Name] is automatically set to [ON].
- If [ON] is selected when the birthday or name has not been registered, the setting screen appears automatically.

**4** Press **▼** to select [Exit] and then press [MENU/SET] to finish.

### ■ To cancel [Age] and [Name]

Select the [OFF] setting in step 2.

### Note

- The age and name can be printed out using the “PHOTOfunSTUDIO” bundled software on the CD-ROM (supplied).
- If [Age] or [Name] is set to [OFF] even when the birthday or name has been set, the age or name will not be displayed.
- Shutter speed may slow down up to 1 second.

**[Pet]**

Select this when you want to take pictures of a pet such as a dog or a cat. You can set your pet's birthday and name.

For information about [Age] or [Name], refer to [Baby1]/[Baby2] on P61.

**[Sunset]**

Select this when you want to take pictures of a sunset view. This allows you to take vivid pictures of the red color of the sun.

**[High Sens.]**

This mode minimizes the jitter of the subjects, and enables you to take pictures of these subjects in dimly lit rooms.

**■ Picture Size**

Select the picture size of 3M (4:3), 2.5M (3:2), 2M (16:9) or 2.5M (1:1).

**[Glass Through]**

This mode is ideal for taking pictures of scenery and other landscapes through clear glass, such as in vehicles or buildings.

**Note**

- The camera may focus on the glass if it is dirty or has dust on it.
- The pictures taken may not look natural if the glass is colored. When this happens, change the white balance settings. (P66)

**[Photo Frame]**

Record the image with a frame around it.

**■ Setting the frame**

Select from 6 types of frames.

**Note**

- The picture size is fixed to 5M (4:3).
- The color of the frame displayed on the screen and the color of the frame around the actual image may differ, but this is not a malfunction.

## Entering Text

It is possible to enter babies' and pets' names and the names of travel destinations when recording. (Only alphabetical characters and symbols can be entered.)

### 1 Display the entry screen.

- You can display the entry screen via the following operations.
  - [Name] of [Baby1]/[Baby2] or [Pet] in Scene Mode
  - [Location] in [Travel Date]

### 2 Press ▲/▼/◀/▶ to select text and then press [MENU/SET] to register.

- Move the cursor to [A<sup>u</sup>a<sup>l</sup>] and then press [MENU/SET] to switch text between [A] (capitals), [a] (lower case), [1] (numbers) and [&] (special characters).
- To enter the same character again, rotate the zoom lever towards [Q] (T) to move the cursor.
- The following operations can be performed by moving the cursor to the item and pressing [MENU/SET]:
  - [ ]: Enter a blank
  - [Delete]: Delete a character
  - [◀]: Move the entry position cursor to the left
  - [▶]: Move the entry position cursor to the right
- The following characters and numbers can be entered.
  - A maximum of 30 characters can be entered.
  - \* A maximum of 15 characters can be entered for [ ], [ ], [ ], [•] and [–].



### 3 Press ▲/▼/◀/▶ to move the cursor to [Set] and then press [MENU/SET] to end text input.

#### Note

- Text can be scrolled if all of the entered text does not fit on the screen.
- It is displayed in order of [Location], [Name].

## Using the [Rec] Menu

For details on [Rec] menu settings, refer to [P37](#).

### [Picture Size]

Applicable modes:    

Set the number of pixels. The higher the numbers of pixels, the finer the detail of the pictures will appear even when they are printed onto large sheets.

Settings	Picture Size
[ 4:3 16M ]	4608×3456
[ 4:3 10M <sup>EZ</sup> ]*	3648×2736
[ 4:3 5M <sup>EZ</sup> ]	2560×1920
[ 4:3 3M <sup>EZ</sup> ]*	2048×1536
[ 4:3 0.3M <sup>EZ</sup> ]	640×480
[ 3:2 14M ]	4608×3072
[ 16:9 12M ]	4608×2592
[ 1:1 12M ]	3456×3456

\* This item cannot be set in the Intelligent Auto Mode.

**4:3** : Aspect ratio of a 4:3 TV

**3:2** : Aspect ratio of a 35 mm film camera

**16:9** : Aspect ratio of a high-definition TV, etc.

**1:1** : Square aspect ratio

#### Note

- In specific modes, Extended Optical Zoom cannot be used, and the picture size for [ **5M<sup>EZ</sup>** ] is not displayed. For details regarding modes in which Extended Optical Zoom cannot be used, refer to [P48](#).
- Pictures may appear mosaic depending on the subject and the recording conditions.



## [Sensitivity]

**Applicable modes:**    SCH

This allows the Sensitivity to light (ISO sensitivity) to be set. Setting to a higher figure enables pictures to be taken even in dark places without the resulting pictures coming out dark.

Settings	Description of settings
[ISO] ([i.ISO])	The ISO sensitivity is adjusted according to the movement of the subject and the brightness. • Maximum [1600]
[100]	The ISO sensitivity is fixed to various settings.
[200]	
[400]	
[800]	
[1600]	

	[100] ←	→ [1600]
Recording location (recommended)	When it is light (outdoors)	When it is dark
Shutter speed	Slow	Fast
Noise	Less	Increased
Jitter of the subject	Increased	Less

### ■ About [ISO] (Intelligent ISO sensitivity control)

The camera detects movement of the subject and then automatically sets the optimum ISO sensitivity and shutter speed to suit the movement of the subject and brightness of the scene to minimize the jitter of the subject.

- The shutter speed is not fixed when the shutter button is pressed halfway. It is continuously changing to match the movement of the subject until the shutter button is pressed fully.







### Note

- For the focus range of flash when [ISO] is set, refer to P51.
- The ISO sensitivity is automatically set under the following conditions.
  - When recording motion pictures
  - When [Burst] is set to [C] or [B]

## [White Balance]

**Applicable modes:**     **SCN**

In sunlight, under incandescent lights or in other such conditions where the color of white takes on a reddish or bluish tinge, this item adjusts to the color of white which is closest to what is seen by the eye in accordance with the light source.

Settings	Description of settings
<b>[AWB]</b> ((Auto White Balance))	Automatic adjustment
 ((Daylight))	When taking pictures outdoors under a clear sky
 ((Cloudy))	When taking pictures outdoors under a cloudy sky
 ((Shade))	When taking pictures outdoors in the shade
 ((Incandescent))	When taking pictures under incandescent lights
 ((White Set))	Value set by using  SET
 SET ((White Set Setting))	Set manually

### Note

- Under fluorescent lighting, LED lighting fixture etc., the appropriate White Balance will vary depending on the lighting type, so use [AWB] or SET.
- The White Balance setting is memorized even if the camera is turned off. (However, the White Balance setting for a Scene Mode returns to [AWB] when the Scene Mode is changed.)
- White Balance is fixed to [AWB] in following conditions.
  - [Scenery]/[Night Portrait]/[Night Scenery]/[Food]/[Sunset] in Scene Mode

## ■ Auto White Balance

Depending on the conditions prevailing when pictures are taken, the pictures may take on a reddish or bluish tinge. Furthermore, when a multiple number of light sources are being used or there is nothing with a color close to white, Auto White Balance may not function properly. In this case, set the White Balance to a mode other than [AWB].

- 1 Auto White Balance will work within this range
- 2 Blue sky
- 3 Cloudy sky (Rain)
- 4 Shade
- 5 Sunlight
- 6 White fluorescent light
- 7 Incandescent light bulb
- 8 Sunrise and sunset
- 9 Candlelight

K=Kelvin Color Temperature

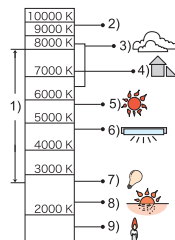

## Setting the White Balance manually

Set the White Balance value. Use to match the condition when taking photographs.

- 1 Select [MENU/SET] and then press [MENU/SET].
- 2 Aim the camera at a sheet of white paper etc. so that the frame in the center is filled by the white object only and then press [MENU/SET].



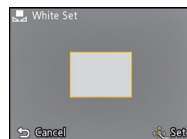

- White Balance may not be set when the subject is too bright or too dark. Set the White Balance again after adjusting to appropriate brightness.
- Exit the menu after it is set.



## [AF Mode]



**Applicable modes:**      **SCN**

This allows the focusing method that suits the positions and number of the subjects to be selected.

Settings	Description of settings
 ((Face Detection))	The camera automatically detects the person's face. (max. 15 areas) The focus and exposure can then be adjusted to fit that face no matter what portion of the picture it is in.
 (([AF Tracking]))*	Focus can be adjusted to a specified subject. Focus will keep on following the subject even if it moves. (Dynamic tracking)
 (([23-Area]))*	Up to 23 points for each AF area can be focused. This is effective when the subject is not in the center of the screen. (AF area frame will be same as image aspect ratio setting.)
 (([1-Area]))	The camera focuses on the subject in the AF area on the center of the screen.

\*  will be used during motion picture recording.

### Note

- The focus setting is fixed to  in Miniature Effect Mode.
-  cannot be set with [Panorama Shot], [Night Scenery] or [Food] in Scene Mode.
- It cannot be set to  in the following conditions.
  - In [Panorama Shot] in Scene Mode
  - In [B&W] or [SEPIA] in [Color Mode]

### About ([Face Detection])

The following AF area frames are displayed when the camera detects the faces.

Yellow:



When the shutter button is pressed halfway, the frame turns green when the camera is focused.

White:

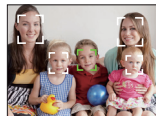
Displayed when more than one face is detected. Other faces that are the same distance away as the faces within the yellow AF areas are also brought into focus.



### Note

- Under certain picture-taking conditions including the following cases, the face detection function may fail to work, making it impossible to detect faces. [AF Mode] is switched to  () while motion pictures are taken.
  - When the face is not facing the camera
  - When the face is at an angle
  - When the face is extremely bright or dark
  - When there is little contrast on the faces
  - When the facial features are hidden behind sunglasses, etc.
  - When the face appears small on the screen
  - When there is rapid movement
  - When the subject is not a human being
  - When the camera is shaking
  - When Digital Zoom is used
- If the camera is registering something other than someone's face, change the settings to something other than .

## ■ Setting up [AF Tracking] ([AF Tracking])

Align the subject with the AF tracking frame, and then press ▼ to lock onto the subject.

Ⓐ AF tracking frame

- AF area will be displayed in yellow when a subject is recognized, and focus will automatically adjust continuously following the subject's movement (Dynamic tracking).
- AF tracking is canceled when ▼ is pressed again.



Ⓐ

### Note

- Dynamic tracking function may not work in the following cases:
  - When the subject is too small
  - When the recording location is too dark or bright
  - When the subject is moving too fast
  - When the background has the same or similar color to the subject
  - When jitter is occurring
  - When using the zoom
- When the lock fails, the AF tracking frame will turn red and then disappear. Press ▼ again.
- The camera records pictures with [AF Mode] as [ ] when locked or Dynamic Tracking is not working.

## [i.Exposure]

**Applicable modes:**    SCN

Contrast and exposure will be adjusted automatically when there is a big difference in brightness between the background and subject, to bring the image close to real life.

**Settings:** [ON]/[OFF]

 **Note**

- [i.●] in the screen turns yellow when [i.Exposure] is in effect.
- Even when the [Sensitivity] is set to [100], [Sensitivity] may be set higher than [100] if the picture is taken with [i.Exposure].
- Compensation effect may not be achieved depending on the conditions.

## [i.Resolution]

**Applicable modes:**    SCN

Pictures with sharp profile and resolution can be taken by using the Intelligent Resolution Technology.

Settings	Description of settings
[ON]	[i.Resolution] is activated.
[i.ZOOM]	[i.Resolution] is activated, and zoom magnification increased to 2 times while limiting deterioration of the picture.
[OFF]	—

 **Note**

- Refer to [P47](#) for information about the Intelligent Zoom.

## [Digital Zoom]

**Applicable modes:**    SCN

This can enlarge subjects even more than the Optical Zoom, Extended Optical Zoom, or [i.ZOOM].

**Settings:** [ON]/[OFF]



 **Note**

- Refer to [P47](#) for details.
- The setting is fixed to [ON] in Macro Zoom Mode.

## [Burst]

Applicable modes:    

Pictures are taken continuously while the shutter button is pressed.

Settings	Description of settings	
 ((Burst On))	<b>Burst speed</b>	approx. 1.3 pictures/second
	<ul style="list-style-type: none"> <li>You can take pictures until the capacity of the built-in memory or the card is full.</li> <li><b>The burst speed becomes slower halfway.</b> The exact timing of this depends on the type of card and the Picture Size.</li> <li>The focus is fixed when the first picture is taken.</li> <li>The exposure and White Balance are adjusted each time you take a picture.</li> <li>The Burst speed (pictures/second) may become slower depending on the recording environment, such as in dark places, if the ISO sensitivity is high etc.</li> </ul>	
 ((Hi-Speed Burst))	<b>Burst speed</b>	approx. 10 pictures/second
	<b>Number of recordable pictures</b>	max. 100 pictures
<ul style="list-style-type: none"> <li>This can be set only during Normal Picture Mode.</li> <li>The picture size is fixed to 3M (4:3), 2.5M (3:2), 2M (16:9) or 2.5M (1:1).</li> <li>The Burst speed changes according to the recording conditions.</li> <li>The number of Burst recording pictures are limited by the picture-taking conditions and the type and/or status of the card used.</li> <li>The number of Burst recording pictures may increase when you use a card with fast writing speed or card is formatted.</li> <li>The focus, zoom, exposure, White Balance, shutter speed and ISO sensitivity are fixed to the settings for the first picture.</li> <li>The ISO sensitivity is automatically adjusted. However, the ISO sensitivity is increased to make the shutter speed become high-speed.</li> <li>Depending on the operating conditions, it may take time to take the next picture if you repeat taking a picture.</li> </ul>		
 ((Flash Burst))	<b>Number of recordable pictures</b>	max. 5 pictures
	<ul style="list-style-type: none"> <li>Still pictures are taken continuously with flash.</li> <li>This can be set only during Normal Picture Mode.</li> <li>The picture size is fixed to 3M (4:3), 2.5M (3:2), 2M (16:9) or 2.5M (1:1).</li> <li>Settings for focus, zoom, exposure, shutter speed, ISO sensitivity, flash output are fixed to the first picture.</li> <li>Number of recordable pictures will be fixed to 5 pictures when the self-timer is used.</li> <li><b>The flash setting is fixed to [⚡].</b></li> </ul>	
[OFF]	—	

 **Note**

- Burst Mode is not canceled when the camera is switched off.
- If you take pictures in Burst Mode with the built-in memory, it will take time to write the picture data.
- The setting is fixed to [OFF] in [Panorama Shot] and [Photo Frame] in Scene Mode.
- Number of recordable pictures will be fixed to 3 pictures when the self-timer is used (except for [☺]).
- **The flash setting is fixed to [☺] (except for [☹]).**



**[Color Mode]****Applicable modes:**   

Sets various color effects, including making the picture sharper, brighter, or applying a sepia tone.

Settings	Description of settings
<b>[STANDARD]</b>	This is the standard setting.
<b>[Happy]<sup>*1</sup></b>	Image with enhanced brightness and vividness.
<b>[VIVID]<sup>*2</sup></b>	The picture becomes sharper.
<b>[B&amp;W]</b>	The picture becomes black and white.
<b>[SEPIA]</b>	The picture becomes sepia.

\*1 This can be set only when Intelligent Auto Mode is set.

\*2 This can be set only during Normal Picture Mode.

## [AF Assist Lamp]

**Applicable modes:**     **SCN**

AF assist lamp will illuminate the subject when the shutter button is pressed halfway, making it easier for the camera to focus when recording in low light conditions. (Larger AF area is displayed depending on the recording conditions.)

**Settings:** [ON]/[OFF]

### Note

- The effective distance of the assist lamp is a maximum of approximately 1.5 m (4.9 feet).
- When you do not want to use the AF Assist Lamp **A** (e.g. when taking pictures of animals in dark places), set the [AF Assist Lamp] to [OFF]. In this case, it will become more difficult to focus on the subject.
- [AF Assist Lamp] is fixed to [OFF] in [Scenery], [Night Scenery], [Sunset], and [Glass Through] in Scene Mode.

DMC-SZ1 DMC-SZ02





DMC-FH8



## [Red-Eye Removal]

**Applicable modes:**     **SCN**

When Red-Eye Reduction ([], []) is selected, Digital Red-Eye Correction is performed whenever the flash is used. The camera automatically detects red-eye and corrects the picture.

**Settings:** [ON]/[OFF]

### Note

- Only available when [AF Mode] is set to [] and Face Detection is active.
- Under certain circumstances, red-eye cannot be corrected.

## [Stabilizer]

**Applicable modes:**     **SCN**

Using one of these modes, jitter during picture taking is detected, and the camera automatically compensates the jitter, enabling jitter-free images to be taken.

**Settings:** [ON]/[OFF]

### Note

- Stabilizer is fixed to [OFF] in [Panorama Shot] in Scene Mode.
- Stabilizer will be set to [ON] while recording motion pictures.
- The stabilizer function may not be effective in the following cases.
  - Be careful of camera jitter when you press the shutter button.
    - When there is a lot of jitter.
    - When the zoom magnification is high.
    - In Digital Zoom range.
    - When taking pictures while following a moving subject.
    - When the shutter speed becomes slower to take pictures indoors or in dark places.

## [Date Stamp]

**Applicable modes:**     **SCN**

You can take a picture with date and time of recording.

Settings	Description of settings
[W/O TIME]	Stamp the year, month, and day.
[WITH TIME]	Stamp the year, month, day, hour, and minutes.
[OFF]	—

### Note

- **Date information for pictures recorded with the [Date Stamp] set cannot be deleted.**
- **When printing pictures with [Date Stamp] at a shop or with a printer, the date will be printed on top of the other if you choose to print with the date.**
- If the time has not been set, you cannot stamp with the date information.
- The setting is fixed to [OFF] in the following cases.
  - When recording motion pictures
  - In [Panorama Shot] in Scene Mode
  - When using [Burst].
- [Text Stamp], [Resize], and [Cropping] cannot be set for pictures recorded with [Date Stamp] set.
- Even if you take a picture with [Date Stamp] set to [OFF], it is possible to stamp dates onto the recorded pictures using [Text Stamp] (P87) or setup the Date print (P94, 107).

## [Clock Set]

- Refer to P19 for details.

## Using the [Motion Picture] Menu

For details on [Motion Picture] menu settings, refer to P37.

In [Panorama Shot] in Scene Mode, the [Motion Picture] menu will not be displayed.

### [Rec Quality]

Applicable modes:    

This sets up the picture quality of motion pictures.

Settings	Picture size/Bit rate	fps	Aspect ratio
[HD]	1280×720 pixels/Approx. 10 Mbps	30	16:9
[VGA]	640×480 pixels/Approx. 4 Mbps		4:3

#### Note

##### • What is bit rate

This is the volume of data for a definite period of time, and the quality becomes higher when the number gets bigger. This unit is using the “VBR” recording method. “VBR” is an abbreviation of “Variable Bit Rate”, and the bit rate (volume of data for definite period of time) is changed automatically depending on the subject to record. Therefore, the recording time is shortened when a subject with fast movement is recorded.

### [Continuous AF]

Applicable modes:    

It will continually keep on focusing on a subject for which the focus was once set.





Settings: [ON]/[OFF]





#### Note

- Set this function to [OFF] if you wish to fix the focus on the position where you started the motion picture recording.

## Various methods of playback

You can play back the recorded pictures in various methods.

- 1** Slide the REC/PLAY switch to , and then press [MODE].
- 2** Press /// to select item, and then press [MENU/SET].
  - Following items can be selected.

	([Normal Play]) (P32)
	([Slide Show]) (P78)
	([Filtering Play]) (P80)
	([Calendar]) (P81)

## [Slide Show]

You can play back the pictures you have taken in synchronization with music, and you can do this in sequence while leaving a fixed interval between each of the pictures.

Furthermore, you can play back the pictures grouped together by category, or play back only those pictures you have set as favorites as a slide show.

This playback method is recommended when you have connected the camera to a TV set to view the pictures you have taken.

### 1 Select the group to play back by pressing ▲/▼, and then press [MENU/SET].

- During [Category Selection], press ▲/▼/◀/▶ to select a category, and then press [MENU/SET]. Refer to P80 for category details.

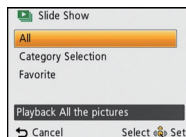

### 2 Press ▲ to select [Start] and then press [MENU/SET].

### 3 Press ▼ to finish the slide show.

- Normal Playback resumes after the slide show finishes.

#### ■ Operations performed during slide show

The cursor displayed during playback is the same as ▲/▼/◀/▶.

▲	Play/Pause	
▼	Stop	
◀	Back to previous picture*	
▶	Ahead to next picture*	
[W]	Reduce volume level	
[T]	Increase volume level	

\* Only available when paused or playing back panorama pictures.

## ■ Changing the slide show settings

You can change the settings for Slide Show Playback by selecting [Effect] or [Setup] on the slide show menu screen.

### [Effect]

This allows you to select the screen effects or music effects when switching from one picture to the next.

[NATURAL], [SLOW], [SWING], [URBAN], [OFF], [AUTO]

- When [URBAN] has been selected, the picture may appear in black and white as a screen effect.
- [AUTO] can be used only when [Category Selection] has been selected. The pictures are played back with the recommended effects in each category.
- Some [Effect] will not operate when playing back pictures displayed vertically.

### [Setup]

[Duration] or [Repeat] can be set.

Settings	Description of settings
[Duration]	[1SEC.]/[2SEC.]/[3SEC.]/[5SEC.]
[Repeat]	[ON]/[OFF]
[Music]	[ON]/[OFF]

- [Duration] can be set only when [OFF] has been selected as the [Effect] setting.
- When playing back a panorama picture, the [Effect] setting is disabled.
- [Music] cannot be selected when [OFF] has been selected as the [Effect] setting.



### Note

- Motion pictures cannot be played back as a slide show. When [  ] (motion picture) is selected in [Category Selection], the first frames of the motion pictures are displayed as still pictures in a slide show.

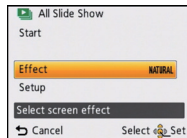





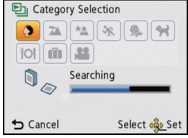



## [Filtering Play]

The images sorted into the category or images set as favorite are played back.

Settings	Description of settings
[Category Selection]	<p>This mode allows you to search images by Scene Mode or other categories (such as [Portrait], [Scenery] or [Night Scenery]) and sort the pictures into each of the categories. You can then play back the pictures in each category.</p> <p><b>Press ▲/▼/◀/▶ to select the category and then press [MENU/SET] to set.</b></p> <ul style="list-style-type: none"> <li>Only the category for which pictures have been found can be selected.</li> </ul> 
[Favorite]	You can play back the pictures you have set as [Favorite] (P92).

### ■ About the categories to be sorted

It will be sorted as following when [Category Selection] is set.

	Recording information e.g. Scene Modes
	[Portrait], [i-Portrait], [Soft Skin], [Night Portrait], [i-Night Portrait], [Baby1]/[Baby2]
	[Scenery], [i-Scenery], [Panorama Shot], [Sunset], [i-Sunset], [Glass Through]
	[Night Portrait], [i-Night Portrait], [Night Scenery], [i-Night Scenery]
	[Sports]
	[Baby1]/[Baby2]
	[Pet]
	[Food]
	[Travel Date]
	[Motion Picture]



## [Calendar]

You can display pictures by recording date.

**1** Press ▲/▼/◀/▶ to select the date to be played back.

- If there were no pictures recorded during a month, that month is not displayed.

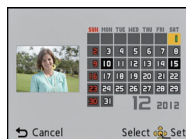

**2** Press [MENU/SET] to display the pictures that were recorded on the selected date.

- Press [🗑️/↩️] to return to the calendar screen.



**Note**

- The recording date of the picture selected in the playback screen becomes the date selected when the calendar screen is first displayed.
- If there are multiple pictures with the same recording date, the first picture recorded on that day is displayed.
- You can display the calendar between January 2000 and December 2099.
- If the date is not set in the camera, the recording date is set as January 1st, 2012.
- If you take pictures after setting the travel destination in [World Time], the pictures are displayed by the dates at the travel destination in Calendar Playback.

## Having Fun with Recorded Pictures

### [Auto Retouch]

The brightness and color of the pictures taken can be balanced.

- With [Auto Retouch], a new edited picture is created. Check that there is free space on the built-in memory or the card.

[Auto Retouch] cannot be used if the card's Write-Protect switch is set to [LOCK].



- \* These pictures are examples to show the effect.

DMC-SZ1

DMC-SZ02

**1** Press ◀/▶ to select a picture, and then press ▲.

**2** Press [MENU/SET].

- Confirmation screen is displayed. It is executed when [Yes] is selected.

DMC-FH8

**1** Press ◀/▶ to select a picture, and then press ▲.

**2** Press ▲/▼ to select [Auto Retouch], and then press [MENU/SET].

**3** Press ▲/▼ to select [ON], and then press [MENU/SET].

- Confirmation screen is displayed. It is executed when [Yes] is selected.

#### Note

- Depending on the picture, noise may be emphasised by [Auto Retouch].
- Effects may be difficult to see depending on the picture.
- It may not be possible to perform [Auto Retouch] on pictures which have already been retouched.
- [Auto Retouch] may not be performed on pictures recorded with other equipment.
- [Auto Retouch] is not possible in the following cases:
  - Motion pictures
  - Pictures taken in [Panorama Shot] and [Photo Frame] in Scene Mode

**[Beauty Retouch] DMC-FH8**

Apply effects similar to that of aesthetics or makeup to brighten up any face.

- With [Beauty Retouch], a new edited picture is created. Check that there is free space on the built-in memory or the card.

[Beauty Retouch] cannot be used if the card's Write-Protect switch is set to [LOCK].

- 1** Press ◀/▶ to select a picture, and then press ▲.
- 2** Press ▲/▼ to select [Beauty Retouch], and then press [MENU/SET].
- 3** Press ◀/▶ to select the face of the person to edit, and then press [MENU/SET].
  - Only a person with an arrow can be selected.
- 4** Press ▲/▼ to select the item, and then press ▶.

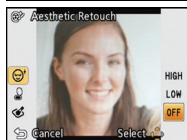

Select effects from each of the following items.

Item	Description of settings
[☺] ([Aesthetic Retouch])	Gives skin a more transparent look, or make eyes and teeth look whiter.
[👤] ([Foundation])	Adjust skin color.
[💄] ([Make Up Retouch])	Add color to lips, more volume to faces or clarity to eyes.

- 5** Press ▲/▼ to select the effect.
  - To continue to add different effects, press ◀, and repeat steps 4 and 5.

## 6 After finishing the picture editing, press [MENU/SET].

- Confirmation screen is displayed. Selecting [Yes] displays images before application and after application.

## 7 Press [MENU/SET].

- Confirmation screen is displayed. It is executed when [Yes] is selected.

### Note

- [Beauty Retouch] cannot be used on people who have already been retouched, or two or more people at the same time. To use [Beauty Retouch] for these pictures, save the picture first, then select the person to retouch.
- The brightness and color of pictures you are checking before saving may differ to the actual picture that is saved.
- [Beauty Retouch] cannot be used with motion pictures or pictures recorded with [Panorama Shot] in Scene Mode.
- [Beauty Retouch] may not be performed on pictures recorded with other equipment.
- Intended retouching may not be possible when the face detection is not performed properly.
- When a subject is wearing glasses, the desired retouch may not be possible.
- When a picture is bright due to reflected light from a flash or the sun, the retouching effect may be less pronounced.
- To take pictures appropriate for [Beauty Retouch]:
  - Record a large, frontal view of the face
  - Avoid taking pictures in a very dark place
  - Clearly record the part you intend to retouch
- Reallusion is a trademark of Reallusion Inc.



**REALLUSION**

## Using the [Playback] Menu

You can set up pictures to be uploaded to image sharing sites and perform actions like cropping recorded pictures, as well as set up the protection of recorded images, etc.

- With [Text Stamp], [Resize] or [Cropping], a new edited picture is created. A new picture cannot be created if there is no free space on the built-in memory or the card so we recommend checking that there is free space and then editing the picture.

### [Upload Set]

It is possible to setup the images to be uploaded to the image sharing sites (Facebook/YouTube) on this unit.

- You can only upload motion pictures to YouTube, while you may upload both motion pictures and still pictures to Facebook.
- **This cannot be done to the images in the built-in memory. Copy the images to a card (P96), and then perform the [Upload Set].**

**1** Select [Upload Set] on the [Playback] menu. (P37)

**2** Press ▲/▼ to select [SINGLE] or [MULTI] and then press [MENU/SET].

**3** Select the picture, and then press [MENU/SET] to set.

- The setting is canceled when [MENU/SET] is pressed again.
- Exit the menu after it is set.

#### [MULTI] setting

Press [DISP.] to set (repeat), and then press [MENU/SET] to set.

- The setting is canceled when [DISP.] is pressed again.
- Confirmation screen is displayed. It is executed when [Yes] is selected. Exit the menu after it is executed.

[SINGLE]



Press ◀/▶ to select the picture.

[MULTI]

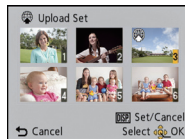

Press ▲/▼/◀/▶ to select the pictures.

## ■ Upload to the image sharing sites

An upload tool built into the camera, "LUMIX Image Uploader," is automatically copied to the card when you set up [Upload Set].

Perform the upload operation after connecting the camera to a PC (P102). For details, refer to P104.

## ■ Canceling all the [Upload Set] settings

**1** Select [Upload Set] on the [Playback] menu.

**2** Press ▲/▼ to select [CANCEL] and then press [MENU/SET].

- Confirmation screen is displayed. It is executed when [Yes] is selected. Exit the menu after it is executed.

### Note

- Setting may not be possible for pictures recorded with other cameras.
- It cannot be set with the card less than 512 MB.

## [Text Stamp]

You can stamp the recording date/time, name, location or travel date onto the recorded pictures.

**1** Select [Text Stamp] on the [Playback] menu. (P37)

**2** Press ▲/▼ to select [SINGLE] or [MULTI] and then press [MENU/SET].

**3** Select the picture, and then press [MENU/SET] to set.

- [☑] is displayed on pictures already with date or text stamped.

## [MULTI] setting

Press [DISP.] to set (repeat), and then press [MENU/SET] to set.

- The setting is canceled when [DISP.] is pressed again.

[SINGLE]

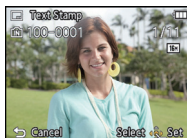

Press ◀/▶ to select the picture.

[MULTI]

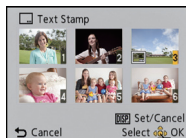

Press ▲/▼/◀/▶ to select the pictures.

**4** Press ▲/▼ to select [Set], and then press [MENU/SET].

**5** Press ▲/▼ to select text stamp items, and then press [MENU/SET].

**6** Press ▲/▼ to select the settings, and then press [MENU/SET].

Item	Setting item
[Shooting Date]	<p>[W/O TIME]: Stamp the year, month and day.</p> <p>[WITH TIME]: Stamp the year, month, day, hour and minutes.</p> <p>[OFF]</p>
[Name]	<p>[☑/🐶] ((Baby/Pet)): Stamps names registered in name settings for [Baby1]/[Baby2] or [Pet] in Scene Mode.</p> <p>[OFF]</p>
[Location]	<p>[ON]: Stamps the travel destination name set under [Location].</p> <p>[OFF]</p>
[Travel Date]	<p>[ON]: Stamps the travel date set under [Travel Date].</p> <p>[OFF]</p>

**7** Press [ / ].

**8** Press **▲** to select **[OK]**, and then press **[MENU/SET]**.

- Confirmation screen is displayed. It is executed when [Yes] is selected. Exit the menu after it is executed.

 **Note**

- When you print pictures stamped with text, the date will be printed over the stamped text if you specify printing of the date at the photo shop or on the printer.
- You can set up to 50 pictures at one time in [MULTI].
- The picture quality may deteriorate when text stamping is carried out.
- Depending on the printer being used, some characters may be cut at printing. Check before printing.
- When text is stamped onto the 0.3M pictures, it is difficult to read it.
- Text and dates cannot be stamped on the pictures in the following cases.
  - Motion pictures
  - Pictures taken in [Panorama Shot] in Scene Mode
  - Pictures recorded without setting the clock
  - Pictures with date or text stamped
  - Pictures recorded with other equipment



## [Video Divide]

Recorded motion picture can be divided in two. It is recommended for when you want to divide a part you need with a part you do not need.

**It cannot be restored once divided.**

- 1** Select [Video Divide] on the [Playback] menu. (P37)
- 2** Press ◀/▶ to select the motion picture to divide, and then press [MENU/SET].

- 3** Press ▲ at the location to divide.

- Motion picture is played back from the same location when ▲ is pressed again.
- You can finely adjust the location for division by pressing ◀/▶ while the motion picture is paused.



- 4** Press ▼.

- Confirmation screen is displayed. It is executed when [Yes] is selected. Exit the menu after it is executed.
- Motion picture may be lost if the card or battery is removed while processing the dividing.

### Note

- [Video Divide] may not be performed on motion pictures recorded with other equipment.
- Motion pictures cannot be divided at a location close to the start or end of the motion picture.
- The order of images will change if motion pictures are divided. It is recommended to search these motion pictures by using [Calendar] or [Category Selection] in the [Filtering Play].
- Motion pictures with a short recording time cannot be divided.

**[Resize]**

To allow easy posting to web pages, attachment to email etc., picture size (number of pixels) is reduced.

- 1** Select **[Resize]** on the **[Playback]** menu. **(P37)**
- 2** Press **▲/▼** to select **[SINGLE]** or **[MULTI]** and then press **[MENU/SET]**.
- 3** Select the picture and size.

**[SINGLE] setting**

- 1** Press **◀/▶** to select the picture, and then press **[MENU/SET]**.
- 2** Press **◀/▶** to select the size, and then press **[MENU/SET]**.
  - Confirmation screen is displayed. It is executed when **[Yes]** is selected.
  - Exit the menu after it is executed.

**[MULTI] setting**

- 1** Press **▲/▼** to select the size, and then press **[MENU/SET]**.
- 2** Press **▲/▼/◀/▶** to select the picture, and then press **[DISP.]**.
  - Repeat this step for each picture, and press **[MENU/SET]** to set.
  - Confirmation screen is displayed. It is executed when **[Yes]** is selected.
  - Exit the menu after it is executed.

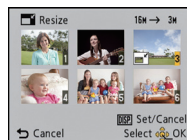
**Note**

- You can set up to 50 pictures at one time in **[MULTI]**.
- The picture quality of the resized picture will deteriorate.
- It may not be possible to resize pictures recorded with other equipment.
- The following images cannot be resized.
  - Motion pictures
  - Pictures taken in **[Panorama Shot]** in **Scene Mode**
  - Pictures with date or text stamped

**[Cropping]**

You can enlarge and then clip the important part of the recorded picture.

- 1** Select **[Cropping]** on the **[Playback]** menu. (P37)
- 2** Press **◀/▶** to select the picture, and then press **[MENU/SET]**.
- 3** Use the zoom lever and press **▲/▼/◀/▶** to select the parts to be cropped.



Zoom lever (T): Enlargement

Zoom lever (W): Reduction

▲/▼/◀/▶: Move

- 4** Press **[MENU/SET]**.

- Confirmation screen is displayed. It is executed when [Yes] is selected. Exit the menu after it is executed.

 **Note**

- The picture quality of the cropped picture will deteriorate.
- It may not be possible to crop pictures recorded with other equipment.
- The following images cannot be cropped.
  - Motion pictures
  - Pictures taken in [Panorama Shot] in Scene Mode
  - Pictures with date or text stamped

**[Favorite]**

You can do the following if a mark has been added to pictures and they have been set as favorites.

- Play back only the pictures set as favorites. ([Favorite] in [Filtering Play])
- Play back the pictures set as favorites only as a Slide Show.
- Delete all the pictures not set as favorites. ([All Delete Except Favorite])

**1** Select **[Favorite]** on the **[Playback]** menu. (P37)

**2** Press **▲/▼** to select **[SINGLE]** or **[MULTI]** and then press **[MENU/SET]**.

**3** Select the picture, and then press **[MENU/SET]**.

- The setting is canceled when [MENU/SET] is pressed again.
- Exit the menu after it is set.

[SINGLE]



Press **◀/▶** to select the picture.

[MULTI]

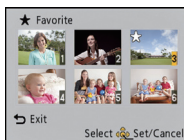

Press **▲/▼/◀/▶** to select the pictures.

#### ■ Canceling all the [Favorite] settings

**1** Select **[Favorite]** on the **[Playback]** menu.

**2** Press **▲/▼** to select **[CANCEL]** and then press **[MENU/SET]**.

- Confirmation screen is displayed. It is executed when [Yes] is selected. Exit the menu after it is executed.

#### Note

- You can set up to 999 pictures as favorites.
- You may not be able to set pictures taken with other equipment as favorites.

## [Print Set]

DPOF "Digital Print Order Format" is a system that allows the user to select which pictures to print, how many copies of each picture to print and whether or not to print the recording date on the pictures when using a DPOF compatible photo printer or photo printing store. For details, ask at your photo printing store.

When you want to use a photo printing store to print pictures recorded on the built-in memory, copy them to a card (P96) and then set the print setting.

For more information visit:

[http://panasonic.jp/dc/dpof\\_110/white\\_e.htm](http://panasonic.jp/dc/dpof_110/white_e.htm)

**1** Select [Print Set] on the [Playback] menu. (P37)

**2** Press ▲/▼ to select [SINGLE] or [MULTI] and then press [MENU/SET].

**3** Select the picture, and then press [MENU/SET].

[SINGLE]

[MULTI]



Press ◀/▶ to select the picture.

Press ▲/▼/◀/▶ to select the pictures.

**4** Press ▲/▼ to set the number of prints, and then press [MENU/SET] to set.

- When [MULTI] has been selected, repeat steps 3 and 4 for each picture. (It is not possible to use the same setting for a multiple number of pictures.)
- Exit the menu after it is set.

### ■ Canceling all the [Print Set] settings

**1** Select [Print Set] on the [Playback] menu.

**2** Press ▲/▼ to select [CANCEL] and then press [MENU/SET].

- Confirmation screen is displayed. It is executed when [Yes] is selected. Exit the menu after it is executed.

## ■ To print the date

After setting the number of prints, set/cancel printing with the recording date by pressing [DISP].

- Depending on the photo printing store or the printer, the date may not be printed even if you set to print the date. For further information, ask at your photo printing store or refer to the operating instructions for the printer.
- The date cannot be printed on pictures with date or text stamped.



### Note

- The number of prints can be set from 0 to 999.
- Depending on the printer, the date print settings of the printer may take precedence so check if this is the case.
- It may not be possible to use the print settings with other equipment. In this case, cancel all the settings, and reset the settings.
- [Print Set] cannot be set for motion pictures.
- If the file is not based on the DCF standard, the print setting cannot be set.

**[Protect]**

You can set protection for pictures you do not want to be deleted by mistake.

- 1** Select **[Protect]** on the **[Playback]** menu. **(P37)**
- 2** Press **▲/▼** to select **[SINGLE]** or **[MULTI]** and then press **[MENU/SET]**.
- 3** Select the picture, and then press **[MENU/SET]**.

- The settings are canceled when **[MENU/SET]** is pressed again.
- Exit the menu after it is set.

**[SINGLE]**

Press **◀/▶** to select the picture.

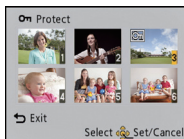
**[MULTI]**

Press **▲/▼/◀/▶** to select the pictures.

#### ■ Canceling all the **[Protect]** settings

- 1** Select **[Protect]** on the **[Playback]** menu.
- 2** Press **▲/▼** to select **[CANCEL]** and then press **[MENU/SET]**.
  - Confirmation screen is displayed. It is executed when **[Yes]** is selected.
  - Exit the menu after it is executed.

#### **Note**

- The protect setting may not be effective on other equipment.
- Even if you protect pictures in the built-in memory or a card, they will be deleted if the built-in memory or the card is formatted.
- Even if you do not protect pictures on a card, they cannot be deleted when the card's Write-Protect switch is set to **[LOCK]**.

**[Copy]**

You can copy the data of the pictures you have taken from the built-in memory to a card or from a card to the built-in memory.

**1** Select **[Copy]** on the **[Playback]** menu. (P37)

**2** Press **▲/▼** to select the copy destination and then press **[MENU/SET]**.

**[IN+SD]** ((IN→SD)): All the picture data in the built-in memory are copied onto the card at one time.

**[SD+IN]** ((SD→IN)): One picture at a time is copied from the card to the built-in memory.

Press **◀/▶** to select the picture and then press **[MENU/SET]**.

- Confirmation screen is displayed. It is executed when [Yes] is selected. Exit the menu after it is executed.
- Do not turn the camera off at any point during the copying process.

 **Note**

- If a picture exists with the same name (folder number/file number) as the picture to be copied in the copy destination when **[IN+SD]** is selected, a new folder is created and the picture is copied. If a picture exists with the same name (folder number/file number) as the picture to be copied in the copy destination when **[SD+IN]** is selected, that picture is not copied.
- It may take time to copy the picture data.
- [Print Set], [Protect] or [Favorite] settings will not be copied. Perform the settings again after copying is finished.



## Playing Back Pictures on a TV Screen

Pictures recorded with this unit can be played back on a TV screen.

### DMC-SZ1

- Please use the supplied AV cable.

### DMC-SZ02 DMC-FH8

- Please use the optional AV cable (DMW-AVC1).

Preparations:

Set the [TV Aspect]. (P43)

Turn this unit and the TV off.

## 1 Connect the camera and a TV.

- Check the directions of the connectors, and plug them straight in or unplug them straight out. (Otherwise the connectors may bend out of shape, which may cause malfunction.)
- **DMC-SZ1**  
Do not use any other AV cables except the supplied one.
- **DMC-SZ02 DMC-FH8**  
Always use a genuine Panasonic AV cable (DMW-AVC1: optional).

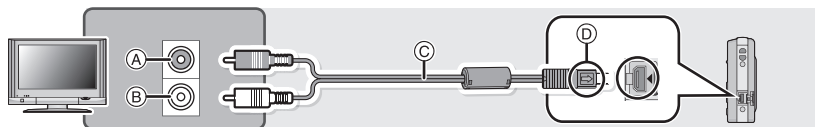

- (A) Yellow: to the video input socket  
 (B) White: to the audio input socket  
 (C) AV cable  
 (D) Align the marks, and insert.

## 2 Turn the TV on and select external input.

## 3 Turn the camera on and then slide the REC/PLAY switch to [▶].

### Note

- Depending on the [Picture Size], black bands may be displayed on the top and bottom or the left and right of the pictures.
- Change the screen mode on your TV if the picture is displayed with the top or bottom cut off.
- When you play back a picture vertically, it may be blurry.
- When pictures are displayed, they may not be displayed properly depending on the type of TV.
- No sound is output from the camera speakers.
- Read the operating instructions for the TV.

The recorded still pictures can be played back on a TV with an SD Memory Card slot.

- Depending on the TV model, pictures may not be displayed on the full screen.
- Motion pictures cannot be played back. To play back motion pictures, connect the camera to the TV with the AV cable.
- In some cases, panorama pictures cannot be played back. Also, auto-scroll playback of panorama pictures may not work.
- For cards compatible with playback, refer to the operating instructions of the TV.

## Saving the Recorded Still Pictures and Motion Pictures

Methods to export still pictures and motion pictures to other devices will vary depending on the file format (JPEG or MP4). Here are a few suggestions.

### Copy by inserting the SD card into the recorder

**Panasonic devices compatible with the respective file format (such as a Blu-ray Disc recorder) can be used to copy the images.**

For details on compatible devices, refer to the support sites below.

<http://panasonic.jp/support/global/cs/dsc/>

(This Site is English only.)

\* Some compatible devices may not be sold in certain countries and regions.

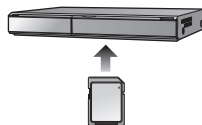

- See the operating instructions for the recorder about the details about copying and playing back.

## Copy the playback image using an AV cable

Copy images played back with this unit to Blu-ray disc, DVD disc, hard disk, or video using a Blu-ray Disc Recorder, DVD recorder, or video.

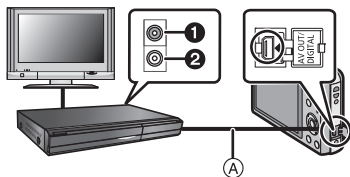

- ① Yellow: to the video input socket
- ② White: to the audio input socket
- Ⓐ AV cable

**1** Connect this unit with the recording equipment with an AV cable.

**2** Start the playback of this unit.

**3** Start the recording on the recording equipment.

- When ending the recording (copying), stop the playback on this unit after stopping the recording of the recording equipment.

### Note

- When you play back motion pictures on 4:3 aspect ratio TV, you must set [TV Aspect] (P43) on this unit to [4:3] before starting a copy. The image will be vertically long if you play back motion pictures copied with [16:9] setting on a [4:3] aspect TV.
- See the operating instructions for the recording equipment regarding the details of copying and playing back.

## Copying to a PC using “PHOTOfunSTUDIO”

The software “PHOTOfunSTUDIO” on the CD-ROM (supplied) can be used to save all the still pictures and motion pictures recorded by the camera in their various formats to your computer.



### **1** Install “PHOTOfunSTUDIO” to the PC.

- Read the separate “Basic Owner’s Manual” for more information about the software in the CD-ROM (supplied) and how to install it.

### **2** Connect camera to PC.

- For details on how to connect the camera, refer to “Loading still pictures or motion pictures” (P102).

### **3** Copy the images to a PC using “PHOTOfunSTUDIO”.

- For details, refer to the operating instructions of “PHOTOfunSTUDIO” (PDF).

#### **Note**

- Do not delete or move imported files or folders in Windows Explorer. When viewing in “PHOTOfunSTUDIO”, you will not be able to play back or edit.

## Connecting to a PC

You can transfer the pictures in the camera to a PC by connecting the camera and the PC.

- Some PCs can read directly from the card removed from the camera. For details, refer to the operating instructions of your PC.
- **If the computer being used does not support SDXC Memory Cards, a message prompting you to format may appear. (Doing so will cause recorded images to be erased so do not choose to format.)**  
**If the card is not recognized, please refer to the below support site.**  
**<http://panasonic.net/avc/sdcard/information/SDXC.html>**
- You can easily print out or mail the pictures you have imported. Use of the "PHOTOfunSTUDIO" bundled software on the CD-ROM (supplied) is a convenient way of doing this.
- Read the separate "Basic Owner's Manual" for more information about the software in the CD-ROM (supplied) and how to install it.

### ■ PC that can be used

The unit can be connected to any PC capable of recognizing a mass storage device.

- Windows support: Windows 7/Windows Vista/Windows XP/Windows 2000/  
Windows Me
- Mac support: OS X v10.1 ~ v10.7

## Loading still pictures or motion pictures

### Preparations:

Turn on the camera and the PC.

Remove the card before using the pictures in the built-in memory.

### 1 Connect the computer and camera with the USB connection cable (supplied).

- Check the directions of the connectors, and plug them straight in or unplug them straight out. (Otherwise the connectors may bend out of shape, which may cause malfunction.)
- Do not use any other USB connection cables except the supplied one. Use of cables other than the supplied USB connection cable may cause malfunction.

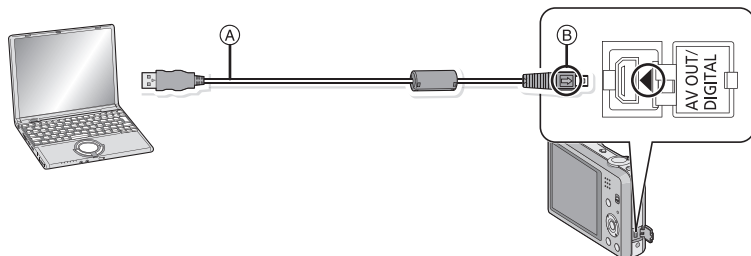

Ⓐ USB connection cable (supplied)

Ⓑ Align the marks, and insert.

### 2 Press ▲/▼ to select [PC], and then press [MENU/SET].

### 3 Operate the PC.

- You can save the images into the PC by dragging and dropping the image, or the folder with the image that you would like to transfer onto a different folder in the PC.

#### Note

- Use a battery with sufficient battery power. If the remaining battery power becomes low while the camera and the PC are communicating, the alarm beeps. Refer to "Disconnecting the USB connection cable safely" (P103) before disconnecting the USB connection cable. Otherwise, data may be destroyed.
- Before inserting or removing a card, turn the camera off and disconnect the USB connection cable. Otherwise, data may be destroyed.

■ **Viewing the contents of the built-in memory or card using the PC (folder composition).**

**For Windows:** A drive ([Removable Disk]) is displayed in [Computer]

**For Mac:** A drive ([LUMIX], [NO\_NAME] or [Untitled]) is displayed on the desktop

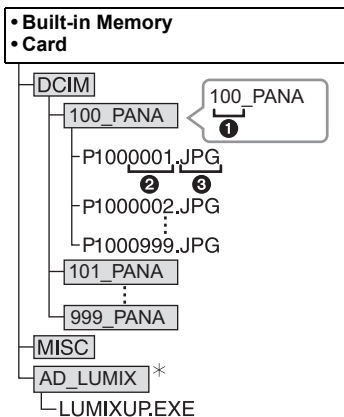

DCIM:	Images
<b>1</b>	Folder number
<b>2</b>	File number
<b>3</b>	JPG:
	Still pictures
	MP4:
	MP4 Motion pictures
MISC:	DPOF print
	Favorite
AD_LUMIX:	For Upload set
LUMIXUP.EXE	Upload tool
	“LUMIX Image Uploader”
	* Cannot be created in the built-in memory.

A new folder is created when pictures are taken in the following situations.

- When a card containing a folder with the same folder number has been inserted (Such as when pictures were taken using another maker of camera)
- When there is a picture with file number 999 inside the folder

■ **Disconnecting the USB connection cable safely**

Select the [Eject] icon in the task tray displayed on the PC, and then click [Eject DMC-XXX] (XXX varies by model).

- Depending on your PC's settings, this icon may not be displayed.
- If the icon is not displayed, check that [Access] is not displayed on the LCD monitor of the digital camera before removing the hardware.

■ **Connection in the PTP Mode (Windows® XP, Windows Vista®, Windows® 7, and Mac OS X only)**

Select [PictBridge(PTP)] when connecting USB cable.

- Data can now be read only from the card in the PC.
- When there are 1000 or more pictures on a card, the pictures may not be imported in the PTP Mode.
- Motion picture cannot be played back in PTP Mode.

## Uploading the images to sharing sites

Still pictures and motion pictures can be uploaded to image sharing sites (Facebook/YouTube) using the upload tool “LUMIX Image Uploader”.

You do not need to transfer the images to the PC or install dedicated software onto the PC, so you can easily upload the images even away from your home or work if there is a PC that is connected to the network.

- It is only compatible with a PC with Windows XP/Windows Vista/Windows 7.
- For details, refer to the operating instructions of “LUMIX Image Uploader” (PDF).

Preparations:

Setup the images to upload with [Upload Set] (P85).

Connect the PC to the Internet.

Create an account at the image sharing site to be used, and prepare the login information.

### 1 Start up the “LUMIXUP.EXE” by double-clicking it. (P103)

- An upload tool “LUMIX Image Uploader” may startup automatically if the “PHOTOfunSTUDIO” software on the CD-ROM (supplied) is installed.

### 2 Select the destination to upload.

- Operate following the instructions displayed on the PC screen.

#### Note

- Operation cannot be guaranteed for future specification changes of the YouTube and Facebook services. Service contents or screen may be modified without notice. (This service is as of November 1st, 2011)
- Do not upload any images protected by copyright, unless you own the copyright yourself, or have permission from the relevant copyright holder.
- **Images may contain personal information that can be used to identify the user, such as a title, the time and date when the images were taken, and the location where the image was taken if the camera includes a GPS function. Check this information before uploading images to image sharing sites.**



## Printing the Pictures

If you connect the camera to a printer supporting PictBridge, you can select the pictures to be printed out and instruct that printing be started on the camera's LCD monitor.

- Some printers can print directly from the card removed from the camera. For details, refer to the operating instructions of your printer.

Preparations:

Turn on the camera and the printer.

Remove the card before printing the pictures from the built-in memory.

Check print quality and other settings on the printer before printing the pictures.

### 1 Connect the printer and camera with the USB connection cable (supplied).

- Check the directions of the connectors, and plug them straight in or unplug them straight out. (Otherwise the connectors may bend out of shape, which may cause malfunction.)
- Do not use any other USB connection cables except the supplied one. Use of cables other than the supplied USB connection cable may cause malfunction.

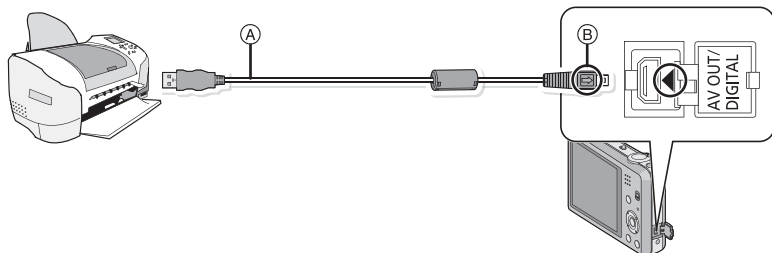

- Ⓐ USB connection cable (supplied)
- Ⓑ Align the marks, and insert.

### 2 Press ▲/▼ to select [PictBridge(PTP)], and then press [MENU/SET].

#### Note

- Use a battery with sufficient battery power. If the remaining battery power becomes low while the camera and the printer are connected, the alarm beeps. If this happens during printing, stop printing at once. If not printing, disconnect the USB connection cable.
- Do not disconnect the USB cable while [ ] (Cable disconnect prohibit icon) is displayed. (may not be displayed depending on the type of printer used)
- Before inserting or removing a card, turn the camera off, and disconnect the USB connection cable.
- Motion pictures cannot be printed out.

## Selecting a single picture and printing it

- 1 Press **◀/▶** to select the picture and then press **[MENU/SET]**.

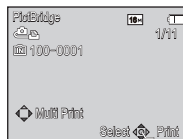

- 2 Press **▲** to select **[Print start]** and then press **[MENU/SET]**.

- Refer to [P107](#) for the items which can be set before starting to print the pictures.
- Disconnect the USB connection cable after printing.

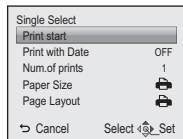

## Selecting multiple pictures and printing them

- 1 Press **▲**.

- 2 Press **▲/▼** to select an item and then press **[MENU/SET]**.

Item	Description of settings
<b>[Multi Select]</b>	Multiple pictures are printed at one time. • Press <b>▲/▼/◀/▶</b> to select the pictures, and then press <b>[DISP.]</b> . (When <b>[DISP.]</b> is pressed again, the setting is canceled.) • After the pictures have been selected, press <b>[MENU/SET]</b> .
<b>[Select All]</b>	Prints all the stored pictures.
<b>[Print Set (DPOF)]</b>	Prints the pictures set in <b>[Print Set]</b> only. ( <a href="#">P93</a> )
<b>[Favorite]</b>	Prints the pictures set as favorites only. ( <a href="#">P92</a> )

- 3 Press **▲** to select **[Print start]** and then press **[MENU/SET]**.

- If the print check screen has appeared, select **[Yes]**, and print the pictures.
- Refer to [P107](#) for the items which can be set before starting to print the pictures.
- Disconnect the USB connection cable after printing.

## Print Settings

Select and set the items both on the screen in step 2 of the “Selecting a single picture and printing it” and in step 3 of the “Selecting multiple pictures and printing them” procedures.

- When you want to print pictures in a paper size or a layout which is not supported by the camera, set [Paper Size] or [Page Layout] to  and then set the paper size or the layout on the printer. (For details, refer to the operating instructions of the printer.)
- When [Print Set (DPOF)] has been selected, the [Print with Date] and [Num.of prints] items are not displayed.

### [Print with Date]

Item	Description of settings
[ON]	Date is printed.
[OFF]	Date is not printed.

- If the printer does not support date printing, the date cannot be printed on the picture.
- Depending on the printer, the date print settings of the printer may take precedence so check if this is the case.
- When printing images with [Date Stamp] or [Text Stamp], please remember to set [Print with Date] to [OFF] or the date will print on top.

### Note

**When asking the photo shop to print the pictures**

- By stamping the date using [Date Stamp] (P75) or [Text Stamp] (P87) or setting date printing at the time of the [Print Set] (P93) setting before going to a photo shop, the dates can be printed at the photo shop.

### [Num.of prints]





You can set the number of prints up to 999.

**[Paper Size]**

Item	Description of settings
	Settings on the printer are prioritized.
[L/3.5"×5"]	89 mm×127 mm
[2L/5"×7"]	127 mm×178 mm
[POSTCARD]	100 mm×148 mm
[16:9]	101.6 mm×180.6 mm
[A4]	210 mm×297 mm
[A3]	297 mm×420 mm
[10×15cm]	100 mm×150 mm
[4"×6"]	101.6 mm×152.4 mm
[8"×10"]	203.2 mm×254 mm
[LETTER]	216 mm×279.4 mm
[CARD SIZE]	54 mm×85.6 mm

• Paper sizes not supported by the printer will not be displayed.

**[Page Layout] (Layouts for printing that can be set with this unit)**

Item	Description of settings
	Settings on the printer are prioritized.
	1 picture with no frame on 1 page
	1 picture with a frame on 1 page
	2 pictures on 1 page
	4 pictures on 1 page

- An item cannot be selected if the printer does not support the page layout.

**■ Layout printing****When printing a picture several times on 1 sheet of paper**

For example, if you want to print the same picture 4 times on 1 sheet of paper, set [Page Layout] to  and then set [Num.of prints] to 4 for the picture that you want to print.

**When printing different pictures on 1 sheet of paper**

For example, if you want to print 4 different pictures on 1 sheet of paper, set [Page Layout] to  and then set [Num.of prints] to 1 for each of the 4 pictures.

**Note**

- The camera is receiving an error message from the printer when the  indication lights orange during printing. After finishing printing, make sure there are no problems with the printer.
- If the number of prints is high, the pictures may be printed several times. In this case, the remaining number of prints indicated may differ from the number set.

# Screen Display

## ■ In recording

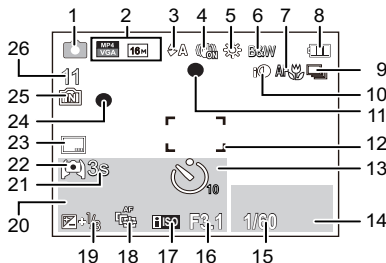

- |   |  |
|---|--|
| <p>1 Recording Mode</p> <p>2 Recording Quality (P76)<br/>Picture Size (P64)<br/>☑: Backlight Compensation (P24)</p> <p>3 Flash Mode (P49)</p> <p>4 Optical Image Stabilizer (P75)<br/>Ⓜ: Jitter alert (P21)</p> <p>5 White Balance (P66)</p> <p>6 Color Mode (P73)</p> <p>7 AF Macro Mode (P52)<br/>🔍: Macro Zoom Mode (P52)</p> <p>8 Battery indication (P12)</p> <p>9 Burst (P71)</p> <p>10 Intelligent Exposure (P70)</p> <p>11 Focus (P27)</p> <p>12 AF area (P27)</p> <p>13 Self-timer Mode (P53)</p> <p>14 AF tracking operation (P69)</p> <p>15 Shutter speed (P26)</p> <p>16 Aperture value (P26)</p> <p>17 ISO sensitivity (P65)</p> <p>18 AF Tracking (P69)<br/>AF*: AF assist lamp (P74)</p> | <p>19 Exposure compensation (P54)</p> <p>20 Number of days that have passed since the departure date (P40)<br/>Location (P40)<br/>Name (P61)<br/>Age (P61)<br/>Current date and time<br/>✈: World Time (P39)<br/>Zoom (P47): EZW [ ] T 1X</p> <p>21 Elapsed recording time* (P29): 8m30s</p> <p>22 LCD Mode (P42)</p> <p>23 Date Stamp (P75)</p> <p>24 Recording state (P29)</p> <p>25 Built-in memory (P16)<br/>☑: Card (P16) (displayed only during recording)</p> <p>26 Number of recordable pictures (P18)<br/>Available recording time* (P18, 29): 8m30s</p> <p>* "m" is an abbreviation for minute and "s" for second.</p> |
|---|--|

## ■ In playback

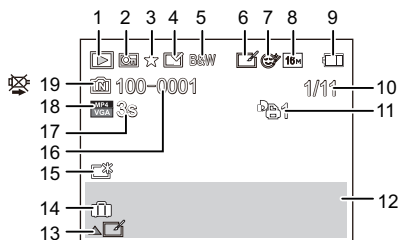

- |   |   |
|---|---|
| <ul style="list-style-type: none"> <li>1 Playback Mode (P77)</li> <li>2 Protected picture (P95)</li> <li>3 Favorite (P92)</li> <li>4 Date/Text stamped display (P75, 87)</li> <li>5 Color Mode (P73)</li> <li>6 After Auto Retouch (P82)</li> <li>7 <b>DMC-FH8</b></li> <li>After Beauty Retouch (P83)</li> <li>8 Picture Size (P64)</li> <li>9 Battery indication (P12)</li> <li>10 Picture number</li> <li>Total pictures</li> <li>Elapsed playback time* (P34): 8m30s</li> <li>11 Number of prints (P93)</li> <li>12 Location (P40)</li> <li>Recording information (P46)</li> <li>Name (P61)</li> <li>Age (P61)</li> </ul> | <ul style="list-style-type: none"> <li>13 Auto Retouch (P82)</li> <li>Beauty Retouch indicator (P83)</li> <li>Motion picture playback (P34)</li> <li>Play panorama (P59)</li> <li>14 Number of days that have passed since the departure date (P40)</li> <li>Recorded date and time</li> <li>✈: World Time (P39)</li> <li>15 Power LCD (P42)</li> <li>16 Folder/File number (P103)</li> <li>17 Motion picture recording time* (P34): 8m30s</li> <li>18 Recording Quality (P76)</li> <li>19 Built-in memory (P16)</li> <li>Cable disconnection warning icon (P105)</li> </ul> <p>* "m" is an abbreviation for minute and "s" for second.</p> |
|---|---|

## Cautions for Use

### Optimal use of the camera

**Keep this unit as far away as possible from electromagnetic equipment (such as microwave ovens, TVs, video games etc.).**

- If you use this unit on top of or near a TV, the pictures and/or sound on this unit may be disrupted by electromagnetic wave radiation.
- Do not use this unit near cell phones because doing so may result in noise adversely affecting the pictures and/or sound.
- Recorded data may be damaged, or pictures may be distorted, by strong magnetic fields created by speakers or large motors.
- Electromagnetic wave radiation generated by microprocessors may adversely affect this unit, disturbing the pictures and/or sound.
- If this unit is adversely affected by electromagnetic equipment and stops functioning properly, turn this unit off and remove the battery or disconnect AC adaptor (supplied). Then reinsert the battery or reconnect AC adaptor and turn this unit on.

**Do not use this unit near radio transmitters or high-voltage lines.**

- If you record near radio transmitters or high-voltage lines, the recorded pictures and/or sound may be adversely affected.

**Always use the supplied cords and cables. If you use optional accessories, use the cords and the cables supplied with them.**

**Do not extend the cords or the cables.**

**Do not spray the camera with insecticides or volatile chemicals.**

- If the camera is sprayed with such chemicals, the body of the camera may be damaged and the surface finish may peel off.
- Do not keep rubber or plastic products in contact with the camera for a long period of time.

**The speaker does not have magnetic shielding. Do not keep this speaker and magnetized cards (bank cards, commuter passes, etc.) close together.**



## Cleaning

**Before cleaning the camera, remove the battery or disconnect the power plug from the outlet. Then wipe the camera with a dry soft cloth.**

- When the camera is soiled badly, it can be cleaned by wiping the dirt off with a wrung wet cloth, and then with a dry cloth.
- Do not use solvents such as benzine, thinner, alcohol, kitchen detergents, etc., to clean the camera, since it may deteriorate the external case or the coating may peel off.
- When using a chemical cloth, be sure to follow the accompanying instructions.

## About the LCD monitor

- Do not press the LCD monitor with excessive force. Uneven colors may appear on the LCD monitor and it may malfunction.
- If the camera is cold when you turn it on, the picture on the LCD monitor will be slightly darker than usual at first. However, the picture will return to normal brightness when the internal temperature of the camera increases.

Extremely high precision technology is employed to produce the LCD monitor screen. However, there may be some dark or bright spots (red, blue, or green) on the screen. This is not a malfunction. The LCD monitor screen has more than 99.99% effective pixels with a mere 0.01% of the pixels inactive or always lit. The spots will not be recorded on pictures on the built-in memory or a card.

## About the Lens

- Do not press the lens with excessive force.
- Do not leave the camera with the lens facing the sun, as rays of light from the sun may cause it to malfunction. Also, be careful when placing the camera outside or near a window.

## Battery

**The battery is a rechargeable lithium ion battery. Its ability to generate power comes from the chemical reaction that takes place inside it. This reaction is susceptible to the surrounding temperature and humidity. If the temperature is too high or too low, the operating time of the battery will become shorter.**

### **Always remove the battery after use.**

- Place the removed battery in a plastic bag, and store or carry away from metallic objects (clips, etc.).

### **If you drop the battery accidentally, check to see if the body of the battery and the terminals are damaged.**

- Inserting a damaged battery in the camera will damage the camera.

### **Bring charged spare batteries when going out.**

- Be aware that the operating time of the battery becomes shorter in low temperature conditions such as at a ski resort.
- When you travel, do not forget to bring the AC adaptor (supplied) and USB connection cable (supplied) so that you can charge the battery in the country that you are traveling in.

### **Dispose of unusable battery.**

- The battery has a limited life.
- Do not throw the battery into fire because it may cause an explosion.
- The unusable battery should be discarded in accordance with battery recycling laws. Call the RBRC hotline at 1-800-822-8837 for information.

### **Do not allow battery terminals to come into contact with metal objects (such as necklaces, hairpins, etc.).**

- This can cause short-circuiting or heat generation and you may be badly burned if you touch a battery.

## AC adaptor (supplied)

- If you use the AC adaptor (supplied) near a radio, the radio reception may be disturbed.
- Keep the AC adaptor (supplied) 1 m (3.3 feet) or further away from radios.
- The AC adaptor (supplied) may generate whirring sounds when it is being used. This is not a malfunction.
- After use, be sure to disconnect the power supply device from the electrical outlet. (A very small amount of current is consumed if it is left connected.)

## Card

**Do not leave the card where the temperature is high, where electromagnetic waves or static electricity are easily generated or exposed to direct sunlight.**

**Do not bend or drop the card.**

- The card may be damaged or the recorded content may be damaged or deleted.
- Put the card in the card case or the storage bag after use and when storing or carrying the card.
- Do not allow dirt, dust, or water to get into the terminals on the back of the card and do not touch the terminals with your fingers.

**Notice for when transferring to another party, or disposing of the memory card**

- “Format” or “delete” using the camera or a PC will only modify the file management information, it will not erase the data in the memory card completely.

It is recommended to physically destroy the memory card or use the commercially available computer data deletion software to completely erase the data in the memory card before transferring to another party or disposing.

Management of data in the memory card is the responsibility of the user.

## About the personal information

If a name or birthday is set for [Baby1]/[Baby2], this personal information is kept in the camera and recorded in the image.

### Disclaimer

- Information including personal information may be altered or vanish due to erroneous operation, effect of static electricity, accident, malfunction, repair, or other handlings. Please note in advance that Panasonic is not liable in any way for any direct or indirect damage from the alteration or vanishing of information or personal information.

**When requesting a repair, transferring to another party, or disposing**

- Reset the settings to protect the personal information. (P43)
- If there are pictures stored in the built-in memory, copy them onto the memory card (P96) before formatting the built-in memory (P44) as needed.
- Remove the memory card from the camera when requesting a repair.
- Built-in memory and settings may return to factory default when camera is repaired.
- Please contact the dealer where you purchased the camera or your nearest Service Center if above operations are not possible due to malfunction.

**When transferring to another party, or disposing of the memory card, please refer to “Notice for when transferring to another party, or disposing of the memory card” above.**

### When not using the camera for a long period of time

- Store the battery in a cool and dry place with a relatively stable temperature: [Recommended temperature: 15 °C to 25 °C (59 °F to 77 °F), Recommended humidity: 40%RH to 60%RH]
- Always remove the battery and the card from the camera.
- If the battery is left inserted in the camera, it will discharge even if the camera is turned off. If the battery continues to be left in the camera, it will discharge excessively and may become unusable even if charged.
- When storing the battery for a long period of time, we recommend charging it once a year. Remove the battery from the camera and store it again after it has completely discharged.
- We recommend storing the camera with a desiccant (silica gel) when you keep it in a closet or a cabinet.

### About the picture data

Recorded data may be damaged or lost if the camera breaks down due to inappropriate handling. Panasonic will not be liable for any damage suffered due to loss of recorded data.

### About tripods or unipods

- When you use a tripod, make sure the tripod is stable when this unit is attached to it.
- You may not be able to remove the card or the battery when using a tripod or unipod.
- Make sure that the screw on the tripod or unipod is not at an angle when attaching or detaching the camera. You may damage the screw on the camera if you use excessive force when turning it. Also, the camera body and the rating label may be damaged or scratched if the camera is attached too tightly to the tripod or unipod.
- Read the operating instructions for the tripod or unipod carefully.
- **DMC-FH8**  
Some tripods or unipods may block the speaker, making it difficult to hear operating sounds etc.

## Message Display

Confirmation messages or error messages will be displayed on the screen in some cases. The major messages are described below as examples.

### [This picture is protected]

- Delete the picture after canceling the protect setting. (P95)

### [Some pictures cannot be deleted]/[This picture cannot be deleted]

- Pictures not based on the DCF standard cannot be deleted.
  - Format the card after saving necessary data on a PC etc. (P44)

### [Cannot be set on this picture]

- [Text Stamp] or [Print Set] cannot be set for pictures not based on the DCF standard.

### [Built-in memory full]/[Memory card full]/[Not enough space on built-in memory]/[Not enough memory on the card]

- There is no space left on the built-in memory or the card.
- When you copy pictures from the built-in memory to the card (batch copy), the pictures are copied until the capacity of the card becomes full.

### [Some pictures cannot be copied]/[Copy could not be completed]

- The following pictures cannot be copied.
  - When a picture with the same name as the picture to be copied exists in the copy destination. (Only when copying from a card to the built-in memory.)
  - Files not based on the DCF standard.
- Moreover, pictures recorded or edited by other equipment may not be copied.

### [Built-In Memory Error]/[Format built-in memory?]

- This message will be displayed when you format the built-in memory on a PC.
  - Format the built-in memory on the camera again. (P44) The data on the built-in memory will be deleted.

### [Memory card error. This card cannot be used in this camera. Format this card?]

- It is a format that cannot be used with this unit.
  - Insert a different card and try again.
  - Reformat on this unit (P44) after saving necessary data using a PC, etc. Data will be deleted.

**[Please turn camera off and then on again]/[System Error]**

- This message appears when the camera is not operating properly.
  - Turn the camera off and on. If the message persists, contact the dealer or your nearest Service Center.

**[Memory Card Error]/[Memory card parameter error]/[This memory card cannot be used]**

- Use a card compatible with this unit. (P16)
- SD Memory Card (8 MB to 2 GB)
- SDHC Memory Card (4 GB to 32 GB)
- SDXC Memory Card (48 GB, 64 GB)

**[Insert SD card again]/[Try another card]**

- An error has occurred accessing the card.
  - Insert the card again.
  - Insert a different card.

**[Read Error/Write Error  
Please check the card]**

- It has failed to read or write data.
  - Remove the card after turning the power [OFF]. Insert the card again, turn the power on, and try to read or write the data again.
- The card may be broken.
  - Insert a different card.

**[Motion recording was cancelled due to the limitation of the writing speed of the card]**

- Use a card with SD Speed Class with “Class 4” or higher when recording motion pictures.
- In the event that it stops even after using a “Class 4” card or higher, the data writing speed has deteriorated so it is recommended to make a backup and then format (P44).
- Depending on the type of the card, motion picture recording may stop in the middle.

**[Cannot record due to incompatible format(NTSC/PAL) data on this card.]**

- Format the card after saving necessary data on a PC etc. (P44)
- Insert a different card.

**[A folder cannot be created]**

- A folder cannot be created because there are no remaining folder numbers that can be used.
  - Format the card after saving necessary data on a PC etc. (P44)

**[Picture is displayed for 16:9 TV]/[Picture is displayed for 4:3 TV]**

- Select [TV Aspect] in the [Setup] menu if you want to change the TV aspect. (P43)
- This message also appears when the USB connection cable is connected to the camera only. In this case, connect the other end of the USB connection cable to a PC or a printer. (P102, 105)

**[This battery cannot be used]**

- Use a genuine Panasonic battery. If this message is displayed even when a genuine Panasonic battery is used, contact the dealer or your nearest Service Center.
- If the battery terminal is dirty, clean it and remove any objects.

## Troubleshooting

First, try out the following procedures (P119–127).

If the problem is not resolved, it may be improved by selecting **[Reset] (P43)** on the **[Setup]** menu.

### Battery and power source

#### The charging lamp has gone off but the unit has not been charged.

- This phenomenon occurs when charging in a location where the temperature is very high or very low.
  - Reconnect the USB connection cable (supplied) in a location where the ambient temperature (and the temperature of battery) is in a 10 °C to 30 °C (50 °F to 86 °F) range, and try charging again. [If you reconnect the USB connection cable (supplied) when the unit is fully charged, the charging lamp will turn on for approximately 15 seconds.]

#### The camera cannot be operated even when it is turned on. The camera turns off immediately after it is turned on.

- The battery is exhausted. Charge the battery.
- If you leave the camera on, the battery will be exhausted.
  - Turn the camera off frequently by using the [Sleep Mode]. (P42)

#### Card/battery door does not close.

- Insert the battery securely all the way in. (P10)

### Recording

#### The picture cannot be recorded.

- Is the REC/PLAY switch at the  setting? (P22)
- Is there any memory remaining on the built-in memory or the card?
  - Delete the pictures which are not necessary to increase available space in the memory. (P35)
- You may not be able to record for a short while after turning the power [ON] when using a large capacity card.

#### The recorded picture is whitish.

- The picture can become whitish if there is dirt, e.g. fingerprints on the lens.
  - If the lens is dirty, turn on the camera, eject the lens barrel and gently wipe the lens surface with a soft, dry cloth.

#### The recorded picture is too bright or dark.

- Check that the exposure is correctly compensated. (P54)

#### Multiple pictures are taken at one time.

- Set [Burst] (P71) of the [Rec] menu to [OFF].

### The subject is not focused properly.

- The focus range varies depending on the Recording Mode.  
→ Set to the proper mode for the distance to the subject.
- The subject is beyond the focus range of the camera. (P27)
- There is camera shake (jitter) or the subject is moving slightly. (P21)

### The recorded picture is blurred. The Optical Image Stabilizer is not effective.

- The shutter speed becomes slower when pictures are taken in dark places so hold the camera firmly with both hands to take the pictures. (P21)
- When taking pictures at a slow shutter speed, use the Self-timer. (P53)

### The recorded picture looks rough. Noise appears on the picture.

- Is the ISO sensitivity high or the shutter speed slow? (ISO sensitivity is set to [ISO] when the camera is shipped. Therefore, when taking pictures indoors etc. noise will appear.)  
→ Decrease the ISO sensitivity. (P65)  
→ Take pictures in bright places.
- Have you set [High Sens.] in Scene Mode, or [Burst] in [Rec] menu to [ ] or [ ]? If so, the resolution of the recorded picture decreases slightly because of high sensitivity processing, but this is not a malfunction.

### The brightness or the hue of the recorded picture is different from the actual scene.

- When recording under fluorescent or LED lighting fixture etc., increasing the shutter speed may introduce slight changes to brightness and color. These are a result of the characteristics of the light source and do not indicate a malfunction.

### When recording pictures or half-pressing the shutter button, reddish stripes may appear on the LCD monitor. Alternatively, part or all of the LCD monitor may turn a reddish color.

- This is a characteristic of CCDs, and it appears when the subject has a bright part. Some unevenness may occur in the surrounding areas, but this is not a malfunction.  
It is recorded in motion pictures but is not recorded on still pictures.
- It is recommended that when you take pictures you take care not to expose the screen to sunlight or any other source of strong light.

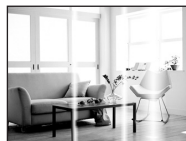



**Motion picture recording stops in the middle.**

- Use a card with SD Speed Class with “Class 4” or higher when recording motion pictures.
- Depending on the type of the card, recording may stop in the middle.
  - If motion picture recording stops during use of a card of at least “Class 4” or if you use a card that has been formatted on a PC or other equipment, the data-writing speed is lower. In such cases, we recommend that you make a backup of the data and then format (P44) the card in this unit.

**Subject cannot be locked.  
(AF tracking not possible)**

- Set the AF area to the distinctive color of the subject if there is a part that is different from the surrounding color. (P69)

**Recording by [Panorama Shot] ends before finishing.**

- If the camera is moved too slowly, the camera assumes that camera motion was stopped and ends the still picture recording.
- If there is a lot of camera shake in the recording direction while moving the camera, recording ends.
  - When recording with [Panorama Shot], move the camera by trying to trace a small circle parallel to the recording direction at a speed of about 8 seconds per revolution (estimated).

**Operation sound is small.**

- Is your finger covering up the speaker? (P8)

## LCD monitor

### The LCD monitor becomes darker or brighter for a moment.

- This phenomenon appears when you press the shutter button halfway to set the aperture value and does not affect the recorded pictures.
- This phenomenon also appears when the brightness changes when the camera is zoomed or when the camera is moved. This is because of operation of the automatic aperture of the camera, and it is not a malfunction.

### The LCD monitor flickers indoors.

- The LCD monitor may flicker for a few seconds after the power is switched on. This is an operation to correct flicker caused by lighting such as fluorescent lights, LED lights etc. and is not a malfunction.

### The LCD monitor is too bright or dark.

- Is [LCD Mode] active? (P42)
- Perform [LCD Display]. (P41)

### Black, red, blue and green dots appear on the LCD monitor.

- This is not a malfunction.  
These pixels do not affect the recorded pictures.

### Noise appears on the LCD monitor.

- In dark places, noise may appear to maintain the brightness of the LCD monitor. This does not affect the pictures you are recording.

## Flash

### The flash is not activated.



- Is the flash setting set to [☺]?  
→ Change the flash setting. (P49)
- The flash cannot be used in the following cases:
  - In Miniature Effect Mode (P55)
  - [Scenery]/[Panorama Shot]/[Night Scenery]/[Sunset]/[Glass Through] in Scene Mode (P56)
  - When recording in [Burst] (except for [📷]) (P71)

### Flash is activated several times.

- The flash is activated twice when Red-Eye Reduction (P49) has been set.
- Has [Burst] (P71) in the [Rec] menu been set to [📷]?

## Playback

**The picture being played back is rotated and displayed in an unexpected direction.**

- [Rotate Disp.] (P44) is set to [ ] or [].

**The picture is not played back.  
The recorded pictures are not displayed.**

- Is the REC/PLAY switch set to []? (P32)
- Is there a picture on the built-in memory or the card?
  - The pictures on the built-in memory appear when a card is not inserted. The picture data on the card appears when a card is inserted.
- Is this a folder or picture which was processed in the PC? If it is, it cannot be played back by this unit.
  - It is recommended to use the "PHOTOfunSTUDIO" software in the CD-ROM (supplied) to write pictures from PC to card.
- Has [Filtering Play] been set for playback?
  - Change to [Normal Play]. (P77)

**The folder number and the file number are displayed as [—] and the screen turns black.**

- Is this a non-standard picture, a picture which has been edited using a PC or a picture which was taken by another maker of digital cameras?
- Did you remove the battery immediately after picture-taking or did you take the picture using a battery with a low remaining charge?
  - Format the data to delete the pictures mentioned above. (P44)  
(Other pictures will be deleted as well and it will not be possible to restore them. Therefore, check well before formatting.)

**Playback sound or operation sound is too low.**

- Is something covering up the speaker? (P8)

**With a Calendar Search, pictures display dates differing from the actual dates on which the pictures were taken.**

- Is the clock in the camera set properly? (P19)
- When pictures edited using a PC or pictures taken by other equipment are searched, they may display dates differing from the actual dates on which the pictures were taken.

### White round spots like soap bubbles appear on the recorded picture.

- If you take a picture with the flash in a dark place or indoors, white round spots may appear on the picture caused by the flash reflecting off of particles of dust in the air. This is not a malfunction. A characteristic of this is that the number of round spots and their position differ in every picture.



### Red part of the recorded image has changed color to black.

- When Digital Red-Eye Correction ([], []) is in operation, if you take a picture of a subject with red color surrounded by a skin tone color, that red part may be corrected to black by the Digital Red-Eye Correction function.  
→ It is recommended to take a picture with the Flash Mode set to [A], [] or [], or [Red-Eye Removal] on the [Rec] menu set to [OFF]. (P74)

### [Thumbnail is displayed] appears on the screen.

- Is it a picture that has been recorded with other equipment? In such cases, these pictures may be displayed with a deteriorated picture quality.

### The sound of the recorded motion pictures sometimes breaks up.

- This unit automatically adjusts the aperture during motion picture recording. At such times, the sound may break up. This is not a malfunction.

### Motion pictures recorded with this model cannot be played back on other equipment.

- Even if a compatible MP4 playback device is used, the video or sound quality of the recorded motion pictures may be poor, or they may not be able to be played. The recorded data may also not be displayed properly in certain cases.

## TV, PC and printer

### The picture does not appear on the television.

- Is the camera connected to the TV correctly?  
→ Set the TV input to External Input Mode.

### The display areas on the TV screen and the camera's LCD monitor are different.

- Depending on the TV model, the pictures may be elongated horizontally or vertically or they may be displayed with their edges cut off.

### The motion pictures cannot be played back on a TV.

- Are you trying to play back the motion pictures by directly inserting the card in the card slot of the TV?  
→ Connect the camera to the TV with the AV cable and then play back the pictures on the camera. (P97)

### The picture is not displayed fully on the TV.

- Check [TV Aspect] setting. (P43)

### The picture cannot be transferred when the camera is connected to a PC.

- Is the camera connected to the PC correctly?
- Is the camera recognized by the PC correctly?  
→ Select [PC] when connecting. (P102)

### The card is not recognized by the PC. (The built-in memory is recognized.)

- Disconnect the USB connection cable. Connect it again while the card is inserted in the camera.
- If there are two or more USB terminal on a single PC, try connecting the USB connection cable to another USB terminal.

### The card is not recognized by the PC. (SDXC memory card is used)

- Check if your PC is compatible with SDXC memory cards.  
<http://panasonic.net/avc/sdcard/information/SDXC.html>
- A message prompting to format the card may be displayed when connecting, but do not format.
- If the [Access] displayed on the LCD monitor does not disappear, disconnect the USB connection cable after turning off the power.

### There is a problem trying to upload to YouTube or Facebook.

- Confirm that the login information (login ID/user name/email address/password) is correct.
- Confirm that the PC is connected to the Internet.
- Confirm that resident software such as virus protection software or firewall is not blocking access to YouTube or Facebook.
- Confirm with YouTube or Facebook as well.

### The picture cannot be printed when the camera is connected to a printer.

- Pictures cannot be printed using a printer that does not support PictBridge.  
→ Select [PictBridge(PTP)] when connecting. (P105)

### The ends of the pictures are cut at printing.



- When using a printer with a Cropping or borderless printing function, cancel this function before printing. (For details, refer to the operating instructions for the printer.)
- When you order photo studios to print pictures, ask the photo studio if the 16:9 pictures can be printed.

### The panorama picture is not printing correctly.

- Since aspect ratio of a panorama picture differs from normal pictures, it may not always be possible to print it correctly.  
→ Please use a printer that supports panorama pictures. (For details, refer to the operating instructions for the printer.)
- We recommend using the "PHOTOfunSTUDIO" software on the CD-ROM (supplied) to adjust the size of the still picture to the print paper size.

## Others

### An unreadable language was selected by mistake.

- Press [MENU/SET], select the [Setup] menu icon [  ]. Then press [MENU/SET], and then select the [  ] icon to set the desired language. (P44)

### A red lamp sometimes turns on when the shutter button is pressed halfway.

- In dark places, the AF Assist Lamp lights red to make it easier to focus on a subject.

### The AF Assist Lamp does not turn on.

- Is [AF Assist Lamp] on the [Rec] menu set to [ON]? (P74)
- The AF Assist Lamp does not turn on in bright places.

### The camera becomes warm.

- The surface of the camera may become warm during use. This does not affect the performance or quality of the camera.

### The lens clicks.

- When the brightness changes due to zoom or camera movement, etc., the lens may click and the picture on the screen may drastically change. However, the picture is not affected. The sound is caused by the automatic adjustment of the aperture. This is not a malfunction.

### The clock is reset.

- If you do not use the camera for a long time, the clock may be reset.  
→ [Please set the clock] message will be displayed; please reset the clock. (P19)

**When pictures are taken using the zoom, they are slightly distorted and the areas around the subject contain colors which are not actually present.**

- It is possible that the subject may be warped slightly, or the borders get colored, depending on the zoom magnification, due to the characteristics of the lens, but this is not a malfunction.

**Zooming stops instantaneously.**

- When using the Extended Optical Zoom, the zooming action will stop temporarily. This is not a malfunction.

**Zoom does not go up to maximum magnification.**

- Is the camera set to Macro Zoom Mode? ([P52](#))  
Maximum zoom during Macro Zoom Mode is 3× digital zoom.

**The file numbers are not recorded consecutively.**

- When you perform an operation after taking a certain action, the pictures may be recorded in folders with different numbers from the ones used prior to the operation.

**The file numbers are recorded with previously used numbers.**

- If the battery was inserted or removed without first turning the camera's power off, the folder and file numbers for the pictures taken will not be stored in the memory. When the power is then turned back on and pictures are taken, they may be stored under file numbers which should have been assigned to previous pictures.

**When the camera is left alone, the Slide Show is suddenly displayed.**

- This is the [Auto Demo] which introduces the features of the camera. Press a button to return the camera to the original screen.

- SDXC Logo is a trademark of SD-3C, LLC.
- QuickTime and the QuickTime logo are trademarks or registered trademarks of Apple Inc., used under license therefrom.
- Mac and Mac OS are trademarks of Apple Inc., registered in the U.S. and other countries.
- Windows and Windows Vista are either registered trademarks or trademarks of Microsoft Corporation in the United States and/or other countries.
- YouTube is a trademark of Google Inc.
- This product uses “DynaFont” from DynaComware Corporation. DynaFont is a registered trademark of DynaComware Taiwan Inc.
- Other names of systems and products mentioned in these instructions are usually the registered trademarks or trademarks of the manufacturers who developed the system or product concerned.



This product is licensed under the AVC patent portfolio license for the personal and non-commercial use of a consumer to (i) encode video in compliance with the AVC Standard (“AVC Video”) and/or (ii) decode AVC Video that was encoded by a consumer engaged in a personal and non-commercial activity and/or was obtained from a video provider licensed to provide AVC Video. No license is granted or shall be implied for any other use. Additional information may be obtained from MPEG LA, LLC. See <http://www.mpegla.com> .



## Free Manuals Download Website

<http://myh66.com>

<http://usermanuals.us>

<http://www.somanuals.com>

<http://www.4manuals.cc>

<http://www.manual-lib.com>

<http://www.404manual.com>

<http://www.luxmanual.com>

<http://aubethermostatmanual.com>

Golf course search by state

<http://golfingnear.com>

Email search by domain

<http://emailbydomain.com>

Auto manuals search

<http://auto.somanuals.com>

TV manuals search

<http://tv.somanuals.com>