

Panasonic[®]

Operating Instructions

Digital Camera

Model No. **DMC-FX50**

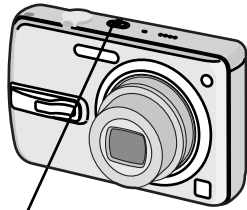

LEICA
DC VARIO-ELMARIT

Before connecting, operating or adjusting this product, please read the instructions completely.

For USA assistance, please call: 1-800-272-7033 or send e-mail to : digitalstillcam@panasonic.com

For Canadian assistance, please call: 1-800-561-5505 or visit us at www.panasonic.ca

PP

VQT0Y19

Dear Customer,

We would like to take this opportunity to thank you for purchasing this Panasonic Digital Camera. Please read these Operating Instructions carefully and keep them handy for future reference.

Information for Your Safety

WARNING
TO REDUCE THE RISK OF FIRE OR SHOCK HAZARD AND ANNOYING INTERFERENCE, USE ONLY THE RECOMMENDED ACCESSORIES AND DO NOT EXPOSE THIS EQUIPMENT TO RAIN OR MOISTURE. DO NOT REMOVE THE COVER (OR BACK); THERE ARE NO USER SERVICEABLE PARTS INSIDE. REFER SERVICING TO QUALIFIED SERVICE PERSONNEL.

Carefully observe copyright laws. Recording of pre-recorded tapes or discs or other published or broadcast material for purposes other than your own private use may infringe copyright laws. Even for the purpose of private use, recording of certain material may be restricted.

- Please note that the actual controls and components, menu items, etc. of your Digital Camera may look somewhat different from those shown in the illustrations in these Operating Instructions.
- SDHC Logo is a trademark.
- Leica is a registered trademark of Leica Microsystems IR GmbH.
- Elmarit is a registered trademark of Leica Camera AG.
- Other names, company names, and product names printed in these instructions are trademarks or registered trademarks of the companies concerned.

THE SOCKET OUTLET SHALL BE INSTALLED NEAR THE EQUIPMENT AND SHALL BE EASILY ACCESSIBLE.

CAUTION

Danger of explosion if battery is incorrectly replaced. Replace only with the same or equivalent type recommended by the manufacturer. Dispose of used batteries according to the manufacturer's instructions.



A lithium ion/polymer battery that is recyclable powers the product you have purchased. Please call 1-800-8-BATTERY for information on how to recycle this battery.

FCC Note: (U.S. only)

This equipment has been tested and found to comply with the limits for a Class B digital device, pursuant to Part 15 of the FCC Rules. These limits are designed to provide reasonable protection against harmful interference in a residential installation. This equipment generates, uses, and can radiate radio frequency energy and, if not installed and used in accordance with the instructions, may cause harmful interference to radio communications. However, there is no guarantee that interference will not occur in a particular installation. If this equipment does cause harmful interference to radio or television reception, which can be determined by turning the equipment off and on, the user is encouraged to try to correct the interference by one or more of the following measures:

- Reorient or relocate the receiving antenna.
- Increase the separation between the equipment and receiver.
- Connect the equipment into an outlet on a circuit different from that to which the receiver is connected.
- Consult the dealer or an experienced radio/TV technician for help.

FCC Caution: To assure continued compliance, follow the attached installation instructions and use only shielded interface cables with ferrite core when connecting to computer or peripheral devices.

Any changes or modifications not expressly approved by the party responsible for compliance could void the user's authority to operate this equipment.

Trade Name: Panasonic
Model No.: DMC-FX50
Responsible party: Panasonic Corporation of North America
One Panasonic Way, Secaucus, NJ 07094
Support Contact: Panasonic Consumer Electronics Company
1-800-272-7033

This device complies with Part 15 of the FCC Rules. Operation is subject to the following two conditions: (1) This device may not cause harmful interference, and (2) this device must accept any interference received, including interference that may cause undesired operation.

This Class B digital apparatus complies with Canadian ICES-003



Before Use

-If you see this symbol-

■ **Care of the camera**

- **Do not strongly shake or bump the camera.** The camera may stop operating normally, pictures may not be recorded or the lens may be damaged.
- **Sand or dust may cause the camera to malfunction. Make sure that sand or**

■ **About Condensation (When the lens is fogged up)**

- Condensation occurs when the ambient temperature or humidity changes as described below. Be careful of condensation since it causes lens stains, fungus and camera malfunction.
 - When the camera is taken from the cold outdoors to the warm indoors.
 - When the camera is taken from outside to inside an air-conditioned car.
 - When cool wind from an air conditioner etc. blows directly on the camera.
 - In humid places.
- To prevent condensation, put the camera in a plastic bag until the temperature of the camera is close to the ambient temperature. If condensation occurs, turn the camera off and leave it for about 2 hours. The fog will disappear naturally when the temperature of the camera becomes close to the ambient temperature.

■ **When not using the camera for a long period of time**

- Store the battery in a cool and dry place with a relatively stable temperature.
[Recommended temperature: 15 °C to 25 °C (59 °F to 77 °F),
Recommended humidity: 40% to 60%]
- Always remove the battery and the card from the camera.
- If the battery is left inserted in the camera, it will discharge even if the camera is turned off. If the battery continues to be left in the camera, it will discharge excessively and may become unusable even if charged.
- When storing the battery for a long period of time, we recommend charging it once a year. Remove the battery from the camera and store it again after it has completely discharged.
- We recommend storing the camera with a desiccant (silica gel) when you keep it in a closet or a cabinet.

■ **About cards that can be used in this unit**

You can use an SD Memory Card, an SDHC Memory Card and a MultiMediaCard.

- When the term **card** is used in these operating instructions this refers to the following types of Memory Cards.
 - SD Memory Card (8 MB to 2 GB)
 - SDHC Memory Card (4 GB)
 - MultiMediaCard

More specific information about memory cards that can be used with this unit.

- You can only use an SDHC Memory Card if using cards with 4 GB or more capacity.
- A 4 GB Memory Card without an SDHC logo is not based on the SD Standard and will not work in this product.

About the Mode Dial

Adjust part **A** to the desired mode.
Rotate the mode dial slowly and surely to adjust to each mode.

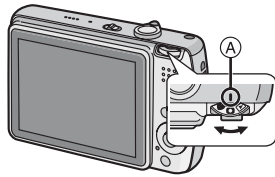



 : **Normal picture mode (P23)**
Use this mode for normal recording.

 : **Macro mode (P48)**
This mode allows you to take a close-up picture of a subject.

 : **Motion picture mode (P62)**
This mode allows you to record motion pictures.

SCN : **Scene mode (P49)**
This mode allows you to take pictures depending on the recording scenes.

 : **Simple mode (P26)**
This mode is recommended for beginners.

 : **Playback mode (P32)**
This mode allows you to play back recorded pictures.

 : **Print mode (P95)**
This mode allows you to print pictures of recorded pictures.

■ About indications in these operating instructions



The modes indicated here allow you to use the functions or settings shown on the page. Set the mode dial to any of the modes indicated to use the functions or settings.



Convenient or helpful information for use of the camera is described.

■ About illustrations in these operating instructions

The appearance of the product, the illustrations and menu screens etc. will differ slightly from those in actual use.

■ About illustrations of the joystick

In these operating instructions, operations using the joystick are described with illustrations.

e.g.:When you move the ▼ button

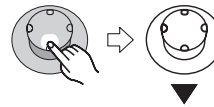

e.g.:When you Press the [MENU/SET] button



Contents

Before Use

| | |
|-----------------------------------|---|
| Information for Your Safety | 2 |
| About the Mode Dial | 6 |

Preparation

| | |
|--|----|
| Standard Accessories | 9 |
| Names of the Components | 10 |
| Quick Guide | 11 |
| Charging the Battery with the Charger | 12 |
| About the Battery (charging/ number of recordable pictures) | 13 |
| Inserting/Removing the Battery | 14 |
| Inserting/Removing the Card | 15 |
| About the Card | 16 |
| Setting Date/Time (Clock Set) | 17 |
| • Changing the clock setting | 17 |
| About the Setup Menu | 18 |

Basic

| | |
|--|----|
| Taking Pictures | 23 |
| Taking Pictures in Simple Mode | 26 |
| Taking Pictures with the Zoom | 28 |
| • Using the Optical Zoom | 28 |
| • Using the Extended Optical Zoom (EZ) | 29 |
| • Using the Digital Zoom Further extending the zoom | 30 |
| Checking the Recorded Picture | |

Menu Settings

| | |
|--|----|
| Using the [REC] Mode Menu | 70 |
| • [W.BALANCE] | |
| Adjusting the hue for a more natural picture..... | 71 |
| • [SENSITIVITY] | |
| Setting the light sensitivity | 73 |
| • [ASPECT RATIO] | |
| Setting the aspect ratio of pictures ... | 74 |
| • [PICT.SIZE]/[QUALITY] | |
| Setting a picture size and quality that match your use of the pictures ... | 75 |
| • [AUDIO REC.] | |
| Recording still pictures with audio | 76 |
| • [AF MODE] | |
| Setting the focus method..... | 77 |
| • [AF ASSIST LAMP] | |
| Focusing in low light conditions becomes easier | 78 |
| • [SLOW SHUTTER] | |
| Recording bright pictures in dark places | 78 |
| • [COL.EFFECT] | |
| Setting color effects for the recorded pictures..... | 79 |
| • [PICT.ADJ.] | |
| Adjusting the picture quality for the recorded pictures..... | 79 |
| • [CLOCK SET] | |
| Set the display order for the date and time..... | 79 |
| Using the [PLAY] mode menu | 80 |
| • [DUAL DISPLAY] | |
| Displaying the recorded pictures on a dual display | 80 |
| • [SLIDE SHOW] | |
| Playing back pictures in order for a fixed duration..... | 81 |
| • [FAVORITE] | |
| Setting your favorite pictures | 82 |
| • [ROTATE DISP.]/[ROTATE] | |
| To display the picture rotated | 83 |

| | |
|---|----|
| • [DPOF PRINT] | |
| Setting the picture to print and the number of prints | 85 |
| • [PROTECT] | |
| Preventing accidental erasure of pictures..... | 87 |
| • [AUDIO DUB.] | |
| Adding audio after taking pictures | 88 |
| • [RESIZE] | |
| Making the picture smaller | 88 |
| • [TRIMMING] | |
| Enlarging a picture and trimming it... .. | 89 |
| • [ASPECT CONV.] | |
| Changing the aspect ratio of a 16:9 picture..... | 90 |
| • [FORMAT] | |
| Initializing the card..... | 91 |

Connecting to other equipment

| | |
|--|----|
| Connecting to a PC..... | 92 |
| Printing the Pictures..... | 95 |
| Playing Back Pictures on a TV Screen.... | 99 |

Others

| | |
|---------------------|-----|
| Screen Display..... | 100 |
|---------------------|-----|

Standard Accessories

Check that all the accessories are included before using the camera.

| | |
|-------------------------------------|-------------------------------------|
| <p>1</p> <p>RP-SD016B</p> | <p>2</p> <p>CGA-S005A</p> |
| <p>3</p> <p>DE-A11B</p> | <p>4</p> <p>K1HA08CD0007</p> |
| <p>5</p> <p>K1HA08CD0008</p> | <p>6</p> |
| <p>7</p> <p>VFC4090</p> | <p>8</p> <p>VYQ3509</p> |

- 1** SD Memory Card (16 MB)
 - 2** Battery Pack
(Indicated as **battery** in the text)
 - 3** Battery Charger
(Indicated as **charger** in the text)
 - 4** USB Connection Cable
 - 5** AV Cable
 - 6** CD-ROM
 - 7** Strap
 - 8** Battery Carrying Case
- SD Memory Card, SDHC Memory Card and MultiMediaCard are indicated as **card** in the text.
 - For information about optional accessories, refer to the "Digital Camera Accessory System". (P118)
 - If any accessories are lost, customers in the USA should contact Panasonic's parts department at 1 800 833-9626 and customers in Canada should contact 1 800 561-5505 for further information about obtaining replacement parts.

Names of the Components

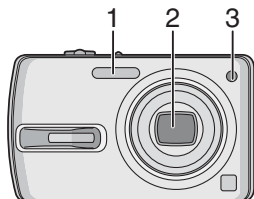

- 1 Flash (P39)
- 2 Lens (P4)
- 3 Self-timer indicator (P43)
AF assist lamp (P78)

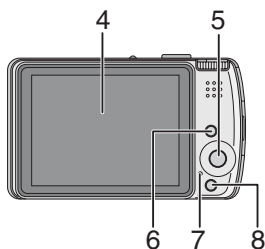

- 4 LCD monitor (P35, 100)
- 5 Joystick
 - ◻/ [MENU/SET] button (P18)
 - ◀/ Self-timer button (P43)
 - ▼/ [REV] button (P31)
 - ▶/ Flash setting button (P39)
 - ▲/ Exposure compensation (P44)/
Auto bracket (P45)/White balance fine
adjustment (P72)/Backlight
compensation in simple mode (P27)
button
- 6 [DISPLAY/LCD MODE] button
(P35, 38)
- 7 Status indicator (P13)
- 8 Single or burst mode (P47)/
Delete button (P33)

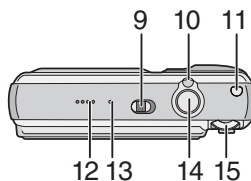

- 9 Camera ON/OFF switch (P11, 17)
- 10 Zoom lever (P28)
- 11 Optical image stabilizer button (P46)
- 12 Speaker (P67)
- 13 Microphone (P62, 76, 88)
- 14 Shutter button (P23, 62)
- 15 Mode dial (P6)

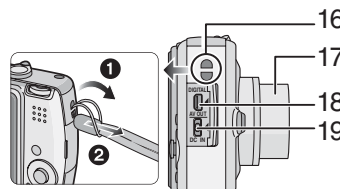

- 16 Strap eyelet
 - 17 Lens barrel
 - 18 [DIGITAL/AV OUT] socket (P92, 95, 99)
 - 19 [DC IN] socket (P92, 95)
- Always use a genuine Panasonic AC adaptor (DMW-AC5; optional).
 - This camera cannot charge the battery even though the AC adaptor (DMW-AC5; optional) is connected to it.

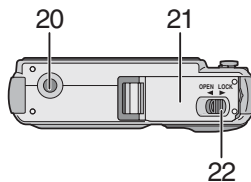

- 20 Tripod receptacle
 - When you use a tripod, make sure the tripod is stable when the camera is attached to it.
- 21 Card/Battery door (P14, 15)
- 22 Release lever (P14, 15)

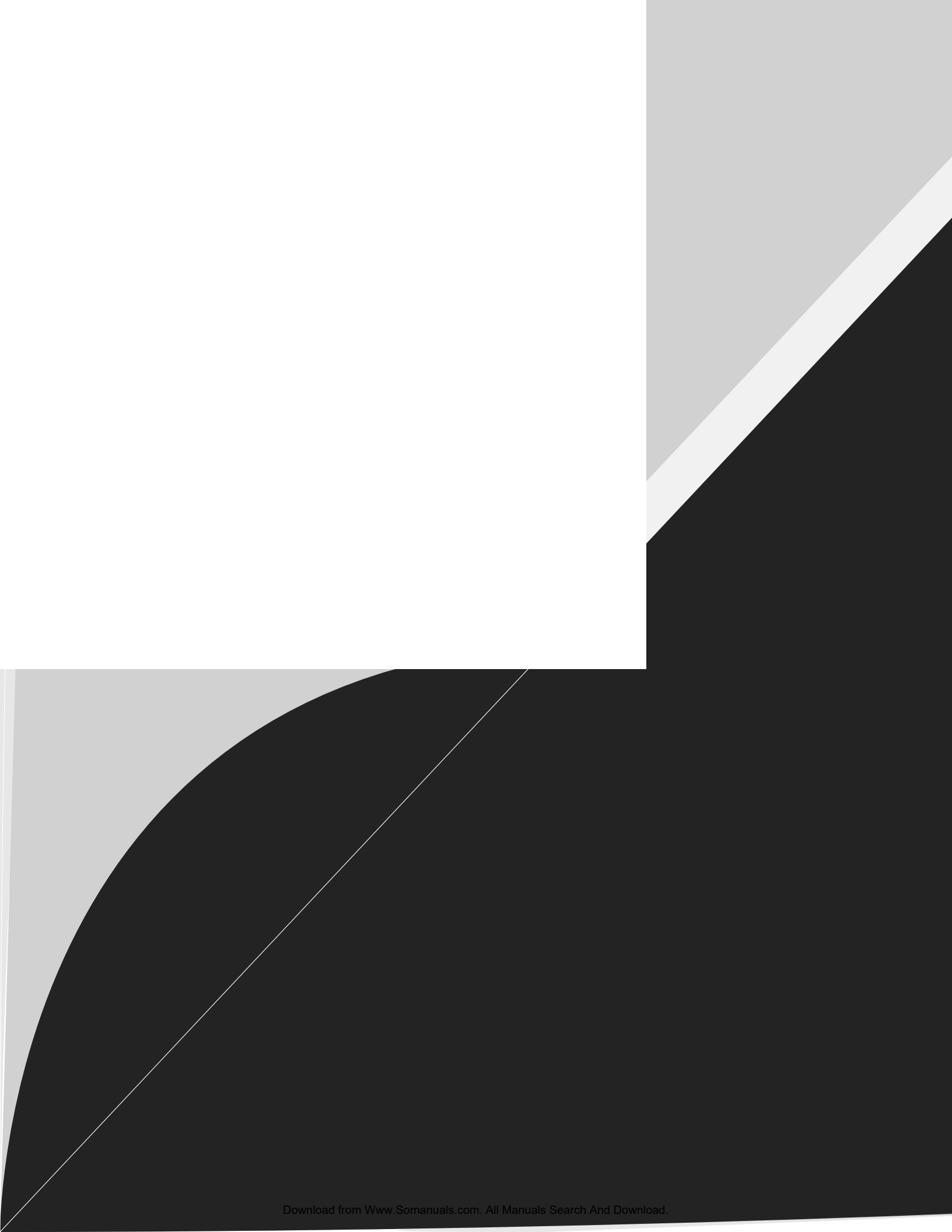

Charging the Battery with the Charger

The battery is not charged when the camera is shipped. Charge the battery before use.

1 Attach the battery with attention to the direction of the battery.

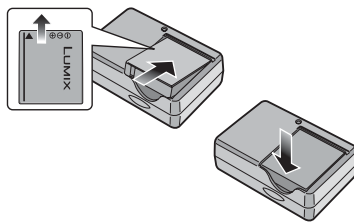

2 Connect the charger to the electrical outlet.

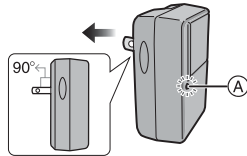

- Charging starts when the [CHARGE] indicator (A) lights green.
- Charging is complete when the [CHARGE] indicator (A) turns off (after about 130 minutes).

3 Detach the battery after charging is completed.

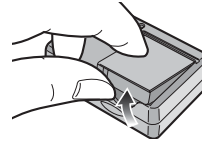

- After charging is completed, be sure to disconnect the charger from the electrical outlet.
- The battery becomes warm after using it and during and after charging. The camera also becomes warm during use. This is not a malfunction.
- The battery will be exhausted if left for a long period of time after being charged. Recharge the battery when it is exhausted.
- The battery can be charged even if it is not fully discharged.
- **Use the dedicated charger and battery.**
- **Charge the battery with the charger indoors.**
- **Do not disassemble or modify the charger.**

About the Battery

(charging/number of recordable pictures)

■ Battery indication

The remaining battery power appears on the screen. [It does not appear when you use the camera with the AC adaptor (DMW-AC5; optional) connected.]



- The battery indication turns red and blinks. (The status indicator blinks when the LCD monitor turns off.) Recharge the battery or replace it with fully charged battery.

■ The battery life

The number of recordable pictures (By CIPA standard in normal picture mode)

| | |
|-------------------------------|---|
| Number of recordable pictures | Approx. 300 pictures (Approx. 150 min) |
|-------------------------------|---|

Recording conditions by CIPA standard

- Temperature: 23 °C (73.4 °F)/
Humidity: 50% when LCD monitor is on.*
- Using a Panasonic SD Memory Card (16 MB). (supplied)
- Using the supplied battery.
- Starting recording 30 seconds after the camera is turned on. (When the optical image stabilizer function is set to [MODE1].)
- **Recording once every 30 seconds** with full flash every second recording.
- Rotating the zoom lever from Tele to Wide or vice versa in every recording.
- Turn the camera off every 10 recordings.
- CIPA is an abbreviation of [Camera & Imaging Products Association].

*The number of recordable pictures decreases when the power LCD function or high angle mode (P38) are used.

The number of recordable pictures varies depending on the recording interval time.
If the recording interval time becomes longer, the number of recordable pictures decreases.
[e.g. When recording once every 2 minutes, the number of recordable pictures decreases to about 75.]

Playback time

| | |
|---------------|-----------------|
| Playback time | Approx. 310 min |
|---------------|-----------------|

The number of recordable pictures and playback time will vary depending on the operating conditions and storing condition of the battery.

■ Charging

| | |
|---------------|-----------------|
| Charging time | Approx. 130 min |
|---------------|-----------------|

Charging time and number of recordable pictures with the optional battery pack (CGA-S005A) are the same as above.

- The [CHARGE] indicator lights when charging starts.

■ When the [CHARGE] indicator flashes

- The battery is over discharged (discharged excessively). In a while, [CHARGE] indicator will light up and normal charging will start.
- When the battery temperature is excessively high or low, [CHARGE] indicator flashes and the charging time will be longer than normal.
- The terminals of the charger or the battery are dirty. In this case, wipe them with a dry cloth.
- When the operating time of the camera becomes extremely short even after properly charging the battery, the life of the battery may have expired. Buy a new battery.

■ Charging conditions

- Charge the battery in a temperature between 10 °C to 35 °C (50 °F to 95 °F). (The battery temperature should also be the same.)
- The performance of the battery may temporarily deteriorate and the operating time may become shorter in low temperature conditions (e.g. skiing/snowboarding).

Inserting/Removing the Battery

- Check that the camera is turned off and that the lens is retracted.

1 Slide the release lever in the direction of the arrow and open the card/battery door.

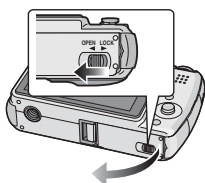

- Always use genuine Panasonic batteries (CGA-S005A).

2 Insert:
Insert the charged battery fully being careful about the direction you insert it.

Remove:
Slide the lock (A) to remove the battery.

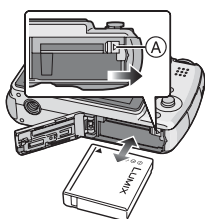

3 ① Close the card/battery door.
② Slide the release lever in the direction of the arrow.

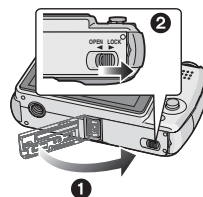

- Remove the battery after use. Store the removed battery in the battery carrying case (supplied).
- When a fully charged battery has been inserted for more than 24 hours, the clock setting is stored (in the camera) for at least 3 months even if the battery is removed. (If you insert a battery that is not sufficiently charged, the length of time that the clock setting is stored may become less.) However, the clock setting is canceled after this length of time. In this case, set the clock again. (P17)
- Do not remove the card or the battery while the card is being accessed. The data may be damaged. (P16)
- Do not remove the battery until the LCD monitor and the status indicator (green) turn off as the settings on the camera may not be stored properly.
- The supplied battery is designed only for the camera. Do not use it with any other equipment.

About the Card

■ Access to the card

The card access indication (A) lights red when pictures are being recorded onto the card.

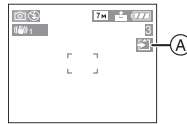

When the card access indication lights, pictures are being read or deleted or the card is being formatted. Do not:

- Turn the camera off.
- Remove the battery or the card.
- Shake or impact the camera.
- Disconnect the AC adaptor (DMW-AC5; optional).

The card and the data may be damaged or the camera may not operate normally.

■ About handling a card

Transfer important pictures/motion pictures from your card to your PC periodically (P92). The data on the card may be damaged or lost due to electromagnetic waves, static electricity, the camera breaking down or a defective card.

- Do not format the card on your PC or other equipment. Format it on the camera only to ensure proper operation. (P91)
- The reading/writing speed of an SD Memory Card and an SDHC Memory Card is fast. Both types of card are equipped with a Write-Protect switch (B) that can inhibit writing and formatting a card. (When the switch is slid to the [LOCK] side, it is not possible to write or delete data on the card and format it. When the switch is unlocked, these functions become available.)



Please confirm the latest information on the following website.

<http://panasonic.co.jp/pavc/global/cs>

(This Site is English only.)

- Refer to P112 for information about the number of recordable pictures and the available recording time for each card.
- This camera is compatible with SD Memory Cards based on SD Memory Card Specifications and formatted in FAT12 system and FAT16 system. It is also compatible with SDHC Memory Cards based on SD Memory Card Specifications and formatted in FAT32 system.
- The SDHC Memory Card is a memory card standard decided by the SD Association in 2006 for high capacity memory cards more than 2 GB.
- This camera is compatible with both an SD Memory Card and an SDHC Memory Card. You can use an SDHC Memory Card in equipment that is compatible with SDHC Memory Cards however you cannot use an SDHC Memory Card in equipment that is only compatible with SD Memory Cards. (If you use an SDHC Memory Card in other equipment, always read the operating instructions for the other equipment.)
- This unit does not support recording motion pictures on MultiMediaCards. We recommend using High Speed SD Memory Cards/SDHC Memory Cards when recording motion pictures. (P62)



- The SD Memory Card, SDHC Memory Card and MultiMediaCard are small, lightweight, removable external cards.
- The reading/writing speed of a MultiMediaCard is slower than an SD Memory Card or SDHC Memory Card. When a MultiMediaCard is used, the performance of certain features may be slightly slower than advertised.
- Keep the Memory Card out of reach of children to prevent swallowing.

Setting Date/Time (Clock Set)

■ Initial setting

The clock is not set so the following screen appears when you turn the camera on.

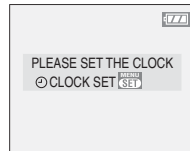
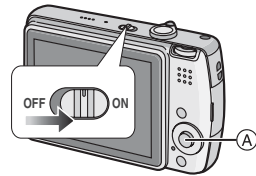

Ⓐ: [MENU/SET] button

1 Press [MENU/SET].

2 Move ▲/▼/◀/▶ to select the date and time.

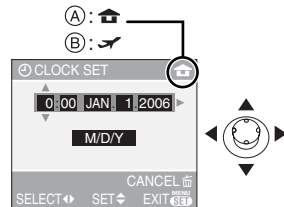

Ⓐ: Time at the home area

Ⓑ: Time at the travel destination (P59)

• ◀/▶: Select the desired item.

• ▲/▼: Set the display order for the date and time.

• Press [] to cancel the clock setting without storing the date and time.

• Refer to [WORLD TIME] (P59) for information about setting the local time at the travel destination area.

3 Press [MENU/SET] several times to close the menu.

- Turn the camera off after finishing setting the clock. Then turn it on and check that the clock setting is correct.

■ Changing the clock setting

1 Press [MENU/SET].

2 Move ▲/▼ to select [CLOCK SET].
(P70)

3 Move ▶ and then perform steps 2 and 3 to set the clock.

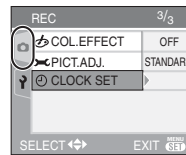

- You can also set the clock in the [SETUP] menu. (P18)



• When a fully charged battery has been inserted for more than 24 hours, the clock setting is stored (in the camera) for at least 3 months even if the battery is removed.

• You can set the year from 2000 to 2099. The 24-hour system is used.

• If the date is not set in the camera it will not be printed when you use a photo printing service, even if the store provides a date printing option for your photographs. (P86)

About the Setup Menu

- Set items as required. (Refer to P19 to 22 for each menu item.)
- Menu items differ depending on the mode selected with the mode dial (P6). The following example shows how to set [AUTO REVIEW] when normal picture mode [] is selected.
- Select [RESET] to return the settings to the initial settings at the time of purchase. (P21)

1 Press [MENU/SET] and then move ◀.

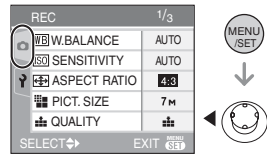

2 Move ▼ to select the [SETUP] menu icon [] and then move ▶.

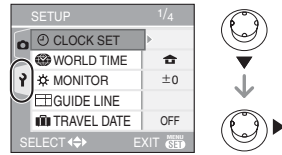

3 Move ▲/▼ to select the menu item.

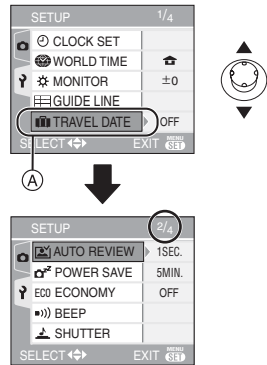

- Move ▼ at (A) to switch to the next menu screen.

18
VQT0Y19

4 Move ▶, move ▲/▼ to select the setting and then press [MENU/SET].

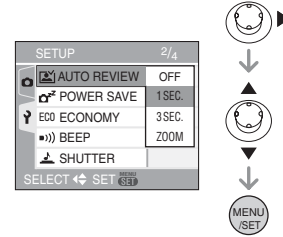

5 Press [MENU/SET] to close the menu.

- You can also press the shutter button halfway to close the menu.

■ About the menu screen items

- There are 4 menu screens (1/4, 2/4, 3/4 and 4/4).
- You can switch menu screens from any menu item by rotating the zoom lever.

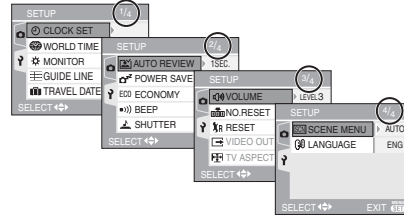



 **[CLOCK SET]**

Press [] to display the [SETUP] menu and select the item to set. (P18)
Change date and time. (P17)

 **[WORLD TIME]**

Press [] to display the [SETUP] menu and select the item to set. (P18)

[]: The time at your home area is set.

[]: The local time at the travel destination area is set.

- Refer to P59 for information about setting [WORLD TIME].
- The [WORLD TIME] setting also affects simple mode [].

 **[MONITOR]**

Press [] to display the [SETUP] menu and select the item to set. (P18)
Adjust the brightness of the LCD monitor in 7 steps.

- The [MONITOR] setting also affects simple mode [].

 **[GUIDE LINE]**



Press [] to display the [SETUP] menu and select the item to set. (P18)

Set the pattern of the guide lines displayed when taking pictures. (P36)

You can also set whether or not to have the recording information and histogram displayed when the guide lines are displayed.

[REC. INFO.]: [ON]/[OFF]

[HISTGRAM]: [ON]/[OFF]

[PATTERN]: []/[]

 **[TRAVEL DATE]**

Press [] to display the [SETUP] menu and select the item to set. (P18)

[SET]: When taking a picture, the date on which it was taken is recorded.

[OFF]: When taking a picture, the date on which it was taken is not recorded.

- Refer to P57 for information about setting [TRAVEL DATE].
- The [TRAVEL DATE] setting also affects simple mode [].

 **[AUTO REVIEW]**



Press [] to display the [SETUP] menu and select the item to set. (P18)

[1SEC.]: The recorded picture automatically appears on the screen for about 1 second.

[3SEC.]: The recorded picture automatically appears on the screen for about 3 seconds.

[ZOOM]: The recorded picture automatically appears on the screen for about 1 second. It is then enlarged 4 times and appears for about 1 second. This mode is useful for confirming focus. Pictures recorded using auto bracket or burst mode and pictures with audio are not enlarged even if [ZOOM] is selected.

[OFF]: The recorded picture does not automatically appear.

- The auto review function is not activated in motion picture mode [].
- When pictures are recorded in auto bracket (P45) or burst mode (P47), the auto review function is activated regardless of the setting on the auto review function. (The picture is not enlarged.)
- The auto review function is activated while pictures with audio (P76) are being recorded regardless of its setting. (The picture is not enlarged.)
- The auto review setting is disabled when using auto bracket or burst mode, in motion picture mode [] or when [AUDIO REC.] or [SELF PORTRAIT] in scene mode is set to [ON].

 **[POWER SAVE]**

Press [] to display the [SETUP] menu and select the item to set. (P18)

[1MIN.]/[2MIN.]/[5MIN.]/[10MIN.]:

Power save mode is activated (the camera is automatically turned off to save the battery life) if the camera has not been used for the time selected on the setting.

[OFF]: Power save mode is not activated.

- Press the shutter button halfway or turn the camera off and on to cancel power save mode.
- Power save mode is fixed to [5MIN.] in simple mode [].
- Power save mode is fixed to [2MIN.] in economy mode.
- When using the AC adaptor (DMW-AC5; optional), connecting to a PC or a printer, recording or playing back motion pictures and during a slide show, power save mode is not activated. (However, the setting for power save mode is fixed to [10MIN.] while pausing a slide show or playing back a manual slide show.)

ECO [ECONOMY]

Press [] to display the [SETUP] menu and select the item to set. (P18)

Battery life is saved by reducing the brightness of the LCD monitor and turning it off automatically when the camera is not being used in recording mode.

[LEVEL 1]: The LCD monitor turns off if the camera is not operated for about 15 seconds in recording mode.

[LEVEL 2]: The LCD monitor turns off if the camera is not operated for about 15 seconds in recording mode or for about 5 seconds after taking a picture.

[OFF]: Economy mode cannot be activated.

- In economy mode, the LCD monitor is turned off while the flash is being charged.
- The status indicator lights while the LCD monitor is turned off. Press any button to turn on the LCD monitor again.
- Power save mode is fixed to [2MIN.] in economy mode.
[However, power save mode is not activated when using the AC adaptor (DMW-AC5; optional).]
- Economy mode will not work in simple mode [], when using the AC adaptor (DMW-AC5; optional), recording motion pictures, the menu screen is displayed or the self-timer is set.
- The brightness of the LCD monitor is not reduced in Power LCD mode and high angle mode.

■))) [BEEP]

Press [MENU] to display the [SETUP] menu and select the item to set. (P18)

■))) [BEEP LEVEL]

[OFF]: No operation sound

[L]: Soft operation sound

[H]: Loud operation sound

⏏ [BEEP TONE]: ① / ② / ③

- The [BEEP] setting also affects simple mode [♥].

📷 [SHUTTER]

Press [MENU] to display the [SETUP] menu and select the item to set. (P18)

Set to select the volume of shutter sound.

📷 [SHUTTER VOL.]

[OFF]: No shutter sound

[L]: Soft shutter sound

[H]: Loud shutter sound

⏏ [SHUTTER TONE]: ① / ② / ③

- The [SHUTTER] setting also affects simple mode [♥].

🔊 [VOLUME]

Press [MENU] to display the [SETUP] menu and select the item to set. (P18)

The volume of speakers can be adjusted in 7 steps from level 6 to 0.

- When you connect the camera to a TV, the volume of the TV speakers does not change.

📷 [NO.RESET]

Press [MENU] to display the [SETUP] menu and select the item to set. (P18)

Set this when you want the file number of the next recording to start from 0001. (The folder number is updated and the file number starts from 0001.)

- A folder number between 100 and 999 can be assigned. When the folder number reaches 999, the number cannot be reset. We recommend formatting the card after saving the data on a PC or elsewhere.
- To reset the folder number to 100, format (P91) the card first and then use this function to reset the file number. A reset screen for the folder number will then appear. Select [YES] to reset the folder number.
- Refer to P93 for detailed information about the file number and the folder number.
- The [NO.RESET] setting also affects simple mode [♥].

📷 [RESET]

Press [MENU] to display the [SETUP] menu and select the item to set. (P18)

The [REC] or [SETUP] menu settings are reset to the initial settings.

- The birthday setting for [BABY1]/[BABY2] (P56) in scene mode, the number of days that have passed since the departure date for [TRAVEL DATE] (P57) and the [WORLD TIME] setting (P59) are also reset when the [SETUP] menu settings are reset. Also, [FAVORITE] (P82) is fixed to [OFF] and [ROTATE DISP.] (P83) is fixed to [ON].
- The folder number and the clock setting are not changed.

 **[VIDEO OUT]**

(Playback mode only) (P99)

Press  to display the [SETUP] menu and select the item to set. (P18)

[NTSC]: Video output is set to NTSC system.

[PAL]: Video output is set to PAL system.

 **[TV ASPECT]**

(Playback mode only)

Press  to display the [SETUP] menu and select the item to set. (P18)

[16:9]:

Select this if connecting the camera to a 16:9 screen TV.

[4:3]:

Select this if connecting the camera to a 4:3 screen TV.

- This is suitable for displaying pictures recorded with a **[16:9]** aspect on the full screen of a 16:9 TV. Pictures recorded with a **[4:3]** or **[3:2]** aspect are displayed with black bands on the left and right of the screen.
- When **[4:3]** is selected, pictures recorded with a **[16:9]** or **[3:2]** aspect are displayed with black bands on the top and bottom of the screen.
- When you select **[16:9]** and use the AV cable (supplied) for output (P99), pictures are displayed vertically on the LCD monitor.

 **[SCENE MENU]**

Press  to display the [SETUP] menu and select the item to set. (P18)

[AUTO]: [SCENE MODE] menu appears automatically when setting the mode dial to scene mode. Select the desired scene mode. (P49)

[OFF]: [SCENE MODE] menu does not appear when setting the mode dial to scene mode and the camera is operated in scene mode currently selected. If you change the scene mode, press [MENU/SET] to display the [SCENE MODE] menu and then select the desired scene mode.

 **[LANGUAGE]**

Press  to display the [SETUP] menu and select the item to set. (P18)

Set the language on the menu screen from the following languages. Set to the desired language with ▲/▼ and store it with [MENU/SET].

[ENGLISH]: English

[DEUTSCH]: German

[FRANÇAIS]: French

[ESPAÑOL]: Spanish

[ITALIANO]: Italian

[中文]: Chinese (Traditional)

[日本語]: Japanese

- If you set a different language by mistake, select  from the menu icons to set the desired language.

- The [LANGUAGE] setting also affects simple mode .

Taking Pictures



The camera automatically sets the shutter speed and the aperture value according to the brightness of the subject.

- 1 ① Turn the camera on.
- 2 ② Select normal picture mode [].

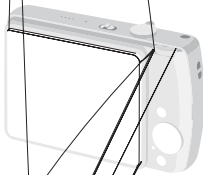

- 2 Aim the AF area ① to the point you want to focus on and then press the shutter button halfway.

- ②: Press the shutter button halfway to focus.
- The focus indication ② lights and then the aperture value ③ and the shutter speed ④ are displayed.
- When the ISO sensitivity is set to [], the shutter speed will not be displayed. (P73)
- If [] or [] is used in AF mode, the AF area does not appear until the subject is brought into focus. (P77)

- The AF area displayed is bigger than usual when using the digital zoom or when taking pictures in dark places. (P77)

3 Take a picture.

- ③: Press the shutter button fully to take the picture.



- We recommend checking that the clock is set properly before taking pictures. (P17)
- When you press the shutter button, the screen may become bright or dark for a moment. This function allows easy adjustment of focus and the recorded picture will not be affected.
- When a time is set for power save (P20), the camera automatically turns off if you do not operate it within the set time. To operate the camera again, press the shutter button halfway or turn the camera off and on.
- To avoid noise, we recommend decreasing the ISO sensitivity (P73) or setting [PICT.ADJ.] to [NATURAL]. (P79) (ISO sensitivity is set to [AUTO] when the camera is shipped. Therefore, when taking pictures indoors etc. the ISO sensitivity increases.)

■ **Tips for taking good pictures**

- Hold the camera gently with both hands, keep your arms still at your side and stand with your feet slightly apart.
- Make sure the camera does not shake when you press the shutter button.
- Do not cover the flash or the AF assist lamp with your fingers or other objects.
- Do not touch the front of the lens.
- If the LCD monitor screen is difficult to see because of light from the sun etc. shining on it, we recommend using your hand or another object to block the light when using the camera.

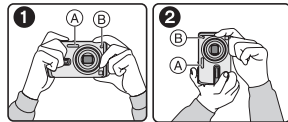

- ❶: When holding the camera sideways
- ❷: When holding the camera vertically
- Ⓐ: Flash
- Ⓑ: AF assist lamp

■ **Direction detection function**

Pictures recorded with the camera held vertically are played back vertically (rotated). (Only when [ROTATE DISP.] (P83) is set to [ON])

- Pictures may not be displayed vertically if they were taken with the camera aimed up or down.
- Motion pictures taken with the camera held vertically are not displayed vertically.

■ **When you want to take a subject outside the AF area (AF/AE Lock)**

When recording a picture of people with a composition like the following picture, you will not be able to focus the camera on the subject because the people are outside the AF area.

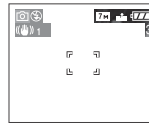

In this case,

- 1 Aim the AF area at the subject.
 - 2 Press the shutter button halfway to fix the focus and the exposure.
 - The focus indication lights when the subject is focused.
 - 3 Press and hold the shutter button halfway while moving the camera as you compose the picture.
 - 4 Press the shutter button fully.
- You can repeatedly retry AF/AE lock before pressing the shutter button fully.

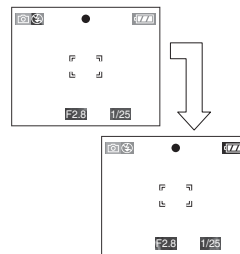

■ Focusing

- **The focus range is 50 cm (1.64 feet) to ∞. Use macro mode when recording close-up pictures. (P48)**

- If the distance between the camera and the subject is beyond the focus range of the camera, the picture may not be properly focused even if the focus indication lights.
- In the following cases, the camera will not focus on subjects properly.
 - When there are both near and distant subjects in a scene.
 - When there is dirt or dust on glass between the lens and the subject.
 - When there are illuminated or glittering objects around the subject.
 - When taking a picture in dark places.
 - When the subject is moving fast.
 - When the scene has low contrast.
 - When jitter occurs.
 - When recording a very bright subject.

We recommend taking pictures using AF/AE lock. In dark places, the AF assist lamp (P78) may turn on to focus on the subject.

- Even when the focus indication appears and the subject is focused, it is canceled if you release the shutter button. Press the shutter button halfway again.

■ Preventing jitter (camera shake)

- Be careful of jittering when pressing the shutter button.
- If jitter could occur because of slow shutter speed, the jitter alert  appears.

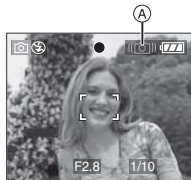

- When the jitter alert appears, we recommend using a tripod. If you cannot use a tripod, be careful how you hold the camera (P24). The use of the self-timer prevents jittering caused by pressing the shutter button when you are using a tripod (P43).
- Shutter speed will be slower particularly in the following cases. Keep the camera still from the moment the shutter button is pressed until the picture appears on the screen. We recommend using a tripod.
 - Slow sync./Red-eye reduction (P39)
 - [NIGHT PORTRAIT] (P51)
 - [NIGHT SCENERY] (P51)
 - [PARTY] (P52)
 - [CANDLE LIGHT] (P53)
 - [FIREWORKS] (P53)
 - [STARRY SKY] (P54)
 - When the shutter speed is slowed in [SLOW SHUTTER] (P78)

■ Exposure

- If you press the shutter button halfway when the exposure is not adequate, the aperture value and the shutter speed turn red. (They do not turn red when the flash is activated.)
- The brightness of the screen may differ from the brightness of the recorded pictures especially when recording in low light conditions.
- When most of the subjects on the screen are bright (e.g. a blue sky on a clear day, a snowy field etc.), the recorded pictures may become dark. In this case, compensate the exposure value on the camera. (P44)

Taking Pictures in Simple Mode



This mode allows beginners to take pictures easily. Only the basic functions appear in the menu to make operations simple.

Basic menu settings

1 Press [MENU/SET].

2 Move ▲/▼ to select the desired menu item and then move ►.

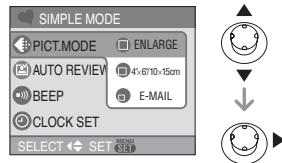

3 Move ▲/▼ to select the desired setting and then press [MENU/SET].

4 Press [MENU/SET] to close the menu.

- You can also press the shutter button halfway to close the menu.

Settings in Simple mode

[PICT.MODE]

| | |
|-----------------|--|
| [ENLARGE] | Suitable for enlarging the pictures to be printed to 8"×10" size, letter size etc. |
| [4"×6"/10×15cm] | Suitable for regular size printing. |
| [E-MAIL] | Suitable for attaching pictures to e-mails or adding pictures to websites. |

[AUTO REVIEW]

| | |
|-------|--|
| [OFF] | The recorded picture does not automatically appear. |
| [ON] | The recorded picture automatically appears on the screen for about 1 second. |

[BEEP]

| | |
|--------|----------------------|
| [OFF] | No operation sound |
| [LOW] | Soft operation sound |
| [HIGH] | Loud operation sound |

[CLOCK SET]

Change date and time. (P17)

- If [4"×6"/10×15cm] or [E-MAIL] is set in [PICT.MODE], the extended optical zoom is activated and the zoom ratio is extended to a maximum of 5.5×. (P29)
- The settings for [BEEP] and [CLOCK SET] in simple mode are also applied to other recording modes.
- The settings for [WORLD TIME] (P19), [MONITOR] (P19), [TRAVEL DATE] (P19), [BEEP] (P21), [SHUTTER] (P21), [NO.RESET] (P21) and [LANGUAGE] (P22) in the [SETUP] menu are applied to simple mode.

■ Other Settings in Simple mode

In simple mode, other settings are fixed as follows. For more information about each setting, refer to the page indicated.

- Focus range:
 - 30 cm (0.98 feet) to ∞ (Tele)
 - 5 cm (0.16 feet) to ∞ (Wide)
- [POWER SAVE] (P20): [5MIN.]
- [ECONOMY] (P20): [OFF]
- Self-timer (P43): 10 seconds
- Optical Image Stabilizer (P46): [MODE2]
- Burst speed (P47): []
- [W.BALANCE] (P71): [AUTO]
- [SENSITIVITY] (P73): [] | s0
- [ASPECT RATIO]/[PICT.SIZE]/[QUALITY] (P74, 75):
 - [] ENLARGE]:
 - 4:3 : [7M] (7M)/ []
 - [] 4"×6"/10×15cm]:
 - 3:2 : [25M] (2.5M EZ)/ []
 - [] E-MAIL]:
 - 4:3 : [0.3M] (0.3M EZ)/ []
- [AF MODE] (P77): []
- [AF ASSIST LAMP] (P78): [ON]
- [SLOW SHUTTER] (P78): [1/8–]

- You cannot use the following functions in simple mode.

- High angle mode
- White balance fine adjustment
- Exposure compensation
- Auto bracket
- [AUDIO REC.]
- [D.ZOOM]
- [COL.EFFECT]
- [PICT.ADJ.]
- [GUIDE LINE]

- You cannot set the following items in simple mode.

- [TRAVEL DATE]
- [WORLD TIME]

■ The Backlight Compensation

Backlight refers to when light comes from the back of a subject.

In this case, the subject, such as a person, will become dark.

If you move ▲, compensating backlight ON indication [] appears and the backlight compensation function is activated. This function compensates the backlight by brightening the whole of the picture.

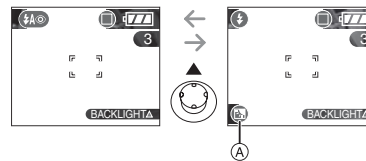

- If you move ▲ while [] is displayed, [] disappears and the backlight compensation function is canceled.
- We recommend using the flash when you use the backlight compensation function. (When using the flash, it is fixed to Forced ON [].)
- The flash setting is fixed to AUTO/Red-eye reduction [] when the backlight compensation function is set to [OFF].

...ion, the
...rings
...alled
...may be more
...istant subjects.
...unction after focusing
...us on the subject again.
...oom magnification is an
...n.
...arrel (P10) extends or retracts
...ng to the zoom position. Take care
... interrupt the motion of the lens
...arrel while the zoom lever is rotated.
In motion picture mode [...], the zoom
magnification is fixed to the value set at
the start of recording.

...rther away

...ver towards

...g for picture size is

Using the Extended Optical Zoom (EZ)



This camera has a 3.6× optical zoom. However, if the picture size is not set to the highest setting for each aspect ratio [4:3 / 3:2 / 16:9], a maximum of 5.5× optical zoom can be achieved with no picture quality deterioration.

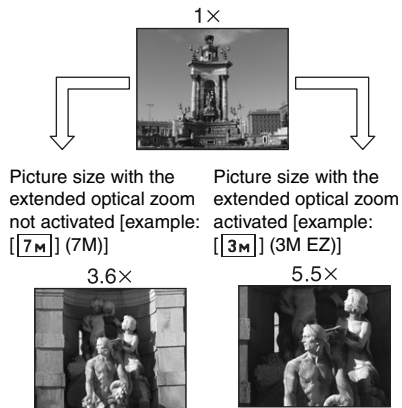

Extended optical zoom mechanism

When you set the picture size to [3M] (3M EZ) (3 million pixels), the 7M (7 million pixels) CCD area is cropped to the center 3M (3 million pixels) area, allowing a picture with a higher zoom effect.

Picture size and maximum zoom magnification

(○: Available, —: Not available)

| Aspect ratio | Picture size | Maximum zoom magnification | Extended optical zoom |
|--------------|--------------------|----------------------------|-----------------------|
| 4:3 | [7M] / (7M) | 3.6× | — |
| 3:2 | [6M] (6M) | | |
| 16:9 | [5.5M] (5.5M) | | |
| 4:3 | [5M] (5M EZ) | 4.4× | ○ |
| 4:3 | [3M] (3M EZ) | 5.5× | ○ |
| | [2M] (2M EZ) | | |
| | [1M] (1M EZ) | | |
| | [0.3M] / (0.3M EZ) | | |
| 3:2 | [2.5M] / (2.5M EZ) | | |
| 16:9 | [2M] (2M EZ) | | |



- Refer to P74 for aspect ratio settings, P75 for picture size and P26 for simple mode [♥].
- “EZ” is an abbreviation of “Extended optical Zoom”.
- You can further enhance the zoom magnification with the extended optical zoom without worrying about further picture distortion.
- If you set a picture size that activates the extended optical zoom, the extended optical zoom icon [EZ] is displayed on the screen when you use the zoom function.
- The zoom will stop moving for an instant near [W] (1×) when the extended optical zoom is used. This is not a malfunction.
- The indicated zoom magnification is an approximation.
- In motion picture mode [H] and [HIGH SENS.] in scene mode, the extended optical zoom does not work.

Using the Digital Zoom Further extending the zoom



A maximum of 14.6× zoom can be achieved with the 3.6× optical zoom and the 4× digital zoom when [D.ZOOM] is set to [ON] in the [REC] mode menu. However, if a picture size that can use extended optical zoom is selected, a maximum of 21.9× zoom can be achieved with the 5.5× extended optical zoom and the 4× digital zoom.

Menu operation

1 Press [MENU/SET].

- When a scene mode is selected, move ◀ in the [SCENE MODE] menu (P49), move ▼ to select the [REC] mode menu icon [CAM] and then move ▶.

2 Move ▲/▼ to select [D.ZOOM] and then move ▶.

3 Move ▼ to select [ON] and then press [MENU/SET].

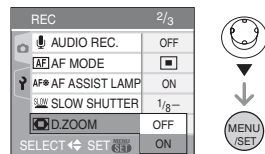

4 Press [MENU/SET] to close the menu.

- You can also press the shutter button halfway to close the menu.

Entering the digital zoom range

The on-screen zoom indication may momentarily stop moving when you rotate the zoom lever to the extreme Tele position. You can enter the digital zoom range by continuously rotating the zoom lever to Tele or releasing the zoom lever once and then rotating it to Tele again.

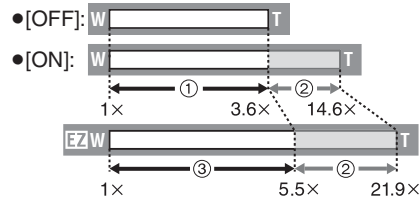

(When using the digital zoom [4×] and the extended optical zoom (3M EZ) at the same time.)

- ① Optical zoom
- ② Digital zoom
- ③ Extended optical zoom



- When using the digital zoom, the AF area on the center of the screen is displayed and it is bigger than usual. (P77)
- In digital zoom, the larger the picture the lower the picture quality.
- In the digital zoom range, the stabilizer function may not be effective.
- When using the digital zoom, we recommend using a tripod and the self-timer (P43) for taking pictures.
- The indicated zoom magnification is an approximation.
- The digital zoom does not work in the following cases:
 - In simple mode [♥].
 - In [SPORTS], [BABY1]/[BABY2] and [HIGH SENS.] in scene mode.
 - When the ISO sensitivity has been set to [ISO].

Checking the Recorded Picture (Review)



You can check the recorded pictures while still in [REC] mode.

1 Move ▼ [REV].



- The last recorded picture appears for about 10 seconds.
- Review is canceled when the shutter button is pressed halfway or the ▼ [REV] is moved again.
- You can check other pictures by moving ◀/▶.
- When the recorded pictures are too bright or too dim, compensate the exposure. (P44)

2 Rotate the zoom lever towards [Q] [T] to enlarge the picture.

- Rotate the zoom lever to [Q] [T] for a 4× magnification and then rotate it even more for a 8× magnification. When you rotate the zoom lever towards [Q] [W] after enlarging the picture, the magnification becomes lower.

3 Move ▲/▼/◀/▶ to move the position.

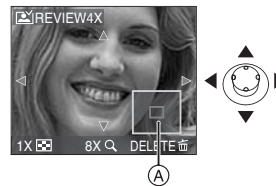

- When you change the magnification or the position to be displayed, the zoom position indication (A) appears for about 1 second so that you can check the enlarged area.

Deleting the recorded picture during Review (Quick deletion)

- 1 Press [].
- 2 Move ▲ to select [YES].
- 3 Press [MENU/SET].



- Once deleted, pictures cannot be recovered. Double-check pictures before deleting them.
- Multiple pictures or all the pictures can be deleted. For information about how to delete pictures, refer to P33.



- When [ROTATE DISP.] is set to [ON], pictures recorded holding the camera vertically are played back vertically (rotated).

Playing Back Pictures



Move ◀/▶ to select the picture.

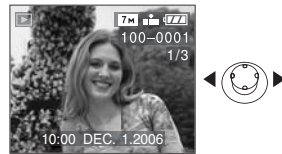

- ◀: Play back the previous picture
- ▶: Play back the next picture

- The first recorded picture will be displayed after the last recorded picture.
- When [ROTATE DISP.] (P83) is set to [ON], pictures recorded by holding the camera vertically are played back vertically.

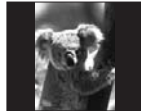

■ Fast forwarding/Fast rewinding

Move and hold ◀/▶ during playback.

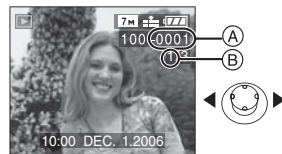

- ◀: Fast rewind
- ▶: Fast forward

- The file number (A) and the picture number (B) only change one by one. Release ◀/▶ when the number of the desired picture appears to play back the picture.

- If you move and hold ◀/▶, the number of files forwarded/rewound at one time increases. The actual number of files forwarded/rewound at one time depends on the number of files recorded.
- In review playback in recording mode and in multi playback (P64), the pictures can only be forwarded or rewound one by one.



- This camera is based on the DCF standard "Design rule for Camera File system" which was established by the "JEITA (Japan Electronics and Information Technology Industries Association)".
- The file format that can be played back on the camera is JPEG. (In some cases, even JPEG pictures cannot be played back.)
- The LCD monitor may not be able to display the details of the recorded pictures. You can use the playback zoom (P66) to check the details of the pictures.
- If you play back pictures that have been recorded with other equipment, the picture quality may deteriorate. (The pictures are displayed as [THUMBNAIL IS DISPLAYED] on the screen.)
- If you change a folder name or file name on your PC, the pictures may not play back on the camera.
- If you play back a non-standard file, the folder/file number is indicated by [—] and the screen may turn black.
- Depending on the subject, an interference fringe may appear on the screen. This is called moire. This is not a malfunction.

Deleting Pictures



■ To delete a single picture

1 Select the picture with ◀/▶.

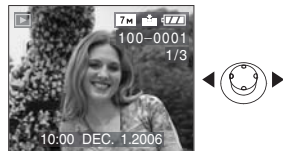

◀: Play back the previous picture

▶: Play back the next picture

2 Press [MENU/SET].

3 Move ▲ to select [YES] and then press [MENU/SET].



• While the picture is being deleted, [MENU/SET] appears on the screen.

■ To delete [MULTI DELETE]/
[ALL DELETE]

1 Press [MENU/SET] twice.

2 Move ▲/▼ to select
[MULTI DELETE] or
[ALL DELETE] and then press
[MENU/SET].

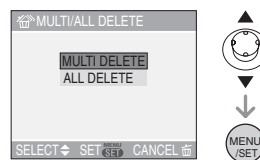

- If you select [MULTI DELETE], perform steps **3** onwards.
- If you select [ALL DELETE], perform steps **5** onwards.
- When [FAVORITE] (P82) is set to [ON], [ALL DELETE EXCEPT ★] appears. If you select [ALL DELETE EXCEPT ★], perform steps **5** onwards. (However, if none of the pictures have [★] displayed, you cannot select [ALL DELETE EXCEPT ★] even if [FAVORITE] is set to [ON].)

3 Move ◀/▶ to select the picture and then move ▼ to set.

(Only when selecting [MULTI DELETE])



- Repeat the above procedure.
- [] appears on the selected pictures. If ▼ is moved again, the setting is canceled.
- The icon [] blinks red if the selected picture is protected and cannot be deleted. Cancel the protect setting and then delete the picture. (P87)

4 Press [].

5 Move ▲ to select [YES] and then press [MENU/SET] to set.

(Screen when selecting [MULTI DELETE])



- [DELETE ALL PICTURES IN THE MEMORY CARD?] is displayed when using [ALL DELETE] and [DELETE ALL EXCEPT ★?] is displayed when using [ALL DELETE EXCEPT ★].
- If you press [MENU/SET] while deleting pictures using [ALL DELETE] or [ALL DELETE EXCEPT ★], the deleting will stop halfway.



- Once deleted, pictures cannot be recovered. Double-check pictures before deleting them.
- Do not turn off the camera while deleting.
- When deleting pictures, use a battery with sufficient battery power (P13) or the AC adaptor (DMW-AC5; optional).
- It is possible to delete up to 50 pictures at one time using [MULTI DELETE].
- The greater the number of pictures the longer it takes to delete them.
- If there are pictures that are protected [] (P87), do not conform to the DCF standard (P32) or are in a card with the Write-Protect switch slid to the [LOCK] side (P16), they are not deleted even if [ALL DELETE] or [ALL DELETE EXCEPT ★] is selected.

About the LCD Monitor

Changing the information displayed

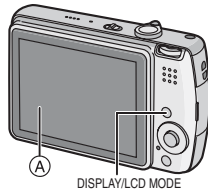

A LCD monitor (LCD)

Press [DISPLAY] to change.

- When the menu screen appears, the [DISPLAY] button is not activated. During playback zoom (P66), while playing back motion pictures (P67) and during a slide show (P81), you can only select "Normal display ①" or "No display ②".

In simple mode [♥]

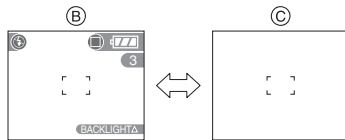

B Normal display
C No display

In recording mode

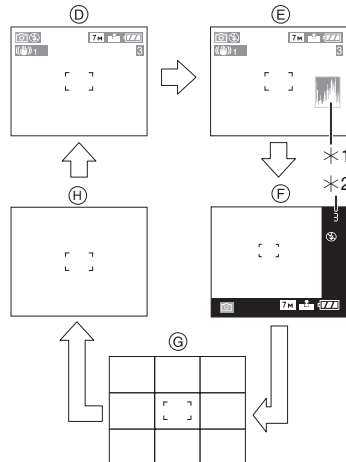

D Normal display
E Display with histogram
F Out-of-frame display
G No display (Recording guide line)^{*3}
H No display

*1 Histogram

*2 When the number of pictures remaining is more than 1000 or the time remaining in motion picture mode is more than 1000 seconds, [9999] is displayed.

*3 Set the pattern of the guide lines displayed by setting [GUIDE LINE] in [SETUP] menu. (P19) You can also set whether or not to have the recording information and histogram displayed when the guide lines are displayed.

In playback mode

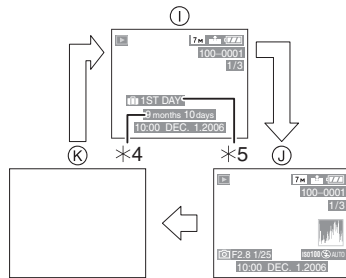

- ① Normal display
- J Display with recording information and histogram
- K No display
- *4 Displayed if [BIRTHDAY SET.] and [WITH AGE] were set in [BABY1]/[BABY2] (P56) in scene mode before taking pictures.
- *5 The number of days that have passed since the travel date are displayed if you set [TRAVEL DATE] (P57) before taking pictures.



- In [NIGHT PORTRAIT] (P51), [NIGHT SCENERY] (P51), [FIREWORKS] (P53) and [STARRY SKY] (P54) in scene mode, the guide line is gray.

Recording guide line

When you align the subject on the horizontal and vertical guide lines or the cross point of these lines, you can take pictures with well-designed composition by viewing the size, the slope and the balance of the subject.

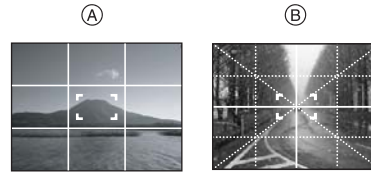

- A [3x3 grid]: This is used when dividing the entire screen into 3×3 for taking pictures with a well-balanced composition.
- B [Crosshair]: This is used when you want to position the subject at the exact center of the screen.

**Brightening the LCD Monitor
(Power LCD/High angle mode)**



• If the mode dial is set to [▶], the Power LCD function only can be used.

1 Press [LCD MODE] for 1 second.

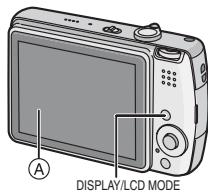

Ⓐ LCD monitor (LCD)

2 Move ▲/▼ to select a mode.

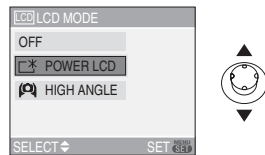

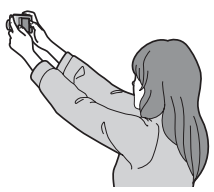
| | |
|-------------------------------------|---|
| <p>[☒*]: [POWER LCD]</p> | <p>The LCD monitor becomes brighter and easier to see even when taking pictures outdoors.</p> |
| <p>[☒]: [HIGH ANGLE]</p> | <p>The LCD monitor is easier to see when taking pictures with the camera held high above your head. This is useful when you cannot get close to the subject because there is a person in the way. (However it becomes more difficult to see when looked at straight on.)</p>  |
| <p>[OFF]</p> | <p>The LCD monitor returns to the normal brightness.</p> |

3 Press [MENU/SET].

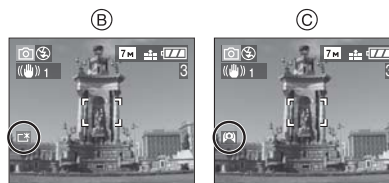

• The [POWER LCD] Ⓑ or [HIGH ANGLE] Ⓒ icon appears.

■ Canceling High angle mode or Power LCD

- If you press and hold [LCD MODE] again for 1 second the screen shown in step **2** is displayed. Select [OFF] to cancel Power LCD mode or High angle mode.



- High angle mode is also canceled if you turn the camera off or power save mode is activated.
- The brightness of the pictures displayed on the LCD monitor is adjusted when Power LCD mode or High angle mode is activated. Therefore, some subjects may look different on the LCD monitor. However, this does not affect the recorded pictures.
- The LCD monitor automatically returns to normal brightness after 30 seconds when recording in Power LCD mode. Press any button to make the LCD monitor bright again.
- You may not notice the High angle mode effect if the LCD monitor is difficult to see because of light from the sun etc. shining on it. In this case, we recommend using your hand or another object to block the light when using the camera.
- High angle mode is not activated in the following cases.
 - In simple mode [♥]
 - In playback mode
 - While the menu screen is displayed
 - While the review screen is displayed

Taking Pictures using the Built-in Flash

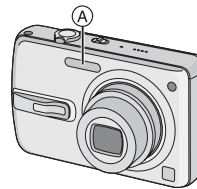

Ⓐ: Photo flash

Do not cover it with your fingers or other objects.

■ Switching to the appropriate flash setting

Set the flash to match the recording.

1 Move ► [⚡].

2 Move ▲/▼ to select a mode.

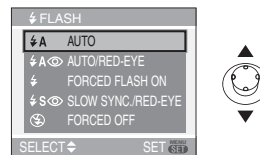

- You can also move ► [⚡] to select.
- For information about flash settings that can be selected, refer to “Available flash settings by recording mode”. (P40)

3 Press [MENU/SET].

- You can also press the shutter button halfway to finish.
- The menu screen disappears after about 5 seconds. At this time, the selected item is automatically set.

⚡A : **AUTO**

The flash is automatically activated when the recording conditions make it necessary.

⚡A👁 : **AUTO/Red-eye reduction** *1

The flash is automatically activated when the recording conditions make it necessary. It is activated once before the actual recording to reduce the red-eye phenomenon (eyes of the subject appearing red in the picture) and then activated again for the actual recording.

- Use this when you take pictures of people in low lighting conditions.

⚡ : **Forced ON**

The flash is activated every time regardless of the recording conditions.

- Use this when your subject is back-lit or under fluorescent light.

⚡👁 : **Forced ON/Red-eye reduction** *1

- The flash setting is set to **Forced ON/Red-eye reduction** only when you set [PARTY] (P52) or [CANDLE LIGHT] (P53) in scene mode.

⚡S👁 : **Slow sync./Red-eye reduction** *1

If you take a picture with a dark background landscape, this feature will slow the shutter speed when the flash is activated so that the dark background landscape will become bright. Simultaneously it reduces the red-eye phenomenon.

- Use this when you take pictures of people in front of a dark background.

🚫 : **Forced OFF**

The flash is not activated in any recording conditions.

- Use this when you take pictures in places where the use of the flash is not permitted.

*1 The flash is activated twice. The subject should not move until the second flash is activated.

■ **Available flash settings by recording mode**

The available flash settings depend on the recording mode.







(○: Available, —: Not available)

| | ⚡A | ⚡A👁 | ⚡ | ⚡S👁 | ⚡👁 | 🚫 |
|---|----|-----|-----|-----|----|---|
| 📷 | ○ | ○ | ○ | ○ | — | ○ |
| ❤ | — | ○*2 | —*2 | — | — | ○ |
| 👤 | ○ | ○ | ○ | ○ | — | ○ |
| 🏠 | — | — | — | — | — | ○ |
| 🌙 | ○ | ○ | ○ | — | — | ○ |
| 👤 | ○ | ○ | ○ | — | — | ○ |
| 📺 | — | — | — | — | — | ○ |
| 👤 | ○ | ○ | ○ | — | — | ○ |
| 👤 | — | — | — | ○ | — | ○ |
| 👤 | — | — | — | — | — | ○ |
| 👤 | ○ | ○ | ○ | — | — | ○ |
| 👤 | ○ | — | ○ | — | — | ○ |
| 👤 | — | — | — | ○ | ○ | ○ |
| 👤 | — | — | — | ○ | ○ | ○ |
| 👤 | — | — | — | — | — | ○ |
| 👤 | — | — | — | — | — | ○ |
| 👤 | — | — | ○ | — | — | ○ |
| 👤 | — | — | — | — | — | ○ |
| 👤 | ○ | — | ○ | — | — | ○ |
| 👤 | — | — | — | — | — | ○ |
| 👤 | ○ | ○ | ○ | — | — | ○ |
| 👤 | ○ | ○ | ○ | — | — | ○ |

- The flash setting may change if the recording mode is changed. Set the flash setting again if necessary.

*2 It becomes Forced ON [], when the backlight compensation function is activated.

■ Shutter speed for each flash setting

| Flash setting | Shutter speed (Sec.) |
|--|----------------------|
|  : AUTO | 1/30 to 1/2000 |
|  : AUTO/ Red-eye reduction | |
|  : Forced ON  : Forced ON/ Red-eye reduction | |
|  : Slow sync./ Red-eye reduction | 1/8* to 1/2000 |
|  : Forced OFF | |

- * The shutter speed changes depending on the slow shutter setting. (P78)
- There may be differences in the above shutter speeds in scene mode.
 - [NIGHT SCENERY] (P51): 8 seconds to 1/2000th of a second
 - [FIREWORKS] (P53): 1/4th of a second, 2 seconds
 - [STARRY SKY] (P54): 15 seconds, 30 seconds, 60 seconds



- Do not look directly at the flash at close range when it is activated.
- If you bring the flash too close to an object, the object may be distorted or discolored by the heat or lighting from the flash.
- Do not cover the photo flash with your fingers or other objects.
- In economy mode, the LCD monitor turns off and the status indicator lights while the flash is charging. [This does not happen when using the AC adaptor (DMW-AC5; optional).] If the remaining battery power is low, the length of time that the LCD monitor turns off to charge may become longer.

- If you press the shutter button halfway when the flash is activated, the flash icon turns red.
- When the jitter alert appears, we recommend using a tripod.
- When you take a picture beyond the available flash range, the exposure may not be adjusted properly and the picture may become bright or dark.
- When the flash is being charged, the flash icon blinks red, and you cannot take a picture even when you press the shutter button fully.
- When taking a picture with the flash, the white balance is automatically adjusted (except for []). However, the white balance may not be properly adjusted if the flash level is insufficient. (P71)
- When the shutter speed is fast, the flash effect may not be sufficient.
- If you repeat taking a picture, it may not actually be taken even if the flash is activated. Take a picture after the access indication disappears.
- The red-eye reduction effect differs between people. Also, if the subject was far away from the camera or was not looking at the first flash, the effect may not be evident.
- When you set burst mode or auto bracket, only 1 picture is recorded for every flash activated.

Taking Pictures with the Self-timer



1 Move ◀ [⌚].

2 Move ▲/▼ to select a mode.

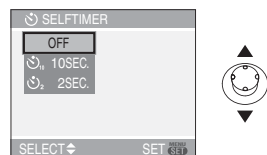

- You can also move ◀ [⌚] to select.

3 Press [MENU/SET].

- You can also press the shutter button halfway to finish.
- The menu screen disappears after about 5 seconds. At this time, the selected item is automatically set.

4 Press the shutter button halfway to focus and then press it fully to take the picture.

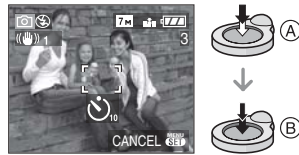

- (A): Press the shutter button halfway to focus.
- (B): Press the shutter button fully to take the picture.
- The self-timer indicator (C) blinks and the shutter is activated after 10 seconds (or 2 seconds).
- If you press [MENU/SET] while the self-timer is set, the self-timer setting is canceled.



- When using a tripod etc., setting the self-timer to 2 seconds is a convenient way to avoid the jitter caused by pressing the shutter button.
- When you press the shutter button once fully, the subject is automatically focused just before recording. In dark places, the self-timer indicator will blink and then may turn on brightly operating as an AF assist lamp (P78) to allow the camera to focus on the subject.
- In simple mode [♥], the self-timer is fixed to 10 seconds.
- In [SELF PORTRAIT] (P52) in scene mode, the self-timer is fixed to 2 seconds.
- When you set the self-timer in burst mode, the camera starts taking a picture 2 or 10 seconds after the shutter button is pressed. The number of pictures taken at one time is fixed to 3.
- We recommend using a tripod when recording with the self-timer. (When you use a tripod, make sure the tripod is stable when the camera is attached to it.)

Compensating the Exposure



Use this function when you cannot achieve appropriate exposure due to the difference in brightness between the subject and the background. Look at the following examples.

Under exposed



Compensate the exposure towards positive.



Properly exposed



Over exposed



Compensate the exposure towards negative.

1 Move ▲ [] until [EXPOSURE] appears, compensate the exposure with ◀▶.

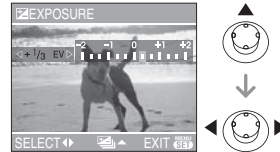

- You can compensate from [-2 EV] to [+2 EV] in steps of [1/3 EV].
- Select [0 EV] to return to the original exposure.

2 Press [MENU/SET] to finish.

- You can also press the shutter button halfway to finish.



- EV is an abbreviation of [Exposure Value]. It refers to the amount of light given to the CCD by the aperture value and the shutter speed.
- The exposure compensation value appears on the lower left of the screen.
- The set exposure value is memorized even if the camera is turned off.
- The compensation range of the exposure will be limited depending on the brightness of the subject.
- Exposure cannot be compensated when using [STARRY SKY] in scene mode.

Taking Pictures using Auto Bracket



In this mode, 3 pictures are automatically recorded in the selected exposure compensation range each time the shutter button is pressed. You can select the picture with the desired exposure from the 3 pictures with different exposures.

1 Move **▲** [**▲**] several times until **[AUTO BRACKET]** appears, set the compensation range of the exposure with **◀/▶**.

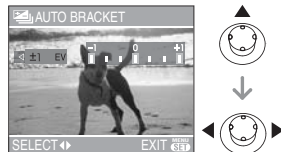

- You can select [OFF] (0), [$\pm 1/3$ EV], [$\pm 2/3$ EV] or [± 1 EV].
- When you do not use auto bracket, select [OFF] (0).

2 Press **[MENU/SET]** to finish.

- You can also press the shutter button halfway to finish.



- When setting auto bracket, the auto bracket icon [] appears on the lower left of the screen.
- When taking pictures using auto bracket after setting the exposure compensation range, the pictures taken are based on the selected exposure compensation range. When the exposure is compensated, the exposure compensation value appears on the lower left of the screen.
- The auto bracket setting is canceled if you turn the camera off or power save mode is activated.
- When setting auto bracket and burst mode simultaneously, auto bracket will be performed.
- When auto bracket is set, the auto review function is activated regardless of the auto review setting. (The picture is not enlarged.) You cannot set the auto review function in the [SETUP] menu.
- When auto bracket is activated, [AUDIO REC.] cannot be used.
- The exposure may not be compensated with auto bracket depending on the brightness of the subject.
- When the flash is activated or the number of recordable pictures is 2 or less, you can take only 1 picture.
- Auto bracket cannot be set in [SPORTS], [STARRY SKY] and [BABY1]/[BABY2] in scene mode.
- The auto bracket cannot be used when the ISO sensitivity is set to [**I**ISO].

Optical Image Stabilizer



This mode detects jitter and compensates for it.

1 Press and hold the optical image stabilizer button (A) until [STABILIZER] appears.



2 Move ▲/▼ to select the stabilizer function mode and then press [MENU/SET].

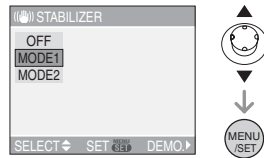

| | |
|----------------------|--|
| [MODE1] () | The stabilizer operates continuously and can assist during photo composition. |
| [MODE2] () | The jitter is compensated for when the shutter button is pressed. There is a greater stabilizing effect. |
| [OFF] () | When the stabilizer is not desired. |

■ Demonstration of the optical image stabilizer (Demonstration Mode)

Move ► to display the demonstration. After the demonstration ends, the screen returns to the stabilizer function mode selection menu. Move ► again if you want to exit the demonstration before it ends. While the demonstration is displayed, the optical zoom is fixed to Wide (1×) and the zoom function cannot be activated. You also cannot take pictures.



- The stabilizer function may not be effective in the following cases.
 - When there is a lot of jitter.
 - When the zoom magnification is high.
 - In digital zoom range.
 - When taking pictures while following a moving subject.
 - When the shutter speed becomes slower to take pictures indoors or in dark places.

Be careful of camera jitter when you press the shutter button.

- In simple mode [] or [SELF PORTRAIT] (P52) in scene mode, the setting is fixed to [MODE2] and in [STARRY SKY] (P54) it is fixed to [OFF]. The stabilizer function mode selection menu does not appear.
- In motion picture mode [], [MODE2] cannot be set.

Taking Pictures using Burst Mode



1 Press and hold the burst mode button.



2 Move ▲/▼ to select a mode.

- You can also press the burst mode button to select.

3 Press [MENU/SET].

- You can also press the shutter button halfway to finish.
- The menu screen disappears after about 5 seconds. At this time, the selected item is automatically set.

4 Take a picture.

- Hold down the shutter button fully to activate the burst mode.

■ Number of pictures recorded in burst mode

*1 The burst speed is constant regardless of the transfer speed of the card.

- The number of pictures indicated is when the shutter speed is faster than 1/60 and the flash is not activated.
- If you set the ISO sensitivity (P73) to [ISO400], [ISO800] or [ISO1250] and then take pictures using burst mode, burst speed will become slower than the figures indicated above.
- Since the shutter speed becomes slower in dark places, the burst speed (pictures/second) may also become slower.
- In simple mode [], the settings become as follows. [] appears on the screen. (P26)

– [ENLARGE]:

/Max. 6 pictures

– [4"×6"/10×15cm]/[E-MAIL]:

/Max. 8 pictures



• When the burst mode setting is set to **Unlimited**

- You can take pictures until the capacity of the card is full.
- The burst speed will become slower halfway. The burst speed of a MultiMediaCard becomes even slower than that of an SD Memory Card or SDHC Memory Card. However, the exact timing of this depends on the number of recordable pictures and the card.

- The focus is fixed when the first picture is taken.
- When the self-timer is used, the number of recordable pictures in burst mode is fixed to 3.
- Burst mode is not canceled when the camera is switched off.
- When auto bracket and burst mode are set simultaneously, auto bracket will be performed.
- The exposure and the white balance vary depending on the burst mode setting. When burst mode is set to [H], they are fixed to the values set for the first picture. When the burst speed is set to [P] or [L], they are adjusted each time you take a picture.
- When burst mode is set, the auto review function is activated regardless of the auto review setting. (The picture is not enlarged.) You cannot set the auto review function in the [SETUP] menu.
- When burst mode is activated, [AUDIO REC.] cannot be used.
- When the flash is activated or [STARRY SKY] in scene mode is selected, you can take only 1 picture.

Taking Close-up Pictures



This mode allows you to take close-up pictures of a subject, e.g. when taking pictures of flowers. You can take pictures of a subject as close as 5 cm (0.16 feet) from the lens by rotating the zoom lever upmost to Wide (1×).

Focus range

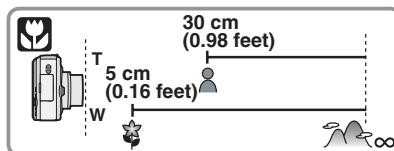

- We recommend using a tripod and the self-timer (P43) in macro mode.
- When a subject is close to the camera, the effective focus range (depth of field) is significantly narrowed. Therefore, if the distance between the camera and the subject is changed after focusing on the subject, it may become difficult to focus on it again.
- If the distance between the camera and the subject is beyond the focus range of the camera, the picture may not be properly focused even if the focus indication lights.
- Macro mode gives priority to a subject close to the camera. Therefore, if the distance between the camera and the subject is more than 50 cm (1.64 feet) it takes longer to focus on it in macro mode than normal picture mode.
- The available flash range is about 60 cm (1.97 feet) to 4.0 m (13.1 feet) (Wide). (When the ISO sensitivity is set to [AUTO].)
- We recommend setting the flash to Forced OFF [OFF] when you take pictures at close range.
- When you take pictures at close range, the resolution of the periphery of the picture may decrease slightly. This is not a malfunction.

Scene Mode



When you select a scene mode to match the subject and recording situation, the camera sets the optimal exposure and hue to obtain the desired picture.

- Refer to P50 to 56 for each scene menu.

1 Move ▲/▼ to select the scene mode.

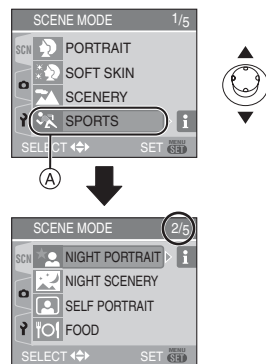

- Move ▼ at (A) to switch to the next menu screen.
- If [SCENE MODE] menu does not appear, press [MENU/SET] to display the [SCENE MODE] menu.
- When you move ►, explanations about each scene mode are displayed. (When you move ◀, the screen returns to the [SCENE MODE] menu.)

2 Press [MENU/SET].

■ About the menu screen items

- There are 5 menu screens (1/5, 2/5, 3/5, 4/5 and 5/5).
- You can switch menu screens from any menu item by rotating the zoom lever.

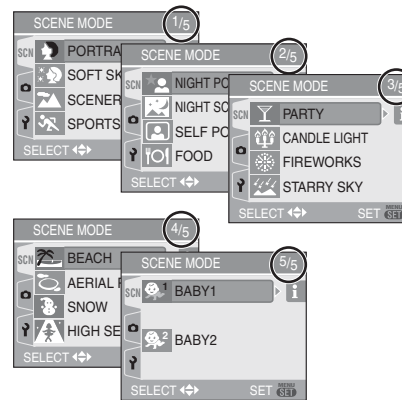

- When you take a picture with a scene mode that is not adequate for the purpose, the hue of the picture may differ from the actual scene.
- When you want to change the brightness of the picture to be recorded, compensate the exposure (P44). (However, the exposure cannot be compensated in [STARRY SKY].)
- Move ◀ and then move ▲/▼ in the [SCENE MODE] menu to select either the [REC] mode menu icon [📷] (P70) or the [SETUP] menu icon [⚙️] (P18) and set the desired items.
- The following cannot be set in scene mode because the camera automatically adjusts them to the optimal setting.
 - [W.BALANCE]
 - [SENSITIVITY]
 - [COL.EFFECT]
 - [PICT.ADJ.]

[PORTRAIT]

Press [MENU] to display the [SCENE MODE] menu and select a scene mode. (P49)

The person stands out from the background and has a healthier complexion.

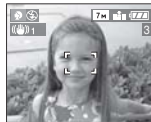

■ Technique for Portrait mode

To increase the effectiveness of this mode:

- 1 Rotate the zoom lever as far as possible to Tele.
- 2 Move close to the subject to make this mode more effective.



- This mode is only suitable when taking pictures outdoors in the daytime.
- ISO sensitivity is fixed to [ISO100].

[SOFT SKIN]

Press [MENU] to display the [SCENE MODE] menu and select a scene mode. (P49)

The camera detects the face or skin area to achieve a smoother appearance of the skin than portrait mode.



■ Technique for Soft skin mode

To make this mode more effective:

- 1 Rotate the zoom lever as far as possible to Tele.
- 2 Move close to the subject to make this mode more effective.



- This mode is only suitable when taking pictures outdoors in the daytime.
- If a part of the background etc. is a color close to skin color, this part is also smoothed.
- This mode may not be effective when there is insufficient brightness.
- ISO sensitivity is fixed to [ISO100].

[SCENERY]

Press [MENU] to display the [SCENE MODE] menu and select a scene mode. (P49)

The camera focuses preferentially on a distant subject. This allows you to take pictures of a wide landscape.



- The focus range is 5 m (16.4 feet) to ∞.
- The flash setting is fixed to Forced OFF [OFF].
- The setting on the AF assist lamp is disabled.

[SPORTS]

Press [MENU] to display the [SCENE MODE] menu and select a scene mode. (P49)

Set here when you want to take pictures of sports scenes or other fast-moving events.



- This mode is suitable for taking pictures of subjects at distances of 5 m (16.4 feet) or more.

- When taking pictures of a fast-moving subject indoors, the [ISO] function automatically increases the ISO sensitivity to prevent subject blur.
- The ISO sensitivity is fixed to [ISO].

[NIGHT PORTRAIT]

Press [MENU] to display the [SCENE MODE] menu and select a scene mode. (P49)
This mode allows you to take pictures of a subject and a landscape with near real-life brightness by using the flash and slowing down the shutter speed.



■ Technique for Night portrait mode

- **Use the flash.**
- Since the shutter speed becomes slower, we recommend using a tripod and the self-timer (P43) for taking pictures.
- Keep the subject still for about 1 second after taking the picture.
- We recommend rotating the zoom lever to Wide (1×) and being about 1.5 m (4.92 feet) from the subject when taking a picture.



- The focus range is 1.2 m (3.94 feet) to 5 m (16.4 feet). (Refer to P41 for the available flash range to take pictures.)
- The shutter may remain closed (max. about 1 sec.) after taking the picture because of signal processing. This is not a malfunction.
- Noise may become visible when you take pictures in dark places.
- When using the flash, Slow sync./Red-eye reduction [SR] is selected and the flash is activated every time.

[NIGHT SCENERY]

Press [MENU] to display the [SCENE MODE] menu and select a scene mode. (P49)

This mode allows you to record the nightscape vividly by reducing the shutter speed.



■ Technique for Night scenery mode

- Since the shutter speed becomes slower (up to about 8 sec.) use a tripod. We also recommend using the self-timer (P43) for taking pictures.



- The focus range is 5 m (16.4 feet) to ∞.
- The shutter may remain closed (max. about 8 sec.) after taking the picture because of signal processing. This is not a malfunction.
- Noise may become visible when you take pictures in dark places.
- The flash setting is fixed to Forced OFF [OFF].
- ISO sensitivity is fixed to [ISO100].
- The setting on the AF assist lamp is disabled.
- You cannot set the slow shutter.

 **[SELF PORTRAIT]**

Press  to display the [SCENE MODE] menu and select a scene mode. (P49)

This mode allows you to take pictures of yourself.

■ **Technique for Self portrait mode**

Press the shutter button halfway to focus. The self-timer indicator lights up when you are brought into focus. Making sure you hold the camera still, press the shutter button fully to take the picture.



- The subject is not focused when the self-timer indicator is blinking. Make sure to press the shutter button halfway again to focus.
- The recorded picture automatically appears on the LCD monitor for reviewing. Refer to P31 for information about using the review function.
- If the picture is blurry due to the slow shutter speed, we recommend using the 2 second self-timer. (P43)



- The focus range is about 30 cm (0.98 feet) to 70 cm (2.30 feet).
- You can take a picture of yourself with audio (P76). If you do this, the self-timer indicator will light up while recording the audio. (P43)
- When you select [SELF PORTRAIT], the zoom magnification is automatically moved to Wide (1×).
- The self-timer can only be set to off or 2 seconds (P43). If it is set to 2 seconds, this setting will remain until the camera is turned off or the mode dial is rotated.

- The stabilizer function mode is fixed to [MODE2]. (P46)
- The AF mode is fixed to . (P77)
- The setting on the AF assist lamp is disabled.

 **[FOOD]**

Press  to display the [SCENE MODE] menu and select a scene mode. (P49)

This mode allows you to take pictures of food with a natural hue without being affected by the ambient light in restaurants etc.

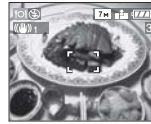

- The focus range becomes the same as macro mode. [5 cm (0.16 feet) (Wide)/ 30 cm (0.98 feet) (Tele) to ∞]

 **[PARTY]**

Press  to display the [SCENE MODE] menu and select a scene mode. (P49)

Select this mode when you want to take pictures at a wedding reception, indoor party etc. By using the flash and slowing down the shutter speed, both people and the background can be recorded with a brightness close to real life.



■ Technique for Party mode

- Since the shutter speed becomes slower, we recommend using a tripod and the self-timer (P43) for taking pictures.
- We recommend rotating the zoom lever to Wide (1×) and being about 1.5 m (4.92 feet) from the subject when taking pictures.



- The flash setting can be set to Slow sync./ Red-eye reduction [⚡S⊙] or Forced ON/ Red-eye reduction [⚡⊙].

■ [CANDLE LIGHT]

Press [MENU] to display the [SCENE MODE] menu and select a scene mode. (P49)

This mode allows you to take pictures with a candle-lit atmosphere.



■ Technique for Candle light mode

- If you make the most of the candle light, you can take successful pictures without using the flash.
- We recommend using a tripod and the self-timer (P43) for taking pictures.



- The focus range becomes the same as macro mode. [5 cm (0.16 feet) (Wide)/ 30 cm (0.98 feet) (Tele) to ∞]
- The flash setting can be set to Slow sync./ Red-eye reduction [⚡S⊙] or Forced ON/ Red-eye reduction [⚡⊙].

■ [FIREWORKS]

Press [MENU] to display the [SCENE MODE] menu and select a scene mode. (P49)

This mode allows you to take beautiful pictures of fireworks exploding in the night sky.



■ Technique for Fireworks mode

- Since the shutter speed becomes slower, we recommend using a tripod.



- This mode is most effective when the subject is 10 m (32.8 feet) or more away.
- The shutter speed becomes the following.
 - When [OFF] is set on the optical image stabilizer function: Fixed to 2 seconds
 - When [MODE1] or [MODE2] is set on the optical image stabilizer function: 1/4th of a second or 2 seconds (The shutter speed becomes 2 seconds only when the camera has determined that there is little jitter such as when using a tripod etc.)
- Histograms are always displayed in orange. (P37)
- The flash setting is fixed to Forced OFF [⊙].
- You cannot set the AF mode.
- The AF area is not displayed.
- The setting on the AF assist lamp is disabled.
- You cannot set the slow shutter.
- ISO sensitivity is fixed to [ISO100].

[STARRY SKY]

Press [MENU/SET] to display the [SCENE MODE] menu and select a scene mode. (P49)
This mode allows you to take vivid pictures of a starry sky or a dark subject that you could not take in [NIGHT SCENERY] by making the shutter speed slower.

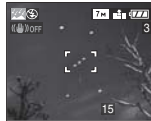

■ Setting the shutter speed

- Select a shutter speed of [15 SEC.], [30 SEC.] or [60 SEC.].
- 1 Move ▲/▼ to select the number of seconds and then press [MENU/SET].

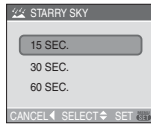

- 2 Take pictures.



- Press the shutter button to display the countdown screen. Do not move the camera after this screen is displayed. When a countdown finishes, [PLEASE WAIT...] is displayed for the same length of time as the set shutter speed for signal processing.
- Press [MENU/SET] to stop taking the picture while the countdown screen is displayed.

■ Technique for Starry sky mode

- The shutter opens for 15, 30 or 60 seconds. Be sure to use a tripod. We also recommend taking pictures with the self-timer. (P43)



- Histograms are always displayed in orange. (P37)
- The flash setting is fixed to Forced OFF [☺].
- The optical image stabilizer function is fixed to [OFF].
- ISO sensitivity is fixed to [ISO100].
- You cannot compensate the exposure or set [AUDIO REC.], auto bracket, burst mode, set the slow shutter.

[BEACH]

Press [MENU/SET] to display the [SCENE MODE] menu and select a scene mode. (P49)
This mode allows you to take pictures on a beach. It prevents under exposure of the subject under strong sunlight.



- Do not touch the camera with wet hands.
- Sand or seawater will cause the camera to malfunction. Make sure that sand or seawater does not get into the lens or the terminals.
- Problems caused by sand or seawater are not covered by the product warranty.

[AERIAL PHOTO]

Press  to display the [SCENE MODE] menu and select a scene mode. (P49)
This mode allows you to take pictures through an airplane window.



■ Technique for Aerial photo mode

- We recommend using this technique if it is difficult to focus when taking pictures of clouds etc. Aim the camera at something with high contrast, press the shutter button halfway to fix the focus and then aim the camera at the subject and press the shutter button fully to take the picture.



- Turn the camera off when taking off or landing.
- When using the camera, follow all instructions from the cabin crew.
- Be careful about the reflection from the window.
- The flash setting is fixed to Forced OFF .
- The setting on the AF assist lamp is disabled.

[SNOW]

Press  to display the [SCENE MODE] menu and select a scene mode. (P49)
This mode will adjust the white balance and the exposure to show the snow as white as possible.



[HIGH SENS.]

Press  to display the [SCENE MODE] menu and select a scene mode. (P49)
This mode sets the ISO sensitivity higher than usual. A slight blurring of the subject is created when taking pictures indoors etc.



- The resolution of the recorded picture decreases slightly because of high sensitivity processing. This is not a malfunction.
- ISO sensitivity is automatically set to the following optimal value.
 - [ISO3200]
- The focus range becomes the same as macro mode. [5 cm (0.16 feet) (Wide)/ 30 cm (0.98 feet) (Tele) to ∞]
- The flash setting is fixed to Forced OFF .
- The extended optical zoom and digital zoom cannot be used.

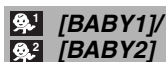

Press [MENU/SET] to display the [SCENE MODE] menu and select a scene mode. (P49)

This mode allows you to take pictures of a baby with a healthy complexion. When the flash is used, the light from it is weaker than usual.

You can set the birthdays of two babies by using [BABY1] and [BABY2].

- The baby's age can be displayed when playing back pictures.
- The age can also be printed on each picture by using the software [LUMIX Simple Viewer] in the CD-ROM (supplied). (For information about printing, refer to the separate operating instructions for PC connection.)

■ Age display setting

- If you want the age to be displayed, set the birthday in advance, select [WITH AGE] and press [MENU/SET].
- If you do not want the age to be displayed, select [WITHOUT AGE] and press [MENU/SET].

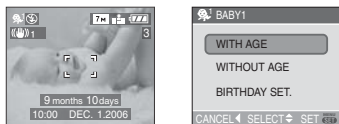

■ Birthday setting

- 1 Move ▲/▼ to select [BIRTHDAY SET.] and then press [MENU/SET].
 - 2 When the message [PLEASE SET THE BIRTHDAY OF THE BABY] appears, select items (Year/Month/Day) using ◀/▶ and set them using ▲/▼.
 - 3 Press [MENU/SET] to finish the setting.
- If you select [WITH AGE] without setting the birthday in advance, a message is displayed. Press [MENU/SET] and set the birthday in steps 2 and 3.



- The focus range becomes the same as macro mode. [5 cm (0.16 feet) (Wide)/ 30 cm (0.98 feet) (Tele) to ∞]
- ISO sensitivity is fixed to [1]ISO].
- After turning on the camera in [BABY1]/[BABY2] in scene mode or switching to [BABY1]/[BABY2] from other scene modes, the age and current date and time are displayed for about 5 seconds at the bottom of the screen.
- The age display style differs depending on the language setting in the recording mode.
- The display style when printing may differ slightly from the display style on the screen.
- The date of birth is displayed as [0 month 0 day].
- If the age is not properly displayed, check the clock and birthday settings.
- If the camera is set to [WITHOUT AGE], the age is not recorded even if the time and birthday are set. This means the age cannot be displayed even if camera is set to [WITH AGE] after taking the pictures.
- Use [RESET] in the [SETUP] menu to reset the birthday setting. (P21)

Recording which Day of the Vacation You Take the Picture



If you set the departure date in advance, you can record which day of the vacation you take the picture.

- When you play back a picture, the date on which it was taken is displayed.

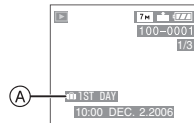

- (A): The number of days that have passed since the departure date
- The number of days that have passed since the departure date can be printed on each picture by using the software [LUMIX Simple Viewer] in the CD-ROM (supplied). (For information about printing, refer to the separate operating instructions for PC connection.)

■ Setting the travel date

- 1** Press [MENU/SET] and then move ◀.

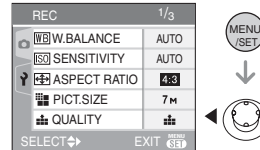

- 2** Move ▼ to select the [SETUP] menu icon [?] and then move ▶.

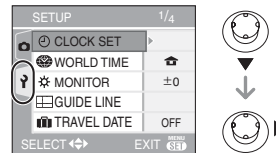

- 3** Move ▲/▼ to select [TRAVEL DATE] and then move ▶.

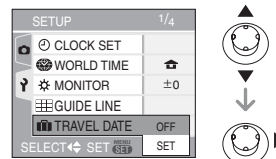

- 4** Move ▼ to select [SET] and then press [MENU/SET].

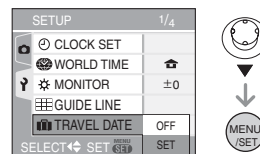

5 Move ▲/▼/◀/▶ to select the date.



◀/▶: Select the desired item.
 ▲/▼: Set the year, month and date.

6 Press [MENU/SET] twice to close the menu.

7 Take a picture.

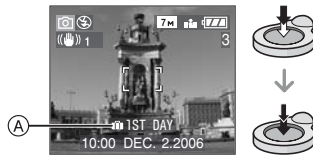

- Ⓐ: The number of days that have passed since the departure date
- The current date and time and which day of the vacation it is are displayed for about 5 seconds at the bottom of the screen if the camera is turned on when the travel date is set, after setting the clock, departure date or travel date, after changing the world time setting and after switching from playback mode to another mode.
 - When [TRAVEL DATE] is set, [1] appears on the lower right of the screen.

■ Canceling the travel date

If you leave [TRAVEL DATE] set to [SET], the number of days that have passed since the departure date will continue to be recorded.

When the vacation is finished, set [TRAVEL DATE] to [OFF] on the screen shown in step 4 and then press [MENU/SET] twice.



- The travel date is calculated using the date in the clock setting (P17) and the departure date you set. If you set [WORLD TIME] (P59) to the travel destination, the travel date is calculated using the date in the clock setting and the travel destination setting.
- The travel date setting is memorized even if the camera is turned off.
- If you set a departure date and then take a picture on a date before this departure date, [-] (minus) is displayed in orange and the day of the vacation that you took the picture is not recorded.
- If you set a departure date and then change the clock setting to the date and time at the travel destination, [-] (minus) is displayed in white and the day of the vacation that you took the picture is recorded when the travel destination date is, for example, one day before the departure date.
- If [TRAVEL DATE] is set to [OFF], the number of days that have passed since the departure date will not be recorded even if you set the travel date or the clock. Even if [TRAVEL DATE] is set to [SET] after taking the pictures, which day of the vacation you took them is not displayed.
- If you set a departure date when the clock is not set, the message [PLEASE SET THE CLOCK] appears. In this case, set the clock. (P17)
- The [TRAVEL DATE] setting also affects simple mode [♥].

Displaying the Time at the Travel Destination (World Time)



If you set your home area and the travel destination area when traveling abroad etc., the local time at the travel destination area can be displayed on the screen and recorded on the pictures taken.

- Select [CLOCK SET] to set the current date and time in advance. (P17)

1 Press [MENU/SET] and then move .

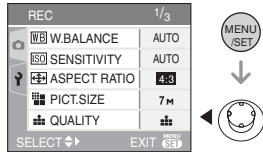

2 Move to select the [SETUP] menu icon and then move .

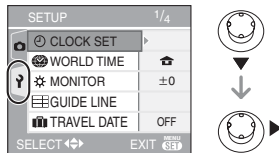

3 Move / to select [WORLD TIME] and then move .

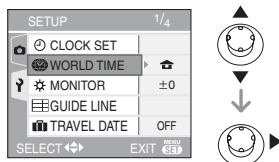

- If you are setting the world time for the first time, the message [PLEASE SET THE HOME AREA] appears. If this message appears, press [MENU/SET] and then set home area from the screen shown in step **2** in “Setting the home area [HOME]”.

■ Setting the home area [HOME] (Perform steps **1**, **2** and **3**.)

1 Move to select [HOME] and then press [MENU/SET] to set.



2 Move / to select your home area and then press [MENU/SET] to set.



- The current time is displayed on the top left of the screen and the time difference from GMT “Greenwich Mean Time” is displayed on the bottom left of the screen.
- If daylight saving time [] is used at the home area, move . Move again to return to the original time.
- The daylight saving time setting for the home area does not advance the current time. Advance the clock setting by one hour. (P17)

to
of
(ed.)
the menu.

changes from [] to []
setting the travel destination.

- Return the setting to [HOME] when the vacation is finished by performing steps **1, 2, 3** and then steps **1** and **2** of "Setting the home area [HOME]". (P59)
- If you cannot find the travel destination in the areas displayed on the screen, set by the time difference from the home area.
 - The [WORLD TIME] setting also affects simple mode [].



50
VQT0Y19

Location candidates for World Time settings

| Offset from GMT | Listed location name | | | |
|-----------------|----------------------|---------------|--------------|--------------|
| -11 | Midway Islands | Samoa | | |
| -10 | Hawaii | Honolulu | Tahiti | |
| -9 | Alaska | Anchorage | | |
| -8 | Vancouver | Seattle | Los Angeles | |
| -7 | Denver | Phoenix | | |
| -6 | Chicago | Houston | Mexico City | |
| -5 | Toronto | New York | Miami | Lima |
| -4 | Caracas | Manaus | La Paz | |
| -3:30 | Newfoundland | | | |
| -3 | Rio de Janeiro | Sao Paulo | Buenos Aires | |
| -2 | Fernando de Noronha | | | |
| -1 | Azores | | | |
| 0 | London | Casablanca | | |
| +1 | Berlin | Paris | Rome | Madrid |
| +2 | Helsinki | Athens | Cairo | Johannesburg |
| +3 | Moscow | Kuwait | Riyadh | Nairobi |
| +3:30 | Tehran | | | |
| +4 | Dubai | Abu Dhabi | | |
| +4:30 | Kabul | | | |
| +5 | Islamabad | Karachi | Male | |
| +5:30 | Delhi | Kolkata | Mumbai | Chennai |
| +5:45 | Kathmandu | | | |
| +6 | Dacca | Colombo | | |
| +6:30 | Yangon | | | |
| +7 | Bangkok | Jakarta | | |
| +8 | Beijing | Hong Kong | Kuala Lumpur | Singapore |
| +9 | Seoul | Tokyo | | |
| +9:30 | Adelaide | | | |
| +10 | Guam | Sydney | | |
| +11 | Solomon Islands | New Caledonia | | |
| +12 | Fiji | Auckland | Wellington | |
| +12:45 | Chatham Islands | | | |

* "GMT" is an abbreviation of "Greenwich Mean Time".

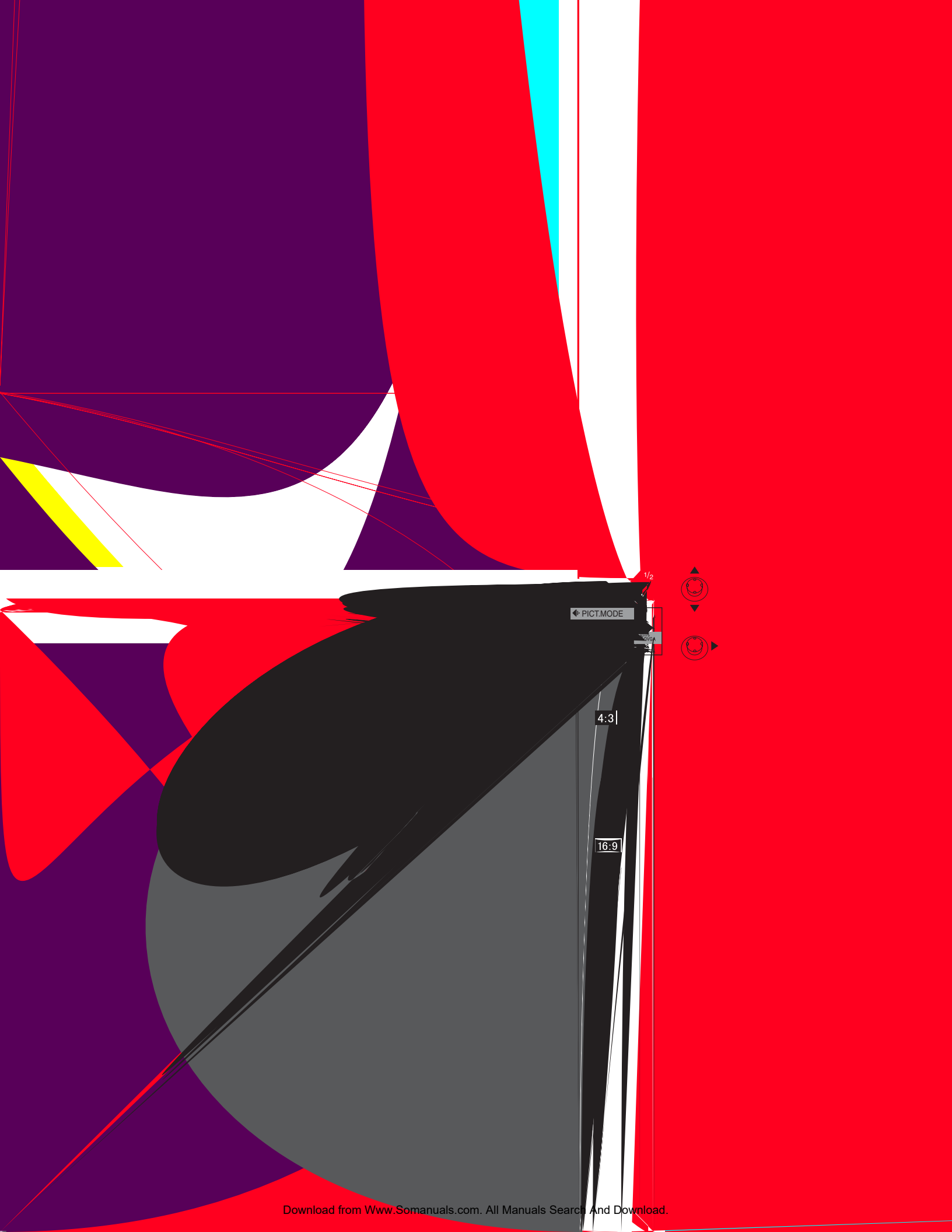

1/2

← PICT.MODE

→

4:3

16:9



- fps “frames per second”; This refers to the number of frames used in 1 second.
- You can record smoother motion pictures with “30 fps”.
- You can record longer motion pictures with “10 fps” although the picture quality is lower.
- The file size with [10fpsQVGA] is small so it is suitable for e-mails.

6 Press [MENU/SET] to close the menu.

- **You can also press the shutter button halfway to close the menu.**



- The focus range is 5 cm (0.16 feet) (Wide) to ∞, 30 cm (0.98 feet) (Tele) to ∞.
- Refer to P114 for information about the available recording time.
- The available recording time displayed on the screen may not decrease regularly.
- Motion pictures cannot be recorded without audio.
- This unit does not support recording motion pictures on MultiMediaCards.
- **When you set the picture quality to [30fpsVGA] or [30fps16:9], we recommend using a high speed SD Memory Card with “10MB/s” or greater displayed on the package.**
- **Depending on the type of SD Memory Card or SDHC Memory Card, recording may stop in the middle.**
- **We recommend using Panasonic’s SD Memory Card/SDHC Memory Card.**
- Depending on the type of SD Memory Card or SDHC Memory Card, the card access indication may appear for a while after recording motion pictures. This is not a malfunction.

- When motion pictures recorded with the camera are played back on other equipment, the quality of the picture and sound may deteriorate and it may not be possible to play them back. Also the recording information may not be displayed correctly.
- In motion picture mode [H], you cannot use the direction detection function and the review function.
- You cannot set [MODE2] on the optical image stabilizer function.
- The bundled software includes QuickTime to play back motion picture files recorded with the camera on the PC.

Displaying Multiple Screens (Multi Playback)



1 Rotate the zoom lever towards [] [W] to display multiple screens.

(Screen when 9 screens are displayed)

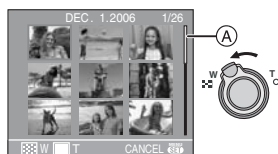

- []: 1 screen → 9 screens → 25 screens → Calendar screen display (P65)
- Rotate the zoom lever towards [Q] [T] to return to the previous screen.
- When you switch to multiple screens, a scroll bar (A) appears. You can confirm the location of the displayed picture in all the recorded pictures with this scroll bar.

2 Move ▲/▼/◀/▶ to select a picture.

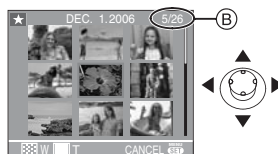

- (B): Number of the selected picture and the total number of recorded pictures
- The recording date and number of the selected picture and the total number of recorded pictures are displayed.

- Depending on the recorded picture and the setting, the following icons will appear.

- [★] (Favorites)
- [] (Motion picture)
- [] ([BABY1]/[BABY2] in scene mode)
- [] (Travel date)

Examples of 25 screens



To return to normal playback

Rotate towards [Q] [T] or press [MENU/SET].

- The picture appears framed in orange.

To delete a picture during multi playback

- 1 Move ▲/▼/◀/▶ to select a picture and then press [].
- 2 Move ▲ to select [YES].
- 3 Press [MENU/SET].



- Even if the indications on the screen are turned off in normal playback mode (P35), the recording information etc. appears on the screen in multi playback. If you return to the 1 screen playback screen, the camera returns to the normal playback screen.

- Pictures will not be displayed in the rotated direction even if [ROTATE DISP.] is set to [ON]. (P83)

Displaying Pictures by Recording Date (Calendar Playback)



You can display pictures by recording date using the calendar playback function.

1 Rotate the zoom lever towards [] [W] to display the calendar screen.



- The recording date of the picture selected in the playback screen becomes the date selected when the calendar screen is first displayed.
- If there are multiple pictures with the same recording date, the first picture recorded on that day is displayed.
- The calendar is displayed monthly.

2 Move ▲/▼/◀/▶ to select the date to be played back.

▲/▼: Select the month

◀/▶: Select the date

- If there were no pictures recorded during a month, the month is not displayed.

3 Press [MENU/SET] to display the pictures that were recorded on the selected date.



- The pictures that were recorded on the selected date are displayed on the 9 screens playback screen.
- Rotate the zoom lever towards [] [W] to return to the calendar screen.

4 Move ▲/▼/◀/▶ to select a picture and then press [MENU/SET].

- The selected picture is displayed on the 1 screen playback screen.

■ To return to the 1 screen playback screen

After the calendar screen is displayed, rotate the zoom lever towards [Q] [T] to display 25 screens, 9 screens and the 1 screen. (P64)



- The pictures are displayed without being rotated even if you set [ROTATE DISP.] to [ON]. (P83)
- You can display the calendar between January 2000 and December 2009.
- If the recording date of the picture selected in 25 screen multi playback is not between January 2000 and December 2009, the camera displays it in the oldest recording date in the calendar.
- Pictures edited on a PC will be displayed with dates different from the actual recording dates.
- If the date is not set in the camera (P17), the recording date is set as January 1st, 2006.
- If you take pictures after setting the travel destination in [WORLD TIME] (P59), the pictures are displayed by the dates at the travel destination in calendar playback.

Changing the Playback Zoom

Rotate the zoom lever towards [L] [W] to enlarge the picture.

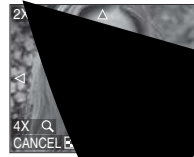

- **Zoom lever**: 1x → 2x → 4x
- When you rotate the zoom lever towards [L] [W] and enlarge the picture, the magnification becomes lower. When you rotate the zoom lever towards [R] [T], the magnification becomes higher.
- When you change the zoom position for about 1 second, the zoom position is saved. Check the position in the playback zoom section.

2 Move ▲ to set the zoom position

To stop using the playback zoom
Rotate the zoom lever towards [L] [W] or press [MENU/SET].

To delete a picture in the playback zoom

- 1 Press [L].
- 2 Move ▲ to select the picture.
- 3 Press [MENU/SET].



- Even when you use the playback zoom, the magnification and operation indicators on the screen are the same as in normal playback (page 35).
- The magnification and operation indicators on the screen can be switched between displaying and not displaying the screen by pressing [L].
- When you set the magnification, the magnification indicators on the screen are the same as in normal playback (page 35).
- The more you zoom in, the more its quality is degraded.

Playing Back Motion Pictures/Pictures with Audio



■ Motion pictures

Move ◀/▶ to select a picture with a motion picture icon [30fps VGA] / [10fps VGA] / [30fps QVGA] / [10fps QVGA] / [30fps 16:9] / [10fps 16:9] and then move ▼ to play back.

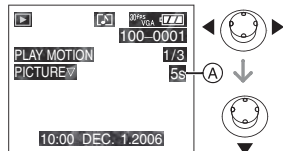

- The motion picture recording time (A) is displayed on the screen. After playback starts, the motion picture recording time disappears and the elapsed playback time is displayed on the bottom right of the screen.

For example, 1 hour 20 minutes and 30 seconds is displayed as [1h20m30s].

- The cursor displayed during playback is the same as ▲/▼/◀/▶.
- Move ▼ again to stop motion picture playback and return to the normal playback screen.



Fast forward

Move and hold [] to fast forward motion picture playback.

◀: Fast reverse

▶: Fast forward

- The camera returns to normal motion picture playback when the [] is released.

To pause

Move ▲ during motion picture playback.

- Move ▲ again to resume playback.

Frame-by-frame

Move ◀/▶ to frame-by-frame playback.

◀: Frame-by-frame reverse

▶: Frame-by-frame forward

Move ▲ again to stop frame-by-frame playback and return to normal motion picture playback.

■ Pictures

Move ◀/▶ to select a picture with the audio icon [] and then move ▼ to play back.



- Refer to [AUDIO DUPLICATION] and [AUDIO DUAL] for more information about how to create pictures with audio.

(while playing back or pause pictures and while playing back pictures only)
- [ROTATE DISP.] / [ROTATE DISP.] / [ASPECT CONV.]

- Move ▲ (up) to move the picture play head to the previous frame.
- Move ◀▶ (left/right) to move forward frame.
- If you press the [PAUSE] button, you can save the display as one single picture. (Picture Still)

3 Rotate the zoom lever towards [] [W] to display the 9 screens playback screen.



- After the 9 screens playback screen is displayed, rotate the zoom lever towards [] [W] to switch the frames/second.

When [**30fpsVGA**]/[**30fpsQVGA**]/[**30fps16:9**] is selected

30 frames/second → 15 frames/second
→ 10 frames/second
→ 5 frames/second

When [**10fpsVGA**]/[**10fpsQVGA**]/[**10fps16:9**] is selected

10 frames/second → 5 frames/second

- Rotates the zoom lever towards [Q] [T] to return to the previous frames/second screen.
- You can move forward frame-by-frame by moving ▲/▼/◀/▶.
 - ▲/▼: Move forward/backward 3 frames at a time.
 - ◀/▶: Move forward/backward 1 frame at a time.

4 Press the shutter button.

- The message [SAVE THESE NINE PICTURES AS ONE SINGLE PICTURE ?] appears. Also, the message [SAVE AS A SINGLE PICTURE ?] appears if you saved the picture in step **2**.

5 Move ▲ to select [YES] and then press [MENU/SET].



- The nine pictures are saved as one single picture.

Picture size

| Item | 1 picture | 9 pictures |
|-------------|-----------|------------|
| [30fpsVGA] | 0.3 M | 2 M |
| [10fpsVGA] | 0.3 M | 2 M |
| [30fpsQVGA] | 0.3 M | 1 M |
| [10fpsQVGA] | 0.3 M | 1 M |
| [30fps16:9] | 2 M | 2 M |
| [10fps16:9] | 2 M | 2 M |

- [QUALITY] (P75) is fixed to [].



- You may not be able to save still pictures from a motion picture taken on other equipment.

Using the [REC] Mode Menu



Increase the variety of pictures you can take by setting color effect, picture adjustment etc.

- Set the mode dial to the desired recording mode.
- Menu items differ depending on the mode selected with the mode dial (P6). This page describes how to set [AUDIO REC.] in normal picture mode [📷]. (Refer to P71 to 79 for each menu item.)
- Select [RESET] in the [SETUP] menu to return the menu settings to the initial settings at the time of purchase. (P21)

1 Press [MENU/SET].

2 Move ▲/▼ to select the menu item.

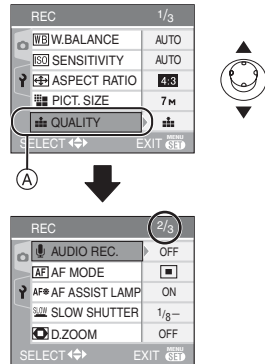

- Move ▼ at (A) to switch to the next menu screen.

3 Move ►, move ▲/▼ to select the setting and then press [MENU/SET].

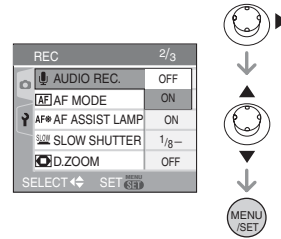

4 Press [MENU/SET] to close the menu.

- You can also press the shutter button halfway to close the menu.

■ About the menu screen items

- There are 3 menu screens (1/3, 2/3 and 3/3).
- You can switch menu screens from any menu item by rotating the zoom lever.

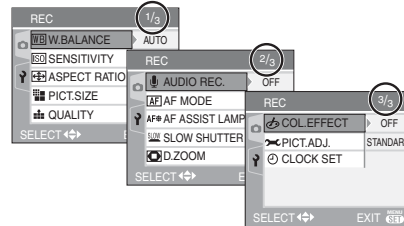

[W.BALANCE]

[WB] Adjusting the hue for a more natural picture



Press [MENU] to display the [REC] mode menu and select the item to set. (P70)
This function allows you to reproduce a white color close to real life in pictures recorded under sunlight, halogen lighting etc. in which the white color may appear reddish or bluish. Select a setting that matches the recording conditions.

| | |
|------------------------|---|
| [AUTO] | for auto setting (auto white balance) |
| (Daylight) | for recording outdoors on a bright day |
| (Cloudy) | for recording outdoors on a cloudy day |
| (Shade) | for recording outdoors in the shade on a bright day |
| (Halogen) | for recording under halogen lighting |
| (White set) | for using the preset white balance |
| SET (White set) | for setting the white balance again |

- If you select a setting other than [AUTO], you can finely adjust the white balance.

■ Auto white balance

The available white balance range is shown in the following illustration. When you take a picture beyond the available white balance range, the picture may appear reddish or bluish. Even within the confines of the range, the auto white balance may not operate properly if there are many light sources or there is no color close to white. In these cases, set the white balance to a mode other than [AUTO].

- 1 Auto white balance will work within this range.
- 2 Blue sky
- 3 Cloudy sky (Rain)
- 4 Shade
- 5 TV screen
- 6 Sunlight
- 7 White fluorescent light
- 8 Incandescent light bulb
- 9 Sunrise and sunset
- 10 Candlelight

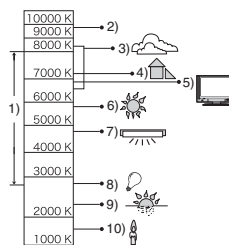

K=Kelvin Color Temperature

■ **Setting the white balance manually**

[SET]

Use this to set the white balance manually.

- 1 Select [SET] and then press [MENU/SET].
- 2 Aim the camera at a sheet of white paper etc. so that the frame in the center is filled by the white object only and then press [MENU/SET].



- 3 Press [MENU/SET] twice to close the menu.

- You can also press the shutter button halfway to finish.

■ **Finely adjusting the white balance**

[WB]

You can adjust the white balance finely when you cannot acquire the desired hue by setting the white balance.

- Set the white balance to [].

- 1 Move ▲ [] several times until [WB ADJUST.] appears and then move ◀/▶ to adjust the white balance.



- ◀ [RED]: Move when the hue is bluish.
- ▶ [BLUE]: Move when the hue is reddish.
- Select [0] to return to the original white balance.

- 2 Press [MENU/SET] to finish.

- You can also press the shutter button halfway to finish.
- The white balance icon on the screen turns red or blue.



About the white balance

- When you take a picture with the flash, the white balance is automatically adjusted (except for []). However, the white balance may not be properly adjusted if the flash level is insufficient.
- The white balance cannot be set in simple mode [] and scene mode.

About the white balance fine adjustment

- You can finely adjust the white balance independently for each white balance item.
- The white balance fine adjustment setting is reflected in the picture when using the flash.
- The white balance fine adjustment setting is memorized even if the camera is turned off.
- The white balance fine adjustment level in [] returns to [0] when you reset the white balance using [SET].
- You cannot finely adjust the white balance when [COL.EFFECT] (P79) is set to [COOL], [WARM], [B/W] or [SEPIA].

[ISO] [SENSITIVITY]
Setting the light sensitivity



Press [MENU] to display the [REC] mode menu and select the item to set. (P70)
ISO is a measure of sensitivity to light. The higher the sensitivity is set, the less light is needed to take a picture so the camera becomes more suitable for recording in dark places.

| | | |
|---|--------------|--------------|
| ISO sensitivity | 100 ← → 1250 | |
| Use in bright places (e.g. outdoors) | Suitable | Not suitable |
| Use in dark places | Not suitable | Suitable |
| Shutter speed | Slow | Fast |
| Noise | Less | Increased |

| | |
|-----------|--|
| [AUTO] | The ISO sensitivity is automatically adjusted according to the brightness. |
| [iISO] | The ISO sensitivity is adjusted according to the movement of the subject and the brightness. |
| [ISO100] | The sensitivity is fixed to various settings. |
| [ISO200] | |
| [ISO400] | |
| [ISO800] | |
| [ISO1250] | |

- When setting to [AUTO], the ISO sensitivity is automatically adjusted to a maximum of [ISO200] according to the brightness. (It can be adjusted to a maximum of [ISO400] when using the flash.)

■ About [iISO] (Intelligent ISO sensitivity control)

The camera detects the movement of the subject near the center of the screen and then sets the optimal ISO sensitivity and shutter speed according to the movement and the brightness of the subject.

- Jitter is avoided when taking pictures indoors of a moving subject by increasing the ISO sensitivity and making the shutter speed faster.



1/125 ISO800

- Noise is avoided when taking pictures indoors of a subject with no movement by decreasing the ISO sensitivity.

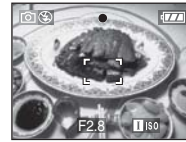

1/30 ISO200

- When setting to [iISO], the ISO sensitivity is automatically adjusted to a maximum of [ISO800] ([ISO400] when using the flash).



- When you press the shutter button halfway, [iISO] (A) appears. When you press the shutter button fully, the shutter speed is displayed for a while.





- If you select [**I**ISO], digital zoom, auto bracket and slow shutter cannot be used.
- Depending on the brightness and how fast the subject is moving, jitter may not be avoided even if [**I**ISO] is selected.
- The camera may not be able to detect the movement of the subject in the following cases.
 - When the moving subject is small
 - When the moving subject is at the edge of the screen
 - When the subject starts moving the instant the shutter button is pressed fully
- ISO sensitivity is automatically set to the following optimal value in [HIGH SENS.] (P55) in scene mode.
 - [ISO3200]
- To avoid picture noise, we recommend decreasing the ISO sensitivity or setting [PICT.ADJ.] to [NATURAL]. (P79)
- ISO sensitivity cannot be set in the following cases.
 - Simple mode [**♥**]
 - Motion picture mode [**Ⓜ**]
 - Scene mode

[ASPECT RATIO]
Setting the aspect ratio of pictures



Press [**Ⓜ**] to display the [REC] mode menu and select the item to set. (P70)
By changing the aspect ratio, you can select an angle of view that matches the subject.

| | |
|-------------|---|
| 4:3 | <p>Select to take pictures with the same aspect ratio as a 4:3 TV or a PC monitor.</p>  |
| 3:2 | <p>Select to take pictures with the same 3:2 aspect ratio as 35 mm film.</p>  |
| 16:9 | <p>This is suitable for landscapes etc. where a wide view is preferable. This is also suitable for playing back pictures on a wide-screen TV, high-definition TV etc.</p>  |



- In motion picture mode [**Ⓜ**], you can select [**4:3**] or [**16:9**]. (P62)
- The ends of the recorded pictures may be cut at printing. (P110)

[PICT.SIZE]/[QUALITY]
Setting a picture size and quality
that match your use of the pictures



Press [MENU] to display the [REC] mode menu and select the item to set. (P70)
 A digital picture is made of numerous dots called pixels. Although you cannot see the difference on the camera's screen, the more pixels the finer the picture will be when it is printed on a large piece of paper or displayed on a PC monitor. Picture quality refers to the compression rate when saving digital pictures.

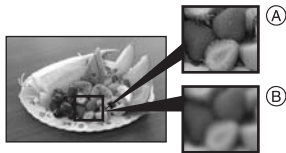

- (A) Many pixels (Fine)
 (B) Few pixels (Rough)

* These pictures are examples to show the effect.

■ **Number of pixels**

You can print pictures more clearly when a large picture size [7M] (7M) is selected. When a smaller picture size [0.3M] (0.3M EZ) is selected, you can record more pictures and attach them to an e-mail or post them on a website because their file size is small.

■ **When the aspect ratio is [4:3].**

| | |
|----------------|------------------|
| 7M (7M) | 3072×2304 pixels |
| 5M (5M EZ) | 2560×1920 pixels |
| 3M (3M EZ) | 2048×1536 pixels |
| 2M (2M EZ) | 1600×1200 pixels |
| 1M (1M EZ) | 1280×960 pixels |
| 0.3M (0.3M EZ) | 640×480 pixels |

■ **When the aspect ratio is [3:2].**

| | |
|----------------|------------------|
| 6M (6M) | 3072×2048 pixels |
| 2.5M (2.5M EZ) | 2048×1360 pixels |

■ **When the aspect ratio is [16:9].**

| | |
|-------------|------------------|
| 5.5M (5.5M) | 3072×1728 pixels |
| 2M (2M EZ) | 1920×1080 pixels |

■ **Quality**

You can increase the number of recordable pictures without changing the picture size if quality is set to [FINE].

| | |
|--|---|
| | Fine (Low compression): This gives priority to picture quality. Picture quality will be high. |
| | Standard (High compression): This gives priority to the number of recordable pictures. Standard quality pictures are recorded. |



- The number of pixels that can be selected differs depending on the aspect ratio. If you change the aspect ratio, set the picture size.
- “EZ” is an abbreviation of “Extended optical Zoom”. This is a function which further extends the optical zoom ratio. If you select a picture size with EZ displayed, the zoom ratio is extended to a maximum of 5.5× when the digital zoom is set to [OFF]. (P29)
- The extended optical zoom does not work in [HIGH SENS.] in scene mode so the picture size for [EZ] is not displayed.
- Pictures may appear mosaic depending on the subject and the recording conditions.
- Refer to P112 for information about the number of recordable pictures.
- The number of recordable pictures depends on the subject.
- The number of recordable pictures displayed on the screen may not correspond with recorded pictures.
- In simple mode [♥], the settings become as follows.
 - [ENLARGE]:
 : (7M) /
 - [4"×6"/10×15cm]:
 : (2.5M EZ) /
 - [E-MAIL]:
 : (0.3M EZ) /



[AUDIO REC.]

Recording still pictures with audio



Press [] to display the [REC] mode menu and select the item to set. (P70)
 You can record audio with the still picture if this is set to [ON]. This means you can record the conversation that took place when you were recording or an explanation of the picture.

- [] appears on the screen when you set [AUDIO REC.] to [ON].
- Focus on the subject and press the shutter button to start recording. Recording will automatically stop about 5 seconds later. There is no need to press and hold the shutter button.
- Audio is recorded from the built-in microphone on the camera.
- If you press [MENU/SET] during audio recording, the audio recording is canceled. The audio is not recorded.
- The total number of pictures that can be stored on each card will decrease slightly when audio is recorded with each picture.



- You cannot take pictures with audio in auto bracket, burst mode or [STARRY SKY] in scene mode.

[AF] [AF MODE] Setting the focus method



Press [MENU] to display the [REC] mode menu and select the item to set. (P70)
Select the mode that matches the recording conditions and the composition.

[9] 9-area-focusing :

The camera focuses on any of 9 focus areas. This is effective when the subject is not in the center of the screen.



[3] 3-area-focusing (High speed):

The camera quickly focuses on any of 3 focus areas – left, right or center. This is effective when the subject is not in the center of the screen.



[1] 1-area-focusing (High speed):

The camera quickly focuses on the subject in the AF area on the center of the screen.



[1] 1-area-focusing:

The camera focuses on the subject in the AF area on the center of the screen.



[•] Spot-focusing:

The camera focuses on a limited narrow area in the center of the screen.



■ About [3] or [1]

- The picture may stop moving for a moment before being brought into focus when you press the shutter button halfway. This is not a malfunction.



- The AF area displayed on the center of the screen is bigger than usual when using the digital zoom or when taking pictures in dark places.

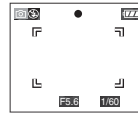

- The camera is focusing on all the AF areas when multiple AF areas (max. 9 areas) light at the same time.
- The focus position is not predetermined. It is set to a position automatically determined by the camera at the time of focusing. If you want to determine the focus position to take pictures, switch the AF mode to [3], [1] or [•].
- Switch the AF mode to [3] or [1] if it is difficult to focus using [•].
- The AF mode cannot be set in simple mode [♥], [FIREWORKS] or [SELF PORTRAIT] in scene mode.

[AF ASSIST LAMP]

AF* *Focusing in low light conditions becomes easier*



Press [MENU] to display the [REC] mode menu and select the item to set. (P70)
Illuminating the subject makes it easier for the camera to focus when recording in low light conditions that make focusing difficult.

- If the AF assist lamp is set to [ON], an AF area with a size wider than usual is displayed and the AF assist lamp (A) turns on when you press the shutter button halfway in dark places etc.

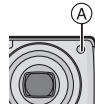

| | |
|--------------|---|
| [ON] | The AF assist lamp turns on in low light conditions. At this time, the AF assist lamp icon [AF*] appears on the screen. The effective range of the AF assist lamp is 1.5 m (4.92 feet). |
| [OFF] | The AF assist lamp does not turn on. |



- Be careful about the following when using the AF assist lamp.
 - Do not look at the AF assist lamp from close up.
 - Do not cover the AF assist lamp with your fingers or other objects.
- When the AF assist lamp is turned on, the AF area on the center of the screen is displayed and it is bigger than usual. (P77)

- When you do not want to use the AF assist lamp (e.g. when taking pictures of animals in dark places), set the [AF ASSIST LAMP] to [OFF]. In this case, it will become more difficult to focus on the subject.
- The setting for [AF ASSIST LAMP] is fixed to [ON] in simple mode [♥].
- The setting for the [AF ASSIST LAMP] is fixed to [OFF] in [SCENERY] (P50), [NIGHT SCENERY] (P51), [FIREWORKS] (P53) [SELF PORTRAIT] (P52) and [AERIAL PHOTO] (P55) in scene mode.

[SLOW SHUTTER]

SLOW *Recording bright pictures in dark places*



Press [MENU] to display the [REC] mode menu and select the item to set. (P70)
When taking pictures in dark places with low light, you can take pictures which are brighter than normal by selecting a setting even slower than the slowest setting of the shutter speed.

- The slow shutter speeds you can select are: [1/8-], [1/4-], [1/2-] and [1-].
- This is effective if you want to take bright pictures of both a night landscape and a subject using [NIGHT PORTRAIT] (P51) in scene mode.

| | | |
|-----------------------------|----------------|----------|
| Slow shutter setting | 1/8- ←————→ 1- | |
| Brightness | Darker | Brighter |
| Jitter | Less | More |

■ Example





- This should usually be set to [1/8-] to take pictures. (When you select a slow shutter speed other than [1/8-], [SLOW] appears on the lower left of the screen.)
- When the shutter speed is made slower using [SLOW SHUTTER], jitter is likely to occur. We recommend using a tripod and the self-timer (P43) for taking pictures.
- You cannot set the slow shutter in [NIGHT SCENERY], [FIREWORKS] and [STARRY SKY] in scene mode.

[COL.EFFECT]

 *Setting color effects for the recorded pictures*



Press [] to display the [REC] mode menu and select the item to set. (P70)
Select a color effect that matches the recording conditions and your image of the recording.

| | |
|----------------|--------------------------------------|
| [COOL] | The picture becomes bluish. |
| [WARM] | The picture becomes reddish. |
| [B/W] | The picture becomes black and white. |
| [SEPIA] | The picture becomes sepia. |

[PICT.ADJ.]

 *Adjusting the picture quality for the recorded pictures*



Press [] to display the [REC] mode menu and select the item to set. (P70)
Select an effect that matches the recording situation and your image of the recording.

| | |
|------------------|------------------------------|
| [NATURAL] | The picture becomes softer. |
| [VIVID] | The picture becomes sharper. |



- When you take pictures in dark places, noise may become visible. To avoid noise, we recommend setting [PICT.ADJ.] to [NATURAL].

[CLOCK SET]

 *Set the display order for the date and time*



Press [] to display the [REC] mode menu and select the item to set. (P70)
Change date and time. (P17)

Using the [PLAY] mode menu



You can use various functions in playback mode to rotate pictures, set protection for them etc.

- Refer to P81 to 91 for each menu item.

1 Press [MENU/SET].

2 Move ▲/▼ to select the menu item and then move ►.

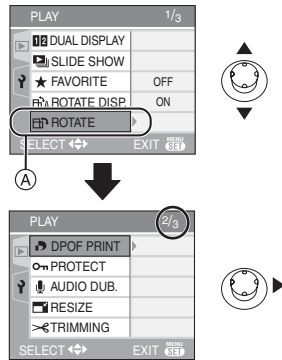

- Move ▼ at (A) to switch to the next menu screen.
- After performing steps 1 and 2, refer to the description of the menu item in the operating instructions and then set it.

■ About the menu screen items

- There are 3 menu screens (1/3, 2/3 and 3/3).
- You can switch menu screens from any menu item by rotating the zoom lever.

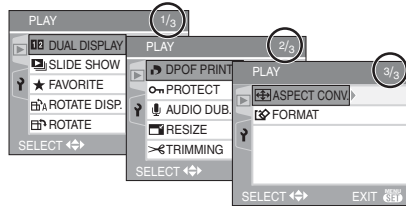

[DUAL DISPLAY]

12 Displaying the recorded pictures on a dual display

Press [MENU] to display the [PLAY] mode menu and select the item to set. (P80)
You can display two recorded pictures on the screen to compare them.

Move ▲/▼ to switch the orange frame between the top and the bottom and move ◀/▶ to select the picture.



- 1 The orange frame switches to the top. (You can select the picture at the top.)
- 2 The orange frame switches to the bottom. (You can select the picture at the bottom.)
- 3 The previous picture is displayed.
- 4 The next picture is displayed.

- When you rotate the zoom lever towards [Q] [T], the magnification becomes higher. When you rotate the zoom lever towards [] [W], the magnification becomes lower.
- When you change the magnification, the zoom position indication appears for about 1 second so that you can check the position of the enlarged section.

■ To cancel the dual display

Press [MENU/SET].

- The picture displayed in the orange frame appears on the 1 screen playback screen.



- When [ROTATE DISP.] is set to [ON], pictures recorded holding the camera vertically are played back vertically (rotated).
- You cannot display the same picture on the dual display at the same time.
- Press [] to return to the 1 screen playback screen.
- You cannot select [DUAL DISPLAY] if there are no recorded pictures or only 1 recorded picture.

Press [] to display the [PLAY] mode menu and select the item to set. (P80)

This is recommended when playing back pictures on a TV screen. You can skip unwanted pictures if [FAVORITE] (P82) has been set.



1 Move ▲/▼ to select [ALL] or [] and then press [MENU/SET].

- The screen shown in step **1** appears when [FAVORITE] is set to [ON]. When [FAVORITE] is set to [OFF], perform step **2** onwards.

- If none of the pictures have [] displayed, you cannot select [] even if [FAVORITE] is set to [ON].

■ **Setting the audio, duration and effect**

Select [DURATION], [EFFECT] or [AUDIO] on the screen shown in step 2 and set.

| | |
|-------------------|---|
| [DURATION] | Can be set to [1SEC.], [2SEC.], [3SEC.], [5SEC.] or [MANUAL] (manual playback). |
| [EFFECT] | <p>A slide show effect can be selected.</p> <p>[OFF]: No effect</p> <p> : New pictures slide across the screen.</p> <p> : New pictures appear from behind the current pictures and replace them.</p> <p> : New pictures gradually fill the screen from the center.</p> <p>[MIX] : An effect is selected at random.</p> <p>• If you set [DURATION] to [MANUAL] the settings in [EFFECT] are disabled.</p> |
| [AUDIO] | If set to [ON], the audio of the pictures with audio is played back. |

- You can only select [MANUAL] when [★] has been selected in step 1.
- Move ◀/▶ to display the previous or next picture when [MANUAL] is selected.



- If you set [AUDIO] to [ON] and then play back a picture with audio, the next picture will be displayed after the audio has finished.
- You cannot play back motion pictures and use power save in a slide show. (However, the setting for power save mode is fixed to [10MIN.] while pausing a slide show or playing back a manual slide show.)

★ **[FAVORITE]**
Setting your favorite pictures

Press [MENU] to display the [PLAY] mode menu and select the item to set. (P80) You can do the following if a mark has been added to pictures and they have been set as favorites.

- Delete all the pictures not set as favorites. ([ALL DELETE EXCEPT ★]) (P33)
- Play back the pictures set as favorites only as a slide show. (P81)

1 Move ▼ to select [ON] and then press [MENU/SET].

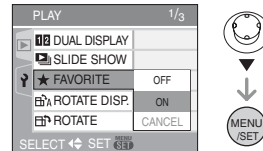

- You cannot set pictures as favorites if [FAVORITE] is set to [OFF]. Also the favorites icon [★] will not appear when [FAVORITE] is set to [OFF] even if it was previously set to [ON].
- You cannot select [CANCEL] if none of the pictures have [★] displayed.

2 Press [MENU/SET] to close the menu.

3 Move ◀/▶ to select the picture then move ▲.

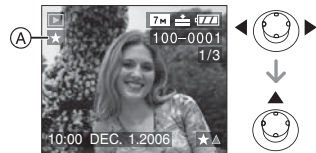

- Repeat the above procedure.
- If ▲ is moved while the [★] favorites icon (A) is displayed, [★] is cleared, and the favorites setting is canceled.
- You can set up to 999 pictures as favorites.

■ Deleting all favorites

- 1 Select [CANCEL] on the screen shown in step 1 and then press [MENU/SET].
- 2 Move ▲ to select [YES] and then press [MENU/SET].
- 3 Press [MENU/SET] to close the menu.



- When printing pictures at a photo printing store, [ALL DELETE EXCEPT ★] (P33) is useful so only the pictures you want to be printed remain on the card.
- Use [LUMIX Simple Viewer] on the CD-ROM (supplied), to set, confirm or delete favorites. (For information about this, refer to the separate operating instructions for PC connection.)
- You may not be able to set pictures taken with other equipment as favorites.

■ [ROTATE DISP.]/[ROTATE] To display the picture rotated

Press [MENU] to display the [PLAY] mode menu and select the item to set. (P80)
This mode allows you to automatically display pictures vertically if they were recorded holding the camera vertically or rotate pictures manually in 90° steps.

■ Rotate display (The picture is automatically rotated and displayed.)

1 Move ▼ to select [ON] and then press [MENU/SET].

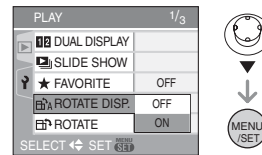

- The pictures are displayed without being rotated when you select [OFF].
- Refer to P32 for information about how to play back pictures.

2 Press [MENU/SET] to close the menu.

■ Rotate
(The picture is rotated manually.)

1 Move ◀/▶ to select the picture and then move ▼.

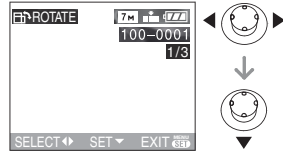

- The [ROTATE] function is disabled when [ROTATE DISP.] is set to [OFF].
- Motion pictures and protected pictures cannot be rotated.

2 Move ▲/▼ to select the direction to rotate the picture and then press [MENU/SET].

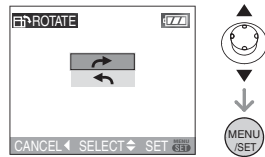

| | |
|---|--|
| ➡ | The picture rotates clockwise in steps of 90°. |
| ⬅ | The picture rotates counter-clockwise in steps of 90°. |

3 Press [MENU/SET] twice to close the menu.

■ Example
When rotating clockwise (➡)

Original picture

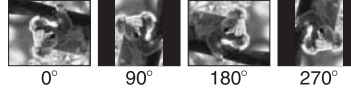

- When [ROTATE DISP.] is set to [ON], pictures recorded holding the camera vertically are played back vertically (rotated).
- If you take pictures when aiming the camera up or down, it may not be possible to display the pictures vertically. (P24)
- The picture may be slightly blurred when the camera is connected to the TV with the AV cable (supplied) and played back vertically.
- When you play back pictures on a PC, they cannot be displayed in the rotated direction unless the OS or software is compatible with Exif. Exif is a file format for still pictures which allows recording information etc. to be added. It was established by "JEITA (Japan Electronics and Information Technology Industries Association)".
- Rotated pictures are displayed rotated when they are played back in review playback and playback zoom however are displayed without being rotated when they are played back in multi playback.
- It may not be possible to rotate pictures that have been recorded with other equipment.

[DPOF PRINT]**Setting the picture to print and the number of prints**

Press [MENU/SET] to display the [PLAY] mode menu and select the item to set. (P80) DPOF "Digital Print Order Format" is a system that allows the user to select which pictures to print, how many copies of each picture to print and whether or not to print the recording date on the pictures when using a DPOF compatible photo printer or photo printing store. For details, ask at your photo printing store.

For more information visit:

http://panasonic.jp/dc/dpof_110/white_e.htm

Move ▲/▼ to select [SINGLE], [MULTI] or [CANCEL] and then press [MENU/SET].

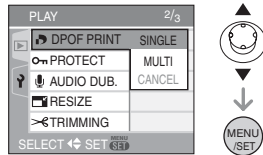

- You cannot select [CANCEL] if there are no prints that have been set in the DPOF print settings.

Single setting

1 Move ◀/▶ to select the picture to print and then move ▲/▼ to set the number of prints.



- The number of prints icon [DPOF] (A) appears.
- The number of prints can be set from 0 to 999. The DPOF print setting is canceled when the number of prints is set to [0].

2 Press [MENU/SET] twice to close the menu.

Multi setting

1 Move ◀/▶ to select the picture to print and then move ▲/▼ to set the number of prints.

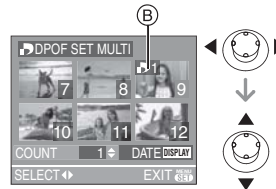

- The number of prints icon [DPOF] (B) appears.
- Repeat the above procedure. (You cannot set all the pictures at one time.)
- The number of prints can be set from 0 to 999. The DPOF print setting is canceled when the number of prints is set to [0].

2 Press [MENU/SET] twice to close the menu.

■ To cancel all settings

1 Move ▲ to select [YES] and then press [MENU/SET].

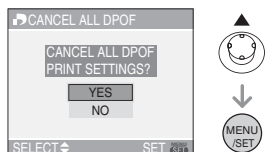

2 Press [MENU/SET] to close the menu.

■ To print the date

After setting the number of prints, set/cancel printing with the recording date by pressing [DISPLAY].

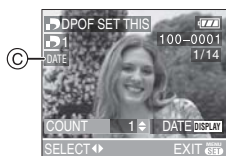

- The date print icon [DATE] © appears.
- When you go to a photo printing store for digital printing, be sure to order the printing of the date additionally if required.
- Depending on the photo printing store or the printer, the date may not be printed even if you set to print the date. For further information, ask at your photo printing store or refer to the operating instructions for the printer.



- DPOF is an abbreviation of “Digital Print Order Format”. This feature allows you to write print information to media and then use the information on a DPOF-compliant system.
- DPOF print setting is a convenient function when printing pictures with a printer that supports PictBridge. The date printing setting on the printer may take priority over the date printing setting on the camera. Check the date printing setting on the printer also. (P95)
- It is necessary to delete all previous DPOF print information made on other equipment when setting DPOF print on the camera.
- If the file is not based on the DCF standard, the DPOF print setting cannot be set. DCF is an abbreviation of “Design rule for Camera File system”, stipulated by “JEITA (Japan Electronics and Information Technology Industries Association)”.

[PROTECT]
 Preventing accidental erasure of pictures

Press [] to display the [PLAY] mode menu and select the item to set. (P80)
 You can set protection for pictures you do not want to be deleted by mistake.

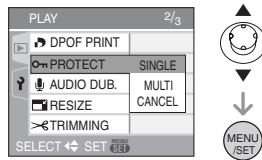

Move ▲/▼ to select [SINGLE], [MULTI] or [CANCEL] and then press [MENU/SET].



■ **Single setting**

1 Move ◀/▶ to select the picture and then move ▼ to SET/CANCEL.



| | |
|-----------------|--|
| [SET] | The protect icon [] (A) appears. |
| [CANCEL] | The protect icon [] (A) disappears. |

2 Press [MENU/SET] twice to close the menu.

■ **Multi setting/To cancel all settings**

Perform the same operation as in "[DPOF PRINT] Setting the picture to print and the number of prints". (P85 to 86)



- If you press [MENU/SET] while canceling protection, the canceling will stop halfway.
- The protect setting may not be effective on other equipment.
- If you want to delete protected pictures, cancel their protection.
- Even if you protect pictures on a card, they will be deleted if the card is formatted. (P91)
- Even if you do not protect pictures on an SD Memory Card or an SDHC Memory Card, they cannot be deleted when the card's Write-Protect switch (B) is set to [LOCK].

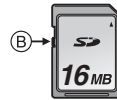

- The following functions cannot be used with protected pictures.
 - [ROTATE]
 - [AUDIO DUB.]

[AUDIO DUB.] Adding audio after taking pictures

Press [MENU] to display the [PLAY] mode menu and select the item to set. (P80)
You can add the audio after taking a picture.

1 Move ◀/▶ to select the picture and then move ▼ to start audio recording.



- The message [OVERWRITE AUDIO DATA?] screen appears when audio has already been recorded. Move ▲ to select [YES] and then press [MENU/SET] to start audio recording. (The original audio is overwritten.)
- Audio dubbing cannot be used with the following pictures.
 - Motion pictures
 - Protected pictures
- Audio dubbing may not work properly on pictures recorded by other equipment.

2 Move ▼ to stop recording.

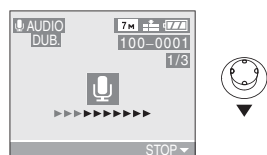

- The audio recording stops automatically if ▼ is not moved after about 10 seconds.

3 Press [MENU/SET] twice to close the menu.

[RESIZE] Making the picture smaller

Press [MENU] to display the [PLAY] mode menu and select the item to set. (P80)
This function is useful if you want to reduce the file size of a picture to attach it to an e-mail or upload it to a website.

1 Move ◀/▶ to select the picture and then move ▼.



- The following pictures cannot be resized.
 - Pictures recorded in [0.3M] (0.3M EZ) (When the aspect ratio setting is [4:3].)
 - Pictures recorded in [2.5M] (2.5M EZ) (When the aspect ratio setting is [3:2].)
 - Pictures recorded in [2M] (2M EZ) (When the aspect ratio setting is [16:9].)
 - Motion pictures
 - Pictures with audio
- It may not be possible to resize pictures recorded with other equipment.

2 Move ◀/▶ to select the size and

- Use ▲/▼ to set the frame position for pictures rotated vertically.
- The message [DELETE ORIGINAL PICTURE?] appears.

4 Move ▲/▼ to select [YES] or [NO] and then press [MENU/SET].

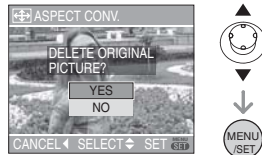

- The picture is overwritten when you select [YES]. If you convert the aspect ratio of a picture and then overwrite it, you cannot restore it.
- A picture with the converted aspect ratio is newly created when you select [NO].
- When the original picture is protected, you cannot overwrite it. Select [NO] and newly create a picture with the converted aspect ratio.

5 Press [MENU/SET] twice to close the menu.



- After converting the aspect ratio, the picture size may become larger than that of the original picture.
- The following pictures cannot be converted.
 - Pictures with audio
 - Motion pictures
- Files that do not conform to the DCF standard cannot be converted. DCF is an abbreviation of “Design rule for Camera File system”, stipulated by “JEITA (Japan Electronics and Information Technology Industries Association)”.

[FORMAT] Initializing the card

Press [MENU] to display the [PLAY] mode menu and select the item to set. (P80)
Usually, it is not necessary to format the card. Format it when the message [MEMORY CARD ERROR] appears.

Move ▲ to select [YES] and then press [MENU/SET].

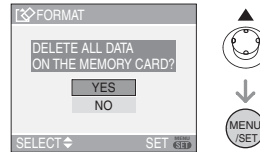

- Formatting irretrievably deletes all the data including any protected pictures. Check the data carefully before formatting.
- If the card has been formatted on a PC or other equipment, format it on the camera again.
- Use a battery with sufficient battery power (P13) or the AC adaptor (DMW-AC5; optional) when formatting.
- Do not turn the camera off during formatting.
- You cannot format an SD Memory Card or an SDHC Memory Card when the card's Write- Protect switch (A) is set to [LOCK].



- If the card cannot be formatted, consult your nearest servicenter.

For USA assistance, please call: 1-800-272-7033
or send e-mail to : digitalstillcam@panasonic.com

For Canadian assistance, please call:
1-800-561-5505 or visit us at www.panasonic.ca

Connecting to a PC



You can acquire recorded pictures to a PC by connecting the camera and the PC. The software [LUMIX Simple Viewer] (for Windows®) in the CD-ROM (supplied) allows you to easily acquire pictures recorded with the camera to a PC, print them and send them by e-mail.

If you use "Windows 98/98SE", install the USB driver and then connect it to the computer.

For information about installing [LUMIX Simple Viewer] etc., refer to the separate operating instructions for PC connection.

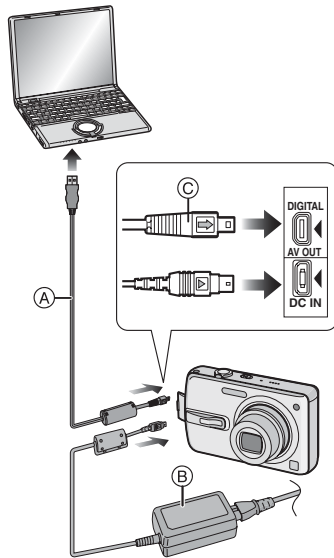

Ⓐ: USB connection cable (supplied)

Ⓑ: AC adaptor (DMW-AC5; optional)

- Use a battery with sufficient battery power or the AC adaptor (DMW-AC5; optional).
- Turn the camera off before inserting or removing the cable for the AC adaptor (DMW-AC5; optional).

92

VQT0Y19

- Set the camera to a mode other than [] mode.

1 Turn on the camera and the PC.

2 Connect the camera to a PC via the USB connection cable Ⓐ (supplied).

- Connect the USB connection cable with the [] mark facing the [] mark on the [DIGITAL] socket.
- Hold the USB connection cable at Ⓒ and insert straight in or take straight out. (If you forcibly insert the USB connection cable at a slant or upside down you can deform the connection terminals and damage the camera or the connected equipment.)



Ⓓ: This message appears during data transfer.

[Windows]

The drive appears in the [My Computer] folder.

- If you are connecting the camera to a PC for the first time, the required driver is installed automatically so that the camera can be recognized by "Windows Plug and Play". The drive then appears on the [My Computer] folder.

[Macintosh]

The drive is displayed on the screen.

- The drive is displayed as [LUMIX] when you connect the camera with no card inserted.
- The drive is displayed as [NO_NAME] or [Untitled] when you connect the camera with a card inserted.

■ About motion picture playback on a PC

Use the software "QuickTime" (for Windows 2000/XP) in the CD-ROM (supplied) to play back motion pictures recorded on this camera on a PC.

- If you use "Windows 98/98SE/Me", download "QuickTime6.5.2 for PC" from the following site, and install it. <http://www.apple.com/support/quicktime/>
- This software is installed as standard on a "Macintosh OS".

■ Folder Composition

Folders are displayed as shown in the following illustration.

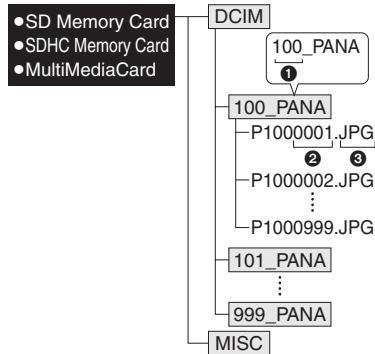

- ❶ Folder number
- ❷ File number
- ❸ JPG: pictures
MOV: motion pictures

The items in each folder are as follows.

| | |
|--------------------------|---|
| [DCIM] | Folders from [100_PANA] to [999_PANA] |
| [100_PANA] to [999_PANA] | Pictures/motion pictures |
| [MISC] | Files on which the DPOF print settings are recorded |

- The data for up to 999 pictures recorded by the camera can be included in 1 folder. If the number of pictures exceeds 999, another folder is created.
- To reset the file number or the folder number, select [NO.RESET] in the [SETUP] menu. (P21)

■ Conditions under which a different folder number is used

In the following cases, the picture is not recorded in the same folder as the previously recorded picture. It is recorded in a folder with a new number.

- 1 When the folder just recorded to contains a picture file with the number 999 in it (example: P1000999.JPG).
- 2 When the card just recorded to contains, for example, a folder with the number 100 [100_PANA] in it and that card is removed and replaced with a card that has a folder with the number 100 in it recorded by a camera from a different maker (100XXXXX, with XXXXX being the name of the maker) and then a picture is recorded.
- 3 When recording after selecting [NO.RESET] (P21) from the [SETUP] menu. (Pictures will be recorded to a new folder with a number sequential to the folder recorded to immediately before. By using [NO.RESET] on a card that does not contain folders or pictures, such as one just formatted, the folder number can be reset to 100.)



■ About the PTP connection

If the OS is "Windows XP" or "Mac OS X", you can connect in PTP mode if you set the camera to [] mode and then connect to your PC.

- Pictures can only be read on the camera. They cannot be written to a card or deleted.
- When there are 1000 or more pictures on a card, the pictures may not be imported.



- Do not use any other USB connection cables except the supplied one.
- Do not disconnect the USB connection cable while [ACCESS] is displayed.
- When there are many pictures on the card, it may take some time to transfer them.
- You may not be able to play back motion pictures on the card correctly when the camera is connected to a PC. Import the motion picture files to the PC and then play them back.
- If battery power is exhausted while the camera and the PC are communicating, the recorded data may be damaged. When you connect the camera to the PC, use a battery with sufficient battery power (P13) or the AC adaptor (DMW-AC5; optional).
- If the remaining battery power becomes low while the camera and the PC are communicating, the status indicator blinks and the alarm beeps. In this case, stop the communication at once on the PC.

- **When connecting the camera to a "Windows 2000" OS PC with the USB connection cable, do not replace the card while the camera and the PC are connected. The information on the card may be damaged. Disconnect the USB connection cable before replacing the card.**
- Pictures edited or rotated with a PC may be displayed in black in playback mode (P32), multi playback (P64) and calendar playback (P65).
- For information about this, refer to the separate operating instructions for PC connection.
- Read the operating instructions for the PC.
- The message [PLEASE RE-CONNECT THE PRINTER.] appears if you change the mode dial to [] while the camera and the PC are connected. Set the camera to a mode other than [] mode, check that no data is being transferred and then connect to the printer again. ([ACCESS] appears on the LCD monitor of the camera while data is being transferred.)

Printing the Pictures



By connecting the camera directly to a printer supporting PictBridge via the USB connection cable (supplied), you can select the pictures to print and start printing on the camera's screen.

Set print settings such as the print quality on the printer beforehand. (Read the printer operating instructions.)

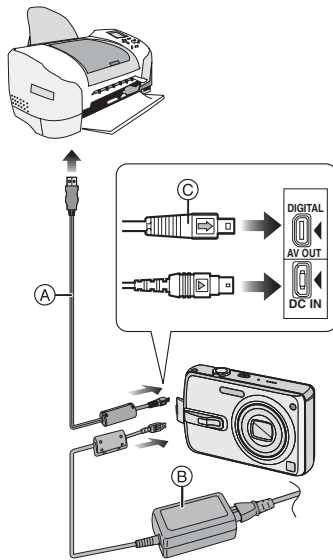

Ⓐ: USB connection cable (supplied)

Ⓑ: AC adaptor (DMW-AC5; optional)

- It may take time to print some pictures. Use a battery with sufficient battery power (P13) or the AC adaptor (DMW-AC5; optional) when you connect to a printer.
- Turn the camera off before inserting or removing the cable for the AC adaptor (DMW-AC5; optional).

1 Turn on the camera and the printer.

2 Set the mode dial to [🖨️].

3 Connect the camera to a printer via the USB connection cable Ⓐ (supplied).

- Connect the USB connection cable with the [➡️] mark facing the [⬅️] mark on the [DIGITAL] socket.
- Hold the USB connection cable at Ⓒ and insert straight in or take straight out.



- Do not use any other USB connection cables except the supplied one.
- If the mode dial is not set to [🖨️] when the camera is connected to the PC, disconnect the USB connection cable, set the mode dial to [🖨️] and then connect the USB connection cable again.
- To print the age in [BABY1]/[BABY2] (P56) in scene mode or the departure date for [TRAVEL DATE] (P57), use the software [LUMIX Simple Viewer] in the CD-ROM (supplied) and print from the PC. For information about this, refer to the separate operating instructions for PC connection.
- To find out more about PictBridge compliant printers, contact your local dealer.

■ **Selecting a single picture and printing it**

1 Move ◀/▶ to select the picture and then press [MENU/SET].

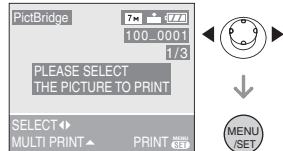

- The message disappears in about 2 seconds.

2 Move ▲ to select [PRINT START] and then press [MENU/SET].

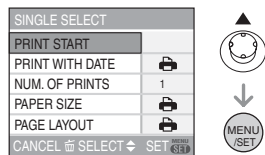

- Press [MENU/SET] to cancel printing halfway.

3 Disconnect the USB connection cable after printing.

■ **Selecting multiple pictures and printing them**

1 Move ▲.

2 Move ▲/▼ to select an item and then press [MENU/SET].

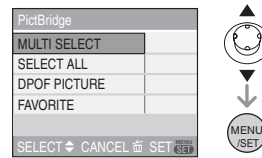

| | |
|-----------------------|--|
| [MULTI SELECT] | Multiple pictures are printed at one time. After selecting [MULTI SELECT], move ◀/▶ to select the pictures to print and then move ▼. The icon [P] appears on the pictures to be printed. (Move ▼ again to cancel the setting.) Press [MENU/SET] after finishing the setting. |
| [SELECT ALL] | Prints all the stored pictures. |
| [DPOF PICTURE] | Prints the pictures set in [DPOF] only. (P85) |
| [FAVORITE]* | Prints the pictures set as favorites only. (P82) |

*This only appears when [FAVORITE] (P82) is set to [ON]. (However if none of the pictures have [★] displayed, you cannot select it even if [FAVORITE] is set to [ON].)

3 Move ▲ to select [PRINT START] and then press [MENU/SET].

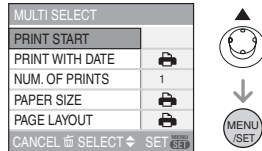

- [PRINT WITH DATE] and [NUM. OF PRINTS] are not displayed when [DPOF PICTURE] is set.
- Press [MENU/SET] to cancel printing.
- When you select [MULTI SELECT], [SELECT ALL] or [FAVORITE], a print confirmation screen appears. Select [YES] and print the pictures.
- The message [PRINTING ## PICTURE(S) DO YOU WANT TO PROCEED ?] appears on the print confirmation screen if the number of prints is more than 1000.

4 Disconnect the USB connection cable after printing.

■ Setting date printing, the number of prints, the paper size and the page layout

Select and set each item in step 3.

- Items not supported by the printer are displayed in gray and cannot be selected.
- When you want to print pictures in a paper size or a layout which is not supported by the camera, set [PAPER SIZE] or [PAGE LAYOUT] to [] and then set the paper size or the layout on the printer. (For details, refer to the operating instructions of the printer.)

• [PRINT WITH DATE]

| | |
|-------|--|
| | Settings on the printer are prioritized. |
| [OFF] | Date is not printed. |
| [ON] | Date is printed. |

- If the printer does not support date printing, the date cannot be printed on the picture.

• [NUM. OF PRINTS]

- Set the number of prints.
- You can set up to 999 prints.

• [PAPER SIZE]





- (Paper sizes that can be set with this unit)
- The paper sizes are displayed on pages 1/2 and 2/2. Move ▼ to select.

| | |
|-------------|--|
| 1/2 | |
| | Settings on the printer are prioritized. |
| [L/3.5"×5"] | 89 mm×127 mm |
| [2L/5"×7"] | 127 mm×178 mm |
| [POSTCARD] | 100 mm×148 mm |
| [A4] | 210 mm×297 mm |
| 2/2* | |
| [CARD SIZE] | 54 mm×85.6 mm |
| [10×15cm] | 100 mm×150 mm |
| [4"×6"] | 101.6 mm×152.4 mm |
| [8"×10"] | 203.2 mm×254 mm |
| [LETTER] | 216 mm×279.4 mm |

*These items cannot be displayed when the printer does not support the paper sizes.

• **[PAGE LAYOUT]**

(Layouts for printing that can be set with this unit)

| | |
|---|--|
|  | Settings on the printer are prioritized. |
|  | 1 picture with no frame on 1 page |
|  | 1 picture with a frame on 1 page |
|  | 2 pictures on 1 page |
|  | 4 pictures on 1 page |

- An item cannot be selected if the printer does not support the page layout.

■ **Setting the date printing with the DPOF print in advance**

We recommend setting DPOF date printing with [DPOF PRINT] (P86) in advance when the printer supports it. If you select [DPOF PICTURE], printing starts and the recording date is printed.

■ **Layout printing**





• **When printing a picture several times on 1 sheet of paper**

For example, if you want to print a picture 4 times on 1 sheet of paper, set [PAGE LAYOUT] to  and then set [NUM. OF PRINTS] to 4.

• **When printing different pictures on 1 sheet of paper (only in DPOF printing)**

For example, if you want to print 4 different pictures on 1 sheet of paper, set [PAGE LAYOUT] to  and then set [COUNT] in [DPOF PRINT] (P85) to 1 for each of the 4 pictures.



- Do not disconnect the USB connection cable when the cable disconnection warning icon  is displayed. (Depending on the printer, the icon may not be displayed.)
- If the remaining battery power becomes low while the camera and the printer are connected, the status indicator blinks and the alarm beeps. If this happens during printing, press [MENU/SET] and stop printing at once. If not printing, disconnect the USB connection cable.
- The camera is receiving an error message from the printer when the  indication lights orange during printing. After finishing printing, make sure there are no problems with the printer.
- If the total number of DPOF prints or the number of DPOF pictures printed is high, pictures may be printed several times. The remaining number of prints indicated may differ from the number set. This is not a malfunction.
- With date printing, the setting on the printer may take priority over the setting on the camera. Check the date print setting on the printer also.
- The message [USB MODE CHANGED. PLEASE REMOVE THE USB CABLE.] appears if you change the mode dial to a mode other than  while the camera and the printer are connected. Set the mode dial to  again and then disconnect the USB connection cable. If this happens during printing, stop printing and then disconnect the USB connection cable.

Playing Back Pictures on a TV Screen



■ Playing back pictures using the AV cable (supplied)

- Set the aspect of the TV on the camera. (P22)
- Turn the camera and the TV off.

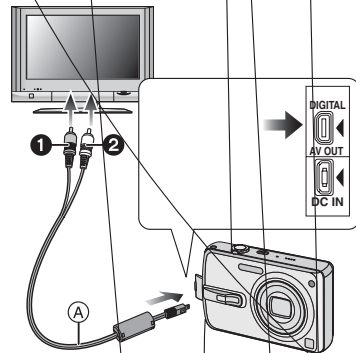

1 Connect the AV cable **A** (supplied) to the [AV OUT] socket on the camera.

- Connect the AV cable with the [] mark facing the [◀] mark on the [AV OUT] socket.
- Hold the AV cable at **B** and insert straight in or take straight out.

2 Connect the AV cable to the video input and the audio input sockets on the TV.

- **1** Yellow: to the video input socket
- **2** White: to the audio input socket

3 Turn the TV on and select external input.

4 Turn the camera on.



- Do not use any other AV cables except the supplied one.
- The top and bottom or left and right of the picture may be cut off slightly when it is displayed due to the characteristics of the TV.
- Depending on the screen mode setting of the TV when you connect the camera to a wide-screen TV or a high-definition TV, the picture may be stretched horizontally or vertically and the top and bottom and or left and right of the picture may be cut off when it is displayed. In this case, change the screen mode setting.
- Audio playback is monaural.
- Read the operating instructions for the TV.
- When you play back a picture vertically, it may be blurry.
- You can view pictures on TVs in other countries (regions) which use the NTSC or PAL system when you set [VIDEO OUT] in the [SETUP] menu. Even if you set [VIDEO OUT] to [PAL], the output signal will still be NTSC in the recording mode.

■ Playing back pictures on a TV with an SD Memory Card slot

Still pictures recorded on an SD Memory Card can be played back on a TV with an SD Memory Card slot.



- You cannot play back an SDHC Memory Card if the TV model does not support it.
- Depending on the TV model, pictures may not be displayed on the full screen.
- Motion pictures cannot be played back. To play back motion pictures, connect the camera to the TV with the AV cable (supplied).
- You may not be able to play back MultiMediaCards.

Screen Display

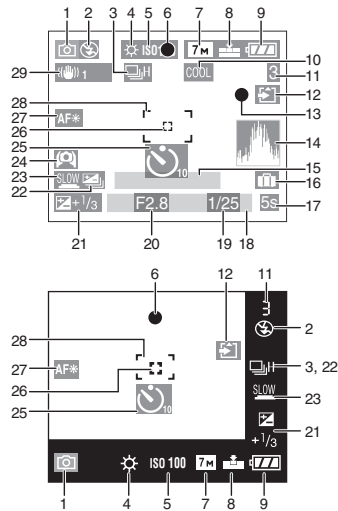

Ⓐ In recording

- 1 Recording mode (P23)
- 2 Flash mode (P39)
- 3 Burst (P47)
U : Audio recording (P62, 76)
- 4 White balance (P71)
- 5 ISO sensitivity (P73)
- 6 Focus (P23)
- 7 Picture size (P75)
 In Motion picture mode (P62)
30fps / 10fps / 30fps / 10fps
 VGA / VGA / QVGA / QVGA (4:3)
30fps / 10fps
 16:9 / 16:9 (16:9)
[] : Jitter alert (P25)
- 9 Battery indication (P13)
- 10 Color effect mode (P79)



- 11 Number of recordable pictures/
Available recording time
e.g. In Motion picture mode
(P62): R1h20m30s
- 12 Card access indication (P16)
- 13 Recording state
- 14 Histogram (P37)
- 15 Age (P56)
 • This is displayed for about 5 seconds
when the camera is turned on in baby
mode etc.

 Number of days that have passed since
the travel date (P57)
 • This is displayed for about 5 seconds if
the camera is turned on when the
travel date is set etc.
- 16 Travel date (P57)
- 17 Elapsed recording time (P62)
- 18 Current date and time
 • This is displayed for about 5 seconds
when the camera is turned on, after
setting the clock and after switching
from playback mode to recording
mode.

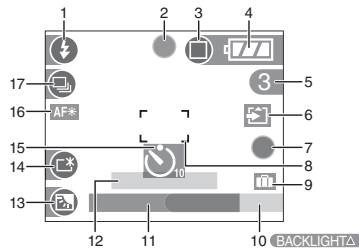
 Zoom (P28)/Extended optical zoom
(P29)/Digital zoom (P30)
EZ W T 1X
- 19 Shutter speed (P23)
I ISO : Intelligent ISO (P73)
- 20 Aperture value (P23)
- 21 Exposure compensation (P44)
- 22 Auto bracket (P45)
- 23 Slow shutter (P78)
- 24 High angle mode (P38)/
* : Power LCD (P38)
- 25 Self-timer mode (P43)
- 26 Spot AF area (P77)
- 27 AF assist lamp (P78)
- 28 AF area (P23)
- 29 Optical image stabilizer (P46)



Ⓑ Recording in simple mode

- 1 Flash mode (P39)
- 2 Focus (P23)
- 3 Picture mode (P26)
: Jitter alert (P25)
- 4 Battery indication (P13)
- 5 Number of recordable pictures
- 6 Card access indication (P16)
- 7 Recording state
- 8 AF area (P23)
- 9 Travel date (P57)
- 10 Operation for backlight compensation (P27)
- 11 Current date and time
 - This is displayed for about 5 seconds when the camera is turned on, after setting the clock and after switching from playback mode to simple mode.
- Zoom (P28)/Extended optical zoom (P29)

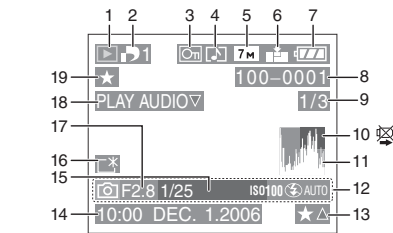
- 12 Number of days that have passed since the travel date (P57)
 - This is displayed for about 5 seconds if the camera is turned on when the travel date is set etc.
- 13 Backlight compensation (P27)
- 14 Power LCD (P38)
- 15 Self-timer mode (P43)
- 16 AF assist lamp (P78)
- 17 Burst (P47)



© In playback

- 1 Playback mode (P32)
- 2 Number of DPOF prints (P85)
- 3 Protected picture (P87)
- 4 Picture with audio/Motion pictures (P67)
- 5 Picture size (P75)
- 6 Quality (P75)
 - In Motion picture mode (P67)
 - 30fps_VGA / 10fps_VGA / 30fps_QVGA / 10fps_QVGA (4:3)
 - 30fps_16:9 / 10fps_16:9 (16:9)
 - In Simple mode (P26)
 - : ENLARGE
 - : 4"×6"/10×15cm
 - : E-MAIL
- 7 Battery indication (P13)
- 8 Folder/File number (P93)
- 9 Picture number/Total pictures

- 10 Cable disconnection warning icon (P98)
 - This is displayed when printing using a printer supporting PictBridge. (Depending on the printer, the icon may not be displayed.)
- Motion picture recording time (P67): 1h20m30s
- 11 Histogram (P37)
- 12 Recording information
- 13 Favorites settings (P82)/Elapsed playback time (P67): 1h20m30s
- 14 Recorded date and time
- 15 Age (P56)
- 16 Power LCD (P38)
- 17 Number of days that have passed since the travel date (P57)
- 18 Audio playback (P67)
 - PLAY MOTION PICTURE : In motion picture mode (P67)
- 19 Favorites (P82)

Cautions for Use

■ Optimal use of the camera

Take care not to drop or knock the unit or put a lot of pressure on it.

- We strongly recommend you do not leave the camera in your pants pocket when you sit down or forcefully insert it into a full or tight bag etc. Damage to the LCD monitor or personal injury may result.
- Take care not to knock or drop the bag/case that you inserted the camera in as the shock may cause damage to the camera, lens or LCD monitor.
- Do not attach any other items to the wrist strap that's included with your camera. While being stored, that item can rest against the LCD monitor and damage it.
- Do not use a paper bag as it can easily rip causing the camera to fall and be damaged.
- We strongly recommend you purchase a good camera bag/case from your local dealer to protect your camera.

Keep the camera as far away as possible from electromagnetic equipment (such as microwave ovens, TVs, video games etc.).

■ **Card**

Do not leave the card where the temperature is high, where electromagnetic waves or static electricity are easily generated or exposed to direct sunlight.

Do not bend or drop the card.

- The card may be damaged or the recorded content may be damaged or deleted.
- Put the card in the card case or the storage bag after use and when storing or carrying the card.
- Do not allow dirt, dust or water to get into the terminals on the back of the card and do not touch the terminals with your fingers.

■ **Battery**

The battery is a rechargeable lithium ion battery. Its ability to generate power comes from the chemical reaction that takes place inside it. This reaction is susceptible to the surrounding temperature and humidity. If the temperature is too high or too low, the operating time of the battery will become shorter.

Always remove the battery after use.

Store the removed battery in the battery carrying case (supplied).

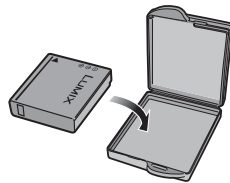

If you drop the battery accidentally, check to see if the body of the battery and the terminals are damaged.

- Inserting a damaged battery in the camera will damage the camera.

Bring charged spare batteries when going out.

- Be aware that the operating time of the battery becomes shorter in low temperature conditions such as at a ski resort.
- When you travel, do not forget to bring the battery charger (supplied) so that you can charge the battery in the country that you are travelling in.

Dispose of unusable battery.

- The battery has a limited life.
- Do not throw the battery into fire because it may cause an explosion.
- The unusable battery should be discarded in accordance with battery recycling laws. Call the RBRC hotline on 1-800-822-8837 for information.

Do not allow battery terminals to come into contact with metal objects (such as necklaces, hairpins etc.).

- This can cause short circuiting or heat generation and you may be badly burned if you touch a battery.

■ **Charger**

- If you use the battery charger near a radio, the radio reception may be disturbed. Keep the charger 1 m (3.28 feet) or more away from radios.
- The charger may generate whirring sounds when it is being used. This is not a malfunction.
- After using the charger, be sure to disconnect it from the electrical outlet. (A very small amount of current is consumed if it is left connected.)
- Keep the terminals of the charger and battery clean.

Message Display

Confirmation messages or error messages will be displayed on the screen in some cases.

The major messages are described below as examples.

[THIS MEMORY CARD IS PROTECTED]

The Write-Protect switch on the SD Memory Card and the SDHC Memory Card are moved to [LOCK]. Move the switch back to unlock it. (P16, 87, 91)

[NO VALID PICTURE TO PLAY]

Record a picture or insert a card with a recorded picture and then play it.

[THIS PICTURE IS PROTECTED]

Delete or overwrite the picture after canceling the protect setting. (P87)

[THIS PICTURE CANNOT BE DELETED]/ [SOME PICTURES CANNOT BE DELETED]

Pictures not based on the DCF standard cannot be deleted. If you want to delete some pictures, format the card after saving necessary data on a PC etc. (P91)

[NO ADDITIONAL DELETE SELECTIONS CAN BE MADE]

You have exceeded the number of pictures that can be set at once with [MULTI DELETE]. Delete the selected pictures and then select [MULTI DELETE] again to delete any remaining pictures. More than 999 favorites have been set.

[CANNOT BE SET ON THIS PICTURE]/ [CANNOT BE SET ON SOME PICTURES]

If the pictures are not based on the DCF standard, the DPOF print cannot be set.

[MEMORY CARD ERROR FORMAT THIS CARD?]

The card format cannot be recognized by the camera. Format the card again with the camera after saving necessary data on a PC etc. (P91)

[PLEASE TURN CAMERA OFF AND THEN ON AGAIN]

This message appears when the camera is not operating properly. Turn the camera off and on. If the message persists, contact the dealer or your nearest servicenter.

[MEMORY CARD ERROR PLEASE CHECK THE CARD]

An error has occurred accessing the card. Insert the card again.

[READ ERROR PLEASE CHECK THE CARD]

An error has occurred reading the data. Insert the card again. Make sure the card is inserted properly and then play back again.

[WRITE ERROR PLEASE CHECK THE CARD]

An error has occurred writing the data. Turn the camera off and remove the card. Insert the card again and turn the camera on. Make sure the camera is turned off before removing or inserting the card to avoid damage.

[MOTION RECORDING WAS CANCELLED DUE TO THE LIMITATION OF THE WRITING SPEED OF THE CARD]

- When you set the picture quality to [30fpsVGA] or [30fps16:9], we recommend using a high speed SD Memory Card with “10MB/s” or greater displayed on the package.
- Depending on the type of SD Memory Card or SDHC Memory Card, recording may stop in the middle.

[A FOLDER CANNOT BE CREATED]

A folder cannot be created because there are no remaining folder numbers that can be used. (P93)

Format the card after saving necessary data on a PC etc. (P91)

If you execute [NO.RESET] in the [SETUP] menu after formatting, the folder number is reset to 100. (P21)

**[PICTURE IS DISPLAYED FOR 4:3 TV]/
[PICTURE IS DISPLAYED FOR 16:9 TV]**

- The AV cable is connected to the camera. Press [MENU/SET] if you want to delete this message at once.
- Select [TV ASPECT] in the [SETUP] menu to change the TV aspect. (P22)
- This message also appears when the USB connection cable is connected to the camera only.
In this case, connect the other end of the USB connection cable to a PC or a printer. (P92, 95)

Troubleshooting

If you return the menu settings to the initial settings at the time of purchase, the condition may improve.

Select [RESET] in the [SETUP] menu. (P21)

■ Battery and power source

1: The camera cannot be operated even when it is turned on.

- Is the battery inserted correctly?
 - Check the direction of the battery. (P14)
- Is the battery sufficiently charged?
 - Use a battery that has been sufficiently charged.

2: The LCD monitor turns off while the camera is turned on.

- Is power save mode (P20) or economy mode (P20) activated?
 - Press the shutter button halfway to cancel these modes.
- Is the battery exhausted?
 - Use a battery that has been sufficiently charged.

3: The camera turns off immediately after it is turned on.

- Is the battery charge insufficient to operate the camera?
 - Use a battery that has been sufficiently charged.
 - If you leave the camera on, the battery will be exhausted. Turn the camera off frequently by using power save mode (P20) etc.

■ Recording

1: The picture cannot be recorded.

- Is the card inserted?
- Is the mode dial correctly set?
- Is there any memory remaining on the card?
 - Before recording, delete some pictures. (P33)

2: The recorded picture is whitish.

The lens is dirty.

- The picture can become whitish if there is dirt e.g. fingerprints on the lens. If the lens is dirty, turn on the camera, eject the lens barrel (P10) and gently wipe the lens surface with a soft dry cloth.

3: The recorded picture is too bright or dark.

- Check that the exposure is correctly compensated. (P44)

4: 2 or 3 pictures are taken at one time.

- Is auto bracket (P45) or burst mode set? (P47)

5: The subject is not focused properly.

- The focus range varies depending on the recording mode.
 - Rotate the mode dial to set the proper mode for the distance to the subject.
- Is the subject beyond the focus range of the camera? (P25)
- Have you taken a picture with jitter?

6: The recorded picture is blurred. The optical image stabilizer is not effective.

- The shutter speed will become slower and the optical image stabilizer function may not work properly when taking pictures especially in dark places. In this case, we recommend holding the camera firmly with both hands when taking pictures. (P24) When [SLOW SHUTTER] (P78) is set, we recommend using a tripod and the self-timer (P43) when taking pictures.

7: The recorded picture looks rough.

Noise appears on the picture.

- Is the ISO sensitivity high or the shutter speed slow?
 - (ISO sensitivity is set to [AUTO] when the camera is shipped. Therefore, when taking pictures indoors etc. the ISO sensitivity increases.)
 - Decrease the ISO sensitivity. (P73)
 - Set [PICT.ADJ.] to [NATURAL]. (P79)
 - Take pictures in bright places.
- In [HIGH SENS.] (P55) in scene mode, the resolution of the recorded picture decreases slightly because of high sensitivity processing.
 - This is not a malfunction.

8: Motion picture recording stops in the middle.

- Are you using a MultiMediaCard?
 - This unit does not support MultiMediaCards.
- When you set the picture quality to [30fpsVGA] or [30fps16:9], we recommend using a high speed SD Memory Card with “10MB/s” or greater displayed on the package.
- Depending on the type of SD Memory Card or SDHC Memory Card, recording may stop in the middle.

9: A vertical line appears on the LCD monitor while recording motion pictures.

- This is a phenomenon called smear. It is a characteristic of CCD and appears when the subject has a bright part. Uneven colors may also appear around the smear. This is not a malfunction. It is recorded in motion pictures but is not recorded on still pictures.

■ **LCD monitor**

1: The LCD monitor sometimes turns off although the camera is turned on.

- Have you set economy mode? (P20)
 - In economy mode, the LCD monitor turns off while the flash is charged.

2: The LCD monitor becomes darker or brighter for a moment.

- This phenomenon appears when you press the shutter button halfway to set the aperture value and does not affect the recorded pictures.

3: The LCD monitor flickers indoors.

- The LCD monitor may flicker for a few seconds after turning the camera on indoors under fluorescent light.
This is not a malfunction.

4: The LCD monitor is too bright or dark.

3: The folder number and the file number are displayed as [—] and the screen turns black.

- Is the picture edited with a PC or recorded with a digital camera from another manufacturer?

This may also happen if the battery is removed immediately after recording or if recording with a exhausted battery.

– Format the data to delete the pictures mentioned above. (P91) (Formatting irretrievably deletes all data including the other pictures. Check the data carefully before formatting.)

4: The picture is displayed with a date different from the actual recording date in calendar playback.

- Was the picture edited with a PC or recorded with a digital camera from another manufacturer?

This kind of picture may be displayed with a date different from the actual recording date in calendar playback. (P65)

- Is the clock in the camera set properly? (P19)

For example, if the clock setting on the camera is different from the date and time set on the PC and you acquire pictures recorded with the camera to the PC and then write them back to the card, the pictures may be displayed with dates different from the actual recording dates in calendar playback etc.

■ TV, PC and printer

1: The picture does not appear on the television.

- Is the camera connected to the TV correctly?
- Set the TV input to external input mode.

2: The display areas on the TV screen and the camera's LCD monitor are different.

Depending on the TV model, the area display may be smaller so the picture may be stretched horizontally or vertically and the top and bottom or left and right of the picture may be cut off when it is displayed. This is due to the TV specifications and is not a malfunction.

3: The motion pictures cannot be played back on a TV.

- Are you trying to play back the motion pictures by directly inserting the card in the card slot of the TV?
 - Connect the camera to the TV with the AV cable (supplied) and then play back the pictures on the camera. (P99)

4: The picture cannot be transferred when the camera is connected to a PC.

- Is the camera connected to the PC correctly?
- Is the camera recognized by the PC correctly?

5: The card is not recognized by the PC.

- Disconnect the USB connection cable. Connect it again while the card is inserted in the camera.

6: The picture cannot be printed when the camera is connected to a printer.

- Does the printer support PictBridge?
 - You cannot print pictures with printers which do not support PictBridge. (P95)
- Reset the mode to []. (P95)

7: The ends of the pictures are cut at printing.



- When using a printer with a trimming or borderless printing function, cancel this function before printing. (For details, refer to the operating instructions for the printer.)
- When you order photo studios to print pictures, ask the photo studio if the pictures can be printed with both ends.

8: The picture is not displayed fully on the TV.

- Set the aspect of the TV on the camera. (P22)

■ Others

1: An unreadable language was selected by mistake.

- Press [MENU/SET], select the [SETUP] menu icon [] and then select the [] icon to set the desired language. (P22)

2: The setting for the auto review function is disabled.

- Are you taking pictures using auto bracket (P45)? Is the camera in burst mode (P47) or motion picture mode [] (P62) or [SELF PORTRAIT] (P52)? Is [AUDIO REC.] set to [ON] (P76)?
 - In these cases, you cannot set the auto review function in the [SETUP] menu.

3: A red lamp sometimes turns on when the shutter button is pressed halfway.

- In dark places, the AF assist lamp (P78) lights red to make it easier to focus on a subject.

4: The AF assist lamp does not turn on.

- Is [AF ASSIST LAMP] on the [REC] mode menu set to [ON]? (P78)
- Are you taking pictures in dark places?
 - The AF assist lamp does not turn on in bright places.
- The AF assist lamp does not turn on when [SCENERY] (P50), [NIGHT SCENERY] (P51) [SELF PORTRAIT] (P52), [FIREWORKS] (P53) or [AERIAL PHOTO] (P55) in scene mode is selected.

5: The camera becomes warm.

- The surface of the camera may become warm during use. This does not affect the performance or quality of the camera.

6: The lens clicks.

- When the brightness changes due to zoom or camera movement etc., the lens may click and the picture on the screen may drastically change. However, the picture is not affected. The sound is caused by the automatic adjustment of the aperture. This is not a malfunction.

7: The clock is reset.

- If you do not use the camera for a long time, the clock may be reset. When the message [PLEASE SET THE CLOCK] appears, set the clock again. (P17)
- When you take a picture before setting the clock, [0:00 0. 0. 0] is recorded.

8: Colors appear on the picture which were not found in the actual scene.

- Depending on the zoom magnification, the picture may have some colored fringes around the subject. This is called chromatic aberration and may be more visible when recording distant subjects. However this is not a malfunction.

9: The file numbers are not recorded consecutively.

- When you perform an operation after taking a certain action, the pictures may be recorded in folders with different numbers from the ones used prior to the operation. (P93)

10: The file numbers are recorded in ascending order.

- If the battery is inserted or removed when the camera is not turned off, the recorded folder numbers are lost. However if you turn the camera on again and record pictures, the recorded folder numbers are different from the prior recorded folder numbers.

11: The picture is displayed in black.

- Pictures edited or rotated with a PC may be displayed in black in playback mode (P32), multi playback (P64) and calendar playback (P65).

Number of Recordable Pictures and Available Recording Time

- The number of recordable pictures and the available recording time are an approximation. (These vary depending on the recording conditions and the type of card.)
- The number of recordable pictures varies depending on the subjects.

■ Number of recordable pictures

| Aspect ratio | | 4:3 | | | | | |
|--------------|--------|--------------------------------|------|-----------------------------------|------|-----------------------------------|------|
| Picture size | | 7M (7M): (3072×2304 pixels) | | 5M (5M EZ): (2560×1920 pixels) | | 3M (3M EZ): (2048×1536 pixels) | |
| Quality | | | | | | | |
| Card | 16 MB | 3 | 7 | 5 | 10 | 8 | 16 |
| | 32 MB | 7 | 16 | 11 | 23 | 18 | 36 |
| | 64 MB | 16 | 34 | 24 | 48 | 38 | 75 |
| | 128 MB | 35 | 69 | 50 | 99 | 78 | 150 |
| | 256 MB | 68 | 135 | 98 | 190 | 150 | 290 |
| | 512 MB | 135 | 270 | 195 | 380 | 300 | 590 |
| | 1 GB | 270 | 540 | 390 | 770 | 600 | 1180 |
| | 4 GB | 1090 | 2150 | 1560 | 3010 | 2410 | 4640 |

| Aspect ratio | | 4:3 | | | | | |
|--------------|--------|-----------------------------------|------|----------------------------------|-------|-------------------------------------|-------|
| Picture size | | 2M (2M EZ): (1600×1200 pixels) | | 1M (1M EZ): (1280×960 pixels) | | 0.3M (0.3M EZ): (640×480 pixels) | |
| Quality | | | | | | | |
| Card | 16 MB | 13 | 27 | 21 | 40 | 68 | 110 |
| | 32 MB | 29 | 58 | 45 | 85 | 145 | 230 |
| | 64 MB | 61 | 120 | 93 | 175 | 290 | 480 |
| | 128 MB | 125 | 240 | 190 | 350 | 600 | 970 |
| | 256 MB | 240 | 470 | 370 | 690 | 1170 | 1900 |
| | 512 MB | 480 | 940 | 730 | 1370 | 2320 | 3770 |
| | 1 GB | 970 | 1880 | 1470 | 2740 | 4640 | 7550 |
| | 4 GB | 3770 | 7090 | 5740 | 10050 | 17240 | 24130 |

| Aspect ratio | | 3:2 | | | | 16:9 | |
|--------------|--------|--------------------------------|------|---|------|------------------------------------|------|
| Picture size | | 6M (6M): (3072×2048 pixels) | | 2.5M / (2.5M EZ): (2048×1360 pixels) | | 5.5M (5.5M): (3072×1728 pixels) | |
| Quality | | | | | | | |
| Card | 16 MB | 3 | 8 | 9 | 18 | 4 | 10 |
| | 32 MB | 8 | 18 | 20 | 40 | 10 | 21 |
| | 64 MB | 19 | 38 | 43 | 83 | 22 | 45 |
| | 128 MB | 39 | 78 | 88 | 165 | 46 | 92 |
| | 256 MB | 77 | 150 | 170 | 330 | 91 | 180 |
| | 512 MB | 150 | 300 | 340 | 650 | 180 | 350 |
| | 1 GB | 300 | 600 | 680 | 1310 | 360 | 710 |
| | 4 GB | 1230 | 2410 | 2680 | 5020 | 1450 | 2800 |

| Aspect ratio | | 16:9 | |
|--------------|--------|-----------------------------------|------|
| Picture size | | 2M (2M EZ): (1920×1080 pixels) | |
| Quality | | | |
| Card | 16 MB | 12 | 25 |
| | 32 MB | 27 | 53 |
| | 64 MB | 57 | 105 |
| | 128 MB | 115 | 220 |
| | 256 MB | 230 | 430 |
| | 512 MB | 450 | 860 |
| | 1 GB | 910 | 1720 |
| | 4 GB | 3540 | 6700 |

■ Available recording time

| Aspect ratio | | 4:3 | | | | 16:9 | |
|-------------------------|--------|--------------|--------------------|--------------------|--------------------|---------------|--------------------|
| Picture quality setting | | 30fps VGA | 10fps VGA | 30fps QVGA | 10fps QVGA | 30fps 16:9 | 10fps 16:9 |
| Card | 16 MB | 6 s | 26 s | 26 s | 1 min 23 s | 5 s | 22 s |
| | 32 MB | 17 s | 59 s | 59 s | 2 min 55 s | 14 s | 50 s |
| | 64 MB | 39 s | 2 min | 2 min | 6 min | 33 s | 1 min 46 s |
| | 128 MB | 1 min 23 s | 4 min 10 s | 4 min 10 s | 12 min 20 s | 1 min 11 s | 3 min 35 s |
| | 256 MB | 2 min 45 s | 8 min 10 s | 8 min 10 s | 24 min | 2 min 20 s | 7 min |
| | 512 MB | 5 min 30 s | 16 min 20 s | 16 min 20 s | 47 min 50 s | 4 min 40 s | 14 min |
| | 1 GB | 11 min | 32 min 50 s | 32 min 50 s | 1 h 35 min 50 s | 9 min 20 s | 28 min 10 s |
| | 2 GB | 22 min 30 s | 1 h 7 min | 1 h 7 min | 3 h 15 min | 19 min 20 s | 57 min 30 s |
| | 4 GB* | 44 min 20 s | 2 h 11 min 50 s | 2 h 11 min 50 s | 6 h 22 min 50 s | 38 min | 1 h 53 min 10 s |

* Motion pictures can be recorded continuously up to 2 GB.

The maximum available recording time for up to 2 GB only is displayed on the screen.



- The numbers inside the thick black lines are the number of recordable pictures in simple mode [♥]. (P26)
- The number of recordable pictures and the available recording time displayed on the LCD monitor may not decrease in order.
- This unit does not support recording motion pictures on MultiMediaCards.
- The extended optical zoom does not work in [HIGH SENS.] (P55) in scene mode so the picture size for [EZ] is not displayed.

Specifications

| | |
|---------------------------------------|--|
| Digital Camera: | Information for your safety |
| Power Source: | DC 5.1 V |
| Power Consumption: | 1.8 W (When recording) 0.9 W (When playing back) |
| Camera effective pixels: | 7,200,000 pixels |
| Image sensor: | 1/2.5" CCD, total pixel number 7,380,000 pixels, Primary color filter |
| Lens: | Optical 3.6× zoom, f=4.6 mm to 16.8 mm (35 mm film camera equivalent: 28 mm to 102 mm)/F2.8 to F5.6 |
| Digital zoom: | Max. 4× |
| Extended optical zoom: | Max. 5.5× |
| Focus: | Normal/Macro, 9-area-focusing/3-area-focusing (High speed)/1-area-focusing (High speed)/1-area-focusing/Spot-focusing |
| Focus range: | Normal: 50 cm (1.64 feet) to ∞ Macro/Simple/Motion picture: 5 cm (0.16 feet) (Wide)/30 cm (0.98 feet) (Tele) to ∞ |
| Shutter system: | Electronic shutter+ Mechanical shutter |
| Burst recording | |
| Burst speed: | 3 pictures/second (High speed), 2 pictures/second (Low speed), Approx. 2 pictures/second (Unlimited) |
| Number of recordable pictures: | Max. 8 pictures (Standard), max. 6 pictures (Fine), Depends on the remaining capacity of the card (Unlimited). (Performance in burst recording is only with SD Memory Card/SDHC Memory Card. MultiMediaCard performance will be less.) |
| Motion picture recording: | 848×480 pixels/640×480 pixels/320×240 pixels (30 or 10 frames/second with audio. The maximum recording time depends on the capacity of the card.) |
| ISO sensitivity: | AUTO/[ISO] 100/200/400/800/1250 [HIGH SENS.] mode: 3200 |
| Shutter speed: | 8 seconds to 1/2000th of a second [STARRY SKY] mode: 15 seconds, 30 seconds, 60 seconds Motion picture mode: 1/30th of a second to 1/20000th of a second |
| White balance: | AUTO/Daylight/Cloudy/Shade/Halogen/White set |

| | |
|------------------------------|---|
| Exposure (AE): | Program AE Exposure compensation (1/3 EV Step, -2 EV to +2 EV) |
| Metering mode: | Multiple |
| LCD monitor: | 3.0" low-temperature polycrystalline TFT LCD (Approx. 230,000 pixels) (field of view ratio about 100%) |
| Flash: | Flash range: [ISO AUTO] Approx. 60 cm (1.97 feet) to 4 m (13.1 feet) (Wide) AUTO, AUTO/Red-eye reduction, Forced ON (Forced ON/ Red-eye reduction), Slow sync./Red-eye reduction, Forced OFF |
| Microphone: | Monaural |
| Speaker: | Monaural |
| Recording media: | SD Memory Card/SDHC Memory Card/MultiMediaCard (Still pictures only) |
| Picture size | |
| Still picture: | When the aspect ratio setting is [4:3] 3072×2304 pixels, 2560×1920 pixels, 2048×1536 pixels, 1600×1200 pixels, 1280×960 pixels, 640×480 pixels When the aspect ratio setting is [3:2] 3072×2048 pixels, 2048×1360 pixels When the aspect ratio setting is [16:9] 3072×1728 pixels, 1920×1080 pixels |
| Motion pictures: | When the aspect ratio setting is [4:3] 640×480 pixels, 320×240 pixels When the aspect ratio setting is [16:9] 848×480 pixels |
| Quality: | Fine/Standard |
| Recording file format | |
| Still Picture: | JPEG (based on "Design rule for Camera File system", based on "Exif 2.21" standard)/DPOF corresponding |
| Picture with audio: | JPEG (based on "Design rule for Camera File system", based on "Exif 2.21" standard)+"QuickTime" (picture with audio) |
| Motion pictures: | "QuickTime Motion JPEG" (motion pictures with audio) |
| Interface | |
| Digital: | "USB 2.0" (Full Speed) |
| Analog | |
| video/audio: | NTSC/PAL Composite (Switched by menu), Audio line output (monaural) |

Terminal

| | |
|-------------------------------|--|
| [DIGITAL/AV OUT]: | Dedicated jack (8 pin) |
| [DC IN]: | Dedicated jack |
| Dimensions: | Approx. 97.7 mm (W)×57.1 mm (H)×25.1 mm (D) [3 7/8" (W)×2 1/4" (H)×1" (D)] (excluding the projecting part) |
| Mass: | Approx. 151 g/5.33 oz (excluding card and battery), Approx. 179 g/6.31 oz (with card and battery) |
| Operating temperature: | 0 °C to 40 °C (32 °F to 104 °F) |
| Operating humidity: | 10% to 80% |

Battery Charger**(Panasonic DE-A11B):** Information for your safety

| | |
|----------------|---------------------------------|
| Input: | 110 V to 240 V ~50/60 Hz, 0.2 A |
| Output: | CHARGE 4.2 V --- 0.8 A |

Equipment mobility: Movable**Battery Pack (lithium-ion)****(Panasonic CGA-S005A):** Information for your safety

| | |
|--------------------------|-----------------|
| Voltage/capacity: | 3.7 V, 1150 mAh |
|--------------------------|-----------------|

Others

Digital Accessory System

| Accessories | Figure | Description |
|-------------|---|--------------|
| CGA-S |  | Battery Pack |
| DMW-CX | | Leather Case |

er
recr
• N
out the battery charging time and the number of
odel numbers may vary between countries. Consult your

8
VQT0Y19

Digital Camera Accessory Order Form (For USA Customers)

Please photocopy this form when placing an order.

1. Digital Camera Model # _____

2. Items Ordered

| Accessory # | Description | Price Each | Quantity | Total Price |
|------------------------------|-------------|------------|----------|-------------|
| | | | | |
| | | | | |
| | | | | |
| Subtotal | | | | |
| Your State & Local Sales Tax | | | | |
| Shipping & Handling | | | | 6.95 |
| Total Enclosed | | | | |

3. Method of payment (check one)

- Check of Money Order enclosed (NO C.O.D.SHIPMENTS)
- VISA Credit Card # _____
- MasterCard Expiration Date _____
- Discover Customer Signature _____

Make Check or Money Order to: PANASONIC ACCESSORIES

(Please do not send cash)

4. Shipping information (UPS delivery requires complete street address)

Ship To:

Mr.

Mrs.

Ms.

First _____ Last _____

Phone#:

Day () _____

Street Address _____

Night () _____

City _____ State _____ Zip _____

TO OBTAIN ANY OF OUR DIGITAL CAMERA ACCESSORIES YOU CAN DO ANY OF
THE FOLLOWING:
VISIT YOUR LOCAL PANASONIC DEALER
OR
CALL PANASONIC'S ACCESSORY ORDER LINE AT 1-800-332-5368
[6 AM-5 PM M-F, 6 AM-10:30 AM SAT, PACIFIC TIME]
OR
MAIL THIS ORDER TO: PANASONIC SERVICES COMPANY ACCESSORY ORDER OFFICE
20421 84th Avenue South Kent, WA. 98032

In CANADA, please contact your local Dealer for more information about accessories.

Request for Service Notice (For USA Only)

Please photocopy this form when making a request for service notice.

In the unlikely event this product needs service.

Request for Service Notice: • Please include your **proof of purchase.**
(Failure to do so will delay your repair.)
(USA Only) • To further speed your repair, please provide
an explanation of what wrong with the unit
and any symptom it is exhibiting.

Mail this completed form and your Proof of Purchase along with your unit to:

Panasonic Services Company
410B Airport Road
Elgin, IL 60123-9333
Attn: Digital Camera Repair

Limited Warranty (For USA Only)

PANASONIC CONSUMER ELECTRONICS COMPANY, DIVISION OF
 PANASONIC CORPORATION OF NORTH AMERICA
 One Panasonic Way, Secaucus, New Jersey 07094
 PANASONIC PUERTO RICO, INC.
 Ave. 65 de Infantería, Km. 9.5, San Gabriel Industrial Park, Carolina, Puerto
 Rico 00985

Panasonic Digital Still Camera Limited Warranty

Limited Warranty Coverage

If your product does not work properly because of a defect in materials or workmanship, Panasonic Consumer Electronics Company or Panasonic Puerto Rico, Inc. (collectively referred to as "the warrantor") will, for the length of the period indicated on the chart below, which starts with the date of original purchase ("warranty period"), at its option either (a) repair your product with new or refurbished parts, or (b) replace it with a new or refurbished product. The decision to repair or replace will be made by the warrantor.

| PRODUCT OR PART NAME | PARTS | LABOR |
|--|-------------------------|-------------------------|
| DIGITAL STILL CAMERA (EXCEPT ITEMS LISTED BELOW) | 1 (ONE) YEAR | 90 (NINETY) DAYS |
| CCD | 6 (SIX) MONTHS | 90 (NINETY) DAYS |
| RECHARGEABLE BATTERY PACK (IN EXCHANGE FOR DEFECTIVE BATTERY PACK) | 90 (NINETY) DAYS | NOT APPLICABLE |
| SD MEMORY CARD (IN EXCHANGE FOR DEFECTIVE SD CARD) | 90 (NINETY) DAYS | NOT APPLICABLE |

During the "Labor" warranty period there will be no charge for labor. During the "Parts" warranty period, there will be no charge for parts. You must carry-in or mail-in your product during the warranty period. If non-rechargeable batteries are included, they are not warranted. This warranty only applies to products purchased and serviced in the United States or Puerto Rico. This warranty is extended only to the original purchaser of a new product which was not sold "as is". A purchase receipt or other proof of the original purchase date is required for warranty service.

Carry-In or Mail-In Service

For Carry-In or Mail-In Service in the United States call
1-800-272-7033.

For assistance in Puerto Rico call Panasonic Puerto Rico, Inc.
(787)-750-4300 or fax (787)-768-2910.

This warranty ONLY COVERS failures due to defects in materials or workmanship, and DOES NOT COVER normal wear and tear or cosmetic damage. The warranty ALSO DOES NOT COVER damages which occurred in shipment, or failures which are caused by products not supplied by the warrantor, or failures which result from accidents, misuse, abuse, neglect, mishandling, misapplication, alteration, faulty installation, set-up adjustments, misadjustment of consumer controls, improper maintenance, power line surge, lightning damage, modification, or commercial use (such as in a hotel, office, restaurant, or other business), rental use of the product, service by anyone other than a Factory Servicenter or other Authorized Servicer, or damage that is attributable to acts of God.

THERE ARE NO EXPRESS WARRANTIES EXCEPT AS LISTED UNDER "LIMITED WARRANTY COVERAGE". THE WARRANTOR IS NOT LIABLE FOR INCIDENTAL OR CONSEQUENTIAL DAMAGES RESULTING FROM THE USE OF THIS PRODUCT, OR ARISING OUT OF ANY BREACH OF THIS WARRANTY. (As examples, this excludes damages for lost time, travel to and from the servicer, loss of media or images, data or other memory content. The items listed are not exclusive, but are for illustration only.) **ALL EXPRESS AND IMPLIED WARRANTIES, INCLUDING THE WARRANTY OF MERCHANTABILITY, ARE LIMITED TO THE PERIOD OF THE LIMITED WARRANTY.**

Some states do not allow the exclusion or limitation of incidental or consequential damages, or limitations on how long an implied warranty lasts, so the exclusions may not apply to you.

This warranty gives you specific legal rights and you may also have other rights which vary from state to state. If a problem with this product develops during or after the warranty period, you may contact your dealer or Servicenter. If the problem is not handled to your satisfaction, then write to the warrantor's Consumer Affairs Department at the addresses listed for the warrantor.

PARTS AND SERVICE WHICH ARE NOT COVERED BY THIS LIMITED WARRANTY ARE YOUR RESPONSIBILITY.

Customer Services Directory (For USA Only)

For Product Information, Operating Assistance, Literature Request, Dealer Locations, and all Customer Service inquiries please contact: 1-800-272-7033, Monday-Friday 8:30am-8pm EST.

Web Site: <http://www.panasonic.com/consumersupport>
You can purchase parts, accessories or locate your nearest servicer by visiting our Web Site.

Accessory Purchases

Purchase Parts, Accessories and Instruction Books online for all Panasonic Products by visiting our Web Site at:

<http://www.pasc.panasonic.com>

or, send your request by E-mail to:
npcparts@us.panasonic.com

You may also contact us directly at:
1-800-332-5368 (Phone) 1-800-237-9080 (Fax Only)
(Monday - Friday 9 am to 9 pm, EST.)
Panasonic Services Company 20421 84th Avenue South, Kent, WA 98032
(We Accept Visa, MasterCard, Discover Card, American Express, and Personal Checks)

Product Repairs

Centralized Factory Servicer

MAIL TO : Panasonic Services Company
410B Airport Road
Elgin, IL 60123-9333
Attention: Digital Camera Repair

Please carefully pack and ship, prepaid and insured, to the Elgin Centralized Factory Servicer.
Customer's in Puerto Rico, please ship or carry in to location below ("Service in Puerto Rico").

Service in Puerto Rico

Panasonic Puerto Rico, Inc.:
Ave. 65 de Infantería, Km. 9.5, San Gabriel Industrial Park,
Carolina, Puerto Rico 00985
Phone (787) 750-4300 Fax (787) 768-2910

As of May 2006

Index

A

| | |
|--------------------------------|--------|
| AC Adaptor | 92, 95 |
| Aerial Photo Mode | 55 |
| AF Assist Lamp | 78 |
| AF Mode | 77 |
| AF/AE Lock | 24 |
| Aspect Ratio | 74 |
| Aspect Ratio Conversion | 90 |
| Audio Dubbing | 88 |
| Audio Recording | 62, 76 |
| Auto Bracket | 45 |
| Auto Review | 19 |
| Auto White Balance | 71 |
| Available Recording Time | 114 |

B

| | |
|-------------------------------------|-----|
| Baby Mode | 56 |
| Backlight Compensation | 27 |
| Battery Carrying Case | 104 |
| Beach Mode | 54 |
| Brightness of the LCD Monitor | 19 |
| Built-in Flash | 39 |
| Burst Mode | 47 |

C

| | |
|--|------------|
| Calendar Playback | 65 |
| Candle Light Mode | 53 |
| Card Access Indication | 16 |
| Charger | 104 |
| Charging | 13 |
| Clock Set | 17, 19, 79 |
| Color Effect | 79 |
| Condensation | 5 |
| Creating still pictures from a motion picture | 68 |

D

| | |
|--|------------|
| Date Printing | 86, 97, 98 |
| Deleting Pictures | 33 |
| Demonstration of the Optical Image Stabilizer | 46 |
| Digital Zoom | 30 |
| DPOF Print Setting | 85 |
| Dual Display | 80 |

E

| | |
|--------------------|----|
| Economy Mode | 20 |
|--------------------|----|

| | |
|-----------------------------|--------|
| Exposure | 25 |
| Exposure Compensation | 44 |
| Extended Optical Zoom | 29 |
| EZ | 29, 75 |

F

| | |
|--------------------------|-------------|
| File Number | 21, 93, 102 |
| Fine | 75 |
| Fireworks Mode | 53 |
| Focus | 25 |
| Folder Composition | 93 |
| Folder Number | 21, 93, 102 |
| Food Mode | 52 |
| Formatting | 91 |

G

| | |
|------------------|--------|
| Guide Line | 19, 36 |
|------------------|--------|

H

| | |
|-----------------------------|----|
| High Angle Mode | 38 |
| High Sensitivity Mode | 55 |
| Histogram | 37 |

I

| | |
|---|----|
| Intelligent ISO sensitivity control | 73 |
| ISO Sensitivity | 73 |

J

| | |
|--------------|----|
| Jitter | 25 |
|--------------|----|

L

| | |
|------------------------|---------|
| Language Setting | 22 |
| Layout | 98 |
| LCD Monitor | 35, 100 |

M

| | |
|---------------------------|----|
| Macro Mode | 48 |
| MANUAL | 82 |
| Motion Picture Mode | 62 |
| Multi Playback | 64 |

N

| | |
|-------------------------------------|---------|
| Night Portrait Mode | 51 |
| Night Scenery Mode | 51 |
| Normal Recording | 23 |
| NO.RESET | 21 |
| NTSC | 22 |
| Number of Prints | 85, 97 |
| Number of Recordable Pictures | 13, 112 |

| | |
|--------------------------------|----|
| O | |
| Operation Tone | 21 |
| Operation Tone Level | 21 |
| Operational Sound | 21 |
| Optical Image Stabilizer | 46 |
| Optical Zoom | 28 |

| | |
|---|----|
| P | |
| PAL | 22 |
| Paper Size | 97 |
| Party Mode | 52 |
| PC | 92 |
| PictBridge | 95 |
| Picture Adjustment | 79 |
| Picture Quality Setting (Motion Picture Mode) | 62 |
| Picture Quality Setting (Simple Mode) | 26 |
| Picture Size | 75 |
| Pictures with Audio | 67 |
| Playback Pictures on TV | 99 |
| Playback Zoom | 66 |
| Playing Back Motion Pictures | 67 |
| Portrait Mode | 50 |
| Power LCD | 38 |
| Power Save | 20 |
| Protect | 87 |

| | |
|---------------|----|
| Q | |
| Quality | 75 |

| | |
|------------------------|----|
| R | |
| Reset of Setting | 21 |
| Resizing | 88 |
| Review | 31 |
| Rotate | 83 |
| Rotate Display | 83 |

| | |
|--------------------------|----|
| S | |
| Scene Menu | 22 |
| Scene Mode | 49 |
| Scenery Mode | 50 |
| Self Portrait Mode | 52 |
| Self-timer | 43 |
| Setting Favorites | 82 |
| Setup Menu | 18 |
| Shutter sound | 21 |
| Shutter Tone | 21 |
| Simple Mode | 26 |
| Slide Show | 81 |
| Slow Shutter | 78 |
| Snow Mode | 55 |

| | |
|------------------------|----|
| Soft Skin Mode | 50 |
| Sports Mode | 50 |
| Spot-focusing | 77 |
| Standard | 75 |
| Starry Sky Mode | 54 |
| Status Indicator | 20 |

| | |
|-------------------|--------|
| T | |
| Travel Date | 19, 57 |
| Trimming | 89 |
| TV Aspect | 22 |

| | |
|----------------------------|--------|
| U | |
| USB Connection Cable | 92, 95 |

| | |
|--------------------------|--------|
| V | |
| Video Output | 22, 99 |
| Volume of Speakers | 21 |

| | |
|-------------------------------------|----|
| W | |
| White Balance | 71 |
| White Balance Fine Adjustment | 72 |
| White Set | 72 |
| World Time | 59 |

| | |
|------------|----|
| Z | |
| Zoom | 28 |

Spanish Quick Use Guide/Guía rápida en español

Ésta es una visión de conjunto que trata del procedimiento para grabar y reproducir las imágenes con la cámara.

1 Cargue la batería.

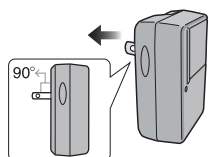

- Cuando se envía la cámara, la batería está sin carga. Cárguela antes del uso.

2 Inserte la batería y la tarjeta.

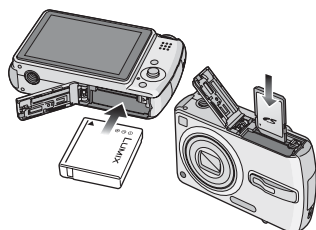

3 Encienda la cámara para tomar las imágenes.

- Ajuste el reloj.

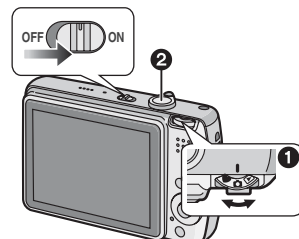

- 1 Ajuste el disco del modo a [📷].
- 2 Pulse el botón del obturador para tomar las imágenes.

4 Reproduzca las imágenes.

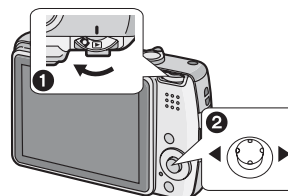

- 1 Ajuste el disco del modo a [▶].
- 2 Elija la imagen que quiere ver.

MEMO



QuickTime and the QuickTime logo are trademarks or registered trademarks of Apple Computer, Inc., used under license.

**Panasonic Consumer Electronics Company,
Division of Panasonic Corporation of North America**

One Panasonic Way, Secaucus, NJ 07094

Panasonic Puerto Rico, Inc.

Ave. 65 de Infantería, Km. 9.5, San Gabriel Industrial Park, Carolina, Puerto Rico 00985

Panasonic Canada Inc.

5770 Ambler Drive, Mississauga, Ontario, L4W 2T3

© 2006 Matsushita Electric Industrial Co., Ltd.



VQT0Y19

F0706Hd0 (3000 A)



Free Manuals Download Website

<http://myh66.com>

<http://usermanuals.us>

<http://www.somanuals.com>

<http://www.4manuals.cc>

<http://www.manual-lib.com>

<http://www.404manual.com>

<http://www.luxmanual.com>

<http://aubethermostatmanual.com>

Golf course search by state

<http://golfingnear.com>

Email search by domain

<http://emailbydomain.com>

Auto manuals search

<http://auto.somanuals.com>

TV manuals search

<http://tv.somanuals.com>