

Panasonic®

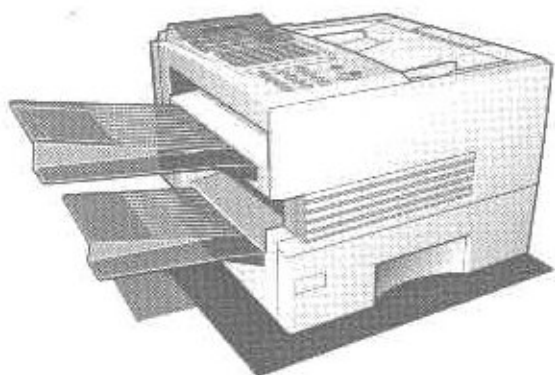

Facsimile Operating Instructions (For Facsimile)

Model No. **UF-890/990**

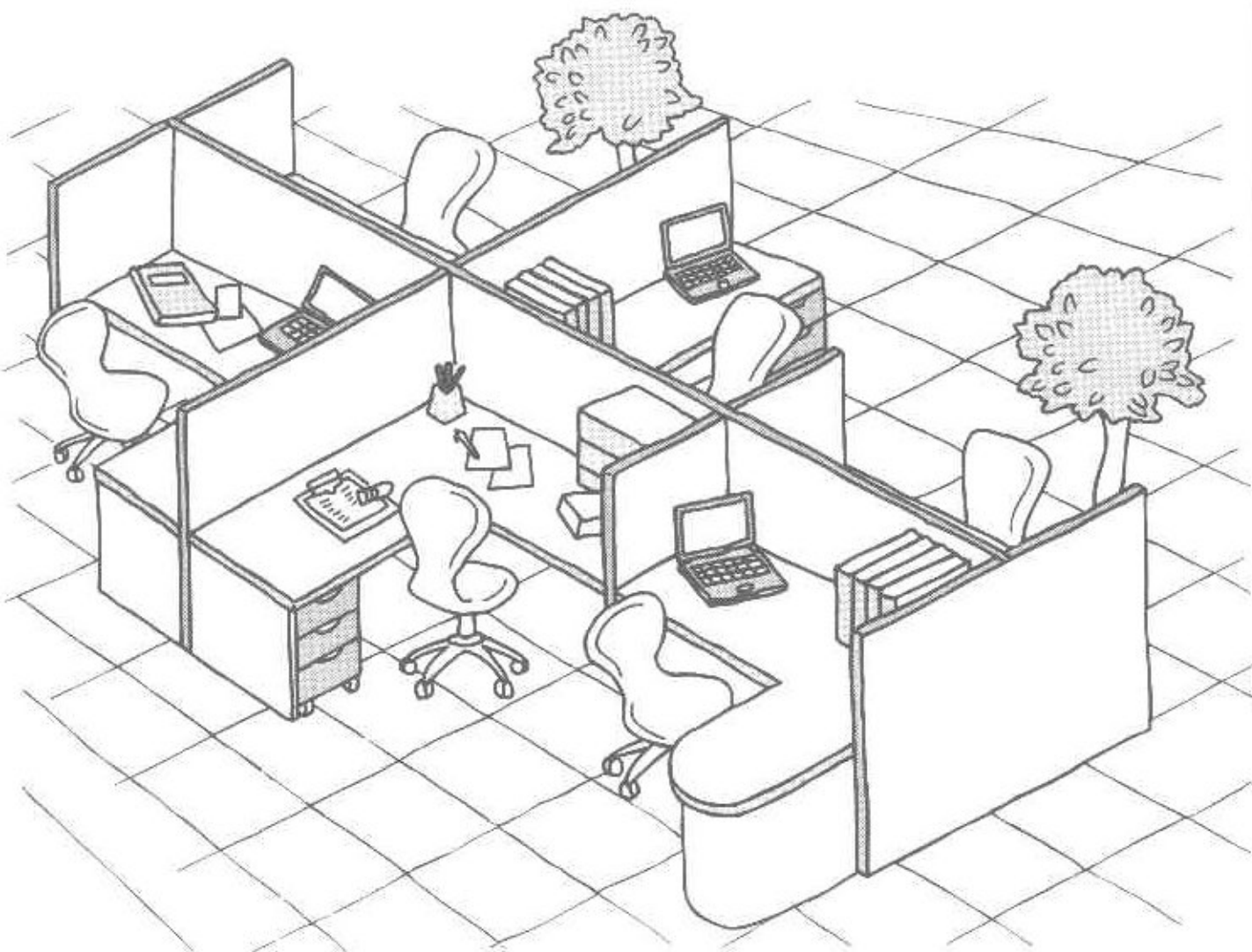

Before operating this equipment, please read these instructions completely and keep these operating instructions for future reference.

English

IMPORTANT INFORMATION

When requesting information, supplies or service always refer to the model and serial number of your machine. The model and serial number plate (Main Name Plate) is located on the machine as shown below. For your convenience, space is provided below to record information you may need in the future.

Model No. _____

Serial No. _____

Date of Purchase _____

Dealer _____

Address _____

Telephone Number

() - _____

Supplies Telephone Number

() - _____

Service Telephone Number

() - _____

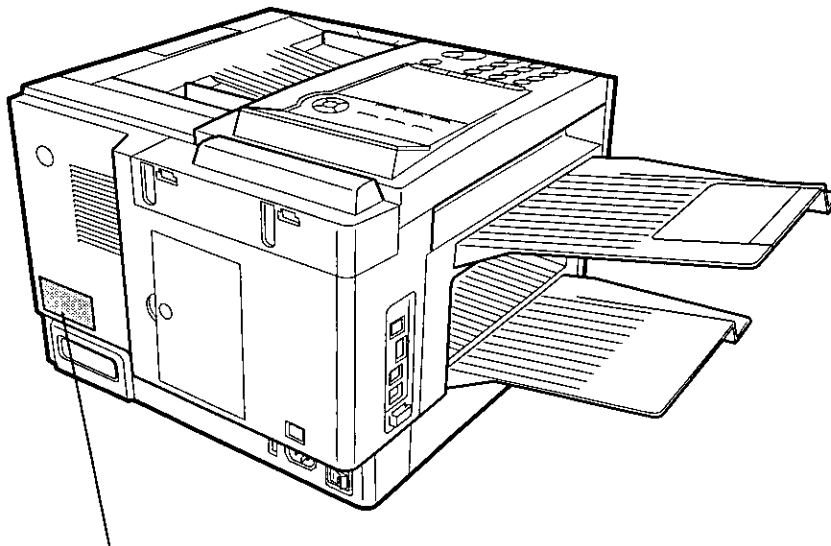

Model and Serial Number

Copyright © 2001-2002 by Matsushita Graphic Communication Systems, Inc.
All rights reserved. Unauthorized copying and distribution is a violation of law. Printed in Japan.
The contents of these Operating Instructions are subject to change without notice.

Table of Contents

Getting to Know Your Machine

Safety Information	9
Precaution	11
Function Key	12
External View	13
Control Panel	14

Installing Your Machine

Main Unit and Accessories	16
Installing the Accessories	17
Installing the Toner Cartridge	18
Loading the Recording Paper	20
<input type="checkbox"/> Paper Specifications	20
Connecting the Telephone Line Cable and Power Cord	22
Setting the Dialing Method (Tone or Pulse)	24
Adjusting the Volume	25
<input type="checkbox"/> Setting the Monitor Volume	25
<input type="checkbox"/> Setting the Ringer Volume	25
User Parameters	26
<input type="checkbox"/> General Description	26
<input type="checkbox"/> Setting the Date and Time	26
<input type="checkbox"/> Setting Your LOGO	27
<input type="checkbox"/> Setting Your Character ID	28
<input type="checkbox"/> Setting Your ID Number (Fax Telephone Number)	29

Programming Your Machine

One-Touch/Abbreviated Dialing Numbers	30
<input type="checkbox"/> Entering One-Touch/Abbreviated Dialing Numbers	30
<input type="checkbox"/> Editing One-Touch/Abbreviated Dialing Numbers	32
<input type="checkbox"/> Printing Out a Directory Sheet	34
Customizing Your Machine	35
<input type="checkbox"/> General Description	35
<input type="checkbox"/> Setting the Fax Parameters	35
<input type="checkbox"/> Fax Parameter Table	36

Table of Contents

Basic Operations

Loading Documents	40
<input type="checkbox"/> Documents You Can Send	40
<input type="checkbox"/> Documents You Cannot Send	40
<input type="checkbox"/> How to Load Documents	41
Basic Transmission Settings	42
<input type="checkbox"/> General Description	42
<input type="checkbox"/> Contrast	42
<input type="checkbox"/> Resolution	42
<input type="checkbox"/> Halftone	43
<input type="checkbox"/> Verification Stamp	43
<input type="checkbox"/> Communication Journal (COMM. JOURNAL)	44
Sending Documents	45
<input type="checkbox"/> General Description	45
<input type="checkbox"/> Memory Transmission	45
<input type="checkbox"/> Direct Transmission	52
<input type="checkbox"/> Voice Mode Transmission	55
<input type="checkbox"/> Transmission Reservation	57
<input type="checkbox"/> Redialing	60
Receiving Documents	61
<input type="checkbox"/> General Description	61
<input type="checkbox"/> Automatic Reception	61
<input type="checkbox"/> Manual Reception	61
<input type="checkbox"/> Print Reduction	62
<input type="checkbox"/> Selecting the Print Reduction Mode	62
<input type="checkbox"/> Receiving Oversize Documents	63
<input type="checkbox"/> Substitute Memory Reception	64
<input type="checkbox"/> Print Collation Mode	64
Making Copies	65

Advanced Features

Batch Transmission	66
<input type="checkbox"/> General Description	66
<input type="checkbox"/> Real-time Batch Transmission	66
<input type="checkbox"/> Delayed Batch Transmission	66
Timer Controlled Communications	67
<input type="checkbox"/> General Description	67
<input type="checkbox"/> Deferred Transmission	67
<input type="checkbox"/> Deferred Polling	68
Polling	69
<input type="checkbox"/> General Description	69
<input type="checkbox"/> Setting the Polling Password	69
<input type="checkbox"/> Preparing to be Polled	70
<input type="checkbox"/> To Poll Documents from Another Station	71

Table of Contents

Program Keys	72
<input type="checkbox"/> General Description.....	72
<input type="checkbox"/> Setting for Group Dialing	72
<input type="checkbox"/> Setting for Deferred Transmission.....	73
<input type="checkbox"/> Setting for Deferred Polling	74
<input type="checkbox"/> Setting for Normal Polling.....	75
<input type="checkbox"/> Setting for One-Touch Key.....	76
<input type="checkbox"/> Changing or Erasing the Program Key Settings.....	77
Edit File Mode	78
<input type="checkbox"/> General Description.....	78
<input type="checkbox"/> Printing a File List.....	78
<input type="checkbox"/> Viewing the Contents of a File List.....	79
<input type="checkbox"/> Changing the Start Time or the Station of a File	80
<input type="checkbox"/> Deleting a File	82
<input type="checkbox"/> Printing Out a File.....	83
<input type="checkbox"/> Adding Documents into a File	84
<input type="checkbox"/> Retry an Incomplete File	85
Access Code.....	86
<input type="checkbox"/> General Description.....	86
<input type="checkbox"/> Setting the Access Code.....	86
<input type="checkbox"/> Operating Your Machine with the Access Code (Restrict all operations)	87
<input type="checkbox"/> Operating Your Machine with the Access Code (Restrict access of Fax Parameters and Journal)	87
Receive To Memory.....	88
<input type="checkbox"/> General Description.....	88
<input type="checkbox"/> Setting the RCV To Memory Password.....	88
<input type="checkbox"/> Setting RCV To Memory	88
<input type="checkbox"/> Printing Out Documents	89
Distinctive Ring Detector (DRD)	90
<input type="checkbox"/> General Description.....	90
Fax Cover Sheet	91
<input type="checkbox"/> General Description.....	91
<input type="checkbox"/> To use the Fax Cover Sheet	91
PIN Code Access.....	93
<input type="checkbox"/> General Description.....	93
<input type="checkbox"/> Selecting the Access Method (Prefix or Suffix)	93
<input type="checkbox"/> Dialing with a PIN Code	94
Fax Forward	95
<input type="checkbox"/> Setting Fax Forward	95
File Transmission.....	96
<input type="checkbox"/> General Description.....	96
<input type="checkbox"/> Storing the Document(s)	96
<input type="checkbox"/> Sending the Stored Document(s).....	97
<input type="checkbox"/> Deleting the Stored Document(s).....	98
<input type="checkbox"/> Printing the Stored Document(s).....	98

Table of Contents

Department Code	99
<input type="checkbox"/> General Description	99
<input type="checkbox"/> Setting the Department Code	100
<input type="checkbox"/> Changing or Erasing the Department Code	101
<input type="checkbox"/> Sending Document with Department Code	103
<input type="checkbox"/> Sending Document with Department Code (Voice Mode Transmission)	104
<input type="checkbox"/> Printing a Department Code List	105
<input type="checkbox"/> Printing a Department Code Journal	106
Multiple LOGO	108
<input type="checkbox"/> General Description	108
<input type="checkbox"/> Setting the Multiple LOGO	108
<input type="checkbox"/> Changing or Erasing the Multiple LOGO	109
<input type="checkbox"/> Sending Document with Multiple LOGO	110
<input type="checkbox"/> Printing a Multiple Logo List	111

Network Features

Selective Reception	112
<input type="checkbox"/> General Description	112
<input type="checkbox"/> Setting the Selective Reception	112
Password Communications	113
<input type="checkbox"/> General Description	113
<input type="checkbox"/> Compatibility with Other Machines	113
<input type="checkbox"/> Setting Password Transmission	114
<input type="checkbox"/> Setting Password Reception	115
<input type="checkbox"/> Using Password Transmission	116
<input type="checkbox"/> Using Password Reception	117
Confidential Mailbox	118
<input type="checkbox"/> General Description	118
<input type="checkbox"/> Confidential Mailbox	118
<input type="checkbox"/> Sending a Confidential Document to a Remote Station's Mailbox	119
<input type="checkbox"/> Polling a Confidential Document from a Remote Station's Mailbox	120
<input type="checkbox"/> Receiving a Confidential Document to Your Machine's Mailbox	121
<input type="checkbox"/> Storing a Confidential Document in Your Machine's Mailbox	122
<input type="checkbox"/> Printing Out a Confidential Document from Your Machine's Mailbox	123
<input type="checkbox"/> Deleting a Confidential Document Stored in Your Machine's Mailbox	124
Sub-Addressing	125
<input type="checkbox"/> General Description	125
<input type="checkbox"/> To set the Sub-address into a One-Touch/ABBR. Dialing Numbers	126
<input type="checkbox"/> To send a Document with Sub-address	127

Table of Contents

Print out Journals and Lists

Journals and Lists	128
<input type="checkbox"/> General Description.....	128
<input type="checkbox"/> Transaction Journal.....	128
<input type="checkbox"/> Individual Transmission Journal (IND. XMT JOURNAL).....	129
<input type="checkbox"/> Communication Journal (COMM. JOURNAL).....	132
<input type="checkbox"/> One-Touch/Abbreviated and Directory Search List.....	134
<input type="checkbox"/> Program List.....	137
<input type="checkbox"/> FAX Parameter List.....	138

Problem Solving

Troubleshooting	139
<input type="checkbox"/> Information Codes.....	141
<input type="checkbox"/> Clearing a Recording Paper Jam.....	144
<input type="checkbox"/> Clearing a Document Jam.....	145
<input type="checkbox"/> Cleaning the Document Scanning Area.....	146
<input type="checkbox"/> Cleaning the Printer Roller.....	147
<input type="checkbox"/> Adjusting the Automatic Document Feeder (ADF).....	148
<input type="checkbox"/> Verification Stamp.....	149
<input type="checkbox"/> Replacing the Lithium Battery.....	150
<input type="checkbox"/> Checking the Telephone Line.....	151

Appendix

Specifications	152
Recording Paper Specifications	155
Options and Supplies	156
<input type="checkbox"/> Installing the Memory Card (Flash Memory Card and/or DRAM Card).....	158
FCC Notice for User in USA	159
Notice to User in Canada	161
Glossary	163
ITU-T Image No. 1	166
Index	167

memo

Safety Information

⚠ WARNING denotes a potential hazard that could result in serious injury or death.

- TO PREVENT FIRE OR SHOCK, DO NOT EXPOSE THIS PRODUCT TO RAIN OR ANY TYPE OF MOISTURE.
- TO MINIMIZE THE POSSIBILITY OF SHOCK OR DAMAGE TO THE MACHINE, IT MUST BE PROPERLY GROUNDED.
- THIS PRODUCT UTILIZES A LASER. ONLY QUALIFIED SERVICE PERSONNEL SHOULD ATTEMPT TO SERVICE THIS DEVICE DUE TO POSSIBLE EYE INJURY. CAUTION-USE OF CONTROLS OR ADJUSTMENTS OR PERFORMANCE OF PROCEDURES OTHER THAN THOSE SPECIFIED HEREIN MAY RESULT IN HAZARDOUS RADIATION EXPOSURE.



- THE MAIN PLUG ON THIS EQUIPMENT MUST BE USED TO DISCONNECT THE MAIN POWER. PLEASE ENSURE THAT THE SOCKET OUTLET IS INSTALLED NEAR THE EQUIPMENT AND SHALL BE EASILY ACCESSIBLE.
- MAKE SURE THAT THE MACHINE IS INSTALLED IN A SPACIOUS OR WELL VENTILATED ROOM SO AS NOT TO INCREASE THE AMOUNT OF OZONE IN THE AIR. SINCE OZONE IS HEAVIER THAN AIR, IT IS RECOMMENDED THAT AIR AT FLOOR LEVEL BE VENTILATED.

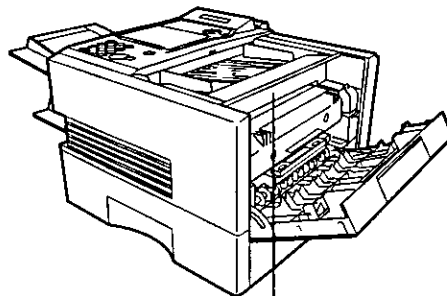
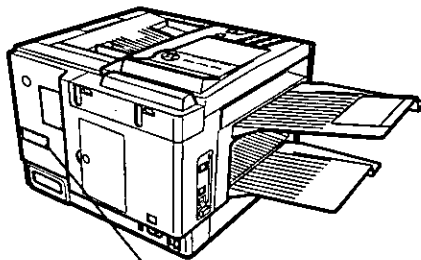

Product complies with DHHS Rules 21
CFR Subchapter J in effect at date
of manufacture.

Manufacturer's name and address Factory ID

- **DANGER** : Invisible laser radiation when open and interlock defeated. AVOID DIRECT EXPOSURE TO BEAM.
- **CAUTION** : Invisible and hazardous laser radiation when interlocks defeated. AVOID EXPOSURE TO BEAM.
- **ATTENTION** : Rayonnement laser invisible dangereux lorsque la sécurité est neutralisée. EXPOSITION DANGEREUSE AU FAISCEAU.
- **VORSICHT** : Unsichtbare Laserstrahlung, wenn Sicherheitsverriegelung überbrückt. NICHT DEM STRAHL AUSSETZEN.
- **PELIGRO** : Cuando se invalida el bloqueo, se producen radiaciones invisibles de láser. EVITÉSE LA EXPOSICIÓN DIRECTA A TALES RAYOS.
- **VARO!** : Näkymätöntä ja vaarallista lasersäteilyä suojalukitus ohitettaessa. Vältä suoraa altistumista säteelle.
- **ADVARSEL** : USYNLIG LASERSTRÅLING NÅR SIKKERHEDSAF-BRYDERE ER UDE AF FUNKTION. UNDGÅ UDSETTELSE FOR STRÅLING.
- **ADVARSEL** : USYNLIG LASERSTRÅLING NÅR SIKKERHEDS-LÅS BRYTES. UNNGÅ EKSPONERING FOR STRÅLEN.
- **WARNING** : OSYNLIG LASERSTRÅLING NÅR SPÄRRAR ÄR URKOPPLADE. STRÅLEN ÄR FARLIG.
- **注意** : 为防止激光照射, 当连接本机时, 请勿暴露于光柱下。
- **주의** : 연결장치가 고장 났을 때에는 눈에 보이지않고 위험한 레이저 방사선이 빛에 직접 닿지않도록 해 주십시오.

FBS6902

Safety Information

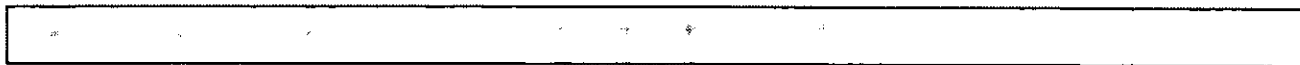

⚠ CAUTION denotes hazards that could result in minor injury or damage to the machine.

- TO REDUCE THE RISK OF SHOCK OR FIRE, USE ONLY NO. 26 AWG OR LARGER TELEPHONE LINE CABLE.
- DISCONNECT ALL POWER TO THE MACHINE BEFORE COVER(S) ARE REMOVED. REPLACE THE COVER(S) BEFORE THE UNIT IS RE-ENERGIZED.
- THIS PRODUCT CONTAINS A LITHIUM BATTERY. DANGER OF EXPLOSION IF BATTERY IS INCORRECTLY REPLACED.
REPLACE ONLY WITH THE SAME OR EQUIVALENT TYPE. DISPOSE OF USED BATTERIES ACCORDING TO THE INSTRUCTIONS OF YOUR LOCAL SOLID WASTE OFFICIALS.

⚠ IMPORTANT SAFETY INSTRUCTIONS

When using your telephone equipment, basic safety precautions should always be followed to reduce the risk of fire, electric shock and injury to persons, including the following:

- DO NOT USE THIS PRODUCT NEAR WATER, FOR EXAMPLE, NEAR A BATH TUB, WASH BOWL, KITCHEN SINK OR LAUNDRY TUB, IN A WET BASEMENT OR NEAR A SWIMMING POOL.
- AVOID USING A TELEPHONE (OTHER THAN A CORDLESS TYPE) DURING AN ELECTRICAL STORM. THERE MAY BE A REMOTE RISK OF ELECTRIC SHOCK FROM LIGHTNING.
- DO NOT USE THE TELEPHONE TO REPORT A GAS LEAK IN THE VICINITY OF THE LEAK.
- USE ONLY THE POWER CORD INDICATED IN THIS MANUAL.

Precaution

⚠ CAUTION denotes hazards that could result in minor injury or damage to the machine.

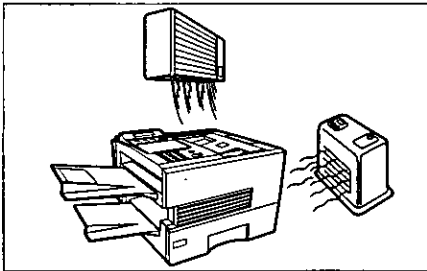

Do not install the machine near heating or an air conditioning unit.

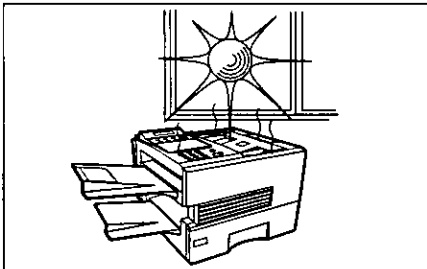

Avoid exposure to direct sunlight.

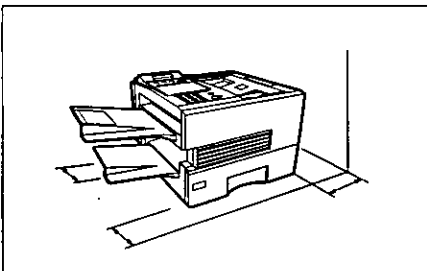

Install the machine on a flat surface, leave at least 4 inches (10 cm) of space between the machine and other objects.

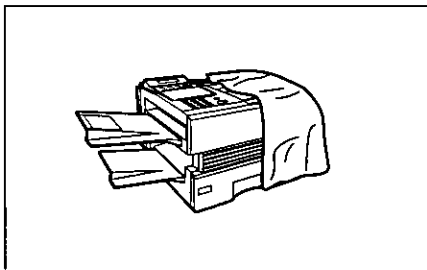

Do not block the ventilation openings.

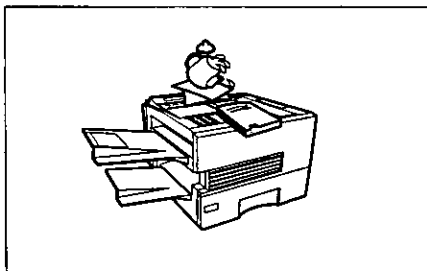

Do not place heavy objects or spill liquids on the machine.

Function Key

Any function can be started by first pressing **FUNCTION** and then enter the function number, or by pressing **▼** or **▲** scroll key repeatedly until the desired function appears on the display.

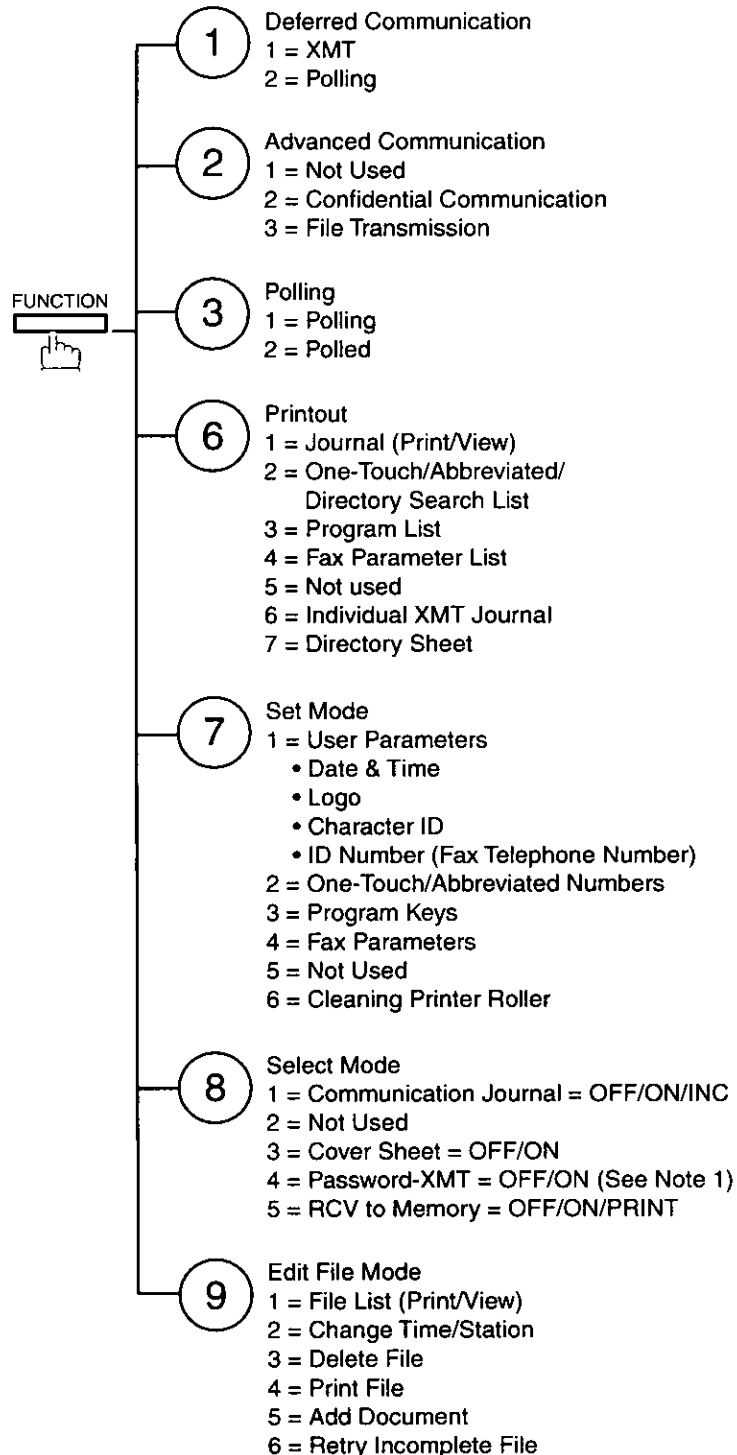

NOTE

1. If Fax Parameter is not preset to the Valid position, which enables you to use the function, the display will not show the function.

External View

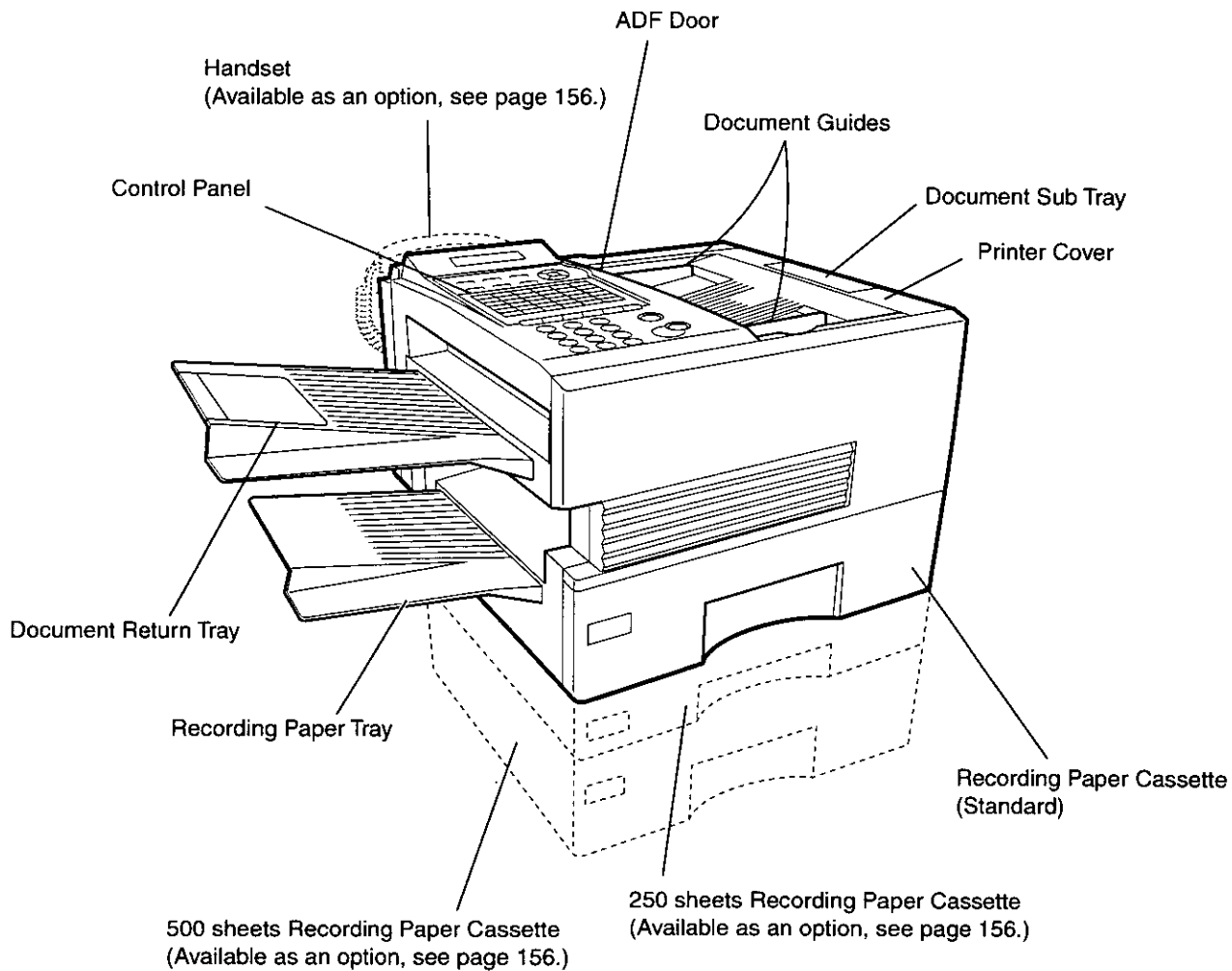

Control Panel

LCD Display

Indicates date and time, or the current operation.

- ON LINE Blinks when the machine is transmitting a document or receiving.
- TONER Blinks when the remaining toner is getting low and lights when the toner is running out. (See page 18)
- ALARM Lights when trouble occurs. (See page 139)

One-Touch Keys (01-32)

Used for One-Touch Dialing. (See page 48 and 53)

Program Keys (P1-P8)

Used to record long dialing procedures or Group Dialing Number keys. (See page 72 to 77)

Character Keys

The One-Touch Keys and Program Keys also serve as character and symbol input keys which are used to record your LOGO, character ID and station name. The character key template is printed on the panel under the directory sheet cover.

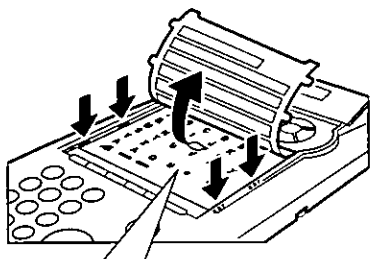

01	A	02	B	03	C	04	D	05	E	06	F
07	G	08	H	09	I	10	J	11	K	12	L
13	M	14	N	15	O	16	P	17	Q	18	R
19	S	20	T	21	U	22	V	23	W	24	X
25	Y	26	Z	27		28		29		30	
31	À	32	Á	P1	Ó	P2	Ü	P3		P4	
P5		P6	SPACE	P7	SYMBOLS	P8	CAPS	LINE SELECT	MONITOR		

- SPACE Used to insert a space while entering LOGO, character ID and station name.
- SYMBOLS Used to enter a symbol (, ' & () ; + - . /) for LOGO, character ID and station name. Use ▼ or ▲ to select the symbols.
- CAPS Used to switch between upper and lower character set.

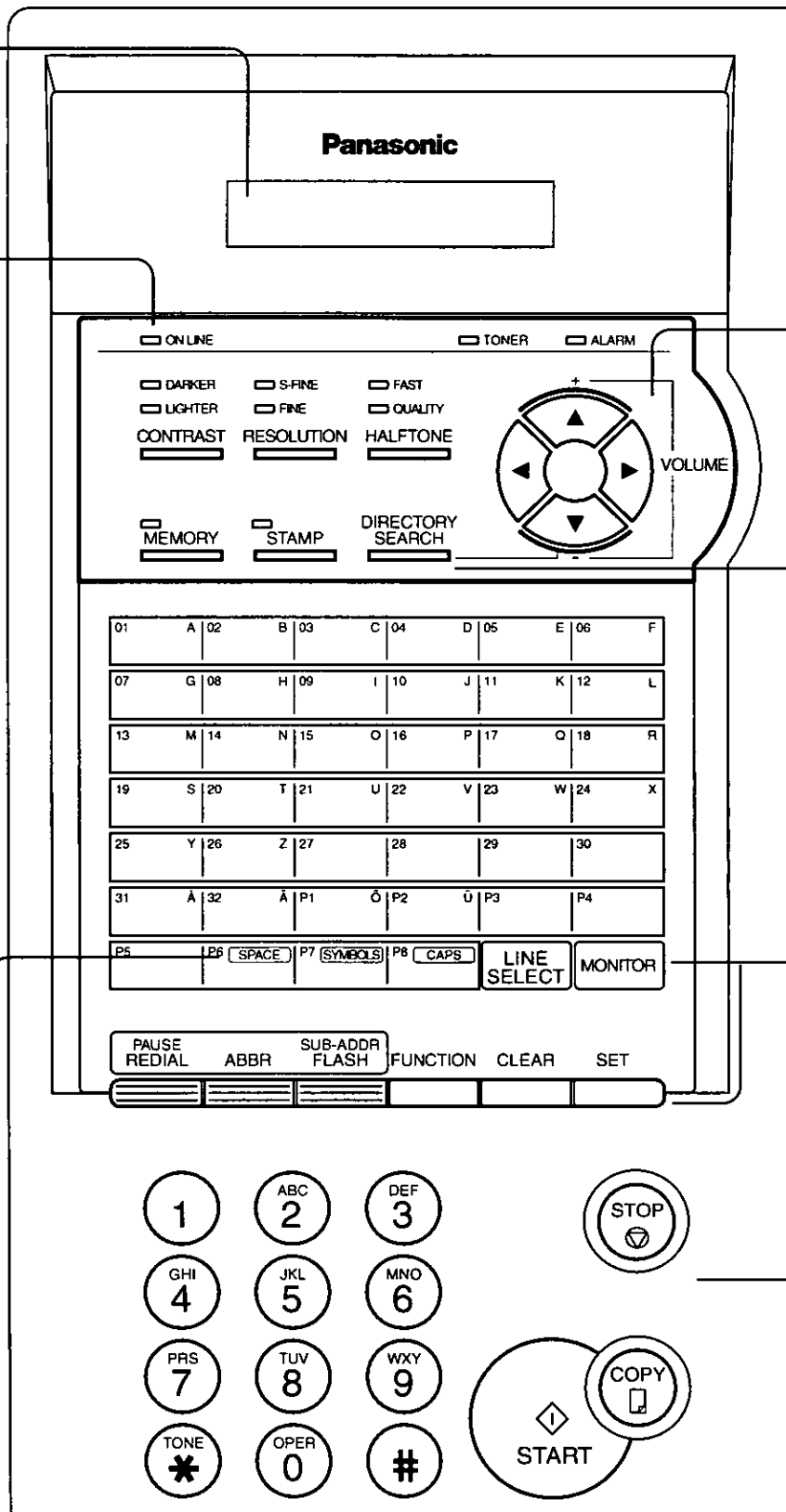

Control Panel

CONTRAST | Used to set Normal, Lighter, or Darker. (See page 42)

RESOLUTION | Used to set Standard, Fine, Super-Fine. (See page 42)

HALFTONE | Provides OFF, QUALITY or FAST settings for halftone documents. (See page 43)

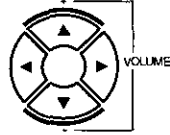

Used for the following:

- Adjust the monitor and ringer volume. (See page 25)
- Move the cursor while entering numbers and characters.
- Search the station name for Directory Search Dialing.
- Confirm the entered station for multi-station communication.
- Select functions.
- Confirm the current communication modes (e.g. Page number, ID, Dialed Telephone number, File number) when the unit is ON LINE.

MEMORY | Used to select either memory or direct communication. (See page 45 to 51)

STAMP | Used to turn the verification stamp ON or OFF. (See page 43)

DIRECTORY SEARCH | Used to search for a station name. (See page 50 and 54)

PAUSE REDIAL | Used to enter a pause when recording or dialing a telephone number, or to redial the last dialed number. (See page 60)

CLEAR | Used to erase the previously entered input.

ABBR | Used to start Abbreviated Dialing. (See page 49 and 53)

SET | Used to set operations.

SUB-ADDR FLASH | Used to separate the Sub-address from the telephone number when dialing, or to access some features of your PBX.

LINE SELECT | Used to select the communication port. Available for UF-990 only if the Optional G3 Communication Port Kit has been installed. (See page 156)

FUNCTION | Used to start or select the function and sub-functions. These functions are explained in detail on page 12.

MONITOR | Used to start On-Hook Dialing. (See page 56)

1 2 3
4 5 6
7 8 9
TONE * 0 #

Used for manual number dialing, recording phone numbers, and numerical entries.



Used to cancel operations. When it is pressed, the machine will return to standby.



Used to make copies. (See page 65)



Used to temporarily change the Dialing Mode to Tone when Pulse mode is set.



Used to start operations.

Main Unit and Accessories

Unpack the carton and check that you have all the accessories illustrated.

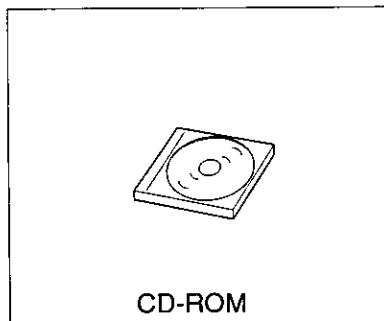
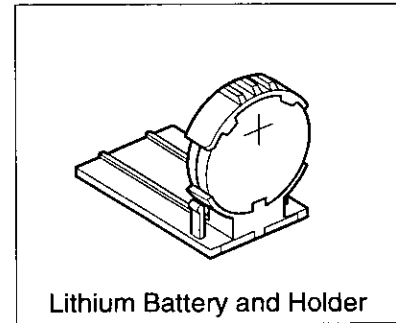
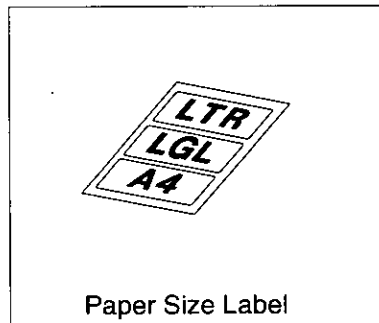
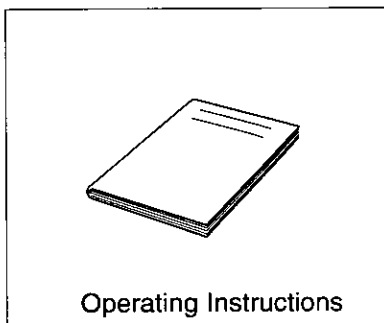
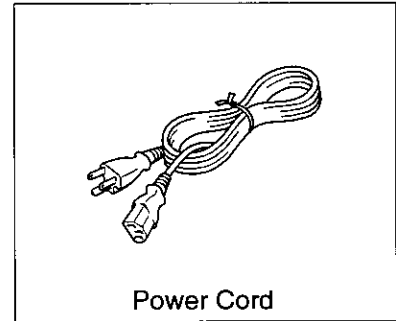
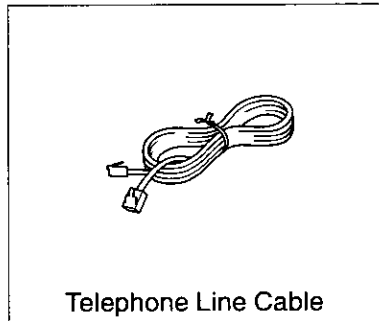
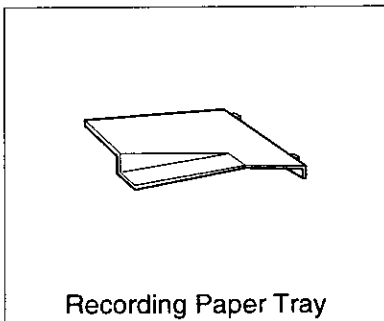
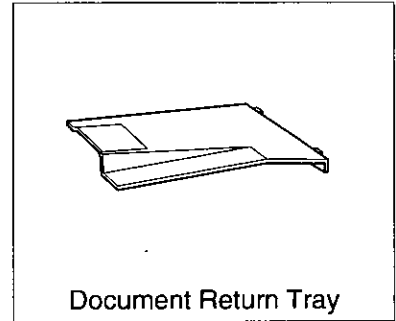
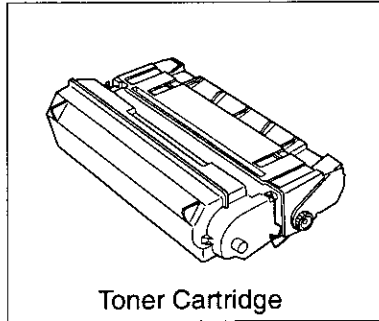
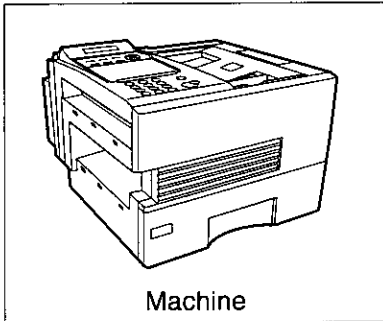

Installing the Accessories

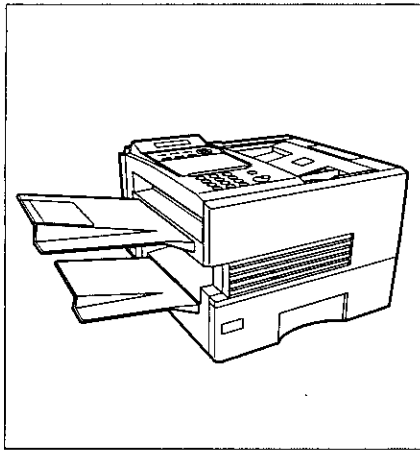

Final Installed View

Installing the Lithium Battery

(This battery is used to backup the clock during power failures, see page 150)

- (1) Open the ADF Door.
- (2) Install the Battery Holder, slide it to the Left until it latches and close the ADF Door.

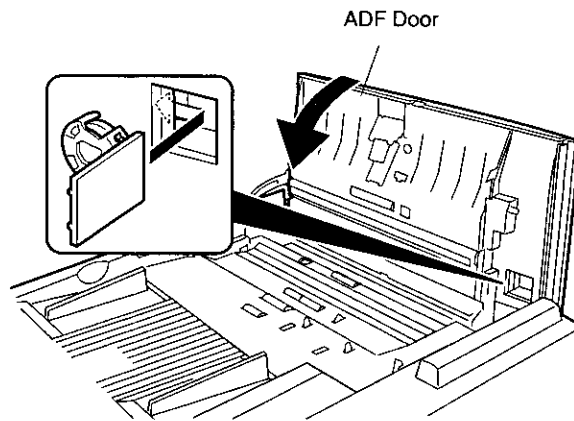

Handset Cradle [Available as an Option]

Hook the projections into the square holes on the machine.

Connect the cable into the HANDSET jack on the machine.

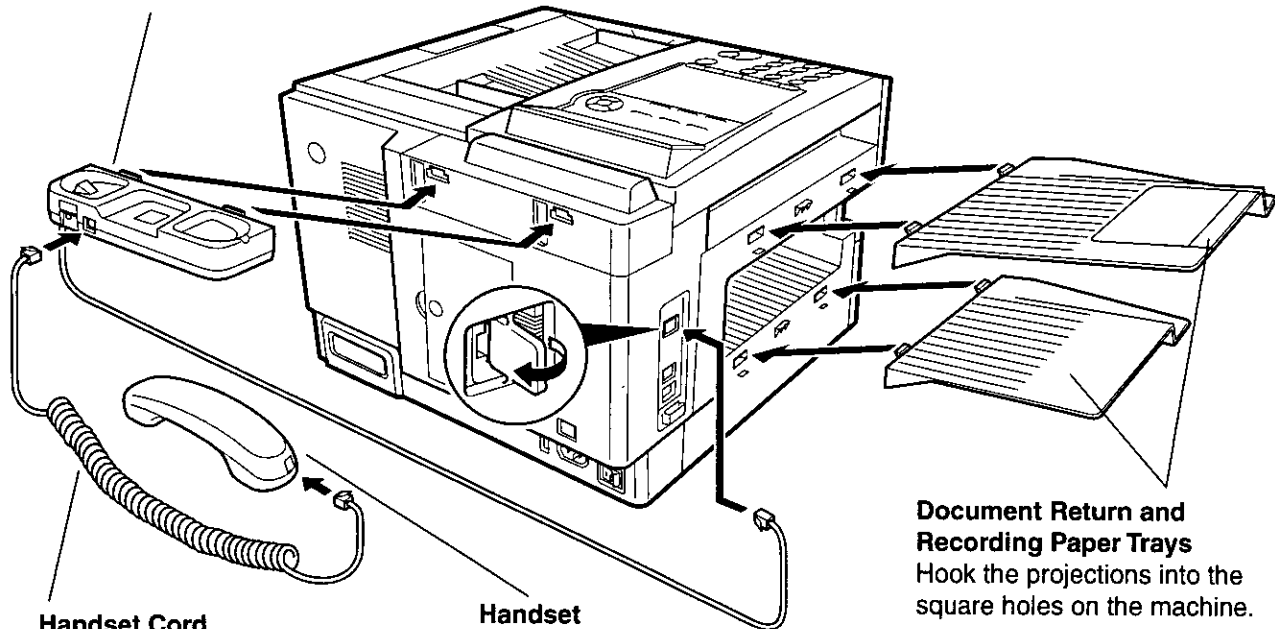

Handset Cord
[Available as an Option]

Handset
[Available as an Option]

Document Return and
Recording Paper Trays
Hook the projections into the
square holes on the machine.

Installing the Toner Cartridge

1

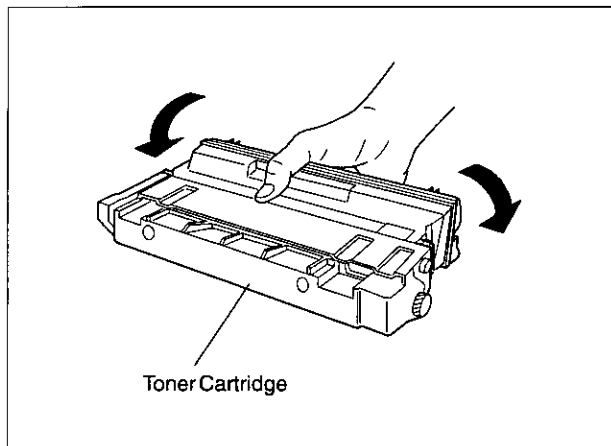

Unpack the Toner Cartridge and rock it back and forth as shown for 5 or 6 times to even the toner inside.

2

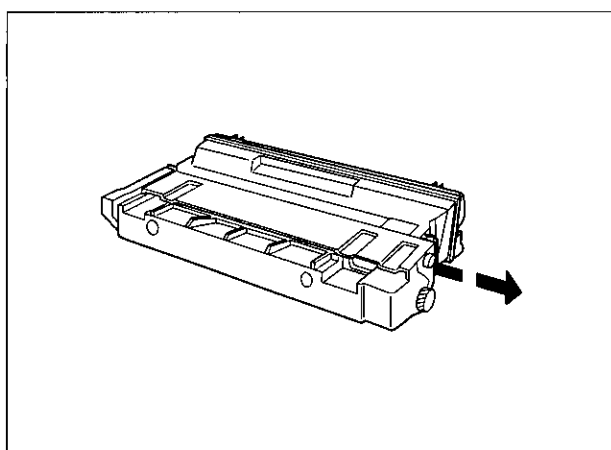

Remove the protective seal.

Note: Pull on the seal slowly and straight out.

3

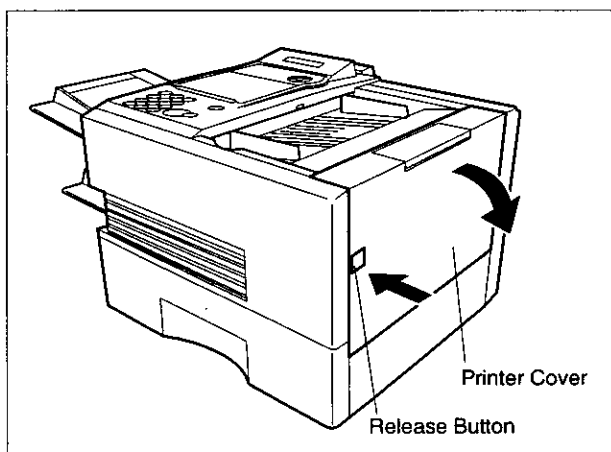

Push the Release Button to open the Printer Cover.

Installing the Toner Cartridge

4

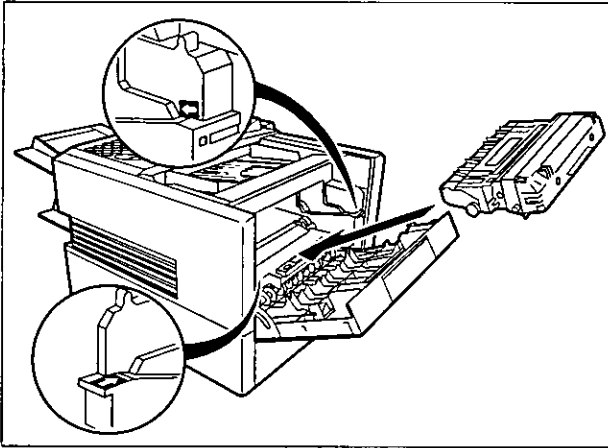

Align the arrow and the projection on both sides as shown and insert the Toner Cartridge into the machine.

5

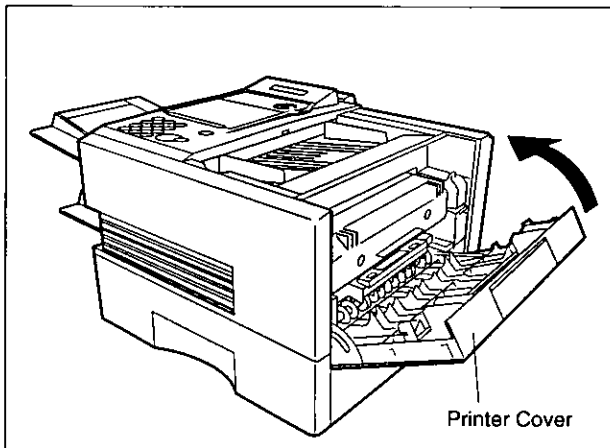

Close the Printer Cover firmly.

6 If you are replacing the Toner Cartridge, it is recommended to clean the Printer Roller to maintain good printing quality. To clean the Printer Roller, follow the procedure on page 147.

Loading the Recording Paper

Paper Specifications

In general, most bond papers will produce excellent results. Most photocopy papers will also work very well. There are many "name" and "generic" brands of paper available. We recommend that you test various papers until you obtain the results you are looking for. For detailed recommended paper specifications, see page 155.

How to Load the Recording Paper

1

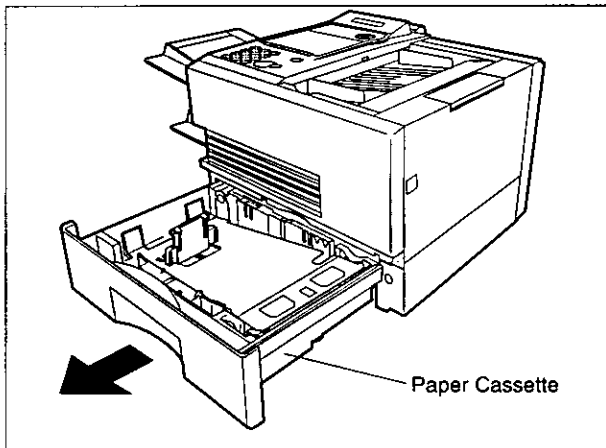

Slide out the Paper Cassette from the machine.

2

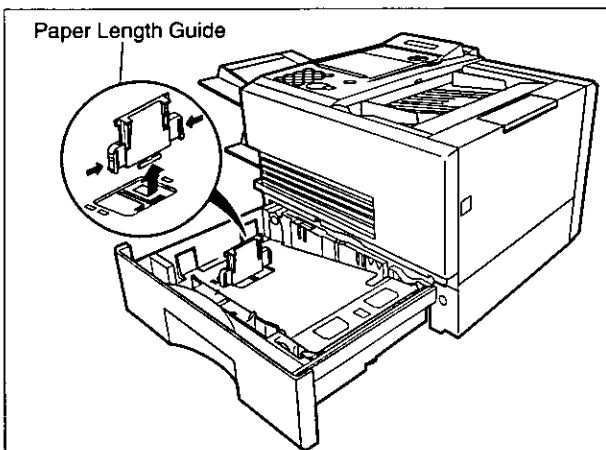

Adjust the Paper Length Guide to the proper paper size (A4, LTR, or LGL).

For LGL size paper, remove the Paper Length Guide and store it in the provided slot in the front left side of the Paper Cassette.

If reloading the same size of paper, skip the step 2 and 3.

3

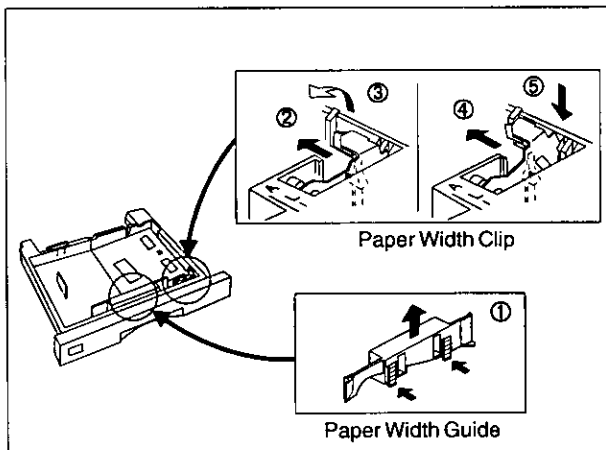

Adjust the Paper Width Guide and Clip to the proper paper (A4, or LTR/LGL).

The factory default for the Paper Width Guide and Clip are on LTR/LGL position. For A4 paper size, adjust by following the steps below.

1. Replace the Paper Width Guide into the proper slot (A4 or LTR/LGL).
2. Release the Paper Width Clip latch.
3. Pull upwards to remove the Paper Width Clip.
4. Replace the Paper Width Clip into the A(A4) or L(LTR/LGL) slot.
5. Push down on the Paper Width Clip to latch it in place.

Loading the Recording Paper

Paper Specifications

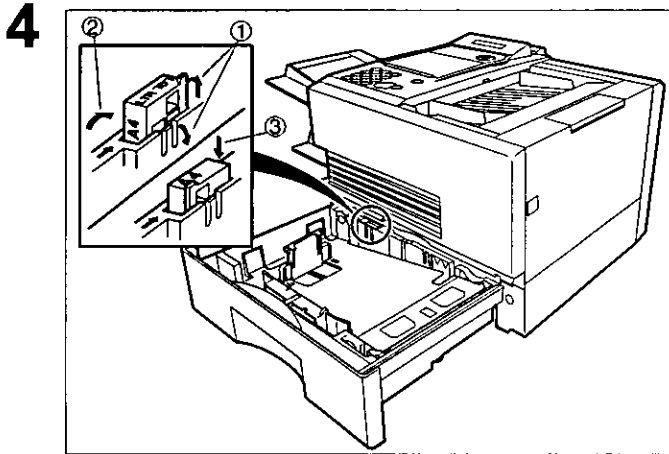

1. Release the hook and remove the Paper Size Selector.
2. Rotate the Paper Size Selector until the appropriate setting marked on the Selector is facing upward and the wording is upright.
3. Reinstall the Paper Size Selector.

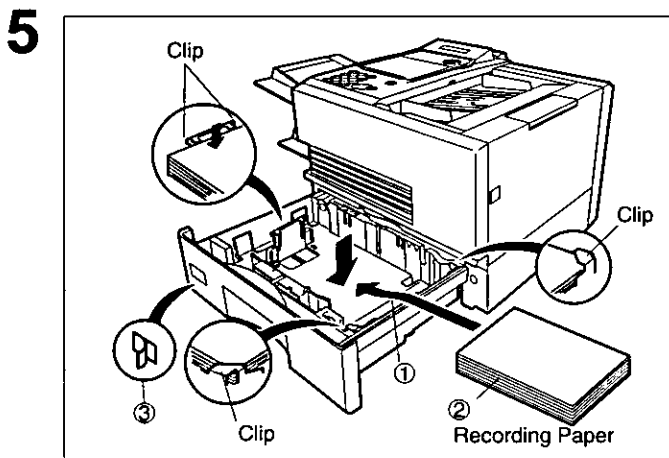

1. Push the Pressure Plate until it is locked down.
2. Load the paper into the Paper Cassette.
Caution: Make sure that the paper is set under the clips of the Paper Cassette. You can load about 500 sheets with standard weight paper (20 lb. weight). For paper specification see page 155.
3. Set the proper paper size label.

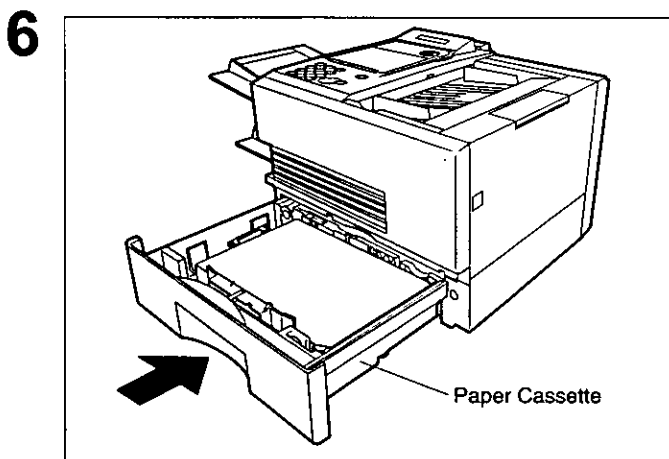

Slide the Paper Cassette into the machine.

NOTE

1. Your machine will properly print on A4, Letter and Legal size paper only. If other size of paper (B4, B5, A5) is used, your machine may not print properly.

Connecting the Telephone Line Cable and Power Cord



■ Power Cord

Plug one end of the power cord into an ordinary 3 prong AC outlet and the other end into the receptacle on the rear of the machine.

Warning: This apparatus must be properly grounded through an ordinary 3 prong AC outlet. Do not break off the earth (ground) prong to fit a 2 prong outlet.

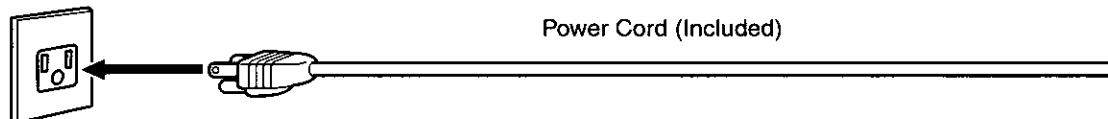

■ Telephone Line Cable

Plug one end of the telephone line cable into the "RJ-11C" telephone jack supplied by the telephone company and the other end into the LINE jack on the left side of the machine.

RJ-11C Telephone Jack

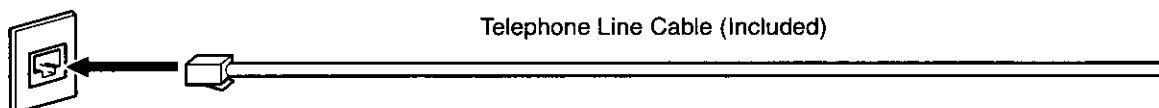

NOTE

1. Your machine uses little power and you should keep it ON at all times.

Connecting the Telephone Line Cable and Power Cord

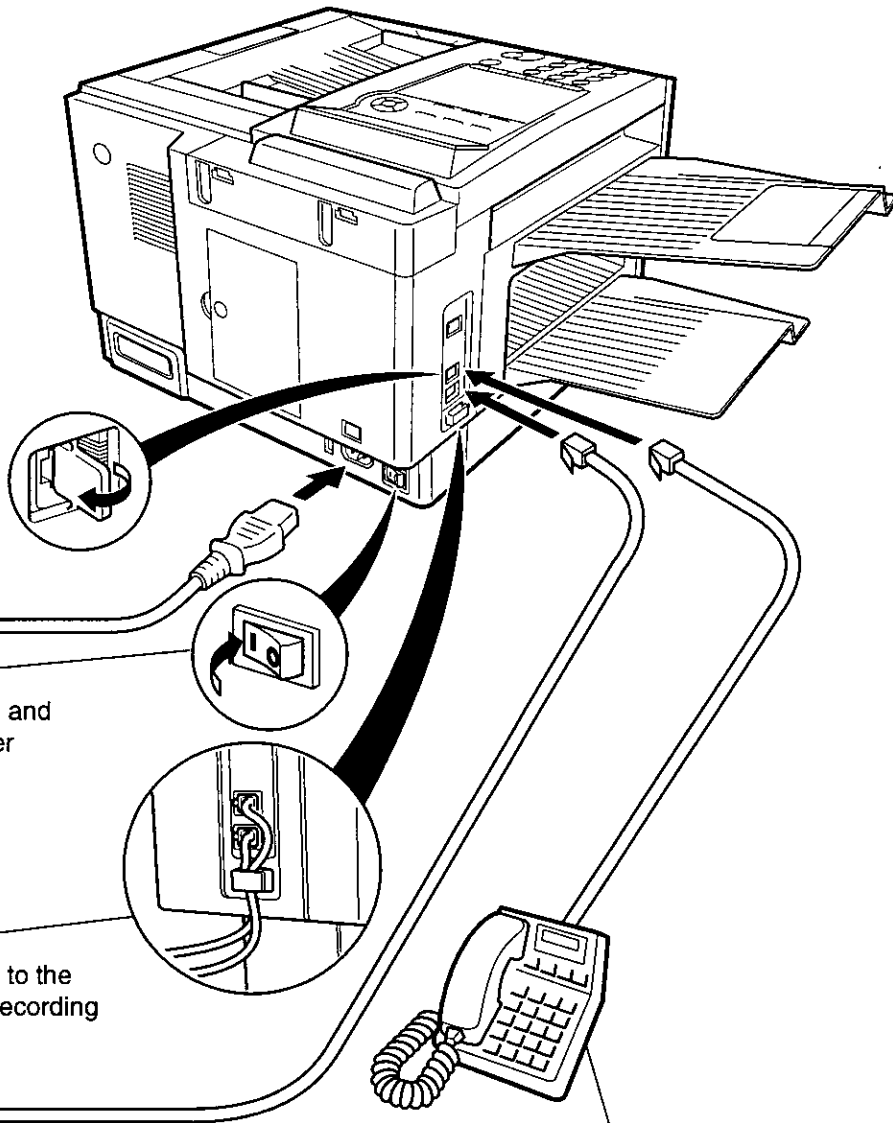



■ **Power Switch**
After connecting all cables and Power Cord, turn the power switch ON.

Note
Attach the cables to the Hook to prevent recording paper jam.

■ **External Telephone (Optional)**
You can connect an additional standard single line telephone to the machine. To connect the telephone, break off the protective tab on the TEL jack.

Setting the Dialing Method (Tone or Pulse)

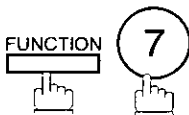
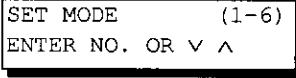
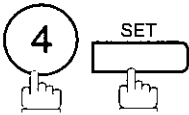
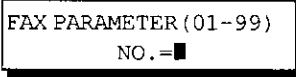
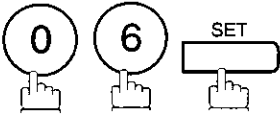
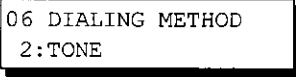
Your machine can operate with either of two dialing methods (Tone or Pulse), depending on the type of telephone line you are connected to. If you need to change the dialing method to Tone or Pulse, follow the procedure below.

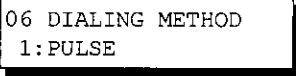
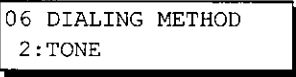
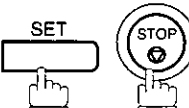
- 1**  
- 2**  
- 3**  
- 4**  for "PULSE".
or
 for "TONE".

or

- 5** 

Adjusting the Volume

Setting the Monitor Volume

You can adjust the monitor and ringer volume on your machine. The built-in speaker enables you to hear the dial tone, dialing signals, and busy tone. The ringer sounds when your machine receives a call.

1



You will hear the dial tone through the speaker.

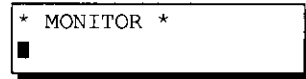

2

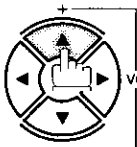

VOLUME repeatedly to raise the volume.

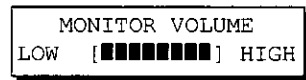

or

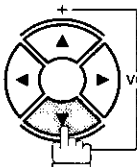

VOLUME repeatedly to lower the volume.

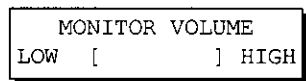

3



Setting the Ringer Volume

1

Standby

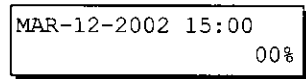

2

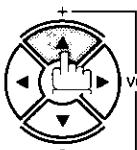

VOLUME repeatedly to raise the volume.



or

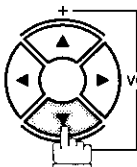

VOLUME repeatedly to lower the volume.



3



NOTE

1. You can also adjust the volume of the key touch tone and the volume of the buzzer in the Fax Parameter No. 10 (KEY/BUZZER VOLUME). (See page 36)

User Parameters

General Description

Your facsimile machine has several basic settings (User Parameters) to help you keep records of the documents you send or receive. For example, the built-in clock keeps the current date and time, and your LOGO and ID Number help to identify you when you send or receive documents.

Setting the Date and Time

At standby the display will show the date and time. Once the standby display is set, it will automatically be updated.

1

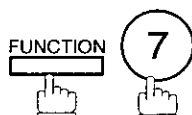

SET MODE (1-6)
ENTER NO. OR V ^

2



1:USER PARAMETERS?
PRESS SET TO SELECT

3

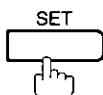

DATE & TIME
■1-01-2001 00:00

4

Enter the new date and time.

Ex: ① ③ Month: March
 ① ② Date: 12th
 ② ① ① ② Year: 2002
 ① ⑤ ① ① Time: 3:00 PM

DATE & TIME
03-12-2002 15:00

If you make a mistake, use ◀ or ▶ to move the cursor over the incorrect number, then overwrite it with a correct one.

5

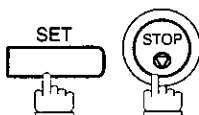

NOTE

1. The clock of your machine is equipped with D.S.T.(Daylight Saving Time) system. So, your clock will automatically set the time forward from 2:00 AM to 3:00 AM on the first Sunday of April and set the time back from 2:00 AM to 1:00 AM on the last Sunday of October. If your state does not use the D.S.T. system, change the Fax Parameter No. 35 (DAYLIGHT TIME) to "Invalid".
2. The current Date & Time must be set because it is required by the Telephone Consumer Act of 1991. (For details, see FCC NOTICE at the end of this Operating Instructions)

Setting Your LOGO

When you send a document, your LOGO appears on the top of the copy printed out at the other station. The LOGO helps to identify you to someone who receives your document.

1

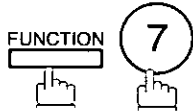

```
SET MODE      (1-6)
ENTER NO. OR v ^
```

2



```
1:USER PARAMETERS?
PRESS SET TO SELECT
```

3

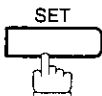

repeatedly until display shows;

```
LOGO
█
```

4

Enter your LOGO (max. 25 characters and digits) by using the Character keys.

Ex: PANASONIC

If you make a mistake, use ◀ or ▶ to move the cursor one space beyond the incorrect character, press CLEAR then re-enter the new character.

If more than 19 characters are entered, the left side characters will scroll off the display.

```
LOGO
PANASONIC█
```

5

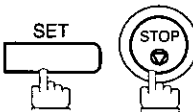

NOTE

1. Your Company Name or your name must be set as your LOGO because it is required by the Telephone Consumer Act of 1991. (For details, see FCC NOTICE at the end of this Operating Instructions)

User Parameters

Setting Your Character ID

If the remote machine has a Character ID capabilities, when you are sending or receiving, your Character ID will appear on the remote machine's display and the remote machine's Character ID will appear on your display.

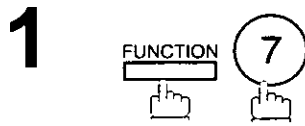

```
SET MODE          (1-6)
ENTER NO. OR v ^
```

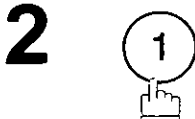

```
1:USER PARAMETERS?
PRESS SET TO SELECT
```



```
CHARACTER ID
█
```

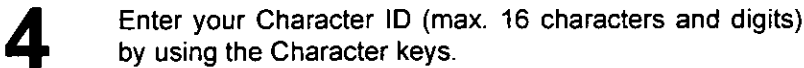

Ex: **H E A D SPACE O F F I C E**

If you make a mistake, use ◀ or ▶ to move the cursor beyond the incorrect character, press **CLEAR** then re-enter the new character.

```
CHARACTER ID
HEAD OFFICE█
```

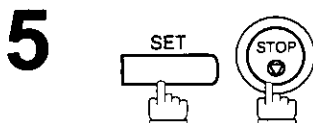

NOTE

1. The special characters of Å, Ä, Ö, Ü, Æ, è and é cannot be used for Character ID.

Setting Your ID Number (Fax Telephone Number)

If the remote machine does not have a Character ID but it has an ID Number, when sending or receiving, your ID Number will appear on the remote machine's display and their ID Number will appear on your display.

We suggest you use your facsimile telephone number as your ID number. (max. 20 digits)

1

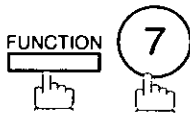

SET MODE (1-6)
ENTER NO. OR v ^

2



1:USER PARAMETERS?
PRESS SET TO SELECT

3

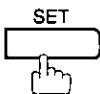

repeatedly until display shows;

ID NO.
█

4

Enter your ID (max. 20 digits) by using the keypad and **[SPACE]** key to enter a space between numbers.

Ex: **[2] [0] [1] [SPACE] [5] [5] [5] [SPACE] [1] [2] [1] [2]**

If you make a mistake, use **[◀]** or **[▶]** to move the cursor one space beyond the incorrect number, press **[CLEAR]** then re-enter the new number.

ID NO.
201 555 1212█

5

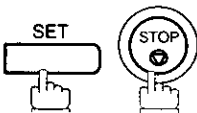

NOTE







- You may use **[*]** to enter a "+" character at the beginning of the ID number to indicate the following digit(s) for your country code.
Ex: +1 201 555 1212 +1 for U.S.A. country code.
+81 3 111 2345 +81 for Japan country code.
- Your Fax Telephone Number must be set as your ID Number because it is required by the Telephone Consumer Act of 1991. (For details, see FCC NOTICE at the end of this Operating Instructions)

One-Touch/Abbreviated Dialing Numbers

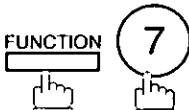
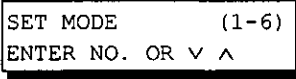
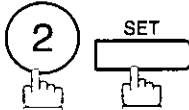
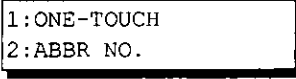
Entering One-Touch/Abbreviated Dialing Numbers

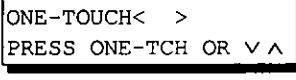
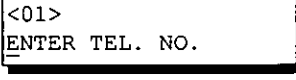
One-Touch and Abbreviated Dialing are two fast ways of dialing full telephone numbers. To use these dialing methods, you must first store the telephone number using the following procedure.

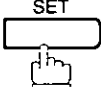
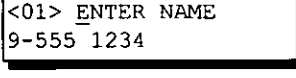
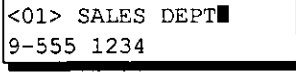
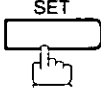
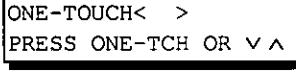
To enter a One-Touch key, follow the steps below

- 1**  
 - 2**  
 - 3**  
 - 4** Ex: 
 - 5** Enter the telephone number (up to 36 digits including pauses and spaces).
Ex: 
 - 6**  
 - 7** Enter the station name using character keys (up to 15 characters).
Ex: 
 - 8**  
- To record another number, repeat step 4 to 8.
To return to standby, press  .

One-Touch/Abbreviated Dialing Numbers

Entering One-Touch/Abbreviated Dialing Numbers

To set an Abbreviated Dialing Number, follow the steps below

1

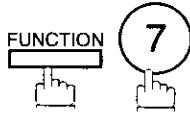

SET MODE (1-6)
ENTER NO. OR v ^

2

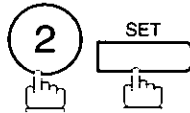

1:ONE-TOUCH
2:ABBR NO.

3



ABBR. []
ENTER NO. OR v ^

4

Ex: 0 2 2 (001 to 160)

[022]
ENTER TEL. NO.

5

Enter the telephone number
(up to 36 digits including pauses and spaces).

Ex: 9 PAUSE 5 5 5 SPACE 2 3 4 5

[022]
9-555 2345

6

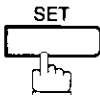

[022]ENTER NAME
9-555 2345

7

Enter the station name using character keys
(up to 15 characters).

Ex: ACCOUNTING

[022]ACCOUNTING
9-555 2345

8

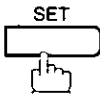

ABBR. []
ENTER NO. OR v ^

To record another number, repeat step 4 to 8.

To return to standby, press STOP.

NOTE

- If you require a special access number to get an outside line, enter it first and then press **PAUSE**. A hyphen "-" is displayed for pause.
- Use **SPACE** or **MONITOR** to enter a space between the numbers to make it easier to read.
- If you are using Pulse dialing and you wish to change to Tone dialing in the middle of dialing, press **TONE** (represented by a "/"). The dialing method will be changed from Pulse to Tone after dialing the digit "/".
Ex: 9 PAUSE TONE 5551234
- You can search for an unused One-Touch key or ABBR. number by pressing ▼ or ▲ in step 3 or 4.

One-Touch/Abbreviated Dialing Numbers

Editing One-Touch/Abbreviated Dialing Numbers

If you have to change or erase any of the One-Touch/Abbreviated dialing numbers, follow the steps below.

To change the settings of a One-Touch/ABBR dialing number

- 1**

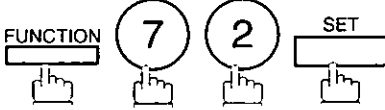

1: ONE-TOUCH
 2: ABBR NO.
- 2**

Select ① for One-Touch Dialing number
 Select ② for ABBR. Dialing Number
 Ex: ①

ONE-TOUCH< >
 PRESS ONE-TCH OR v ^
- 3**

Enter the station you wish to change.
 Ex: 01

<01> SALES DEPT
 9-555 1234
- 4**



then enter a new telephone number. (See Note 1)
 Ex: 9 PAUSE 5 5 5 SPACE 3 4 5 6

<01> SALES DEPT
 ENTER TEL. NO.
- 5**



<01> SALES DEPT
 9-555 3456
- 6**



then enter a new station name. (See Note 1)
 Ex: P A N A F A X

<01> ENTER NAME
 9-555 3456
- 7**



To return to standby, press STOP .

ONE-TOUCH< >
 PRESS ONE-TCH OR v ^

NOTE

1. If you make a mistake, use ◀ or ▶ to move the cursor beyond the incorrect number, press CLEAR then re-enter the new number.
2. If the One-Touch/Abbreviated dialing number has been used for a communication reservation, the settings cannot be changed or erased until the communication has finished. To change or erase the settings, cancel the communication first by Edit File Mode. (See Page 78)

One-Touch/Abbreviated Dialing Numbers

Editing One-Touch/Abbreviated Dialing Numbers

To erase the settings of One-Touch/ABBR Dialing number

1

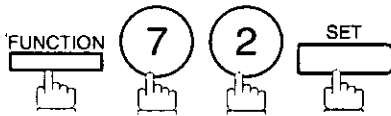

1: ONE-TOUCH
2: ABBR NO.

2

Select ① for One-Touch Dialing number
Select ② for ABBR. Dialing Number

Ex: ①

ONE-TOUCH< >
PRESS ONE-TCH OR v ^

3

Enter the station you wish to erase.

Ex:

<01> SALES DEPT
9-555 1234

4



<01> SALES DEPT
ENTER TEL. NO.

5

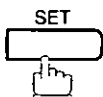

ONE-TOUCH< >
PRESS ONE-TCH OR v ^

To return to standby, press .

NOTE

1. If the One-Touch/Abbreviated dialing number has been used for a communication reservation, the settings cannot be changed or erased until the communication has finished. To change or erase the settings, cancel the communication first by Edit File Mode. (See Page 78)

One-Touch/Abbreviated Dialing Numbers

Printing Out a Directory Sheet

After programming a one-touch dialing number, you can print out the directory sheet which includes the first 12 characters of each station name. Cut along the dotted line and place it over the One-Touch keys under the Directory Sheet Cover. To print out a directory sheet, follow the steps below.

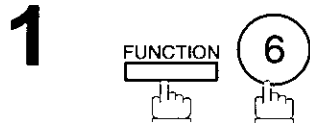

PRINT OUT (1-7)
ENTER NO. OR v ^



* PRINTING *
DIRECTORY SHEET

Your machine prints out the directory sheet.

```

***** -DIRECTORY SHEET- ***** DATE MAR-12-2002 ***** TIME 15:00 *****

```

01	02	03	04	05	06
SALES DEPT	ENG. DEPT	ACCT. DEPT	EXPORT DEPT	R & D DEPT	MARKET DEPT
07	08	09	10	11	12
13	14	15	16	17	18
19	20	21	22	23	24
25	26	27	28	29	30
31	32	P1	P2	P3	P4
P5	P6	P7	P8		

----- dotted line -----

```

***** -HEAD OFFICE - ***** - PANASONIC - ***** - 201 555 1212- *****

```

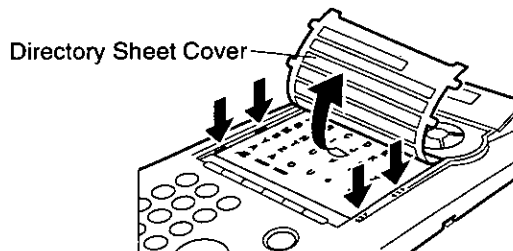

Customizing Your Machine

General Description

Your facsimile machine has a variety of adjustable Fax Parameters. These parameters, listed in the Parameter Table, are preset for you and do not need to be changed. If you do want to make a change, read the table carefully. Some parameters, such as the Resolution and Contrast parameters, can be temporarily changed by simple key operation just before a transmission is made. When the transmission ends, however, these parameters return to their preset values (Home position). Other parameters can only be changed by the procedure described below.

Setting the Fax Parameters

1

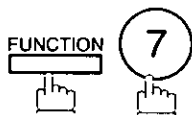

SET MODE (1-6)
ENTER NO. OR v ^

2

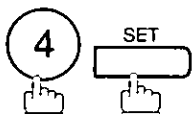

FAX PARAMETER (01-99)
NO. =■

3

Enter Fax Parameter number from the Parameter Table.

Ex: ① ① for CONTRAST

FAX PARAMETER (01-99)
NO. =01

4

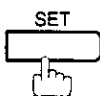

01 CONTRAST
1: NORMAL

5

Enter the new setting value.

Ex: ② for LIGHTER

01 CONTRAST
2: LIGHTER

6

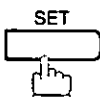

02 RESOLUTION
1: STANDARD

To set another parameter, press **CLEAR** to return to step 3 or press **STOP** to return to standby.

NOTE

1. To scroll the Fax Parameters in Step 2 or 4, press ▼ or ▲.
2. To print out a Fax Parameter List, see page 138.

Customizing Your Machine

Fax Parameter Table

No.	Parameter	Setting Number	Setting	Comments
01	CONTRAST	*1	Normal	Setting the home position of the CONTRAST key.
		2	Lighter	
		3	Darker	
02	RESOLUTION	*1	Standard	Setting the home position of the RESOLUTION key.
		2	Fine	
		3	S-Fine	
04	STAMP	*1	Off	Setting the home position of the STAMP key. To select the stamp function when document is stored in memory, see Fax Parameter No. 28.
		2	On	
05	MEMORY	1	Off	Setting the home position of the MEMORY key.
		*2	On	
06	DIALING METHOD	1	Pulse	Selecting the dialing method.
		*2	Tone	
07	HEADER PRINT	*1	Inside	Selecting the printing position of the header. Inside : Inside TX copy area. Outside : Outside TX copy area. No print : Header is not printed.
		2	Outside	
		3	No print	
08	HEADER FORMAT	*1	Logo, ID No.	Selecting the header format.
		2	From To	
09	RCVD TIME PRINT	*1	Invalid	Selecting whether the machine prints the received date & time, remote ID, percentage of reduction and page number on the bottom of each received page.
		2	Valid	
10	KEY/BUZZER VOLUME	1	Off	Selecting the volume of the Key/Buzzer tone.
		*2	Soft	
		3	Loud	
12	COMM. JOURNAL	1	Off	Selecting the home position of printout mode for COMM. Journal Off/Always/INC. Off : Does not print Always : Always prints Inc. only : Prints only when communication has failed.
		2	Always	
		*3	Inc. only	
13	AUTO JOURNAL PRINT	1	Invalid	Selecting whether the machine prints the journal automatically after every 100 transactions.
		*2	Valid	
14	FILE ACCEPTANCE REPORT	*1	Invalid	Selecting whether the machine prints the file acceptance journal. If you set this parameter to valid, a journal will print out after any memory communication.
		2	Valid	
17	RECEIVE MODE	1	Manual	Setting the reception mode to automatic or manual.
		*2	Auto	
22	SUBSTITUTE RCV	1	Invalid	Selecting whether the machine receives to memory when recording paper runs out, toner runs out or recording paper is jammed.
		*2	Valid	

Customizing Your Machine

Fax Parameter Table

No.	Parameter	Setting Number	Setting	Comments
24	PRINT REDUCTION	1	Fixed	Selecting print reduction mode. Fixed : Reduce received document according to setting of Parameter No. 25.
		*2	Auto	Auto : Reduce received document according to the length of received documents.
25	REDUCTION RATIO	70	70%	Selecting fixed print reduction ratio from 70% to 100%. This parameter functions only when fixed print reduction is selected on Fax Parameter No. 24.
		----	---	
		100	100%	
26	POLLING PASSWORD		(----	Setting a 4-digit password for secured polling. (See page 69)
27	POLLED FILE SAVE	*1	Invalid	Selecting whether the machine retains the polled document in memory even after the document is polled once.
		2	Valid	
28	STAMP AT MEM. XMT	1	Invalid	Selecting whether the machine stamps the original documents when storing the documents into memory. (Depending on the Stamp setting on the Control Panel)
		*2	Valid	
31	INCOMPLETE FILE SAVE	*1	Invalid	Selecting whether the machine retains the document in memory if the document is not successfully transmitted.
		2	Valid	
32	COPY REDUCTION	1	Manual	Selecting whether the machine performs the copy reduction ratio automatically or manually. Manual : The machine will prompt you for the Zoom ratio (100% to 70%) when making copies.
		*2	Auto	Auto : The machine will automatically determine the reduction ratio according to the length of the original document.
33	XMT REDUCTION	1	Invalid	Selecting whether the machine performs reduction when the transmitting document is wider than the recording paper used at the receiving machine.
		*2	Valid	
34	ENERGY SAVER MODE	1	Off	To reduce the power consumption in standby, select either Energy-Saver or Sleep mode and specify the Delay Time (1 to 120 minutes) for the machine to enter into the selected mode. The Delay Timer setting is only available in the Energy-Saver or Sleep Modes.
		2	Energy-Saver	Off : The unit will remain in standby mode and consume more energy than when in Energy-Saver or Sleep modes.
		*3	Sleep	Energy-Saver Mode : Saves energy by consuming less power than when in standby mode by turning off the fuser unit after the specified time. Sleep Mode : This is the lowest power state that the machine enters after the specified time without actually turning off.

Continued on the next page...

Customizing Your Machine

Fax Parameter Table

No.	Parameter	Setting Number	Setting	Comments
35	DAYLIGHT TIME	1	Invalid	Selecting whether the clock adjusts for Daylight Saving Time automatically. The built-in clock will advance 1 hour at 2:00 am on the first Sunday in April and fallback 1 hour at 2:00 am on the last Sunday in October.
		*2	Valid	
36	RING PATTERNDETECT (DRD) (See Note 2)	*1	Invalid	All ring patterns.
		2	Valid	Select a ring pattern for automatic answering. 1: A Standard ring pattern. 2: B Double ring pattern. 3: C Triple ring pattern (Short-Short-Long). 4: D All other triple ring patterns, except the type C described above.
37	RCV TO MEMORY		(---)	Enter a 4-digit password used to print out the received document in memory by using F8-5 (RCV TO MEMORY). When F8-5 is set to On, this parameter will not be shown on the LCD display. (See page 88)
38	ACCESS CODE		(---)	Enter a 4-digit Access Code to secure the machine from unauthorized use. (See page 86)
39	PIN CODE ACCESS	*1	None	Selecting the access method (Prefix or Suffix) to dial a number with PIN Code. (See page 93)
		2	Suffix	
		3	Prefix	
42	CONF. POLLED FILE SAVE	*1	Invalid	Selecting whether the machine saves the confidential polled file even after the file is polled once.
		2	Valid	
43	PASSWORD-XMT	*1	Off	Setting a 4-digit XMT-Password and selecting whether the machine performs and checks the XMT-Password of the receiving station when transmitting. (See page 114)
		2	On	
44	PASSWORD-RCV	*1	Off	Setting a 4-digit RCV-Password and selecting whether the machine performs and checks the RCV-Password of the transmitting station when receiving. (See page 115)
		2	On	
46	SELECT RCV	*1	Invalid	Selecting whether the machine performs selective reception. (See page 112)
		2	Valid	
52	DIAGNOSTIC PASSWORD		(---)	Setting the password for Remote Diagnostic Mode. Please ask your Panasonic Authorized Dealer for details.
53	SUB-ADDRESS PASSWORD		(---)	Setting a 20-digit password for secured sub-address communication.
54	FAX FORWARD	*1	Invalid	Selecting whether the machine performs Fax Forwarding to the specified destination. (See page 95)
		2	Valid	
56	COVER SHEET	*1	Off	Setting the home position of the Cover Sheet parameter in the Select Mode. (See page 91)
		2	On	
58	LANGUAGE	*1	A-English	Selecting the language to be shown on the display and reports.
		2	C-French	
			Spanish	
60	OPTION PAGE MEMORY (D-RAM Card)	*1	0MB	Set the size of the page memory to match the optional Expansion D-RAM Card installed in the machine. (See page 156)
		2	2MB	
		3	4MB	
		4	8MB	

Customizing Your Machine

Fax Parameter Table

No.	Parameter	Setting Number	Setting	Comments
65	PRINT COLLATION	1	Invalid	Selecting whether the machine prints out documents in sequence. (See page 64)
		*2	Valid	
77	LOGO/DEPT. CODE	*1	Invalid	Selecting whether the machine performs the Multiple Logo or Department Code operation. (See page 99 and 108)
		2	Multi-LOGO	
		3	Dept.Code	
82	QUICK MEMORY XMT	1	Invalid	Selecting whether the machine performs Quick Memory Transmission. (See page 47 to 50) Invalid : Stores all documents into memory first before dialing the telephone number. Valid : Starts dialing the telephone number immediately after storing the first page.
		*2	Valid	
88	LINE SELECTION [See Note 3]	*1	Auto	Setting the home position of the Telephone Line selection. Auto : Selects the available telephone line for transmission automatically. Line1 :Selects this as the default telephone line, unless manually selecting an alternate phone line. Line2 :Selects this as the default telephone line, unless manually selecting an alternate phone line.
		2	Line 1	
		3	Line 2	
99	MEMORY SIZE (Flash Memory)	-	-	Displays the amount of base and optional memory installed. (Base Memory + Optional Memory)

NOTE

- Setting number marked with an asterisk (*) indicates the factory standard setting.
- This parameter supports an optional telephone service "Distinctive Ring Service" provided by your local telephone company. It allows up to 4 different telephone numbers to be assigned on a single telephone line with a distinctive ring for each telephone number. By selecting the appropriate ring pattern associated with the telephone number assigned for your fax machine. It can differentiate and answer the incoming call on the fax number. All other calls on the other telephone numbers will not be answered. This optional service from your local phone company is also called Custom Ringing, Distinctive Ringing, Ident-a-call, Ident-a-ring, Personalized Ringing, RingMaster, RingMate, Selective Ringing, Smart Ring or something similar. Check with your local telephone company on the availability of this service in your area.
- This parameter is available only when the G3 Communication Port Option is installed.

Loading Documents

Documents You Can Send

In general, your machine will send any document printed on A4, Letter or Legal size paper.

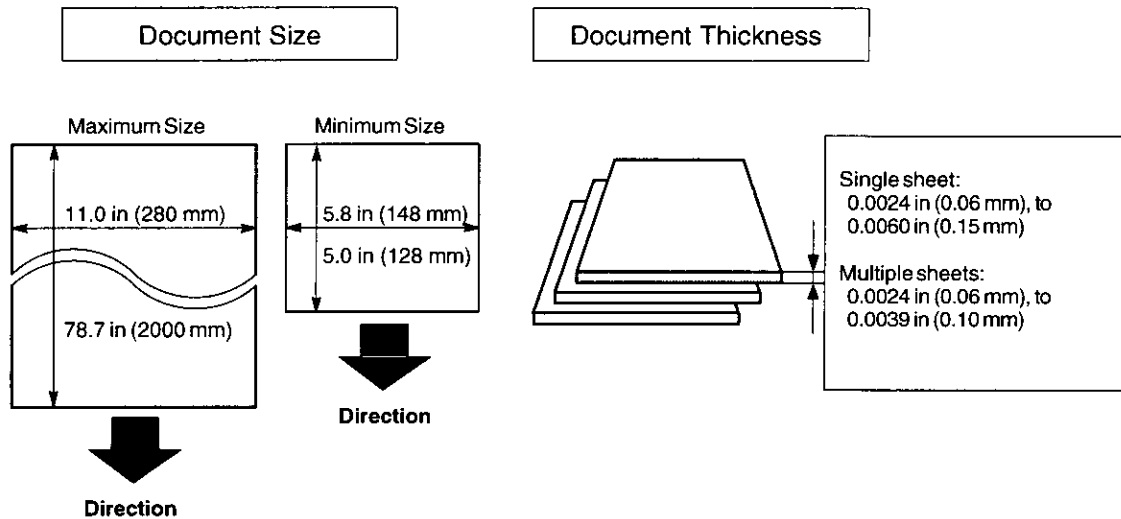

Documents You Cannot Send

You must never try to send documents that are:

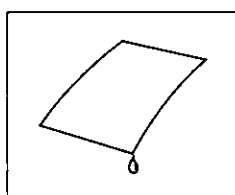

Wet

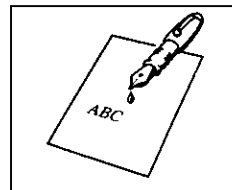

Covered with wet ink or paste

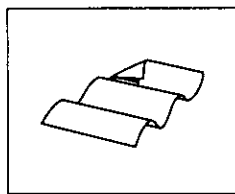

Too thin (e.g., onionskin, airmail paper, pages from some magazines, etc.)

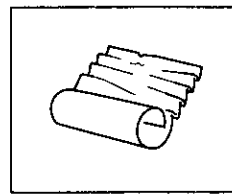

Wrinkled, curled or folded

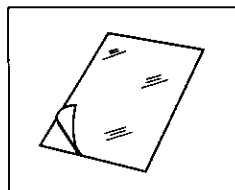

Coated (e.g., glossy paper, etc.)

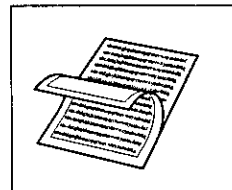

Chemically processed (e.g., pressure-sensitive paper, carbon-coated paper, etc.) or made of cloth or metal

To transmit these kinds of documents, make a photocopy first and then transmit the copy instead.

How to Load Documents

1. Be sure the document(s) is free of staples, paper clips and is not torn, greasy or covered by foreign objects.
2. Place the document(s) **FACE DOWN** on the Automatic Document Feeder (ADF) until the leading edge placed into the machine stops.
If you are sending multiple pages, make sure that **the bottom sheet enters first**. You can also stack up to **70 PAGES** on the ADF at one time by **setting the documents as stairs shape as the figure below**. If you have more than 70 pages, wait until transmission or storing in memory starts as pages feed through, place any remaining pages on top of the last page in the feeder.
3. Adjust the Document Guides to center the document on the ADF.

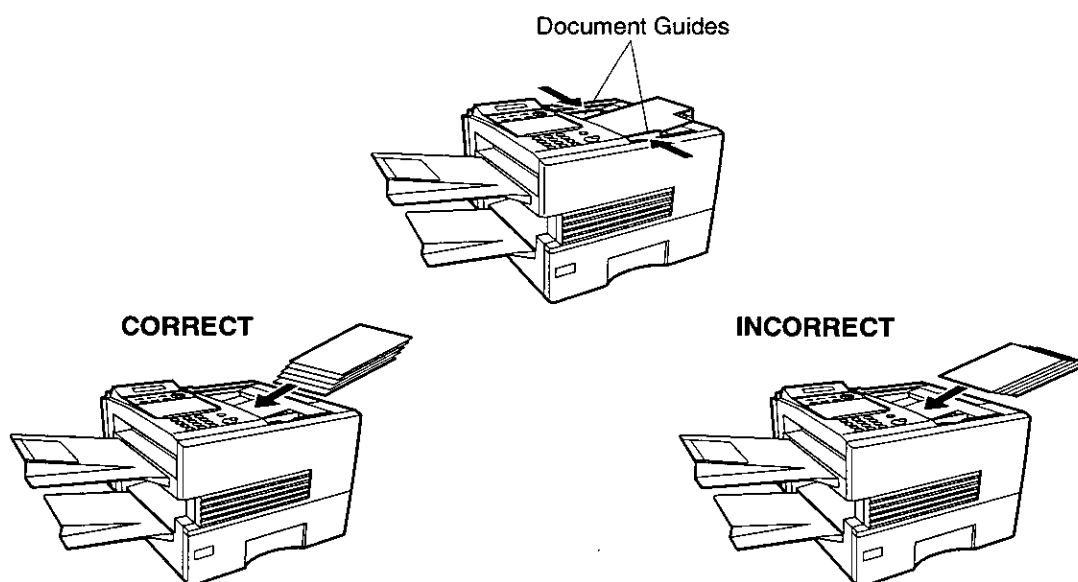

When you set a document on the ADF, the display message will change from date and time (standby) to the following message. You can now change basic transmission settings, or begin the dialing procedure.

ENTER STATION(S)
THEN PRESS START 00%

NOTE

1. The document limitation to send multiple pages is as follows.

	Document Size	Document Thickness
Up to 50 pages	Up to 10.1 x 14.3 in (257 x 364 mm)	0.0024 - 0.0048 in
Up to 70 pages*	A4 or Letter size	0.0024 - 0.0039 in

* Please note that although the size and thickness meets the specifications, you might not be able to set 70 pages with some types of papers.

2. Transmitting documents longer than 14 in (356 mm) requires user's assistance.
3. When transmitting documents longer than Letter size (8.5 x 11 in), please extend the sub-tray as shown below.

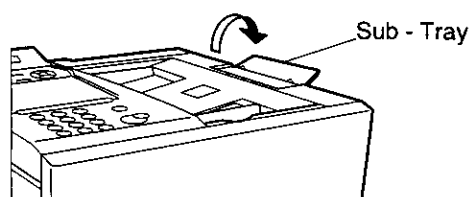

Basic Transmission Settings

General Description

You can temporarily change the transmission settings either before or after you place the document on the ADF.

These settings are as follows

- Contrast
- Resolution
- Halftone
- Stamp
- Communication Journal

After your document(s) have been sent, your machine will automatically return to the preset settings.

Contrast

Your machine is preset to **Normal** contrast. If you wish to send a document with lighter contrast, change the setting to **Lighter**. If you wish to send a document with darker contrast, change the setting to **Darker**.

Press **CONTRAST** to:

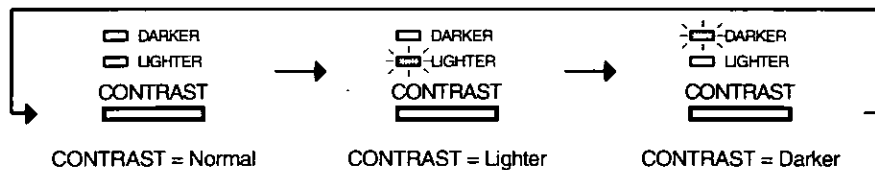

Resolution

Your machine is preset to **Standard** resolution, which is suitable for most documents. Use **Fine** or **Super Fine** for detailed documents.

Press **RESOLUTION** to:

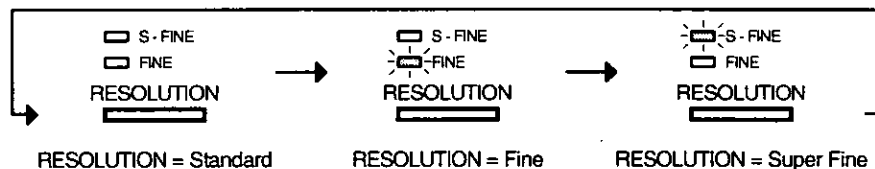

NOTE

1. To change the preset Contrast position, change the setting of Fax Parameter No. 01. (See page 36)
2. To change the preset Resolution position, change the setting of Fax Parameter No. 02. (See page 36)
3. If you send a photographic document with Halftone set to Fast or Quality and the Resolution set to Super Fine (406 pels/inch x 391 lines/inch), the reproduction of the received document will be determined by the capability of the remote station.

Basic Transmission Settings

Halftone

The Halftone setting is useful when sending photographs or illustrations with gray tones. Your machine is preset to HALFTONE = Off. You can select either Fast or Quality mode.

Press **HALFTONE** to:



Verification Stamp

The Verification Stamp helps you to confirm successful transmissions by stamping the bottom of each successfully transmitted page with a small ⊗ mark.

Press **STAMP** to:

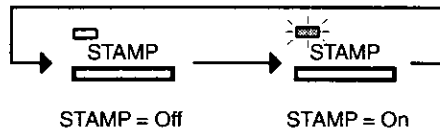

NOTE

1. When you select HALFTONE, FAST or QUALITY, your machine will automatically select Fine Resolution.
2. When you store a document in memory, the Verification Stamp will stamp on the document if it is successfully stored in memory. In this case the Verification Stamp is not a confirmation that the document was successfully transmitted. If you wish to disable the use of the Verification Stamp when storing document in memory, change the setting of Fax Parameter No. 28. (See page 37)
3. To change the preset Verification Stamp position, change the setting of Fax Parameter No. 04. (See page 36)

Basic Transmission Settings

Communication Journal (COMM. JOURNAL)

A Communication Journal lets you verify if the transmission was successful. You can select the condition to print out the Communication Journal as follows.

- When you set COMM. JOURNAL = OFF : a Communication Journal will not be printed out.
- When you set COMM. JOURNAL = ON : a Communication Journal is printed out automatically after every communication.
- When you set COMM. JOURNAL = INC. : a Communication Journal is printed out automatically only if the communication has failed.

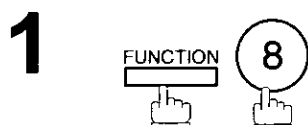

SELECT MODE (1-5)
ENTER NO. OR ∨ ^

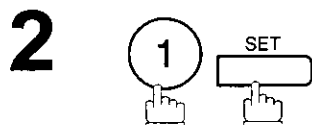

COMM. JOURNAL=INC
1:OFF 2:ON 3:INC

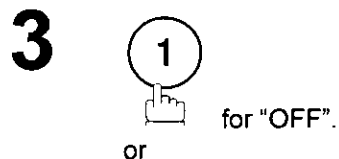

COMM. JOURNAL=OFF
1:OFF 2:ON 3:INC

or



COMM. JOURNAL=ON
1:OFF 2:ON 3:INC

or



COMM. JOURNAL=INC
1:OFF 2:ON 3:INC

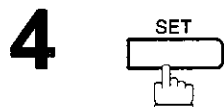

NOTE

1. To change the preset Comm. Journal condition, change the setting of Fax Parameter No. 12. (See page 36)

Sending Documents

General Description

You can choose either Memory or Direct Transmission.

Use Memory Transmission if:

- You want to send the document to multiple stations.
- You have to retrieve the document immediately.
- You want to take advantage of Dual Operation design.

Use Direct Transmission if:

- The memory is full.
- You want to send the document immediately.

Use Voice Mode Transmission if:

- You want to send the document after talking with the other party.
- You want to send the document after listening to a voice prompting.

Memory Transmission

Your machine quickly stores the document into the machine's memory. Then, starts to dial the telephone number.

If the transmission fails, your machine will re-transmit the remaining unsuccessful page(s) automatically.

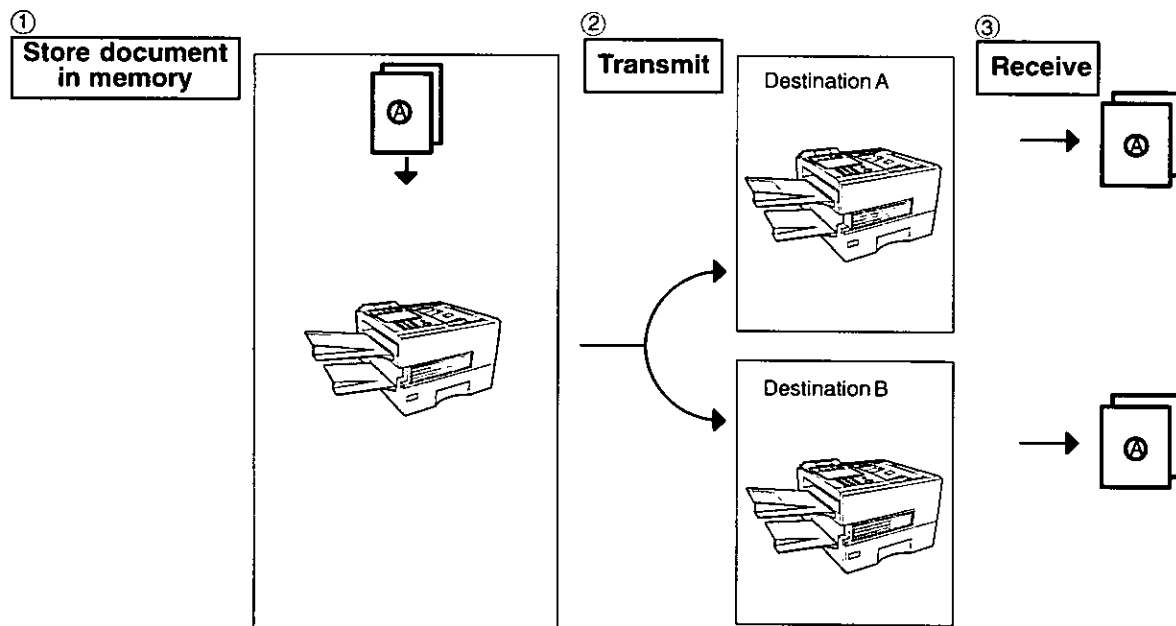

Sending Documents

Memory Transmission

NOTE

1. The File Number of the document being stored is shown at the upper right corner of the display while storing the document. It is also printed on the Communication Journal (COMM. JOURNAL), Transaction Journal and File List. The percentage of memory used is shown on the lower right corner of the display after each page is stored.

```
* STORE *      NO.003
      PAGES=002  10%
```

```
* STORE * COMPLETED
TOTAL PAGES=005  30%
```

2. If memory overflow occurs while storing documents, the remaining documents on the ADF will be ejected. The machine prompts you whether to transmit the successfully stored documents or to cancel the transmission. Press **①** to cancel or press **②** to transmit.

```
MEMORY OVERFLOW
INFO. CODE=870
```

See the Specifications on page 153 for the image memory capacity.

If no action is taken within 10 seconds, the machine will start transmitting the stored documents.

```
15 PAGES COMPLETED
DELETE? 1:YES 2:NO
```

3. An Information Code will be displayed if the transmission has failed or no answer at the receiving side after the last automatic redial.

The document stored for this transmission will be erased from the memory automatically and the information code is printed for the transmission on the Communication Journal (COMM. JOURNAL). If you need to retain the incomplete documents even after the last redial, change Fax Parameter No. 31 (INC. FILE SAVE) to "Valid" in advance. (See page 37) To retry the incomplete documents, refer to page 85.

```
INCOMPLETE
INFO. CODE=XXX
```

4. To stop the transmission, press **STOP**.

The display shows:

```
COMMUNICATION STOP?
1:YES 2:NO
```

Press **①** to stop the transmission. The document you stored will be erased automatically.

If you do not want to erase the documents, change the setting of Fax Parameter No. 31 (INC. FILE SAVE) to "Valid" in advance. (See page 37)

Then the following display will appear and you can select whether to save the file as an incomplete file for editing and retry, or delete the file manually.

```
SAVE AS INCOMP. FILE?
1:YES 2:NO
```

5. If you would like to print a Communication Journal (COMM. JOURNAL) after stopping a transmission, press **①** when the display shows:

```
PRINT COMM. JOURNAL?
1:YES 2:NO
```

6. If the file memory capacity reaches 30 files and you try to store another file, the following display appears and the machine will not accept additional files until a file is completed and becomes available.

```
FILE STORAGE IS FULL
PLEASE WAIT!
```

Memory Transmission

Manual Number Dialing

To dial the telephone number manually, follow the steps below.

1



Set document(s) face down.

ENTER STATION(S)
THEN PRESS START 00%

2



Make sure that the MEMORY lamp is on.

If not, press "On". MEMORY to set "On".

3

Enter a telephone number from the keypad.

Ex: 5 5 5 1 2 3 4

TEL. NO.
5551234

4

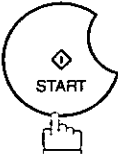

The document is stored into memory with a file number.
Then starts dialing the telephone number immediately
after storing the first page. (See Note 3)
The remaining page(s) continue to store into memory.

* STORE * NO.002
PAGES=001 05%

* DIALING * NO.002
5551234

NOTE

1. If you need a special access number to get an outside line, dial it first then press PAUSE to enter a pause (represented by a "-") before dialing the full number.
Ex: 9 PAUSE 5551234
2. If you are using Pulse dialing and you wish to change to Tone dialing in the middle of dialing, press TONE (represented by a "/").
The dialing mode will be changed from Pulse to Tone after dialing the digit "/".
Ex: 9 PAUSE TONE 5551234
3. This feature is called "Quick Memory Transmission". If you wish to store all the document(s) into memory first before transmitting, change the Fax Parameter No. 82 (QUICK MEMORY XMT) to "Invalid". (See page 39)

Sending Documents

Memory Transmission

One-Touch Dialing

One-Touch Dialing allows you to dial a full telephone number by pressing a single key. To set up the One-Touch keys, see page 30.

1



Set document(s) face down.

ENTER STATION(S)
THEN PRESS START 00%

2



Make sure that the MEMORY lamp is on.

If not, press "On". **MEMORY** to set "On".

3

Press a One-Touch key.

Ex:

<01>(Station name)
5551234

4

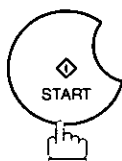

The document is stored into memory with a file number.
Then starts dialing the telephone number immediately
after storing the first page. (See Note 1)
The remaining page(s) continue to store into memory.

* STORE * NO.002
PAGES=001 05%

* DIALING * NO.002
(Station name)

NOTE

1. This feature is called "Quick Memory Transmission". If you wish to store all the document(s) into memory first before transmitting, change the Fax Parameter No. 82 (QUICK MEMORY XMT) to "Invalid". (See page 39)

Memory Transmission

Abbreviated Dialing

Abbreviated dialing is a speedy way to dial a frequently dialed telephone number by preprogramming the telephone number into the built-in auto-dialer with a 3-digit abbreviated code. To program an abbreviated dialing number, see page 31.

1



Set document(s) face down.

ENTER STATION(S)
THEN PRESS START 00%

2



Make sure that the MEMORY lamp is on.
If not, press "On". MEMORY to set "On".

3

Press ABBR then enter a 3-digit code.

Ex: ABBR 0 1 0

[010] (Station name)
5553456

4

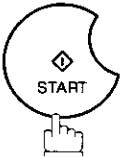

The document is stored into memory with a file number.
Then starts dialing the telephone number immediately
after storing the first page. (See Note 1)
The remaining page(s) continue to store into memory.

* STORE * NO.002
PAGES=001 05%

* DIALING * NO.002
(Station name)

NOTE

1. This feature is called "Quick Memory Transmission". If you wish to store all the document(s) into memory first before transmitting, change the Fax Parameter No. 82 (QUICK MEMORY XMT) to "Invalid". (See page 39)

Sending Documents

Memory Transmission

Directory Search Dialing

Directory Search dialing allows you to dial a full telephone number by searching the station name entered in One-Touch keys or Abbreviated dialing numbers.

1



Set document(s) face down.

ENTER STATION(S)
THEN PRESS START 00%

2



Make sure that the MEMORY lamp is on.

If not, press "On". **MEMORY** to set "On".

3



ENTER LETTER(S)

4

Enter the full station name or part of a station name by using the Character keys. (See page 14)

Ex: **P** **A** **N** **A** for searching **PANASONIC**

ENTER LETTER(S)
PANA

5

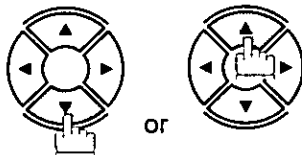

repeatedly until the display shows the station name you want to send to.

[010] PANASONIC
5553456

6

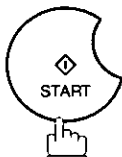

The document is stored into memory with a file number. Then starts dialing the telephone number immediately after storing the first page. (See Note 1)
The remaining page(s) continue to store into memory.

* STORE * NO.002
PAGES=001 05%

* DIALING * NO.002
PANASONIC

NOTE

1. This feature is called "Quick Memory Transmission". If you wish to store all the document(s) into memory first before transmitting, change the Fax Parameter No. 82 (QUICK MEMORY XMT) to "Invalid". (See page 39)

Memory Transmission

Multi-Station Transmission (Broadcasting)

If you have to send the same document(s) to multiple stations, you can save time in feeding the document(s) by using memory transmission. That is, you can store the document(s) into memory and then send it to the station(s) automatically.

1



Set document(s) face down.

ENTER STATION(S)
THEN PRESS START 00%

2



Make sure that the MEMORY lamp is on.

If not, press "On". MEMORY to set "On".

3

Dial by any combination of the following methods:

- One-Touch Dialing
- Abbreviated Dialing
- Manual Number Dialing, press SET after each station is entered
(UF-990: Up to 70 stations, UF-890: Up to 32 stations)
- Directory Search Dialing, press SET after each station is entered
(For details, see page 47 to 50.)

Ex: 01



If you want to confirm the number of stations you have entered, press SET.

<01>(Station name)
5551234

[010](Station name)
5553456

2 STN(S) ARE SET
ADD MORE OR START

4

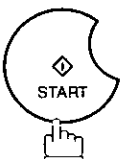

The document is stored into memory with a file number. Then starts dialing the telephone numbers in sequence.

* STORE * NO.001
PAGES=001 01%

* STORE * COMPLETED
TOTAL PAGE=005 25%

* DIALING * NO.001
(Station name)

NOTE

1. You can review the stations you entered in step 3 before storing your document into memory by pressing ▼ or ▲. Press CLEAR to clear an entered station or group shown on the display if needed.
2. The "Quick Memory Transmission" is disabled if multiple stations are set.

Sending Documents

Direct Transmission

If your machine's memory is full or you wish to send the document immediately, use Direct Transmission.

Manual Number Dialing (Direct Transmission)

To dial the telephone number manually, follow the steps below.

1



Set document(s) face down.

ENTER STATION(S)
THEN PRESS START 00%

2

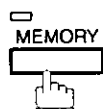

Make sure that the lamp goes off.

ENTER STATION
00%

3

Enter a telephone number from the keypad.

Ex: ⑤ ⑤ ⑤ ① ② ③ ④

PRESS START TO DIAL
5551234

4

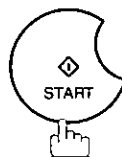

Your machine starts to dial the telephone number.

* DIALING *
5551234

NOTE

1. If you need a special access number to get an outside line, dial it first then press **PAUSE** to enter a pause (represented by a "-") before dialing the full number.
Ex: 9 PAUSE 5551234
2. If you are using Pulse dialing and you wish to change to Tone dialing in the middle of dialing, press **TONE** (represented by a "T").
The dialing mode will be changed from Pulse to Tone after dialing the digit "T".
Ex: 9 PAUSE TONE 5551234
3. To stop the transmission, press **STOP**.
The display shows:

COMMUNICATION STOP?
1: YES 2: NO

Press ① to stop the transmission. The Communication Journal will not print out regardless of the printout mode setting of the Communication Journal.

Direct Transmission

One-Touch Dialing (Direct Transmission)

One-Touch Dialing allows you to dial a full telephone number by pressing a single key. To set up the One-Touch keys, see page 30.

1



Set document(s) face down.

ENTER STATION(S)
THEN PRESS START 00%

2

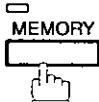

Make sure that the lamp goes off.

ENTER STATION 00%

3

Press a One-Touch key.

Ex: 01

The display will show the One-Touch number and station name. The full number (e.g. 5551234) will then be dialed.

<01> (Station name)
5551234

* DIALING *
(Station name)

Abbreviated Dialing (Direct Transmission)

Abbreviated dialing is a speedy way to dial a frequently dialed telephone number by preprogramming the telephone number into the built-in auto-dialer with a 3-digit abbreviated code. To program an abbreviated dialing number, see page 31.

1



Set document(s) face down.

ENTER STATION(S)
THEN PRESS START 00%

2

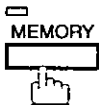

Make sure that the lamp goes off.

ENTER STATION 00%

3

Press **ABBR** and a 3-digit code.

Ex: **ABBR** 0 1 0

The display will show the ABBR number and station name.

The full number (e.g. 5553456) will then be dialed.

[010] (Station name)
5553456

* DIALING *
(Station name)

Sending Documents

Direct Transmission

Directory Search Dialing (Direct Transmission)

Directory Search dialing allows you to dial a full telephone number by searching the station name entered in One-Touch keys or Abbreviated dialing numbers.

- 

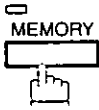
Set document(s) face down.
- 

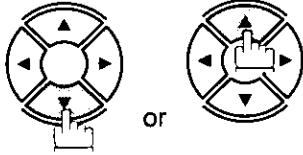
Make sure that the lamp goes off.
- 
- Enter the full station name or part of a station name by using the Character keys. (See page 14)
Ex: **P A N A** for searching **PANASONIC**
- 

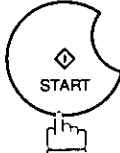
repeatedly until the display shows the station name you want to send to.
- 

The full number (e.g. 5553456) will be dialed.

ENTER STATION(S)
THEN PRESS START 00%

ENTER STATION
00%

ENTER LETTER(S)
■

ENTER LETTER(S)
PANA■

[010] PANASONIC
5553456

* DIALING *
PANASONIC

Sending Documents

Voice Mode Transmission

If you wish to send the document after talking with other party, use Voice Mode Transmission. Your machine requires an optional fax handset or an external telephone.

Off-Hook Dialing

For Off-Hook Dialing, follow the steps below.

1



Set document(s) face down.

ENTER STATION(S)
THEN PRESS START 00%

2

Lift the fax handset or the external telephone and dial the telephone number from the keypad.

Ex: ⑤ ⑤ ⑤ ① ② ③ ④

* PHONE OFF HOOK *

* DIALING *
5551234■

3

When you hear the voice of the other party, tell the other party to prepare to receive a document.

ON LINE * XMT *

Then, when you hear a beep,

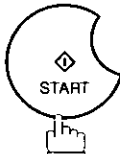

and hang up the handset.

NOTE

1. To stop the transmission, press **STOP**.
The display shows:

COMMUNICATION STOP?
1: YES 2: NO

Press ① to stop the transmission. The Communication Journal will not print out regardless of the printout mode setting of the Communication Journal.

Sending Documents

Voice Mode Transmission

On-Hook Dialing

For On-Hook Dialing, follow the steps below.

1



Set document(s) face down.

ENTER STATION(S)
THEN PRESS START 00%

2



You will hear dial tone through the monitor speaker.

* MONITOR *

3

Dial the telephone number from the keypad.

Ex: ⑤ ⑤ ⑤ ① ② ③ ④

* DIALING *
5551234■

4

When you hear a beep,

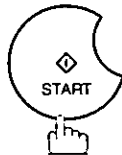

ON LINE * XMT *

NOTE

1. If you need a special access number to get an outside line, dial it first then press **PAUSE** to enter a pause (represented by a "-") before dialing the full number.
Ex: 9 **PAUSE** 5551234
2. If you are using Pulse dialing and you wish to change to Tone dialing in the middle of dialing, press **TONE** (represented by a "/").
The dialing mode will be changed from Pulse to Tone after dialing the digit "/".
Ex: 9 **PAUSE TONE** 5551234

Transmission Reservation

You can do the following while sending a document from memory or receiving a document.

- Reserve the next transmission into memory for up to 70* different files (*UF-890: 30 different files).
- Reserve a priority transmission.

Memory Transmission Reservation (Multi-tasking)

If your machine is on-line busy transmitting from memory, receiving or printing received documents, you can reserve a transmission by the following procedure.

1 Your machine is on-line, the ON LINE lamp is blinking or printing received documents.

ON LINE * PC MODE *	ON LINE * MEM.XMT * ID: (Identification)
ON LINE * PRT MODE *	ON LINE * RCV * ID: (Identification)
* PRINTING PC DATA *	* PRINTING * MEMORY RCV'D DOC
	* PRINTING * PC DATA
	ENTER STATION(S) THEN PRESS START 00%

2  Set document(s) face down.

3 
Make sure that the MEMORY lamp is on.
If not, press "On". MEMORY to set "On".

4 Dial by any combination of the following methods:

- One-Touch Dialing
- Abbreviated Dialing
- Manual Number Dialing, press SET after each station is entered
(UF-990: Up to 70 stations, UF-890: Up to 32 stations)
- Directory Search Dialing, press SET after each station is entered
(For details, see page 47 to 50.)

Ex: 01

<01>(Station name)
5551234

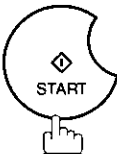
5 

Your machine will store the document(s) into memory.

* STORE * NO.005
PAGES=001 01%

* STORE * COMPLETED
TOTAL PAGE=005 25%

NOTE

1. To cancel the memory transmission reservation, see page 82
2. If the same station has been reserved with different files, the files will be executed in a single transmission (Batch Transmission). (See page 66)

Sending Documents

Transmission Reservation

Direct Transmission Reservation (Priority Transmission Reservation)

If you are in a rush to send an urgent document, however there are many files in the memory, use Direct Transmission Reservation to send the urgent document. The urgent document will be sent immediately after the current communication is finished.

Note that you cannot send documents to multiple stations.

To reserve your machine for sending the urgent documents

- 1** Your machine is on-line, the ON LINE lamp is blinking or printing received documents.

ON LINE * MEM.XMT *
ID: (Identification)

ON LINE * PC MODE *

ON LINE * RCV *
ID: (Identification)

ON LINE * PRT MODE *

* PRINTING *
MEMORY RCV'D DOC

* PRINTING PC DATA *

* PRINTING *
PC DATA

2



Set document(s) face down.

ENTER STATION(S)
THEN PRESS START 00%

3

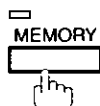

Make sure that the lamp goes off.

ENTER STATION 00%

4

Dial by using any one of the following methods:

- One-Touch Dialing
- Abbreviated Dialing
- Manual Number Dialing and press **START**
- Directory Search Dialing and press **START**
(For details, see pages 52 to 54.)

Ex:

You can reserve sending an urgent document to a single station only.

A message "DIRECT XMT RESERVED" will be shown on the display.

<01>(Station name)
5551234

Transmission Reservation

To cancel the direct transmission reservation

1

Make sure the document is on the ADF.

```
DIRECT XMT RESERVED  
<01>(Station name)
```

2



```
CANCEL XMT RESERVE ?  
1:YES 2:NO
```

3



and then remove the document from ADF.

Sending Documents

Redialing

Automatic Redialing

If a busy line is detected, the machine will redial the number up to 5 times at 3 minutes interval. However, if a busy line is not detected, the machine will redial only one time. During that time, a message will appear as shown to the right.

WAIT TO DIAL NO.001
<01>(Station name)

A file number is shown in the upper right hand corner of the display if it is a memory transmission file.

Manual Redialing

You can also redial the last dialed number manually by pressing **REDIAL** key.

To redial the last dialed number through memory

1



Set document(s) face down.
Make sure that the MEMORY lamp is on.

ENTER STATION(S)
THEN PRESS START 00%

2

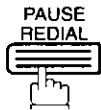

TEL. NO.
5551234

3

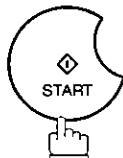

The document is stored into memory with a file number.
Then dials the last dialed number.

* STORE * NO.002
PAGES=001 01%

* DIALING * NO.002
5551234

To redial the last dialed number through ADF

1



Set document(s) face down.

ENTER STATION(S)
THEN PRESS START 00%

2

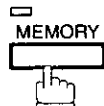

Make sure that the lamp goes off.

ENTER STATION
00%

3

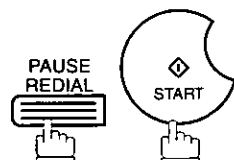

Your machine starts to dial the last dialed number.

PRESS START TO DIAL
5551234

* DIALING *
5551234

NOTE

1. While the unit is displaying "WAIT TO DIAL", you can press **REDIAL** to start redialing immediately.

Receiving Documents

General Description

Your machine is provided with both automatic and manual reception modes. The selection of either reception mode is made with Fax Parameter No. 17 (RCV MODE).

Automatic Reception

Your machine will receive documents automatically if the Fax Parameter No. 17 (RECEIVE MODE) is set to "Auto".

Manual Reception

You may wish to receive documents manually if you use the telephone line in your office primarily as a personal telephone and occasionally for your facsimile machine.

To receive documents manually, change the Fax Parameter No. 17 (RECEIVE MODE) to "Manual" and the following message will be shown on the display.

MAR-12-2002 15:00
MANUAL RCV 00%

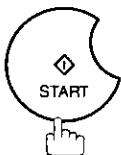
- 1** When the telephone rings, lift the handset. (See Note 1)
If you hear a beep, the sound tells you that someone wants to send a document.
- 2** Remove any documents from the ADF.
- 3** 
Your machine starts receiving the document.
- 4** Hang up the telephone.

NOTE

- Your machine requires an optional fax handset or an external telephone connected to the TEL jack on the left side of the machine.*
- If you receive a document with Super Fine resolution (406 pels/inch x 391 lines/inch), it might be divided into multiple pages with no reduction.*

Receiving Documents

Print Reduction

This machine can use Letter, Legal or A4 size plain paper for recording. Sometimes, oversized documents sent to you by the other parties cannot be printed within a single page. When this occurs, the document will be divided into separate pages.

This machine is equipped with a Print Reduction function to solve this problem. You may select the most appropriate setting from the selections described below.

1. Automatic Reduction

Each page of a received document is first stored in memory. Based on the document length, your machine will automatically calculate the suitable reduction ratio (70% to 100%) to print the entire document on a single page. If the received document is extremely long (over 39% longer than the recording paper), the document will be divided into separate pages and print without reduction.

2. Fixed Reduction

You can pre-determine the reduction ratio from 70% to 100% in 1% steps. The document(s) you receive will be reduced to the fixed ratio regardless of size.

Selecting the Print Reduction Mode

Set Fax Parameters as shown below.

1. To set Automatic Reduction mode.

- 1) No. 24 Print Reduction set to "Auto".

2. To set Fixed Reduction mode.

- 1) No. 24 Print Reduction set to "Fixed".
- 2) No. 25 Reduction Ratio set to any number between 70% through 100%. (See Note 1)
Ex: A4 to A4 - 96%
A4 to Letter - 90%
Letter to Letter - 96%
Legal to Letter - 75%

NOTE

1. If the sending side is set to print the header on the outside of the copy area, more reduction ratio will be required.

Receiving Documents

Receiving Oversize Documents

If the received document is extremely long (over 39% longer than the recording paper), the document will be divided into separate pages. When printing on separate pages, the bottom 0.4 in (10 mm) of first page will be overlapped on top of the next page.

Transmitted Document

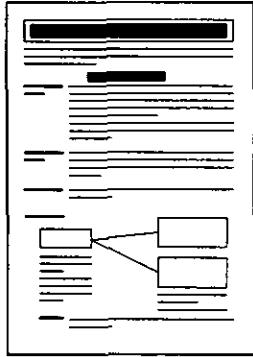

Received Document

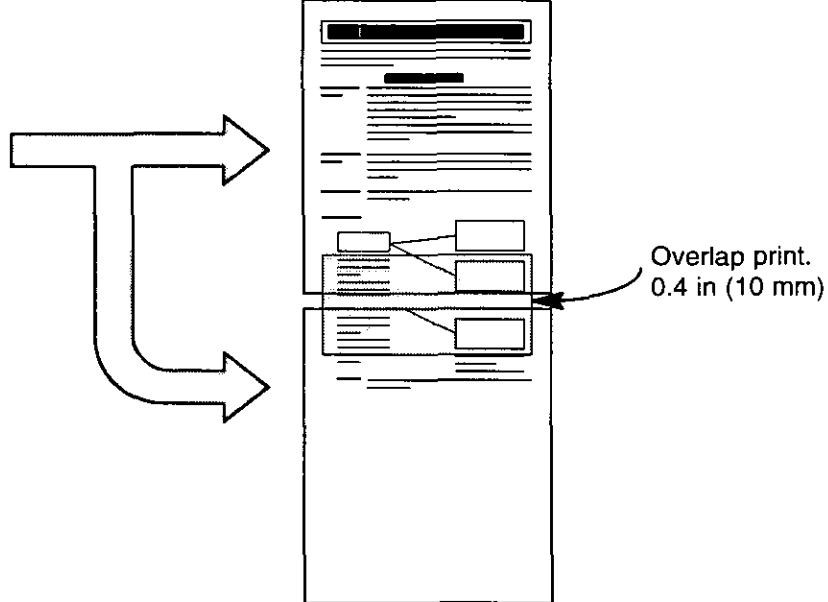

The receiving document is divided into two sheets with overlap printing.

NOTE

1. If the reduction method is set to the Automatic Reduction mode, the document is printed out with no reduction when printing out separate pages. If the reduction method is set to Fixed Reduction mode, the document is printed out by the ratio you set in Fax Parameter No. 25.

Receiving Documents

Substitute Memory Reception

If the recording paper runs out or jams or if the toner runs out during reception, the machine automatically starts receiving documents into its image data memory. Stored documents are printed automatically after replacing the recording paper or the toner cartridge. (See Note 1 and 2)

1 When the machine finishes the memory reception and there is no recording paper or toner, an Information Code appears on the display.

NO RECORDING PAPER
INFO. CODE=010

2 Install the recording paper (See page 20) or replace the toner cartridge (See page 18).

OUT OF TONER
INFO. CODE=041

* PRINTING *
MEMORY RCV'D DOC

The machine will automatically start printing the document stored in the memory.

Print Collation Mode

The printing mechanism of your machine is a Reverse Order Stacking construction. Your machine has a Print Collation Mode that stacks received documents in the correct order. When the Print Collation Mode is enabled, all received documents are stored into memory first, then printed out in Correct Order Stacking. The requirements for the Print Collation Mode to be active are; 1) Fax Parameter No. 65 PRINT COLLATION set to "Valid", and 2) enough remaining memory.

The unit will print in Reverse Order Stacking (Non-Collation Mode) whenever one of the above requirements is not met.

To use this function, we recommend installing an Optional Flash Memory Card. See page 156 (Options and Supplies).

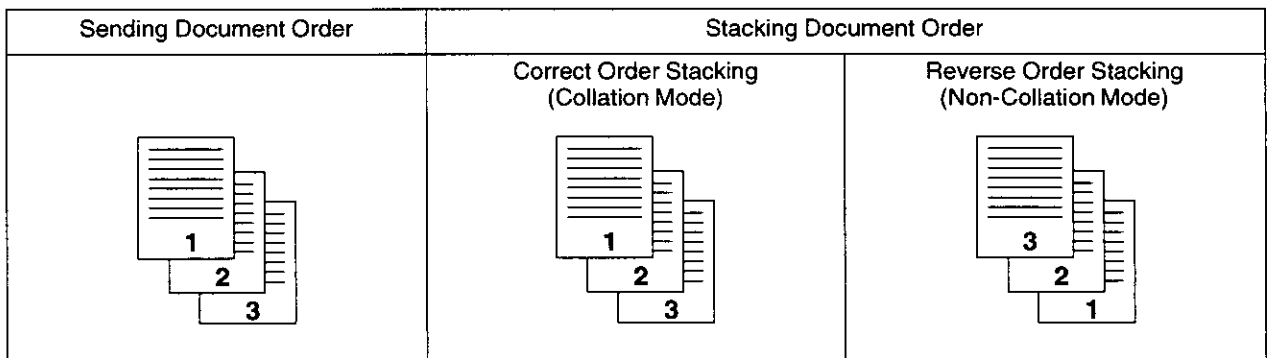

NOTE

1. If the memory overflows, the machine will stop receiving and release the communication line. The document(s) stored in the memory up to that moment will be printed out.
2. If you wish to turn off the substitute reception function, change the setting of Fax Parameter No. 22 to "Invalid". (See page 36)

Making Copies

Your machine has a copy function which can make single or multiple copies. When copying, your machine will automatically select Fine resolution.

1



Set document(s) face down.

```
ENTER STATION(S)  
THEN PRESS START 00%
```

2



```
COPY  
NO. OF COPY=1
```

3

Enter the number of copies.

Ex: ① ①

```
COPY  
NO. OF COPY=10
```

4

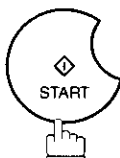

The machine stores the document, then prints the copies.

```
* STORE *      NO.005  
PAGES=001 01%
```

```
* COPY *  
NO. OF COPY=01/10
```

NOTE

1. The copy will be reduced automatically depending on the length of the original document. If you wish to be prompted for the reduction ratio when making copies, change the setting of Fax Parameter No. 32 (COPY REDUCTION) to "Manual".
If Copy Reduction is set to Manual, press % steps. (100% to 70%) ▼ and ▲ to set the zoom ratio in 1% steps. (100% to 70%)
2. If you make a copy with Super Fine resolution, it will be reduced slightly even if the reduction ratio is set to 100% in order to fit the data on one page.
3. Standard Resolution is not available in Copy Mode.
4. An optional D-RAM Card is required when copying a Legal size document with the settings on Super Fine resolution and the reduction ratio at 100%. If no optional D-RAM Card is installed, the bottom portion of the document will be cut off.

Batch Transmission

General Description

To reduce transmission time and cost, this feature allows your machine to accumulate different documents for the same destination(s) to be transmitted in a single phone call.

Real-time Batch Transmission

During memory transmission, your machine searches its memory for reserved files (up to 5 files) to transmit to the same destination, automatically batching and transmitting them in a single phone call.

The following is an example to show Real-time Batch Transmission. (See Note 1)

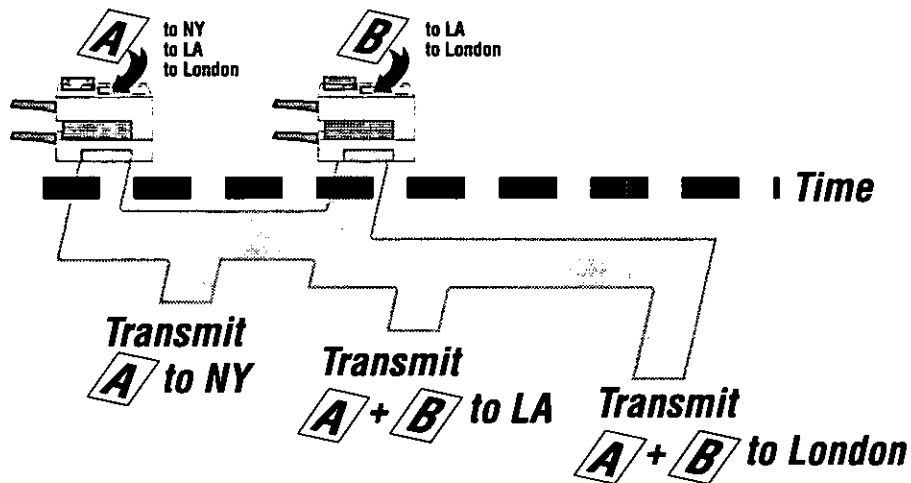

Delayed Batch Transmission

Assign a time for batch transmission to a Program Key in advance. All transmission(s) using the Program Key are batched and transmitted at the reserved time.

The following is an example to show Delayed Batch Transmission.

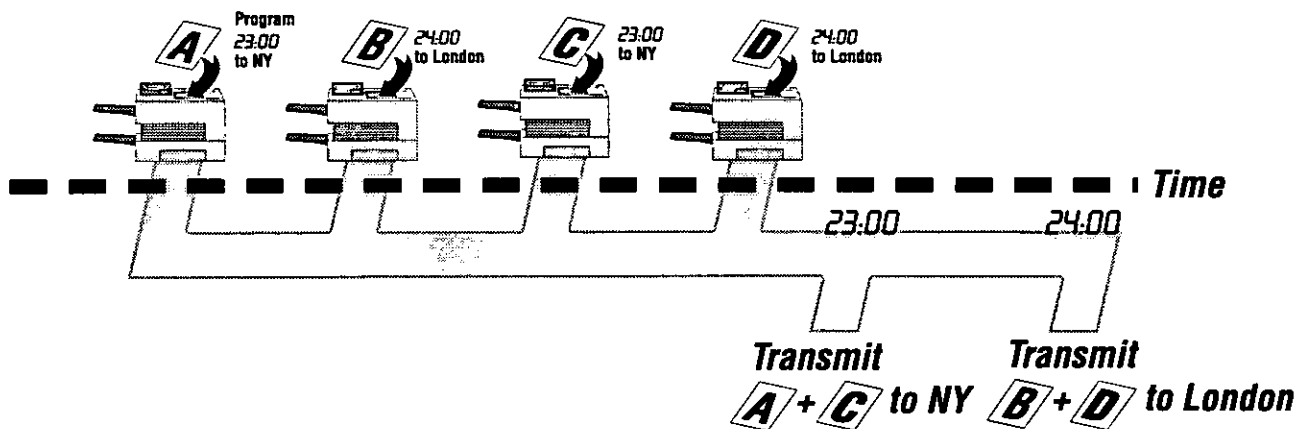

NOTE

1. The machine cannot Batch to a file(s) that is/are Waiting to Redial or currently being sent, but it will Batch to files that are pending to dial.

Timer Controlled Communications

General Description

You can send a document to one or multiple stations at any preset time within the next 24 hours. Up to 70* built-in timers can be set for deferred transmission and deferred polling. (* UF-890 : 30 built-in timers)

Deferred Transmission

1



Set document(s) face down.

```
ENTER STATION(S)  
THEN PRESS START 00%
```

2

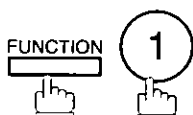

```
DEFERRED COMM. (1-2)  
ENTER NO. OR v ^
```

3

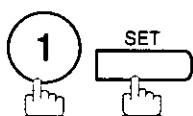

```
DEFERRED XMT  
START TIME ■ :
```

4

Enter the start time from the keypad.
(Use a 4-digit, 24-hour clock)

```
ENTER STATION(S)  
THEN PRESS START
```

Ex: ② ③ ③ ① (11:30 p.m.) and **SET**

5

Dial by any combination of the following methods:

- One-Touch Dialing
- Abbreviated Dialing
- Manual Number Dialing, press **SET** after each station is entered
(UF-990: Up to 70 stations, UF-890: Up to 32 stations)
- Directory Search Dialing, press **SET** after each station is entered
(For details, see page 47 to 50.)

Ex: 01

```
<01>(Station name)  
5551234
```

6

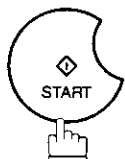

to store documents into the memory.

```
* STORE * NO.002  
PAGES=001 05%
```

```
* STORE * COMPLETED  
TOTAL PAGES=005 30%
```

NOTE

1. If you enter a wrong number in Step 4, press **CLEAR** then re-enter the right number.
2. To change or cancel the Deferred Communication settings, see page 80 and 82.
3. When you reserve a deferred transmission without storing a document into memory, the following message will be shown on the display after pressing **START** in the last step.

```
DEF DIRECT XMT RSV'D  
<01>(Station name)
```

Timer Controlled Communications

Deferred Polling

1

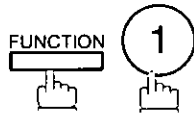

DEFERRED COMM. (1-2)
ENTER NO. OR ∨ ^

2

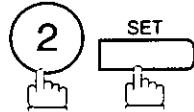

DEFERRED POLLING
START TIME ■ :

3

Enter the start time from the keypad.
(Use a 4-digit, 24-hour clock)

Ex: ① ③ ③ ① (3:30 a.m.) and

DEFERRED POLLING
PASSWORD=■■■■

4

Enter a 4-digit polling password.

Ex: ⑨ ⑧ ⑦ ⑥ and

ENTER STATION(S)
THEN PRESS START

5

Dial by any combination of the following methods:

- One-Touch Dialing
- Abbreviated Dialing
- Manual Number Dialing, press after each station is entered
(UF-990: Up to 70 stations, UF-890: Up to 32 stations)
- Directory Search Dialing, press after each station is entered
(For details, see page 47 to 50.)

Ex:

<01>(Station name)
5551234

6

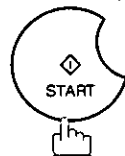

* STORE * NO.001

NOTE

1. If you enter a wrong number in Step 3, press , then re-enter the right number.
2. To change or cancel the Deferred Communication settings, see page 80 and 82.

Polling

General Description

Polling means calling other station(s) to retrieve a document. The other station must know in advance that you will call and must have a document set on the ADF or stored in the memory. You may need to set a polling password, shared by the other station, to ensure security.

Setting the Polling Password

If the polling password does not match with the polled station, your polling request will be refused automatically.

To set the polling password, follow the steps below.

1

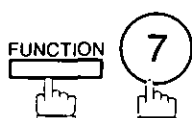

SET MODE (1-6)
ENTER NO. OR v ^

2

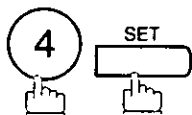

FAX PARAMETER (01-99)
NO. = ■

3

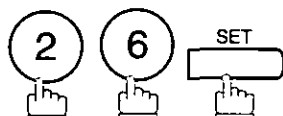

26 POLLING PASSWORD
■■■■

4

Enter a 4-digit polling password.
Ex: ① ② ③ ④

26 POLLING PASSWORD
1234

5

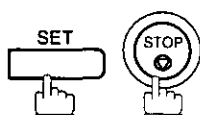

NOTE

1. Polling might not function with all fax machines. We suggest you attempt a trial polling before you actually poll important documents.
2. If a password is not set in the polled station, you may poll the other station even though your machine has a password.

Polling

Preparing to be Polled

In order to let other stations poll your machine, you must prepare your machine with a document stored in memory. Be sure to set the polling password before storing the document into memory. After being polled, the documents stored in the memory will be erased automatically. To retain the documents in memory so that they can be polled repeatedly change Fax Parameter No. 27 (POLLED FILE SAVE) to "Valid".

1



Set document(s) face down.

```
ENTER STATION(S)
THEN PRESS START 00%
```

2

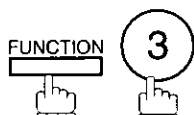

```
POLLING          NO.=■
1: POLLING 2: POLLED
```

3



```
POLLED
PASSWORD=1234
```

4

Enter a 4-digit polling password. (See Note 3)

Ex: ④ ③ ② ①

```
POLLED
PASSWORD=4321
```

5

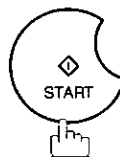

The document(s) will be stored into memory.

```
* STORE *      NO.015
PAGES=001 01%
```



```
* STORE * COMPLETED
TOTAL PAGES=005 24%
```



NOTE





1. You can still send or receive documents even when set to be polled.
2. Only 1 polled file can be stored in memory. If you need to add document(s) into the same polled file, see page 84.
3. If you have set the polling password in Fax Parameter No. 26, the password will appear on the display. You can still change the password temporarily by overwriting it with a new one.

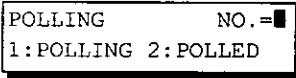

To Poll Documents from Another Station

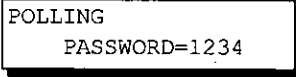
The following procedure lets you poll a document from one or multiple stations. Be sure to set the polling password before polling. (See page 69)



- 1**  

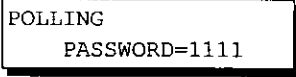

- 2** 

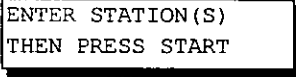

- 3** Enter a 4-digit polling password. (See Note 2)
Ex:    



- 4** 

- 5** Dial by any combination of the following methods:

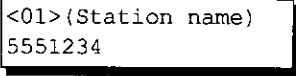
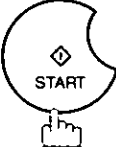

 - One-Touch Dialing
 - Abbreviated Dialing
 - Manual Number Dialing, press  after each station is entered
 (UF-990: Up to 70 stations, UF-890: Up to 32 stations)
 - Directory Search Dialing, press  after each station is entered
 (For details, see page 47 to 50.)

Ex: 

- 6** 



NOTE

1. You can review the entered stations in step 5 by pressing  or  key, press  to erase the displayed station or group as needed.
2. If you have set the polling password in Fax Parameter No. 26, the password will appear on the display.
 You can still change the password temporarily by overwriting it with a new one.

Program Keys

General Description

Your fax machine has special Program Keys. These keys are useful if you frequently need to send or poll the same group of stations. You can use these keys to store a One-Touch group key, a sequence of stations to be polled, a deferred transmission or polling sequence or an additional One-Touch key.

Setting for Group Dialing

To set a Program Key for Group Dialing

1

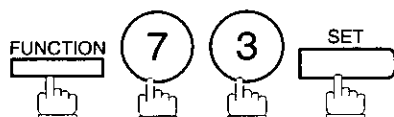

PROGRAM (1-4)
ENTER NO. OR v ^

2

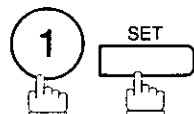

PROGRAM[P]
PRESS PROGRAM KEY

3

Ex: P1

PROGRAM[P1] NAME
ENTER NAME

4

Enter the station name (up to 15 characters) by using the Character keys. (See page 14)



Ex: PROG.A and SET

ENTER STATION(S)
THEN PRESS START

5

Enter the station numbers by using One-Touch Key or ABBR and 3-digit code.

Ex: 01 and ABBR 0 1 0

You may use the  or  keys to review the entered station(s) before going to next step. If you find an error, press CLEAR to erase the displayed station.

<01>(Station name)
5551234

[010](Station name)
5553456

6

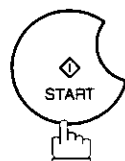

You can now set other Program Keys by repeating the procedures from Step 3, or return to standby by pressing

STOP

PROGRAM[P]
PRESS PROGRAM KEY

Setting for Deferred Transmission

To set a Program Key for deferred transmission

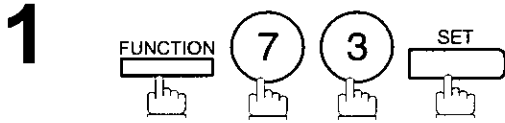

```
PROGRAM          (1-4)
ENTER NO. OR v ^
```

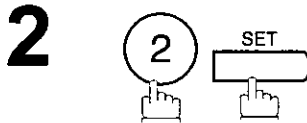

```
PROGRAM[P ]
PRESS PROGRAM KEY
```

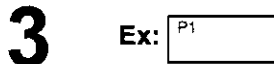

```
PROGRAM[P1]      NAME
ENTER NAME
```

4 Enter the station name (up to 15 characters) by using the Character keys. (See page 14)

Ex: PROG.A and

```
PROGRAM[P1]
PRESS FUNCTION KEY
```

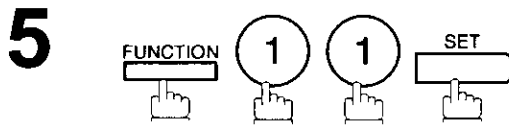

```
DEFERRED XMT
START TIME      ■ :
```

6 Enter the starting time using 4 digits.

Ex: (11:30 p.m.) and

```
ENTER STATION(S)
THEN PRESS START
```

7 Enter the station by any combination of the following methods:

- One-Touch Dialing
- Abbreviated Dialing
- Directory Search Dialing, press after each station is entered
(For details, see page 47 to 50.)

Ex:

```
<01>(Station name)
5551234
```

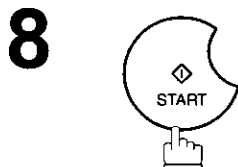

```
PROGRAM[P ]
PRESS PROGRAM KEY
```

You can now set other Program Keys by repeating the procedures from Step 3, or return to standby by pressing

Program Keys

Setting for Deferred Polling

To set a Program Key for deferred polling

1  

2  

3 Ex: 

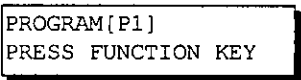
4 Enter the station name (up to 15 characters) by using the Character keys. (See page 14)
Ex: PROG.A and 

5  

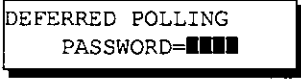
6 Enter the starting time.
Ex: (10:00 p.m.) and 

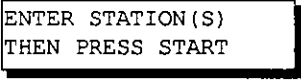
7 Enter a 4-digit polling password.
Ex: and
The polling password appears if it has been previously set. 

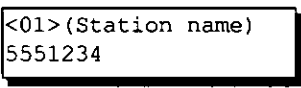
8 Enter the station by any combination of the following methods:
• One-Touch Dialing
• Abbreviated Dialing
• Directory Search Dialing, press after each station is entered
(For details, see page 47 to 50.)
Ex: 

9  

You can now set other Program Keys by repeating the procedures from Step 3, or return to standby by pressing .

Setting for Normal Polling

To set a Program Key for normal polling

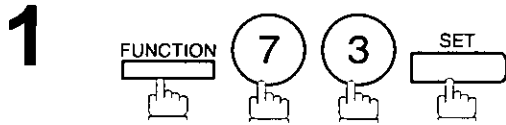

```
PROGRAM      (1-4)
ENTER NO. OR V ^
```

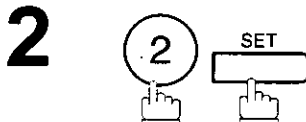

```
PROGRAM[P ]
PRESS PROGRAM KEY
```

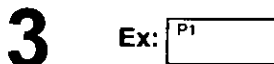

```
PROGRAM[P1]   NAME
ENTER NAME
```

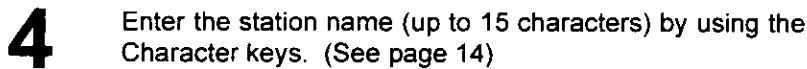

Ex: PROG.A and SET

```
PROGRAM[P1]
PRESS FUNCTION KEY
```

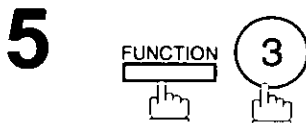

```
POLLING
PASSWORD=■■■■
```



Ex: ① ① ① ① and SET

The polling password appears if it has been previously set.

```
ENTER STATION(S)
THEN PRESS START
```

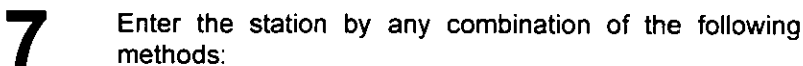

- One-Touch Dialing
- Abbreviated Dialing
- Directory Search Dialing, press SET after each station is entered (For details, see page 47 to 50.)

Ex: 01

```
<01>(Station name)
5551234
```

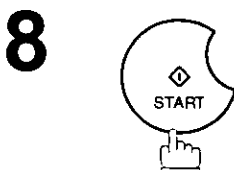

```
PROGRAM[P ]
PRESS PROGRAM KEY
```

You can now set other Program Keys by repeating the procedures from Step 3, or return to standby by pressing

STOP

Program Keys

Setting for One-Touch Key

To set a Program Key for One-Touch Key

1

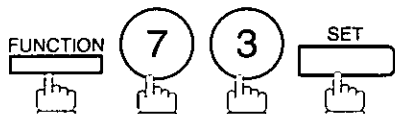

PROGRAM (1-4)
ENTER NO. OR ∨ ^

2

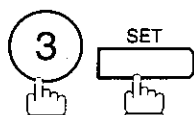

PROGRAM[P]
PRESS PROGRAM KEY

3

Ex: P1

PROGRAM[P1] NAME
ENTER NAME

4

Enter the station name (up to 15 characters) by using the Character keys. (See page 14)

Ex: PROGA and SET

[P1] PROG.A
ENTER TEL. NO.

5

Enter a telephone number (up to 36 digits including pauses and spaces).

Ex: 9 PAUSE 5 5 5 SPACE 1 2 3 4

[P1] PROG.A
9-555 1234

6

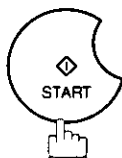

You can now set other Program Keys by repeating the procedures from Step 3, or return to standby by pressing

STOP

PROGRAM[P]
PRESS PROGRAM KEY

Changing or Erasing the Program Key Settings

To change the settings in a Program Key, follow the procedure on setting a Program Key on pages 72 to 76.

- Start time or station(s) for deferred transmission
- Station(s) for normal polling
- Start time or station(s) for deferred polling
- Station(s) for group dialing
- Telephone number and station name for One-Touch key

To erase the settings in a Program Key

1

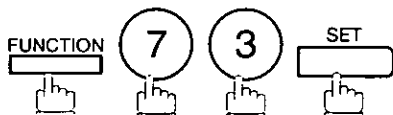

```
PROGRAM          (1-4)
ENTER NO. OR v ^
```

2

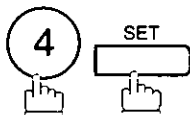

```
PROGRAM[P ]
PRESS PROGRAM KEY
```

3

Press the Program key you want to erase.

Ex:

```
PROGRAM[P1]
DELETE? 1:YES 2:NO
```

4



```
* DELETING *
PROGRAM{P1}
```

5

You can now erase other Program Keys by repeating the procedures from Step 3, or return to standby by pressing

```
PROGRAM[P ]
PRESS PROGRAM KEY
```

Edit File Mode

General Description

Your machine has a document image memory which enables you to reserve memory transmission, memory deferred transmission, memory polling and so on.

After reserving the communications in memory, you may need to change the settings of the communication(s) while it is still in memory. This section describes how to use the file editing features.

Printing a File List

The contents of the communication settings may have to be modified or deleted. To verify the contents, follow the steps below to print out a file list.

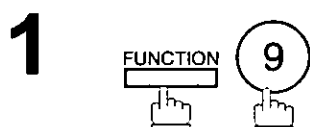

```
EDIT FILE MODE (1-6)
ENTER NO. OR v ^
```

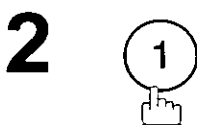

```
FILE LIST?
PRESS SET TO SELECT
```

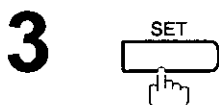

```
FILE LIST
1:PRINT 2:VIEW
```

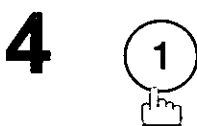

```
* PRINTING *
FILE LIST
```

Sample File List

```
***** -FILE LIST- ***** DATE MAR-12-2002 ***** TIME 15:00 *****

(1)  (2)          (3)          (4)          (5)  (6)
FILE  COMM. TYPE   CREATED TIME  START TIME  PAGES DESTINATION(S)
No.

001   DEFERRED XMT  NOV-12 13:20  20:30      [001]
002   MEM. DEF. XMT  NOV-12 13:20  22:30      003 [011] [012] [013] [016] [017]

                                           -PANASONIC -



***** -HEAD OFFICE - ***** 201 555 1212- *****
```

Explanation of Contents

- | | |
|------------------------------|--|
| (1) File number | If the file is now being executed, a "*" is indicated on the left of the file number. |
| (2) Communication type | |
| (3) Stored date/time | Date/time that these files were stored. |
| (4) Executing time | If the file is a Timer Controlled Communication, the start time is printed in this column.
If the file is an incomplete file, "INCOMP" is printed in this column. |
| (5) Number of stored page(s) | |
| (6) Destination | ABBR. No./One-Touch No./Manual Dialing No. |

Viewing the Contents of a File List

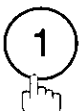

To view the contents of a file list on the display without printing it, follow the steps below.

- 1**  

EDIT FILE MODE (1-6)
ENTER NO. OR v ^
- 2** 

FILE LIST?
PRESS SET TO SELECT
- 3** 

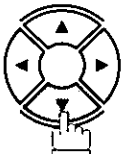
FILE LIST
1:PRINT 2:VIEW
- 4** 

USE THE v ^ KEYS TO
SCROLL EACH FILE
- 5**  or  repeatedly until the display shows a file you want to edit.

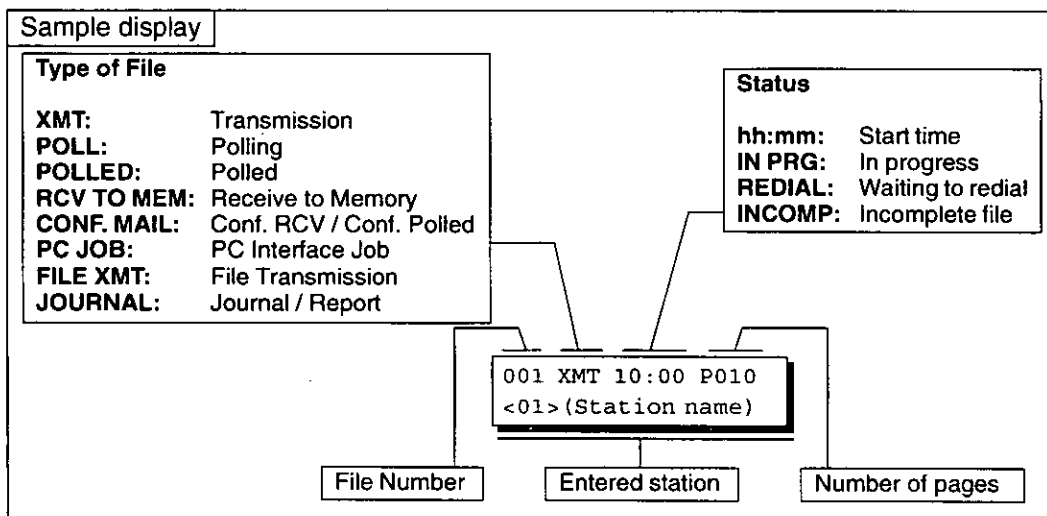





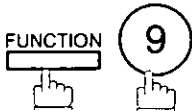
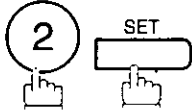

- 6** 

Edit File Mode

Changing the Start Time or the Station of a File

To change the start time and/or stations in a communication file, follow the steps below.

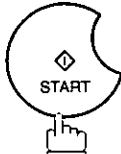
- 1**  EDIT FILE MODE (1-6)
ENTER NO. OR v ^
- 2**  ENTER FILE NO. OR v ^
FILE NO. = **000**
- 3** Enter the file number or use  or  to select the file that you want to change.
Ex: **0 0 1** ENTER FILE NO. OR v ^
FILE NO. =001
- 4**  (See Note 2) DEFERRED XMT
START TIME 22:30
- 5** Enter a new start time.
Ex: **0 6 0 0** (6:00 a.m.)
(If you do not have to change the time, skip to step 6.) DEFERRED XMT
START TIME 06:00
- 6**  <01>(Station name)
5551234
- 7** To delete the station(s), press  or  key until the station you want to delete appears. Then press **CLEAR**
or
Enter the station(s) you want to add.
Ex: 01 SET ENTER STATION(S)
THEN PRESS START
- 8**  * STORE * 005

Changing the Start Time or the Station of a File

NOTE

1. Your machine cannot change the start time and/or stations in the file while it is being sent or waiting to redial.
2. If the file is not a Deferred Communication File, the following message is shown on the display.

```
SET DEFERRED COMM. ?  
1: YES 2: NO
```

Press ① to change the type of the file for deferred communication file.

3. If you edit the file that is saved as an incomplete file, after pressing **START** in step 8, your machine will prompt you whether to execute the file immediately.
The display shows:

```
RETRY INCOMP. FILE ?  
1: YES 2: NO
```

Press ① to execute the file immediately.

Edit File Mode

Deleting a File

To delete the file in memory, follow the steps below.

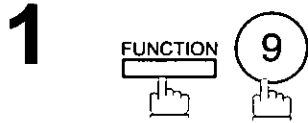

```
EDIT FILE MODE (1-6)
ENTER NO. OR V ^
```



```
ENTER FILE NO. OR V ^
FILE NO. =■■■
```

3 Enter the file number or use ▼ or ▲ to select the file that you want to delete.

```
ENTER FILE NO. OR V ^
FILE NO. =001
```

Ex: ① ① ① (See Note 2)

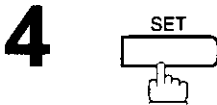

```
DELETE FILE NO.001?
1:YES 2:NO
```



```
* DELETING *
FILE NO.=001
```

Enter the next file number you want to delete or press **STOP** to return to standby.

```
ENTER FILE NO. OR V ^
FILE NO. =■■■
```

NOTE

1. Your machine cannot delete the file while it is being sent.
2. Enter * * * as the file number and press **SET** to delete all files (except the file in progress).
The following message is shown on the display.

```
DELETE ALL FILES?
1:YES 2:NO
```

Press ① to delete all files.

Printing Out a File

To print the contents of the communication file, follow the steps below.

1

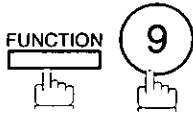

```
EDIT FILE MODE (1-6)
ENTER NO. OR v ^
```

2

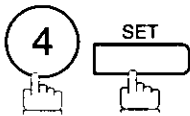

```
ENTER FILE NO. OR v ^
FILE NO. =■■■
```

3

Enter the file number or use or to select the file that you want to print.

Ex: 0 0 1

```
ENTER FILE NO. OR v ^
FILE NO. =001
```

4

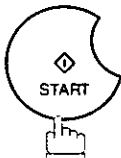

```
* PRINTING *
PAGE=001/003
```

Your machine will print the file. The document(s) will remain in memory even after printing the file.

NOTE

1. Your machine cannot print the file while it is being sent.

Edit File Mode

Adding Documents into a File

To add documents into the file, follow the steps below.

1



Set document(s) face down.

ENTER STATION(S)
THEN PRESS START 05%

2

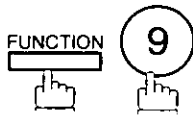

EDIT FILE MODE (1-6)
ENTER NO. OR v ^

3

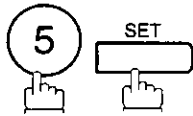

ENTER FILE NO. OR v ^
FILE NO. =■■■

Enter the file number or use ▼ or ▲ to select the file that you want to add.

ENTER FILE NO. OR v ^
FILE NO. =001

Ex: 0 0 1

4

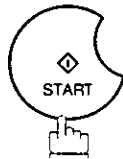

Your machine will start storing the document(s) into a file.

* STORE * NO.001
PAGES=002 10%

NOTE

1. Your machine cannot add the document into the file while it is being sent or waiting to redial.

Retry an Incomplete File

If a memory communication has been unsuccessful due to a busy line or no answer, the document you stored is automatically erased from memory after the last redial.

If you need to retain the document even if the communication failed, change the setting of Fax Parameter No. 31 (INC. FILE SAVE) to Valid in advance.

To retry the incomplete file, print a File List first to verify the file number. (See page 78)
Then, follow the steps below.

1

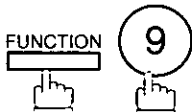

```
EDIT FILE MODE (1-6)
ENTER NO. OR v ^
```

2

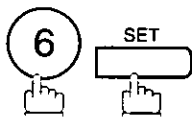

```
ENTER FILE NO. OR v ^
FILE NO. =■■■
```

3

Enter the file number or use or to select the file that you want to retry.

Ex: 0 0 1

```
ENTER FILE NO. OR v ^
FILE NO. =001
```

4

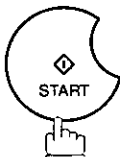

Your machine will retry the file and start dialing immediately.

```
* STORE *      NO.001
<01>(Station name)
```

```
* DIALING *    NO.001
<01>(Station name)
```

NOTE

1. To confirm or change the entered telephone number for the file, see page 78 and 80.
2. If you set Fax Parameter No.31 to Valid, all incomplete files will remain in the memory. To avoid memory overflow, please check the memory content frequently. We recommend that optional flash memory card is installed when this function is used. (See page 156)



Access Code

General Description

The Access Code prevents an unauthorized user from operating the machine. Once a 4-digit Access Code is registered, no one can operate the machine without entering the correct access code.

Automatic Receiving, however, is always available. After you complete any operation, such as mode setting or transmission, and the display returns to standby, you have to re-enter the access code in order to use the machine again. Registering the Access Code does not affect the use of the machine in any other way.

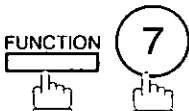
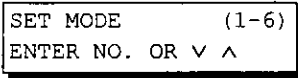
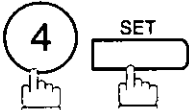
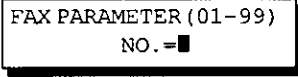
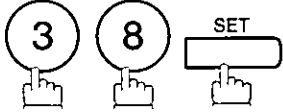
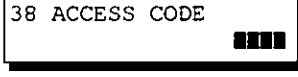
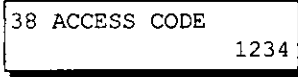
Setting the Access Code

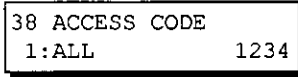
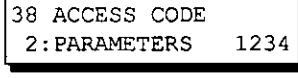
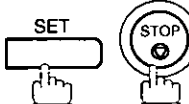
- 1**  
- 2**  
- 3**  
- 4** Enter a 4-digit Access Code.
Ex: ① ② ③ ④ 
- 5**  
- 6** Select Restriction Level.
① for All operations
or
② for Setting and Printing the Fax Parameters only.
Ex: ② 
- 7** 

NOTE

1. To erase the Access Code, enter the Access Code and press **SET** and follow the procedure above to step 3, then press **CLEAR** **SET** and **STOP**.

**Operating Your Machine with the Access Code
(Restrict all operations)**

1 Enter the Access Code.
Ex: ① ② ③ ④

MAR-12-2002 15:00
ACCESS CODE=■

MAR-12-2002 15:00
ACCESS CODE=****



2 

MAR-12-2002 15:00
00%



Now you can operate the machine normally.

**Operating Your Machine with the Access Code
(Restrict access of Fax Parameters and Journal)**

The machine can restrict the operation of setting/printing the Fax Parameters and printing the Transaction Journal when the Department Code feature is enabled.
Ex: When setting the Fax Parameter.

1  

SET MODE (1-6)
ENTER NO. OR v ^

2  

INPUT ACCESS CODE
■■■■

3 Enter a 4-digit Access Code.
Ex: ① ② ③ ④

INPUT ACCESS CODE

4 

FAX PARAMETER (01-99)
NO.=■

Now you can operate the machine normally.

Receive To Memory

General Description

This feature is used to secure all received documents by storing them into the memory. To print out the document from memory, the authorized operator must enter the correct password.

Setting the RCV To Memory Password

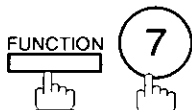
- 

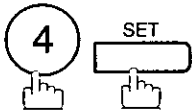
SET MODE (1-6)
ENTER NO. OR v ^
- 

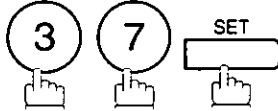
FAX PARAMETER (01-99)
NO. =■
- 

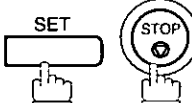
37 RCV TO MEMORY ■■■■
- Enter a 4-digit RCV to Memory Password.
Ex: ① ② ③ ④
- 

37 RCV TO MEMORY
1234

Setting RCV To Memory

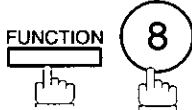
- 

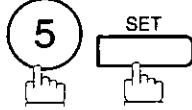
SELECT MODE (1-5)
ENTER NO. OR v ^
- 

RCV TO MEMORY=OFF
1:OFF 2:ON 3:PRINT
- 

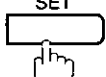
RCV TO MEMORY=ON
1:OFF 2:ON 3:PRINT
- 

MAR-12-2002 15:00
< RCV TO MEMORY >

NOTE

- When the memory overflows, the machine will stop receiving and release the line. The machine will not answer the next incoming call until there is space available in the memory.
- We recommend that optional flash memory card is installed when this function is used. See page 153 on Image Memory Capacity.

Printing Out Documents

After receiving a document with the Receive To Memory feature, the following message will appear on the display.

MESSAGE IN MEMORY
< RCV TO MEMORY >

To print the document, follow the steps below.

1

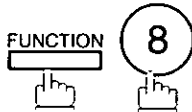

SELECT MODE (1-5)
ENTER NO. OR V ^

2

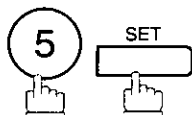

RCV TO MEMORY=ON
1:OFF 2:ON 3:PRINT

3



RCV TO MEMORY=PRINT
1:OFF 2:ON 3:PRINT

4

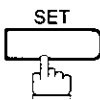

INPUT PASSWORD

5

Enter the password to print the documents.
(See Note 1)

Ex: ① ② ③ ④

INPUT PASSWORD 1234

6

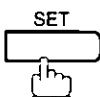

* PRINTING *
MEMORY RCV'D DOC

Machine will start to print the documents.

NOTE

1. If the password has not been set, your machine will not prompt you to enter the password.
2. The documents will be printed immediately after pressing **SET** in step 4.
3. Once the RCV TO MEMORY feature is set to "On", the password cannot be changed (Fax Parameter No. 37 will not be shown on the LCD display). If you wish to change the password, set RCV TO MEMORY feature to "Off" first. Then change the password. (See page 88)

Distinctive Ring Detector (DRD)

General Description

Your machine has a special feature in conjunction with an optional service provided by many local telephone companies. It can distinguish up to 4 telephone numbers with a corresponding ring pattern identifying each number. "DRD" lets you provide multiple phone numbers, one for your fax, business or personal use with only one single phone line.

Please check with your local telephone company on the availability of this service in your area.

Your machine can be programmed to respond to only 1 of the 4 distinctive ring patterns. To select the corresponding ring pattern for your fax number, refer to the Fax Parameter Table on page 36.

The following table shows a typical example with 4 telephone numbers on a single phone line

Telephone No.	Usage	Distinctive Ring Sound	Ring Pattern
555-1111	Business	Riiing.....Riiing.....	Type A, Standard Ring
555-2222	Fax	Ring..Ring.....Ring..Ring.....	Type B, Double Ring
555-3333	Personal	Ring..Ring..Riiing.....Ring..Ring..Riiing.....	Type C, Triple Ring (Short-Short-Long)
555-4444	Teenager	Ring..Riiing..Ring.....Ring..Riiing..Ring.....	Type D, Triple Ring (All other than type C)

The following illustration shows a typical set up, with your machine set to detect Type B (double ring) ring pattern.

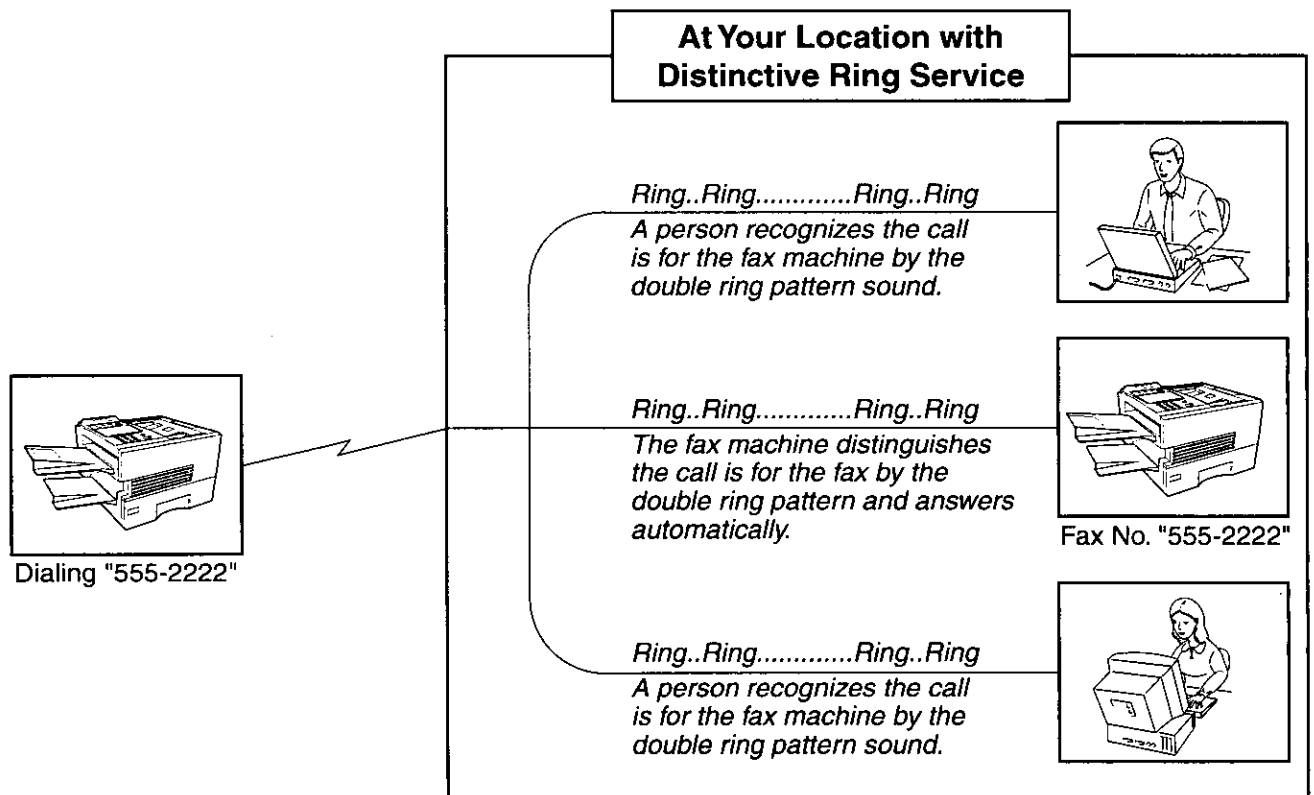

NOTE

1. "Riiing" means a long ringing sound and "Ring" means a short ringing sound.

Fax Cover Sheet

General Description

A Fax Cover Sheet can be automatically attached to your transmit document(s) that shows the recipient's name, originator's name and the number of pages attached.

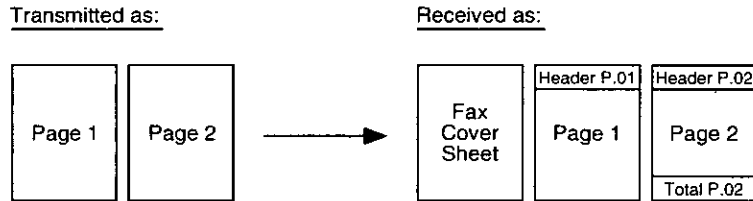

To use the Fax Cover Sheet

To attach a Fax Cover Sheet to a transmission, follow the procedure below.

1



Set document(s) face down.

ENTER STATION(S)
THEN PRESS START 00%

2

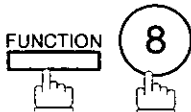

SELECT MODE (1-5)
ENTER NO. OR V ^

3

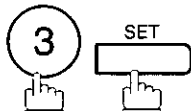

COVER SHEET=OFF
1:OFF 2:ON

4



for "OFF" (Cover Sheet is not attached)

COVER SHEET=OFF
1:OFF 2:ON

or



for "ON" (Cover Sheet is attached)

COVER SHEET=ON
1:OFF 2:ON

5

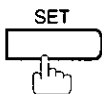

6

Dial the station(s) you wish to send the documents to.

Ex: 01

ENTER STATION(S)
THEN PRESS START 00%

NOTE

- To change the preset Fax Cover Sheet Setting, change the setting of Fax Parameter No. 56, see page 38.
- This function is available for memory or direct transmission modes.
- The Fax Cover Sheet is not counted in the number of pages column of the journals.
- When the Fax Cover Sheet setting is set to On, the Quick Memory XMT feature is disabled.

Fax Cover Sheet

To use the Fax Cover Sheet

Fax Cover Sheet Sample

***** FACSIMILE COVER SHEET *****

(1)
MAR-12-2002 15:00

(2)
Message To:

SALES DEPT.

(3)
Message From:

PANASONIC
201 555 1212

(4)
02
Page(s)
Following This Cover Page

Explanation of Contents

- (1) Starting time of communication.
- (2) Recorded name in the One-Touch, ABBR. No. or dialed telephone number.
- (3) Your LOGO (up to 25 characters) and ID Number. (Up to 20 digits)
- (4) The number of pages to follow. This information is not shown when transmitting by Direct Transmission Mode.

PIN Code Access

General Description

If your PBX requires a PIN (Personal Identification Number) code to get an outside line, your machine can be set to prompt the user to enter a PIN code before any dialing.

Selecting the Access Method (Prefix or Suffix)

1

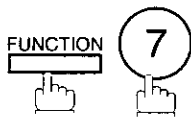

SET MODE (1-6)
ENTER NO. OR v ^

2

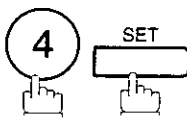

FAX PARAMETER (01-99)
NO. = ■

3

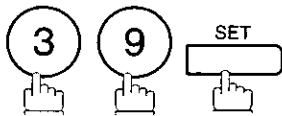

39 PIN CODE ACCESS
1: NONE

4



for suffix code.

or



for prefix code.

39 PIN CODE ACCESS
2: SUFFIX

or

39 PIN CODE ACCESS
3: PREFIX

5

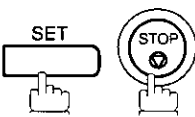

PIN Code Access

Dialing with a PIN Code

1



Set document(s) face down.

ENTER STATION(S)
THEN PRESS START 00%

2

Dial by any combination of the following methods:

- One-Touch Dialing
- Abbreviated Dialing
- Manual Number Dialing, press after each station is entered
(UF-990: Up to 70 stations, UF-890: Up to 32 stations)
- Directory Search Dialing, press after each station is entered
(For details, see page 47 to 50.)

Ex:

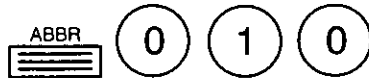

If you want to confirm the number of stations you have entered, press .

<01>(Station name)
5551234

[010](Station name)
5553456

2 STN(S) ARE SET
ADD MORE OR START

3

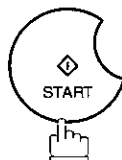

ENTER PIN CODE
█

4

Ex: (Up to 36 digits)

ENTER PIN CODE
9876█

5

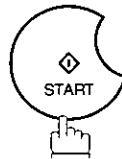

Your machine stores the document and starts dialing the PIN code and telephone number as you specified.

* STORE * NO.002
PAGES=001 05%

* DIALING * NO.002
(Station name)

NOTE



1. The PIN code is shown as " █ " on the display when dialing the number.
2. This feature is not available when dialing a number by using Off-Hook or On-Hook Direct Dialing mode.

Fax Forward

Setting Fax Forward

This feature allows all incoming faxes to be forwarded to the station registered in the one-touch or abbreviated dialing number. Once the faxes are received in the memory, the machine will forward the received document(s) to the telephone number registered in the one-touch or abbreviated dialing number.

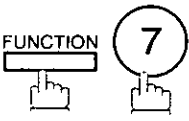
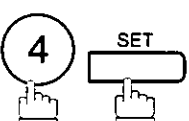
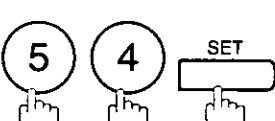
This function is convenient when you would like to receive faxes in another place (i. e. your home) at night or during a holiday.

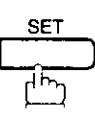
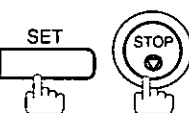
1		<div style="border: 1px solid black; padding: 2px; width: fit-content;">SET MODE (1-6) ENTER NO. OR v ^</div>
2		<div style="border: 1px solid black; padding: 2px; width: fit-content;">FAX PARAMETER (01-99) NO. =■</div>
3		<div style="border: 1px solid black; padding: 2px; width: fit-content;">54 FAX FORWARD 1:INVALID</div>
4		<div style="border: 1px solid black; padding: 2px; width: fit-content;">54 FAX FORWARD 2:VALID</div>
5		<div style="border: 1px solid black; padding: 2px; width: fit-content;">54 FAX FORWARD ENTER STATION</div>
6	Enter the station to forward the received faxes to, by assigning a one-touch key or an abbreviated dialing number. Ex: <input style="width: 50px;" type="text" value="01"/>	<div style="border: 1px solid black; padding: 2px; width: fit-content;"><01>(Station name) 5551234</div>
7		

NOTE

1. When the Fax Forward feature is set, the one-touch or the abbreviated dialing number is restricted from editing. Please change this function to "Invalid" when you would like to edit the telephone number.
2. If the communication to transfer a received document(s) fails, the received document will print out and then is erased from memory even if the Fax Parameter No. 31 (INC. FILE SAVE) is set to "Valid".
If you wish to save the document into memory in case of communication failure, set your machine to Receive To Memory. (See page 88)
3. It is not possible to receive a document if the memory of your machine overflows or is about 95% used.

File Transmission

General Description

This feature allows your machine to store the document(s) into the File Transmission in order to send to a single or to multiple locations when desired. The document(s) in the File Transmission will be kept until it is manually deleted.

Storing the Document(s)

To store the document(s), follow the steps below.

1



Set document(s) face down.

```
ENTER STATION(S)  
THEN PRESS START 00%
```

2

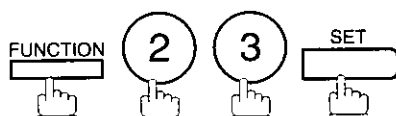

```
FILE XMT MODE (1-4)  
ENTER NO. OR v ^
```

3



```
1:STORE FILE?  
PRESS SET TO SELECT
```

4

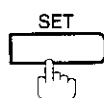

Your machine will start storing the document(s) into the memory.

```
* STORE *      NO.001  
PAGES=002 10%
```

NOTE

1. Only 1 file can be stored for File Transmission.

Sending the Stored Document(s)

To send the stored document(s), follow the steps below.

1

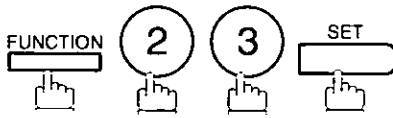

```
FILE XMT MODE (1-4)
ENTER NO. OR v ^
```

2

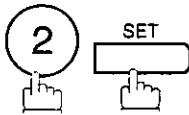

```
ENTER STATION(S)
THEN PRESS START
```

3

Dial by any combination of the following methods:

- One-Touch Dialing
- Abbreviated Dialing
- Manual Number Dialing, press **SET** after each station is entered
(UF-990: Up to 70 stations, UF-890: Up to 32 stations)
- Directory Search Dialing, press **SET** after each station is entered
(For details, see page 47 to 50.)

Ex:

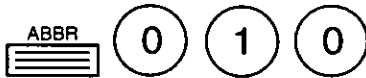

If you want to confirm the number of stations you have entered, press **SET**.

```
<01>(Station name)
5551234
```

```
[010](Station name)
5553456
```

```
2 STN(S) ARE SET
ADD MORE OR START
```

4

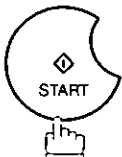

Your machine starts dialing the telephone numbers in sequence.

```
* STORE * NO.001
PAGES=001 01%
```

File Transmission

Deleting the Stored Document(s)

To delete the stored document(s), follow the steps below.

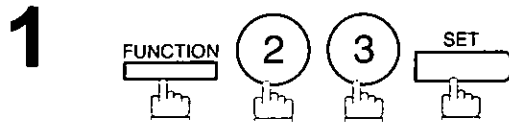

FILE XMT MODE (1-4)
ENTER NO. OR ∨ ^



3:DELETE FILE?
PRESS SET TO SELECT

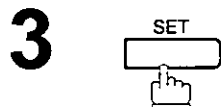

* DELETING *

Printing the Stored Document(s)

To print the stored document(s), follow the steps below.

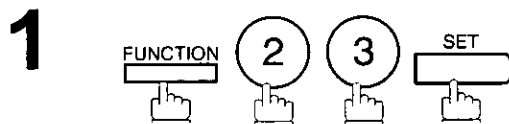

FILE XMT MODE (1-4)
ENTER NO. OR ∨ ^



4:PRINT FILE?
PRESS SET TO SELECT

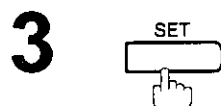

* PRINTING *
FILE XMT DOC

Your machine will print the file. The document(s) will remain in the memory even after printing the file.

Department Code

General Description









This operation requires the user to input a preset 4-digit Department Code before transmission. The Department Name of the selected Department Code is printed on the Header of each page sent, Cover Sheet, COMM

Journal and Individual Transmission Journal. When the Department Code is set, the Transaction Journal will be sorted by the Department Code number (01 - 24) when it is printed.

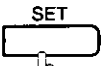
If you wish to prevent unauthorized persons from setting, changing or erasing the Department Code settings, you should set the Access Code to restrict these settings. (See page 86)

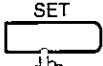
Department Code

Setting the Department Code

- | | |
|--|---|
| <p>1  </p> | SET MODE (1-6)
ENTER NO. OR ∨ ^ |
| <p>2  </p> | FAX PARAMETER (01-99)
NO.=■ |
| <p>3   </p> | 77 LOGO/DEPT. CODE
1:INVALID |
| <p>4 </p> | 77 LOGO/DEPT. CODE
3:DEPT. CODE |
| <p>5 </p> | DEPT. CODE (01-24)
ENTER NO. OR ∨ ^ |
| <p>6 Enter Department Code number.
 Ex: ① ② (01 to 24)</p> | LOGO/DEPT. NAME
12 ■ |
| <p>7 Enter your Department Name (max. 25 characters and digits) by using Character keys. (See page 14)
 Ex: PANASONIC SPACE
 SALES (See Note 1)</p> | LOGO/DEPT. NAME
12 PANASONIC SALES■ |
| <p>8 </p> | INPUT DEPT. CODE
■■■■ |
| <p>9 Enter a 4-digit Department Code.
 Ex: ① ② ③ ④</p> | INPUT DEPT. CODE
1234 |
| <p>10 </p> | LOGO/DEPT. NAME
13 ■ |
- To record another Department Code, repeat step 6 to 10.
 To return to standby, press **STOP** .

NOTE

1. Use **COPY** to copy the default LOGO which is set in the User Parameters. You can add the department name following the default LOGO.
2. When enabling the Dept. Code feature for the first time, it is important to Print the Journal by pressing **FUNCTION** , ⑥ , ① , **SET** and ① in order to erase the previous journal contents.

Changing or Erasing the Department Code

If you have to change or erase any of the Department Codes, follow the steps below.

1

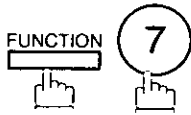

SET MODE (1-6)
ENTER NO. OR V ^

2

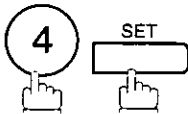

INPUT ACCESS CODE
■■■■

3

If you set the Access Code to restrict the Parameters settings, the unit prompts you to Input the Access Code. Input the Access Code and press **SET**.

FAX PARAMETER (01-99)
NO. = ■

4

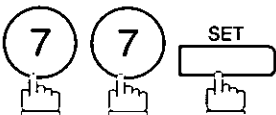

77 LOGO/DEPT. CODE
3:DEPT. CODE

5



DEPT. CODE (01-24)
ENTER NO. OR V ^

6

Enter the Department Code number you wish to change or erase.

Ex: ① ② (01 to 24)

LOGO/DEPT. NAME
12 PANASONIC SALES

7



then enter a new LOGO. (See Note 1 and 2)

Ex: **PANAFAX** **SPACE** **SALES**

or just go to step 10 to erase the Department Code.

LOGO/DEPT. NAME
12 ■

LOGO/DEPT. NAME
12 PANAFAX SALES ■

8



INPUT DEPT. CODE
1234

9



Then enter a new Department Code.

Ex: ⑤ ⑥ ⑦ ⑧

INPUT DEPT. CODE
■■■■

INPUT DEPT. CODE
5678

Continued on the next page...

Department Code

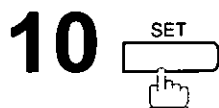

Changing or Erasing the Department Code



LOGO/DEPT. NAME
13 ■

To change or erase another Department Code, repeat step 6 to 10. To return to standby, press **STOP**.

NOTE

1. If you make a mistake, use   to move the cursor beyond the incorrect character, press **CLEAR** then re-enter the correct Department Name.
2. Use **COPY** to copy the default LOGO which is set in the User Parameters. You can add the department name following the default LOGO.

Sending Document with Department Code

1



Set document(s) face down.

ENTER STATION(S)
 THEN PRESS START 00%

2

Dial by any combination of the following methods:

- One-Touch Dialing
- Abbreviated Dialing
- Manual Number Dialing, press SET after each station is entered
(UF-990: Up to 70 stations, UF-890: Up to 32 stations)
- Directory Search Dialing, press SET after each station is entered
(For details, see page 47 to 50.)

Ex: 01

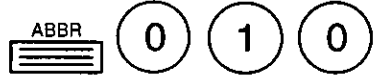

If you want to confirm the number of stations you have entered, press SET.

<01>(Station name)
 5551234

[010](Station name)
 5553456

2 STN(S) ARE SET
 ADD MORE OR START

3

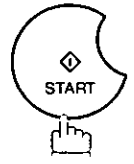

INPUT DEPT. CODE ■■■■

4

Enter a 4-digit Department Code.

Ex: 1 2 3 4

INPUT DEPT. CODE 1234

5

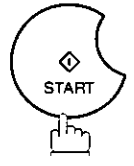

The document is sent with the header of the selected Department Name. The selected Department Name is printed on the COMM. Journal, Individual Transmission Journal and Cover Sheet.

Advanced Features

Department Code

Sending Document with Department Code (Voice Mode Transmission)

1



Set document(s) face down.

ENTER STATION(S)
THEN PRESS START 00%

2

Lift the optional handset or the external telephone or press **MONITOR**.

Ex: Press **MONITOR**

INPUT DEPT. CODE
■■■■

3

Enter a 4-digit Department Code.

Ex: ① ② ③ ④

INPUT DEPT. CODE
1234

4

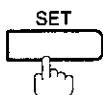

Dial the telephone number from the keypad.

Ex: ⑤ ⑤ ⑤ ① ② ③ ④

* MONITOR *

5

* DIALING *
5551234■

6

When you hear a beep,

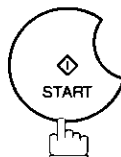

ON LINE * XMT *

The document is sent with the header of the selected Department Name. The selected Department Name is printed on the COMM. Journal, Individual Transmission Journal and Cover Sheet.

Printing a Department Code List

The Department Code List can be printed out following the Fax Parameter List.

1

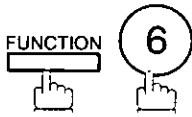

PRINT OUT (1-7)
ENTER NO. OR v ^

2

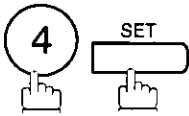

* PRINTING *
FAX PARAMETER LIST

Sample Department Code List (Prints following the Fax Parameter List)

```
***** -FAX PARAMETER LIST- ***** DATE MAR-12-2002 ***** TIME 15:00 *** P.02
```

(1) NUMBER	(2) DEPARTMENT NAME	(3) DEPARTMENT CODE
01	Panafax Sales	0001
02	Panafax Service	0002
03	Panafax Accounting	0003
}		
24	Panafax Engineering	0024

-PANASONIC -

```
***** -HEAD OFFICE - ***** - 201 555 1212 - *****
```

Explanation of Contents

- (1) Department Code Number 01-24
- (2) Department Name Up to 25 characters
- (3) Department Code 4 digits

Advanced Features

Department Code

Printing a Department Code Journal

When the Department Code is set, the Transaction Journal will be sorted by the Department Code number when it is printed. All contents of the Journal will be erased automatically after being printed.

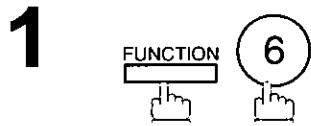

```
PRINT OUT      (1-7)
ENTER NO. OR v ^
```

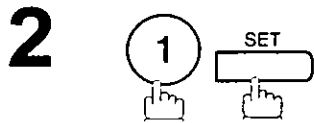

```
JOURNAL
1:PRINT 2:VIEW
```

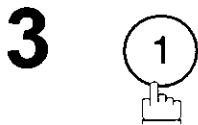

```
* PRINTING *
JOURNAL
```

Sample Department Code Journal / Originated Calls

```
***** -JOURNAL- ***** DATE MAR-12-2002 ***** TIME 15:00 *** P.01
```

ORIGINATED CALLS
MAR-10 TO MAR-12 (1)

(2) TOTAL PAGES = 000038 (3) TOTAL TIME = 00:23:56

(4) (5)
01: Panafax Sales

NO.	COMM.	PAGES	FILE	DURATION	X/R	IDENTIFICATION	DATE	TIME	DIAGNOSTIC
01	OK	005		00:05:13	XMT	☎ 5551234	MAR-10	15:10	C0044903C0000
21	OK	021/021	019	00:10:15	FWD	FAX FORWARD	MAR-10	18:10	C0044903C0000

(6) TOTAL PAGES = 000026 (7) TOTAL TIME = 00:15:28

02: Panafax Service

NO.	COMM.	PAGES	FILE	DURATION	X/R	IDENTIFICATION	DATE	TIME	DIAGNOSTIC
19	OK	001/001	017	00:00:13	XMT	☎ 5551234	MAR-11	10:10	C0044903C0000
30	OK	011/011	045	00:08:15	XMT	SERVICE DEPT.	MAR-12	13:10	C0044903C0000

TOTAL PAGES = 000012 TOTAL TIME = 00:08:28

-PANASONIC -

```
***** -HEAD OFFICE - ***** - 201 555 1212 - *****
```

Printing a Department Code Journal

Sample Department Code Journal / Received Calls

```

***** -JOURNAL- ***** DATE MAR-12-2002 ***** TIME 15:00 *** P.02

RECEIVED CALLS
MAR-10 TO MAR-12 (1)

      (2)                (3)
TOTAL PAGES = 000011    TOTAL TIME = 00:13:41

NO.  COMM.  PAGES  FILE  DURATION  X/R  IDENTIFICATION  DATE  TIME  DIAGNOSTIC
55   OK     005           00:05:13  RCV  4445678          MAR-10 12:10  C0044903C0000
56   OK     005/005  020  00:08:15  PLD  111 222 333      MAR-10 19:15  C0044903C0000

70   OK     001     017  00:00:13  RCV  44567345        MAR-11 10:10  C0044903C0000

                                     -PANASONIC
***** -HEAD OFFICE - ***** - 201 555 1212 - *****
    
```

Explanation of Contents

- (1) Date period of this journal
- (2) Number of total pages transmitted/received for this machine.
- (3) Total transmitted/received time for this machine.
- (4) Department Code Number 01-24
- (5) Department Name
- (6) Number of total pages transmitted/received for this department.
- (7) Total transmitted/received time for this department.

Multiple LOGO

General Description

This operation allows the user to select one of the 25 preset LOGOs before a transmission. The selected LOGO is printed on the Header of each page sent, Cover Sheet, COMM. Journal and Individual Transmission Journal.

Setting the Multiple LOGO

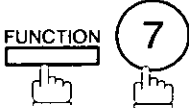
- 1** 

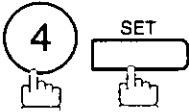
SET MODE (1-6)
ENTER NO. OR ∨ ^
- 2** 

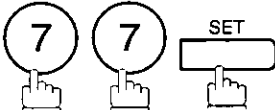
FAX PARAMETER (01-99)
NO. =■
- 3** 

77 LOGO/DEPT. CODE
1: INVALID
- 4** 

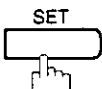
77 LOGO/DEPT. CODE
2: MULTI-LOGO
- 5** 

MULTI-LOGO (01-24)
ENTER NO. OR ∨ ^
- 6** Enter LOGO number.
Ex: ① ② (01 to 24)

LOGO/DEPT. NAME
12 ■
- 7** Enter your LOGO (max. 25 characters and digits) by using character keys. (See page 14)
Ex: P A N A S O N I C SPACE
S A L E S

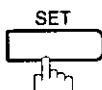
LOGO/DEPT. NAME
12 PANASONIC SALES■
- 8** 

LOGO/DEPT. NAME
13 ■

To record another LOGO, repeat step 6 to 8. To return to standby, press **STOP**.

NOTE

1. Use **COPY** to copy the default LOGO which is set in the User Parameters. You can add the department name following the default LOGO.

Changing or Erasing the Multiple LOGO

If you have to change or erase any of the Multiple LOGOs, follow the steps below.

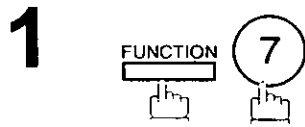

```
SET MODE      (1-6)
ENTER NO. OR v ^
```



```
FAX PARAMETER (01-99)
NO. =■
```

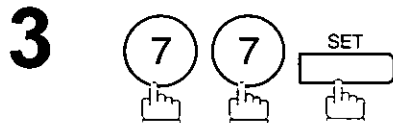

```
77 LOGO/DEPT. CODE
2: MULTI-LOGO
```

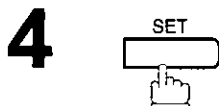

```
MULTI-LOGO (01-24)
ENTER NO. OR v ^
```

5 Enter the LOGO number you wish to change or erase.
Ex: ① ② (01 to 24)

```
LOGO/DEPT. NAME
12 PANASONIC SALES
```

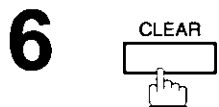

```
LOGO/DEPT. NAME
12 ■
```

then enter a new LOGO (See Note 1 and 2).

Ex: P A N A F A X SPACE S A L E S
or just go to step 7 to erase the LOGO.

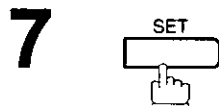

```
LOGO/DEPT. NAME
13 ■
```

To return to standby, press **STOP**.

NOTE

- If you make a mistake, use **◀ ▶** to move the cursor beyond the incorrect character, press **CLEAR** then re-enter the correct LOGO.
- Use **COPY** to copy the default LOGO which is set in the User Parameters. You can add the department name following the default LOGO.

Multiple LOGO

Sending Document with Multiple LOGO

1



Set document(s) face down.

ENTER STATION(S)
THEN PRESS START 00%

2

Dial by any combination of the following methods:

- One-Touch Dialing
- Abbreviated Dialing
- Manual Number Dialing, press after each station is entered
(UF-990: Up to 70 stations, UF-890: Up to 32 stations)
- Directory Search Dialing, press after each station is entered
(For details, see page 47 to 50.)

Ex:

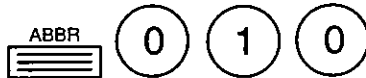

If you want to confirm the number of stations you have entered, press .

<01>(Station name)
5551234

{010}(Station name)
5553456

2 STN(S) ARE SET
ADD MORE OR START

3

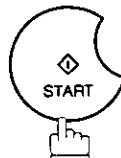

SELECT LOGO (00-24)
ENTER NO. OR V ^

4

Enter the LOGO No. or use or to select the LOGO that you want to use. (See Note 2)

Ex: ① ②

12 PANASONIC SALES

5

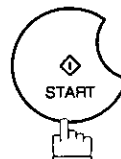

The document is sent with the header of the selected LOGO. The selected LOGO is printed on the COMM. Journal, Individual Transmission Journal and Cover Sheet.

NOTE

1. The Multiple LOGO function cannot be used in the Voice Dialing Mode.
2. If you skip selecting the LOGO in the step 4, the unit selects the default LOGO (00) which is set in the User Parameters.

Printing a Multiple Logo List

The Multiple Logo List can be printed out following the Fax Parameter List.

1

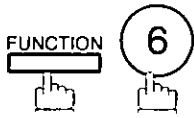

```
PRINT OUT      (1-7)
ENTER NO. OR v ^
```

2

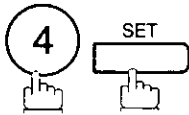

```
* PRINTING *
FAX PARAMETER LIST
```

Sample Multiple LOGO List (Prints following the Fax Parameter List)

```
***** -FAX PARAMETER LIST- ***** DATE MAR-12-2002 ***** TIME 15:00 *** P.02

MULTI-LOGO LIST
  (1)      (2)
NUMBER    LOGO
01        Panafax Sales
02        Panafax Service
03        Panafax Accounting

          )

24        Panafax Engineering

                                -PANASONIC
***** -HEAD OFFICE - ***** - 201 555 1212 - *****
```

Explanation of Contents

- (1) LOGO Number 01-24
- (2) Multiple LOGO Up to 25 characters

Advanced Features

Selective Reception

General Description

Your machine has a special feature, Selective Reception, which can prevent the receiving of unnecessary documents (i.e. junk fax, direct mail, etc.).

Before receiving the document, the last 4 digits of the ID Number received from the sending machine will be compared with the last 4 digits of the telephone number programmed in each One-Touch or Abbreviated station. When a match is found, your machine will start receiving the document. If a match is not found, your machine will cancel the reception and an Information Code 406 will be recorded on the Journal.

Setting the Selective Reception.

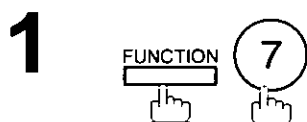

SET MODE (1-6)
ENTER NO. OR V ^

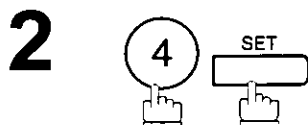

FAX PARAMETER (01-99)
NO. =■

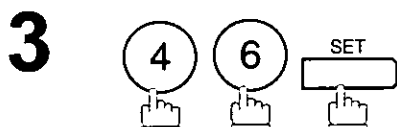

46 SELECT RCV
1:INVALID



46 SELECT RCV
2:VALID

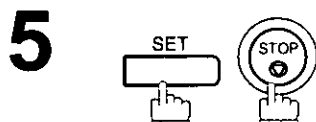

NOTE

1. When the Selective Reception is set, your machine can receive only from those stations which are programmed in the built-in auto-dialer.
2. If your ID number has not been set, your machine might not be able to receive from some models. To set your ID number, see page 29.

Password Communications

General Description

Password Communications, including Password Transmission and Password Reception will prevent your machine from sending a fax to a wrong station or receiving a fax from an unauthorized stations. You can set Password Transmission and Password Reception independently, or both together.

To use Password Transmission, you must set a 4-digit transmission password in advance. The password must be shared with other compatible Panafax machine(s). If the transmission password in your machine does not match the transmission password in the other compatible Panafax machine(s), the transmission will fail. You can select password transmission by setting Function 8-4 (PASSWORD-XMT) to "ON" when you send a document.

To use Password Reception, you must set a 4-digit receiving password in advance. The password must be shared with the other compatible Panafax machine(s). If the password in your machine does not match the receiving password in the other compatible Panafax machine(s), the reception will fail. Once you set password reception and set the parameter to "ON", it stays until you change the setting to "OFF".

Compatibility with Other Machines



You can only use password transmission and reception with another Panafax compatible machine(s) listed below.

Model	Special Settings
DF-1100	
DP-2000	
DP-2500	
DP-3000	
FP-D250F	
FP-D350F	
UF-160	
UF-160M	
UF-170	
UF-260	
UF-270	
UF-270M	
UF-280M	
UF-300	
UF-312	
UF-322	
UF-550	
UF-560	
UF-585	Required.
UF-595	Please refer to the individual User's Guide of each model.
UF-650	
UF-733	
UF-744	
UF-745	
UF-750	
UF-750D	
UF-755	
UF-755e	
UF-766	
UF-770	
UF-788	
UF-790	
UF-880	
UF-885	
UF-890	
UF-895	
UF-990	
UF-M500	

Password Communications

Setting Password Transmission

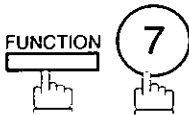
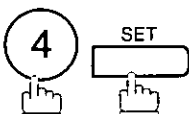
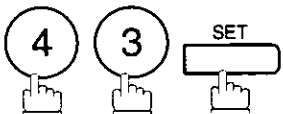
To set transmission password and parameter,

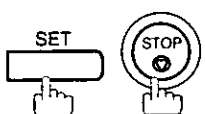
<p>1</p> 	<div style="border: 1px solid black; padding: 2px; width: fit-content;">SET MODE (1-6) ENTER NO. OR v ^</div>
<p>2</p> 	<div style="border: 1px solid black; padding: 2px; width: fit-content;">FAX PARAMETER (01-99) NO. =■</div>
<p>3</p> 	<div style="border: 1px solid black; padding: 2px; width: fit-content;">43 PASSWORD-XMT ■■■■</div>
<p>4</p> <p>Enter a 4-digit Transmission Password. Ex: ① ② ③ ④ and press SET</p>	<div style="border: 1px solid black; padding: 2px; width: fit-content;">43 PASSWORD-XMT 1: OFF 1234</div>
<p>5</p> <p> for "OFF" (password is not checked) or  for "ON" (password is checked)</p>	<div style="border: 1px solid black; padding: 2px; width: fit-content;">43 PASSWORD-XMT 1: OFF 1234</div> <p>or</p> <div style="border: 1px solid black; padding: 2px; width: fit-content;">43 PASSWORD-XMT 2: ON 1234</div>
<p>6</p> 	

NOTE

1. You can change the setting temporarily by using FUNCTION 8-4 (PASSWORD-XMT) for each transmission. See page 116 for details.
2. To change the password, press CLEAR in step 4. Then re-enter a new one.

Setting Password Reception

To set receiving password and parameter,

1

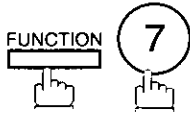

```
SET MODE      (1-6)
ENTER NO. OR v ^
```

2

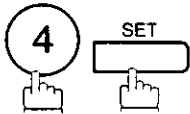

```
FAX PARAMETER (01-99)
NO. =■
```

3

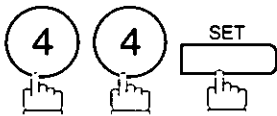

```
44 PASSWORD-RCV
```

4

Enter a 4-digit Transmission Password.
Ex: ① ② ③ ④ and press **SET**

```
44 PASSWORD-RCV
1:OFF          1234
```

5



for "OFF" (password is not checked)

or



for "ON" (password is checked)

```
44 PASSWORD-RCV
1:OFF          1234
```

or

```
44 PASSWORD-RCV
2:ON           1234
```

6

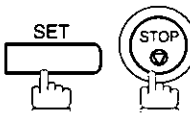

NOTE

- Once you set the parameter, you cannot select the parameter, "OFF" or "ON", for each reception. It is always "OFF" or "ON" until you change the setting.
- To change the password, press **CLEAR** in step 4. Then re-enter a new one.



Password Communications

Using Password Transmission

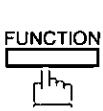

To use Password Transmission, you can select PASSWORD-XMT "OFF" or "ON" for each Transmission by following the procedure below.

- 1**  Set document(s) face down.



ENTER STATION(S)
THEN PRESS START 00%

- 2**  

SELECT MODE (1-5)
ENTER NO. OR V ^

- 3**  

PASSWD-XMT=OFF
1:OFF 2:ON

- 4**  for "OFF" (password is not checked)
or
 for "ON" (password is checked)

PASSWD-XMT=OFF
1:OFF 2:ON

or

PASSWD-XMT=ON
1:OFF 2:ON

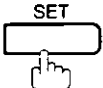
- 5** 

ENTER STATION(S)
THEN PRESS START

- 6** Dial by any combination of the following methods:
 - One-Touch Dialing
 - Abbreviated Dialing
 - Manual Number Dialing, press SET after each station is entered
(UF-990: Up to 70 stations, UF-890: Up to 32 stations)
 - Directory Search Dialing, press SET after each station is entered
(For details, see page 47 to 50.)

Ex: 01

<01>(Station name)
5551234

7

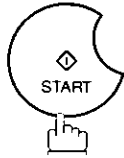

If your machine's Transmission Password coincides with the other station's Transmission Password, your machine starts sending the document.

When transmission is completed, PASSWORD-XMT returns to standard setting ("**OFF**" or "**ON**").

Using Password Reception

There is no additional operation required once you set the parameter by following the procedure on page 115. The parameter, "**OFF**" or "**ON**", cannot be selected for each reception. It is always "**OFF**" or "**ON**" until you change the setting.

Confidential Mailbox

General Description

Your machine is equipped with two Confidential Communication features which ensure that the Confidential information you send is received only by the person with the correct confidential code.

Confidential Mailbox

The confidential mailbox feature can be used as a mailbox to communicate with other compatible models using a 4-digit confidential code. The Confidential Mailbox feature receives document(s) with a confidential code into memory. These documents can only be printed by the person who has the correct confidential code.

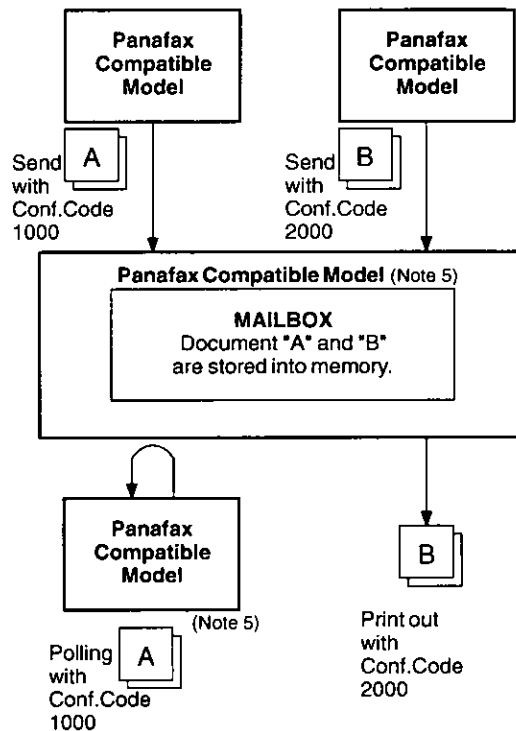

Compatibility with Other Machines

Table 1 shows a list of compatible Panafax models which have the Confidential Mailbox feature. It also shows whether or not special settings are required.

Table 1 : Confidential Mailbox Requirement

Compatible Model								Special Settings
DF-1100	DP-2000	DP-2500	DP-3000	UF-280M	UF-312	UF-322	UF-332	Not required.
UF-333	UF-342	UF-344	UF-550	UF-560	UF-585	UF-595	UF-733	
UF-744	UF-745	UF-755	UF-755e	UF-766	UF-770	UF-788	UF-790	
UF-880	UF-885	UF-890	UF-895	UF-990				

NOTE

1. If your machine receives two confidential faxes with same confidential code, both documents are stored together in the same confidential mailbox.
2. Up to 20* Mailbox files can be stored in memory. So, you can receive the confidential fax using 20* different confidential codes. (*UF-890 : Up to 10 Mailbox files)
3. If the memory overflows, the machine will stop receiving and release the line.
4. We recommend that optional flash memory card be installed when this function is used. See page 153 on Image Memory Capacity.
5. If confidential faxes were received in the mailbox of UF-733, you cannot poll those documents. The UF-733 is designed to print out the received confidential document locally only.

Sending a Confidential Document to a Remote Station's Mailbox

1



Set document(s) face down.

ENTER STATION(S)
THEN PRESS START 00%

2

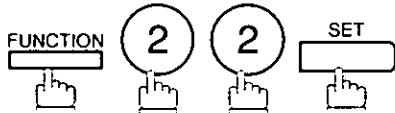

CONF. COMM. (1-5)
ENTER NO. OR v ^

3

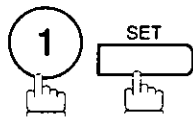

CONFIDENTIAL XMT
CONF. CODE=■■■■

4

Enter a 4-digit Confidential Code.

Ex: ②②③③

CONFIDENTIAL XMT
CONF. CODE=2233

5

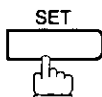

ENTER STATION
THEN PRESS START

6

Dial by any one of the following methods:

- One-Touch Dialing
- Abbreviated Dialing
- Manual Number Dialing
- Directory Search Dialing

Ex: 01

<01>(Station name)
5551234

7

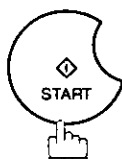

If necessary, inform the receiving person and tell them the Confidential Code.

Confidential Mailbox

Polling a Confidential Document from a Remote Station's Mailbox

After you have been informed that someone has transmitted a confidential document to a remote station's mailbox, you can poll the confidential document from the remote station by following the procedure below.

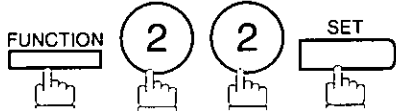
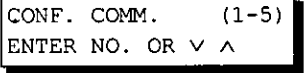
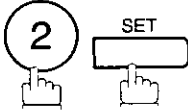
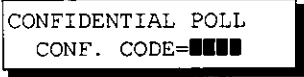
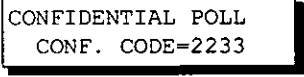
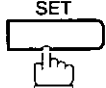
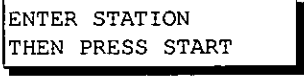
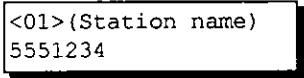
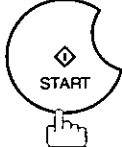
- 1**  
- 2**  
- 3** Enter a 4-digit Confidential Code.
Ex: ② ② ③ ③ 
- 4**  
- 5** Dial by any one of the following methods:
 - One-Touch Dialing
 - Abbreviated Dialing
 - Manual Number Dialing
 - Directory Search DialingEx: 
- 6** 

NOTE

1. The confidential file will be erased automatically at the center station after being polled.

Receiving a Confidential Document to Your Machine's Mailbox

No special setting is required, your machine comes with this feature ready to use. Your machine receives a confidential fax the same way it receives a normal fax message. When receiving the confidential fax, the display shows the following message (CONF. RCV REPORT) and prints out the Confidential Receive Report.

MESSAGE IN MAIL BOX

Sample CONF. RCV Report

```
***** -CONF. RCV REPORT- ***** DATE MAR-12-2002 ***** TIME 15:00 *****
** NOTICE OF CONFIDENTIAL DOCUMENT HELD **
(1)      (2)      (3)      (4)
FILE NO. RECEIVED FROM      PAGES      TIME RECEIVED
040      PANAFAX      001      MAR-12 15:00
                        -PANASONIC      -
***** -HEAD OFFICE - ***** 201 555 1212- *****
```

Explanation of Contents

- | | |
|----------------------------------|----------------------------|
| (1) File number | 001 to 999 |
| (2) Received remote station's ID | Character ID or Numeric ID |
| (3) Number of pages received | |
| (4) Received date and time | |

NOTE

1. If your machine receives two confidential faxes with same confidential code, both documents are stored together in the same confidential mailbox.
2. Up to 20* Mailbox files can be stored in memory. So, you can receive the confidential fax using 20* different confidential codes. (*UF-890 : Up to 10 Mailbox files)
3. If the memory overflows, the machine will stop receiving and release the line.
4. You can verify whether the unit has received a confidential fax by printing out the File List. (See page 78)

Confidential Mailbox

Storing a Confidential Document in Your Machine's Mailbox

Use the following procedure to store a document in a confidential mailbox in your machine. Once the confidential document is stored in your machine, it can be polled by another machine.

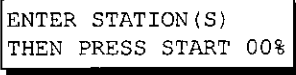
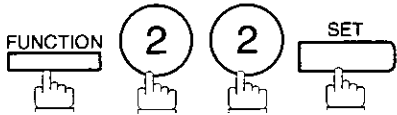
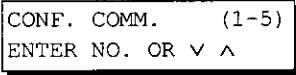
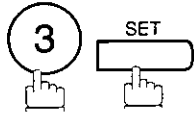
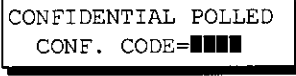
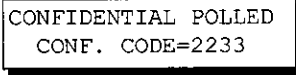
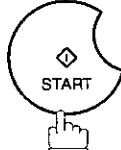
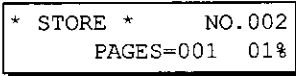
- 1**  Set document(s) face down.

- 2**  
- 3**  
- 4** Enter a 4-digit Confidential Code.
Ex: ② ② ③ ③ 
- 5**  

The document(s) will be stored into memory.
If necessary, inform the receiving party of the confidential document and tell them the confidential code needed to poll the document.

NOTE

1. The confidential file will be erased automatically after being polled.
If you wish to retain the confidential file even after being polled, change the setting of Fax Parameter No. 42 (CONF. POLLED FILE SAVE) to "Valid".

Printing Out a Confidential Document from Your Machine's Mailbox

After you have been notified that someone has transmitted a confidential document to your machine's mailbox, use the following procedure to print out the confidential document.

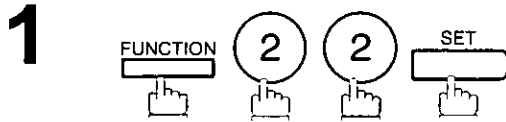

```
CONF. COMM.      (1-5)
ENTER NO. OR v ^
```



```
PRINT CONF. FILE
CONF. CODE=■■■■
```

3 Enter the Confidential Code of the document you want to print out.

```
PRINT CONF. FILE
CONF. CODE=2233
```

Ex: ② ② ③ ③

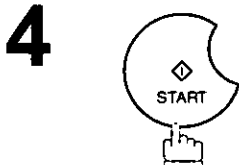

```
* PRINTING *
PAGE=001/001
```

The machine will print out the confidential documents.

NOTE

- The confidential file will be erased automatically after being printed out even if the setting of Fax Parameter No. 42 (CONF. POLLED FILE SAVE) is changed to "Valid".

Confidential Mailbox

Deleting a Confidential Document Stored in Your Machine's Mailbox



If your memory becomes full, or you just want to clean out your confidential documents, you may delete one or more confidential faxes stored in your machine by using the following procedure.

There are two types of confidential file deletions, one is to delete the file individually by its Confidential Code, and the other is to delete all confidential files in memory.

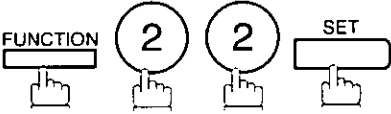
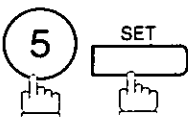
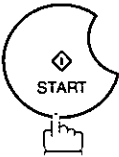
To delete a file using Confidential Code

1		<div style="border: 1px solid black; padding: 2px; width: fit-content;">CONF. COMM. (1-5) ENTER NO. OR ∨ ^</div>
2		<div style="border: 1px solid black; padding: 2px; width: fit-content;">DELETE CONF. FILE CONF. CODE=■■■■</div>
3	Enter a 4-digit Confidential Code. Ex: ② ② ③ ③	<div style="border: 1px solid black; padding: 2px; width: fit-content;">DELETE CONF. FILE CONF. CODE=2233</div>
4		<div style="border: 1px solid black; padding: 2px; width: fit-content;">* DELETING * CONF. CODE=2233</div>

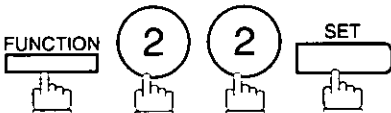
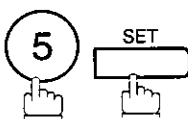
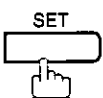
To delete all confidential files in memory

1		<div style="border: 1px solid black; padding: 2px; width: fit-content;">CONF. COMM. (1-5) ENTER NO. OR ∨ ^</div>
2		<div style="border: 1px solid black; padding: 2px; width: fit-content;">DELETE CONF. FILE CONF. CODE=■■■■</div>
3		<div style="border: 1px solid black; padding: 2px; width: fit-content;">DELETE ALL CONF. FILES? 1:YES 2:NO</div>
4		<div style="border: 1px solid black; padding: 2px; width: fit-content;">* DELETING * ALL CONF. FILES</div>

Sub-Addressing

General Description

The Sub-Addressing function allows you further routing, forwarding or relaying of document(s) to the desired recipient(s) when used in combination with Panasonic Internet Fax capable models and/or the Networking version of HydraFax/LaserFAX software. This function conforms to the ITU-T recommendation for T. Routing-Facsimile Routing utilizing the Sub-Address.

Example of a Network

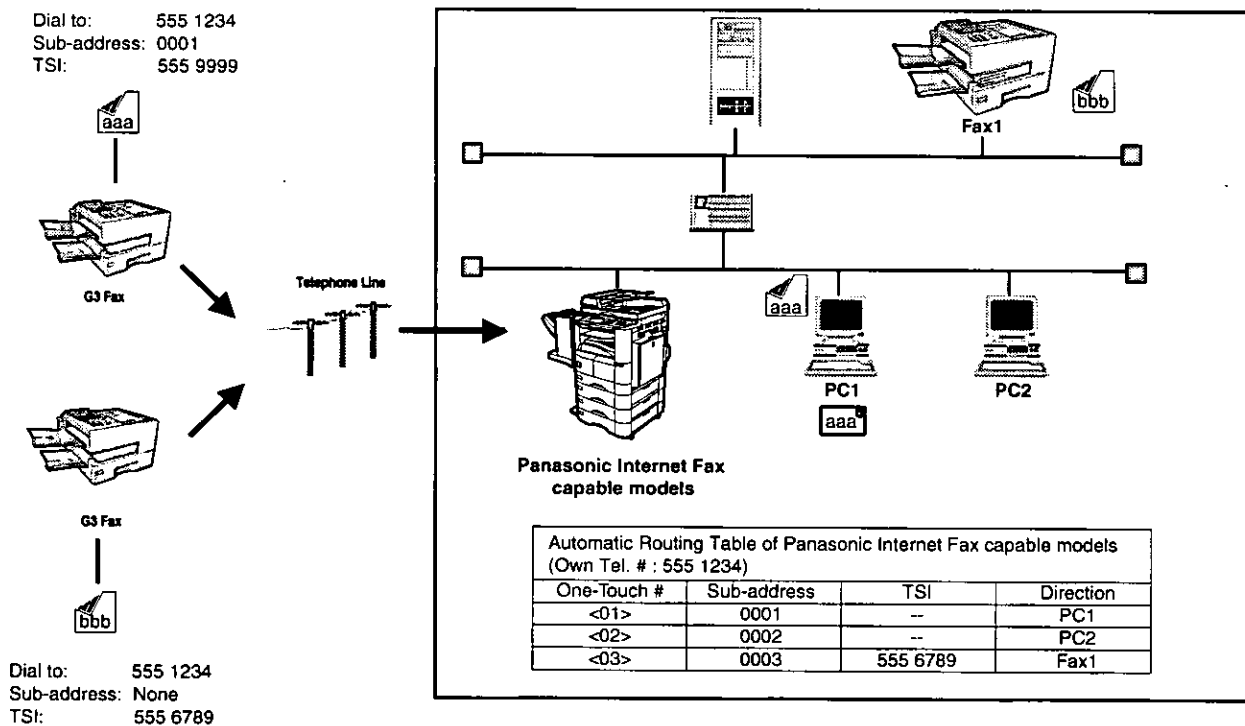

Compatibility with Other Machines

- Sub-addressing Transmission: DF-1100/DP-135FP/150FP/150FX/DP-2000/2500/3000/DX-1000/2000/FP-D250F/D350F/UF-332/333/342/344/490/550/560/585/595/770/788/790/880/885/890/895/990 (see Note 2)
- Sub-addressing Reception: DX-1000/2000/DP-2000/2500/3000 with I-FAX Option and DF-1100/UF-342/344/550/560/585/595/770/788/880 with PC Interface using the Networking version of HydraFax/LaserFAX software.

Sub-addressing Transmission Methods

You can send a document with Sub-address information to the desired recipient by the following methods.

- By registering the Sub-address information into One-Touch/ABBR. Dialing Numbers.
- By specifying the Sub-address information in the Manual Number Dialing Mode.

Setting of Routing, Forwarding or Relaying

You can customize the Automatic Routing to any combination of LAN (Local Area Network), PSTN (Public Switched Telephone Network) or PBX Extension with Panasonic Internet Fax capable models and/or HydraFax/LaserFAX Routing Table (Please refer to the operating instructions of the applicable Panasonic models and/or the HydraFax/LaserFAX User Manual).

NOTE

1. HydraFax and LaserFAX are trademarks of Wordcraft International Ltd.
2. UF-788 with PC Interface Option or the Option ROM installed.

Sub-Addressing

To set the Sub-address into a One-Touch/ABBR. Dialing Numbers

1

FUNCTION 7 2 SET

1:ONE-TOUCH
2:ABBR NO.

2

1

to select "One-Touch".

ONE-TOUCH< >
PRESS ONE-TCH OR v ^

or

or

2

to select "ABBR.NO.".

ABBR. []
ENTER NO. OR v ^

Ex: ①

3

Ex: 01

<01>
ENTER TEL. NO.

4

Enter the telephone number, press **SUB-ADDR** then enter the Sub-address. (Up to 20 digits)
(Up to 36 digits including telephone number, pauses, spaces, FLASH and Sub-address)

Ex: Telephone number = 5551234, Sub-address =2762

Enter as: ⑤ ⑤ ⑤ ① ② ③ ④

SUB-ADDR ② ⑦ ⑥ ②

<01>
5551234s2762

5

SET

Enter the station name.

<01> SALES DEPT
5551234s2762

6

SET STOP

NOTE

1. **SUB-ADDR** separates the Sub-address from the Telephone number and is indicated by an "s" in the display.

To send a Document with Sub-address

Using One-Touch/ABBR. Number Dialing

The operation is the same as for normal dialing

1  Set document(s) face down.

```
ENTER STATION(S)
THEN PRESS START 00%
```

2 Ex:

```
<01>(Station name)
5551234s2762
```

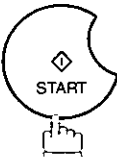
3 

```
* STORE *      NO.001
      PAGES=001 01%
```

The document is stored into memory and your machine starts to dial the number of the station and sends the document(s) with Sub-addressing information.

Using Manual Number Dialing

Use **SUB-ADDR** to separate the Telephone number and the Sub-address.

1  Set document(s) face down.

```
ENTER STATION(S)
THEN PRESS START 00%
```

2 Enter the telephone number, press **SUB-ADDR** then enter the Sub-address (up to 20 digits).
(Up to 36 digits including telephone number, pauses, spaces, FLASH and Sub-address)

```
TEL. NO.
5551234s2762
```

Ex: Telephone number = 5551234, Sub-address =2762

Enter as: (5) (5) (5) (1) (2) (3) (4)
SUB-ADDR (2) (7) (6) (2)

```
* STORE *      NO.001
      PAGES=001 01%
```

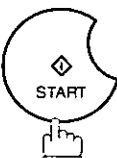
3 

The document is stored into memory and your machine starts to dial the number of the station and sends the document(s) with Sub-addressing information.

NOTE

- SUB-ADDR** separates the Sub-address from the Telephone number and is indicated by an "s" in the display.
- Manual Off-Hook or On-Hook Dialing cannot be used with the Sub-addressing Transmission.
- The Sub-address is not transmitted during Manual Redial Mode.

Journals and Lists

General Description

To help you maintain records of the documents you sent and received, as well as lists of the numbers you record, your facsimile machine is equipped to print the following journals and lists: Transaction Journal, Individual Transmission Journal, Communication Journal, One-Touch/Abbreviated/Directory Search No. List, Program List, Fax Parameter List, Directory Sheet and File List.

Transaction Journal

The "Journal" is a record of the last 100 transactions (a transaction is recorded each time you send or receive a document). It is printed out automatically after every 100 transactions (See Note 1) or you can print or view it manually by using the following procedure:

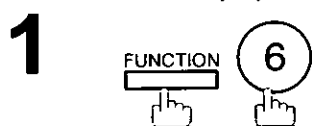

PRINT OUT (1-7)
ENTER NO. OR v ^

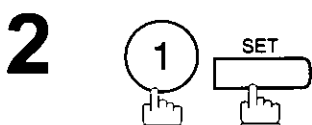

JOURNAL
1:PRINT 2:VIEW

3a ① to print a Journal

* PRINTING *
JOURNAL

3b ② to view a Journal

JOURNAL VIEW
1:XMT ONLY 2:ALL

4 Select the viewing mode.
① to view transmission transactions only
② to view all transactions

USE THE v ^ KEYS TO
SCROLL EACH RECORD

Ex: ②

You can view the transactions in the journal by pressing

▼ or ▲ . Press **STOP** to return to standby.

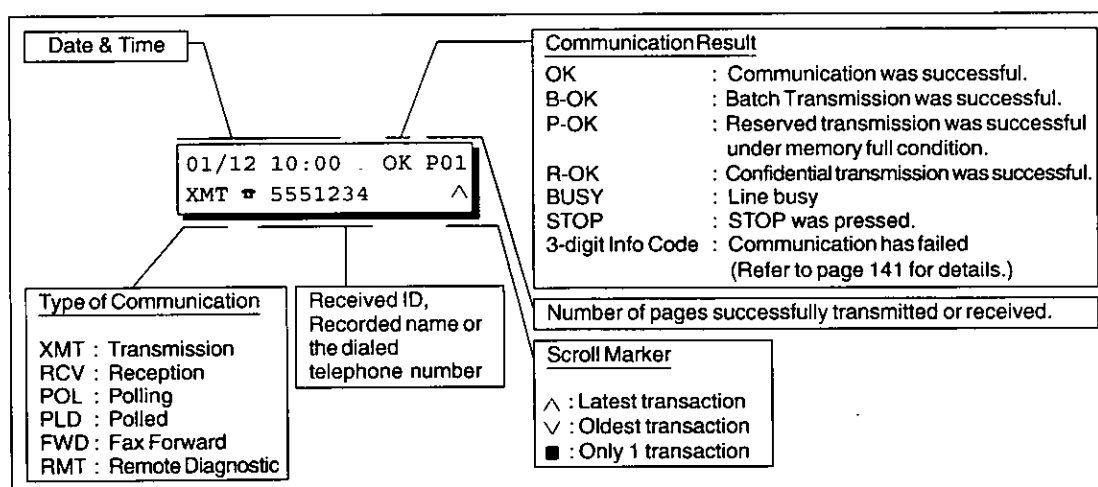

NOTE

1. If you wish to disable the automatic print out of the Transaction Journal, change the setting of Fax Parameter No. 13 to "Invalid". (See page 36)

Individual Transmission Journal (IND. XMT JOURNAL)

An Individual Transmission Journal contains the information on the latest transmission.

1

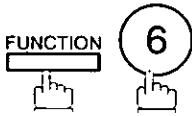

PRINT OUT (1-7)
ENTER NO. OR v ^

2



6:IND. XMT JOURNAL?
PRESS SET TO PRINT

3



* PRINTING *
IND. XMT JOURNAL

Journals and Lists

Individual Transmission Journal (IND. XMT JOURNAL)

Sample Transaction Journal

***** -JOURNAL- ***** (1) (2) DATE MAR-12-2002 ***** TIME 15:00 *****									
(3)	(4)	(5)	(6)	(7)	(8)	(9)	(10)	(11)	(12)
NO.	COMM.	PAGES	FILE	DURATION	X/R	IDENTIFICATION	DATE	TIME	DIAGNOSTIC
01	OK	005/005	001	00:00:22	XMT	SERVICE DEPT.	MAR-11	17:35	C0044903C0000
02	OK	003	002	00:01:17	RCV	111 222 333	MAR-11	17:41	C0044903C0000
03	OK	001	003	00:00:31	XMT	ACCOUNTING DEPT.	MAR-11	17:50	C0044903C0000
04	630	000/005	004	00:00:00	XMT	☎ 342345676	MAR-11	17:57	0800420000000
05	STOP	000	005	00:00:34	XMT	☎ 12324567	MAR-11	18:35	0210260200000
06	OK	001/001	006	00:00:20	XMT	☎ 44567345	MAR-11	18:44	C8044B03C0000
07	408	*003	007	00:02:14	XMT	☎ 2345678	MAR-11	18:55	0040440A30080
31	OK	002/002	050	00:00:31	XMT	☎ 0245674533	MAR-12	08:35	C8044B03C1000
32	OK	003/003	051	00:01:32	XMT	☎ 0353678980	MAR-12	08:57	C8044B03C1000
(13) -PANASONIC -									
***** -HEAD OFFICE - ***** (15) 201 555 1212- ***** (14)									

Sample Individual Transmission Journal (IND. XMT JOURNAL)

***** -IND. XMT JOURNAL- ***** (1) (2) DATE MAR-12-2002 ***** TIME 15:00 *****									
(10)	(11)	DATE/TIME = MAR-12-2002 09:00							
(3)	JOURNAL No. = 21								
(4)	COMM. RESULT = OK								
(5)	PAGE(S) = 001/001								
(7)	DURATION = 00:00:16								
(6)	FILE No. = 010								
(16)	MODE = TRANSMISSION								
(17)	DESTINATION = [001] / 555 1234 / ABCDEFG								
(18)	RECEIVED ID =								
(19)	RESOLUTION = STD								
(13) -PANASONIC -									
***** -HEAD OFFICE - ***** (15) 201 555 1212- ***** (14)									

Individual Transmission Journal (IND. XMT JOURNAL)

Explanation of Contents

- | | |
|---|---|
| (1) Printout date | |
| (2) Printout time | |
| (3) Journal number | |
| (4) Communication result | <p>"OK" indicates that the communication was successful.
 "BUSY" indicates that the communication has failed because of busy line.
 "STOP" indicates that STOP was pressed during communication.
 "B-OK" indicates that the Batch Transmission was successful.
 (All batched files are listed below the batched transaction.)
 "M-OK" indicates that the substitute reception message in memory was not printed out.
 "P-OK" indicates that memory overflow or document misfeeding occurred while storing the documents into memory for transmission but successfully stored document(s) was sent.
 "R-OK" indicates that the Confidential Communication was successful.
 "3-digit Info Code (See page 141) indicates that the communication has failed.</p> |
| (5) Number of pages transmitted or received | <p>The 3-digit number is the number of pages successfully transmitted or received. When the documents are stored into memory, two 3-digit numbers will appear. The first 3-digit number represents the number of pages successfully transmitted. The second 3-digit number represents the total number of pages that were attempted to be transmitted.
 Asterisk "*" indicates that the quality of some received copies was poor.</p> |
| (6) File number | <p>001 to 999 (If the communication is stored into memory, a file number is assigned for each communication.)</p> |
| (7) Duration of communication | |
| (8) Type of communication | <p>"XMT" means Transmission
 "RCV" means Reception
 "POL" means Polling
 "PLD" means Polled
 "FWD" means Fax Forward
 "RMT" means Remote Diagnostic</p> |
| (9) Remote station identification | <p>Name : Recorded name in One-Touch or ABBR. Numbers or remote station's Character ID.
 # number: Dialed telephone number
 Number : Remote station's ID number.</p> |
| (10) Communication date | |
| (11) Communication Start time | |
| (12) Diagnostic | <p>For service personnel only</p> |
| (13) Own LOGO | <p>Up to 25 characters</p> |
| (14) Own ID number | <p>Up to 20 digits</p> |
| (15) Own Character ID | <p>Up to 16 characters</p> |
| (16) Type of communication | <p>Transmission or memory transmission</p> |
| (17) Destination | <p>If a One-Touch or ABBR was used for the transmission:
 One-Touch or ABBR. No./Telephone Number/Recorded Name
 If not : Telephone number</p> |
| (18) Received remote station's ID | <p>Character ID or ID number</p> |
| (19) Resolution | <p>"STD" means standard resolution
 "FINE" means fine resolution
 "S-FINE" means super fine resolution</p> |

Journals and Lists

Communication Journal (COMM. JOURNAL)

The Communication Journal (COMM. JOURNAL) lets you verify whether the transmission or polling was successful. You may select the printout condition (Off/Always/Inc. only) in Function 8-1 or Fax Parameter No. 12.

Sample COMM. JOURNAL

***** -COMM. JOURNAL- ***** DATE MAR-12-2002 **** TIME 15:00 *****

(1) MODE = MEMORY TRANSMISSION (2) START=MAR-12 14:50 (3) END=MAR-12 15:00

FILE NO.= 050 (4)

(5) STN NO.	(6) COMM.	(7) ABBR NO.	(8) STATION NAME/TEL NO.	(9) PAGES	(10) DURATION
001	OK	<01>	SERVICE DEPT.	001/001	00:01:30
002	OK	<02>	SALES DEPT.	001/001	00:01:25
003	407	<03>	ACCOUNTING DEPT.	000/001	00:01:45
004	BUSY		021 111 1234	000/001	00:00:00

- PANASONIC -

***** - HEAD OFFICE - ***** - 201 555 1212 - *****

THE SLEREXE COMPANY LIMITED

SAPORS LANE · BOOLE · DORSET · BH25 8ER

TELEPHONE BOOLE (945 13) 51617 · TELEX 123456

Our Ref. 350/PJC/EAC

18th January, 1972.

Dr. P.N. Cundall,
Mining Surveys Ltd

... variations of print density ...
cause the photocell to generate an analogous electrical video signal.
This signal is used to modulate a carrier, which is transmitted to a
remote destination over a radio or cable communications link.

At the remote terminal, demodulation reconstructs the video
signal, which is used to modulate the density of print produced by a
printing device. This device is scanning in a raster scan synchronised
with that at the transmitting terminal. As a result, a facsimile
copy of the subject document is produced.

Probably you have uses for this facility in your organisation.

Yours sincerely,

Phil.

P.J. CROSS
Group Leader - Facsimile Research

Communication Journal (COMM. JOURNAL)

Explanation of Contents

- (1) Indication of communication mode
- (2) Start time of communication
- (3) End time of communication
- (4) File number
001 to 999 (When the communication is stored into memory, a file number is assigned for each communication.)
- (5) Station number
Sequential number of the Stations.
- (6) Communication result
"OK" indicates that the communication was successful.
"BUSY" indicates that the communication has failed because of busy line.
"STOP" indicates that **STOP** was pressed during communication.
"B-OK" indicates that the Batch Transmission was successful.
"M-OK" indicates that the substitute reception message in memory was not printed out.
"P-OK" indicates that memory overflow or document misfeeding occurred while storing the documents into memory for transmission but successfully stored document(s) was sent.
"R-OK" indicates that the Confidential Communication was successful.
"3-digit Info Code" (See page 141) Information Codes indicates that the communication has failed. In this case, the machine will print out the attached report with first page of your document as shown on the previous page.
- (7) Abbreviated number or **Ⓜ** mark
Ⓜ mark indicates dialed by direct number dial.
- (8) Recorded name in One-Touch, ABBR. or direct dialing number
- (9) Number of pages transmitted or received
The 3-digit number is the number of pages successfully transmitted or received. When the documents are stored into memory, two 3-digit numbers will appear. The first 3-digit number represents the number of pages successfully transmitted. The second 3-digit number represents the total number of pages that were attempted to be transmitted.
- (10) Duration of Communication

Journals and Lists

One-Touch/Abbreviated and Directory Search List

To print a One-Touch/Abbreviated Number and Directory Search List of the telephone numbers you have stored.

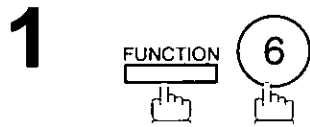

PRINT OUT (1-7)
ENTER NO. OR v ^

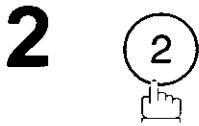

2:ONE-TCH/ABBR LIST?
PRESS SET TO PRINT

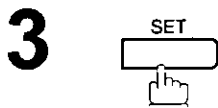

1:ONE-TOUCH/ABBR.NO.
2:DIR. SEARCH



* PRINTING *
ONE-TOUCH/ABBR LIST



* PRINTING *
DIR. SEARCH LIST

One-Touch/Abbreviated and Directory Search List

Sample One-Touch List

```

***** -ONE-TOUCH LIST- ***** DATE MAR-12-2002 ***** TIME 15:00 *****

      (1)      (2)      (3)
ONE-TOUCH  STATION NAME  TELEPHONE NO.

<01>      SERVICE DEPT.  121 555 1234
<02>      SALES DEPT.    222 666 2345
<03>      ACCOUNTING DEPT 313 333 3456

NO. OF STATIONS = 03 (4)

                                     -PANASONIC -

***** -HEAD OFFICE - ***** 201 555 1212- *****
    
```

Sample ABBR. Number List

```

***** -ABBR NO. LIST- ***** DATE MAR-12-2002 ***** TIME 15:00 *****

      (1)      (2)      (3)
ABBR NO.  STATION NAME  TELEPHONE NO.

[001]     ENG. DEPT.    888 555 1234
[002]     PURCHASE DEPT. 999 666 2345
[003]     REGULATION DEPT 777 333 3456

NO. OF STATIONS = 03 (4)

                                     -PANASONIC -

***** -HEAD OFFICE - ***** 201 555 1212- *****
    
```

Journals and Lists

One-Touch/Abbreviated and Directory Search List

Sample Directory Search List

```
***** -DIR. SEARCH LIST- ***** DATE MAR-12-2002 ***** TIME 15:00 *****

(5) (2) (1) (3)
     STATION NAME   ABBR NO. TELEPHONE NO.

[A] ACCOUNTING DEPT <03>      313 333 3456

[E] ENG. DEPT.      [001]     888 555 1234

[P] PURCHASE DEPT  [002]     555 666 2345

[R] REGULATION DEPT [003]     777 333 3456

[S] SALES DEPT.    <01>     121 555 1234
     SERVICE DEPT  <02>     222 666 2345T

NO. OF STATIONS = 06 (4)

                                -PANASONIC -

***** -HEAD OFFICE - ***** 201 555 1212 - *****
```

Explanation of Contents

- (1) One-Touch number or Abbreviated number : <nn>= One-Touch number, [nnn] = Abbreviated number
- (2) Station name recorded in the machine : Up to 15 characters
- (3) Telephone number recorded in the machine : Up to 36 digits
- (4) Number of recorded One-Touch and ABBR. numbers
- (5) The first letter of station name recorded in your machine

Program List

To print a Program List of the Dialing Patterns that you have previously entered into the Program Keys.

1

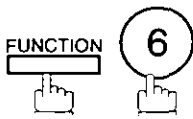

PRINT OUT (1-7)
ENTER NO. OR v ^

2



3: PROGRAM LIST?
PRESS SET TO PRINT

3

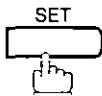

* PRINTING *
PROGRAM LIST

Sample Program List

```
***** -PROGRAM LIST- ***** DATE MAR-12-2002 ***** TIME 15:00 *****
```

(1) PROGRAM	(2) PROGRAM NAME	(3) TYPE	(4) TIMER	(5) ABBR NOS.
[P1]	TIMER XMT	XMT	12:00	[001]
[P2]	TIMER POLL	POLL	19:00	[002]
[P3]	PROG. A	POLL	----	[001] [002]
				-PANASONIC -
***** -HEAD OFFICE - ***** 201 555 1212- *****				

Explanation of Contents

- (1) Program key
- (2) Program name Up to 15 characters
- (3) Type of communication
 - "XMT" indicates transmission.
 - "POLL" indicates polling.
 - "ABBR/GRP" indicates that the Program key is programmed as a group key.
 - "ONE-TOUCH" indicates that the Program key is programmed as a One-Touch key.
- (4) Timer Indicates the starting time.
"----" indicates that the Program key contains "non-deferred" program.
- (5) Numbers recorded in the program One-Touch/ABBR. numbers

Journals and Lists

FAX Parameter List

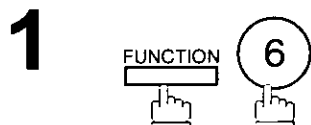

PRINT OUT (1-7)
ENTER NO. OR v ^



4:FAX PARA. LIST?
PRESS SET TO PRINT

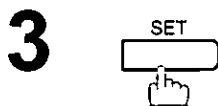

* PRINTING *
FAX PARAMETER LIST

Sample FAX Parameter List

```

***** -FAX PARAMETER LIST- ***** DATE MAR-12-2002 ***** TIME 15:00 *****
(1)      (2)      (3)      (4)      (5)
PARAMETER DESCRIPTION SELECTION CURRENT STANDARD
NUMBER                                     SETTING  SETTING

(7)01    CONTRAST (HOME) (1:Normal  2:Lighter  3:Darker)    1          1
* 02     RESOLUTION (HOME) (1:Standard 2:Fine    3:S-Fine)    2          1

          )

99      MEMORY SIZE                                     (2MB) (6)

                                           -PANASONIC -

***** -HEAD OFFICE - ***** 201 555 1212- *****
    
```

Explanation of Contents

- (1) Parameter number
- (2) Description : "(HOME)" means home position setting.
- (3) Selection
- (4) Current setting : "----" indicates code or password is not set. When the code or password is set, it is shown in parenthesis.
- (5) Standard setting : Factory preset standard setting
- (6) Memory size
- (7) Changed setting : "*" indicates that the Factory preset setting was changed.

Troubleshooting

If You Have Any of These Problems

Mode	Symptom	Cause / Action	page
During Standby	The display is blinking	The battery is not installed or the battery is completely discharged. Install a New battery and reset the clock.	26
During Transmission	Document doesn't feed/multiple feed	1. Check that your document is free of staples and paper clips, and that it is not greasy or torn.	40 41 148
		2. Check that your document is the right type to send through a fax machine by consulting the list on "Documents You Cannot Send". If your document has the characteristics listed, make a photocopy of your document and send the copy instead.	
		3. Check that the document is loaded properly.	
		4. Adjust the ADF Pressure.	
	Document jam	The information code 031 will appear on the display if the document becomes jammed.	145
	Does not stamp	1. Check if Stamp LED is lit. 2. Check Fax parameter No. 04 and No. 28 settings.	43 36, 37
	Stamp too light	Replace stamp or refill ink.	149
Transmission Copy Quality	Vertical lines on the transmitted document	Check own copy quality. If copy is OK, your machine has no problem, report to the receiving party that they have a problem. If copy is NG, clean the Document Scanning Area.	146
	Transmitted document is blank	1. Make sure the document is set face down. 2. Check own copy quality. If copy is OK, your machine has no problem, report to the receiving party that they have a problem. If copy is NG, clean the Document Scanning Area.	146
During Reception	No recording paper	The information code 010 will appear on the display if the paper runs out.	20
	Recording paper jam	The information code 001, 002, 003, 007 or 008 will appear on the display if the paper gets jammed.	144
	Recording paper doesn't advance into machine	Make sure that there is paper in the Paper Cassette. Follow the instructions for loading paper.	20
	Recording paper doesn't eject after printing	Check to see if the recording paper is jammed inside of the machine.	144
	Recording papers are not stacked in sequence. Machine does not print from the last page received.	1. Check if Fax Parameter No. 65 is set to valid. 2. If memory becomes full during reception, the machine will start to print from the 1st page received. We recommend that optional flash memory card is installed if this symptom occurs frequently.	39
	Document auto reduction doesn't work	Check Print Reduction settings.	62
	Out of toner	The information code 041 will appear on the display if the Toner Cartridge runs out of toner.	18

Troubleshooting

--

Mode	Symptom	Cause / Action	page
Print Copy Quality	Vertical lines printing on the received document	Print out a Journal report (e.g. FUNCTION, 6, 1, SET and 1) and check quality to make sure whether your machine has trouble. If Journal report quality is OK, your machine has no problem, report to the sending party that they have a problem. If copy is NG, replace the Toner Cartridge.	128 18
	Fuzzy print	1. Make sure you are using the correct paper for the best possible print quality. 2. Try reversing the recording paper to the other side.	155
	Missing dots or lines/ inconsistent darkness within print	1. Make sure you are using the correct paper for the best possible print quality. 2. Replace the Toner Cartridge.	155 18
	Fading print	Your Toner Cartridge may be running out of toner. Replace the Toner Cartridge.	18
	Faint print	You may need to choose a different paper for the best possible print quality.	155
	Intermittent partial or total black print.	Your Optional Page Memory setting value is set larger than the actual DRAM Memory Card installed. Make sure Fax Parameter 60 is set to the DRAM Memory Card Size.	38
Communication	No dial tone	1. Check the connection of the telephone line. 2. Check the telephone line.	151
	No auto answer	1. Check the connection of the telephone line. 2. Check the Reception mode setting. 3. If the Fax Parameter No. 13 (AUTO JOURNAL PRINT) is set to "Valid" (default setting) and the machine is printing the received document from memory, which also happens to be the 100th transaction, the machine will not auto answer until the Transaction Journal completes printing.	151 61
	Cannot transmit or receive	An information code will be shown on the display. Refer to the information code table to find out the trouble.	141
No Unit Operation	No unit operation	To reset the machine, turn-off the Power Switch for a few seconds then turn it on again.	22

Troubleshooting

Information Codes

When something unusual occurs, the display may show one of the Information Codes listed below. These will help you to identify and correct the problem.

Info. Code	Meaning	Action	Page
001	Recording paper jammed when feeding from the 1st cassette.	Remove the jammed paper.	144
002	Recording paper jammed when feeding from the 2nd cassette.	Remove the jammed paper.	144
003	Recording paper jammed when feeding from the 3rd cassette.	Remove the jammed paper.	144
007	Recording paper did not completely exit out of machine.	Remove the Toner Cartridge and remove the jammed paper.	144
008	Paper cassette is opened while paper is feeding.	Remove the jammed paper and close the cassette.	144
010	No recording paper.	Load the recording paper.	20
011	Recording Paper Cassette is not installed properly.	Install the Recording Paper Cassette.	--
026	The backup battery is getting weak.	Replace the battery, otherwise, the clock contents may be lost.	150
030	Document is misfeeding.	1. Reload the document properly. 2. Remove the document jam. 3. Adjust ADF.	41 145 148
031	Document paper is too long or jammed. Document length exceeds 78.8 inches (2 meters).	1. Reload the document properly. 2. Remove the document jam.	41 145
041	Out of toner.	Replace the Toner Cartridge.	18
043	Toner is getting low.		--
045	Toner Cartridge is not installed.	Install the Toner Cartridge.	18
060	Printer Cover is open.	Close the Printer Cover.	--
061	ADF Door (Document Return Guide) is open.	Close the ADF Door.	--
063	Jam Access Cover (Optional 2nd Feeder Unit) is open.	Close the Jam Access Cover.	--
064	Jam Access Cover (Optional 3rd Feeder Unit) is open.	Close the Jam Access Cover.	--
400	During initial handshake, receiving station did not respond or communication error occurred.	1. Check with the other party. 2. Reload the document and send again.	--
401	Remote station required a Receiving Password to receive the document. Remote station does not have Confidential Mailbox.	Check the remote station.	--
402	During initial handshake, communication error occurred.	Reload the document and send again.	--
403	No polling capability at the remote side.	Ask remote side to set "POLLED=ON".	--
404/405	During initial handshake, communication error occurred.	Reload the document and send again.	--
406	Transmission Password does not match. Receiving Password does not match. Received from an unauthorized station in Selective Reception mode.	Check the password or the telephone number in One-Touch or Abbreviated station.	112 114 115
407	No confirmation from the receiving station for the previous page sent.	Wait a few minutes and send again.	--

Troubleshooting

Information Codes

Info. Code	Meaning	Action	Page
408/409	Remote side confirmation of previous page is illegible.	Wait a few minutes and send again.	--
410	Communication aborted by the transmitting side.	Check with the other party.	--
411	Polling password does not match.	Check the polling password.	69
412	No data from the transmitting side.	Check with the other party.	--
414	Polling password does not match.	Check the polling password.	69
415	Polling transmission error.	Check the polling password.	69
416/417 418/419	Received data has too many errors.	Check with the other party.	--
420/421	Machine goes to receiving mode, but receives no command from the transmitting side.	1. Remote side misdial. 2. Check with the other party.	--
422/427	Interface is incompatible.	Check with the other party.	--
430/434	Communication error occurred while receiving.	Check with the other party.	--
436/490	Received data has too many errors.	Check with the other party.	--
456	<ul style="list-style-type: none"> • Unit received a confidential document or was requested to be polled of a confidential document under any of following conditions. 1. Not enough space in memory to receive the confidential document. 2. Confidential Mailbox is full. 3. While printing received document. • Unit was requested to relay a document. 	1. Print a File List and check the contents. 2. Wait until unit finishes printing.	78
492/493 494	Communication error occurred while receiving.	Check with the other party.	--
495	Telephone line disconnected.	Check with the other party.	--
501/502	Communication error occurred using the internal V.34 Modem.	Check with the other party.	--
540/541 542/543 544	Communication error occurred while transmitting.	1. Reload the document and send again. 2. Check with the other party.	--
550	Telephone line disconnected.	Check with the other party.	--
552/553 554/555	Communication error occurred while receiving.	Check with the other party.	--
580	Sub-address transmission to a unit that has no Sub-address function.	Check the remote station.	125
581	Sub-address Password transmission to a unit that has no Password Sub-address function.	Check the remote station.	125
601	ADF Door was opened during ADF transmission.	Close the ADF Door and send again.	145
623	No document loaded on the ADF.	Reload the document and send again.	--
630	Redial was not successful due to a busy line.	Reload the document and send again.	--
631	During dialing, STOP was pressed.	Reload the document and send again.	--
634	Redial was not successful due to no response from the called station or wrong number dialed.	Check the telephone number and send again.	--
	Note: If busy tone was not detected, the machine will only redial once.		

Information Codes

Info. Code	Meaning	Action	Page
638	Power failure occurred during the communication.	Check the power cord and plug.	22
870	Memory overflow occurred while storing documents into memory for transmission.	1. Transmit documents without storing into memory. 2. Install Optional Flash Memory Card.	52 158

NOTE

1. After identifying the problem and verifying the recommended action, if the information Codes keep reoccurring or for help on Information Codes that appear on your machine but are not listed above, please contact your local Panasonic Authorized Dealer.

Troubleshooting

Clearing a Recording Paper Jam

If the recording paper becomes jammed in the machine, the display will show an Information Code 001, 002, 003, 007 or 008.

To clear the jam, Info. Code 001, 002, 003, 008

1

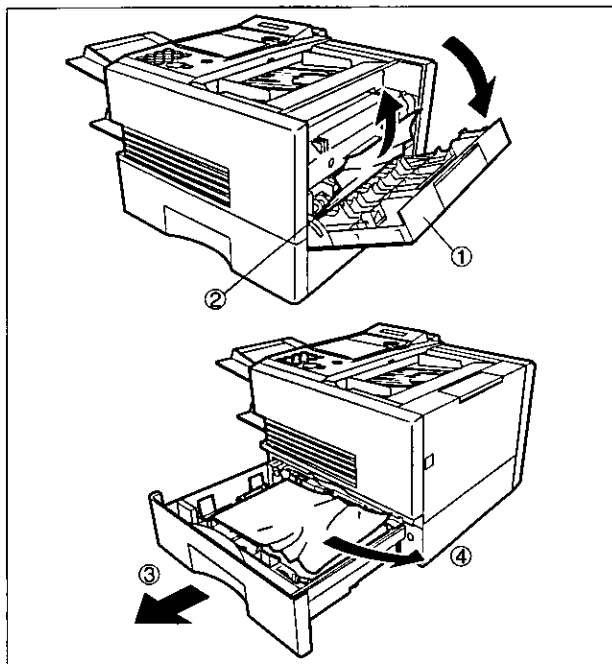

- (1) Open the Printer Cover.
- (2) Remove the jammed paper.
- (3) Slide out the Paper Cassette.
- (4) Remove the jammed or wrinkled paper and reload the recording paper into the paper cassette.

Caution: Make sure that the paper is set under the clips of the Paper Cassette. You can load about 500 sheets with standard weight paper (20 lb. or 75 g/m²). For paper specification see page 155.

To clear the jam, Info. Code 007

1

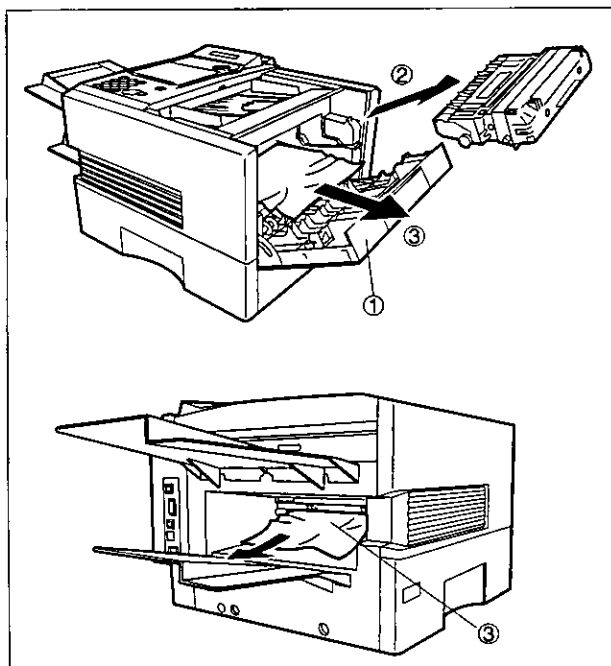

- (1) Open the Printer Cover.
- (2) Remove the Toner Cartridge.
- (3) Remove the jammed paper.

Note: If at all possible, try removing the jammed paper from inside of the unit first (as shown in the upper figure) to prevent toner that has not been fused on the paper from rubbing off and dirtying the Fuser Roller.

NOTE

1. The Recording Paper Jam message display is reset only by opening and closing of the Printer Cover.

Clearing a Document Jam

If a document becomes jammed in the machine, the display will show the Information Code 030 or 031.

To clear the jam

1

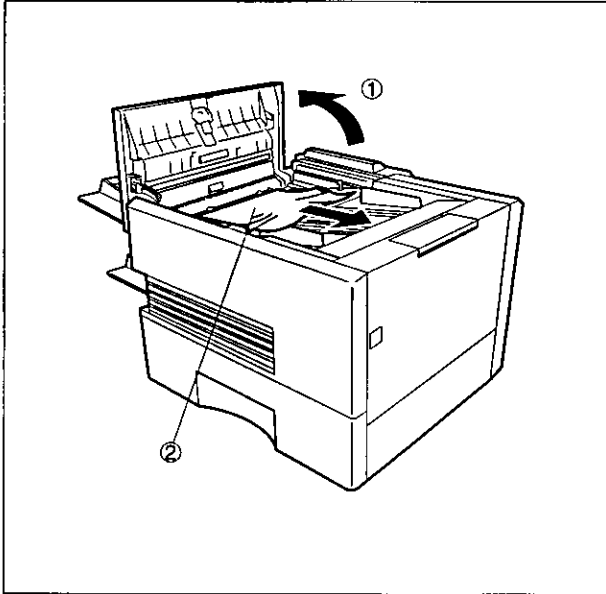

- (1) Open the ADF Door.
- (2) Remove the jammed document.

Troubleshooting

Cleaning the Document Scanning Area

If the receiving party reports that the received documents were black, or contained black lines, try making a copy on your unit to verify. If the copy is black or has black lines, the document Scanning Area is probably dirty and must be cleaned.

To clean the Scanning Area

1

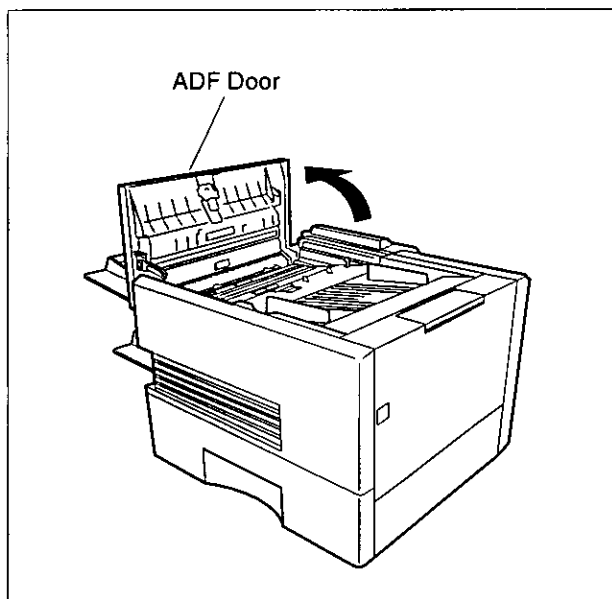

Open the ADF Door.

2

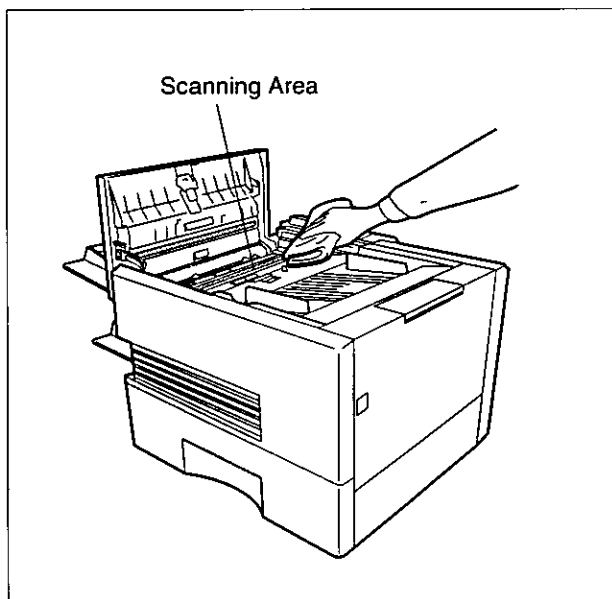

Wipe the Scanning Area gently with a soft cloth gauze wet with ethyl alcohol. Be sure to use a clean cloth, the scanning area can be easily scratched.

Cleaning the Printer Roller

If you find toner on the back of the recording paper, the printer roller in the fuser unit is probably dirty.

To clean the Printer Rollers

1

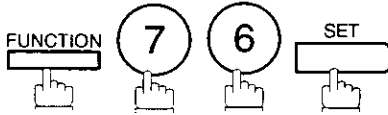

CLEANING CHARTS
1:PRINT 2:CLEAN

2



* PRINTING *
CLEANING CHARTS

The machine will print out 3 Cleaning Charts.
Then, return to standby.

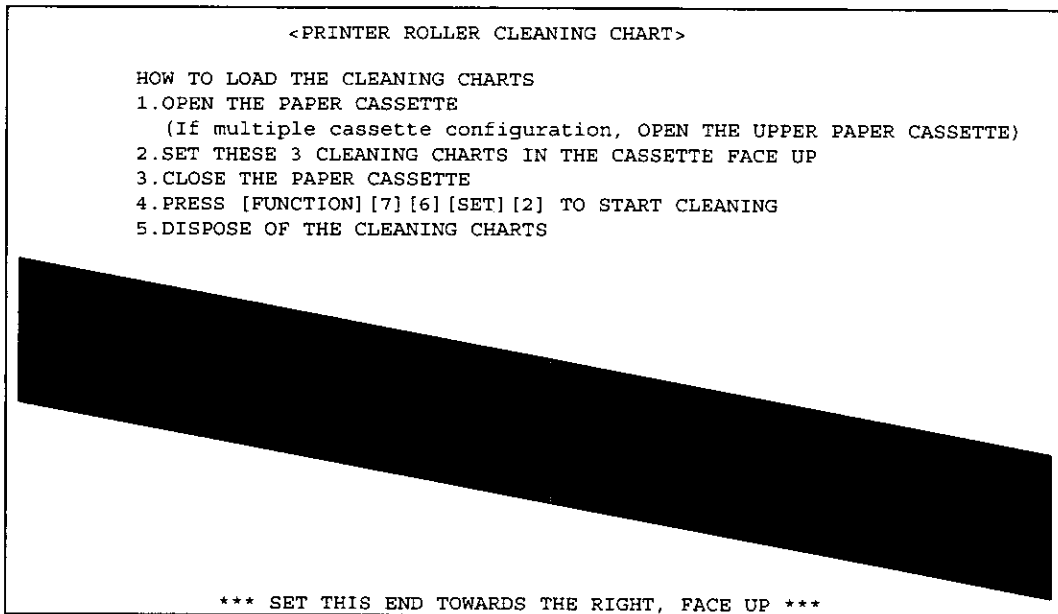

3

Load the Cleaning Charts into the cassette face up.
(See Note 1)

4

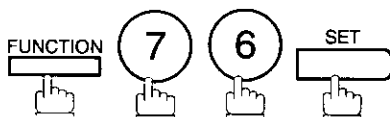

CLEANING CHARTS
1:PRINT 2:CLEAN

5



* CLEANING *
PRINTER ROLLER

The Machine will feed out the charts and clean the printer roller.

NOTE

1. If you have installed the optional cassette(s), load the Cleaning Charts into the upper cassette.

Troubleshooting

Adjusting the Automatic Document Feeder (ADF)

If document misfeeding occurs frequently, we suggest you adjust the ADF.

To adjust the ADF

1

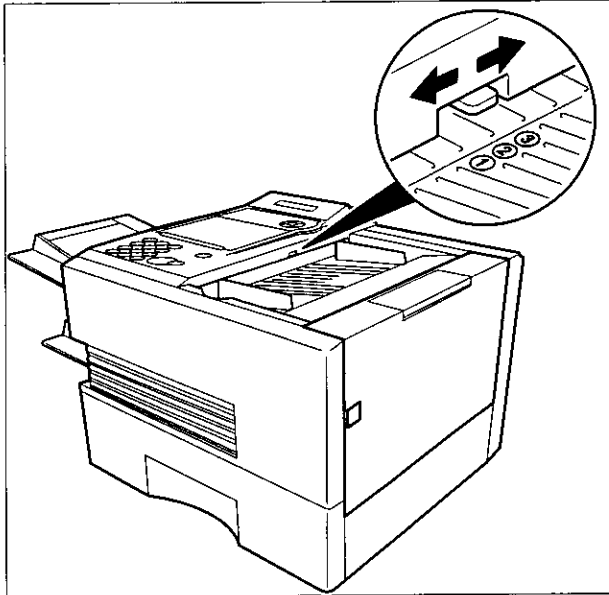

Pull the blue Pressure Adjusting Lever upward and slide it to the desired position depending on the condition.

Position	Condition
1	To prevent no feed trouble
2	Standard position
3	To prevent multiple feed trouble

Verification Stamp

The Verification Stamp contains ink. When the stamp mark appears faded or hard to see, the stamp should be replaced or refilled with ink.

To remove the stamp

1

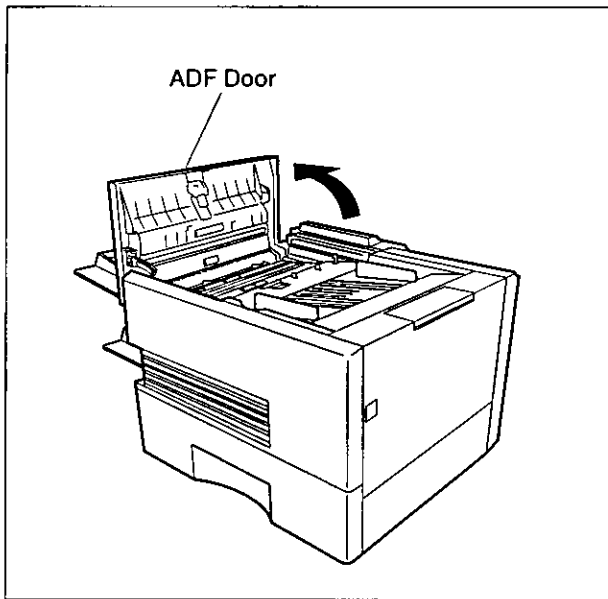

Open the ADF Door.

2

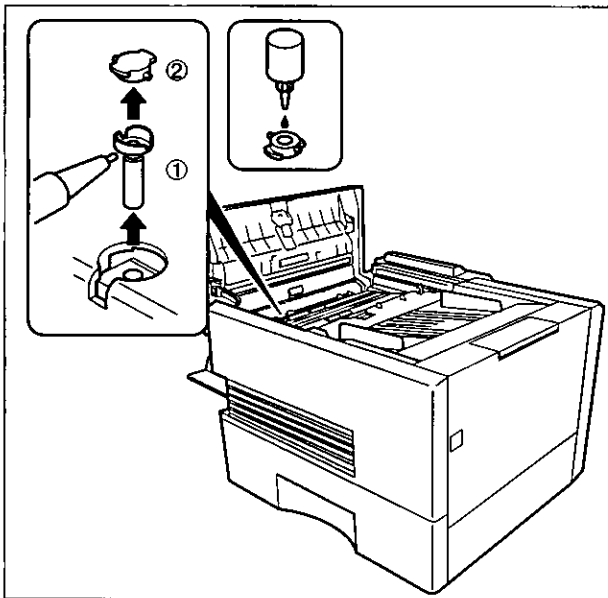

(1) Remove by pulling the Stamp Assembly upward.

(2) Remove the Stamp. Replace the stamp with a new one or refill the stamp with a few drops of the specified ink into the back of the stamp.

NOTE

1. Please contact your local Panasonic dealer to purchase a new stamp. See page 157 for order number.
2. Stamp ink refills can be purchased from a stationary store. Use blue Shachihata X Stamp ink (No. 22113) or its equivalent.

Troubleshooting

Replacing the Lithium Battery

During the initial self test, when the power is turn "On", the machine will evaluate the condition of the back up battery. If the battery is weak or fully discharged, the following message will be shown on the display.

REPLACE BATTERY
INFO. CODE=026

To replace the battery, follow the procedure below:

1

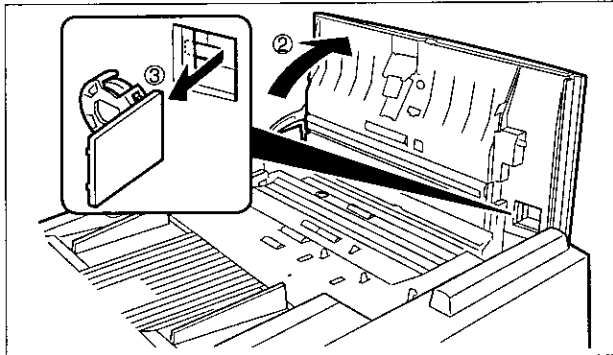

- (1) Turn the Power Switch to the "O" (OFF) position.
- (2) Open the ADF Door.
- (3) Remove the Battery together with the Battery Holder.

Caution: Dispose the Lithium battery properly and keep it away from small children.

2

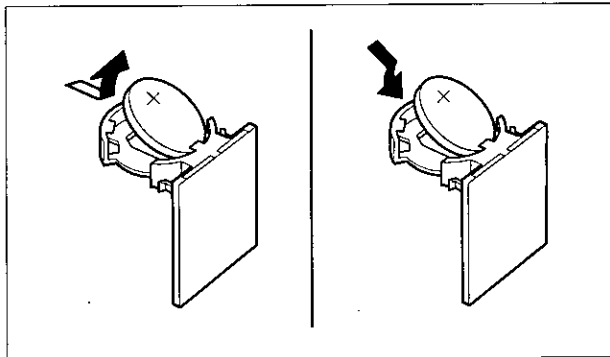

Replace the Lithium Battery.
(Order No.: CR2032)

Caution: When replacing the battery make sure to observe the polarity to avoid damage to the machine.

3

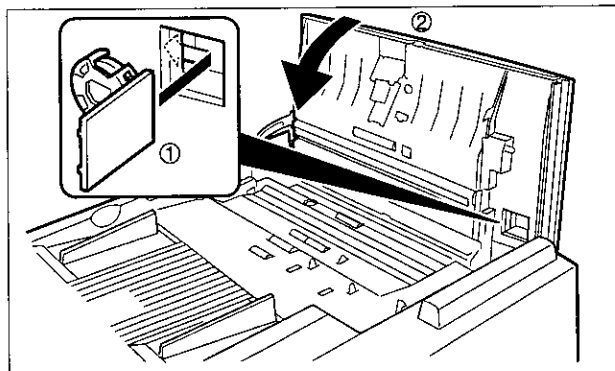

- (1) Install the Battery Holder into the machine.
- (2) Close the ADF Door.
- (3) Turn the Power Switch to the "I" (ON) position.

4

If the clock is flashing on the LCD Display, follow the procedure on page 26 to reset the clock.

NOTE

1. The service life of the battery is approximately 1 year when the machine is turned "Off".

Checking the Telephone Line

When you do not hear a dial tone through the telephone connected to the machine or when the telephone does not ring (No automatic receive).

1

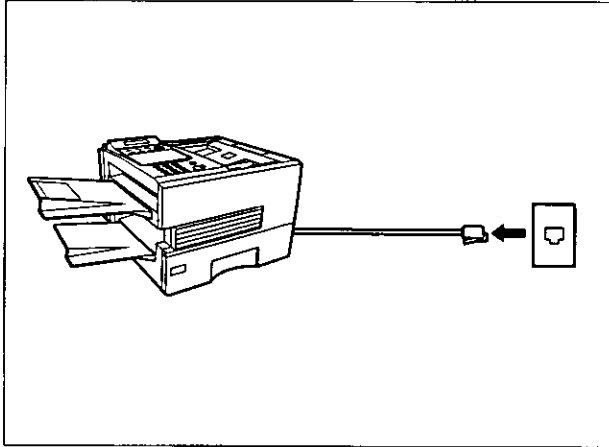

Unplug the Telephone Line Cable from the telephone jack that was supplied by the telephone company.

2

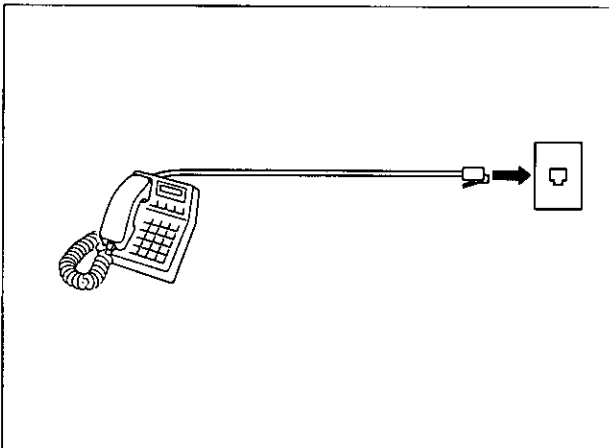

Plug a different regular telephone into the same telephone jack.

3

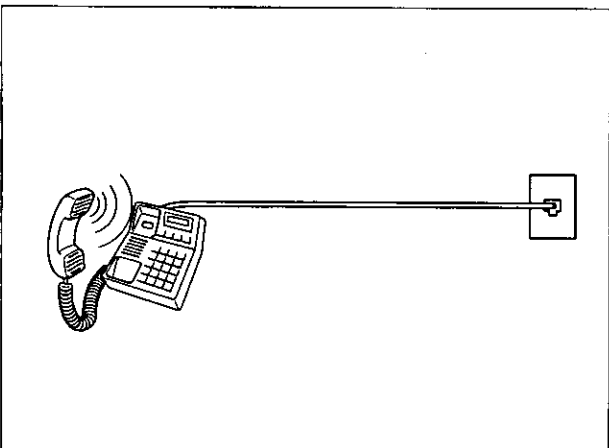

Check for dial tone through the handset. If there is still no dial tone, report it to your local telephone company.

or

Call from another telephone to this number. If the telephone does not ring, report it to your local telephone company.

Specifications

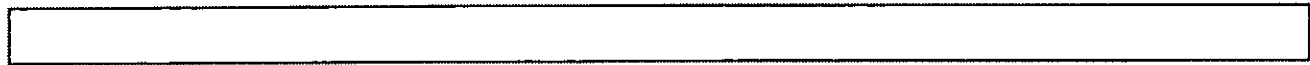

Compatibility	ITU-T Group 3														
Coding Scheme	MH, MR, MMR, JBIG (Conforms to ITU-T Recommendations)														
Modem Type	ITU-T V.34, V.33, V.17, V.29, V.27ter and V.21														
Modem Speed	33600 - 2400 bps														
Document Size	Max. : 11.0 x 78.7 in (280 x 2000 mm) (with operator's assistance) Min. : 5.8 x 5.0 in (148 x 128 mm)														
Document Thickness	Single page : 0.0024 - 0.0060 in (0.06 - 0.15 mm) Multiple pages : 0.0024 - 0.0039 in (0.06 - 0.10 mm)														
ADF Capacity (Automatic Document Feeder)	Built-in, up to 70 Sheets Note : The document limitation to send multiple pages is as follows <table border="0" style="margin-left: 40px;"> <thead> <tr> <th></th> <th style="text-align: center;"><i>Document Size</i></th> <th></th> <th style="text-align: center;"><i>Document Thickness</i></th> </tr> </thead> <tbody> <tr> <td>Up to 50 pages</td> <td style="text-align: center;">Up to 10.1 x 14.3 in (257 x 364 mm)</td> <td></td> <td style="text-align: center;">0.0024 - 0.0048 in</td> </tr> <tr> <td>Up to 70 pages</td> <td style="text-align: center;">A4 or Letter size</td> <td></td> <td style="text-align: center;">0.0024 - 0.0039 in</td> </tr> </tbody> </table> * Please note that although the size and thickness meets the specifications, you might not be able to set 70 pages with some types of papers.				<i>Document Size</i>		<i>Document Thickness</i>	Up to 50 pages	Up to 10.1 x 14.3 in (257 x 364 mm)		0.0024 - 0.0048 in	Up to 70 pages	A4 or Letter size		0.0024 - 0.0039 in
	<i>Document Size</i>		<i>Document Thickness</i>												
Up to 50 pages	Up to 10.1 x 14.3 in (257 x 364 mm)		0.0024 - 0.0048 in												
Up to 70 pages	A4 or Letter size		0.0024 - 0.0039 in												
Scanning Method	Sheet Feeding with CCD type image sensor														
Effective Scanning Width	9.9 in (252 mm)														
Scanner Resolution		Horizontal	Vertical												
	Standard	203 pels/inch × (8 pels/mm) ×	98 lines/inch (3.85 lines/mm)												
	Fine	203 pels/inch × (8 pels/mm) ×	196 lines/inch (7.7 lines/mm)												
	Super Fine	406 pels/inch × (16 pels/mm) × (Interpolated)	391 lines/inch (15.4 lines/mm)												
Recording Method	Laser printer														
Recording Paper	Plain Paper														
Recording Paper Size	Letter, A4 or Legal														
Printer Resolution	Fax/Copy Mode : 406 x 391 dpi Printer Mode : 300 x 300 dpi 600 x 600 dpi (Capable if an additional D-RAM Card is installed. The optimum size of the D-RAM Card depends on how you use the machine. Please ask your local Panasonic dealer for the details.)														
Effective Recording Size	Letter	: 8.2 x 10.7 in (208 x 271 mm)													
	A4	: 8.0 x 11.4 in (202 x 289 mm)													
	Legal	: 8.2 x 13.7 in (208 x 348 mm)													

Specifications

Print Margin (See Note 1)

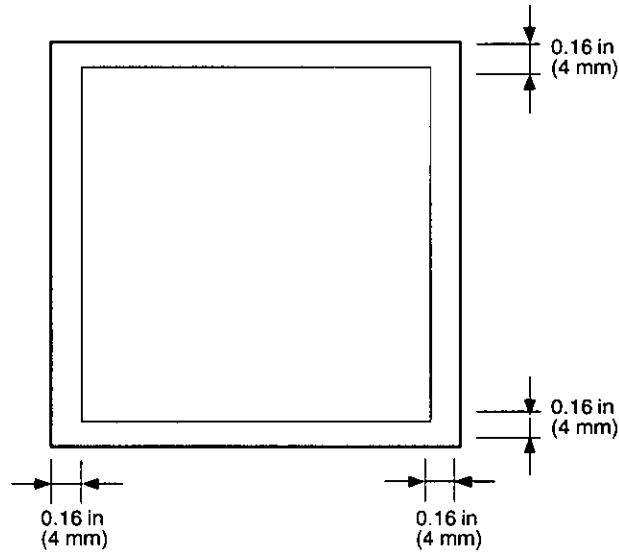

Recording Paper Capacity	Approx. 500 sheets (using 20 lbs paper)
One-Touch/Abbreviated Dialing Memory Capacity	200 stations (including 32 One-Touch keys and 8 Program keys) Each station can register up to 36 digits for each telephone number (including pauses and spaces) and up to 15 characters for each station name
Image Memory Capacity	Base Memory 120 pages with 2 MB Flash Memory Card 280 pages with 4 MB Flash Memory Card 440 pages with 8 MB Flash Memory Card 760 pages (Based on ITU-T Image No.1 using Standard Resolution)

NOTE

1. The left and right print margin is 0.22 in (5.5 mm) when printing a Letter or Legal size document with 600 dpi from a PC.

Specifications

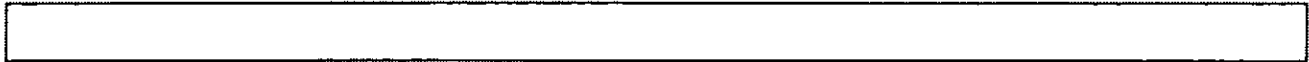

Power Supply	108-132 VAC, 47-63 Hz, Single Phase	
Power Consumption	Standby (Sleep Mode : On)	Less than 1.2 Wh
	Standby (Energy-Saver : On)	Approx. 12 Wh
	Standby (Energy-Saver : Off)	Approx. 80 Wh
	[Room temperature : 77°F (25°C)]	
	Transmission	Approx. 28 W
	Reception	Approx. 460 W
	Copy	Approx. 470 W
Dimensions	PC Print	Approx. 460 W
	Max	Approx. 470 W
	17.3 (W) x 17.7 (D) x 12.2 (H) in (440 x 450 x 310 mm) (excluding Projections and optional Paper Cassette)	
Weight	Approx. 35 lbs (Approx. 16 kg) (excluding consumable supplies and options)	
Operating Environment	Temperature	: 50 to 95°F (10 to 35°C)
	Relative Humidity	: 15 to 70%
FCC Registration Number	BTLJPN-33403-FA-E	
Ringer Equivalence	2.1B	

Recording Paper Specifications

In general, most photocopy papers will also work very well. There are many "name" and "generic" brands of paper available. We recommend that you test various papers until you obtain the results you are looking for.

The following table summarizes the major specifications to consider when selecting white or colored paper.

Basic Weight	16 to 24 lb (60 to 90 g/m ²)
Cut Edge Conditions	Cut with sharp blades, no visible frayed edges
Grain	Long grain
Moisture Content	3.7% to 5.3% by weight
Opacity	88% minimum
Packing	Poly laminated moisture-proof ream wrap
Sizes	Letter : 8.5 x 11 in (216 mm x 279 mm) A4 : 8.3 x 11.7 in (210 mm x 297 mm) Legal : 8.5 x 14 in (216 mm x 356 mm)
Type	Cut sheet



NOTE

1. It is possible that the paper could meet all of the specifications listed above and still not print well because of the variations in paper manufacturing. Therefore, we recommend that you test the paper thoroughly before purchasing.

Options and Supplies

Please contact your local Panasonic dealer for availability.

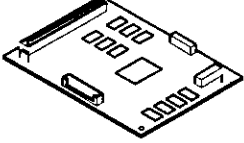
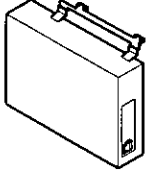
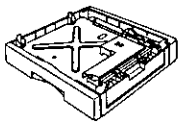
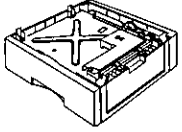
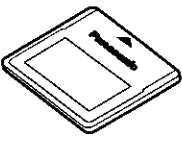
A. Options:

Order No.	Picture	Description	Available Models
UE-403168		Handset Kit	UF-890 UF-990
UE-403169		Page Description Language (PCL6) Printer Emulation Kit	UF-890 UF-990
UE-407019		G3 Communication Port Kit	UF-990
UE-409057		250 sheets Letter / Legal / A4 Size Paper Cassette with the Feeder Unit	UF-890 UF-990
UE-409056		500 sheets Letter / Legal / A4 Size Paper Cassette with the Feeder Unit	UF-890 UF-990
UE-410046		Expansion Flash Memory Card, 2 MB	UF-890 UF-990
UE-410047		Expansion Flash Memory Card, 4 MB	UF-890 UF-990
UE-410048		Expansion Flash Memory Card, 8 MB	UF-890 UF-990
UE-410034		Expansion D-RAM Card, 4 MB	UF-890 UF-990
UE-410057		Expansion D-RAM Card, 8 MB	UF-890 UF-990

NOTE

- Flash Memory Card is used for document storage.
- D-RAM Memory Card is used to enhance the machine's overall performance and printing resolution.

Options and Supplies

--

B. Supplies:

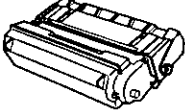
Order No.	Picture	Description	Available Models
DZHT000027		Verification Stamp	UF-890 UF-990
UG-5520		Toner Cartridge	UF-890 UF-990

Options and Supplies

Installing the Memory Card (Flash Memory Card and/or DRAM Card)

Before installing, make sure that there is no document file(s) stored in the memory. You may confirm by printing out a File List (See page 78). When the memory card is installed, the machine will initialize the document memory, all contents stored in the document memory at that time will be lost.

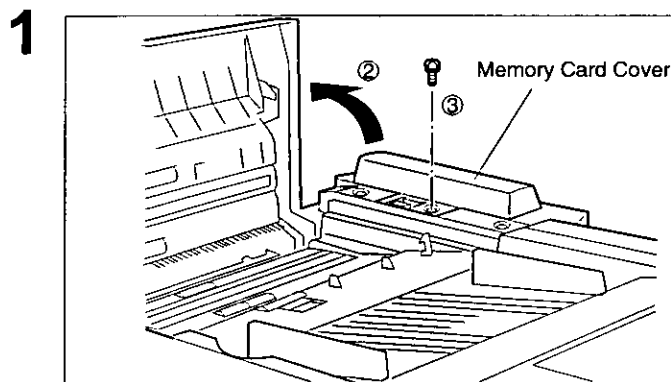

- (1) Turn the Power Switch to the "O" (OFF) position located in the rear of the machine.
- (2) Open the ADF Door.
- (3) Remove a Screw.
- (4) Remove the Memory Card Cover.

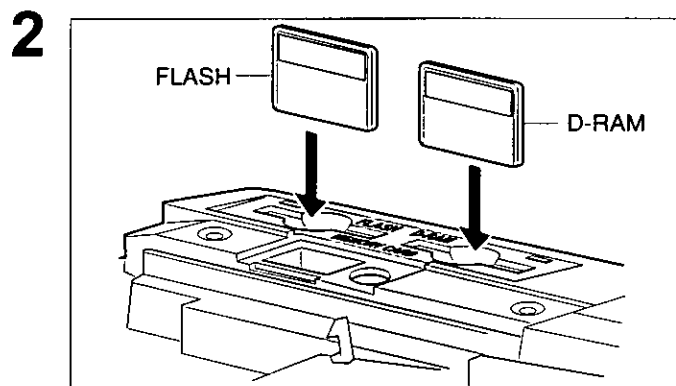

Insert the Memory Card(s) gently into the card slot with the Panasonic logo facing to the rear. (See Note 2)

Caution: Installing the Memory Card(s) in the wrong direction may damage the connecting pins inside the machine.

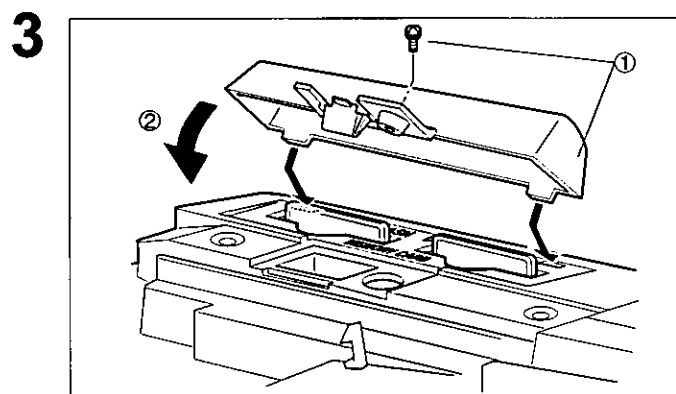

- (1) Re-install the Memory Card Cover and the Screw to secure the Cover.
- (2) Close the ADF Door.



Turn the Power Switch to the "I" (ON) position. Print out the Fax Parameter List (See page 138) and confirm that the memory size on Fax Parameter No. 99. (See page 39 and the Note 3 below)

NOTE

1. The document(s) stored in memory will be lost if the memory card is removed.
2. After installing the DRAM Card, set Fax Parameter No. 60 to the size of the Card.
3. The memory size on Fax Parameter No.99 is only shown for the Flash Memory Card.

FCC Notice for User in USA

WARNING

This equipment has been tested and found to comply with the limits for a Class B digital device, pursuant to Part 15 of the FCC Rules. These limits are designed to provide reasonable protection against harmful interference in a residential installation. This equipment generates, uses and can radiate radio frequency energy and, if not installed and used in accordance with the instructions, may cause harmful interference to radio communications. However, there is no guarantee that interference will not occur in a particular installation. If this equipment does cause harmful interference to radio or television reception, which can be determined by turning the equipment off and on, the user is encouraged to try to correct the interference by one of the following measures:

1. Reorient or relocate the receiving antenna.
2. Relocate fax machine with respect to receiver or other equipment.
3. Connect fax machine into outlet on a circuit different from that to which the receiver is connected.
4. Consult the dealer or an experienced radio/TV technician for help.

Warning: To assure continued compliance, use only shielded interface cable when connecting the facsimile machine parallel interface port to host computer. Also, any changes or modifications not expressly approved by the party responsible for compliance could void the user's authority to operate this equipment.

This device complies with Part 15 of the FCC Rules. Operation is subject to the following two conditions: (1) This device may not cause harmful interference, and (2) this device must accept any interference received, including interference that may cause undesired operation.

Responsible Party: Matsushita Electric Corporation of America
One Panasonic Way, Secaucus, NJ 07094

Technical Support: Panasonic Document Imaging Company/Technical Support Department
Two Panasonic Way, Secaucus, NJ 07094
1-800-225-5329
Email: consumerproducts@panasonic.com

Ask your telephone company or installer to install the jack suitable for your device-if such is not available.

A FCC Compliant telephone cord and modular plug is provided with this equipment. This equipment is designed to be connected to the telephone network or premises wiring using a compatible modular jack that is Part 68 compliant.

The REN is useful to determine the quantity of devices you may connect to your telephone line and still have all of those devices ring when your telephone number is called. In most, but not all areas, the sum of the REN 's of all devices connected to one line should not exceed five (5.0). To be certain of the number of devices you may connect to your line, as determined by the REN, you should contact your local telephone company to determine the maximum REN for your calling area.

If your telephone equipment causes harm to the telephone network, the Telephone Company may discontinue your service temporarily. If possible, they will notify you in advance. But if advance notice isn't practical, you will be notified as soon as possible. You will be informed of your right to file a complaint with FCC.

Your telephone company may make changes in it's facilities, equipment, operations or procedures that could affect the proper functioning of your equipment. If they do, you will be notified in advance to give you an opportunity to maintain uninterrupted telephone service.

If you experience trouble with this telephone equipment, please contact the manufacturer's authorized service agency for information on obtaining service or repairs. The telephone company may ask that you disconnect this equipment from the network until the problem has been corrected or until you are sure that the equipment is not malfunctioning.

FCC Notice for User in USA

This equipment is hearing aid compatible.

For protection against the risk of electric shock, always disconnect all cables from the wall outlet before servicing, modifying or installing the equipment.

This equipment may not be used on coin service provided by the telephone company nor connected to party lines. Connection to party line service is subject to state tariffs. (Contact the state public utility commission, public service commission or corporation commission for information.)

The Telephone Consumer Protection Act of 1991 makes it unlawful for any person to use a computer or other electronic device to send any message via telephone facsimile machine unless such message clearly contains in a margin at the top or bottom of each transmitted page or on the first page of transmission the following information:

1. Date and Time of transmission; and,
2. Identification of either business, business entity or individual sending the message; and,
3. Telephone number of either the sending machine, business, business entity or individual.

In order to program this information into your facsimile machine, you should refer to page number 26 to 29 in this Operating Instructions to complete the steps.

Example of Header Format (LOGO, ID Number setting)

MAR-12-2002 09:00	PANASONIC	201 348 7000	P.01/05
↑	↑	↑	
1) Date and Time	2) LOGO	3) ID Number	



As an ENERGY STAR® Partner, Panasonic has determined that this product meets the ENERGY STAR® guidelines for energy efficiency.

This voluntary program specifies certain energy consumption and usage standards. This product will automatically "power down" after a specified period of non-use. The use of this ENERGY STAR® compliant product will reduce energy consumption and ultimately benefit the environment.

The default functions can be adjusted depending on your office requirements. Please see your authorized Panasonic dealer for more details.

NOTE

1. This equipment complies with Part 68 of the FCC Rules. On the rear panel of this equipment is a label that contains, among other information, the FCC Registration Number and Ringer Equivalence Number (REN) for this equipment. You must, upon request, provide this information to your telephone company.

Notice to User in Canada

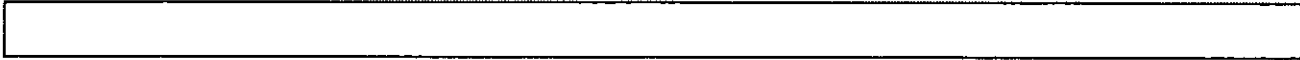

NOTICE

This equipment meets telecommunications network protective, operational and safety requirements as prescribed in the appropriate Terminal Equipment Technical Requirements document(s). This is confirmed by marking the equipment with the Industry Canada certification number. The Department does not guarantee the equipment will operate to the user's satisfaction.

Before installing this equipment, users should ensure that it is permissible to be connected to the facilities of the local telecommunications company. The equipment must also be installed using an acceptable method of connection. The customer should be aware that compliance with the above conditions may not prevent degradation of service in some situations.

Repairs to certified equipment should be made by an authorized Canadian maintenance facility designated by supplier. Any repairs or alterations made by the user to this equipment, or equipment malfunctions, may give the telecommunications company cause to request the user to disconnect the equipment.

Users should ensure for their own protection that the electrical ground connections of the power utility, telephone lines and internal metallic water pipe system, if present, are connected together. This precaution may be particularly important in rural areas.

CAUTION

Users should not attempt to make such connections themselves, but should contact the appropriate electric inspection authority, or electrician, as appropriate.

NOTICE

The ringer equivalence number (REN) assigned to each terminal device provides an indication of the maximum number of terminals allowed to be connected to a telephone interface. The termination on an interface may consist of any combination of devices subject only to the requirement that the sum of the ringer equivalence numbers of all the devices does not exceed 5.

Notice to User in Canada

Avis

L'étiquette de Industrie Canada identifie le matériel homologué. Cette étiquette certifie que le matériel est conforme à certaines normes de protection, d'exploitation et de sécurité des réseaux de télécommunications. Le Ministère n'assure toutefois pas que le matériel fonctionnera à la satisfaction de l'utilisateur. Avant d'installer ce matériel, l'utilisateur doit s'assurer qu'il est permis de le raccorder aux installations de l'entreprise locale de télécommunication. Le matériel doit également être installé en suivant une méthode acceptée de raccordement.

L'abonné ne doit pas oublier qu'il est possible que la conformité aux conditions énoncées ci-dessus n'empêche pas la dégradation du service dans certaines situations. Les réparations de matériel homologué doivent être effectuées par un centre d'entretien canadien autorisé désigné par le fournisseur. La compagnie de télécommunications peut demander à l'utilisateur de débrancher un appareil à la suite de réparations ou de modifications effectuées par l'utilisateur ou à cause de mauvais fonctionnement. Pour sa propre protection, l'utilisateur doit s'assurer que tous les fils de mise à la terre de la source d'énergie électrique, des lignes téléphoniques et des canalisations d'eau métalliques, s'il y en a, sont raccordé ensemble. Cette précaution est particulièrement importante dans les régions rurales.

⚠ Avertissement

L'utilisateur ne doit pas tenter de faire ces raccordements lui-même; il doit avoir recours à un service d'inspection des installations électriques, ou à un électricien, selon le cas.

Avis

L'indice d'équivalence de la sonnerie (IES) assigné à chaque dispositif terminal indique le nombre maximal de terminaux qui peuvent être raccordés à une interface. La terminaison d'une interface téléphonique peut consister en une combinaison de quelques dispositifs, à la seule condition que la somme d'indices d'équivalence de la sonnerie de tous les dispositifs n'excède pas 5.

Glossary

ABBR. No. (Abbreviated Number)	The ability to store full phone numbers into the dialer and then utilizing a short series of keystrokes to speed dial that number in the future.
Access code	A 4-digit programmable access code that prevents unauthorized operation of your Fax.
ADF (Automatic Document Feeder)	The mechanism that delivers a stack of document pages to the scanner one page at a time.
Automatic reception	The mode that allows you to receive fax documents without user intervention.
Auto print reduction	The method of automatically reducing a received document so that it can be printed onto a standard size piece of plain paper. For example, your machine will reduce an incoming legal size page to 75% of its original size so it could fit on a letter size page.
Batch Transmission	The ability to accumulate different documents for the same destination(s) to be transmitted in a single phone call.
BPS (Bits Per Second)	The amount of data that is transmitted over the phone line. Your machine can start at each Max. Modem speed and automatically steps down to suitable speed depending on the phone line condition and the receiving machines capabilities.(Max. Modem Speed 33600 BPS)
C.C.I.T.T.	Consultative Committee on International Telegraph and Telephone. This organization has presently developed four groups of industry standards that insure facsimile compatibility.
Character ID	A programmed proprietary code name that allows up to 16 alphanumeric characters identifying your facsimile machine.
Character keys	The keys that are used to enter letters and symbols for various programming functions.
Coding scheme	The data compression method used by facsimile machines. Your machine utilizes Modified Huffman (MH), Modified Read (MR), Modified Modified Read (MMR) and Joint Bi-level Experts Group (JBIG) coding schemes.
COMM. JOURNAL	Refers to either the Communication Journal, Relay Transmission Report, or the Confidential XMT Report.
CONTRAST	Signifies the scanning sensitivity in terms of lightness and darkness of your original transmitting pages.
Cover Sheet	A Fax Cover Sheet can be attached to your transmit document(s) that shows the recipient's name, originator's name and number of pages attached.
DDD (Direct Distance Dialing)	A telephone service that allows unassisted dialing, no operator assistance is required.
Deferred polling	The ability to retrieve documents from other stations at a later time.
Deferred transmission	The ability to send documents to other stations at a later time.
Department Code	This operation require the user to input a preset 4-digit Department Code before transmission. The Department Name of selected Department Code is printed on the Header of each page sent, Cover Sheet, COMM. Journal and Individual Transmission Journal.
Direct Dialing	The method of dialing where you enter the entire telephone number through the keypad.
Directory Search Dialing	Allows you to dial a full telephone number by searching the station's name entered in the One-Touch keys or Abbreviated dialing numbers.
Directory Sheet	The list that contains the station names that are programmed into your unit.
DTMF (Dual Tone Multi-Frequency)	Dialing method that sends a different set of frequencies for each digit of the telephone keypad. Commonly refers to touch tone dialing.
ECM (Error Correction Mode)	The ability to correct transmission errors as detected during the transmitting phone call.
Energy-Saver Mode	Saves energy by consuming less power than when in standby mode by turning off the fuser unit after the specified time.
FAX Forward	The ability to forward all incoming faxes to the registered station.
FAX Parameter List	The list that contains the home FAX parameters settings that you have programmed into your machine.

Glossary



F.C.C.	Federal Communications Commission. The U.S. Government organization that regulates communications originating or terminating in the United States.
File	A task that has been stored into the memory of your unit. Examples are deferred transactions.
File Transmission	A feature that allows you to store a perpetual File (until it is erased) in the memory that can be sent to a single or multiple stations repeatedly.
Fixed print reduction	The method that allows you to determine one reduction rate, such as 75%, for all incoming documents.
FUNCTION	The control panel key that will be utilized to begin an operation or configuration of a feature.
G3 mode (Group 3)	Refers to the standards and transmission capabilities of the current generation of facsimile machines.
Group dialing	The ability to program many telephone numbers into a single station so that many locations can be dialed in sequence utilizing a single keystroke.
HALFTONE	A scanning technique to distinguish levels of gray from black and white. Your machine can detect up to 64 levels of gray in halftone mode.
Handshaking	The exchange of a group of control signals that communicate between the transmitter and receiver. These signals determine the condition at which communication can occur.
Header	A row of information that is transmitted by the sending machine and printed on the top of each page by the receiving unit. This identifies the transmitting unit and information about the transmission, such as time and date.
ITU-T	International Telecommunication Union - Telecommunication, formerly known as C.C.I.T.T.
ITU-T Image No.1	An industry standard document that allows comparisons of the transmission speeds and capabilities of facsimile machines.
ID	A programmable address of up to 20 digits identifying your machine.
Image memory capacity	This signifies the amount of memory available in your unit capable of storing pages of documents. All page units of measure are based on the ITU-T Image No.1.
Individual Transmission Journal	A report that is printed by the transmitting unit stating information regarding the last document transaction.
Industry Canada (D.O.C)	Department of Communications. The Canadian Government organization that regulates communications originating or terminating in Canada.
Information code	A code that is internally generated by your Fax stating a specific operational error or machine failure.
Initial sending station	In a relay network, the station that is originating the document transmission.
Journal	A report that is printed by your unit listing the last 100 transactions.
Keypad	A group of numeric keys located on your control panel.
LCD	Liquid Crystal Display. The display area of your machine.
LOGO	Your programmed company name or identification up to 25 alphanumeric characters.
Multiple Logo	The user can select one of 25 preset LOGOs before a transmission.
Manual reception	A mode that requires operator intervention to receive an incoming document.
Memory transmission	The documents are scanned into memory before actual connection to the phone line for transmission.
Modem	A device that converts signals from your fax machine into signals that can be transmitted over telephone lines.
Multi-file transmission	The ability to store many files into your machine's memory before actual telephone connection occurs.
Multi-station transmission	The ability to broadcast the same set of documents to a programmed number of locations.
Off-hook dialing	The direct dialing of a telephone number with the handset out of the cradle or "off the hook."

On-hook dialing	The direct dialing of a telephone number with the handset in the cradle or "on the hook."
One-Touch dialing	The ability to dial an entire telephone number by pressing one key.
Overlap Printing	Documents too long to be reduced are automatically printed on two pages with approximately 10 mm overlap.
Panasonic Super Smoothing	An electronic image enhancement (Panasonic Super Smoothing) that will create a particular pattern for the improvement of copy quality.
Polling	The ability to retrieve a document from another facsimile machine.
Polling password	A 4-digit programmed code that enables the security of a document being polled.
Power Saver Mode	To reduce the power consumption of the machine in standby, select the time period to turn OFF the high temperature fuser unit when the printer is idle.
Print Collation	The ability to stack received documents in the correct order.
Print reduction modes	The methods used to determine how an incoming document will be reduced to print onto the paper loaded in your machine.
Program keys	Keys that are defined for storing a sequence of stations to be dialed or polled.
Protocol	A protocol is the special set of rules for communicating that the end points in a telecommunication connection use when they send signals back and forth. Both end points must recognize and observe the protocol.
PSTN	Public Switched Telephone Network. Network of interconnected switching equipment and transmission facilities.
Receiving password	A 4-digit password that is checked before a document is received.
RESOLUTION	Relates to the number of dots scanned or printed per certain square. The quality of the image increases as the number of dots per certain square increases.
Selective reception	A function that can be set so that your unit will receive from only those machines programmed into your dialer.
Sleep Mode	The lowest power state that the machine enters after the specified time without actually turning off. (Sleep Mode is not available when the optional Parallel Port Interface Kit, PDL Printer Driver Kit or G3 Communication Port Kit is installed)
Station name	Alphanumeric ID which can be programmed for each One-Touch dialing and Abbreviated dialing number.
Stored documents	Documents that have been scanned and now are stored in your machine's memory.
Sub-address	ITU-T recommendation for further routing, forwarding or relaying of incoming faxes.
Sub-address Password	ITU-T recommendation for additional security that corresponds to the Sub-address.
Substitute memory reception	Your machine's ability to store an incoming document into its memory, when it runs out of recording paper or toner.
Transmission reservation	The ability to preset a telephone number so that you may reserve a transmission while your unit is performing another function.
Transmission password	A 4-digit password that is checked when a document is transmitted.
User parameter	Programmed parameters that provide information to other stations. Examples are logo, character ID, date and time.
Verification stamp	A user selectable transmission verification stamp can be placed on scanned documents that are successfully transmitted or stored in memory.
View Mode - File List	Allows you to view the brief contents of the memory files through the LCD display without having to print the Memory File List.
View Mode - Journal	Allows you to view the brief contents of the journal through the LCD display without having to print the journal.

ITU-T Image No. 1

All specifications are based on the ITU-T Image No. 1 (The sample shown below is not to scale).



THE SLEREXE COMPANY LIMITED
SAPORS LANE - BOOLE - DORSET - BH 25 8 ER
TELEPHONE BOOLE (945 13) 51617 - TELEX 123456

Our Ref. 350/PJC/EAC 18th January, 1972.

Dr. P.N. Cundall,
Mining Surveys Ltd.,
Holroyd Road,
Reading,
Berks.

Dear Pete,

Permit me to introduce you to the facility of facsimile transmission.

In facsimile a photocell is caused to perform a raster scan over the subject copy. The variations of print density on the document cause the photocell to generate an analogous electrical video signal. This signal is used to modulate a carrier, which is transmitted to a remote destination over a radio or cable communications link.

At the remote terminal, demodulation reconstructs the video signal, which is used to modulate the density of print produced by a printing device. This device is scanning in a raster scan synchronised with that at the transmitting terminal. As a result, a facsimile copy of the subject document is produced.

Probably you have uses for this facility in your organisation.

Yours sincerely,

Phil.

P.J. CROSS
Group Leader - Facsimile Research

Registered in England: No. 2038
Registered Office: 80 Vicars Lane, Ilford, Essex.

Index

A

ABBR. Number List.....	135
Abbreviated Dialing.....	49, 53
Abbreviated Dialing Number.....	31
Access Code.....	86
ADF Capacity.....	152
Adjusting the Automatic Document Feeder (ADF).....	148
Automatic Document Feeder.....	41
Automatic Reception.....	61
Automatic Reduction.....	62

B

Batch Transmission.....	66
-------------------------	----

C

Character ID.....	28
Character Keys.....	14
Cleaning the Document Scanning Area.....	146
Cleaning the Printer Roller.....	147
Communication Journal (COMM. Journal).....	44, 132
Confidential Code.....	118
Confidential Communication.....	118
Confidential Mailbox.....	118
Confidential Receive Report.....	121
Contrast.....	42
Control Panel.....	14
Copy.....	65
Cover Sheet.....	91

D

Daignostic Password.....	38
Date and Time.....	26
Deferred Polling.....	68
Deferred Transmission.....	67
Delayed Batch Transmission.....	66
Department Code.....	99
Dialing Method (Tone or Pulse).....	24
Dimensions.....	154
Direct Transmission.....	52
Direct Transmission Reservation.....	58
Directory Search Dialing.....	50, 54
Directory Search List.....	136
Directory Sheet.....	34
Distinctive Ring Detector (DRD).....	90
Document Jam.....	145
Document Size.....	152
Document Thickness.....	152

E

Edit File Mode.....	78
---------------------	----

F

Fax Forward.....	95
FAX Parameter List.....	138
Fax Parameter Table.....	36
FCC Registration Number.....	154
File List.....	78
File Transmission.....	96
Fixed Reduction.....	62
Function Key List.....	12

G

Group Dialing.....	72
--------------------	----

H

Halftone.....	43
Header Format.....	36
Header Print.....	36

I

ID Number.....	29
Image Memory Capacity.....	153
Incomplete File Save.....	37
IND. XMT Journal.....	129
Information Codes.....	141
Installing the Accessories.....	17
Installing the Toner Cartridge.....	18
ITU-T Image No. 1.....	166

K

Key/Buzzer Volume.....	36
------------------------	----

L

Lithium Battery.....	150
Loading Documents.....	40
Loading the Recording Paper.....	20
LOGO.....	27

M

Manual Number Dialing.....	47, 52
Manual Reception.....	61
Memory Card.....	156, 158
Memory Transmission.....	45
Memory Transmission Reservation.....	57
Monitor Volume.....	25
Multiple LOGO.....	108
Multi-Station Transmission (Broadcasting).....	51

O

Off-Hook Dialing.....	55
One-Touch Dialing.....	48, 53
One-Touch key.....	30
One-Touch List.....	135
On-Hook Dialing.....	56
Operating Environment.....	154
Overlap Printing.....	63

Index

P

Paper Specifications	155
Password Reception	115
Password Transmission	114
PIN Code Access	93
Polling	69
Polling Password	69
Power Consumption	154
Print Collation	64
Print Margin	153
Print Reduction	37
Priority Transmission Reservation	58
Program Keys	72
Program List	137

R

Real-time Batch Transmission	66
Receive To Memory	88
Received Time Print	36
Receiving Password	113
Recording Paper Jam	144
Redialing	60
Reduction Ratio	37
Resolution	42
Retry an Incomplete File	85
Ringer Equivalence	154
Ringer Volume	25

S

Scanner Resolution	152
Selective Reception	112
Stamp	36
Sub-Address Password	38
Sub-Addressing	125
Substitute Memory Reception	64

T

Toner Cartridge	157
Transaction Journal	128
Transmission Password	113

U

User Parameters	26
-----------------------	----

V

Verification Stamp	43, 157
Viewing the Contents of a File List	79

W

Weight	154
--------------	-----

U.S.A. Only

WARRANTY

PANASONIC DOCUMENT IMAGING COMPANY MAKES NO WARRANTIES, GUARANTEES OR REPRESENTATIONS, EXPRESSED OR IMPLIED, TO CUSTOMER WITH RESPECT TO THIS PANASONIC FACSIMILE MACHINE, INCLUDING BUT NOT LIMITED TO, ANY IMPLIED WARRANTY OF MERCHANTABILITY OR FITNESS FOR A PARTICULAR PURPOSE.

PANASONIC DOCUMENT IMAGING COMPANY ASSUMES NO RISK AND SHALL NOT BE SUBJECT TO LIABILITY FOR ANY DAMAGE, INCLUDING, BUT NOT LIMITED TO DIRECT, INDIRECT, SPECIAL, INCIDENTAL OR CONSEQUENTIAL DAMAGES OR LOSS OF PROFITS SUSTAINED BY THE CUSTOMER IN CONNECTION WITH THE USE OR APPLICATION OF THIS PANASONIC FACSIMILE MACHINE. SEE YOUR DEALER FOR DETAILS OF DEALER'S WARRANTY.

For Service, Call: _____

Panasonic Document Imaging Company
A Business Unit of Matsushita Electric Corporation of America
Two Panasonic Way
Secaucus, New Jersey 07094

Panasonic Canada Inc.
5770 Ambler Drive
Mississauga, Ontario L4W 2T3

M0202-0
DZSD001650-0
February 2002
Printed in Japan

Free Manuals Download Website

<http://myh66.com>

<http://usermanuals.us>

<http://www.somanuals.com>

<http://www.4manuals.cc>

<http://www.manual-lib.com>

<http://www.404manual.com>

<http://www.luxmanual.com>

<http://aubethermostatmanual.com>

Golf course search by state

<http://golfingnear.com>

Email search by domain

<http://emailbydomain.com>

Auto manuals search

<http://auto.somanuals.com>

TV manuals search

<http://tv.somanuals.com>