

# Panasonic®

## Operating Instructions (For Facsimile and Internet Fax/Email Functions) Digital Imaging Systems

Model No. DP-8032 / 8025

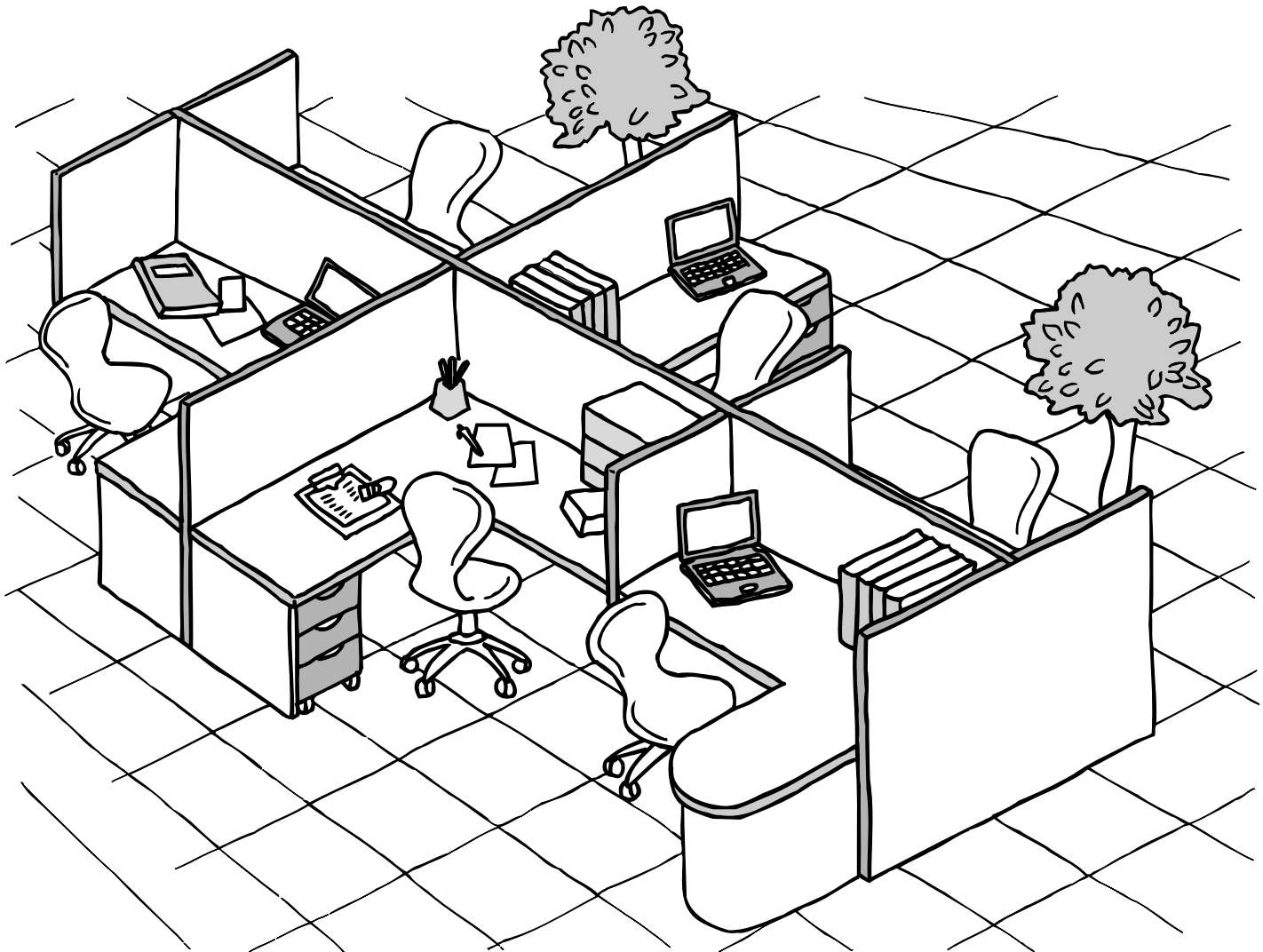

### WORKIO™

Before operating this equipment, please carefully read this manual,  
and keep this documentation in a safe place for future reference.  
(Illustration shows optional accessories that may not be installed on your machine.)

English

# IMPORTANT INFORMATION

When requesting information, supplies, or service, always refer to the model, and serial number of your machine. The model, and serial number plate (Main Name Plate) is located on the machine as shown on page 10. For your convenience, space is provided below to record information you may need in the future for reference, or troubleshooting.

Model No.:	Serial No.:
Date of Purchase:	
Dealer:	
Address:	
Telephone Number:	
Supplies Telephone Number:	
Service Telephone Number:	

For the total system to work properly via LAN, certain information, and additional parameters must be set. Please contact your network administrator for the required information, and connection to the LAN.

(Please confirm other required Internet parameter in General Settings. This setting list is printed by following the steps below:    , Input Key Operator's password,    .)

User Information		
Company Name:		
Address:		
Dept.:		
City:	State:	Zip Code:
Tel. No.:	Fax No.:	

Internet Parameters (See page 122)			
EMAIL Address:			
SMTP Server Name:	or	SMTP Server IP:	PORT No:
SMTP AUTH Name:		SMTP AUTH Password:	
** TCP/IP Default Gateway:			
** DNS Server Address:			
** 2nd DNS Server Address:			
POP Server Name:	or	POP Server IP:	PORT No:
POP User Name:			
POP Password: <i>(for security, do not write it in - but keep it in a safe place)</i>			
LDAP Server Name:	or	LDAP Server IP:	PORT No:
LDAP User Name:			
LDAP Password:			
LDAP Search Base:			

\*\*\* These parameters are located in the Copier mode.

## Useful Office Functions

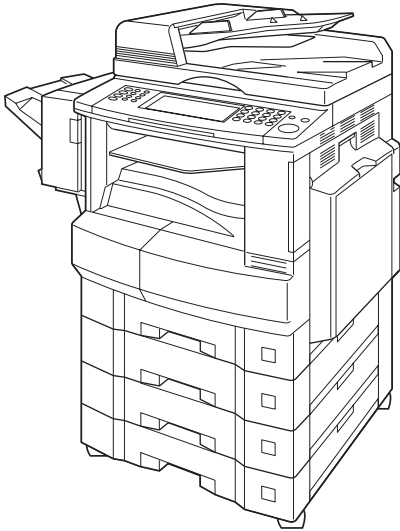

1.



### Facsimile

- Plain Paper High-speed Super G3 compatible Fax with JBIG compression when optional Fax Communication Board (DA-FG300) is installed.
- Quick-Scan
- Quick Memory Transmission

2.



### Internet Fax

- Capable of using Email (Internet Fax) Function

### Document Distribution System

- When your machine is installed with the Fax Communication Board (DA-FG300) option, your machine will allow Fax Forwarding to the Document Distribution System (DA-WR10).
- The Document Distribution System automatically distributes received data (scanner data, data received via FAX, and data received via Internet Fax) to specified recipients via a predefined delivery mechanism. The system administrator uses the system to specify the delivery mechanisms, and the recipients.

# Table of Contents

## Getting to Know Your Machine

<b>Safety Information</b> .....	<b>9</b>
■ Connecting the Cables .....	12
<b>Control Panel</b> .....	<b>14</b>

## Before Starting

<b>Loading Documents</b> .....	<b>17</b>
■ How to Load Documents .....	17
■ Sending Non-Standard Size Documents .....	17
<b>Basic Transmission Settings</b> .....	<b>18</b>
■ General Description .....	18
■ Contrast .....	18
■ Resolution .....	19
■ Original (Text/Photo) .....	20
■ Others .....	20
<b>Sending Documents</b> .....	<b>21</b>
■ Flatbed Scanning .....	23
■ Searching and Editing the Address Book .....	23

## Facsimile Features

<b>Sending Documents</b> .....	<b>25</b>
■ General Description .....	25
■ Memory Transmission .....	25
■ Rotated Transmission .....	27
■ 2-Sided Transmission (Receiving) .....	27
■ On-Hook Dialing .....	28
■ Transmission Reservation .....	29
■ Redialing .....	31
<b>Receiving Documents</b> .....	<b>32</b>
■ General Description .....	32
■ Automatic Reception .....	32
■ Manual Reception .....	32
■ Print Reduction .....	34
■ Receiving Oversize Documents .....	35
■ Substitute Memory Reception .....	36
<b>Mode Setting</b> .....	<b>37</b>
■ Setting the Mode Setting .....	37
<b>Batch Transmission</b> .....	<b>41</b>
■ General Description .....	41
<b>Timer Controlled Communications</b> .....	<b>42</b>
■ General Description .....	42
■ Deferred Transmission .....	42
■ Deferred Polling .....	44
<b>Polling</b> .....	<b>46</b>
■ General Description .....	46
■ Preparing to be Polled .....	46
■ Poll Documents from Another Station .....	48



## Facsimile Features

<b>Program Keys .....</b>	<b>50</b>
■ General Description.....	50
■ Setting for Group Dialing .....	50
■ Setting for Program Dial .....	52
■ Editing for Group Dialing .....	54
■ Erasing the Program Key Settings .....	56
<b>Confidential Mailbox .....</b>	<b>57</b>
■ General Description.....	57
■ Confidential Mailbox .....	57
■ Sending a Confidential Document to a Remote Station's Mailbox .....	58
■ Polling a Confidential Document from a Remote Station's Mailbox .....	60
■ Receiving a Confidential Document to Your Machine's Mailbox .....	61
■ Storing a Confidential Document in Your Machine's Mailbox.....	62
■ Printing Out a Confidential Document from Your Machine's Mailbox.....	63
■ Deleting a Confidential Document Stored in Your Machine's Mailbox .....	64
<b>Sub-Addressing .....</b>	<b>66</b>
■ General Description.....	66
■ Setting the Sub-Address into a Address Book Number .....	67
■ Sending a Fax with Sub-Address .....	69
■ Using Manual Number Dialing.....	70
■ Using Sub-Address Temporarily .....	71
<b>Fax Cover Sheet .....</b>	<b>73</b>
■ General Description.....	73
■ Using the Fax Cover Sheet .....	73
<b>Password Communications .....</b>	<b>76</b>
■ General Description.....	76
■ Setting Password Transmission .....	77
■ Setting Password Reception .....	79
■ Using Password Transmission .....	81
<b>Receive To Memory .....</b>	<b>83</b>
■ Setting the RCV To Memory Password.....	83
■ Setting RCV To Memory .....	84
■ Printing Documents .....	85
<b>PIN Code Access .....</b>	<b>87</b>
■ Selecting the Access Method (Prefix or Suffix) .....	87
■ Dialing with a PIN Code .....	89
<b>Selective Reception .....</b>	<b>91</b>
■ General Description.....	91
■ Setting the Selective Reception .....	91
<b>Department Code .....</b>	<b>93</b>
■ General Description.....	93
■ Activating the Department Code Feature .....	93
■ Sending Document with Department Code .....	95
■ Printing a Department Code Journal .....	96

# Table of Contents

## Facsimile Features

<b>Edit File Mode</b> .....	<b>98</b>
■ General Description .....	98
■ Printing or Viewing a File List.....	98
■ Changing the Start Time or the Station of a File.....	100
■ Deleting a File .....	102
■ Printing Out a File .....	103
■ Adding Documents into a File .....	104
■ Retry an Incomplete File .....	105

## Internet Fax Features

<b>Pre Installation Information</b> .....	<b>107</b>
■ Internet Fax Features.....	107
■ Setup as SMTP Mail Server.....	108
■ Setup as POP3 Client .....	109
<b>Internet Communication Features</b> .....	<b>112</b>
■ Internet Fax Transmission .....	112
■ Direct Internet Fax XMT .....	113
■ Internet Mail Reception .....	114
■ Inbound Routing.....	115
■ Fax Forward .....	116
■ Dynamic Host Configuration Protocol (DHCP).....	116
■ SMTP Authentication .....	116
■ Lightweight Directory Access Protocol (LDAP).....	117
■ Relayed Transmission .....	117
<b>Important Information</b> .....	<b>118</b>
<b>User Parameters</b> .....	<b>120</b>
■ Setting the User (Internet) Parameters .....	120
<b>Setting the Internet Parameters</b> .....	<b>122</b>
■ Setting the User Parameters for the LAN Interface .....	122
<b>Sending Documents via LAN</b> .....	<b>124</b>
■ Manual Email Addressing .....	124
■ Address Book Email Addressing.....	126
■ Multi Email Station Addressing (Broadcasting).....	128
■ Internet Fax Ledger Size Document Transmission.....	129
■ Change the File Format and File Name.....	131
■ Returned Email .....	133
■ Using a Mailing List.....	134
<b>Receiving Documents via LAN</b> .....	<b>135</b>
■ General Description .....	135
■ Receiving Email from a POP Server.....	137
<b>Program Keys</b> .....	<b>141</b>
■ Setting the POP Email Retrieval Key.....	141
■ Using the POP Email Retrieval Key.....	143
<b>Sender Selection</b> .....	<b>145</b>
■ General Description .....	145
■ Setting the Sender Selection .....	145
■ Sending Document with Sender Selection.....	148
■ Printing the Sender Selection List.....	149

## Internet Fax Features

<b>Inbound Routing</b> .....	<b>151</b>
■ Setting the Routing Parameters .....	151
■ Entering Address Book Dialing Numbers for Inbound Routing .....	152
<b>Fax Forward</b> .....	<b>155</b>
■ Setting Fax Forward .....	155
■ Fax Forward (Using Document Distribution System) .....	157
<b>Internet Fax Return Receipt</b> .....	<b>158</b>
■ General Description.....	158
<b>Relayed Transmission</b> .....	<b>160</b>
■ General Description.....	160
■ Relay Network.....	161
■ Setting Up Your Machine as an Internet Relay Station .....	163
■ Setting Up Your Machine for Relayed Transmission.....	164
■ Sending Documents via Internet Relay .....	167
■ Sending Document(s) from a PC to a G3 Fax Machine .....	171
■ Printouts and Reports.....	173

## Setting Your Machine

<b>Setting the Dialing Method (Tone or Pulse)</b> .....	<b>175</b>
■ General Description.....	175
<b>Adjusting the Volume</b> .....	<b>176</b>
■ General Description.....	176
■ Setting the Monitor Volume .....	176
<b>User Parameters</b> .....	<b>177</b>
■ General Description.....	177
■ Setting the User Parameter.....	177
<b>Address Book</b> .....	<b>180</b>
■ Adding Address Book Dialing Numbers .....	180
■ Editing the Address Book .....	183
<b>Customizing Your Machine</b> .....	<b>188</b>
■ General Description.....	188
■ Setting the Fax Parameters.....	188
■ Fax Parameter Table.....	190
<b>Setting Up IPv6</b> .....	<b>197</b>
■ General Description.....	197
■ IPv6 Address .....	199
■ DNS Server Address .....	203

## Printing Journals and Lists

<b>Journals and Lists</b> .....	<b>205</b>
■ General Description.....	205
■ Transaction Journal.....	205
■ Communication Journal (COMM. JOURNAL) .....	209
■ Address Book List .....	211
■ Group and Program List.....	213
■ Fax Parameter List.....	214

# Table of Contents

## Problem Solving

<b>Troubleshooting .....</b>	<b>215</b>
■ Information Codes.....	217
■ Verification Stamp.....	220
■ Checking the Telephone Line .....	221

## Appendix

<b>Specifications .....</b>	<b>223</b>
<b>FCC Notice for User in USA .....</b>	<b>225</b>
<b>Notice to User in Canada .....</b>	<b>227</b>
<b>Glossary .....</b>	<b>229</b>
<b>ITU-T Image No. 1 .....</b>	<b>236</b>
<b>Index .....</b>	<b>237</b>

## **WARNING**

denotes a potential hazard that could result in serious injury, or death.

- TO PREVENT FIRE OR SHOCK, DO NOT EXPOSE THIS PRODUCT TO RAIN OR ANY TYPE OF MOISTURE.
- TO MINIMIZE THE POSSIBILITY OF SHOCK OR DAMAGE TO THE MACHINE, IT MUST BE PROPERLY GROUNDED.
- THIS PRODUCT UTILIZES A LASER. ONLY QUALIFIED SERVICE PERSONNEL SHOULD ATTEMPT TO SERVICE THIS DEVICE DUE TO POSSIBLE EYE INJURY.

**CAUTION** -USE OF CONTROLS OR ADJUSTMENTS OR PERFORMANCE OF PROCEDURES OTHER THAN THOSE SPECIFIED HEREIN MAY RESULT IN HAZARDOUS RADIATION EXPOSURE.

- THE POWER CORD ON THIS EQUIPMENT MUST BE USED TO DISCONNECT THE MAIN POWER. PLEASE ENSURE THAT THE SOCKET OUTLET IS NEAR THE EQUIPMENT AND IS EASILY ACCESSIBLE.
- MAKE SURE THAT THE MACHINE IS INSTALLED IN A SPACIOUS OR WELL VENTILATED ROOM SO AS NOT TO INCREASE THE AMOUNT OF OZONE IN THE AIR. SINCE OZONE IS HEAVIER THAN AIR, IT IS RECOMMENDED THAT AIR AT FLOOR LEVEL BE VENTILATED.

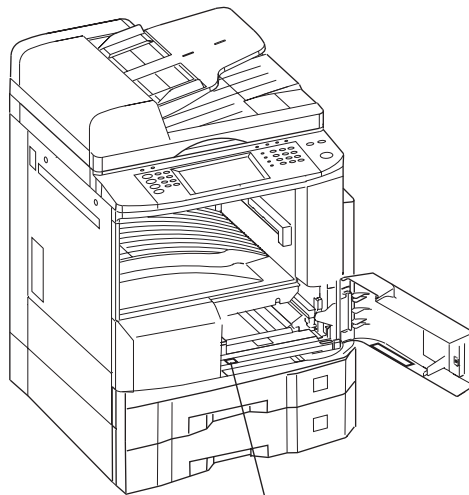

**CAUTION :** CLASS 3B INVISIBLE LASER RADIATION WHEN OPEN AND INTERLOCKS DEFEATED. AVOID EXPOSURE TO THE BEAM.  
**ATTENTION :** Rayonnement laser classe 3B invisible en cas d'ouverture et de défaut de sécurité. EXPOSITION DANGEREUSE AU FAISCEAU.  
**Vorsicht :** Um bei geöffnetem Deckel den Austritt von Klasse 3B unsichtbare Laserstrahlung zu verhindern, muss die Stromversorgung des Lasers unterbrochen werden.  
**PRECAUCIÓN :** RADIACIÓN LASER DE CLASE 3B INVISIBLE CUANDO SE ABRE LA PUERTA CON EL BLOQUEO INVALIDADO. EVITE LA EXPOSICIÓN A LOS RAYOS.  
**VAROITUS :** LUOKKA 3B NÄKYMÄTÖNTÄ JA VAARALLISTA LASERSÄTEILYÄ. JOS LAITTEEN KANSI AVATAAN KESKEN SKANNAUKSEN JA SUOJALUKITUS OHITETAAN, VÄLTÄ SUORAA ALTISTUMISTA SÄTEELLE.  
**ADVARSEL :** KLASSE 3B OSYNLIG LASERSTRÅLING NÄR ÅBEN OG SIKKERHEDSLÅS BRYDES. UNDGÅ EKSPONERING FOR STRÅLEN.  
**ADVARSEL :** KLASSE 3B OSYNLIG LASERSTRÅLING NÄR MASKINEN ER ÅPEN OG SIKKERHETSLÅS BRYTES. UNNGÅ EKSPONERING FOR STRÅLEN.  
**WARNING :** CLASS 3B OSYNLIG LASER STRÅLING NÄR MASKINEN ER ÅPEN OG SIKKERHETSLÅS BRYTES. UNNGÅ EKSPONERING AV LASER.  
**注意 :** 当打开本机及连锁装置失效时, 为防止CLASS 3B不可见激光照射, 请勿暴露在光柱下。  
**주의 :** 캐비닛(문)이 열려 있거나 인터락이 파손된 경우 눈에 보이지 않는 클래스3B의 레이저 광선이 유출 될 수 있습니다. 레이저 광선에 노출되지 않도록 주의하십시오. FBS8932B

# Safety Information

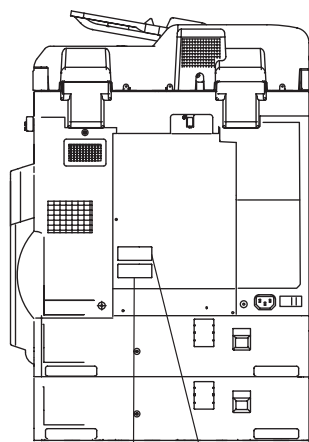

Model and Serial Number

Product complies with DHHS Rules 21  
CFR Subchapter J in effect at date  
of manufacture.

Manufacturer's Name and Address    Factory ID

## CAUTION

denotes hazards that could result in minor injury, or damage to the machine.

- TO REDUCE THE RISK OF SHOCK OR FIRE, USE ONLY NO. 26 AWG OR LARGER TELEPHONE LINE CABLE.
- DISCONNECT ALL POWER TO THE MACHINE BEFORE COVER(S) ARE REMOVED. REPLACE THE COVER(S) BEFORE THE UNIT IS RE-ENERGIZED.

## IMPORTANT SAFETY INSTRUCTIONS

When using your telephone equipment, basic safety precautions should always be followed to reduce the risk of fire, electric shock, and injury to persons, including the following:

- DO NOT USE THIS PRODUCT NEAR WATER, FOR EXAMPLE, NEAR A BATH TUB, WASH BOWL, KITCHEN SINK OR LAUNDRY TUB, IN A WET BASEMENT OR NEAR A SWIMMING POOL.
- AVOID USING A TELEPHONE (OTHER THAN A CORDLESS TYPE) DURING AN ELECTRICAL STORM. THERE MAY BE A REMOTE RISK OF ELECTRIC SHOCK FROM LIGHTNING.
- DO NOT USE THE TELEPHONE TO REPORT A GAS LEAK IN THE VICINITY OF THE LEAK.
- USE ONLY THE POWER CORD, AND BATTERIES INDICATED IN THIS MANUAL. DO NOT DISPOSE OF BATTERIES IN A FIRE. THEY MAY EXPLODE. CHECK WITH LOCAL CODES FOR POSSIBLE SPECIAL DISPOSAL INSTRUCTIONS.

SAVE THESE INSTRUCTIONS.

# Safety Information

## CAUTION

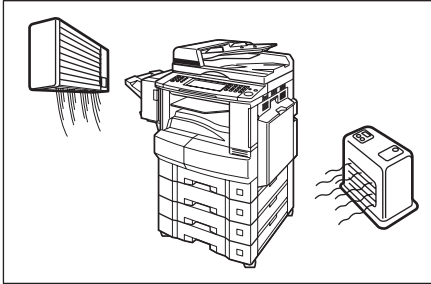

Do not install the machine near heating, or an air conditioning unit.

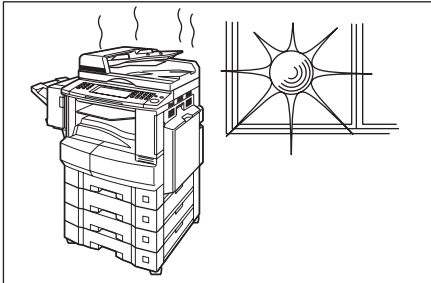

Avoid exposure to direct sunlight.

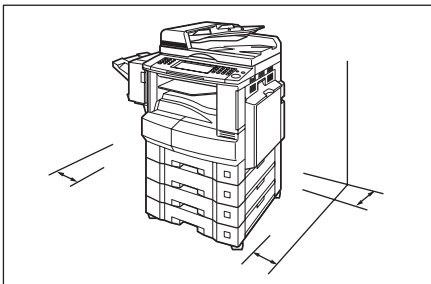

Install the machine on a flat surface, leave at least 4 inches (10 cm) of space between the machine, and other objects.

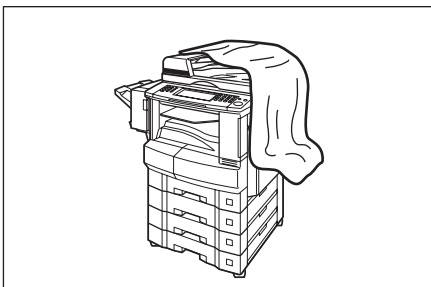

Do not block the ventilation openings.

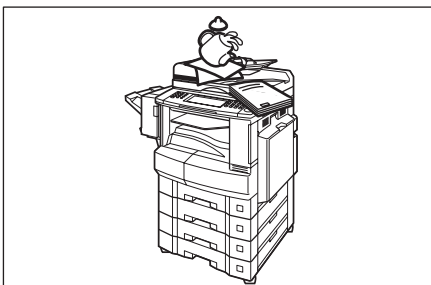

Do not place heavy objects, or spill liquids on the machine.

# Safety Information

## Connecting the Cables

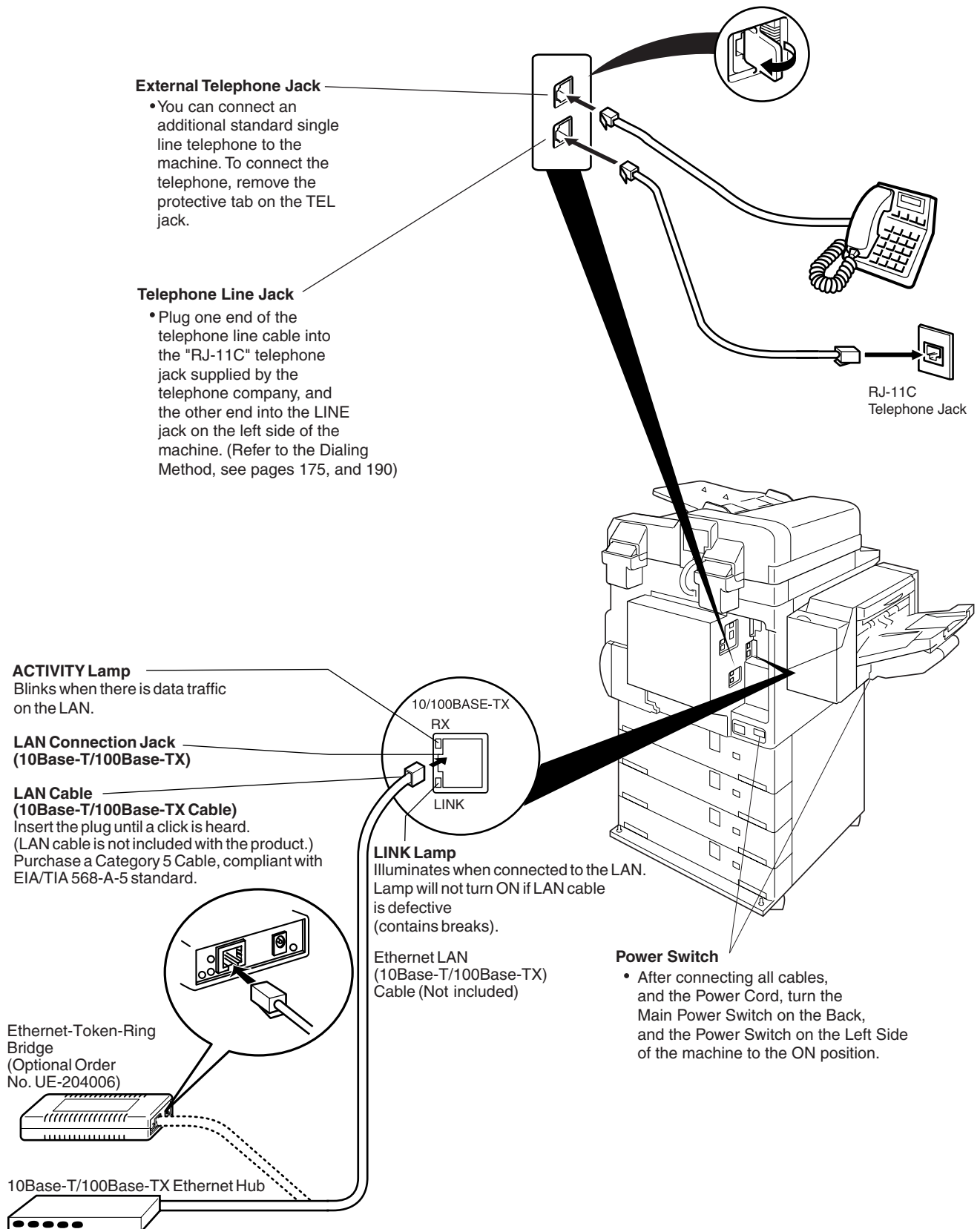



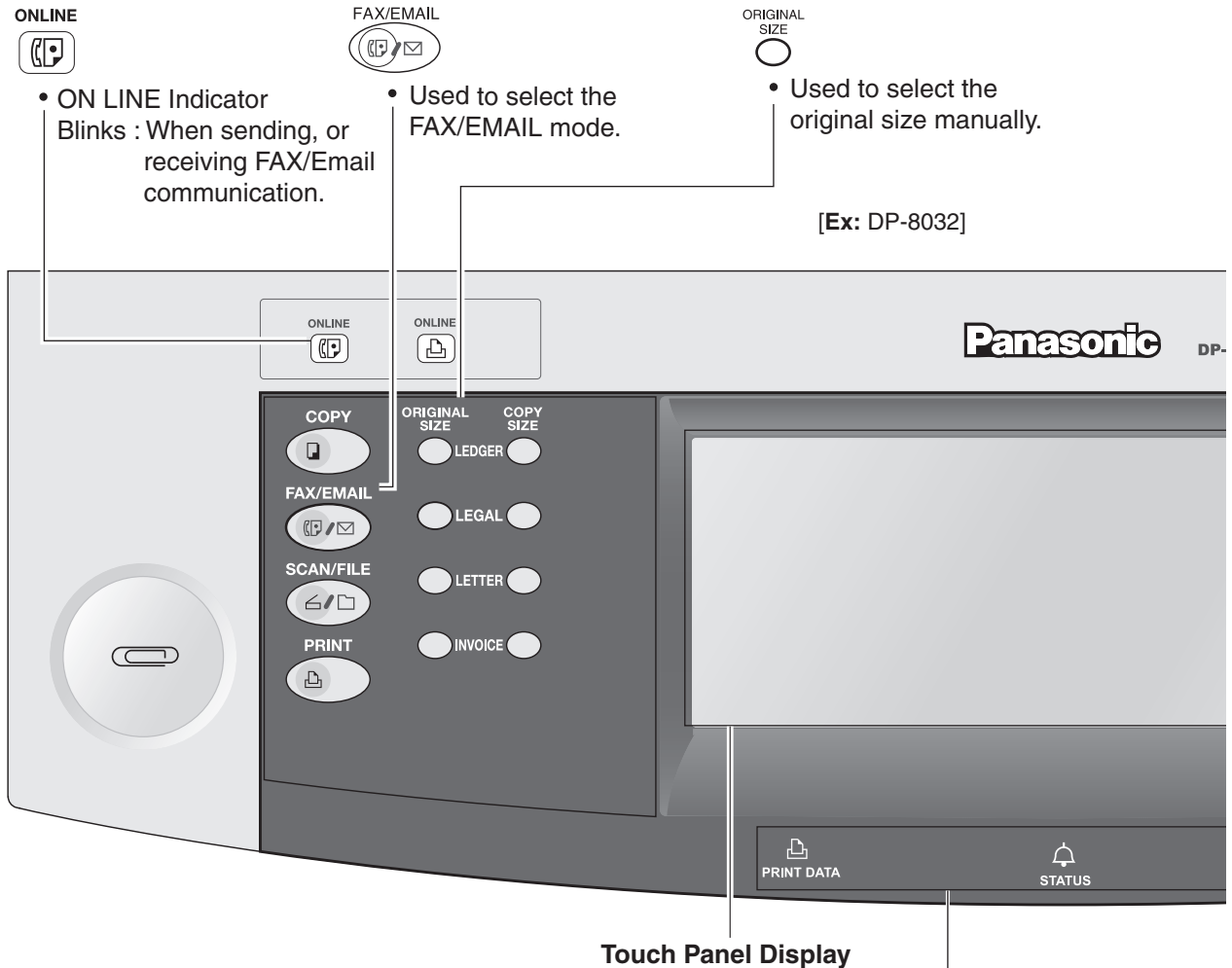

The illustration of the "ADDRESS BOOK" screen and the "MODE SETTING" screen used with this manual explains on a screen different from initial setting.

# Control Panel



[Ex: DP-8032]

Touch Panel Display

	<b>PRINT DATA LED (Green)</b>
	<b>STATUS LED (Red)</b>
	<b>ACTIVE LED (Green)</b>

- PRINT DATA LED (Green)**
  - **Flashes:** When receiving printing data.
  - **Lights:** While printing.
- STATUS LED (Red)**
  - Lights/Flashes when trouble occurs.
  - **Flashes:** Machine detected an alarm status
    - No paper in the Tray. (Tray not selected.)
    - Toner is getting low, etc.
  - **Lights:** Machine detected a trouble status
    - No paper in the selected tray, or toner has run out.
    - Machine detected trouble, such as paper misfed, or jammed.
- ACTIVE LED (Green)**
  - **Flashes:** When machine is active.
  - **Lights:** When the received fax message is in memory.

# Control Panel

**ENERGY SAVER**  

- Used to switch the machine into energy saving mode. For more details, see Energy Saver page of the Operating Instructions (For Copier.)

**FUNCTION**  

- Used to start, or select the function, and sub-functions.

**RESET**  

- Used to reset all the previously set functions.

**ENERGY SAVER** **INTERRUPT** **FUNCTION** **RESET**

**REDIAL/ PAUSE**  

- Used to enter a pause when recording, or dialing a telephone number, or to redial the last dialed number/email address.

**FLASH/ SUB-ADDR**  

- Used to separate the Sub-Address from the telephone number when dialing, or to access some features of your PBX.

**MONITOR**  

- Used to start On-Hook Dialing, or to input a space between numeric entries (such as, while entering telephone numbers).
- Used for adjusting the monitor volume while in the FAX/EMAIL mode. (See page 176).

**SET**  

- Used to set operations.

**Keypad**

1	2 ABC	3 DEF
4 GHI	5 JKL	6 MNO
7 PQRS	8 TUV	9 WXYZ
* TONE	0	#

- Used for manual number dialing, recording phone numbers, and numeric entries.

**Tone Key**

- Used to temporarily change the dialing mode to Tone when Pulse mode is set.

**CLEAR** **STOP**

**CLEAR** **STOP**

**START**

**CLEAR** **STOP**

**START**

- Use this button when correcting entered numbers, or characters.
- Press this button when you want to stop the communication, registration operation, or audible tone.
- Press this button to start transmission, email communication, or a manual fax reception.

memo

# Loading Documents

## How to Load Documents

### 1. On the ADF / Inverting ADF

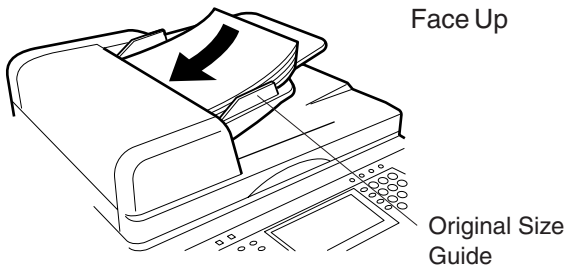

- Insert the original(s) Face Up into the ADF until the leading edge placed into the machine stops.

### 2. On the Platen Glass

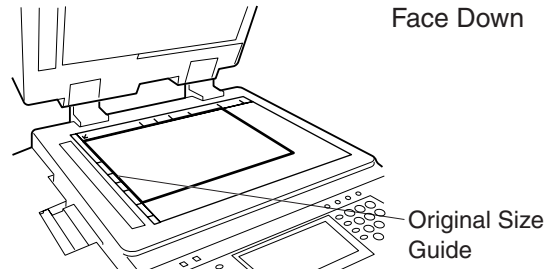

- Place a book, or an original Face Down on the Platen Glass, aligning it with the arrow mark on the original size guides.

## Sending Non-Standard Size Documents

When transmitting non-standard size document(s), the machine may perform Rotate Transmission automatically, and not transmit the portion of the document that exceeds the standard size ("P" portion). (See Note 1)

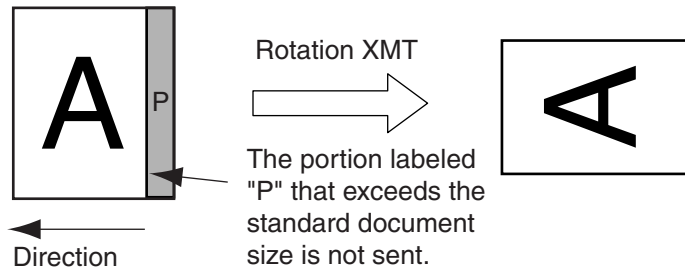

### NOTE

1. When an oversized original is sent to another machine, sometimes, it is reduced in accordance with the other party's recording paper size.

Ex:

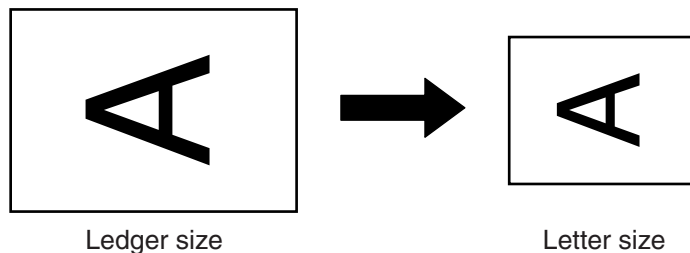

Ledger size

Letter size

# Basic Transmission Settings

## General Description

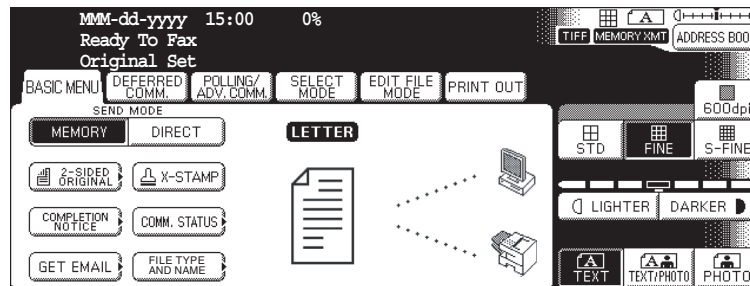

You can temporarily change the transmission settings either before, or after you place the document on the ADF. These settings are as follows:

- CONTRAST
- RESOLUTION
- ORIGINAL (TEXT/PHOTO)
- X-STAMP
- 2-SIDED ORIGINAL
- FILE TYPE AND NAME

After your document(s) have been sent, your machine will automatically return to the preset settings.

## Contrast

Your machine is preset to **Normal** contrast. If you wish to send a document with lighter contrast, change the setting to **Lighter**. If you wish to send a document with darker contrast, change the setting to **Darker**.

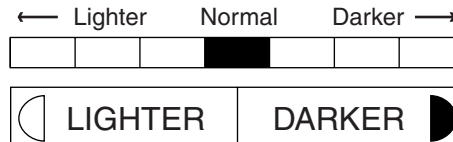

# Basic Transmission Settings

## Resolution

Your machine is preset to **Standard** resolution, which is suitable for most documents. Use **Fine**, or **Super Fine** for detailed documents.



STD

for standard originals



FINE

for detailed originals



S-FINE

for finer detailed originals



600 dpi

for 600 dpi detailed originals

### NOTE

1. To change the preset Contrast position, change the setting of Fax Parameter No. 01. (See page 190)
2. To change the preset Resolution position, change the setting of Fax Parameter No. 02. (See page 190)
3. If you send a photographic original with gray tones, set the Resolution to Fine, or S-Fine (406 x 391 dpi), and the Original setting to Text/Photo, or Photo. The reproduction of the received document will be determined by the capability of the remote station.

# Basic Transmission Settings

## Original (Text/Photo)

The Original setting is useful when sending photographs, or illustrations with gray tones. Your machine is preset to "TEXT". You can select either "TEXT/PHOTO", or "PHOTO" mode.



TEXT

for text only originals



TEXT/PHOTO

for text and photo originals



PHOTO

for photo or illustration originals

## Others



2-SIDED ORIGINAL

### Sending 2-Sided Original(s)

2-Sided scanning selection control is available for the user depending on the original layout. The following selections are available for the 2-Sided scanning option:

- Long Edge : 2-Sided scanning aligned to the long edge of the original.
- Short Edge: 2-Sided scanning aligned to the short edge of the original.



X-STAMP

### Verification Stamp

- Confirms successful transmissions by stamping the bottom of each successfully transmitted page with a small ⊗ mark.



COMPLETION NOTICE

You or a selected party can be notified with a Job Completion Notice via a pop up screen on your/their PC when the Copy Job, or the Print Job is completed. You must setup the Job Completion Notice feature prior to starting the job, and properly setup the Job Status Utility.

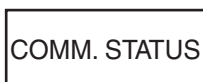

COMM. STATUS

Confirms the communication status.



GET EMAIL

Retrieving the Email temporarily.



FILE TYPE AND NAME

The File Format can be changed temporarily when sending an Internet Fax.

## NOTE

1. When you select TEXT/PHOTO, or PHOTO, your machine will automatically select Fine Resolution.
2. When you store a document in memory, the Verification Stamp will stamp on the document if it is successfully stored in memory. In this case the Verification Stamp is not a confirmation that the document was successfully transmitted. If you wish to disable the use of the Verification Stamp when storing document in memory, change the setting of Fax Parameter No. 28. (See page 191)
3. To change the preset Verification, or File Format position, change the setting of Fax Parameter No. 04, or 177. (See pages 190, and 195)



# Sending Documents

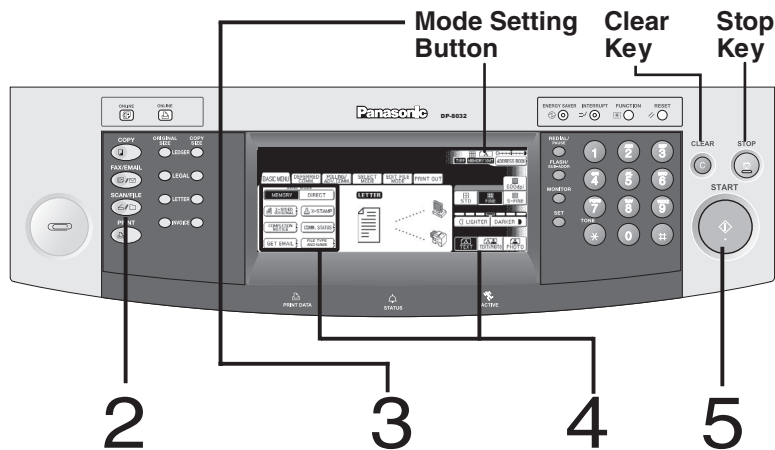
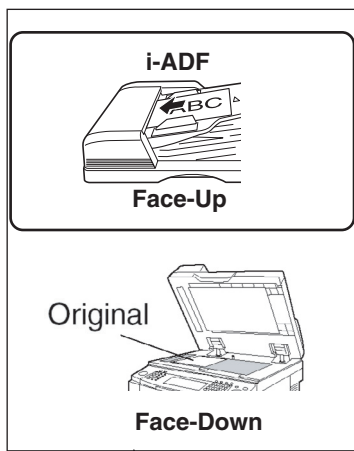

2 Press the **FAX/EMAIL** Key

3 Press the **MODE SETTING** Button

4 Select the **SEND MODE**, or adjust the desired Parameter(s)

5 Press **START**

1 Place original(s)

1a



Place original(s) face up on the ADF.

1b

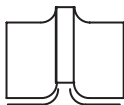

① Place a book, or an original face down on the Platen Glass.

② Press **ORIGINAL SIZE** to select the original size.

Press **FAX/EMAIL** Key.

2

3

**MODE SETTING**

**Select the Mode(s)**  
Set the SEND MODE, or desired Parameter(s), if necessary.  
(See page 18)

- RESOLUTION
- SEND MODE
- 2-SIDED ORIGINAL
- X-STAMP
- FILE TYPE AND NAME

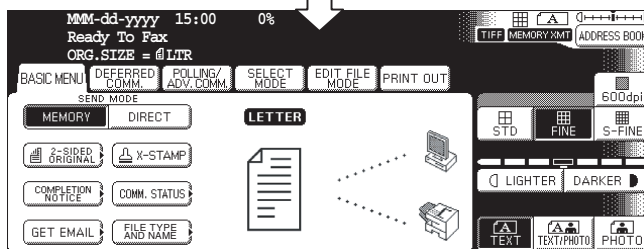
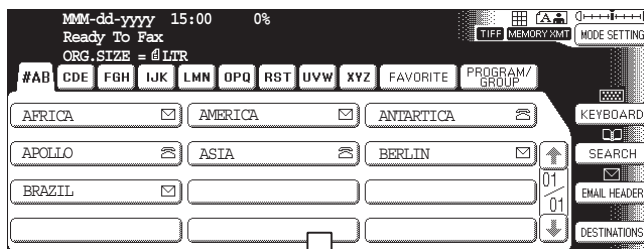

Continued on the next page...

# Sending Documents

## 4

Select either ADDRESS BOOK DIALING, or MANUAL NUMBER DIALING.

### 1. ADDRESS BOOK DIALING

Telephone numbers, or Email addresses should be registered in advance. (See page 180)

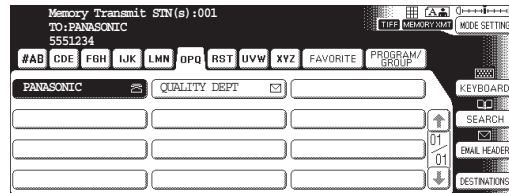

### 2. MANUAL NUMBER DIALING

- ① **Facsimile:** Enter the telephone number.

Ex: ⑤ ⑤ ⑤ ① ② ③ ④

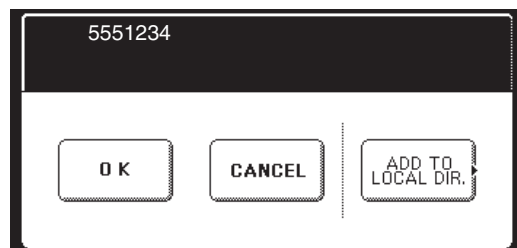

- ② **Email:** Enter the Email address using the QWERTY KEYBOARD.

Ex: abc@panasonic.com

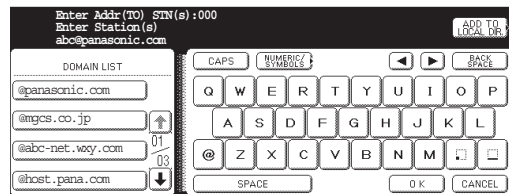
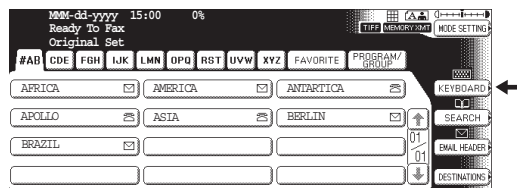

## 5

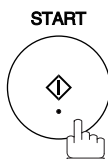

The document(s) will be stored into memory with a file number. Then starts dialing the telephone number, or connecting to the LAN immediately after storing the first page.

(See Note 3)

The remaining page(s) continue to store into memory.

### NOTE

- To utilize the above functions, your machine needs to be setup properly on your network. Please contact your network administrator for actual network setup.
- You can register the entered dialing number into the Address Book by pressing the **ADD TO LOCAL DIR.** **EDIT** in Step 4.
- This feature is called "Quick Memory Transmission". If you wish to store All the documents into memory first before transmitting, change the Fax Parameter No. 082 (QUICK MEMORY XMT) to "Invalid". (See page 192)

## Flatbed Scanning

When a book, or an original is placed on the Platen Glass, the message "ANOTHER ORIGINAL?" is shown on the LCD display when **[START]** is pressed, and the scanning is completed.

- If you wish to store another page, press **[YES]** and place another original, then press **[START]**.
- If **[NO]** is pressed, the machine starts to dial the telephone number.

## Searching and Editing the Address Book

You can search, and edit an Address Book entry as follows.

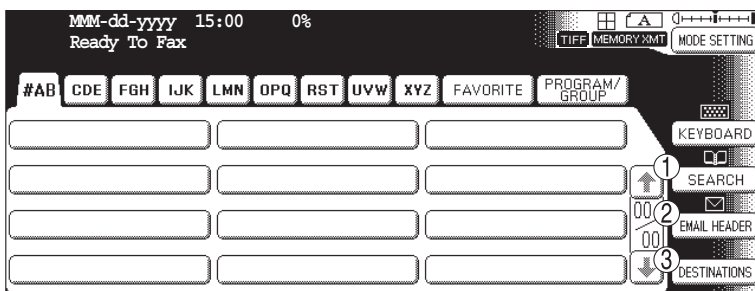

- ① Search the directory using the Local address book, or the Global directory services LDAP (Lightweight Directory Access Protocol).
- ② Input the Email address, CC (Carbon Copy), BCC (Blind Carbon Copy), FROM, and SUBJECT.
- ③ Confirm the destinations.

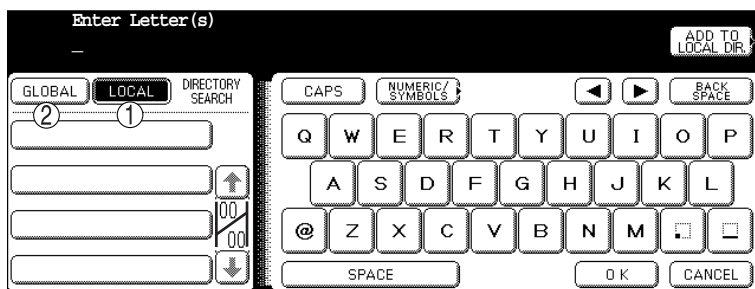

■ SEARCH

- ① Search the Local address book.
- ② Search the Global directory services (LDAP).

# Sending Documents

## Searching and Editing the Address Book

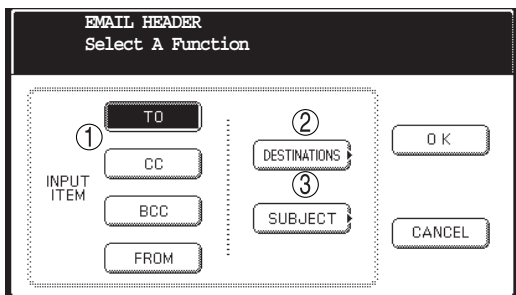

**Ex:** Entering the Email address into the TO: field

1. Press **TO** and the **OK** buttons, then enter the Email address.
2. Confirm the destinations.

### ■ EMAIL HEADER

- ① Select the input item, and press OK.
- ② Confirm the destinations.
- ③ Enter the subject.

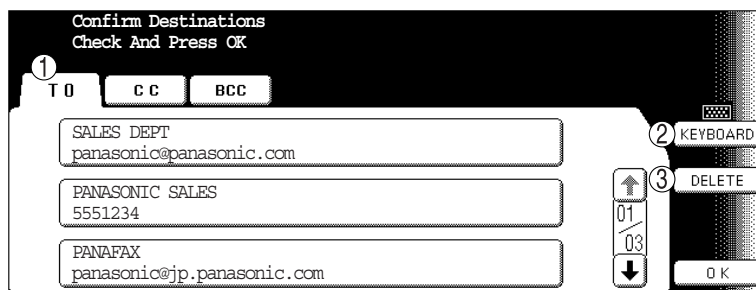

### ■ DESTINATIONS

- ① Select the address tab.
- ② Edit the email address when using manual number dialing.
- ③ Delete the selected address.

# Sending Documents

## General Description

You can choose either Memory, or Direct Transmission.

Use Memory Transmission if:

- You want to send the document(s) to multiple stations.
- You have to retrieve the document immediately.
- You want to take advantage of Multi-access design.
- You want to take advantage of Batch Transmission.

Use Direct Transmission if:

- The memory is full.
- You want to send the document(s) immediately.

## Memory Transmission

Your machine quickly stores the document(s) into the machine's memory.

Then, starts to dial the telephone number.

If the transmission fails, your machine will re-transmit the remaining unsuccessful page(s) automatically.

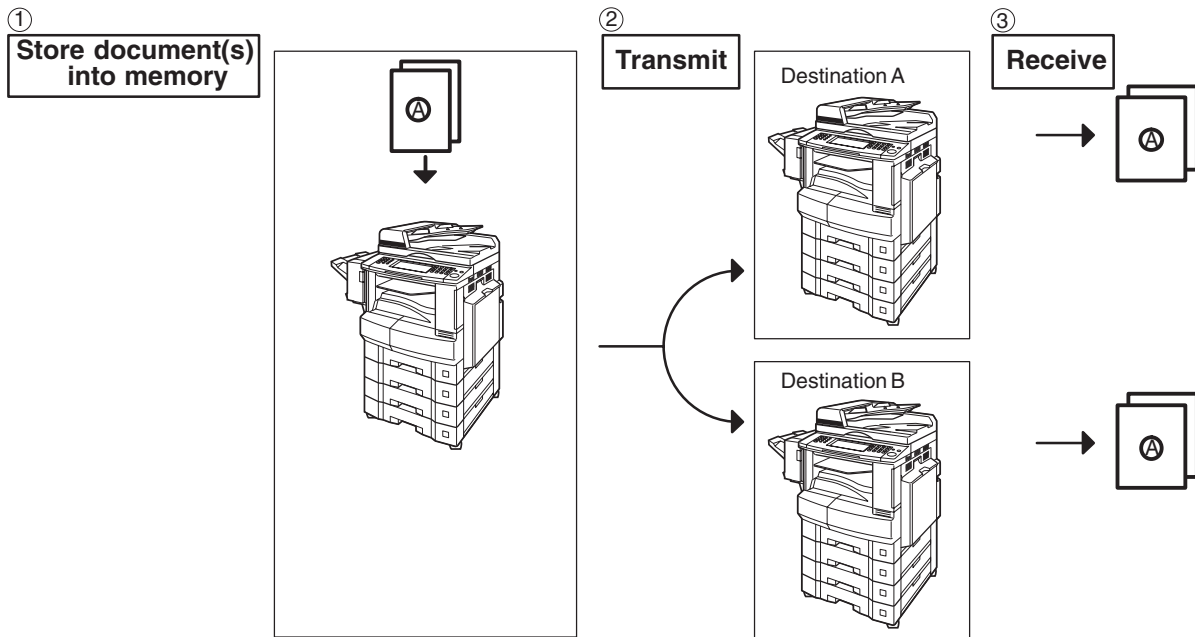

### NOTE

1. While storing, the File Number of the document being stored is shown at the upper right corner of the display. It is also printed on the Communication Journal (COMM. JOURNAL), Transaction Journal, and the File List. The percentage of memory used is shown on the lower right corner of the display after each page is stored.

```
Memory Transmit      No.026
Page    01           0%
5551234
```

Continued on the next page...

# Sending Documents

## Memory Transmission

2. If memory overflow occurs while storing the document(s), the page will be ejected. The machine will show "MEMORY FULL" on the display. You will need to reload the last page that was ejected back on the ADF, and send the remaining document(s) again when the memory becomes available.

Memory Transmit	No.010
* Memory Full *	100%
PANASONIC	

If Fax Parameter No. 082 (Quick Memory XMT) is set to "Invalid", the machine stores all the documents into memory first before transmitting.

After storing each document, the machine checks the available memory to prevent memory overflow, and stops storing additional document(s) if the stored data approaches a certain percentage\* (around 80%).

Then the machine dials, and sends the memory stored documents first, and continues the transmission of the remaining document(s) from the ADF during the same phone call.

If transmitting to multiple stations, or if memory overflows while storing a document, the machine prompts you whether to transmit the successfully stored documents, or to cancel the transmission. Press  to terminate the transmission, or press  to transmit.

For image memory capacity, see the Specifications page. (See page 223)

If no action is taken within 10 seconds, the machine will start transmitting the stored documents.

\* The percentage varies, and is dependent on the type of documents you are storing, machine settings, or whether an optional memory card is installed.

3. An Information Code will be displayed if the transmission has failed, or there was no answer at the receiving side after the last automatic redial.

The document stored for this transmission will be erased from the memory automatically, and the information code is printed for the transmission on the Communication Journal (COMM. JOURNAL).

If you need to retain the incomplete documents even after the last redial, change Fax Parameter No. 031 (INC. FILE SAVE) to "Valid" in advance (See page 191). To retry the incomplete documents, refer to page 105.

4. To stop the transmission, press .

The display shows:



Press  to stop the transmission. The document you stored will be erased automatically. If you do not want to erase the documents, change the setting of Fax Parameter No. 031 (INC. FILE SAVE) to "Valid" in advance. (See page 191)

Then the following display will appear, and you can select whether to save the file as an incomplete file for editing, and retry, or delete the file manually.

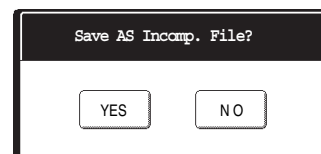

5. If you would like to print a Communication Journal (COMM. JOURNAL) after stopping a transmission, press  when the display shows:

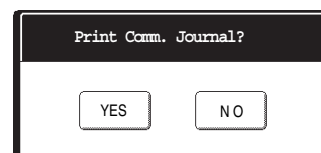

## Rotated Transmission

Letter, or A4 Original(s) are placed in a Portrait (←□) direction, the document(s) will be rotated by 90°, and then transmitted in a Landscape (←□) direction. The document(s) will be printed the same size as the transmitted originals at the Receiving Station.

**Rotation XMT Fax Parameter No. 078 (ROTATION XMT) set to:**

- Invalid

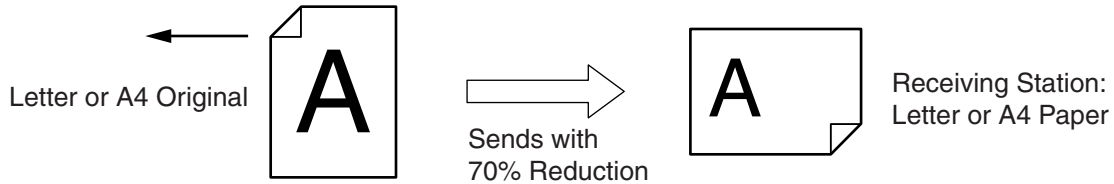

- Valid (Default Position)

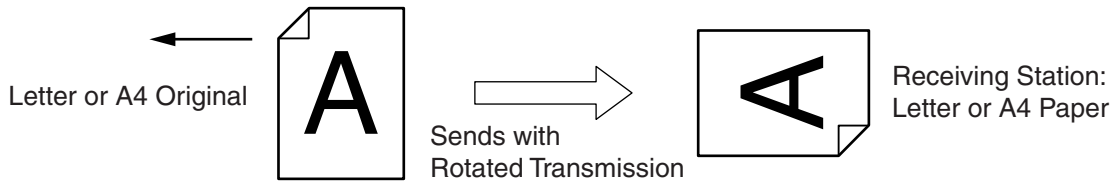

## 2-Sided Transmission (Receiving)

This machine has duplex SCAN & PRINT capabilities.

**Duplex Scan 2-Sided Original on the Basic Menu:**

- 2-Sided Original = ON

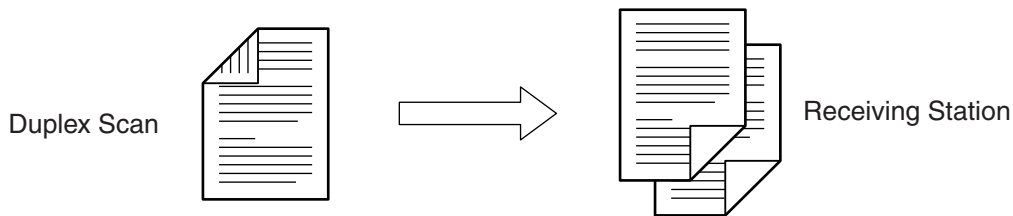

**Duplex Print Fax Parameter No. 095 (DUPLEX PRINT) set to:**

- Duplex Print = Valid (Default Position is "Invalid")

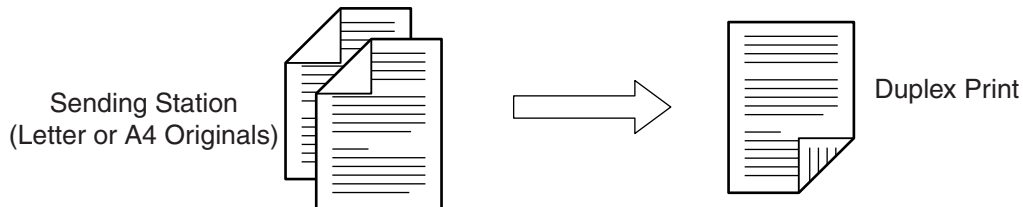

**NOTE**

1. Rotation XMT requires the use of Memory Transmission.
2. Verification Stamp is disabled during Duplex Scan.

# Sending Documents

## On-Hook Dialing

### On-Hook Dialing

For On-Hook Dialing, follow the steps below.



Place original(s) face up on the ADF.

or

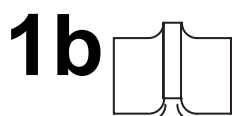

Place a book, or an original face down on the Platen Glass.



You will hear dial tone through the monitor speaker.

If required, press the **SET** key, and adjust the Monitor volume.  
(See page 176)

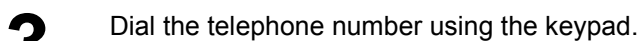

**Ex:** ⑤ ⑤ ⑤ ① ② ③ ④

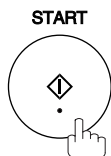
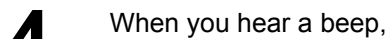

### NOTE

1. If you need a special access number to get an outside line, dial it first then press **PAUSE** to enter a pause (represented by a "-") before dialing the full number.

**Ex: 9 PAUSE 5551234**

2. If you are using Pulse dialing, and you wish to change to Tone dialing in the middle of dialing, press **TONE** (represented by a "/").

The dialing mode will be changed from Pulse to Tone after dialing the digit "/".

**Ex: 9 PAUSE TONE 5551234**



## Transmission Reservation

### Direct Transmission Reservation (Priority Transmission Reservation)

If you are in a rush to send an urgent document, however there are many files in the memory, use Direct Transmission Reservation to send the urgent document. The urgent document will be sent immediately after the current communication is finished.

**Note:** that you cannot send document(s) to multiple stations.

**To reserve your machine for sending the urgent documents**

**1** Your machine is On-Line, the ON LINE lamp is blinking, or printing received documents.



Place original(s) face up on the ADF.  
or



Place a book, or an original face down on the Platen Glass.



Make sure that "DIRECT" is displayed, if "MEMORY" appears, press **DIRECT** to change to Direct Transmission.

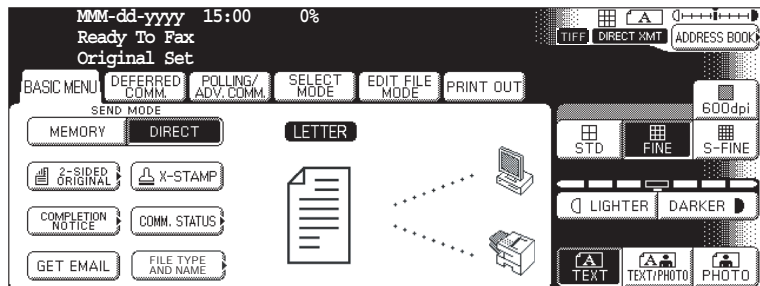

**4** Dial by using any one of the following methods:

- Manual Number Dialing, and press **OK**
- Address Book Dialing  
(For details, see page 22.)

**Ex:** **PANASONIC**

You can make reservation to send an urgent document to a single station only. A message "Direct XMT Reserved" will be shown on the display.

# Sending Documents

## Transmission Reservation

To cancel the direct transmission reservation

**1** Make sure the document is on the ADF.

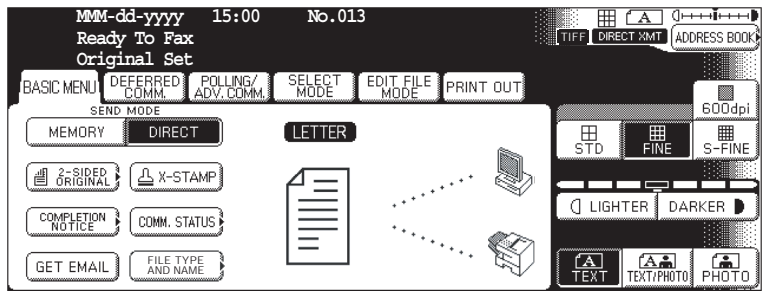

**2** 



**3**  and then remove the document from the ADF.

## Redialing

### Automatic Redialing

If a busy line is detected, the machine will redial the number up to 5 times at 3 minutes interval. However, if a busy line is not detected, the machine will redial only one time. During that time, a message will appear as shown to the right.

A file number is shown in the upper right hand corner of the display if it is a memory transmission file.



### Manual Redialing

You can also redial the last dialed number manually by pressing **REDIAL** key.



Place original(s) face up on the ADF.

or



Place a book, or an original face down on the Platen Glass.



Press **OK** to confirm the displayed telephone number.

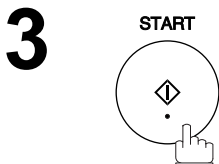
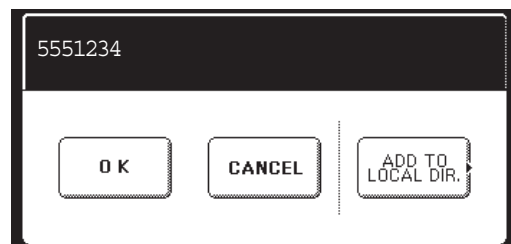

The document is stored into memory with a file number. Then dials the last dialed number.

**NOTE**

1. While the unit is displaying "WAITING TO DIAL", you can press **REDIAL** to start redialing immediately.

# Receiving Documents

## General Description

Your machine is provided with both automatic, and manual reception modes. The selection of either reception mode is made with Fax Parameter No. 017 (RECEIVE MODE).

## Automatic Reception

Your machine will receive documents automatically if the Fax Parameter No. 017 (RECEIVE MODE) is set to "Auto". (See page 191)

## Manual Reception

You may wish to receive documents manually if you use the telephone line in your office primarily as a personal telephone, and occasionally for your facsimile machine. To receive documents manually, change the Fax Parameter No. 017 (RECEIVE MODE) to "Manual" (See page 191), and the following message will be shown on the display.

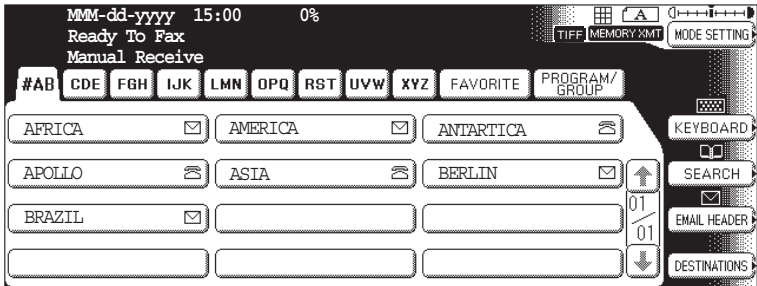

## Manual Reception

To receive documents manually

- 1 When the telephone rings, lift the handset. (See Note 1)  
If you hear a beep, the sound tells you that someone wants to send a document.

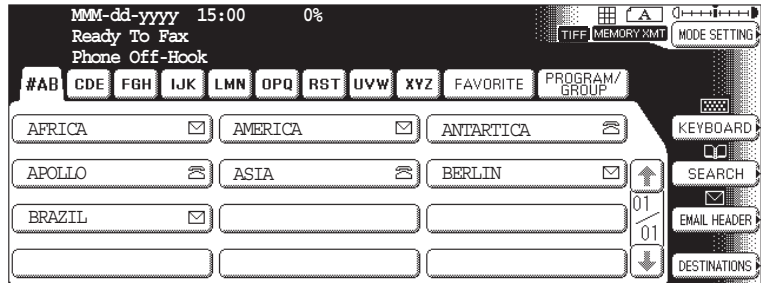

- 2 Remove any documents from the ADF.

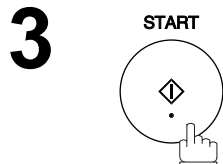

Your machine starts receiving the document.

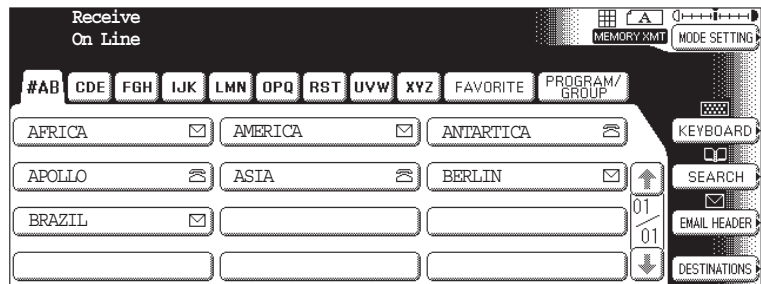

- 4 Hang up the telephone.

### NOTE

1. Your machine requires an external telephone connected to the TEL jack on the left side of the machine.
2. If you receive a document with Super Fine resolution (406 pels/inch x 391 lines/inch), it may be divided into multiple pages with no reduction.

# Receiving Documents

## Print Reduction

This machine can use Letter, Legal, or A4 size plain paper for recording. Sometimes, oversized documents sent to you by the other parties cannot be printed within a single page. When this occurs, the document will be divided into separate pages.

This machine is equipped with a Print Reduction function to solve this problem. You may select the most appropriate setting from the selections described below.

### 1. Automatic Reduction

Each page of a received document is first stored in memory. Based on the document length, your machine will automatically calculate the suitable reduction ratio (70% to 100%) to print the entire document on a single page. If the received document is extremely long (over 39% longer than the recording paper), the document will be divided into separate pages, and print without reduction.

### 2. Fixed Reduction

You can pre-determine the reduction ratio from 70% to 100% in 1% steps. The document(s) you receive will be reduced to the fixed ratio regardless of size.

## Selecting the Print Reduction Mode

Set Fax Parameters as shown below. (See page 191)

1. To set Automatic Reduction mode.

a) Set Parameter No. 24 (Print Reduction) to "Auto".

2. To set Fixed Reduction mode.

a) Set Parameter No. 24 (Print Reduction) to "Fixed".

b) Set Parameter No. 25 (Reduction Ratio) to any number between 70% through 100%. (See Note 1)

<b>Ex:</b> A4 to A4	96%
A4 to Letter	90%
Letter to Letter	96%
Legal to Letter	75%

### NOTE

1. If the sending side is set to print the header on the outside of the copy area, more reduction ratio will be required.

## Receiving Oversize Documents

If the received document is extremely long (over 39% longer than the recording paper), the document will be divided into separate pages. When printing on separate pages, the bottom 0.5 in (13 mm) of the first page will be overlapped on top of the next page.

Transmitted Document

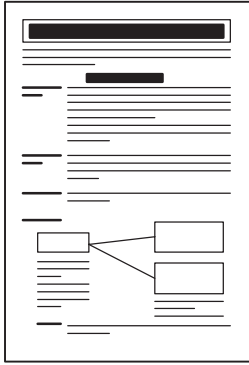

Received Document

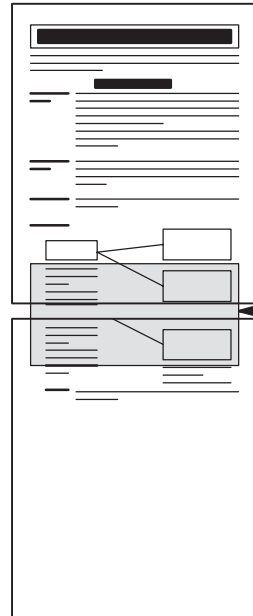
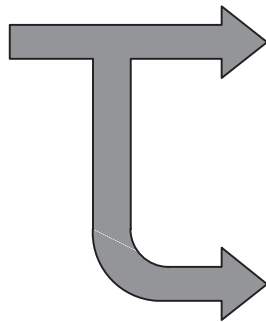

Overlap print.  
0.5 in (13 mm)

The receiving document is divided into two sheets with overlap printing.

### NOTE

1. If the reduction method is set to the Automatic Reduction mode, the document is printed out with no reduction when printing out separate pages. If the reduction method is set to Fixed Reduction mode, the document is printed out by the ratio you set in Fax Parameter No. 25.

# Receiving Documents

## Substitute Memory Reception

If the recording paper runs out, or if the toner runs out during reception, the machine automatically starts receiving documents into its image data memory. Stored documents are printed automatically after replenishing the recording paper, or toner. (See Note 1, and 2)

- 1 When the machine completes the memory reception, and there is no recording paper, or toner, an Information Code will appear on the display.

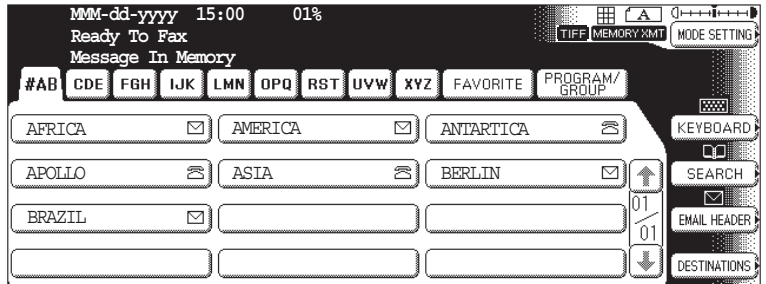

- 2 Replenish the recording paper, or the toner. The machine will automatically start printing the document(s) stored in memory.

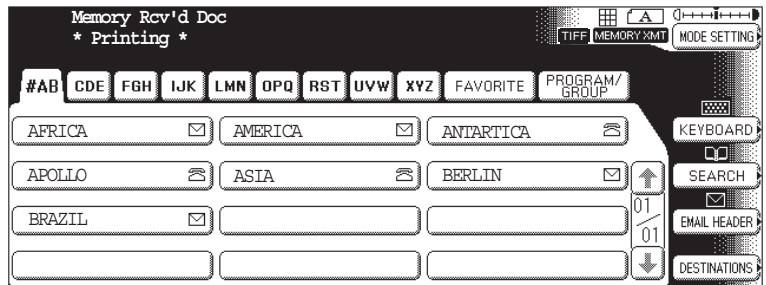

### NOTE

1. If the memory overflows, the machine will stop receiving, and release the communication line. The document(s) stored in the memory up to that moment will be printed out.
2. If you wish to turn off the substitute reception function, change the setting of Fax Parameter No. 22 to "Invalid". (See page 191)



# Mode Setting

## Setting the Mode Setting

You can temporarily change the Basic Menu, Deferred Communication, Polling/Advanced Communication, Select Mode, Edit File Mode, and Print Out.

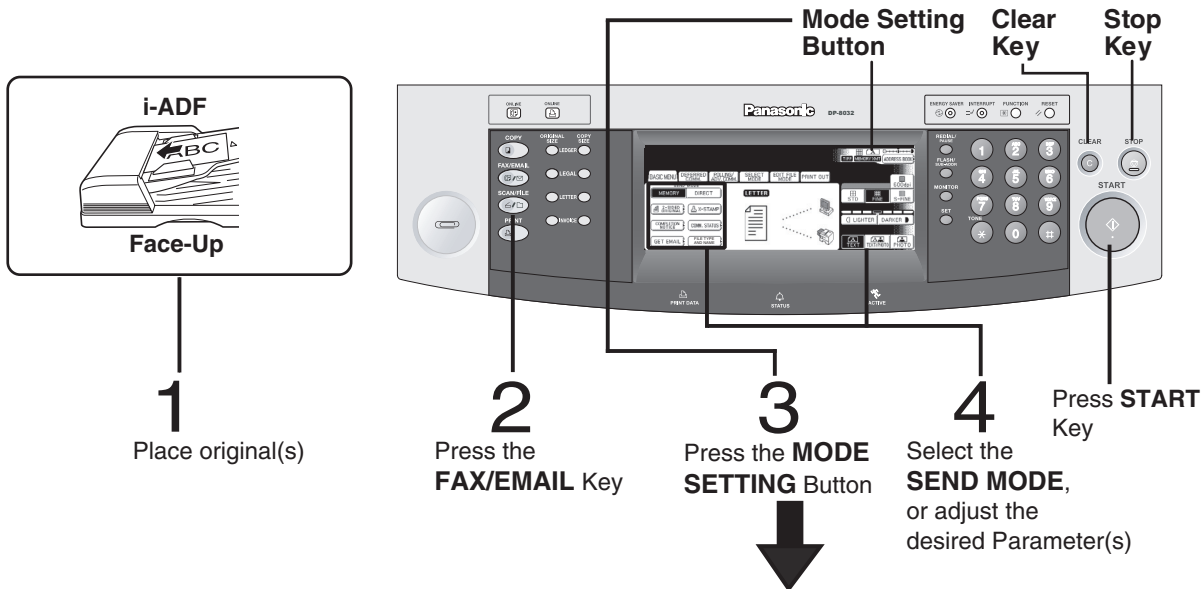

### ■ How to change the MODE SETTING

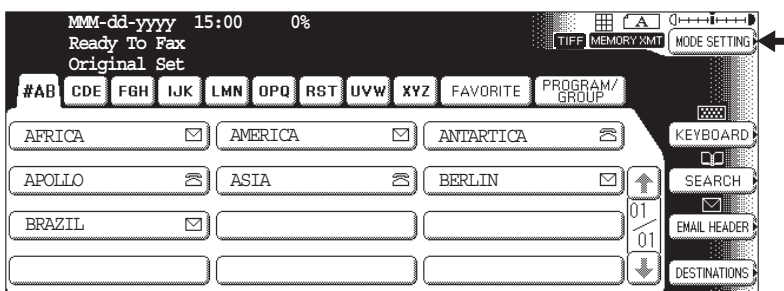

changes to the Mode Setting display.

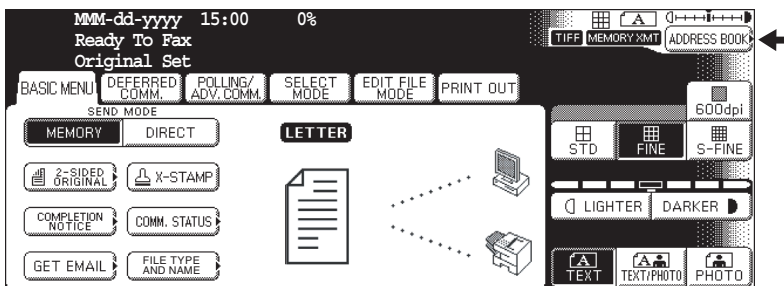

Press the appropriate Index tab, and select the desired setting.

- Basic Menu
- Deferred Communication
- Polling/Advanced Communication
- Select Mode
- Edit File Mode
- Print Out



changes to the Address Book display.

Continued on the next page...

# Mode Setting

## Setting the Mode Setting

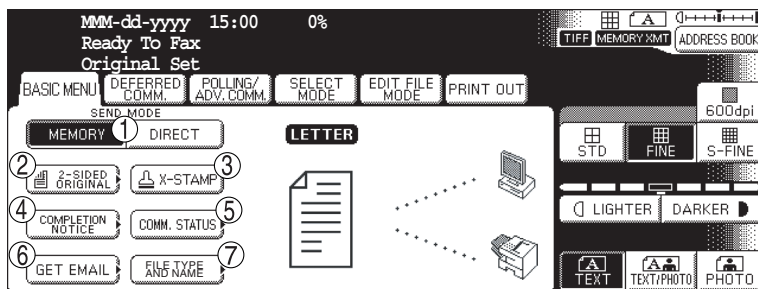

### BASIC MENU

- ① Selects SEND MODE (MEMORY, DIRECT)  
(See pages 21, 25 and 29)
- ② 2-SIDED ORIGINAL  
(See page 20)
- ③ X-STAMP  
(See page 20)
- ④ COMPLETION NOTICE  
(See page 20)
- ⑤ COMM. STATUS  
(See page 20)
- ⑥ GET EMAIL  
(See page 20)
- ⑦ Change FILE TYPE AND NAME  
(See pages 20, and 131)

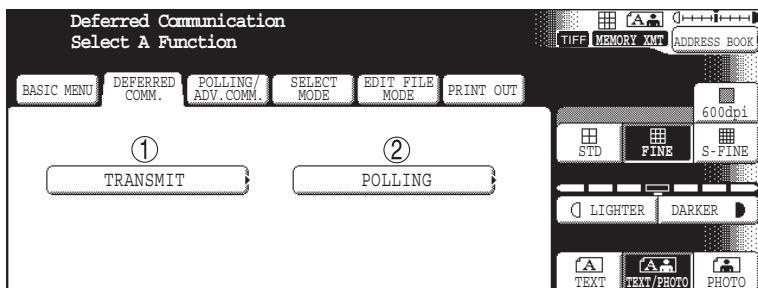

### DEFERRED COMM.

- ① Setting the Deferred Transmission. (See page 42)
- ② Setting the Deferred Polling. (See page 44)

## Setting the Mode Setting

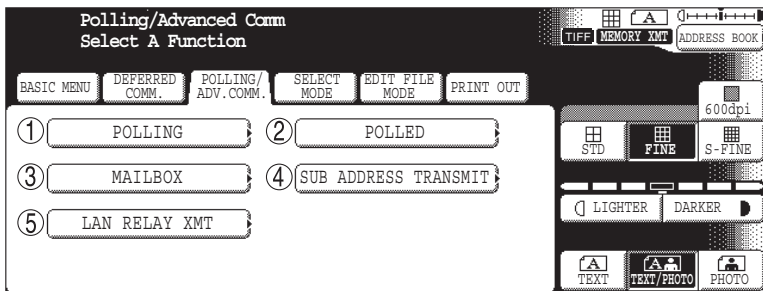

### POLLING/ADV. COMM.

- ① Setting the Polling. (See page 48)
- ② Setting the Polled. (See page 46)
- ③ Setting the Mailbox. (See page 57)
- ④ Setting the Sub Address Transmission. (See page 66)
- ⑤ LAN Relay XMT (See page 160)

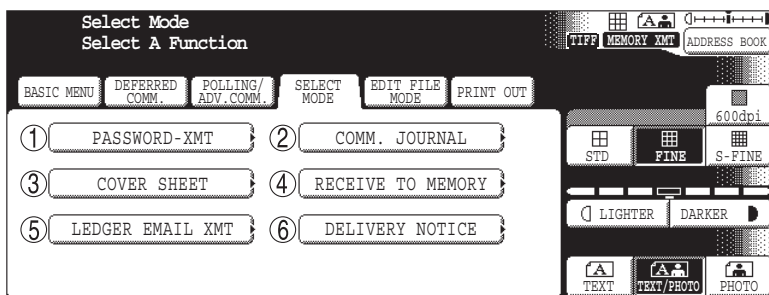

### SELECT MODE

- ① Setting the Password Transmission. (See page 81)
- ② Setting the Communication Journal. (See page 209)
- ③ Setting the Cover Sheet. (See page 73)
- ④ Setting the Receive to Memory. (See page 84)
- ⑤ Ledger Email XMT (See page 129)
- ⑥ Delivery Notice (See pages 112, and 195)

*Continued on the next page...*

# Mode Setting

## Setting the Mode Setting

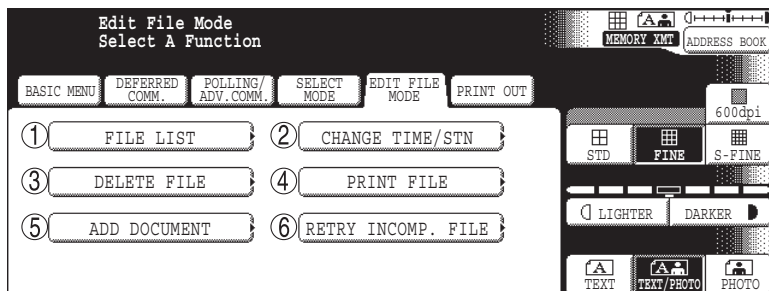

### EDIT FILE MODE

- ① Printing, or Viewing a File List. (See page 98)
- ② Changing the Start Time, or the Station of a File. (See page 100)
- ③ Deleting a File. (See page 102)
- ④ Printing Out a File. (See page 103)
- ⑤ Adding Documents into a File. (See page 104)
- ⑥ Retry an Incomplete File. (See page 105)

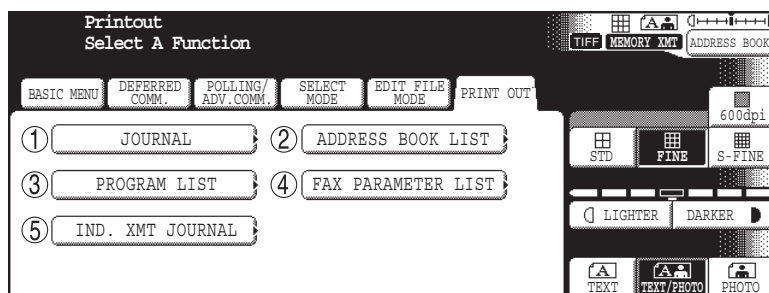

### PRINT OUT

- ① Journal (See page 205)
- ② Address Book List (See page 211)
- ③ Program List (See page 213)
- ④ Fax Parameter List (See page 214)
- ⑤ Individual XMT Journal

# Batch Transmission

## General Description

To reduce transmission time, and cost, this feature allows your machine to accumulate different documents for the same destination(s) to be transmitted in a single phone call.

### Real-Time Batch Transmission

During memory transmission, your machine searches its memory for reserved files (Up to 5 files) to transmit to the same destination, automatically batching, and transmitting them in a single phone call. The following is an example of Real-time Batch Transmission. (See Note 1)

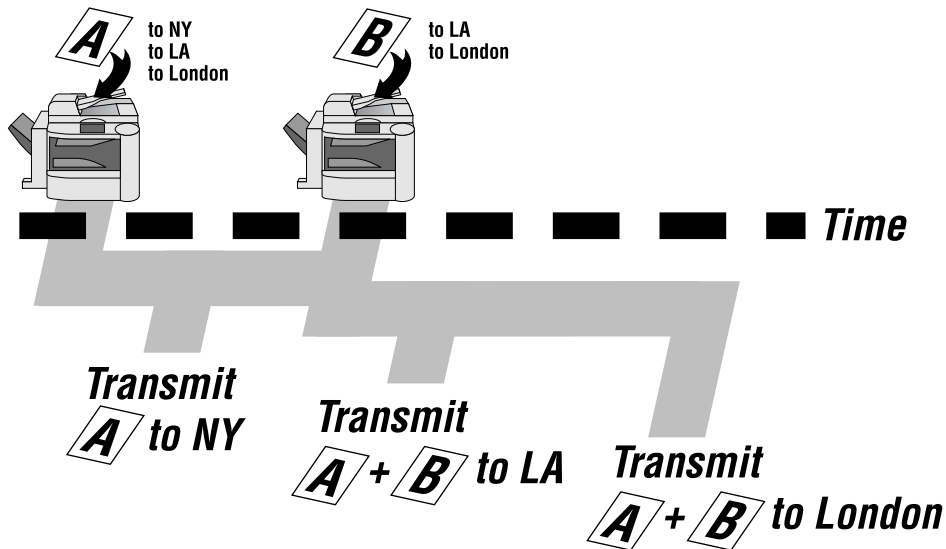

### Delayed Batch Transmission

Assign a time for batch transmission to a Program Key in advance. All transmission(s) using the Program Key are batched, and transmitted at the reserved time. The following is an example of Delayed Batch Transmission.

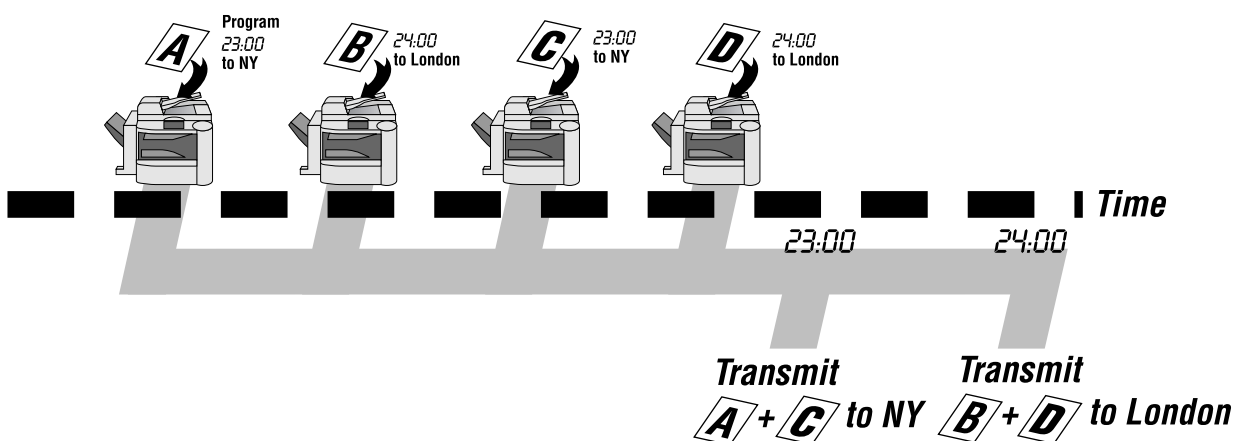

#### NOTE

1. The machine can not Batch to a file(s) that is/are Waiting to Redial, or is currently being sent, but it will Batch to files that are pending to dial.

# Timer Controlled Communications

## General Description

You can send document(s) to one, or multiple stations at any preset time within the next 24 hours. Up to 50 built-in timers can be set for deferred communication.

## Deferred Transmission

Make sure that the FAX/EMAIL lamp is ON. If not, press  to select the "FAX/EMAIL" mode.



Place original(s) face up on the ADF.

or



Place a book, or an original face down on the Platen Glass.

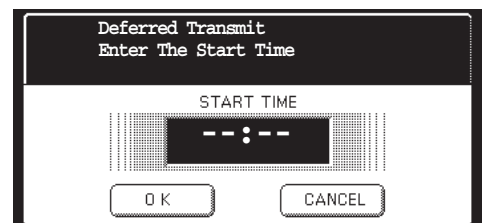
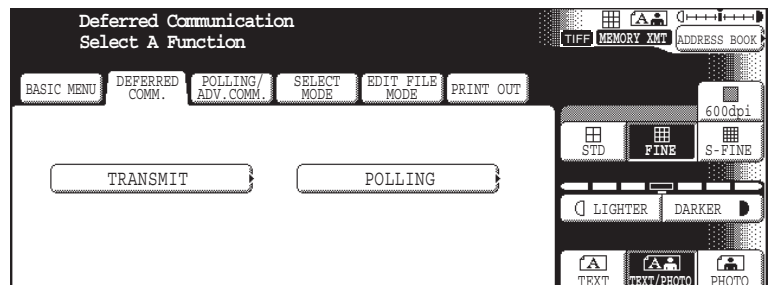

# Timer Controlled Communications

## Deferred Transmission

- 4** Enter the start time from the keypad, and press **OK**.  
(Use a 4-digit, 24-hour clock)

Ex: **2 3 3 0** (11:30 p.m.) and **OK**

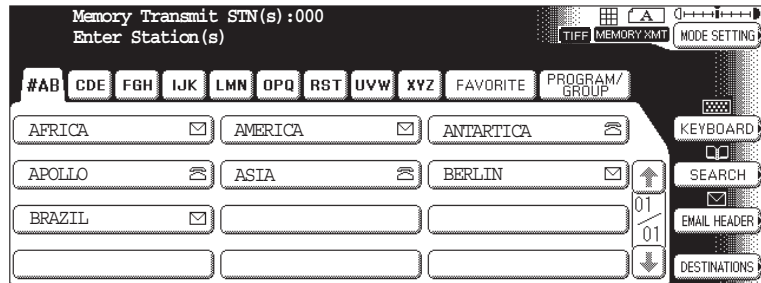

- 5** Dial by any combination of the following methods:

- Manual Number Dialing, press **OK** after each station is entered (Up to 70 stations)
- Address Book Dialing (Up to 200 stations)

Ex: **PANASONIC**

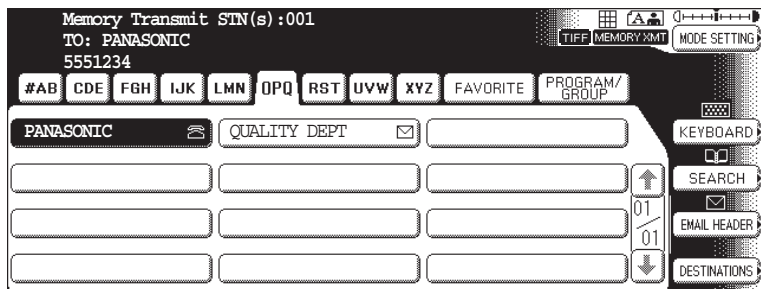

**6**

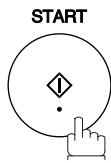

To store document(s) into the memory.

### NOTE

1. If you enter a wrong time in Step 4, press **CLEAR** then re-enter the correct time.
2. To change, or cancel the Deferred Communication settings, see pages 100 to 102.

# Timer Controlled Communications

## Deferred Polling

Make sure that the FAX/EMAIL lamp is ON. If not, press  to select the "FAX/EMAIL" mode.



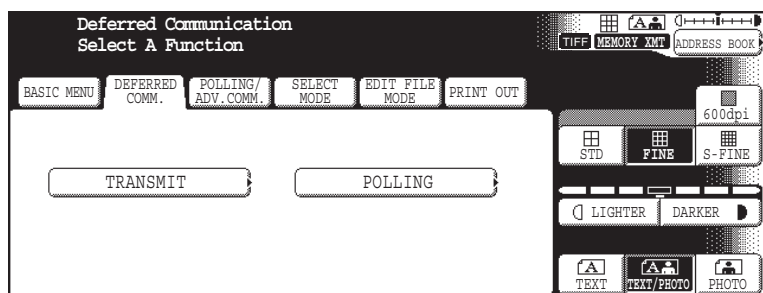

**1**  

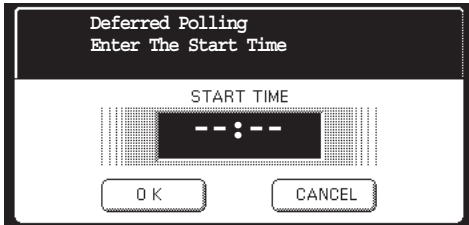



**2** 





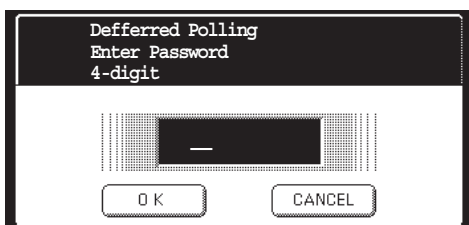

**3** Enter the start time from the keypad, and press .  
(Use a 4-digit, 24-hour clock)

Ex:     (3:30 a.m.) and 



**4** Enter a 4-digit polling password, and press .

Ex:     and 

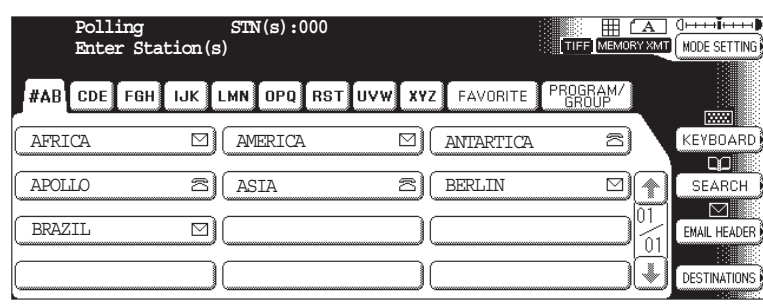



# Timer Controlled Communications

## Deferred Polling

5

Dial by any combination of the following methods:

- Manual Number Dialing, press **OK** after each station is entered (Up to 70 stations)
- Address Book Dialing (Up to 200 stations)  
(For details, see page 22.)

Ex: **PANASONIC**

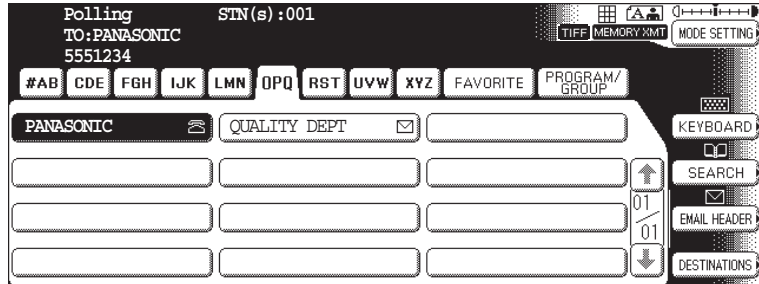

6

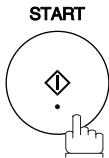

### NOTE

1. If you enter a wrong number in Step 4, press **CLEAR**, then re-enter the right number.
2. To change, or cancel the Deferred Communication settings, see pages 100 to 102.

# Polling

## General Description

Polling means calling other station(s) to retrieve document(s). The other station must know in advance that you will call, and must have document(s) set on the ADF, or stored in the memory. You may need to set a polling password, shared by the other station, to ensure security.

## Preparing to be Polled

In order to let other stations poll your machine, you must prepare your machine with a document stored in memory. Be sure to set the polling password before storing the document into memory. After being polled, the documents stored in the memory will be erased automatically. To retain the documents in memory so that they can be polled repeatedly change Fax Parameter No. 27 (POLLED FILE SAVE) to "Valid".

Make sure that the FAX/EMAIL lamp is ON. If not, press  to select the "FAX/EMAIL" mode.



Place original(s) face up on the ADF.  
or



Place a book, or an original face down on the Platen Glass.

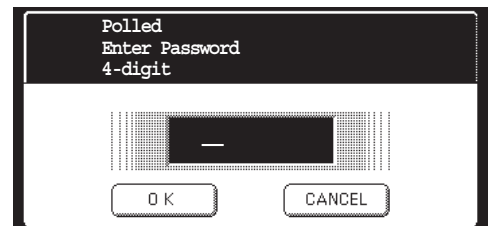
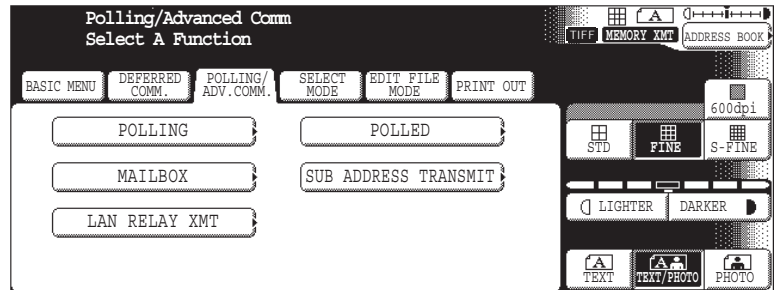

## Preparing to be Polled

**4** Enter a 4-digit polling password, and then press **OK**.  
(See Note 3)

**Ex:** ④ ③ ② ① and press **OK**.

The document(s) will be stored into memory.

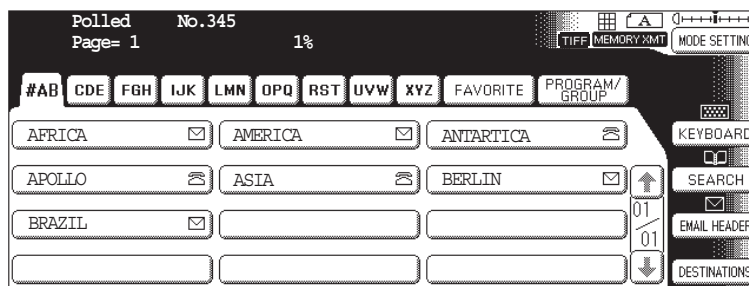

### NOTE

1. You can still send, or receive documents even when set to be polled.
2. Only 1 polled file can be stored in memory. If you need to add document(s) into the same polled file, see page 104.
3. If you have set the polling password in Fax Parameter No. 26, the password will appear on the display.  
You can still change the password temporarily by overwriting it with a new one.

# Polling

## Poll Documents from Another Station

The following procedure lets you poll document(s) from one, or multiple stations. Be sure to set the polling password before polling. (See page 46)

Make sure that the FAX/EMAIL lamp is ON. If not, press  to select the "FAX/EMAIL" mode.



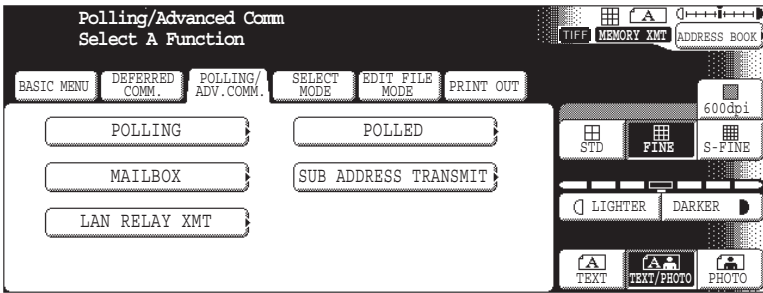

- 1  



- 2 



- 3 Enter a 4-digit polling password, and then press . (See Note 1)

Ex:     and press 

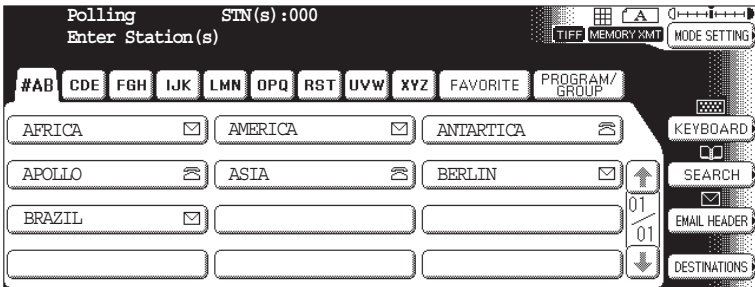

## Poll Documents from Another Station

# 4

Dial by any combination of the following methods:

- Manual Number Dialing, press **OK** after each station is entered (Up to 70 stations)
- Address Book Dialing (Up to 200 stations)  
(For details, see page 22.)

Ex: **PANASONIC**

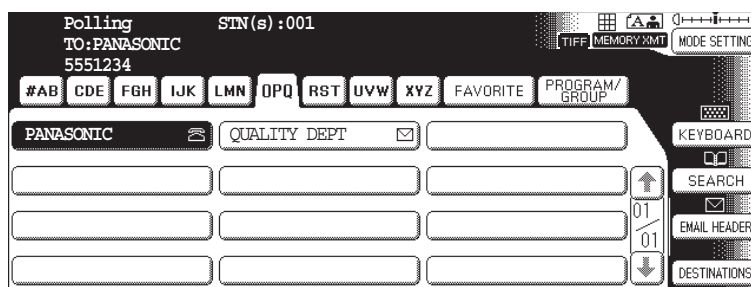

# 5

START

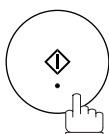

### NOTE

1. If a password is not set in the polled station, you may poll the other station even though your machine has a password.

# Program Keys

## General Description

Your fax machine has special Program Keys. These keys are useful if you frequently need to send, or poll the same group of stations. You can use these keys to assign registered Address Book stations as a group key, a sequence of stations to be polled, a deferred transmission sequence, or an additional address book entry.

## Setting for Group Dialing

To set a Program Key for Group Dialing

1

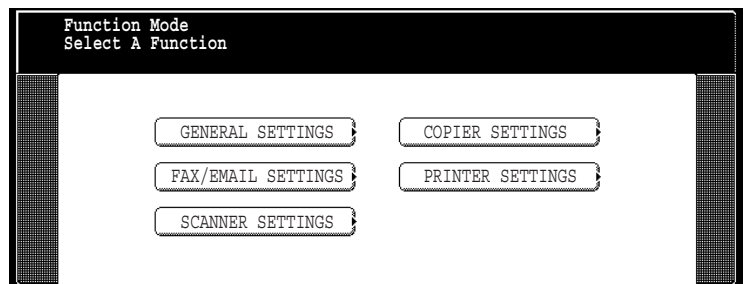

2

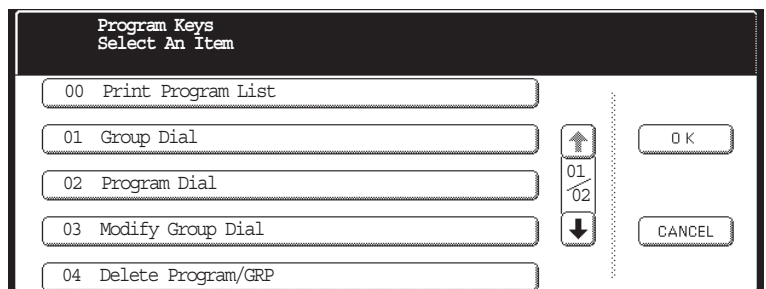

3

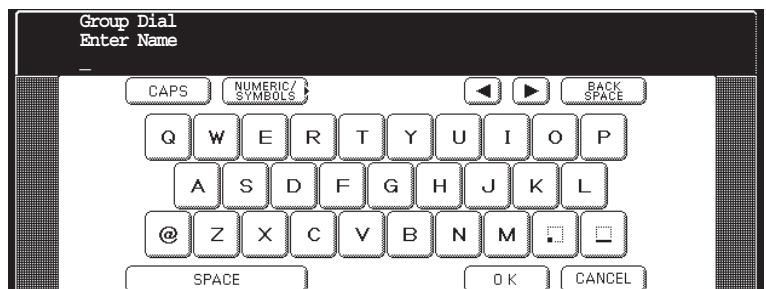

## Setting for Group Dialing

- 4** Enter the Group Name (Up to 15 characters), and press **OK**.  
 Ex: **CAPS** PROG. A and press **OK**

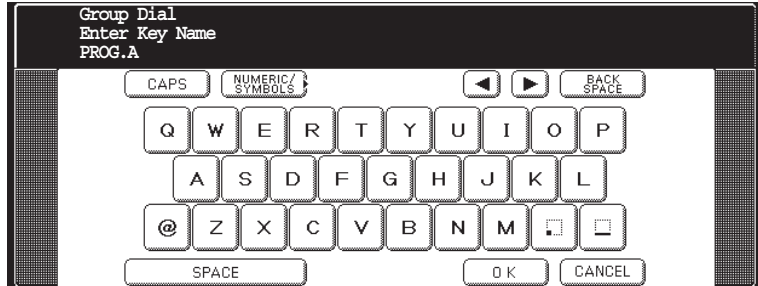

- 5** Enter a Key Name (Up to 15 characters), and press **OK**.

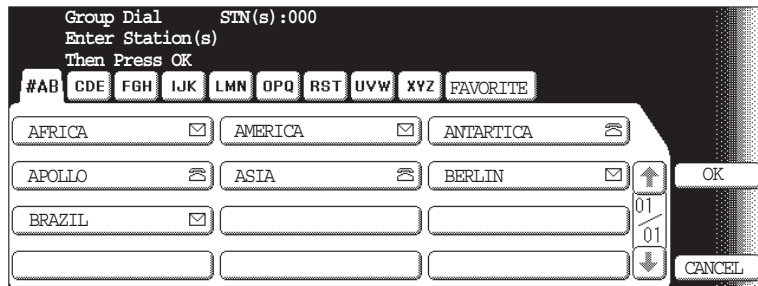

- 6** Enter the Address Book Dialing.  
 If you find an error, press **CLEAR** to erase the displayed station.

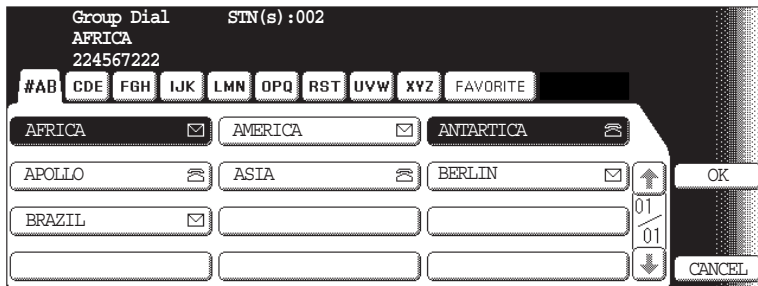

- 7**
- 

You can now set other Program Keys by repeating the procedures from Step 3, or return to standby by pressing **STOP**.

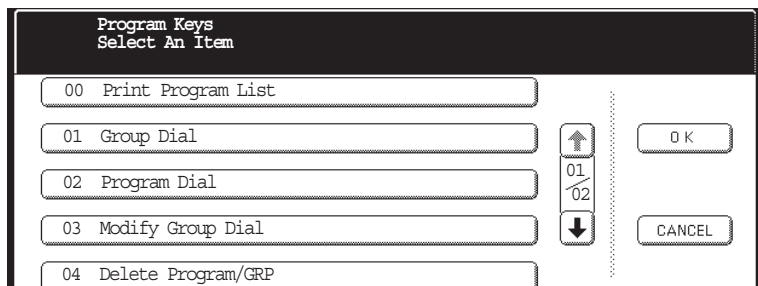

# Program Keys

## Setting for Program Dial

Make sure that the FAX/EMAIL lamp is ON. If not, press  to select the "FAX/EMAIL" mode.

**1** 

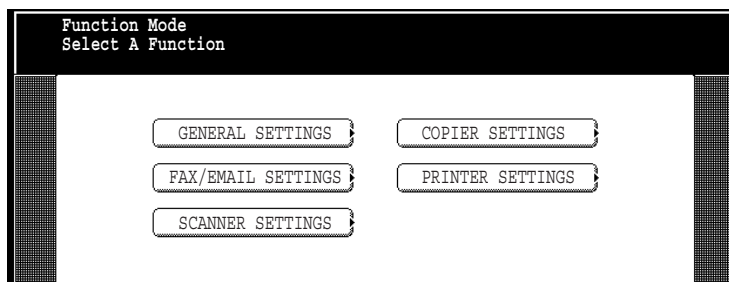

**2**  

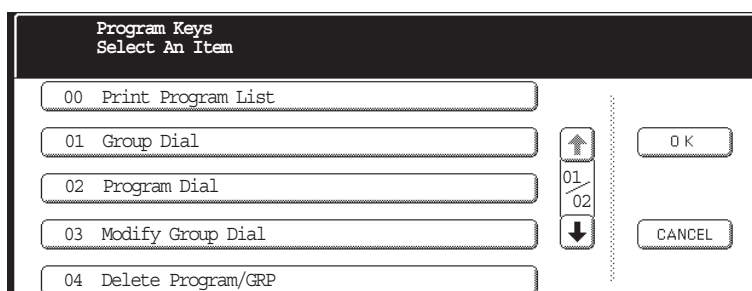

**3** 

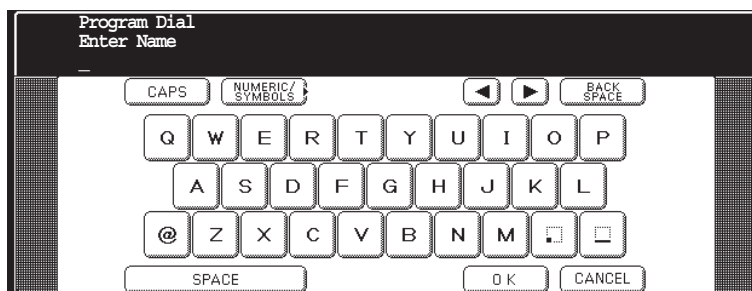

**4** Enter the Program Name (Up to 15 characters), and press **OK**.  
Ex: PRO.POLL and press **OK**.

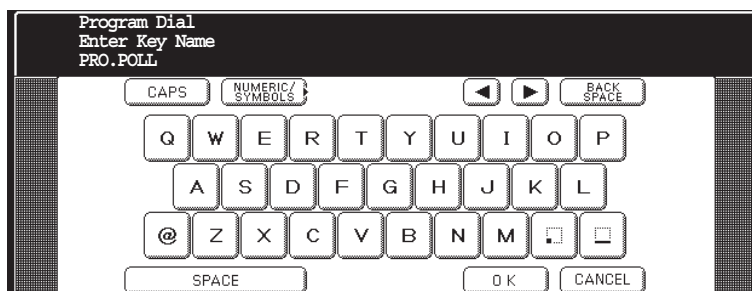



## Setting for Program Dial

- 5** Enter the Program Key Name (Up to 15 characters), and press **OK**.

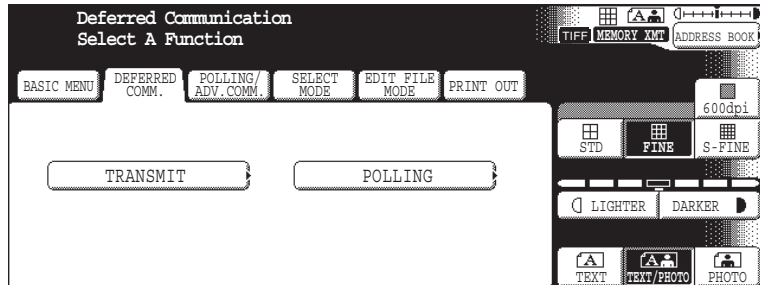

- 6** Program each Function.
- Deferred Communication (See page 42)
  - Polling Communication (See page 46)

- 7** You can now set other Program Keys by repeating the procedures from Step 3, or return to standby by pressing **STOP**.

# Program Keys

## Editing for Group Dialing

If you have to change, or erase any of the Group Dialing, follow the steps below.

### To change the setting of Group Dialing

Make sure that the FAX/EMAIL lamp is ON. If not, press  to select the "FAX/EMAIL" mode.

**1** 

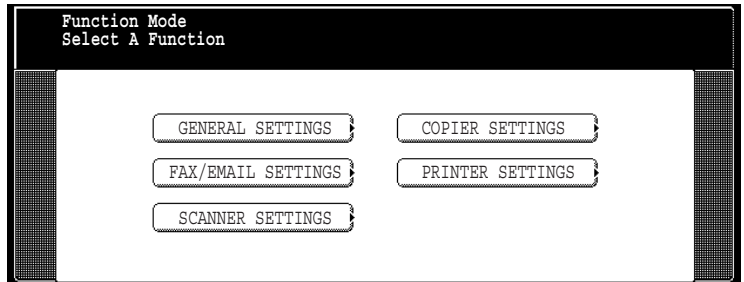

**2**  

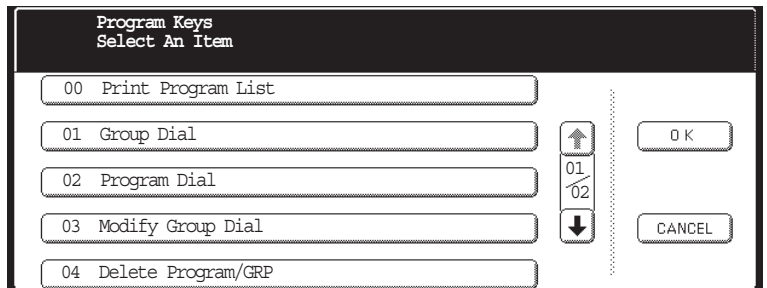

**3** 

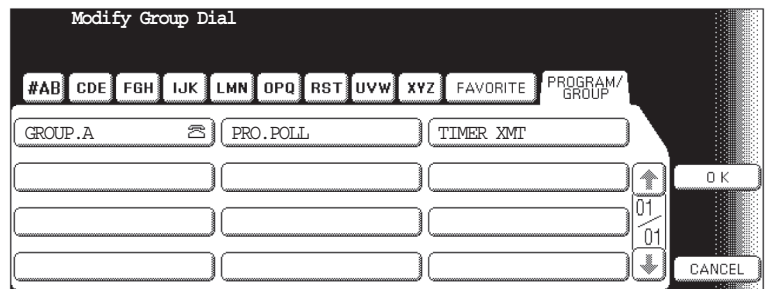

**4** Enter the Group Dial you wish to change, and press **OK**.  
Ex: GROUP.A and press **OK**.

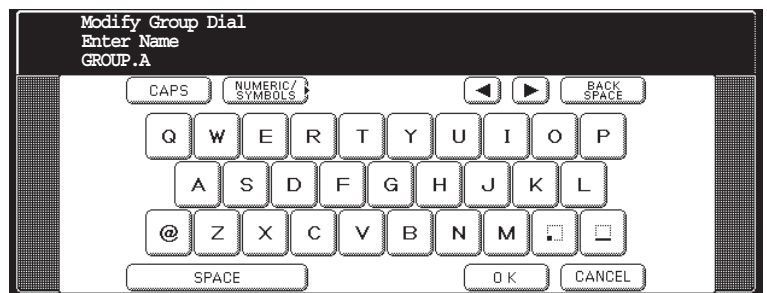

## Editing for Group Dialing

- 5** Enter the new Group Name (Up to 15 characters), and press **OK**.  
 (See Note 1)  
**Ex:** NEW GROUP and press **OK**.

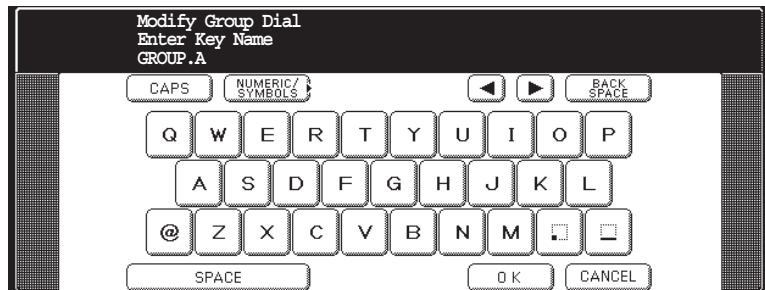

- 6** Enter the new Key Name (Up to 15 characters), and press **OK**.  
 (See Note 1)  
**Ex:** NEW GROUP and press **OK**.

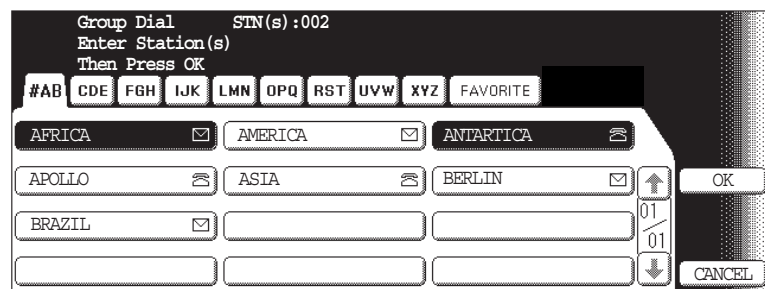

- 7** Enter the Address Book Dialing.  
 Press the Address Book Dialing you wish to enter, or erase the displayed station.



- 8**
- 

You can now set other Program Keys by repeating the procedures from Step 3, or return to standby by pressing **STOP**.

**NOTE**

- If you make a mistake, use **◀** or **▶** to move the cursor beyond the incorrect character, press **CLEAR** then re-enter the correct Department Name.
- The Group Dialing cannot be changed, or erased until the communication has finished. To change, or erase the settings, cancel the communication first by Edit File Mode. (See pages 100 to 102)

# Program Keys

## Erasing the Program Key Settings

To erase the settings in a Program Key

1

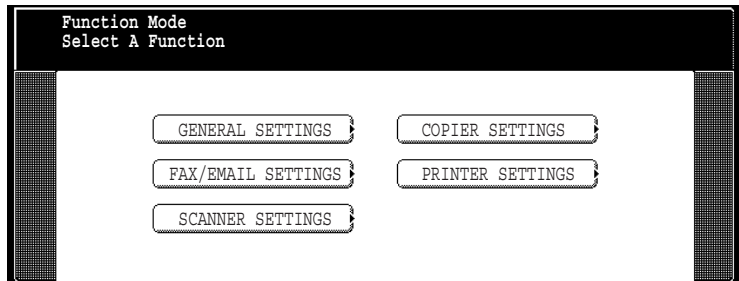

2

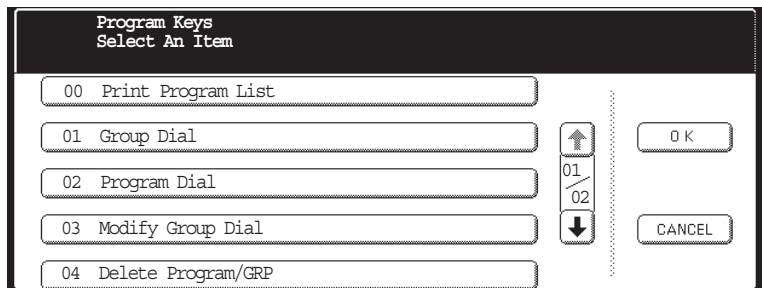

3

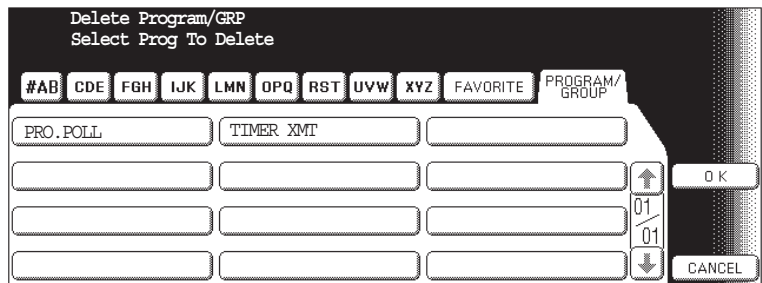

4

Press the Program key you want to erase.

Ex: **PRO.POLL**

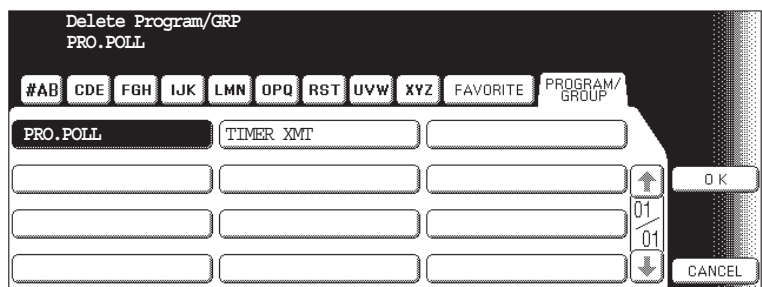

5

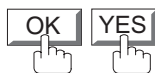

6

You can now erase other Program Keys by repeating the procedures from Step 4, or return to standby by pressing **STOP**.

### NOTE

1. The Program Key cannot be changed, or erased until the communication has finished. To change, or erase the settings, cancel the communication first by Edit File Mode. (See pages 100 to 102)

# Confidential Mailbox

## General Description

Your machine is equipped with two Confidential Communication features which ensure that the Confidential information you send is received only by the person with the correct confidential code.

## Confidential Mailbox

The confidential mailbox feature can be used as a mailbox to communicate with other compatible models using a 4-digit confidential code. The Confidential Mailbox feature receives document(s) with a confidential code into memory. These documents can only be printed by the person who has the correct confidential code.

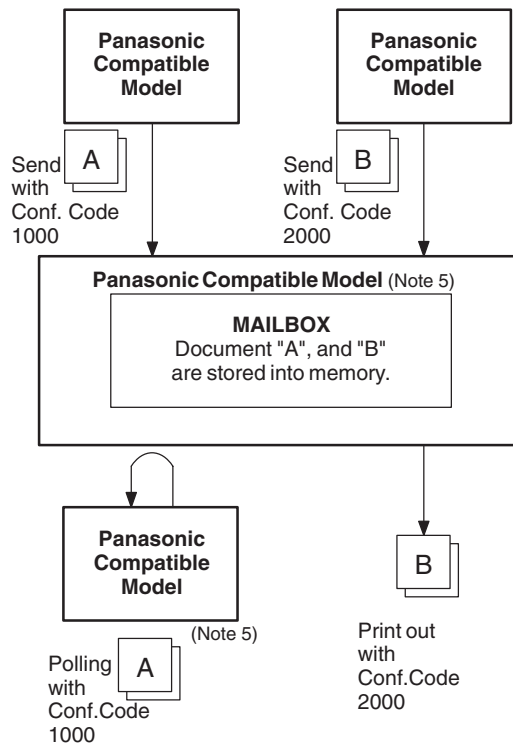

## Compatibility with Other Machines

Table 1 shows a list of compatible Panafax models which have the Confidential Mailbox feature. It also shows whether, or not special settings are required.

**Table 1 : Confidential Mailbox Requirement**

Compatible Model								Special Settings
DP-180	DP-190	DP-1820E	DP-1820P	DP-2330	DP-3030	DP-3530	DP-4530	Not required.
DP-6030	DP-8020P	DP-8020E	DP-8032	DP-8025	DP-8035	DP-8045	DP-8060	
DP-C213	DP-C262	DP-C263	DP-C264	DP-C265	DP-C305	DP-C322	DP-C323	
DP-C354	DP-C405	DX-800	UF-733	UF-6000	UF-9000			

### NOTE

1. If your machine receives two confidential faxes with same confidential code, both documents are stored together in the same confidential mailbox.
2. Up to 50 Mailbox files can be stored in memory. So, you can receive the confidential fax using 50 different confidential codes.
3. If the memory overflows, the machine will stop receiving, and release the line.
4. We recommend that optional flash memory card be installed when this function is used. See page 223 on Image Memory Capacity.
5. If confidential faxes were received in the mailbox of UF-733, you cannot poll those documents. The UF-733 is designed to print out the received confidential document locally only.

# Confidential Mailbox

## Sending a Confidential Document to a Remote Station's Mailbox

Make sure that the FAX/EMAIL lamp is ON. If not, press  to select the "FAX/EMAIL" mode.



Place original(s) face up on the ADF.  
or



Place a book, or an original face down on the Platen Glass.

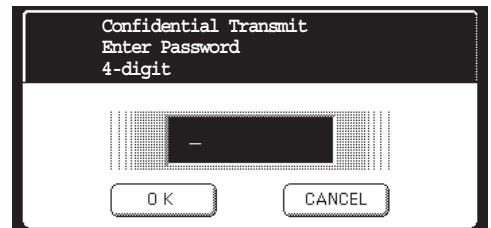
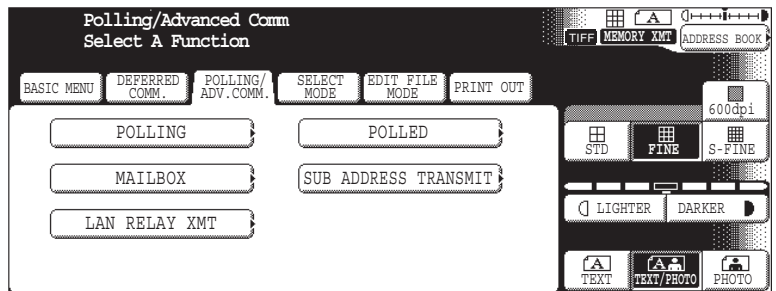

**4** Enter a 4-digit Confidential Code, and press **OK**.  
Ex: **2 2 3 3** and press **OK**

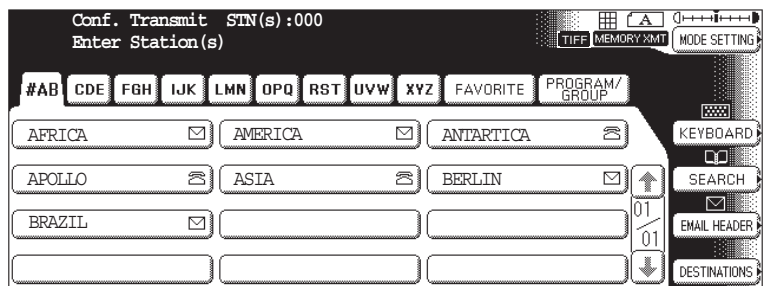

### Sending a Confidential Document to a Remote Station's Mailbox

**5**

Dial by any one of the following methods:

- Manual Number Dialing, press **OK** after each station is entered (Up to 70 stations)
- Address Book Dialing (Up to 200 stations)

Ex: **PANASONIC**

**6**

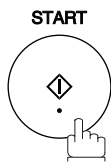

**7**

If necessary, inform the receiving person, and tell them the Confidential Code.

# Confidential Mailbox

## Polling a Confidential Document from a Remote Station's Mailbox

After you have been informed that someone has transmitted a confidential document to a remote station's mailbox, you can poll the confidential document from the remote station by following the procedure below.





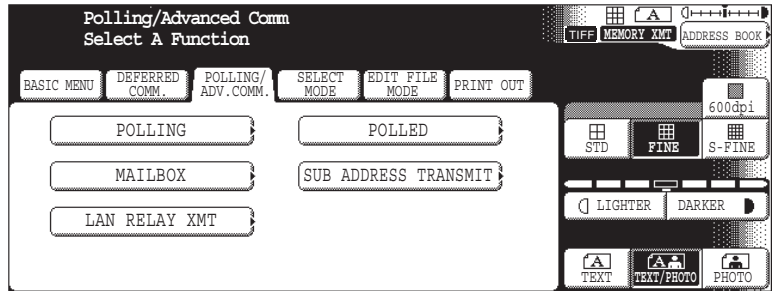

Make sure that the FAX/EMAIL lamp is ON. If not, press  to select the "FAX/EMAIL" mode.

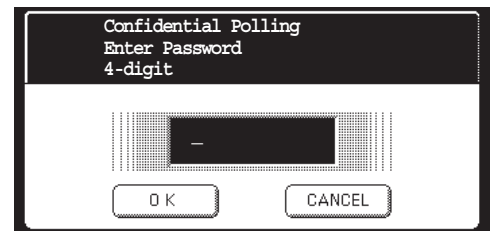
**1**  



**2**  



**3** Enter a 4-digit Confidential Code, and press .  
Ex:     and press 

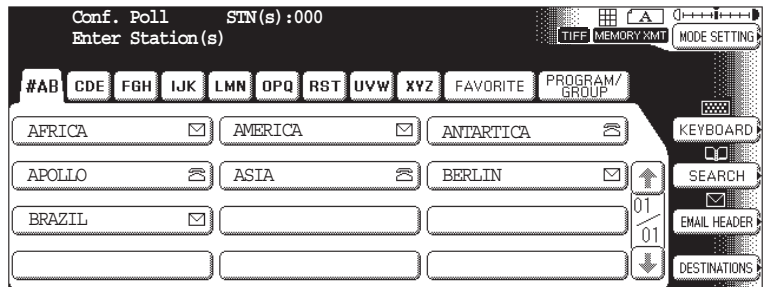

**4** Dial by any one of the following methods:

- Manual Number Dialing, press  after each station is entered (Up to 70 stations)
- Address Book Dialing (Up to 200 stations)

Ex: 

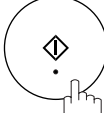
**5** 

### NOTE

1. The confidential file will be erased automatically at the center station after being polled.



## Receiving a Confidential Document to Your Machine's Mailbox

No special setting is required, your machine comes with this feature ready to use. Your machine receives a confidential fax the same way it receives a normal fax message. When receiving the confidential fax, the display shows the following message (CONF. RCV REPORT), and prints out the Confidential Receive Report.

### Sample CONF. RCV Report

```

***** -CONF. RCV REPORT- ***** DATE MMM-dd-yyyy ***** TIME 15:00 *****

      ** NOTICE OF CONFIDENTIAL DOCUMENT HELD **

(1)      (2)      (3)      (4)
FILE NO. RECEIVED FROM      PAGES      TIME RECEIVED

    040      PANAFAX      001      MMM-dd 15:00

                                -PANASONIC      -

***** DP-xxxx ***** -HEAD OFFICE - ***** -      201 555 1212- *****
    
```

### Explanation of Contents

- (1) File number : 001 to 999
- (2) Received remote station's ID : Character ID or Numeric ID
- (3) Number of pages received
- (4) Received date, and time

### NOTE

1. If your machine receives two confidential faxes with same confidential code, both documents are stored together in the same confidential mailbox.
2. Up to 20 Mailbox files can be stored in memory. So, you can receive the confidential fax using 20 different confidential codes.
3. If the memory overflows, the machine will stop receiving, and release the line.

# Confidential Mailbox

## Storing a Confidential Document in Your Machine's Mailbox

Use the following procedure to store a document in a confidential mailbox in your machine. Once the confidential document is stored in your machine, it can be polled by another machine.

Make sure that the FAX/EMAIL lamp is ON. If not, press  to select the "FAX/EMAIL" mode.



Place original(s) face up on the ADF.  
or



Place a book, or an original face down on the Platen Glass.

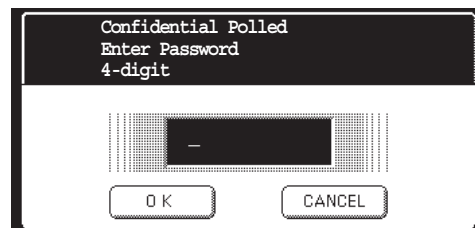
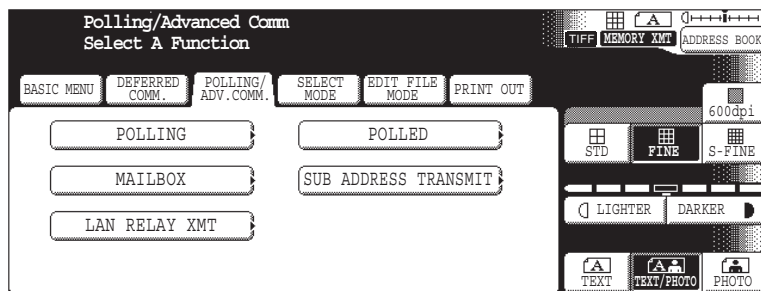

**4** Enter a 4-digit Confidential Code, and press **OK**.

Ex: ② ② ③ ③ and press **OK**

**5** The document(s) will be stored into memory.  
If necessary, inform the receiving party of the confidential document, and tell them the confidential code needed to poll the document.

### NOTE

1. The confidential file will be erased automatically after being polled.  
If you wish to retain the confidential file even after being polled, change the setting of Fax Parameter No. 42 (CONF. POLLED FILE SAVE) to "Valid".

## Printing Out a Confidential Document from Your Machine's Mailbox

After you have been notified that someone has transmitted a confidential document to your machine's mailbox, use the following procedure to print out the confidential document.

Make sure that the FAX/EMAIL lamp is ON. If not, press  to select the "FAX/EMAIL" mode.

**1**

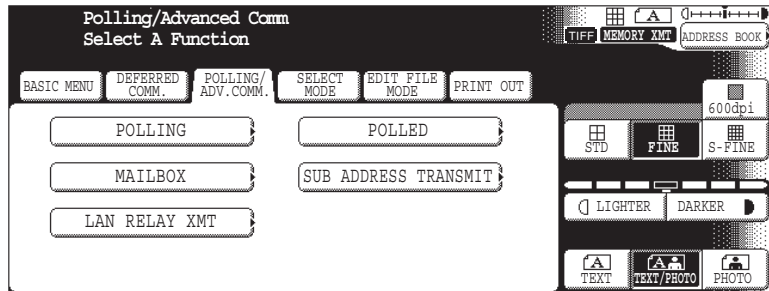

**2**

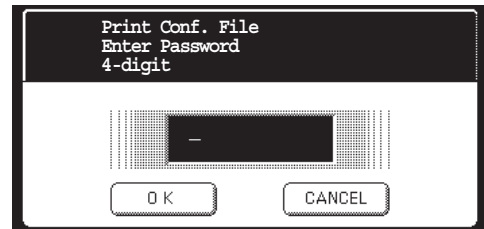

**3**

Enter the Confidential Code of the document you want to print, and then press **OK**.

**Ex:** ② ② ③ ③ and press **OK**

**4**

The machine will print out the confidential documents.

### NOTE

- The confidential file will be erased automatically after being printed out even if the setting of Fax Parameter No. 42 (CONF. POLLED FILE SAVE) is changed to "Valid".

# Confidential Mailbox

## Deleting a Confidential Document Stored in Your Machine's Mailbox

If your memory becomes full, or you just want to clean out your confidential documents, you may delete one, or more confidential faxes stored in your machine by using the following procedure.

There are two types of confidential file deletions, one is to delete the file individually by its Confidential Code, and the other is to delete all confidential files in memory.

### To delete a file using Confidential Code

Make sure that the FAX/EMAIL lamp is ON. If not, press  to select the "FAX/EMAIL" mode.

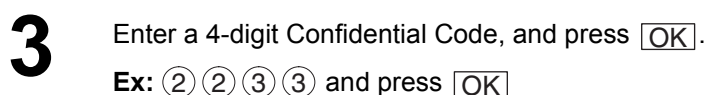
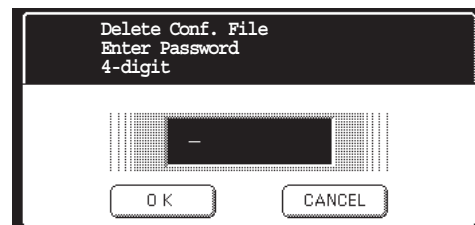
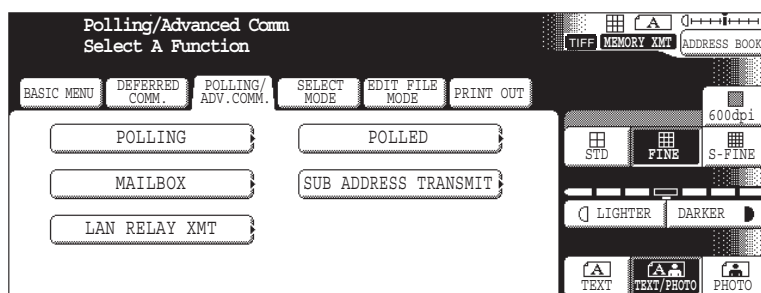

## Deleting a Confidential Document Stored in Your Machine's Mailbox

To delete all confidential files in memory

Make sure that the FAX/EMAIL lamp is ON. If not, press  to select the "FAX/EMAIL" mode.

1

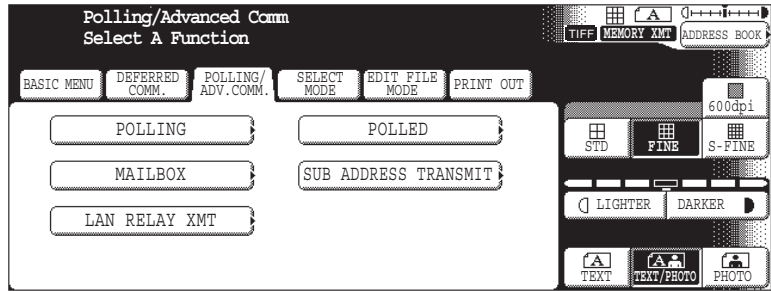

2

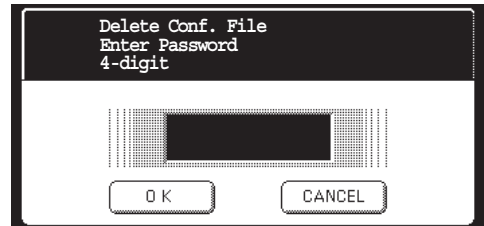

3

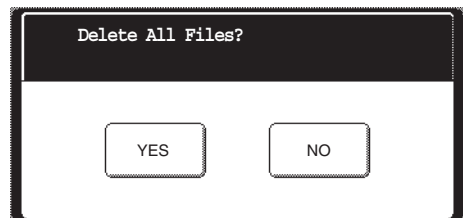

4



# Sub-Addressing

## General Description

The Sub-Addressing function allows you further routing, forwarding, or relaying of document(s) to the desired recipient(s) when used in combination with the Networking version of HydraFax/LaserFAX software. This function conforms to the ITU-T recommendation for T. Routing-Facsimile Routing utilizing the Sub-Address.

### Example of a Network

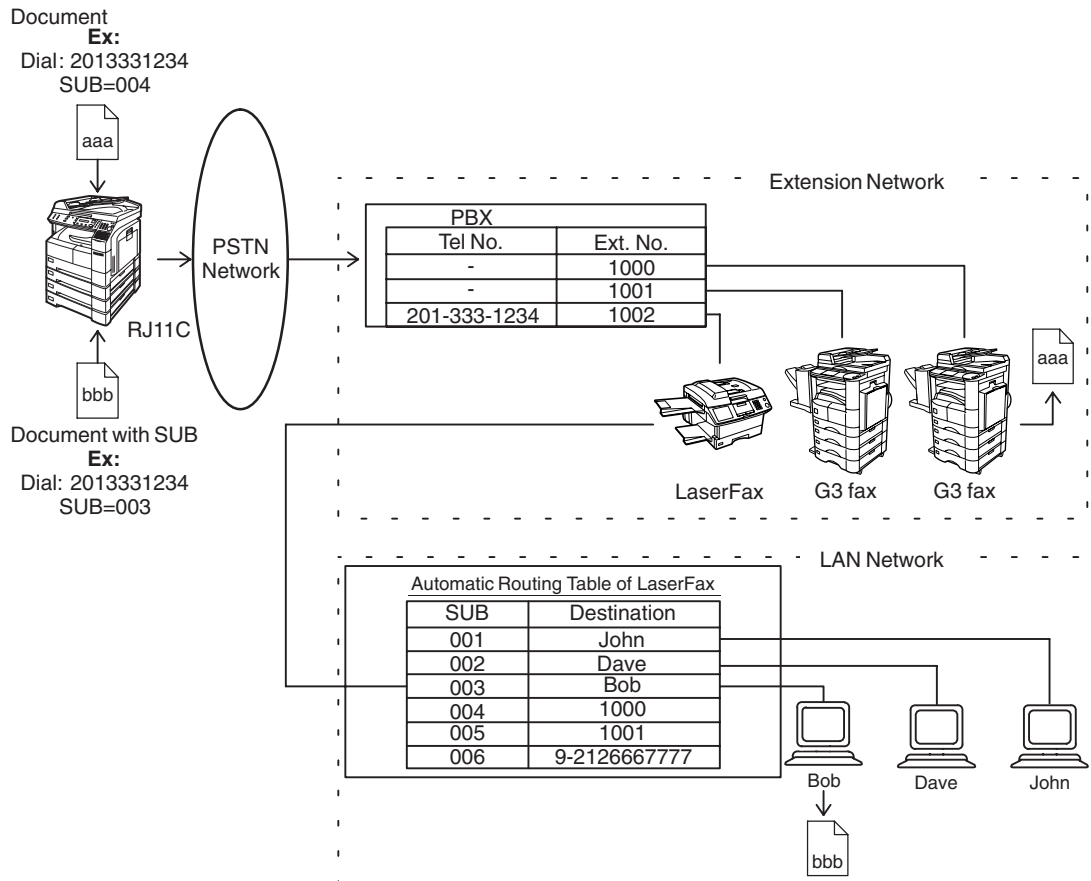

### Compatibility with Other Machines

- Sub-Addressing Transmission: D350F/DF-1100/DP-135FP/150FP/150FX/180/190/1810F/1820P/1820E/2000/2310/2330/2500/3000/3010/3030/3510/3520/3530/4510/4520/4530/6010/6020/6030/DX-600/800/1000/2000/FP-D250F/UF-332/333/342/344/490/550/560/585/590/595/770/780/788/790/880/885/890/895/990/7000/8000/9000 (See Note 2)
- Sub-Addressing Reception: DX-600/800, and DP-180/190/1810F/1820E/1820P/2000/2310/2330/2500/3000/3010/3030/3510/3520/3530/4510/4520/4530/6010/6020/6030/UF-7000/8000/9000/DP-8020P/8020E/8060/8045/8035 with Internet Fax.

### Sub-Addressing Transmission Methods

You can send a document with Sub-Address information to the desired recipient by the following methods.

- By registering the Sub-Address information into the Address Book stations.
- By specifying the Sub-Address information in the Manual Dialing Mode.

### Setting of Routing, Forwarding or Relaying

You can customize the Automatic Routing to any combination of LAN (Local Area Network), PSTN (Public Switched Telephone Network), or PBX Extension with HydraFax/LaserFAX Routing Table (please refer to the HydraFax/LaserFAX User Manual).

#### NOTE

1. HydraFax and LaserFAX are trademarks of Wordcraft International Ltd.
2. UF-788 with PC Interface Option, or the Option ROM installed.

## Setting the Sub-Address into a Address Book Number

1

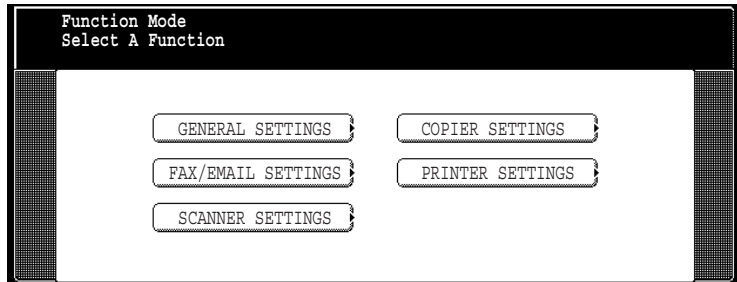

2

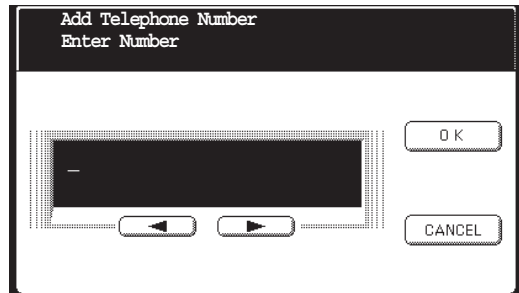
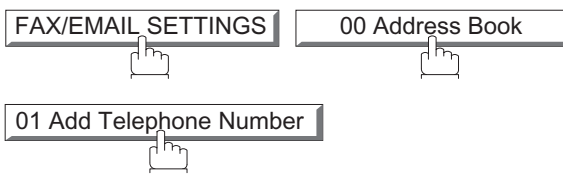

3

Enter the telephone number, press **[SUB-ADDR]** then enter the Sub-address.  
 (Up to 20 digits)  
 (Up to 36 digits including telephone number, pauses, spaces, FLASH, and Sub-address)

**Ex:** Telephone number = 5551234, Sub-address =2762

Enter as: (5) (5) (5) (1) (2) (3) (4) **[SUB-ADDR]** (2) (7) (6) (2)

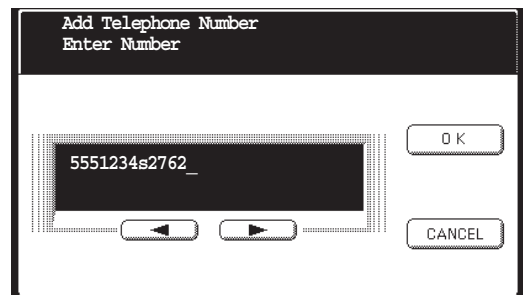

Continued on the next page...

## Sub-Addressing

### Setting the Sub-Address into a Address Book Number

4



And then continue to enter the station name, key name, and favorite key setting.

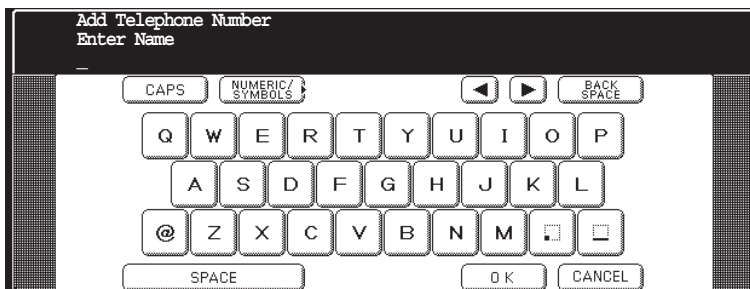

5



#### NOTE

1. **SUB-ADDR** separates the Sub-address from the Telephone number, and is indicated by an "s" in the display.



## Sending a Fax with Sub-Address

### Using the Address Book Dialing Numbers

The operation is the same as for normal dialing

Make sure that the FAX/EMAIL lamp is ON. If not, press  to select the "FAX/EMAIL" mode.



Place original(s) face up on the ADF.  
or



Place a book, or an original face down on the Platen Glass.

**2** Ex: SALES DEPT

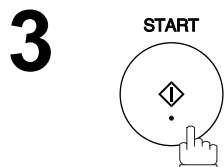
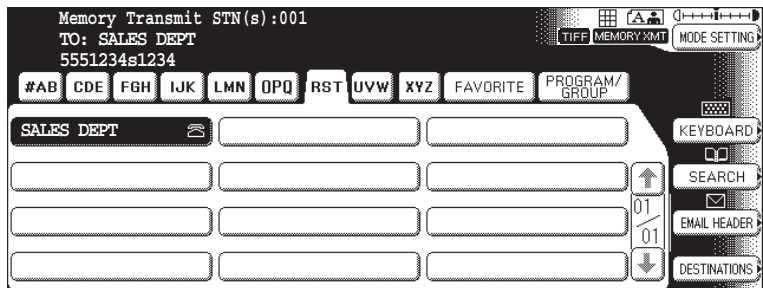

The document is stored into memory, and your machine starts to dial the number of the station, and sends the document(s) with Sub-addressing information.

# Sub-Addressing

## Using Manual Number Dialing

Use **[SUB-ADDR]** to separate the Telephone number, and the Sub-address.

Make sure that the FAX/EMAIL lamp is ON. If not, press  to select the "FAX/EMAIL" mode.



Place original(s) face up on the ADF.  
or



Place a book, or an original face down on the Platen Glass.

- 2** Enter the telephone number, press **[SUB-ADDR]** then enter the Sub-address (Up to 20 digits).  
(Up to 36 digits including telephone number, pauses, spaces, FLASH, and Sub-address)

Ex: Telephone number = 5551234, Sub-address =2762

Enter as: ⑤ ⑤ ⑤ ① ② ③ ④ **[SUB-ADDR]** ② ⑦ ⑥ ② **[OK]**

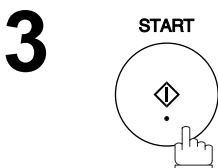
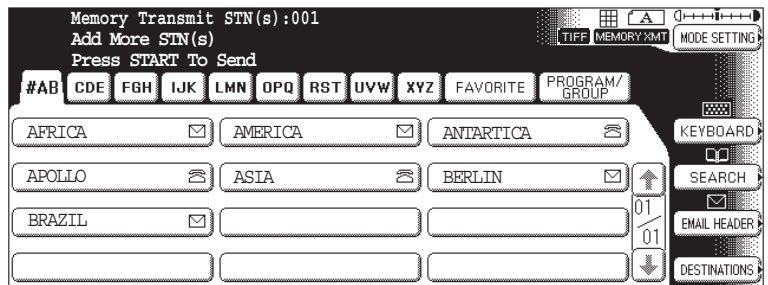

The document is stored into memory, and your machine starts to dial the number of the station, and sends the document(s) with Sub-addressing information.

### NOTE

- [SUB-ADDR]** separates the Sub-address from the Telephone number, and is indicated by an "s" in the display.
- Manual Off-Hook, or On-Hook Dialing cannot be used with the Sub-addressing Transmission.
- The Sub-address is not transmitted during Manual Redial Mode.

## Using Sub-Address Temporarily

Make sure that the FAX/EMAIL lamp is ON. If not, press  to select the "FAX/EMAIL" mode.



Place original(s) face up on the ADF.  
or



Place a book, or an original face down on the Platen Glass.

**2**

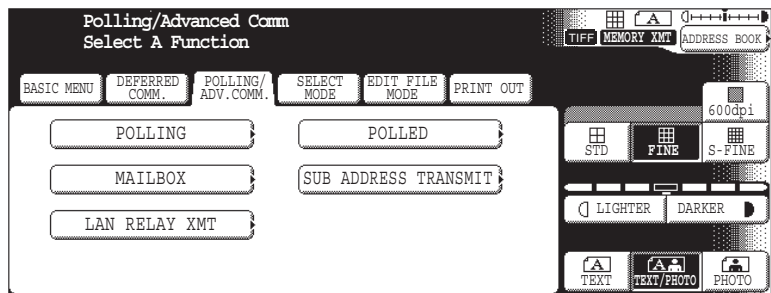

**3**

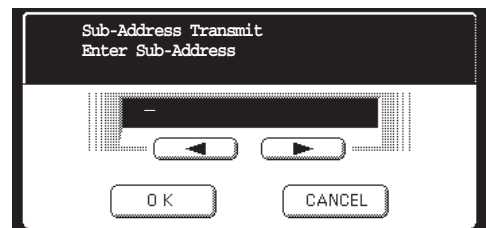

**4**

Enter the Sub-Address (Up to 20 digits), and then press **OK**.

Ex: **2 7 6 2** and press **OK**

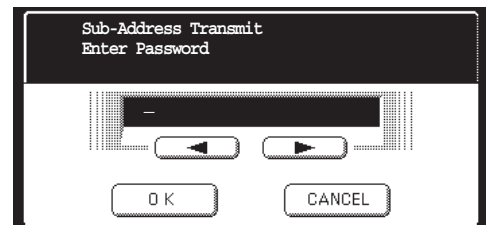

Continued on the next page...

# Sub-Addressing

## Using Sub-Address Temporarily

**5** Enter the Password (Up to 20 digits), and then press **OK**.

Ex: ① ② ③ ④ ⑤ and press **OK**

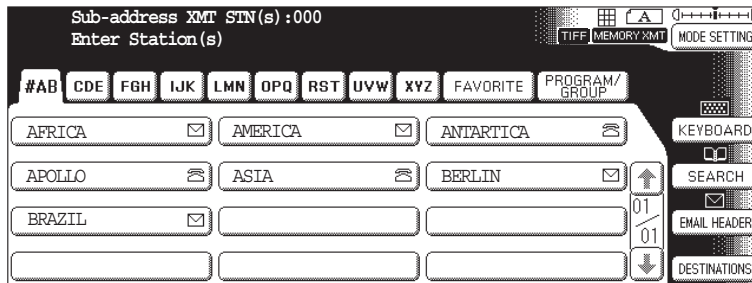

**6** Dial by any one of the following methods:

- Manual Number Dialing, press **OK** after each station is entered (Up to 70 stations)
- Address Book Dialing (Up to 200 stations)

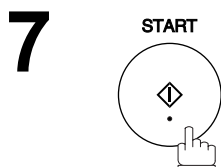

# Fax Cover Sheet

## General Description

A Fax Cover Sheet can be automatically attached to your transmit document(s) that shows the recipient's name, originator's name, and the number of pages attached.

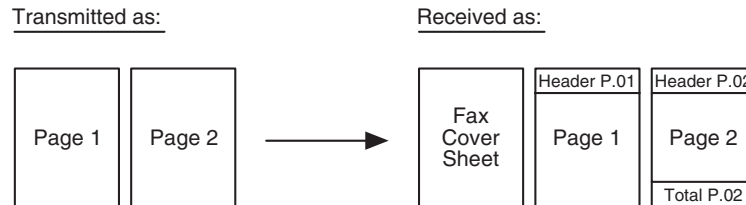

## Using the Fax Cover Sheet

To attach a Fax Cover Sheet to a transmission, follow the procedure below.

Make sure that the FAX/EMAIL lamp is ON. If not, press  to select the "FAX/EMAIL" mode.



Place original(s) face up on the ADF.  
or



Place a book, or an original face down on the Platen Glass.

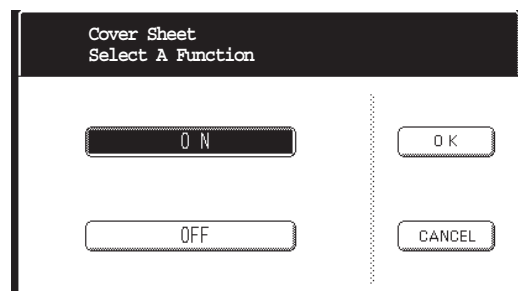
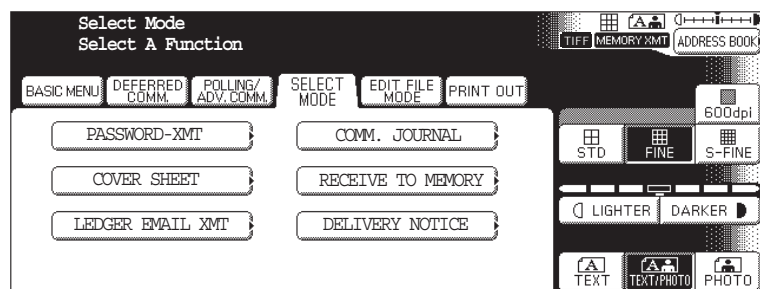

Continued on the next page...

# Fax Cover Sheet

## Using the Fax Cover Sheet

**4**  (Cover Sheet is not attached)

or

 (Cover Sheet is attached)

**5** 

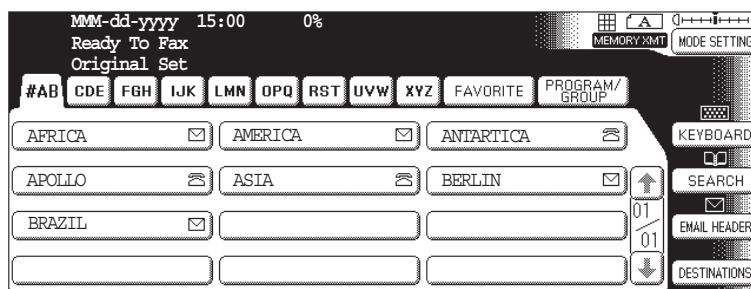

**6** Dial by any one of the following methods:

- Manual Number Dialing, press **OK** after each station is entered (Up to 70 stations)
- Address Book Dialing (Up to 200 stations)

Ex: **PANASONIC**

**7** 

### NOTE

1. To change the preset Fax Cover Sheet Setting, change the setting of Fax Parameter No. 56, see page 192.
2. This function is available for memory, or direct transmission modes.
3. The Fax Cover Sheet is not counted in the number of pages column of the journals.
4. When the Fax Cover Sheet setting is set to On, the Quick Memory XMT feature is disabled.

## Using the Fax Cover Sheet

### Fax Cover Sheet Sample

```
***** FACSIMILE COVER SHEET *****

      (1)
      MMM-dd-yyyy 15:00

      (2)
      Message To:
      [-----]
      | SALES DEPT. |
      |             |
      [-----]

      (3)
      Message From:
      [-----]
      | PANASONIC   |
      | 201 555 1212 |
      [-----]

      (4)
      02
      Page(s)
      Following This Cover Page
```

### Explanation of Contents

- (1) Starting time of communication.
- (2) Recorded name in the Address Book station.
- (3) Your LOGO (Up to 25 characters), and ID Number (Up to 20 digits).
- (4) The number of pages to follow. This information is not shown when transmitting by Direct Transmission Mode.

# Password Communications

## General Description

Password Communications, including Password Transmission, and Password Reception will prevent your machine from sending a fax to a wrong station, or receiving a fax from an unauthorized stations. You can set Password Transmission, and Password Reception independently, or both together.

To use Password Transmission, you must set a 4-digit transmission password in advance. The password must be shared with other compatible Panafax machine(s). If the transmission password in your machine does not match the transmission password in the other compatible Panafax machine(s), the transmission will fail. You can select password transmission by setting MODE SETTING-SELECT MODE-PASSWORD-XMT to "ON" when you send a document.

To use Password Reception, you must set a 4-digit receiving password in advance. The password must be shared with the other compatible Panafax machine(s). If the password in your machine does not match the receiving password in the other compatible Panafax machine(s), the reception will fail. Once you set password reception, and set the parameter to "ON", it stays until you change the setting to "OFF".

## Compatibility with Other Machines

You can only use password transmission, and reception with another Panafax compatible machine(s) listed below.

- DP-180
- DP-190
- DP-1820E
- DP-1820P
- DP-2330
- DP-3030
- DP-3530
- DP-4530
- DP-6030
- DP-8020P
- DP-8020E
- DP-8032
- DP-8025
- DP-8035
- DP-8045
- DP-8060
- DP-C213
- DP-C262
- DP-C263
- DP-C264
- DP-C265
- DP-C305
- DP-C322
- DP-C323
- DP-C354
- DP-C405
- DX-800
- UF-6000
- UF-9000

### NOTE

1. Special settings are required. Please refer to the individual Operating Instructions of each model.



## Setting Password Transmission

To set transmission password, and parameter,

1

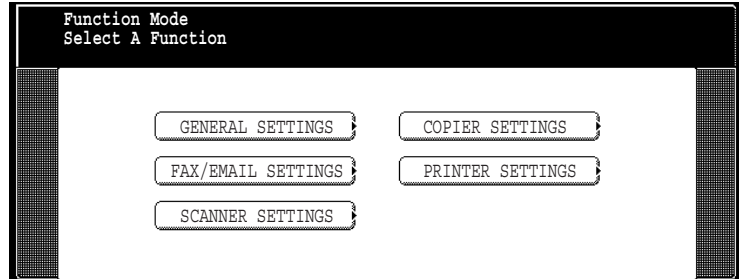

2

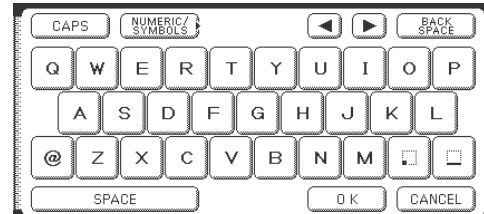
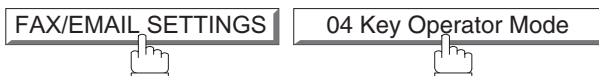

3

Input Key Operator's password, and press **OK**.  
(8 digits: alpha-numeric; alphabet (case-sensitive), numbers, symbols (@,..,\_and SPACE))

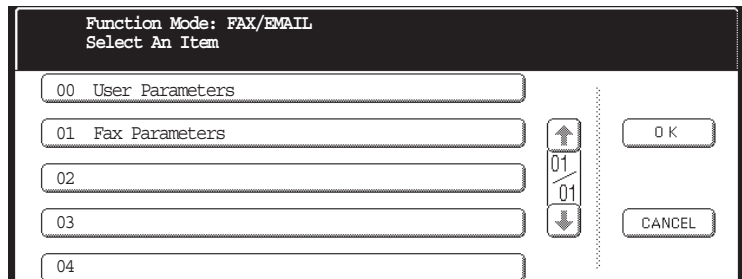

4

Press **01 Fax Parameters** **↑** or **↓** to scroll the display to the desired Fax Parameter.  
(See page 190)

**Ex:** **043 Password-Transmit**

or

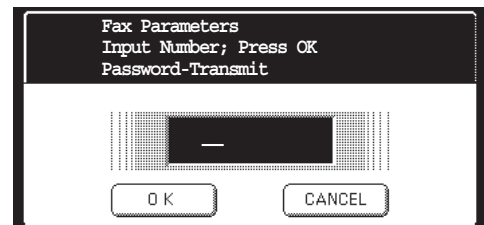



Press **01 Fax Parameters** and enter the Fax Parameter number directly from the keypad, and press **SET** or **START** key.

# Password Communications

## Setting Password Transmission

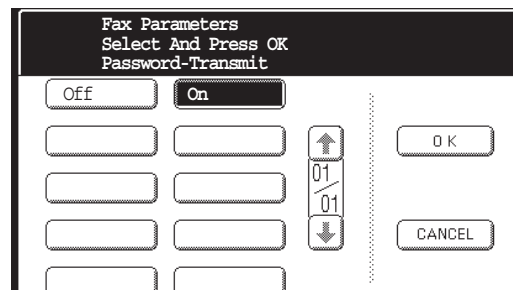
**5** Enter a 4-digit Transmission Password, and press **OK**.  
Ex: ① ② ③ ④ and press **OK**



**6**  (password is not checked)  
or  
 (password is checked)

**7**  

### NOTE

1. You can change the setting temporarily by using **MODE SETTING** **SELECT MODE** **PASSWORD-XMT** for each transmission. See page 81 for details.
2. To change the password, press **CLEAR** in step 4. Then re-enter a new one.

## Setting Password Reception

To set receiving password, and parameter,

**1**

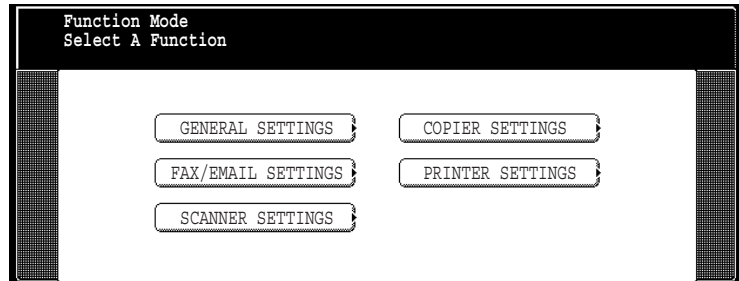

**2**

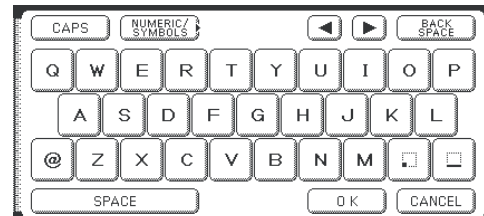
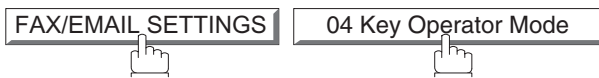

**3**

Input Key Operator's password, and press **OK**.  
(8 digits: alpha-numeric; alphabet (case-sensitive), numbers, symbols (@,.,\_, and SPACE))

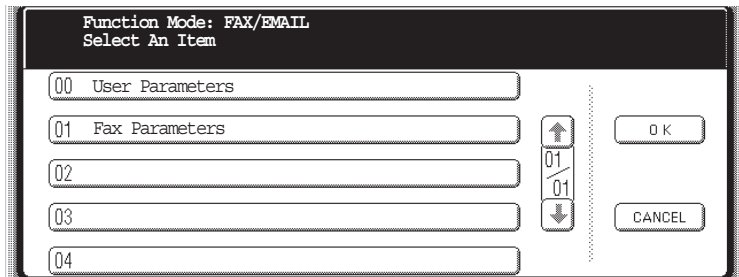

**4**

Press **01 Fax Parameters** or to scroll the display to the desired Fax Parameter.  
(See page 190)

**Ex:** **044 Password-Receive**

or

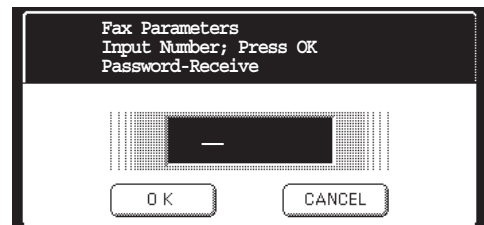



Press **01 Fax Parameters** and enter the Fax Parameter number directly from the keypad, and press **SET** or **START** key.

# Password Communications

## Setting Password Reception

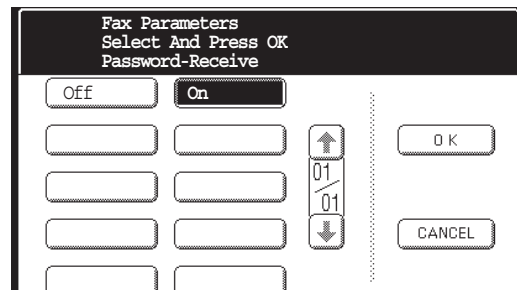
- 5** Enter a 4-digit Receiving Password, and press **OK**.  
Ex: ① ② ③ ④ and press **OK**



- 6**  (password is not checked)  
or  
 (password is checked)

- 7**  

### NOTE

1. Once you set the parameter, you cannot select the parameter, "OFF", or "ON", for each reception. It is always "OFF", or "ON" until you change the setting.
2. To change the password, press **CLEAR** in step 4. Then re-enter a new one.

## Using Password Transmission

To use Password Transmission, you can select PASSWORD-XMT "OFF", or "ON" for each Transmission by following the procedure below.

Make sure that the FAX/EMAIL lamp is ON. If not, press  to select the "FAX/EMAIL" mode.



Place original(s) face up on the ADF.  
or



Place a book, or an original face down on the Platen Glass.

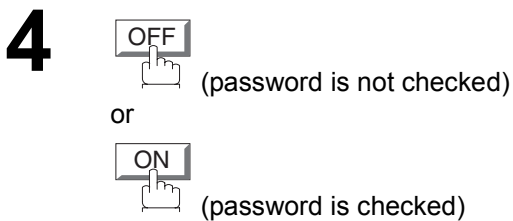
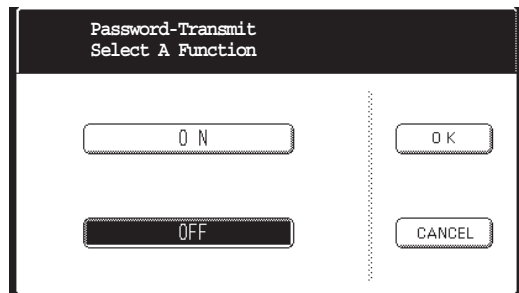
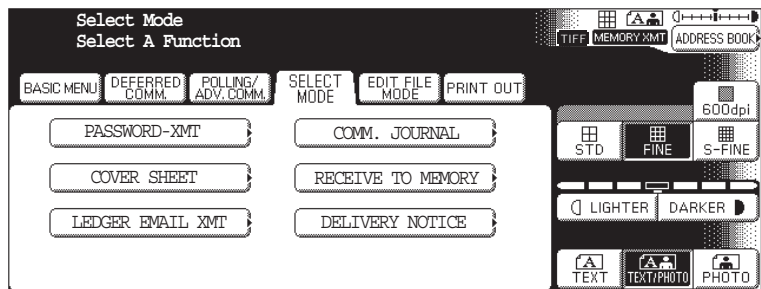

# Password Communications

## Using Password Transmission

5

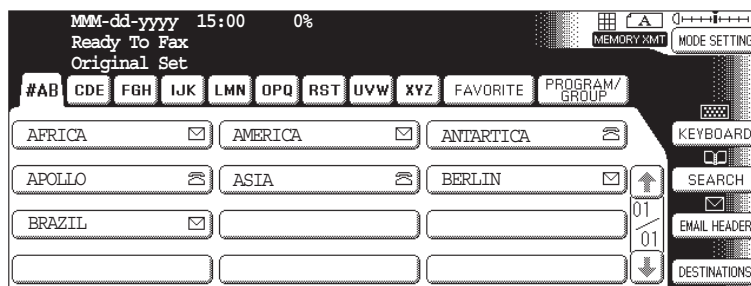

6

Dial by any combination of the following methods:

- Manual Number Dialing, press **OK** after each station is entered (Up to 70 stations)
- Address Book Dialing (Up to 200 stations)  
(For details, see page 22.)

Ex: **PANASONIC**

7

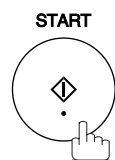

If your machine's Transmission Password coincides with the other station's Transmission Password, your machine starts sending the document.  
When transmission is completed, PASSWORD-XMT returns to standard setting ("OFF", or "ON").

## Using Password Reception

There is no additional operation required once you set the parameter by following the procedure on page 79. The parameter, "OFF", or "ON", cannot be selected for each reception. It is always "OFF", or "ON" until you change the setting.

# Receive To Memory

## Setting the RCV To Memory Password

This feature is used to secure all received documents by storing them into memory. To print the document(s) received in memory, the authorized operator must enter the correct password.

1

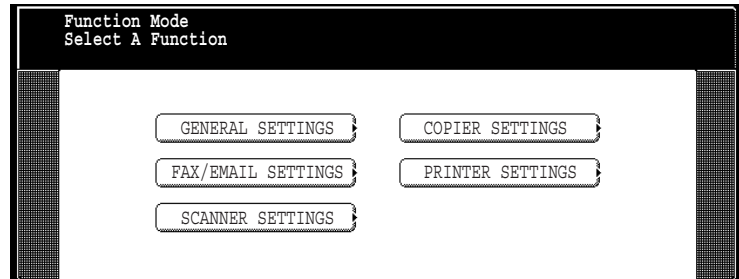

2

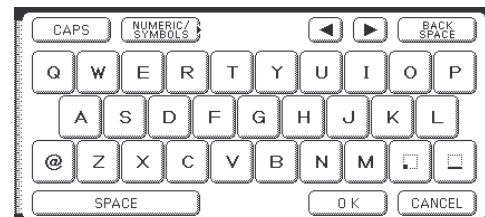
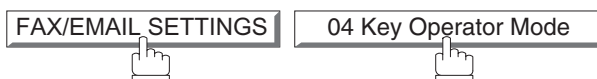

3

Input Key Operator's password, and press **OK**.  
(8 digits: alpha-numeric; alphabet (case-sensitive), numbers, symbols (@,.,\_, and SPACE))

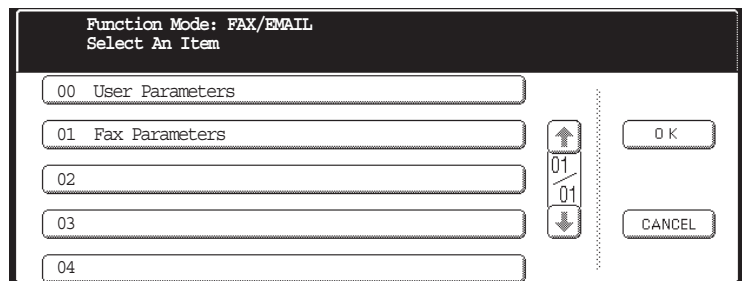

4

Press **01 Fax Parameters** or to scroll the display to the desired Fax Parameter. (See page 190)



or

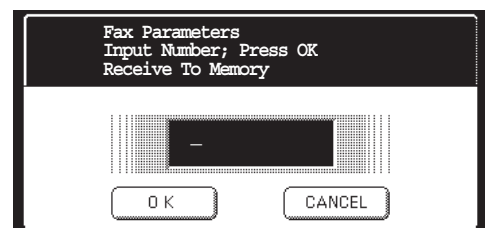

Press **01 Fax Parameters** and enter the Fax Parameter number directly from the keypad, and press **SET** or **START** key.

5

Enter a 4-digit RCV to Memory Password, and then press **OK**.

Ex: ① ② ③ ④ and press **OK**

6



# Receive To Memory

## Setting RCV To Memory

Make sure that the FAX/EMAIL lamp is ON. If not, press  to select the "FAX/EMAIL" mode.

1 

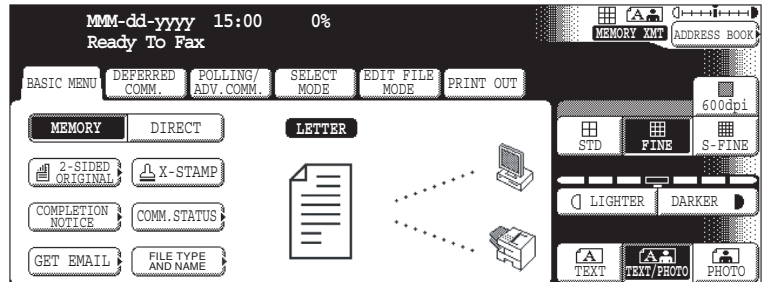

2  

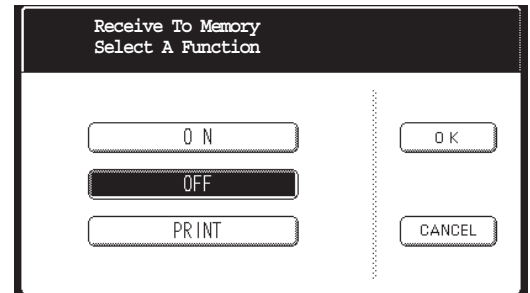

3 

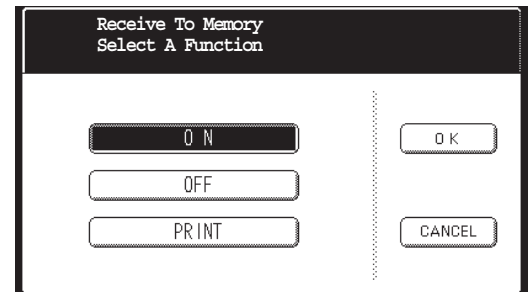

4 

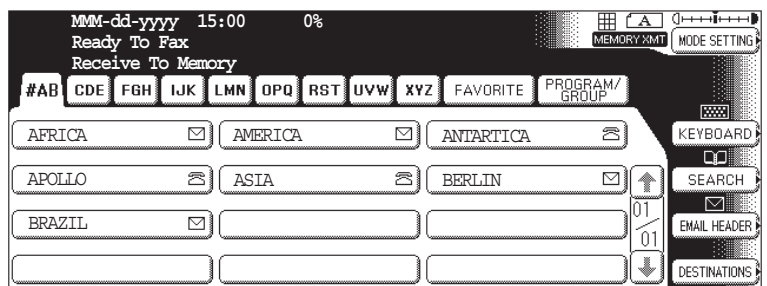

### NOTE

1. When the memory overflows, the machine will stop receiving, and release the line. The machine will not answer the next incoming call until there is space available in memory.
2. We recommend that optional flash memory card is installed when this function is used. See page 223 on Image Memory Capacity.



## Printing Documents

After receiving documents with the Receive To Memory feature, the following message will appear on the display.

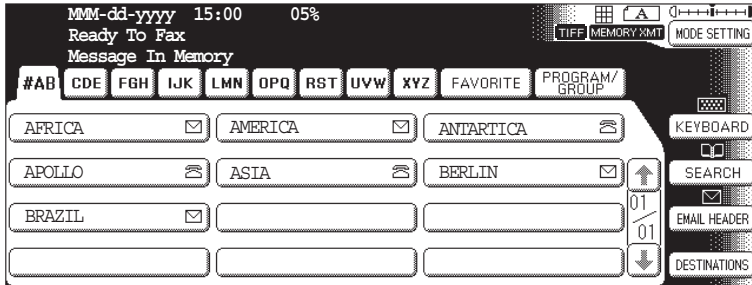

To print the document(s), follow the steps below.

Make sure that the FAX/EMAIL lamp is ON. If not, press  to select the "FAX/EMAIL" mode.

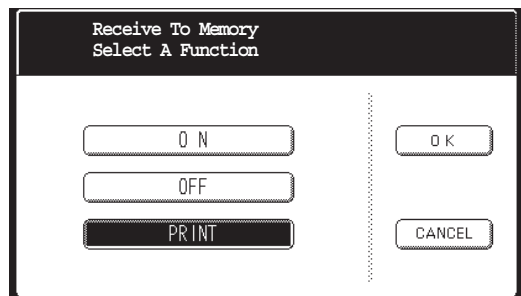
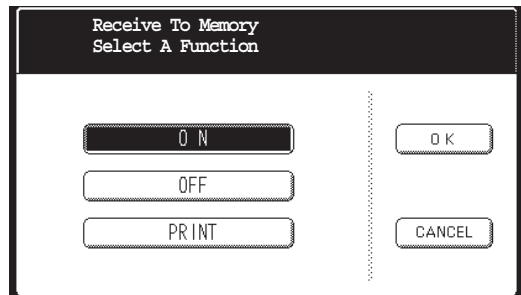
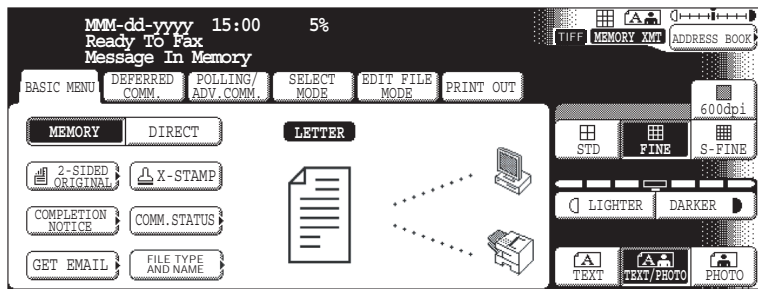
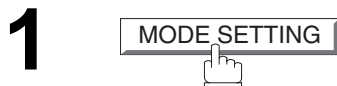

Continued on the next page...

## Receive To Memory

### Printing Documents

- 5** Enter the password to print the document(s), and then press .  
(See Note 1)  
**Ex:** ① ② ③ ④ and press
- 6** Machine will start to print the document(s).

#### NOTE

1. *If the password has not been set, your machine will not prompt you to enter the password. The document(s) will be printed immediately after pressing  in Step 4.*
2. *Once the RCV TO MEMORY feature is set to "ON", the password cannot be changed (Fax Parameter No. 037 will not be selectable on the LCD display). If you wish to change the password, set the RCV TO MEMORY feature to "OFF" first. Then change the password. (See page 84)*

# PIN Code Access

## Selecting the Access Method (Prefix or Suffix)

If your PBX requires a PIN (Personal Identification Number) code to get an outside line, your machine can be set to prompt the user to enter a PIN code before any dialing.

1

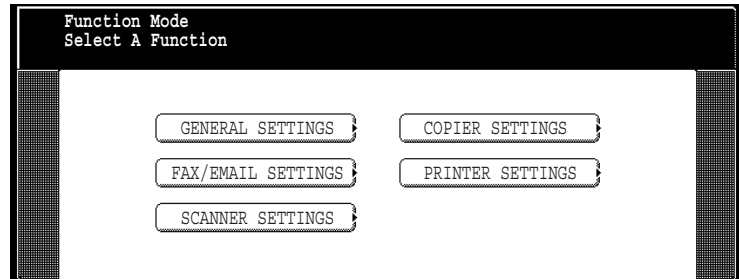

2

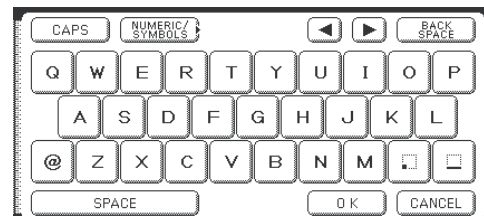

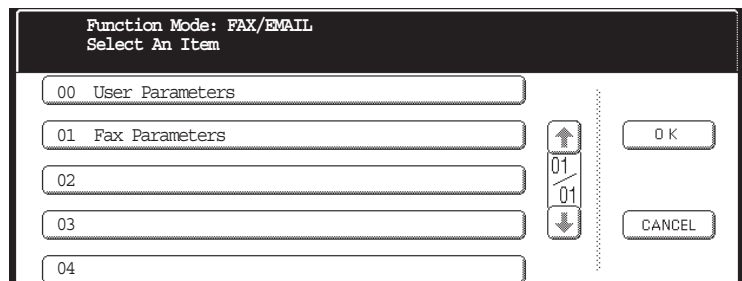

3

Input Key Operator's password, and press **OK**.  
(8 digits: alpha-numeric; alphabet (case-sensitive), numbers, symbols (@,.,\_, and SPACE)).



4

Press **01 Fax Parameters**  or  to scroll the display to the desired Fax Parameter. (See page 190)



or

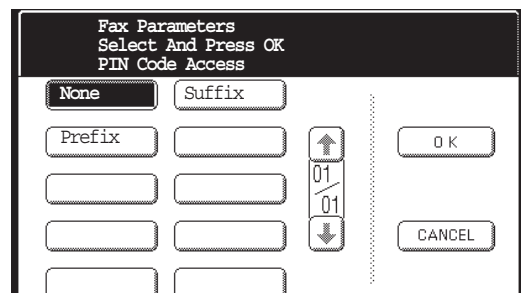



Press **01 Fax Parameters** and enter the Fax Parameter number directly from the keypad, and press **SET** or **START** key.

Continued on the next page...

# PIN Code Access

## Selecting the Access Method (Prefix or Suffix)

**5**  for suffix code.  
or  
 for prefix code.

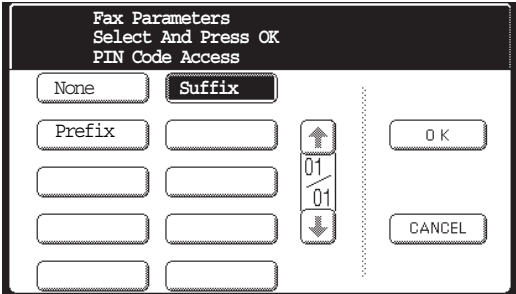

**6**  

## Dialing with a PIN Code

Make sure that the FAX/EMAIL lamp is ON. If not, press  to select the "FAX/EMAIL" mode.



Place original(s) face up on the ADF.  
or



Place a book, or an original face down on the Platen Glass.

**2** Dial by any combination of the following methods:

- Manual Number Dialing, press **OK** after each station is entered (Up to 70 stations)
- Address Book Dialing (Up to 200 stations)

Ex: **PANASONIC**

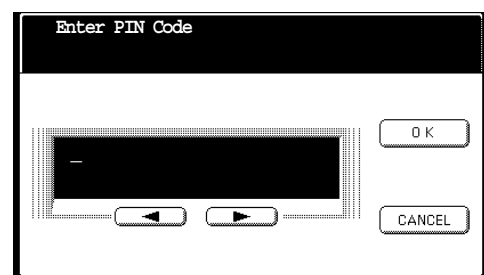
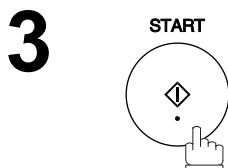
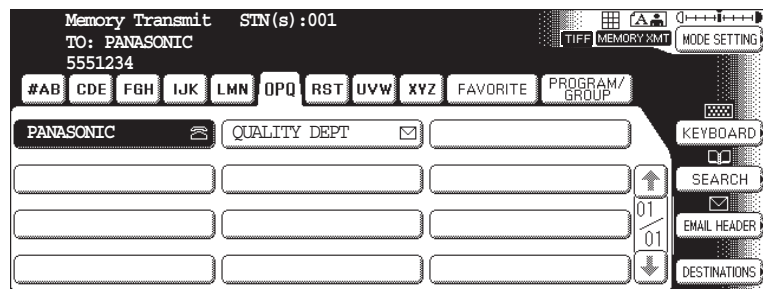

**4** Ex: **9 8 7 6** (Up to 36 digits)

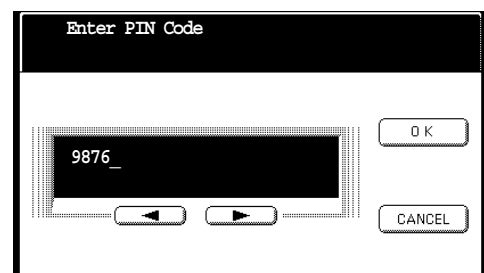

# PIN Code Access

## Dialing with a PIN Code

# 5

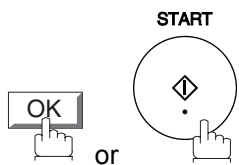

Your machine stores the document, and starts dialing the PIN code, and telephone number as you specified.

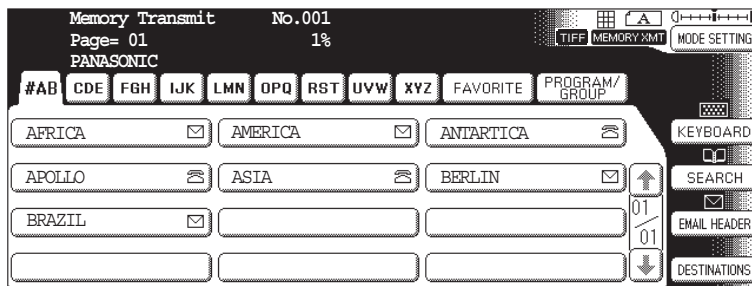

### NOTE

1. The PIN code is shown as " \* " on the display when dialing the number.
2. This feature is not available when dialing a number by using Off-Hook, or On-Hook Direct Dialing mode.

# Selective Reception

## General Description

Your machine has a special feature, Selective Reception, which can prevent the receiving of unnecessary documents (**Ex:** junk fax, direct mail, etc.).

Before receiving the document, the last 4 digits of the ID Number received from the sending machine will be compared with the last 4 digits of the telephone number programmed in each Address Book station. When a match is found, your machine will start receiving the document. If a match is not found, your machine will cancel the reception, and an Information Code 406 will be recorded on the Journal.

## Setting the Selective Reception

1

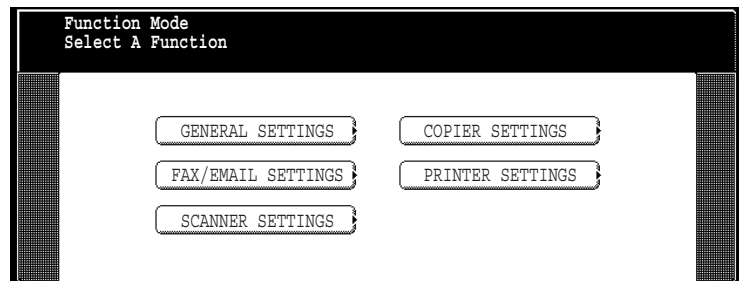

2

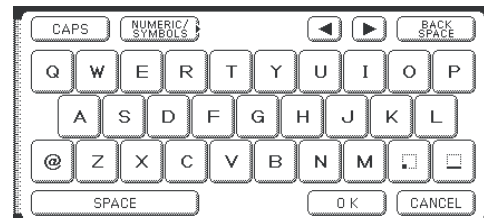

3

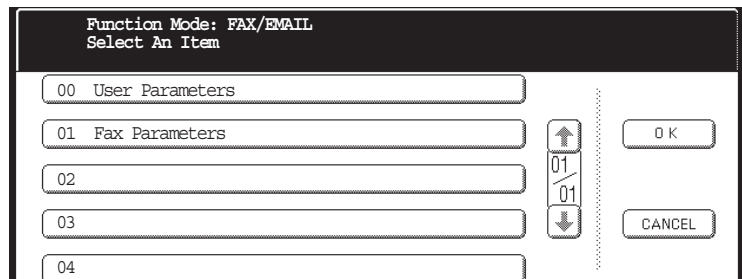

Input Key Operator's password, and press **OK**.  
(8 digits: alpha-numeric; alphabet (case-sensitive), numbers, symbols (@,.,\_, and SPACE))



Continued on the next page...

# Selective Reception

## Setting the Selective Reception

**4** Press **01 Fax Parameters**  or  to scroll the display to the desired Fax Parameter. (See page 190)



or

Press **01 Fax Parameters** and enter the Fax Parameter number directly from the keypad, and press **SET** or **START** key.

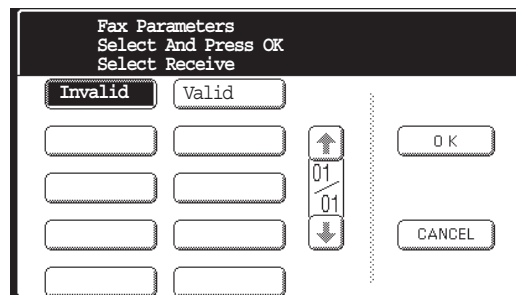

**5** 

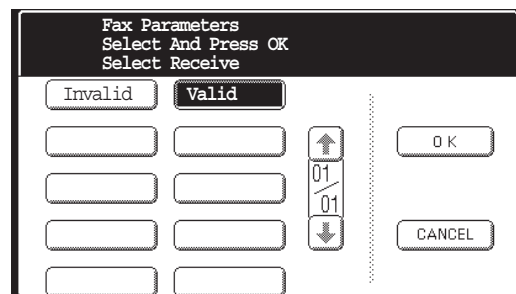

**6** 

### NOTE

1. When the Selective Reception is set, your machine can receive only from those stations which are programmed in the built-in Address Book.
2. If your ID number has not been set, your machine might not be able to receive from some models. To set your ID number, see page 179.



# Department Code

## General Description

This operation requires the user to input a preset Department Code (8-digit maximum) before transmission. The Department Name of the selected Department Code is printed on the Header of each page sent, COMM. Journal, and Individual Transmission Journal.

When the Department Code is set, the Transaction Journal will be sorted by the Department Code number (001 - 300) when it is printed. For details on how to setup the Department Codes, refer to Operator Instructions (for Copier).

If you wish to use the Department Code function, please ask your authorized Panasonic dealer to activate this feature.

## Activating the Department Code Feature

1

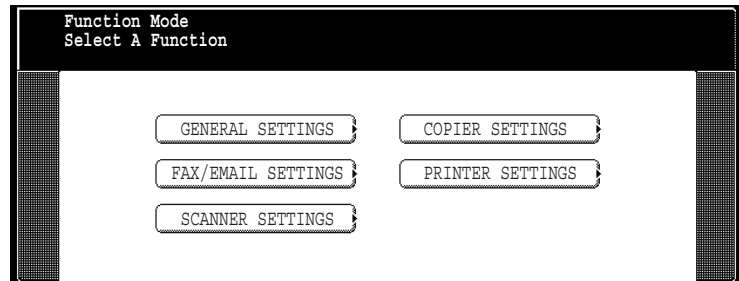

2

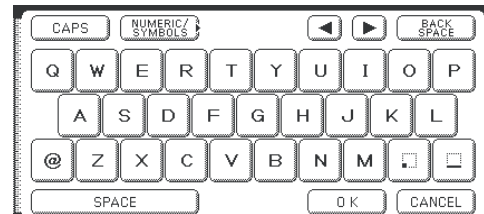
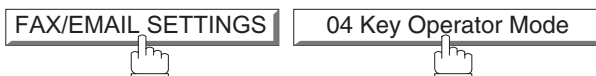

3

Input Key Operator's password, and press **OK**.  
(8 digits: alpha-numeric; alphabet (case-sensitive), numbers, symbols  
(@,.,\_, and SPACE))

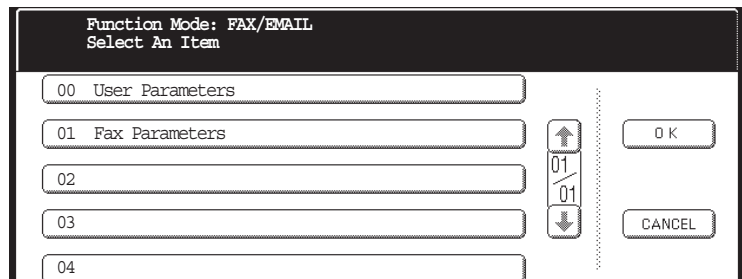

Continued on the next page...

# Department Code

## Activating the Department Code Feature

**4** Press **[01 Fax Parameters]**, and use **[↑]** or **[↓]** to scroll the display to the desired Fax Parameter. (See page 190)



or

Press **[01 Fax Parameters]** and enter the Fax Parameter number directly from the keypad, and press **[SET]** or **[START]** key.

**5**

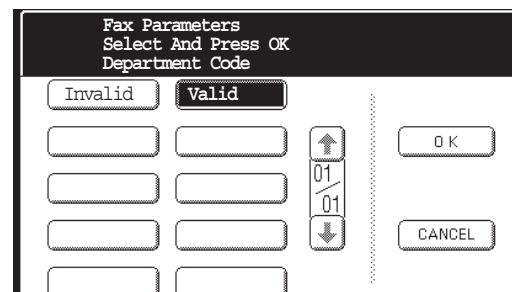
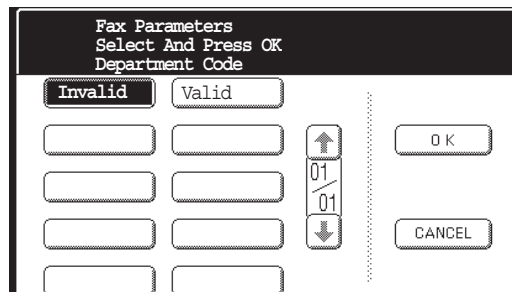
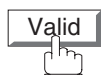

**6**

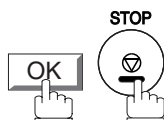

## Sending Document with Department Code

Make sure that the FAX/EMAIL lamp is ON. If not, press  to select the "FAX/EMAIL" mode.



Place original(s) face up on the ADF.  
or



Place a book, or an original face down on the Platen Glass.

**2** Enter a Identification Code (Department Code), and press **OK**.

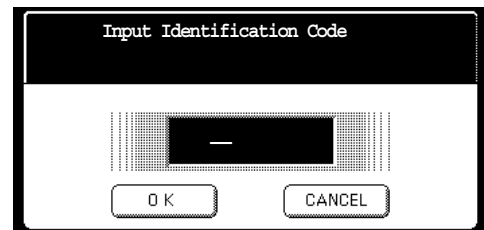

**3** Dial by any combination of the following methods:

- Manual Number Dialing, press **OK** after each station is entered (Up to 70 stations)
- Address Book Dialing (Up to 200 stations)

Ex: **PANASONIC**

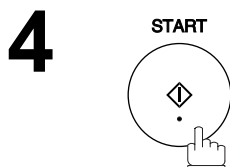
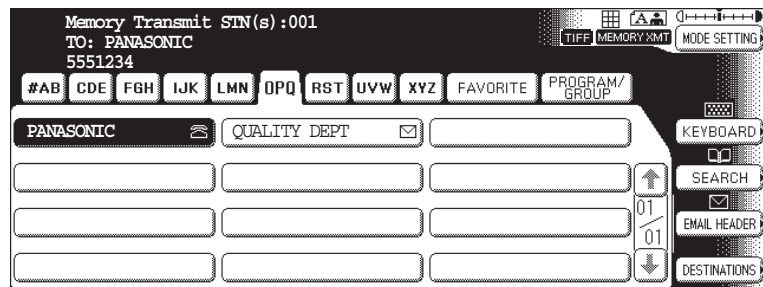

**5** The document is sent with the header of the selected Department Name. The selected Department Name is printed on the COMM. Journal, and Individual Transmission Journal.

# Department Code

## Printing a Department Code Journal

When the Department Code is set, the Transaction Journal will be sorted by the Department Code number when it is printed. All contents of the Journal will be erased automatically after being printed.

Make sure that the FAX/EMAIL lamp is ON. If not, press  to select the "FAX/EMAIL" mode.

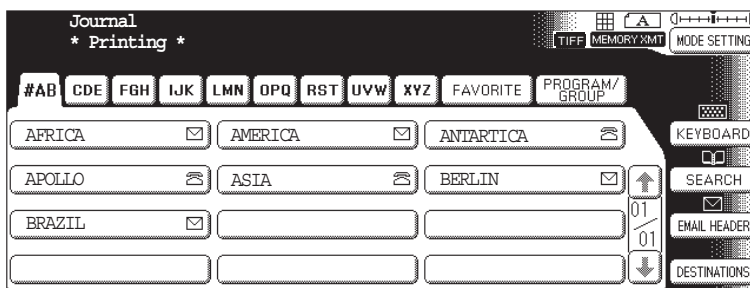
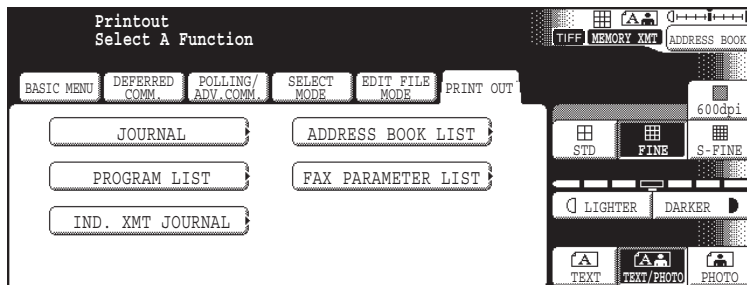

## Printing a Department Code Journal

### Sample Department Code Journal / Originated Calls

```
***** -Dept Code Journal- ***** DATE MMM-dd-yyyy ***** TIME 15:00 *** P.01

ORIGINATED CALLS
MMM-dd TO MMM-dd (1)
(2) (3)
TOTAL PAGES = 000038 TOTAL TIME = 00:23:56

(4) (5)
01: Panafax Sales
-----
NO. COMM. PAGES FILE DURATION X/R IDENTIFICATION DATE TIME DIAGNOSTIC

01 OK 005 00:05:13 XMT ☎ 5551234 MMM-dd 15:10 C0044903C0000
21 OK 021/021 019 00:10:15 FWD FAX FORWARD MMM-dd 18:10 C0044903C0000
(6) (7)
TOTAL PAGES = 000026 TOTAL TIME = 00:15:28

02: Panafax Service
-----
NO. COMM. PAGES FILE DURATION X/R IDENTIFICATION DATE TIME DIAGNOSTIC

19 OK 001/001 017 00:00:13 XMT ☎ 5551234 MMM-dd 10:10 C0044903C0000
30 OK 011/011 045 00:08:15 XMT SERVICE DEPT. MMM-dd 13:10 C0044903C0000

TOTAL PAGES = 000012 TOTAL TIME = 00:08:28

-PANASONIC -
***** DP-xxxx ***** -HEAD OFFICE - ***** - 201 555 1212 - *****
```

### Sample Department Code Journal / Received Calls

```
***** -Dept Code Journal- ***** DATE MMM-dd-yyyy ***** TIME 15:00 *** P.02

RECEIVED CALLS
AUG-15 TO AUG-15 (1)
(2) (3)
TOTAL PAGES = 000011 TOTAL TIME = 00:13:41

NO. COMM. PAGES FILE DURATION X/R IDENTIFICATION DATE TIME DIAGNOSTIC

55 OK 005 00:05:13 RCV 4445678 MMM-dd 12:10 C0044903C0000
56 OK 005/005 020 00:08:15 PLD 111 222 333 MMM-dd 19:15 C0044903C0000

70 OK 001 017 00:00:13 RCV 44567345 MMM-dd 10:10 C0044903C0000

-PANASONIC -
***** DP-xxxx ***** -HEAD OFFICE - ***** - 201 555 1212 - *****
```

### Explanation of Contents

- (1) Period date of this journal
- (2) Number of total pages transmitted/received for this machine.
- (3) Total transmitted/received time for this machine.
- (4) Department Code Number 01-300
- (5) Department Name
- (6) Number of total pages transmitted/received for this department.
- (7) Total transmitted/received time for this department.

# Edit File Mode

## General Description

Your machine has a document image memory which enables you to reserve memory transmission, memory deferred transmission, memory polling, and so on.

After reserving the communications in memory, you may need to change the settings of the communication(s) while it is still in memory. This section describes how to use the file editing features.

## Printing or Viewing a File List

The contents of the communication settings may have to be modified, or deleted. To verify the contents, follow the steps below to print out a file list.

Make sure that the FAX/EMAIL lamp is ON. If not, press  to select the "FAX/EMAIL" mode.

**1**  

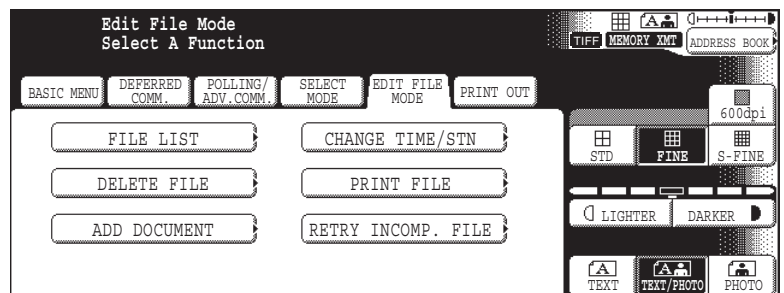

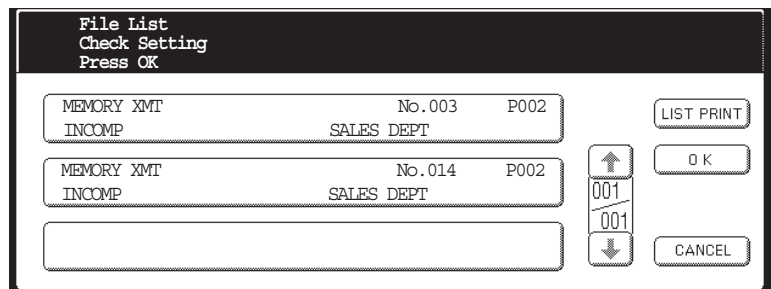

**2** 

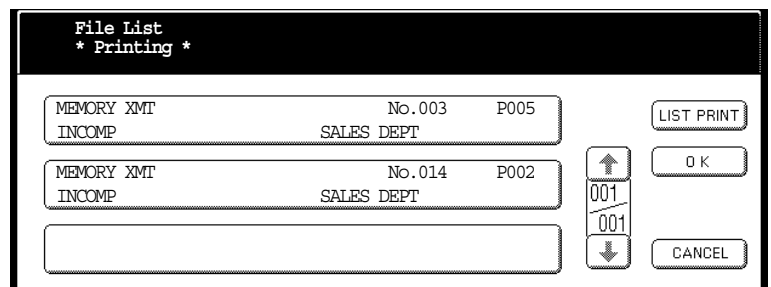

**3a** To print the File List. 



**3b** To view the File List.  or  repeatedly until the display shows the file you want to view.

**4** 

## Printing or Viewing a File List

### Sample File List

```

***** -FILE LIST- ***** DATE MMM-dd-yyyy ***** TIME 15:00 *****
(1)  (2)      (3)      (4)      (5)  (6)
FILE COMM. TYPE  CREATED TIME  START TIME  PAGES DESTINATION(S)
No.
001  DEFERRED XMT  MMM-dd 13:20  20:30      [PANAFAX]
002  MEM. DEF. XMT  MMM-dd 13:20  22:30      003 [SALES DEPT] [TOKYO]
                                           -PANASONIC
***** DP-xxxx ***** -HEAD OFFICE - ***** - 201 555 1212- *****
    
```

### Explanation of Contents

- |                              |  |
|------------------------------|--|
| (1) File number              | If the file is now being executed, a "*" is indicated on the left of the file number.  |
| (2) Communication type       |  |
| (3) Stored date/time         | Date/time that these files were stored.  |
| (4) Executing time           | If the file is a Timer Controlled Communication, the start time is printed in this column.<br>If the file is an incomplete file, "INCOMP" is printed in this column. |
| (5) Number of stored page(s) |  |
| (6) Destination              | Key name(s) / Manual dialing location(s).  |

# Edit File Mode

## Changing the Start Time or the Station of a File

To change the start time, and/or stations in a communication file, follow the steps below.

Make sure that the FAX/EMAIL lamp is ON. If not, press  to select the "FAX/EMAIL" mode.

**1**  

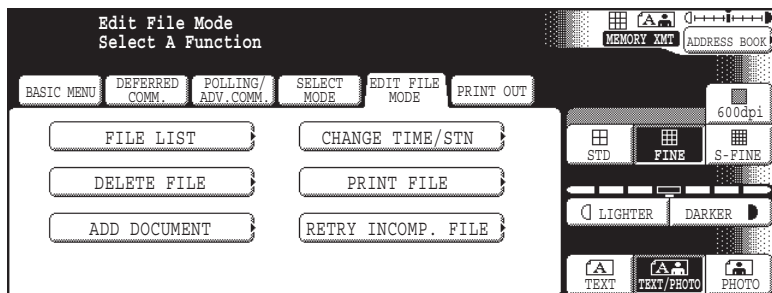

**2** 

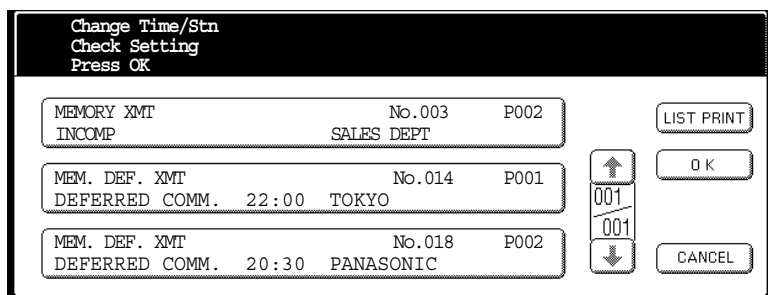

**3** Select the file that you want to change, and press **OK**.  
• Enter the new start time by over writing the current start time.

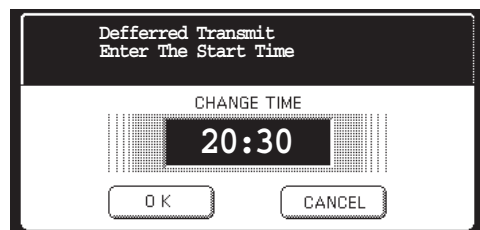

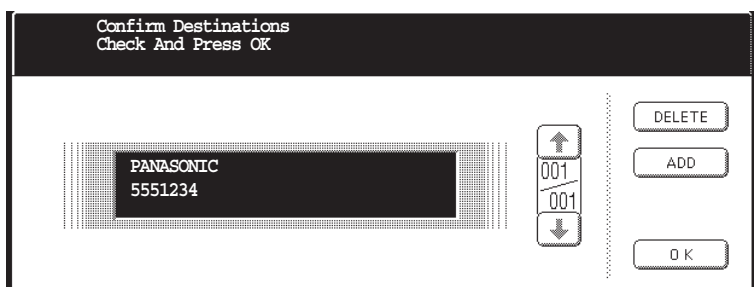

**4** Enter a new start time, and press **OK**.





### Changing the Start Time or the Station of a File

- 5** To delete the station(s), press  or  key until the station you want to delete appears. Then press **DELETE**.
- or
- To add additional station(s), press **ADD** and select the station(s) that you want to add from the Address Book.

- 6** When finished, press

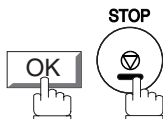

# Edit File Mode

## Deleting a File

To delete the file in memory, follow the steps below.

Make sure that the FAX/EMAIL lamp is ON. If not, press  to select the "FAX/EMAIL" mode.

1

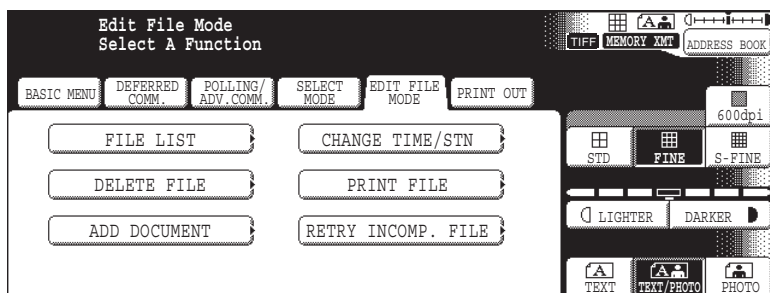

2

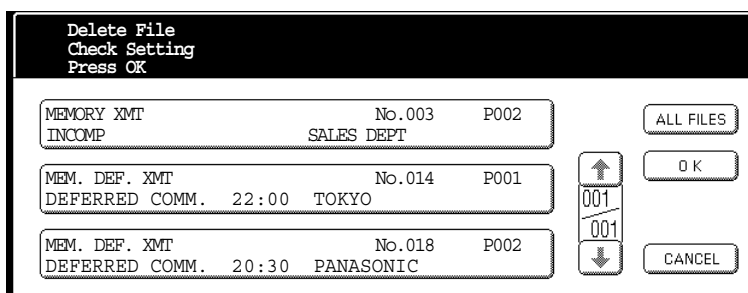

3

Select the file that you want to delete, and press **OK**.

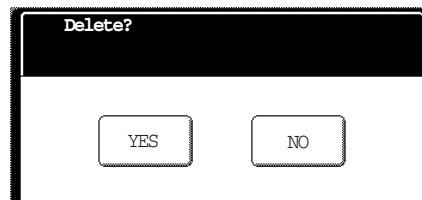

4

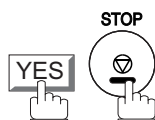

### NOTE

1. Your machine cannot delete the file while it is being sent.
2. If you want to delete all files in Step 3, press **ALL FILES** with no file selected (except the file in progress).  
The following message is shown on the display.

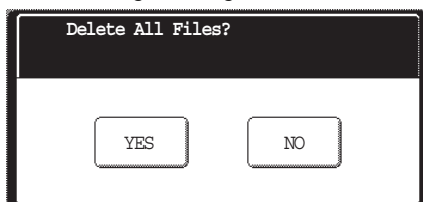

Press **YES** to delete all files.

## Printing Out a File

To print the contents of the communication file, follow the steps below.

Make sure that the FAX/EMAIL lamp is ON. If not, press  to select the "FAX/EMAIL" mode.

1

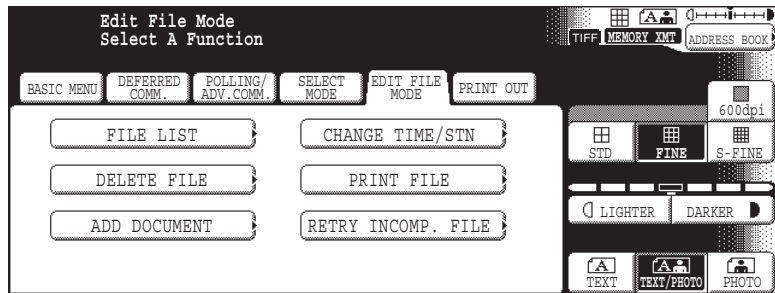

2

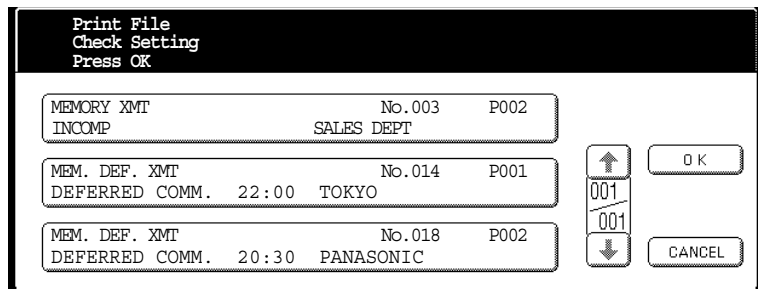

3

Select the file that you want to print, and press **OK**.

4

Your machine will print the file. The document(s) will remain in memory even after printing the file.

### NOTE

1. Your machine cannot print the file while it is being sent.

# Edit File Mode

## Adding Documents into a File

To add documents into the file, follow the steps bellow.

Make sure that the FAX/EMAIL lamp is ON. If not, press  to select the "FAX/EMAIL" mode.



Place original(s) face up on the ADF.  
or



Place a book, or an original face down on the Platen Glass.

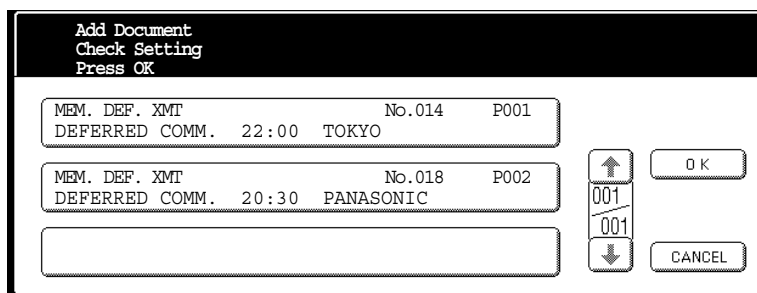
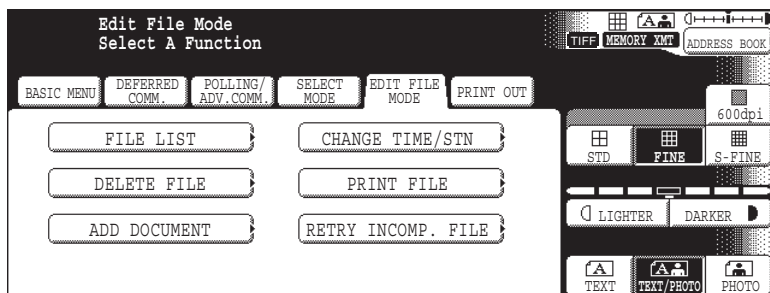

**4** Select the file that you want to add document(s) to, and press **OK**.

**5** Your machine will start storing the document(s) into a file.

### NOTE

1. Your machine cannot add the document into the file while it is being sent, or waiting to redial.

## Retry an Incomplete File

If a memory communication has been unsuccessful due to a busy line, or no answer, the document you stored is automatically erased from memory after the last redial.

If you need to retain the document even if the communication failed, change the setting of Fax Parameter No. 031 (INC. FILE SAVE) to Valid in advance. (See page 191)

To retry the incomplete file, print a File List first to verify the file number. (See page 103)  
Then, follow the steps below.

Make sure that the FAX/EMAIL lamp is ON. If not, press  to select the "FAX/EMAIL" mode.

**1**  

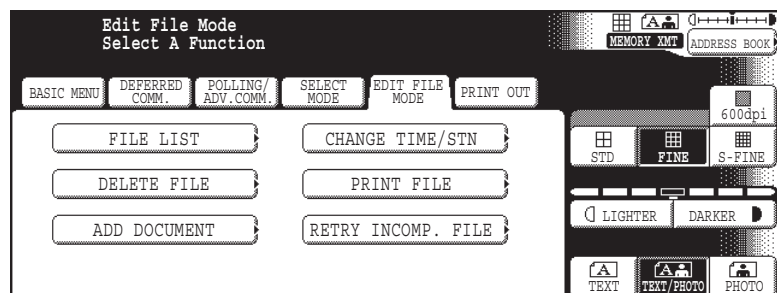

**2** 

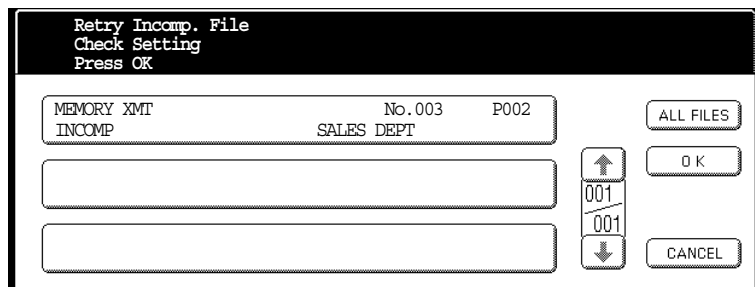

**3** Select the file that you want to retry.

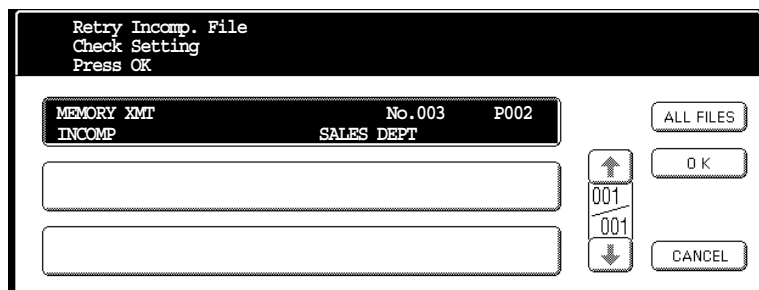

**4** 

Your machine will retry the file, and start dialing immediately.

### NOTE

- To confirm, or change the entered telephone number for the file, see pages 98, and 100.
- If you set Fax Parameter No.031 to Valid, all incomplete files will remain in the memory. To avoid memory overflow, please check the memory content frequently. We recommend that optional flash memory card is installed when this function is used. (See page 223)
- If you want to retry files in Step 3, press **ALL FILES** with no file selected (except the file in progress). The following message is shown on the display. **YES** to retry all files. **NO** to Cancel.

memo

# Pre Installation Information

## Internet Fax Features

Before setting up your Panasonic machine on your network, please read this entire section to be familiar with its functions.

Your machine is able to perform the following when connected to a 10Base-T/100Base-TX Ethernet LAN (local area network):

- Send paper-based information as an Internet Email.
- Send Internet fax message (Direct Internet Fax XMT).
- Receive, and print an Internet Email automatically.
- Forward received G3 fax message, or Email automatically to the preprogrammed Email address, or regular G3 fax machine (see "Fax Forward" on page 155).
- Route received G3 fax message automatically to the sender-specified Email address, or G3 fax machine using ITU-T SUB-Address (see "Inbound Routing" on page 151).
- Route received G3 fax messages automatically to the preprogrammed Email address, or G3 fax machine using the sender's fax ID code (see "Inbound Routing" on page 151).
- Relay an Internet Email to a G3 fax machine via regular fax transmission (see "Relayed Transmission" on page 160).
- Scan to Email.

To utilize the above functions, your machine needs to be set up properly on your network. **Please contact your network administrator for actual network setup.**

Copy the Pre-installation Information form found at the end of this section on page 110, record the MAC Address on the form, and ask your network administrator to complete the remaining information on the form. The MAC Address of your machine can be found on the 2nd page of the General Settings List printout. To print the General Settings List, follow the steps below:

Press    , Input Key Operator's password,    .

Your machine can be set up as either **SMTP Mail Server**, or **POP3 Client**. Depending on the type of setup, different functions are available as follows.

Function	SMTP Server Setup	POP3 Client Setup
Sending paper-based information as an Internet Email	Yes	Yes
Sending, and Receiving the Internet fax message with Direct SMTP protocol.	Yes	No
Receive, and print an Internet Email automatically	Yes	Yes
Receive, and print an Internet Email manually	No	Yes
Forward received G3 fax message, or Email automatically	Yes	Yes
Route received G3 fax message automatically	Yes	Yes
Relay an Internet Email to G3 fax machine	Yes	No

### NOTE

1. To function as SMTP mail server, your machine's email address must include its unique Host name within your company domain. This unique Host name must be registered within your network's DNS (Domain Name System) server. **Ex:** Internet\_Fax@fax01.panasonic.com
2. Automatically refers to immediate SMTP transfer, or immediate POP3 retrieval. Manually refers to manual retrieval of mail when configured as POP3 client.
3. If you are using DHCP to acquire the network parameters, contact your Network Administrator to reserve the obtained IP Address printed on the Fax Parameter List.
4. Your machine will receive, print, forward, or relay emails in text message format, and TIFF-F image file attachment only.

## Pre Installation Information

### Setup as SMTP Mail Server

To install your machine as SMTP Mail Server, the following network parameters need to be programmed on your network, and on your machine.

- TCP/IP Address of your machine
- TCP/IP Subnet Mask of your machine
- TCP/IP Address of the Default Gateway
- Host Name
- TCP/IP Address of the DNS Server (if not available, see Note 2)
- Email Address of your machine (See Note 1)
- Name, or IP Address of the Default SMTP mail server
- SMTP Authentication Name (when the authentication with the SMTP server is required)
- SMTP Authentication Password (when the authentication with the SMTP server is required)

#### Email (from your machine to a PC) and Direct Internet Fax XMT Transmission

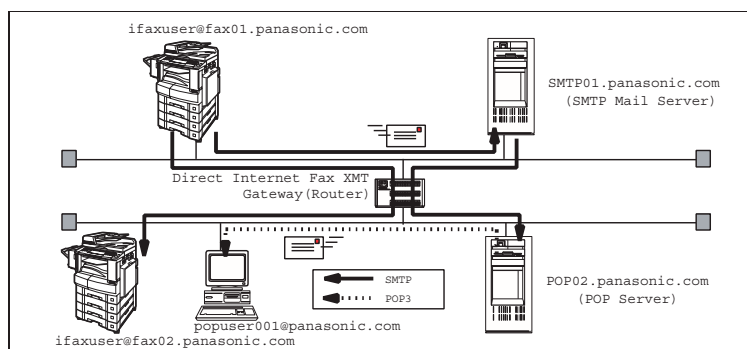

#### Email (from a PC to your machine) and Direct Internet Fax XMT Reception

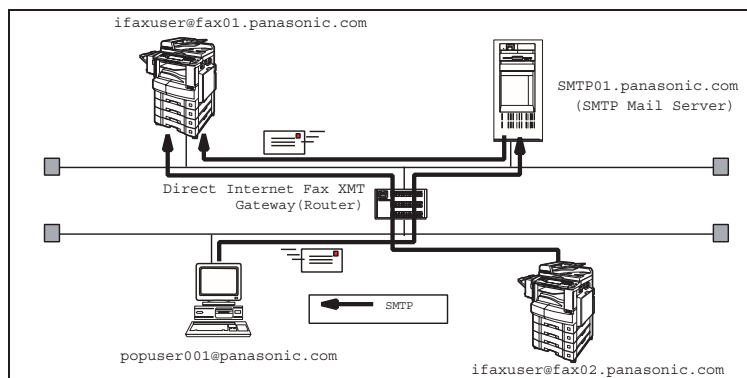

#### NOTE

1. To function as SMTP mail server, your machine's email address must include its unique Host name within your company domain. This unique Host name must be registered within your network's DNS (Domain Name System) server. **Ex:** Internet\_Fax@fax01.panasonic.com
2. By default the machine requires the IP Address of the DNS Server, and prompts you to enter the SMTP Server Name.

If the DNS Server is not available, change the 27(DNS Server Address) of General Settings to "No".

Press **FUNCTION** **GENERAL SETTINGS** **09 Key Operator Mode** , Input Key Operator's password, **OK** **27 DNS Server Address** .



## Setup as POP3 Client

To install your machine as POP3 Client, the following network parameters need to be programmed on your network.

- TCP/IP Address of your machine
- TCP/IP Subnet Mask of your machine
- TCP/IP Address of the Default Gateway
- TCP/IP Address of the DNS Server (if not available, see Note 2)
- Email Address of your machine (See Note 1)
- Name or IP Address of the Default SMTP mail server
- POP Server Name or IP Address
- POP User Account Name
- POP Password

### Email Transmission (from your machine to a PC)

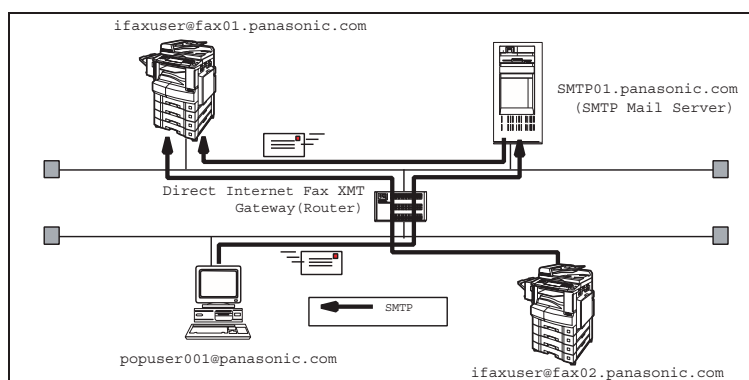

### Email reception (from a PC to your machine)

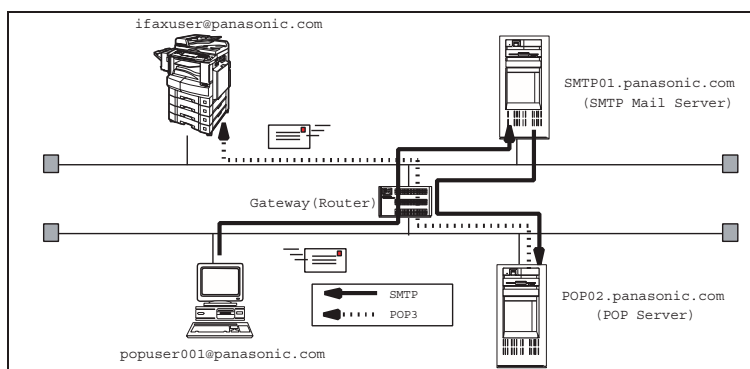

### NOTE

1. The email address format can be the same as your regular email address. If your email address is `popuser001@panasonic.com`, your machine's email address can be `Internet_Fax@panasonic.com`.
2. By default the machine requires the IP Address of the DNS Server, and prompts you to enter the SMTP, and POP Server Names. If the DNS Server is not available, change the 27(DNS Server Address) of General Settings to "No".

Press **FUNCTION** **GENERAL SETTINGS** **09** Key Operator Mode , Input Key Operator's password, **OK** **27** DNS Server Address .

# Pre Installation Information

For the total system to work properly via LAN, certain information, and additional parameters must be set. Please contact your network administrator for the required information, and connection to the LAN.

**Important:** Make a copy of this page, and ask the Network Administrator to complete the required information. After its returned, transfer the information to the back side of the front cover for future reference, and troubleshooting.

User Information		
Company Name		
Address		
Dept.		
City	State	Zip Code
Tel. No.	Fax No.	
Internet Parameters (See page 122)		
(1) IP Address:		
(2) Subnet Mask:		
(3) Default Gateway IP Address:		
(4) Primary DNS IP Address:		
(5) Secondary DNS IP Address:		
(6) Email Address:		
(7) SMTP Server Name :	or	*SMTP Server IP Address:
(8) SMTP Auth Name :		
(9) SMTP Auth Password :		
(10) POP Server Name:	or	*POP Server IP Address:
(11) POP User Name:		
(12) POP Password:		
(13) LDAP Server Name:	or	LDAP Server IP Address
(14) LDAP User Name:		
(15) LDAP Password:		
(16) LDAP Search Base:		
(17) Host Name:		
(18) Default Subject:		
(19) Default Domain:		
(20) Selectable Domains:		
1.		6.
2.		7.
3.		8.
4.		9.
5.		10.
(21) Remote Password:		
(22) Relay XMT Password:		
(23) Manager's Email Address:		
(24) Insert Email Text:		
(25) Relay Domains (Domains Authorized for Relay Transmission):		
1.		6.
2.		7.
3.		8.
4.		9.
5.		10.
(26) Community Name (1):		
(27) Community Name (2):		
(28) Device Name:		
(29) Device Location:		

## NOTE

- Items in Bold, depict information obtained from you Network Administrator.
- By default the machine requires the IP Address of the DNS Server, and prompts you to enter the SMTP, and POP Server Names (items 7, and 10 above).  
If the DNS Server is not available, change the 27(DNS Server Address) of General Settings to "No".  
Press **FUNCTION** **GENERAL SETTINGS** **09 Key Operator Mode** , Input Key Operator's password, **OK** **27 DNS Server Address** .  
Then the machine will prompt you to enter the IP Address of the SMTP, and POP Servers.
- If required, the MAC Address of your machine can be obtained from the 2nd page of the General Settings List printout, by pressing  
Press **FUNCTION** **GENERAL SETTINGS** **09 Key Operator Mode** , Input Key Operator's password, **OK** **00 Print General Settings** **Start** **OK** .

# Pre Installation Information

## Explanation of Contents

- MAC Address : MAC Address from the 2nd page of the General Settings List printout  
Press **FUNCTION** **GENERAL SETTINGS**  
: **09 Key Operator Mode** , Key Operator's password, **OK**  
**00 Print General Settings** **Start** **OK**.
- (1) IP Address : The Internet Protocol (IP) Address assigned to your machine.  
(2) Subnet Mask : The Subnet Mask number.  
(3) Default Gateway IP Address : The Default Gateway's IP Address.  
(4) Primary DNS Server IP Address : The IP address of the Primary DNS Server.  
(5) Secondary DNS Server IP Address : The second IP address of the Primary DNS Server.  
(6) Email Address : The email address assigned to your machine. (Up to 60 characters)  
(7) SMTP Server Name or SMTP Server IP Address : The SMTP Server Name (Up to 60 characters). The SMTP Server IP Address.  
(8) SMTP Auth Name : The SMTP Auth Name.  
(9) SMTP Auth Password : The SMTP Auth Password. (Up to 30 characters)  
(10) POP Server Name or POP Server IP Address : The POP Server Name (Up to 60 characters). The POP Server IP Address.  
(11) POP User Name : POP User Name. (Up to 40 characters)  
(12) POP Password : POP Password. (Up to 30 characters)  
(13) LDAP Server Name or LDAP Server IP Address : The LDAP Server Name or IP Address. (Up to 60 characters)  
(14) LDAP User Name : LDAP Login Name. (Up to 60 characters)  
(15) LDAP Password : LDAP Password. (Up to 30 characters)  
(16) LDAP Search Base : LDAP Search Base. (Up to 60 characters)  
(17) Host Name : The name assigned to your machine. (Up to 60 characters)  
(18) Default Subject : The information to be added to the Subject Line for all outgoing emails. (Up to 40 characters)  
(19) Default Domain : Specify the Domain Name (Up to 50 characters) to be added to frequently used, or incomplete outgoing email addresses (**Ex:** @yourcompany.com).  
(20) Selectable Domains : Enter up to 10 Domain Names that can be selected during manual email addressing. (Up to 30 characters)  
(21) Remote Password : Enter a security password (Up to 10 characters) to allow Remote Programming of the Internet Parameters, and Auto Dialer, or the retrieval of the Journal via email.  
(22) Relay XMT Password : Enter a password to provide network security to your Relay Station (for G3 relay purposes). (Up to 10 characters)  
(23) Manager's Email Address : Enter you Department Manager's email address for notification of all Internet relayed transmissions for supervision, and cost control purposes. (Up to 60 characters)  
(24) Insert Email Text : The email text can be changed. Requires an authorized service provider to activate this feature. (Up to 40 characters)  
(25) Relay Domain (01 to 10) : Enter up to 10 Domain Names that are authorized to access your Internet Relay Domain, a.k.a. Domain Name in your machine. (Up to 30 characters)  
(26) Community Name (1) : Community Name used for the Network Device Locator. (Up to 32 characters).  
(27) Community Name (2) : Community Name used for the Network Device Locator. (Up to 32 characters).  
(28) Device Name : Device Name used for the Network Device Locator. (Up to 32 characters).  
(29) Device Location : Device Location for the Network Device Locator. (Up to 32 characters).

# Internet Communication Features

## Internet Fax Transmission

Your machine allows you to transmit documents over the Internet to another Internet Fax, or a PC. The document is first scanned, and converted into a TIFF-F, or PDF\* file, and then transmitted to the remote location as an attachment file to an email using MIME encoding.

**Note:** PDF file is only available if sending the document(s) to a PC.

The email system at the receiving end must support MIME. Otherwise, the attachment file will be detached, and lost.

When you send an email message to someone, your machine uses Simple Mail Transfer Protocol (SMTP) to transfer your outgoing mail to your SMTP mail server, which in turn uses SMTP to send your mail to the Internet.

## Internet Fax Delivery Notice (MDN)

If the sender (Internet Fax) desires a processing confirmation, it must request a Message Disposition Notification when sending the message itself to a device supporting this notification function.

Several email applications such as Eudora, and Outlook Express support, and are able to respond to the delivery confirmation notification sent from the Internet Fax. As well as send a request for notification to the Internet Fax by email applications that support MDN (Message Disposition Notification) function.

For additional details on MDN, consult a suitable reference such as the Help file, and the User's guide of each respective email application.

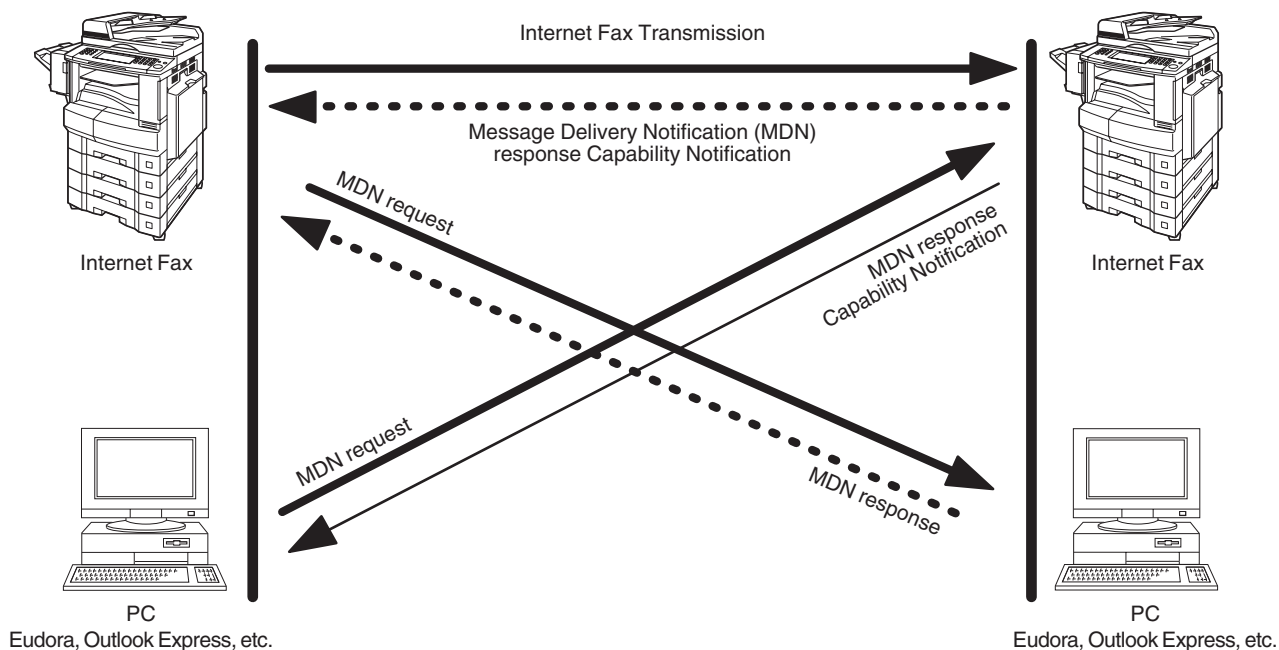

Eudora is a registered trademark of QUALCOMM Incorporated.

Legend :

- : MDN Request from the Originator
- : MDN Response with Capability Notification from the Receptient
- : MDN Response from the Recipient

## Direct Internet Fax XMT

Direct Internet FAX XMT uses Simple Mail Transfer Protocol (SMTP) to transfer mail reliably, and efficiently. An important feature of SMTP is its capability to transport mail across networks, usually referred to as SMTP mail relay by employing SMTP server.

Direct Internet FAX XMT allows you to transmit documents to another Internet Fax directly without using an SMTP server. For this feature to work reliably, the IP Address should remain unchanged (ask your Network Administrator to reserve the IP Address). The Domain Name of the machines, and other record information must be properly registered in the DNS server.

Further more, in common cases only email, and web service from the Internet are permitted into the corporate intranet, and corporate network administrators are extremely unwilling to open the firewall for other, incoming services, since each opened path represents additional, potential security threats.

This makes Direct Internet FAX XMT attractive because it can operate throughout the organization's Intranet.

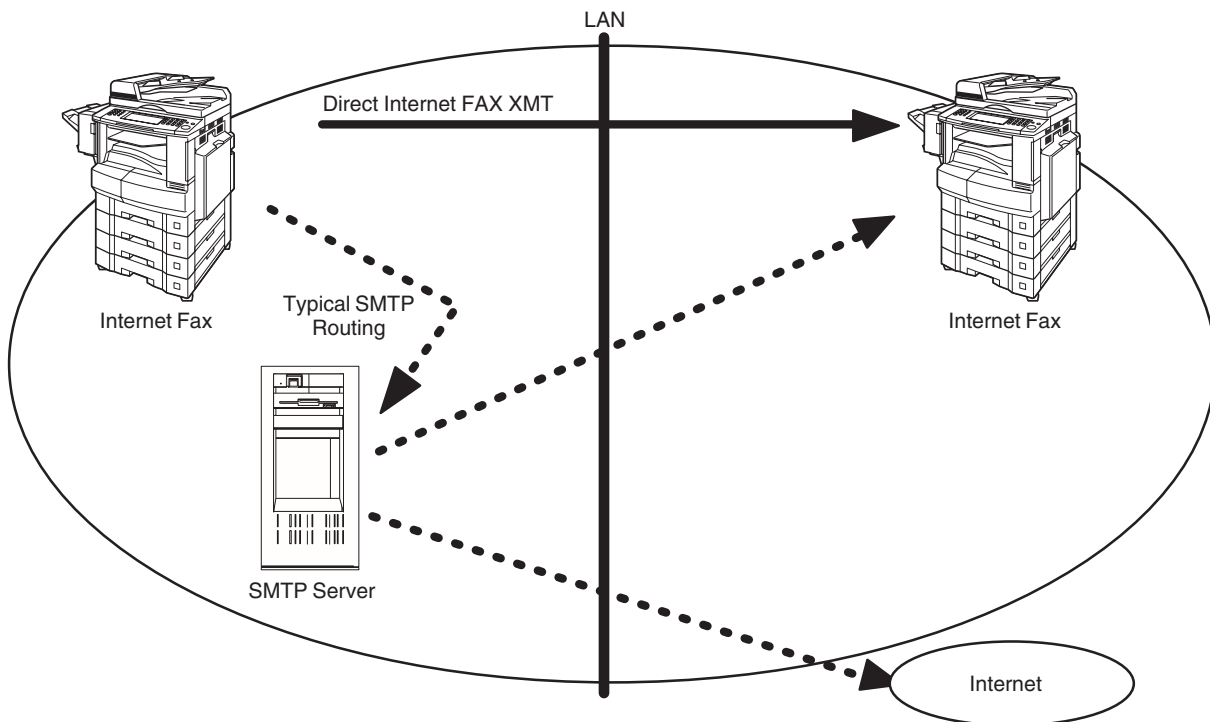

# Internet Communication Features

## Internet Mail Reception

Your machine allows you to receive, and print a PC transmitted email automatically, or manually, depending on its setup configuration. However, if the received email includes a file attachment in a format other than TIFF-F, such as PDF, Word, Excel, Power Point, your machine prints an error message instead.

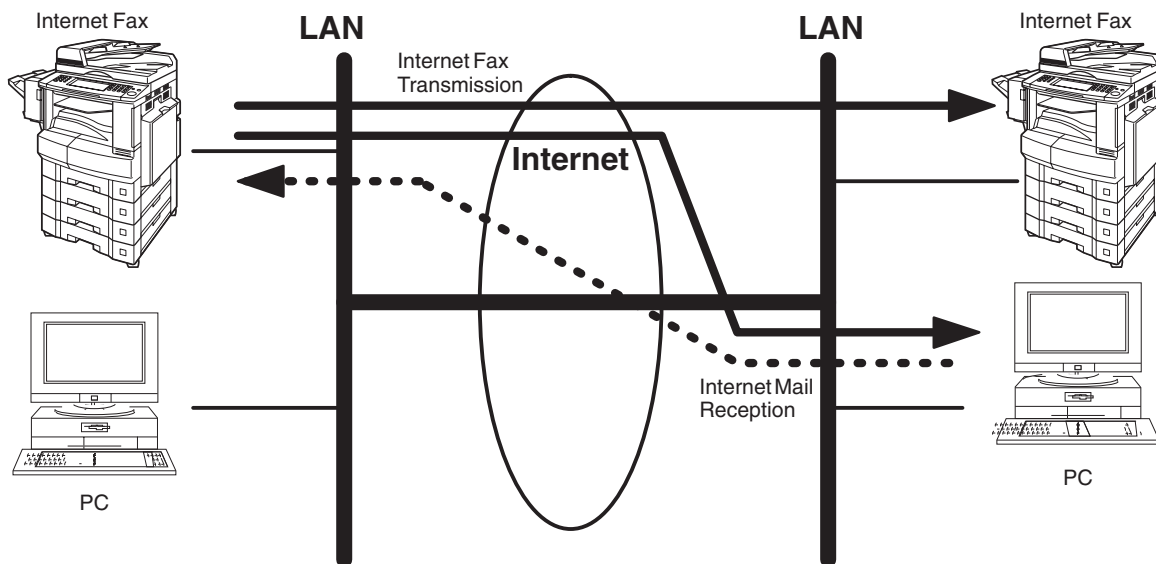

## Inbound Routing

Using the Inbound Routing feature, your machine can route documents received from a G3 fax machine to email address(s), or to Internet Fax machine(s) connected to a LAN as an email, as well as to other G3 fax machine(s) over the telephone line.

**When an incoming Internet Fax, Email, or a regular Fax document is received, your machine checks for the following:**

1. First, your machine checks whether a sub-address is included. If it is, it will look for a sub-address match within its auto dialer, and will route the documents to the corresponding stations email address(s), and/or telephone number(s).
2. If no sub-address is specified, then your machine tries to match the originating fax machine's Numeric ID (TSI) with the TSI routing within its auto dialer, and will route the documents to the corresponding stations email address(s), and/or telephone number(s).

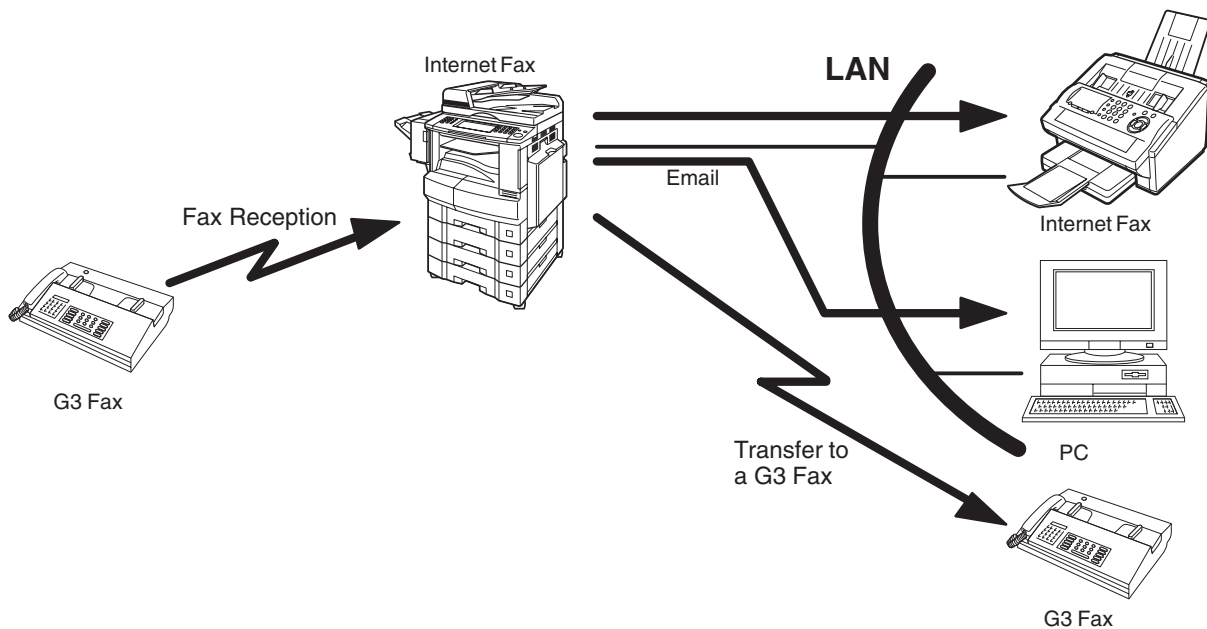

### NOTE

1. If the originating fax machine does not support the above sub-address function, sub-address destination(s) cannot be selected.
2. Your machine will allow you to register the same sub-address number for an email address, and a telephone number.

# Internet Communication Features

## Fax Forward

Your machine is capable of transferring all received Internet email, or regular G3 fax documents to a pre-programmed G3 fax, or a PC destination.

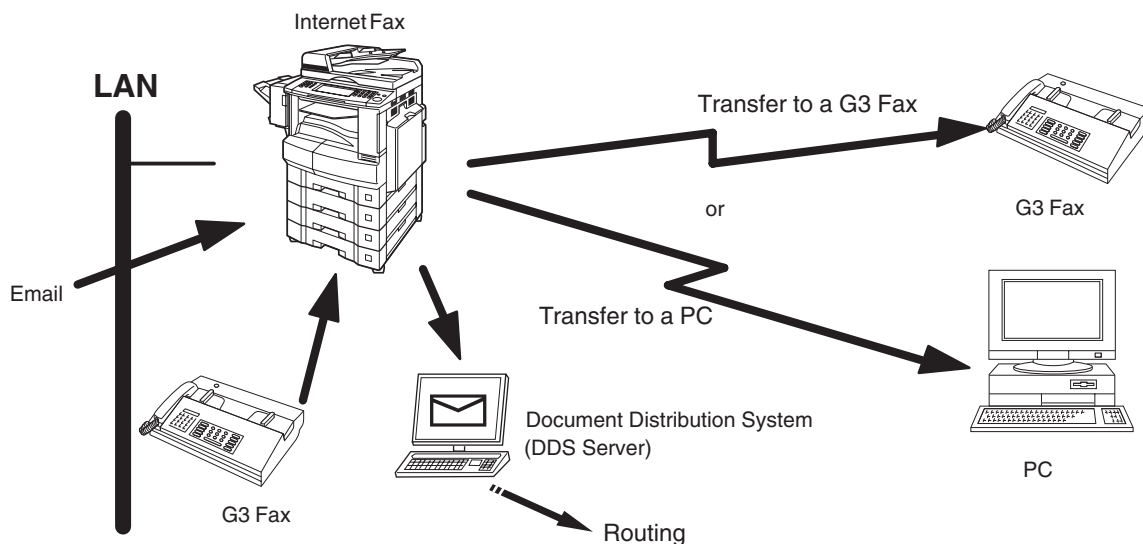

## Dynamic Host Configuration Protocol (DHCP)

DHCP is a protocol for dynamically assigning IP addresses to Internet Fax, and client PCs. With DHCP, an Internet Fax can automatically acquire a unique IP address each time it connects to a network making IP address management an easier task for network administrators. When an Internet Fax logs on to the network, the DHCP server selects an IP address from a master list, and assigns it to the system.

If you wish to enable the following options on your Internet Fax, a static (reserved by a Network Administrator) IP address, and configurations must be used instead of the DHCP operation.

- SMTP Receiving
- G3 Gateway
- Direct Internet Fax XMT

## SMTP Authentication

The Internet's emergence as a worldwide digital infrastructure has dramatically encouraged a market for communications-oriented appliances. However, the no object security technique has gained widespread, and dominant use over the Internet due to several reasons.

1. Internet mail is a multi-hop store, and forward architecture, and use of channel-based security is generally difficult.
2. No single technique is recommended by the Internet Fax standard.

To improve, and robust the system, Authentication through encryption based techniques are provided as a typical solution. The techniques may be associated with the transmission channel, such as by using Simple Authentication, and Security layer (SASL).

Some Internet Service Providers (ISP) take advantage of Internet mail service by providing an Authentication feature.

Your Internet Fax provides the following three Authentication options.

1. SMTP Service Extension for Authentication (SMTP AUTH) -- while sending
2. Lightweight challenge-response mechanism POP (APOP) -- while receiving
3. POP before SMTP -- performs POP procedure prior to every SMTP transaction



## Lightweight Directory Access Protocol (LDAP)

For convenience, your Internet Fax has an LDAP client feature to enable the search for recipient's email addresses from the LDAP server, which assists the entering of long email addresses.

The Lightweight Directory Access Protocol (LDAP) is a protocol for accessing online directory services. An LDAP client connects to an LDAP server, and asks a question. The server responds with an answer.

Your Internet Fax indicates the search result from the LDAP server on the LCD display. This enables you to easily choose the recipients you wish to send to, and saves you time from entering long, and intricate email addresses.

## Relayed Transmission

Your machine allows you to transmit an email received from an Internet Fax, or PC connected to the LAN to multiple fax machines via a telephone line. You can attach files with the TIFF-F format to this email.

Using the Sub-address specified by the originating fax machine, your machine can then route the received documents to the remote machine via an email, which can then relay these documents to final destinations where the final recipient is a regular G3 fax machine.

Your machine also allows you to convert a data file from various application programs such as spreadsheet into a TIFF-F format file, and then transmit this file attached to an email.

To convert applications into a TIFF-F formatted file, however, requires you to first download the software (printer driver) from the web site listed below. The second part requires you to install the software on your PC.

(See the web site for details about the printer driver installation, and operation.)

You can download the Panasonic's printer driver from any of the following URL addresses:

<http://panasonic.co.jp/pcc/en/>

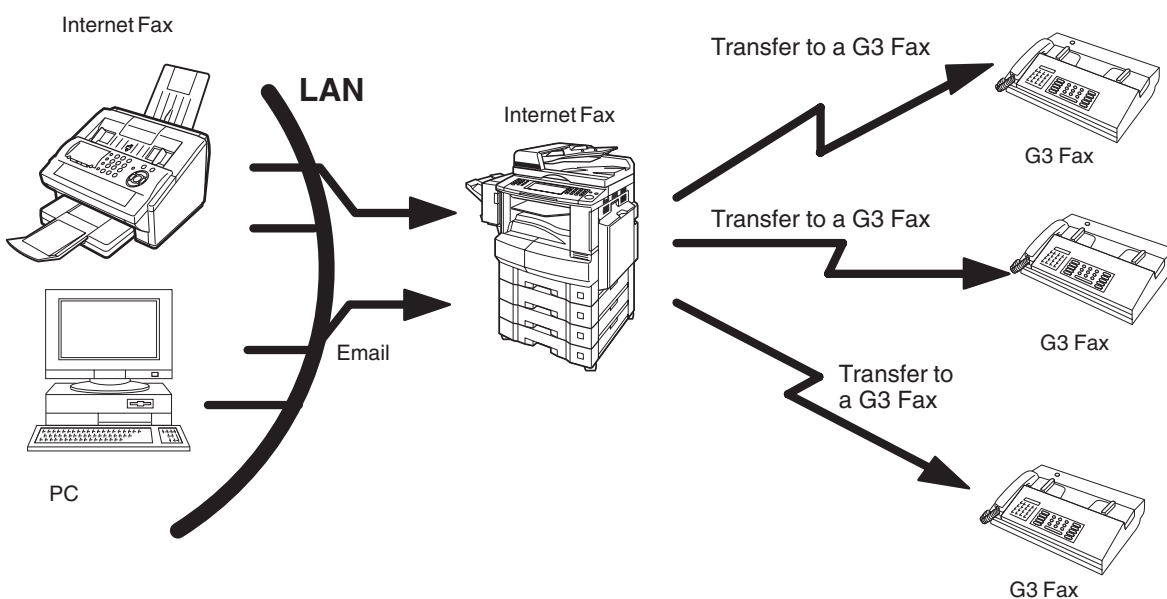

# Important Information

Your machine uses the same communication protocols as email: the Simple Mail Transfer Protocol (SMTP). The differences from a standard G3 fax communication using the Public Telephone Network (PSTN) are as follows.

## Differences between Internet Fax and Regular Fax

A regular Fax machine goes off-hook, dials, and the phone network completes a circuit over phone lines to the receiving fax. You pay for the circuit. The two faxes negotiate a connection, synchronize, and exchange image data.

The Internet Fax works like an email, the image data is broken down into packets, and transmitted through your Local Area Network (LAN) to the Internet, or Intranet instead of using a telephone company's network, thus saving you long distance costs.

## Transmitted Document Confirmation

1. Your machine does not directly connect to the final destination (See Note below), but rather connects to a Mail Server via LAN. Therefore, if a document cannot be correctly transmitted due to an error, the erroneous mail may be returned from the Mail Server to your machine.
2. The erroneous mail may take a long time to return (20 to 30 minutes) depending on the destination location, traffic on the network, or LAN system configuration.
3. Depending on the Mail Server, it is also possible that erroneous mail is not returned at all. Therefore, when transmitting important, or time sensitive documents, it is recommended that you follow up with a telephone call to confirm reception.
4. Documents cannot be transmitted correctly if the destination Mail Server does not conform to the MIME protocol. Erroneous mail may not be returned depending on the Mail Server.

### Note:

- 1) Fax Parameter 172 (DIRECT Internet Fax XMT), if set to "Valid," allows you to configure Address Book so that you can directly send to the destination without medium of SMTP.
- 2) Your machine supports the Delivery Notice feature (See page 195).

## Your machine Cannot Make a Phone Call via LAN

Your machine can only make a phone call using a regular telephone line (PSTN).

## Dual Port Communication

Your machine's dual port capability, allows simultaneous G3 Fax Communication over regular telephone line (PSTN), and LAN Communication.

## Transmission Resolution

In view of PC transmission, the factory default setting for the resolution is set to FINE mode. If required, this setting can be changed to Normal.

## Internet Mail Reception

1. Your machine can receive text email from a PC, and print ANSI characters. It will print a "■" symbol if an unrecognized character is received.
2. Received email font, and character size are fixed, and cannot be changed.
3. Text email will be printed at about 72 lines per page. It is recommended that you use A4/Letter size recording paper.
4. If the received text email includes a file attachment in a format other than TIFF-F, such as PDF, Word, Excel, Power Point, your machine prints an error message instead.
5. If the received email includes attached TIFF-F formatted image files, the text, and TIFF-F formatted image file will be printed on separate pages.

### Sending a Document to a PC via LAN

When transmitting a document to an email address, the following instructions are sent as text message in addition to the TIFF-F formatted image file.

An Image data in TIFF-F format has been attached to this email. You can download the TIFF-F Image Viewer from the following URL addresses:

<http://panasonic.co.jp/pcc/en/>

**Note:** If the document(s) being sent are in the PDF format, the following message is shown instead.

An image data in PDF format has been attached to this email.

### Internet Relayed Transmission

To prevent unauthorized stations from accessing your Relay Station for Internet Relayed Transmission, you must set up your Network security. Enter a Relay Station Name, which is concealed from the final destinations, and a Manager's Email Address for notification of all Internet Relayed Transmissions.

# User Parameters

## Setting the User (Internet) Parameters

See Operating Instructions (For Facsimile) if you wish to set the basic settings (User Parameters). Before starting, you will need a completed copy of page 107 (Pre Installation Information). For your machine to be able to operate as an Internet Fax on the Network properly, the following five (5) Basic Parameters must be pre-programmed into the machine.

- TCP/IP Address of your machine
- TCP/IP Subnet Mask of your machine
- TCP/IP Address of the Default Gateway
- Email Address of your machine
- Name or IP Address of the Default SMTP mail server

1

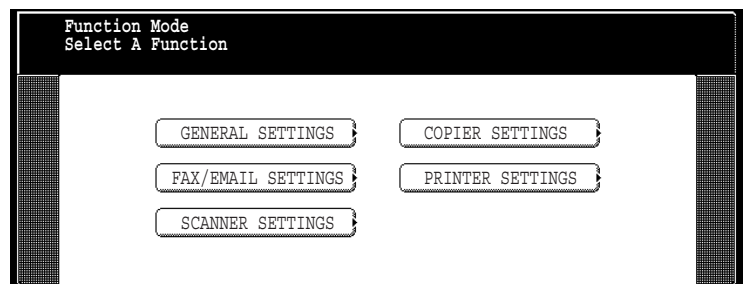

2

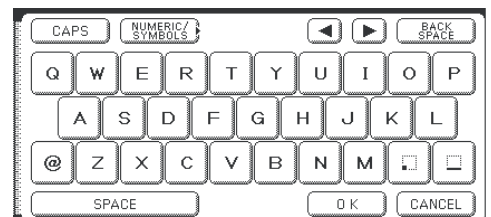

3

Input Key Operator's password, and press **OK**.  
(8 digits: alpha-numeric; alphabet (case-sensitive), numbers, symbols (@,.,,\_, and SPACE))

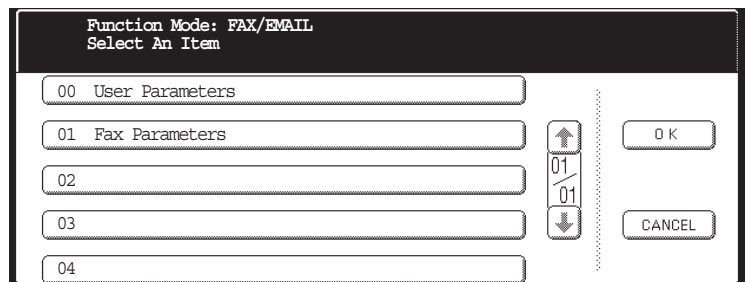

4

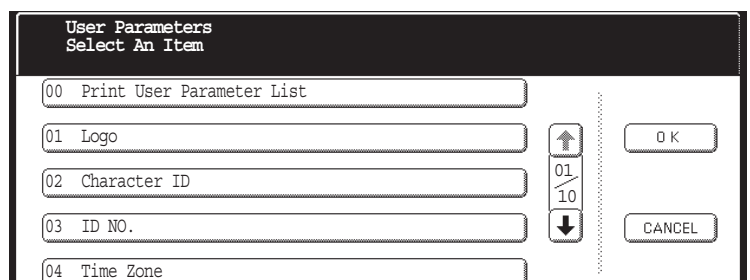

## Setting the User (Internet) Parameters

- 5** Press  or  to scroll the display to the desired User (Internet) Parameters.  
(See page 122)

Ex:

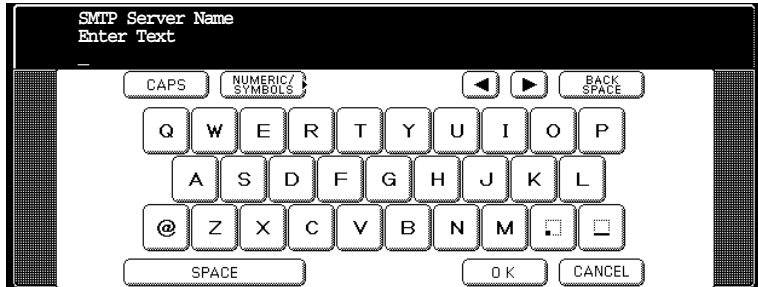

- 6** Enter the SMTP Server Name, and press .  
To advance to the next parameter, press  to return to Step 5, or press  to return to standby.

### NOTE

1. To scroll the display to desired User Parameter in Step 5, press  or .
2. All IP Address fields require an entry. If you wish to leave an IP Address field Blank, or wish to erase one, press  and press .
3. If the DNS Server is not available, change the setting of the 27 (DNS Server Address) of General Settings to "No".

Press   , Input Key Operator's password,  .

# Setting the Internet Parameters

## Setting the User Parameters for the LAN Interface

Depending on how your machine will be configured to communicate on the LAN, the appropriate parameters listed in the table below must be stored first. (See pages 107 to 111)

	Parameter	Comments
01	Logo	Up to 25 characters & digits.
02	Character ID	Up to 16 characters & digits.
03	ID No.	Your Fax Telephone Number. (Up to 20 digits)
04	Time Zone	The Time Zone is required as part of the Email header information when sending Internet faxes.
05	Email Address	The Email Address assigned to your machine for sending, and receiving. (Up to 60 characters)
06	SMTP Server Name	The name of the SMTP Mail Server with Port Number. (Up to 60 characters)
07	SMTP Server IP	IP Address of the SMTP Mail Server with Port Number.
08	SMTP Auth Name	The SMTP Auth Name.
09	SMTP Auth Password	The SMTP Auth Password. (Up to 30 characters)
10	POP Server Name	The name of the POP Mail Server with Port Number. (Up to 60 characters).
11	POP Server IP	IP Address of the POP Mail Server with Port Number.
12	POP User Name	User Name assigned to your machine. (Up to 40 characters)
13	POP Password	Password assigned to your machine. (Up to 30 characters)
15	LDAP Server Name	The name of the LDAP Server with Port Number. (Up to 60 characters)
16	LDAP Server IP	IP Address of the LDAP Server with Port Number.
17	LDAP User Name	Login Name assigned to your machine. (Up to 60 characters)
18	LDAP Password	Password assigned to your machine. (Up to 30 characters)
19	LDAP Search Base	ID for starting the search in the directory on the LDAP Server with Port Number. (Up to 60 characters)
21	Default Subject	The default information to be added to the Subject Line for all outgoing Email (Up to 40 characters).
22	Default Domain	When the outgoing email address is incomplete by SMTP standards, the Frequently Sent Domain specified here will be automatically added to the email address. This feature is also useful as a shortcut when manually entering email addresses to a frequently used Domain. (Up to 50 characters)
25~ 34	Selectable Domains (01) ~ (10)	Enter up to 10 Domain Names that can be selected using the "V or /\ " key during Manual email addressing. (Up to 30 characters)
27	DNS Server Address	Sets the DNS server.
35	Remote Password	This is a security password that allows Remote Programming of the Internet Parameters, and Auto Dialer, or the retrieval of the Journal via an Email. (Up to 10 characters)
36	Relay XMT Password	A password that provides Network security for your Relay Station (used exclusively for G3 relay purposes). (Up to 10 characters)
37	Manager's Email Address	Department Manager's Email Address for notification of all Internet relayed transmissions for supervision, and cost control purposes. (Up to 60 characters)

## Setting the Internet Parameters

### Setting the User Parameters for the LAN Interface

	Parameter	Comments
38	Insert Email Text	The email text can be changed. Requires an authorized service provider to activate this feature. (Up to 40 characters)
40~ 49	Relay Domain (01) ~ (10)	Enter up to 10 Domain Name(s) that have been authorized to access your Internet Fax for Relayed XMT Request. (Up to 30 characters) Relay Domain, a.k.a. Domain Name in your machine.

\* Contact your Network Administrator for this Information.

# Sending Documents via LAN

## Manual Email Addressing

Make sure that the FAX/EMAIL lamp is ON. If not, press  to select the "FAX/EMAIL" mode.



Place original(s) face up on the ADF.  
or



Place a book, or an original face down on the Platen Glass.

**2**

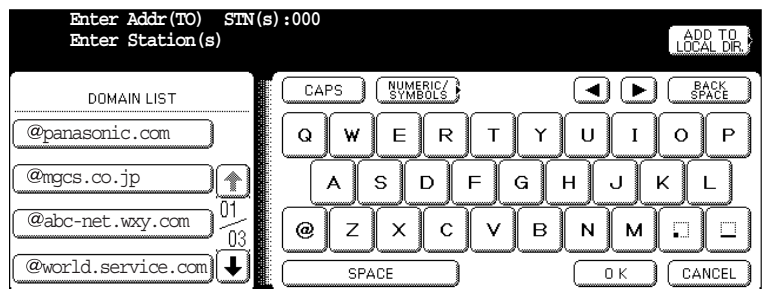
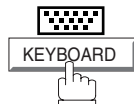

**3a** Enter the full email address using the QWERTY keyboard (Up to 60 characters).

If you make a mistake, press **BACK SPACE** to erase the character then re-enter the correct character.

Ex: abc@panasonic.com

or

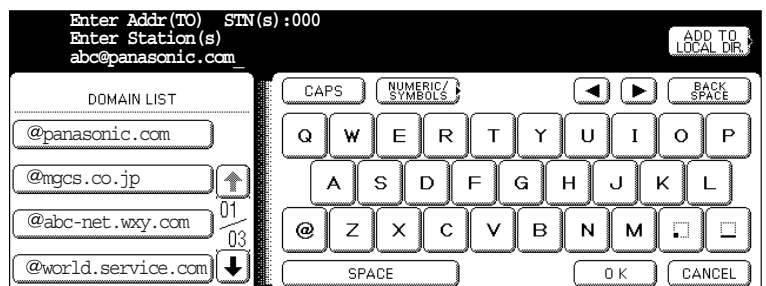

**3b** Enter the User portion of the email address, and press **OK**. The machine will complete the email address with the Default Domain preprogrammed in the User (Internet) Parameters. (Ex: will add "panasonic.com" to the email address)

(See Note 4)

Ex: abc

or

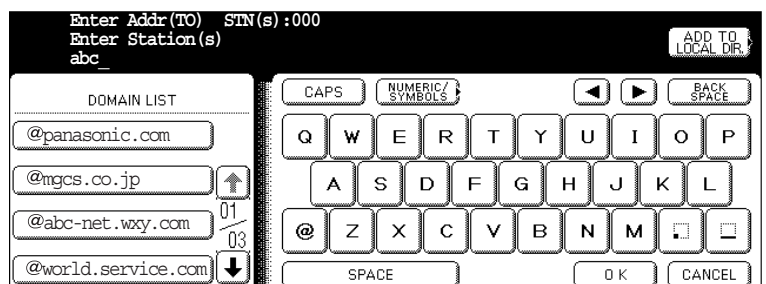



## Manual Email Addressing

**3c** If you want to send to a different Domain, choose the desired domain from Domain List.  
(See Note 4)

Ex: abc @panasonic.com

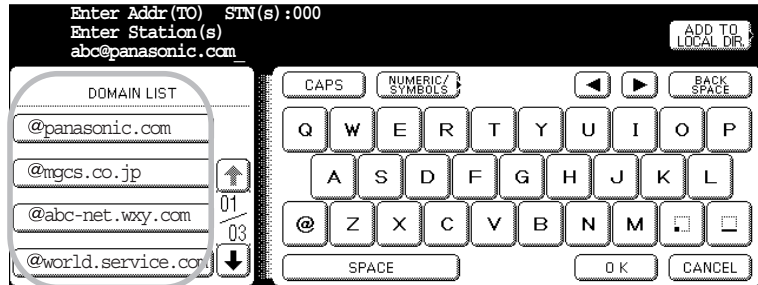

**4** 

You can add up to 70 additional full email addresses.

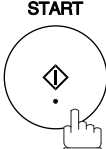
**5** 

The document(s) begin to store into memory with a file number.  
Then starts connecting to the LAN immediately after storing the first page.  
(See Note 5)  
While sending the document(s) via LAN, the remaining page(s) continue to store into memory.

### NOTE

1. If your machine sounds an alarm (pi-pi-pi) when pressing the KEYBOARD Button, or any Address Book entries that contain an email address, one, or more of the required 5 Basic Internet Parameters may have been omitted in the User (Internet) Parameter(s). (See page 122)
2. If you want to specify two, or more destinations, press **OK** after completing the full email address so you can select another destination.
3. If the transmission cannot be completed for any reason, the email may be returned undelivered; otherwise no reply will be printed.
4. For the machine to perform the email address completion the Fax Parameter No. 160 (DEFAULT DOMAIN) must be set to "Valid", and the DEFAULT DOMAIN must be preprogrammed in the User (Internet) Parameters. (See pages 122, and 195)
5. The "QUICK MEMORY TRANSMISSION" feature is disabled if multiple stations are set.

# Sending Documents via LAN

## Address Book Email Addressing

Address Book Addressing allows you to send email(s) by entering the full email address with a single key. To use this method, you must first preprogram the email addresses into the Address Book.

Make sure that the FAX/EMAIL lamp is ON. If not, press  to select the "FAX/EMAIL" mode.



Place original(s) face up on the ADF.  
or

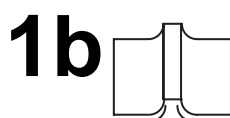

Place a book, or an original face down on the Platen Glass.

**2** Press the appropriate Index Tab.

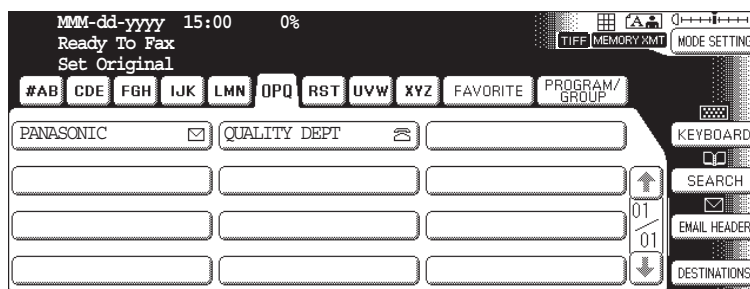

Ex:

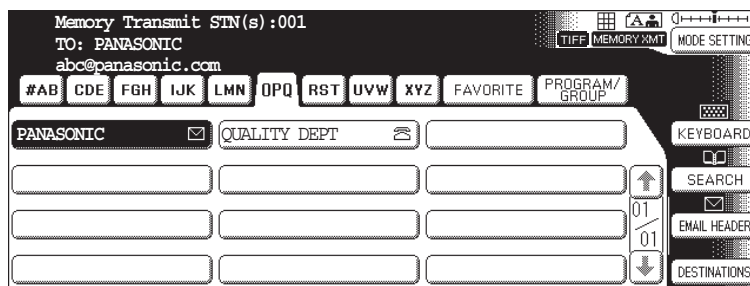

**3** Press the key name for the desired station.

Ex:



**4** If the key name for the station that you want to send to is not displayed on the LCD, press  or  to scroll to the desired display page. You can select multiple destinations (Up to 270 stations). (Address Book Email Addressing: Up to 200 stations; Manual Email Addressing: Up to 70 stations)

### Address Book Email Addressing

# 5

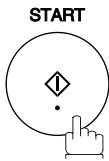

The document(s) begin to store into memory with a file number.  
Then starts connecting to the LAN immediately after storing the first page.  
(See Note 1)  
While sending the document(s) via LAN, the remaining page(s) continue to store into memory.

#### NOTE

1. The "QUICK MEMORY TRANSMISSION" is disable if multiple stations are set.
2. If the transmission cannot be completed for any reason, the email may be returned undelivered; otherwise no reply will be printed.
3. The unit will accept a combination of email address, and PSTN dialing numbers.

# Sending Documents via LAN

## Multi Email Station Addressing (Broadcasting)

You can store the document(s) into memory, and then send to multiple stations (Up to 270 addresses) via LAN.

Make sure that the FAX/EMAIL lamp is ON. If not, press  to select the "FAX/EMAIL" mode.

- 1** Set document(s).  
You can temporarily change the transmission setting.
- 2** Enter email addresses by any combination of the following methods:
  - Manual Email Addressing, press **OK** after each station is entered. (Up to 70 stations)
  - Address Book Email Addressing. (Up to 200 stations)

Ex: **PANASONIC**

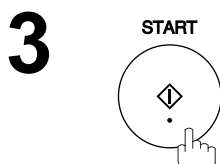
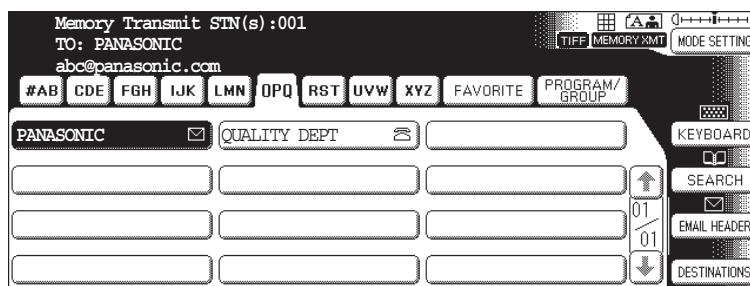

The document(s) begin to store into memory with a file number. Then starts connecting to the LAN immediately after storing the first page. (See Note 4)  
While sending the document(s) via LAN, the remaining page(s) continue to store into memory.

### NOTE

1. If your machine sounds an alarm (pi-pi-pi) in Step 2 above, this indicates that the Dialer is Full (more than 70 full email addresses are entered, or 70 transmission reservations including G3 communication have been already reserved).
2. If the transmission cannot be completed for any reason, the email may be returned undelivered; otherwise no reply will be printed.
3. The unit will accept a combination of email addresses, and PSTN dialing numbers.
4. The "QUICK MEMORY TRANSMISSION" is disable if multiple stations are set.

# Sending Documents via LAN

## Internet Fax Ledger Size Document Transmission

When transmitting via LAN, the transmitter is incapable of identifying the receiver's recording paper size capability, and thus it will not reduce the document size during transmission. Therefore, it is recommended that you send only A4/Letter size documents for LAN transmission. If a Ledger size document is transmitted, and the receiver is only able to print A4/Letter size documents, the communication will fail when the temporary setting "LEDGER EMAIL XMT" of the Select Mode is set to its default position (ON).

To send without reduction, follow the steps below.

Make sure that the FAX/EMAIL lamp is ON. If not, press  to select the "FAX/EMAIL" mode.



Place original(s) face up on the ADF.  
or



Place a book, or an original face down on the Platen Glass.

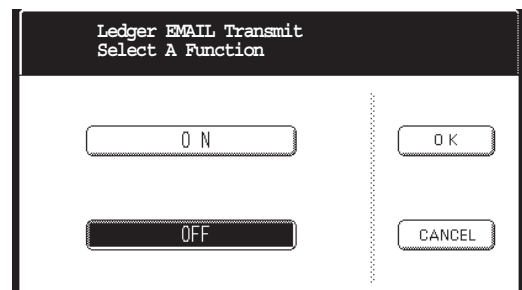
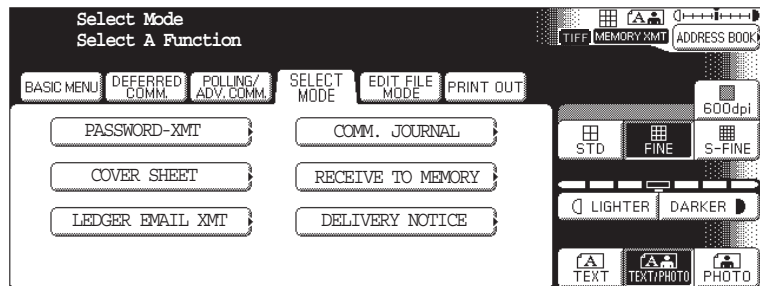

Continued on the next page...

# Sending Documents via LAN

## Internet Fax Ledger Size Document Transmission

**4**

Make sure that the setting is  ON and press  OK.

Dial by any combination of the following methods:

- Manual Email Addressing, press  OK after each station is entered. (Up to 70 stations)
- Address Book Email Addressing. (Up to 200 stations)

Ex: PANASONIC

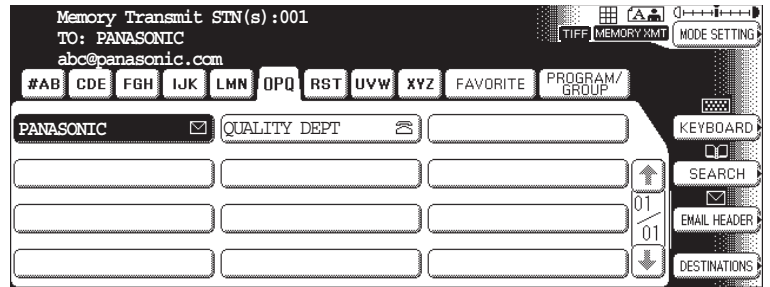

**5**

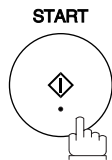

The document(s) is stored into memory with a file number.

The machine then connects to the LAN, and transmits the Ledger size document(s).

(After the document(s) are sent, the "Ledger Email Transmit" Select Mode will automatically return to the preset position (ON))

**To send with reduction, follow the steps below.**

Repeat steps 1 to 5, except in step 4, set the "Ledger Email Transmit" setting to "OFF" position.

When the Select Mode "Ledger Email Transmit" setting is set to the "OFF" position, the transmission reduction is according to the setting of Fax Parameter No. 141 (LAN XMT Reduction). (See the Table below)

- Ledger Email Transmit = ON : Transmits actual document size (without reduction).
- Ledger Email Transmit = OFF : Reduces LEDGER size document to B4 size, or to A4/Letter before transmission. (According to the Fax Parameter No. 141 (LAN XMT Reduction) setting, see Table below)

Document Size	Document Size Transmission		
	Ledger Email Transmit = ON	Ledger Email Transmit = OFF	
		Fax Parameter No. 141 (LAN XMT Reduction) set to "Invalid"	Fax Parameter No. 141 (LAN XMT Reduction) set to "Valid"
LEDGER	LEDGER	B4	A4/Letter
B4	B4	B4	A4/Letter
A4/Letter	A4/Letter	A4/Letter	A4/Letter

**NOTE**

1. Factory default setting for Fax Parameter No. 141 (LAN XMT Reduction) is "Invalid".

## Change the File Format and File Name

Your machine can change the File Type, and File Name can change only the File Type.

Make sure that the FAX/EMAIL lamp is ON. If not, press  to select the "FAX/EMAIL" mode.



Place original(s) face up on the ADF.  
or



Place a book, or an original face down  
on the Platen Glass.

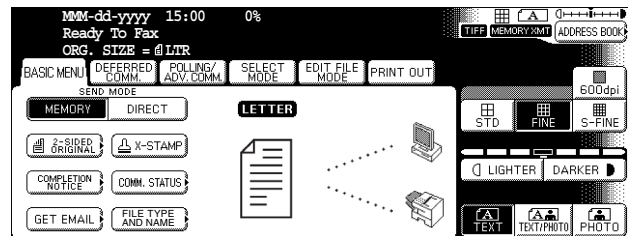
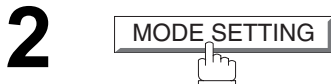

File Type and Name

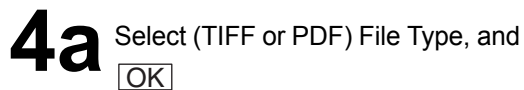
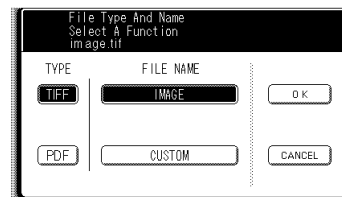

When you select  or , the  
File Name will be displayed as  
"image.tif or image.pdf".

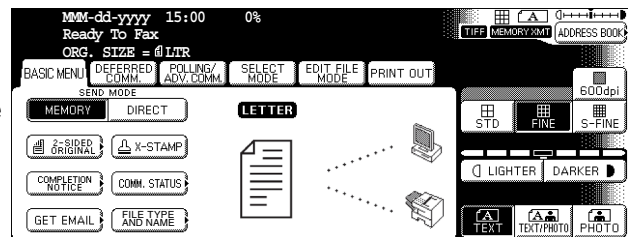

# Sending Documents via LAN

## Change the File Format and File Name

### 4b Select File Name (Customer Name)

- The File Name is displayed on upper LCD. You can Change the File Name by pressing **CUSTOM** after selecting the File Type (TIFF or PDF)
- Enter the new File Name (Up to 20 characters) by using the character keys, and press **OK**.

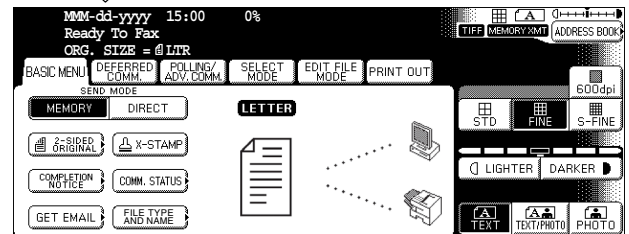
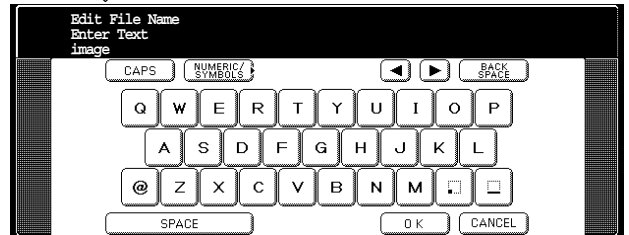
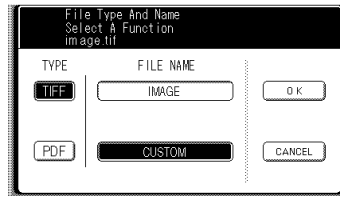

### 5

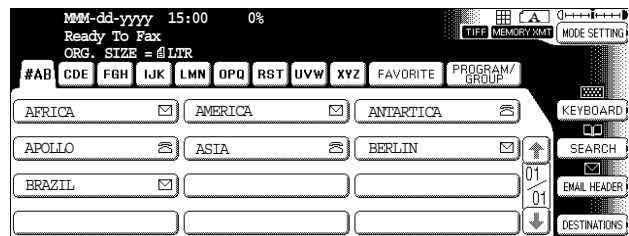

### 6

Enter email address by any combination of the following methods:

- Manual Number Dialing, press **OK** after each station is entered (Up to 70 stations)
- Address Book Dialing (Up to 200 stations)

Ex: **PANASONIC**

### 7

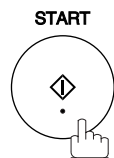

The document(s) is stored into memory, and with a file number.

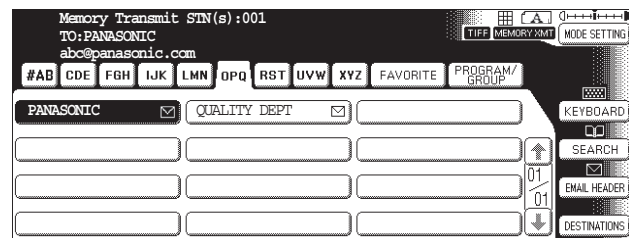

#### NOTE

1. PDF file is only available if sending the document(s) to a PC.



## Returned Email

When using the Internet communication mode, a failure report will print automatically for each transaction if the email is returned undelivered by the mail server. The printout will consist of the undelivered message contents supplied by the mail server, and a portion of the first page's image for that particular transaction.

### Failure Report Sample (User unknown)

```

Received: from localhost (localhost) by ifeifl.rdmg.mgcs.mei.co.jp (8.6.12/3.4W3) with
internal id OAA24381; THU, dd MMM yyyy 14:52:57 +0900
Date: THU, dd MMM yyyy 14:52:57 +0900
From: Mail Delivery Subsystem <MAILER-DAEMON@ifeifl.rdmg.mgcs.mei.co.jp>
Subject: Returned mail: User unknown
Message-Id: <200011120552.OAA243B1@ifeifl.rdmg.mgcs.mei.co.jp>
To: <fax@nwpc31.rdmg.mgcs.mei.co.jp>

The original message was received at THU, dd MMM yyyy 14:52:54 +0900
from nwpc31.rdmg.mgcs.mei.co.jp [172.21.22.51]

----- The following addresses had delivery problems -----
<error@nwr39.rdmg.mgcs.mei.co.jp> (unrecoverable error)

----- Transcript of session follows -----
... while talking to nwr39.rdmg.mgcs.mei.co.jp.:
>>> RCPT To:<error@nwr39.rdmg.mgcs.mei.co.jp>
<<< 550 <error@nwr39.rdmg.mgcs.mei.co.jp>... User unknown
550 <error@nwr39.rdmg.mgcs.mei.co.jp>... User unknown

----- Original message follows -----
Return-Path: fax@nwpc31.rdmg.mgcs.mei.co.jp
Received: from nwpc31.rdmg.mgcs.mei.co.jp (Internet FAX) (nwpc31.rdmg.mgcs.mei.co.jp [172.21
.22.51]) by ifeifl.rdmg.mgcs.mei.co.jp (8.6.12/3.4W3) with SMTP id OAA24380 for <error@nwr39
.rdmg.mgcs.mei.co.jp>; THU, dd MMM yyyy 14:52:54 +0900
Message-ID: <200011120552.OAA24380@ifeifl.rdmg.mgcs.mei.co.jp>
Mime-Version: 1.0
Content-Type: image/tiff
Content-Transfer-Encoding: base64
Content-Disposition: attachment; filename="image.tif"
Content-Description: image.tif
X-Mailer: Internet FAX, MGCS
Date: THU, dd MMM yyyy 14:49:00 +0900
From: "Panasonic Machine" <fax@nwpc31.rdmg.mgcs.mei.co.jp>
Subject: IMAGE from Internet FAX
To: error@nwr39.rdmg.mgcs.mei.co.jp

MMM-dd-yyyy 14:49          5          Inter Fax          P.001/001

```



**THE SLEREXE COMPANY LIMITED**  
 SAPORS LANE . BOOLE . DORSET . BH 25 8 ER  
 TELEPHONE BOOLE (945 13) 51617 - TELEX 123456

Our Ref. 350/PJC/EAC 18th January, 1972.

Dr. P.N. Cundall,  
 Mining Surveys Ltd.,  
 Holroyd Road  
 Reading,  
 Berks.

Dear Pete,

Permit me to introduce you to the facility of facsimile transmission.

In facsimile a photocell is caused to perform a raster scan over the subject copy. The variations of print density on the document cause

## Sending Documents via LAN

### Using a Mailing List

Using a Mailing List stored in the mail server simplifies the process of entering multiple locations, and allows you to send to an unlimited number of email addresses with one easy operation.

Ask your Network System administrator for information on how to utilize the Mailing List.

# Receiving Documents via LAN

## General Description

Your machine offers you a choice to receive Fax documents unattended (by default), or manually over regular telephone lines.

Your machine also offers the same choice to receive, and print Internet email messages via LAN unattended, or manually when subscribing to a POP mail server. However, when your machine is configured to receive email using SMTP protocol, the email can only be received, and printed unattended.

## Internet Fax Received on a PC

Figure 1: Outlook Express Inbox Sample

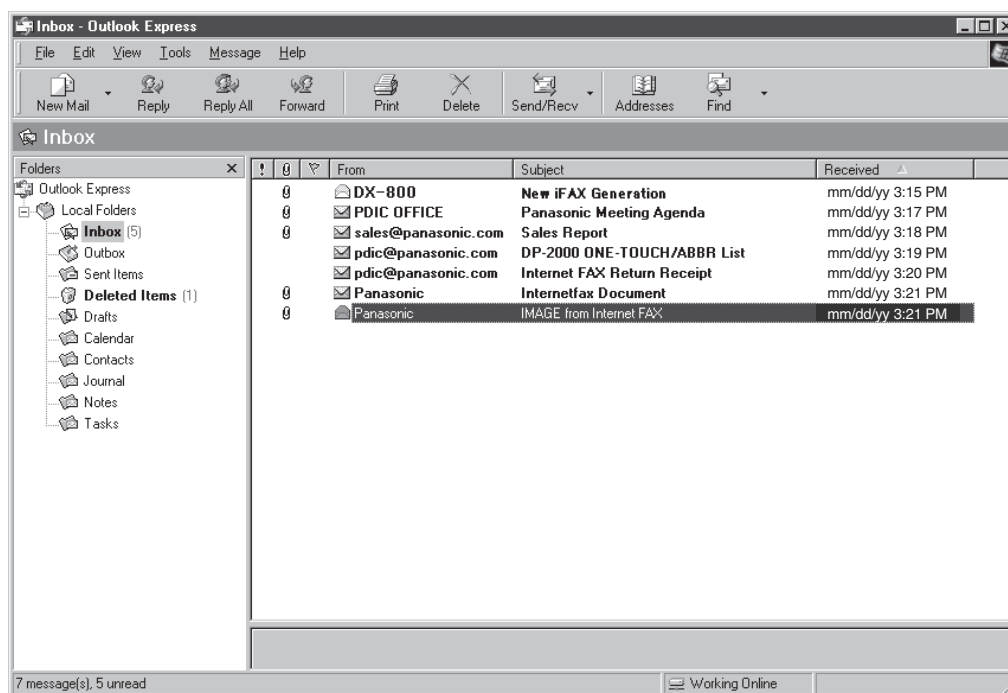

- The "Subject" column in the above example shows samples of email messages received on a PC from your machine, and Internet FAX.
- For your reference, the above example is from Outlook Express Inbox running under Microsoft® Windows. If you are using a different email application software, please refer to your application's User Manual.

# Receiving Documents via LAN

## General Description

Figure 2: Internet Fax Received on a PC

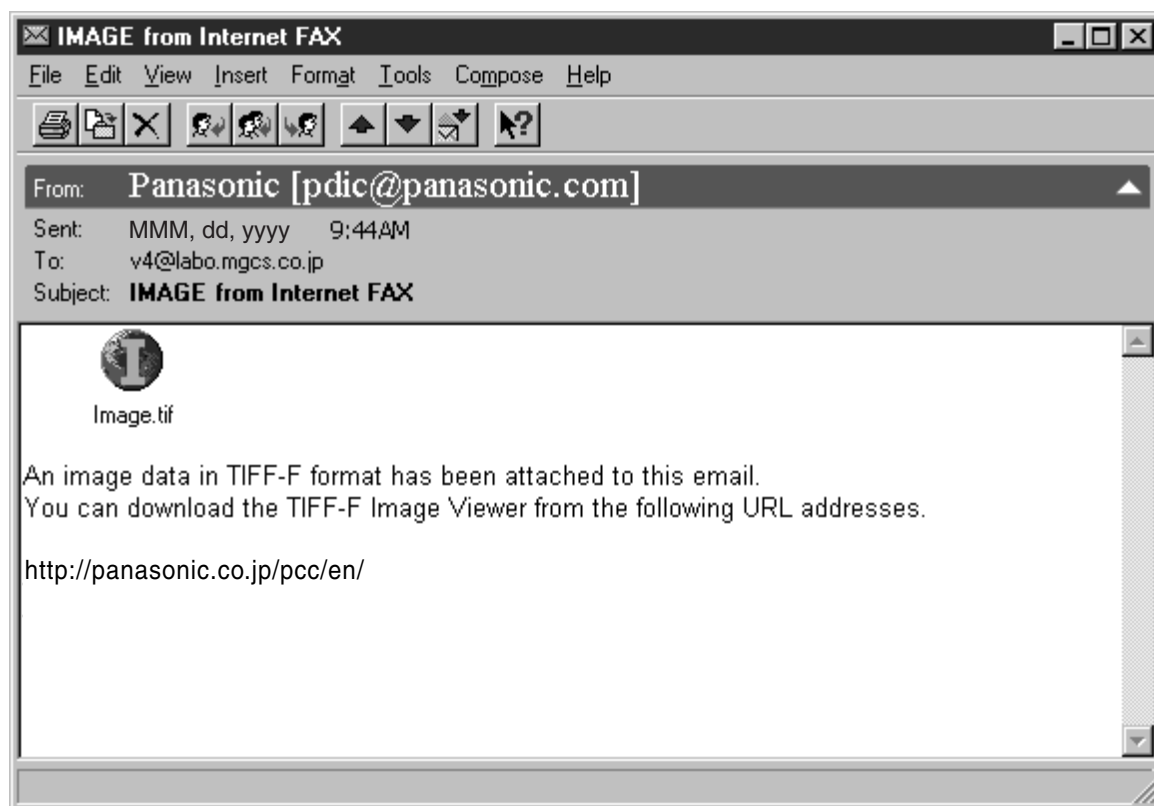

- For your reference, the above example is from Windows Messaging running under Microsoft® Windows.
- To run the Viewer, please refer to your application's User Manual. The attached file is composed of TIFF-F (Tagged Image File Format with Modified Hoffman coded image). TIFF Viewers come in many flavors, a majority of TIFF Viewers will open, and view this file, however, a handful of Viewers may not support this format.
- You can download the TIFF-F Image Viewer into your PC from the following URL addresses:  
<http://panasonic.co.jp/pcc/en/>
- License agreement of Panasonic's TIFF-F Image Viewer application

You must carefully read the license agreement before installing the TIFF-F Image Viewer application on your PC. If you do not agree to all the terms of this agreement, do not use the software, and destroy all of the copies thereof.

You must assume full responsibility for selection of the software, and its operation/non-operation, and results obtained therefrom.

- If you receive an email (Internet Fax) with a PDF file formatted attachment, the following text message is shown in the Email body.

**An image data in PDF format has been attached to this email.**

## Receiving Email from a POP Server

Your machine offers a choice to receive, and print Internet email messages via LAN unattended, or manually when subscribing to a POP mail server.

### Setting the POP Parameters

Set the parameters pertinent to the POP server (Fax Parameters No. 146 to 149).

No. 146 (POP TIMER): Enter the interval to check, and retrieve email from the POP server (0 to 60 minutes). If "0 minutes" is entered, the POP server is not checked for mail.

No. 147 (AUTO POP Receive): When there is mail to be retrieved from the POP server, your machine will retrieve it, and print the email unattended. If this parameter is set to "1:Invalid", the machine will not retrieve it, but displays the number of mails on the POP server.

No. 148 (DEL POP Receive MAIL): Select whether the email is deleted from the POP server after it is retrieved by your machine.

No. 149 (DEL POP ERROR MAIL): Select whether to delete the email from the POP server when the file attachment format is not supported.

To set the above POP parameters, follow the steps below.

1

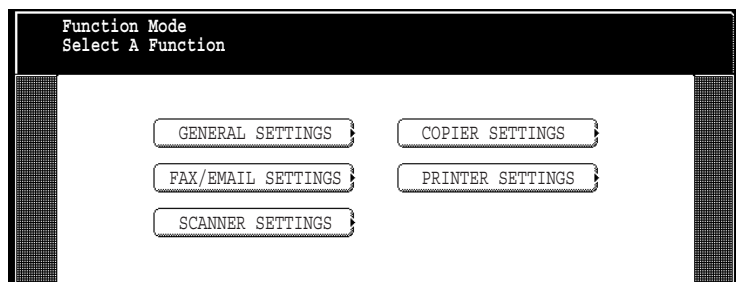

2

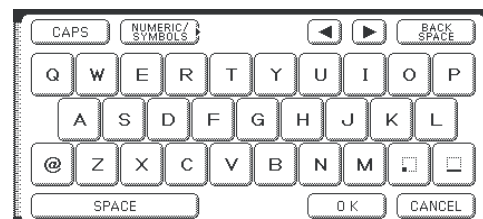
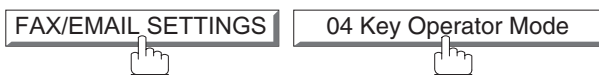

3

Input Key Operator's password, and press **OK**.  
(8 digits: alpha-numeric; alphabet (case-sensitive), numbers, symbols (@,.,\_, and SPACE))

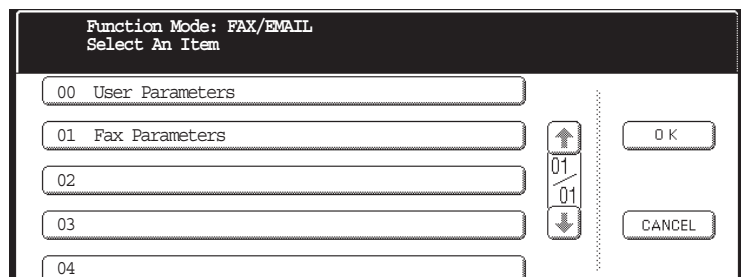

Continued on the next page...

# Receiving Documents via LAN

## Receiving Email from a POP Server

**4** Press **01 Fax Parameters** **↑** or **↓** to scroll the display to the desired Fax Parameter.  
(See page 190)

Ex: **146 POP Timer**

or

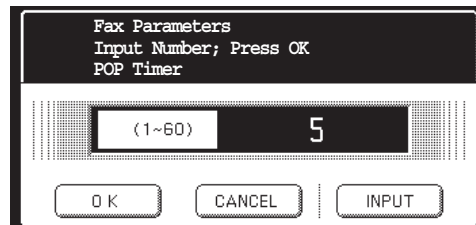

Press **01 Fax Parameters** and enter the Fax Parameter number directly from the keypad, and press **SET** or **START** key.

**5** Enter the desired retrieval interval time (0 to 60 minutes) from the keypad, and press **OK**.

If you make a mistake, press **CLEAR** to erase the time interval, and then re-enter the correct value.

**6** **147 Auto POP Receive**

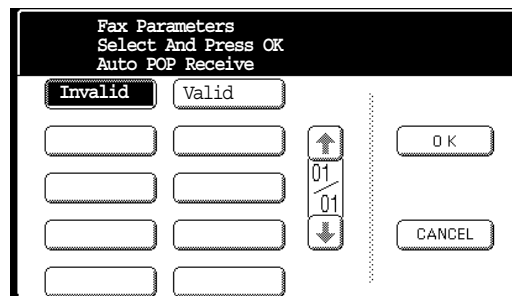

**7** Select the desired setting, and press **OK**.

Press **148 Del POP Receive Mail**.

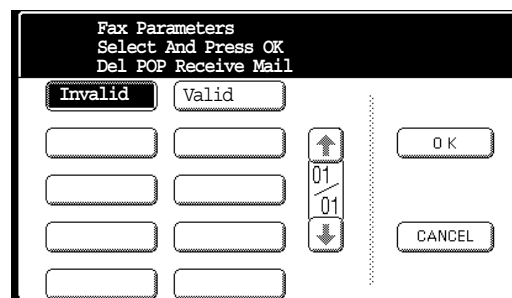

**8** Select the desired setting, and press **OK**. Press **149 Del POP Error Mail**.

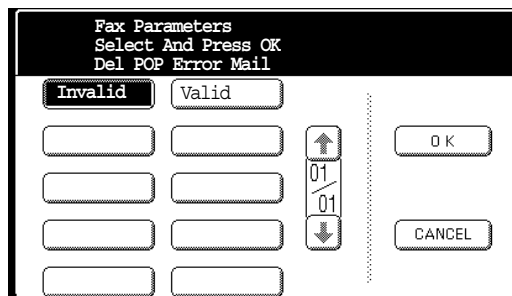

## Receiving Email from a POP Server

- 9** Select the desired setting, and press **OK**.

The screenshot shows a menu titled "Function Mode; FAX/EMAIL" with the instruction "Select An Item". The menu contains five items, each with a number, a description, and a status:

Item No.	Description	Status
145	Sender Selection	Invalid
146	POP Timer	5
147	Auto POP Receive	Valid
148	Del POP Receive Mail	Valid
149	Del POP Error Mail	Invalid

Navigation controls include an up arrow, a down arrow, and a page indicator showing "30 / 37". There are also "OK" and "CANCEL" buttons on the right side of the menu.



To return to standby.

### NOTE

1. When an unsupported file attachment is received, an error message is printed to inform you that the file attachment could not be printed.
2. When Fax Parameter No. 148 (DEL POP Receive MAIL), and/or Fax Parameter No. 149 (DEL POP ERROR MAIL) are set to 1:Invalid, email with errors will not be erased. This will allow you to retrieve this email from your PC later.

Furthermore, if these Fax Parameters are set to "1:Invalid", you will need to delete mails from the POP server periodically. POP servers allocate a certain amount of space per account, and if mail is not deleted regularly, your mail box will overflow, and new incoming mail will be rejected.

Either retrieve these mails from your PC, or set the Fax Parameters to "2:Valid" triggering your machine to receive, print, and delete all the mails from the POP server. This procedure, however, might cause mail that had been printed before to print again.

# Receiving Documents via LAN

## Receiving Email from a POP Server

### Unattended Reception from the POP Server

When the Fax Parameter No. 146 (POP TIMER) is set to a value between 1, and 60 minutes, and Fax Parameter No. 147 (AUTO POP Receive) is set to "2:Valid", the machine will query the POP server at the specified interval for new mail.

Any mail on the POP server is retrieved, and printed unattended.

When the Fax Parameter No. 146 (POP TIMER) is set to "0", the machine will not query the POP server, and the mail is not retrieved automatically. With this setting, mail must be retrieved manually from the POP server.

When the Fax Parameter No. 147 (AUTO POP Receive) is set to "1:Invalid", the machine will query the POP server for new mail at the interval specified by Fax Parameter No. 146. If new mail has arrived at POP server, the machine will not retrieve it, but displays the number of mails on the POP server.

### Manual Reception from the POP Server

To receive manually from the POP server, follow the steps below:



**2** If the POP server has not received any new mail, the following message is displayed.

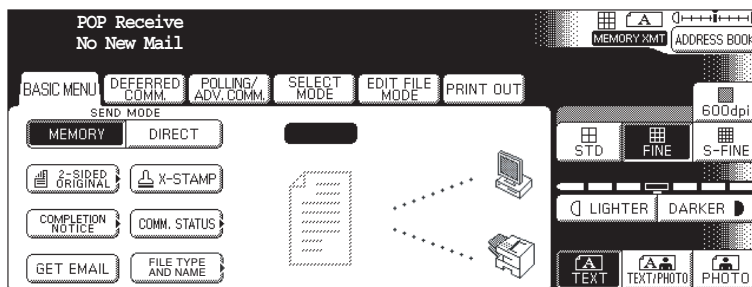

**3** If POP server received new mail, the machine will display the number of mails on the server, then receive, and print the email.

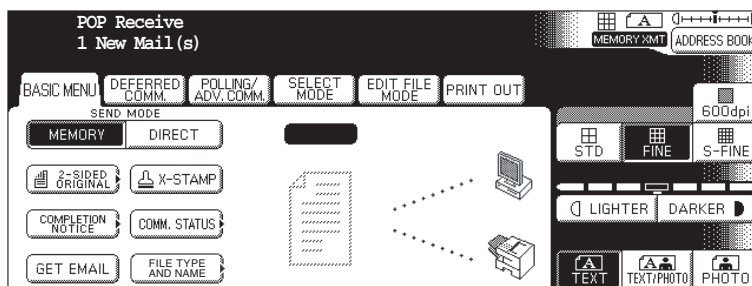

#### NOTE

1. If you program a user name, and password in the Program key, you can receive mail from the POP server using a user name other than the name set as the user parameter.
2. If the machine is in the Shutdown mode, it can not wakeup when receiving Email.



# Program Keys

## Setting the POP Email Retrieval Key

This function allows others to share your machine to retrieve their emails from the POP server by preprogramming their POP User Names, and POP Passwords into the Program Keys. They will be able to retrieve their emails by simply pressing the associated Program Key. (See Note 1)

1

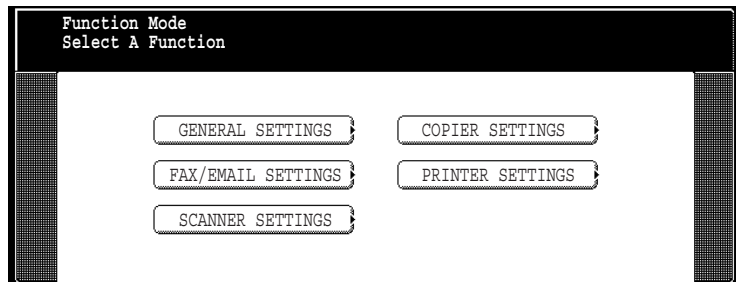

2

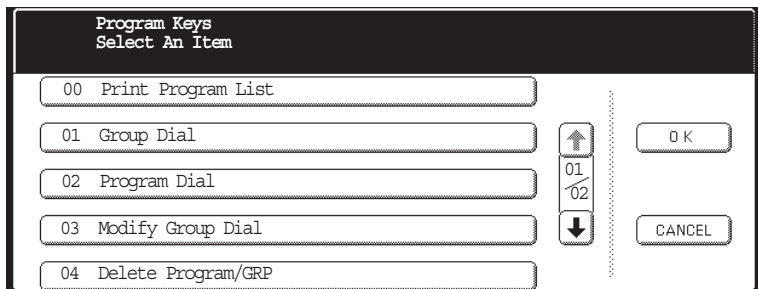

3

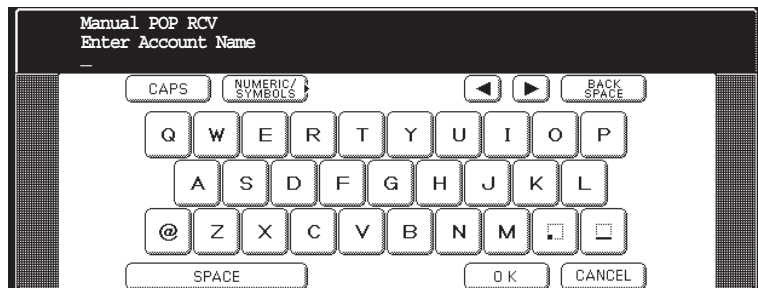
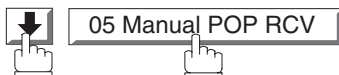

4

Enter the POP user name (Up to 40 characters), and press **OK**.

Ex: **CAPS** POP1 **OK**

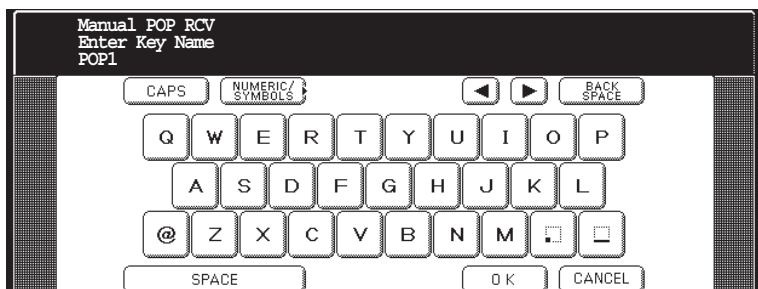

## Program Keys

### Setting the POP Email Retrieval Key

- 5** Enter the POP key name (Up to 15 characters), and press **OK**.  
(By default, the POP key name is the first 15 characters of the POP user name. If you do not want to change it, press **OK**.)

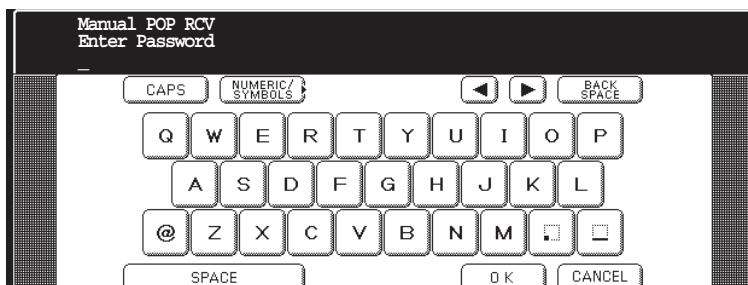

- 6** Enter the POP password (Up to 30 characters), and press **OK**.  
Ex: ① ① ① ① **OK**

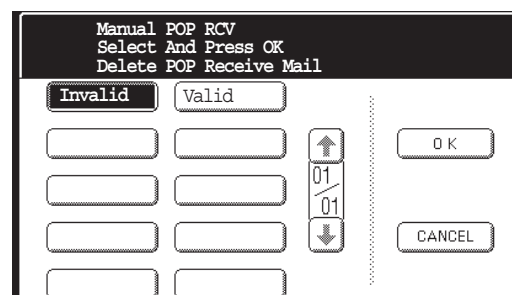

- 7** Select whether to delete the retrieved POP email from the POP server, and press **OK**.  
(Valid = will delete after email retrieval; Invalid = will not delete after email retrieval)

- 8** 

#### NOTE

1. If security is a concern, and to prevent unauthorized personnel from retrieving your email from the POP server, when programming the Program Key, leave the POP Password field "Blank". By leaving it "Blank", the machine will prompt you to enter the POP Password when the Program Key is pressed to retrieve mail.

## Using the POP Email Retrieval Key

To retrieve your Email from the POP Server by using the Program Key, follow the procedure below.

Make sure that the FAX/EMAIL lamp is ON. If not, press  to select the "FAX/EMAIL" mode.

**1** Press the Program key programmed for POP Retrieval Key.

Ex: POP1

If the POP User Account Name is not entered in the Program Key, enter the POP User Name (Up to 40 characters).

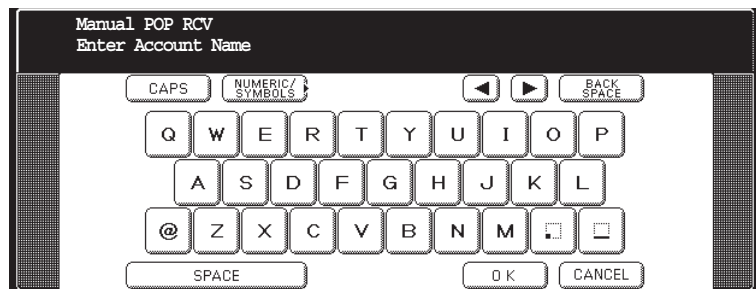
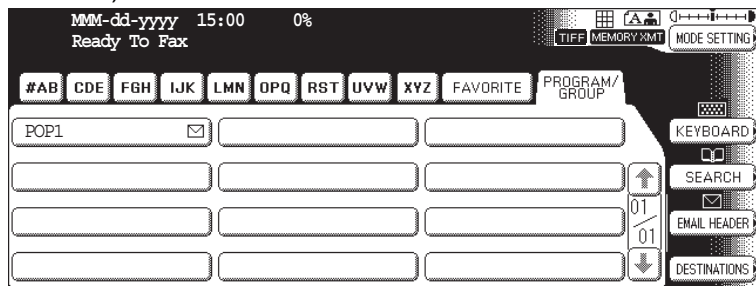

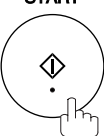
**2** 

If the POP Password is not entered in the Program Key, enter the POP Password (Up to 30 characters), and press **START**.

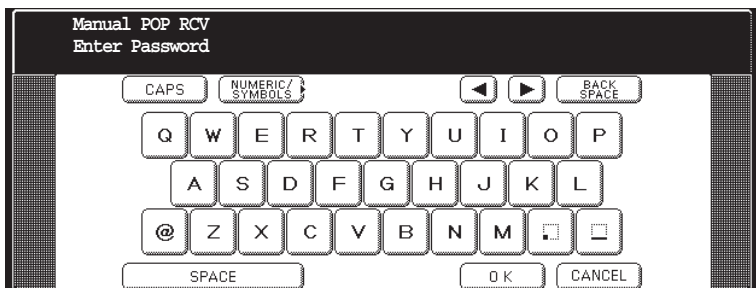

## Program Keys

### Using the POP Email Retrieval Key

- 3** If the POP server has not received any new mail, the following message is displayed.

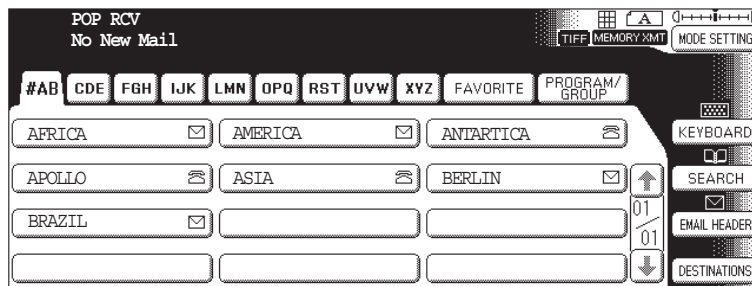

- 4** If POP server received new mail, the machine will display the number of mails on the server, then receive, and print the email.

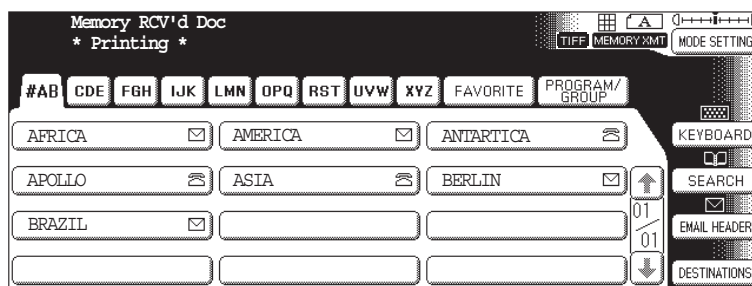
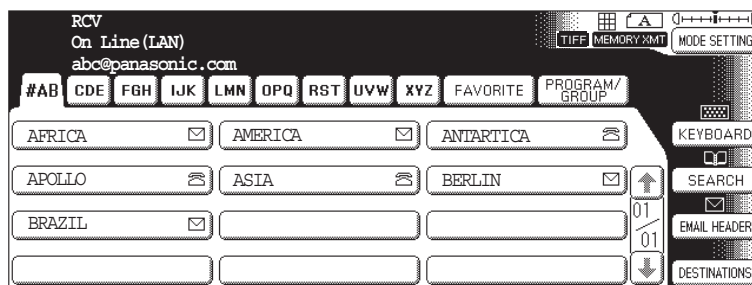

# Sender Selection

## General Description

This operation allows the user to select one of the 25 preset User Names, and Email Addresses before a transmission. The selected User Names is printed on the Header of each page sent, and on the Comm. Journal. When sending email, the selected user name, and/or email address appears in the "From:" field of the email message.

## Setting the Sender Selection

1

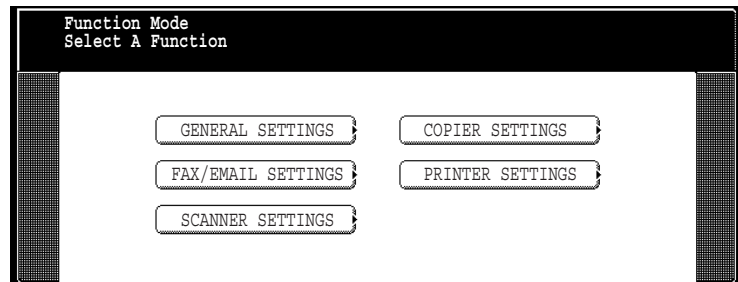

2

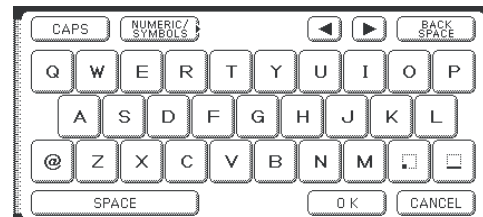
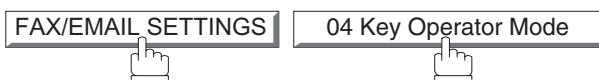

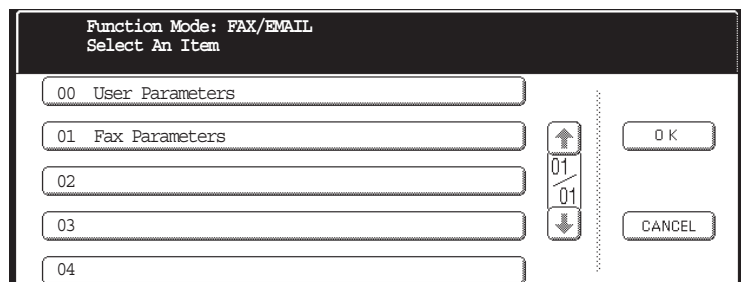

3

Input Key Operator's password, and press **OK**.  
(8 digits: alpha-numeric; alphabet (case-sensitive), numbers, symbols (@,.,\_, and SPACE))



# Sender Selection

## Setting the Sender Selection

**4** Press **01 Fax Parameters**  or  to scroll the display to the desired Fax Parameter.  
(See page 190)

145 SENDER SELECTION

or

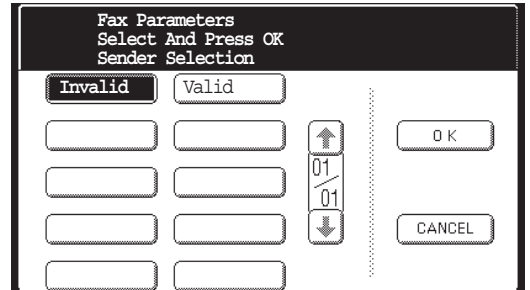

Press **01 Fax Parameters** and enter the Fax Parameter number directly from the keypad, and press **SET** or **START** key.

**5**

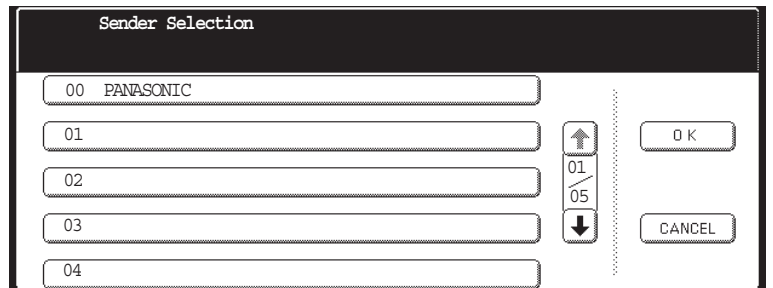
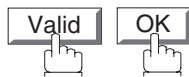

**6**

Select the Sender Selection Key (No. 01~24).  
Ex: 01

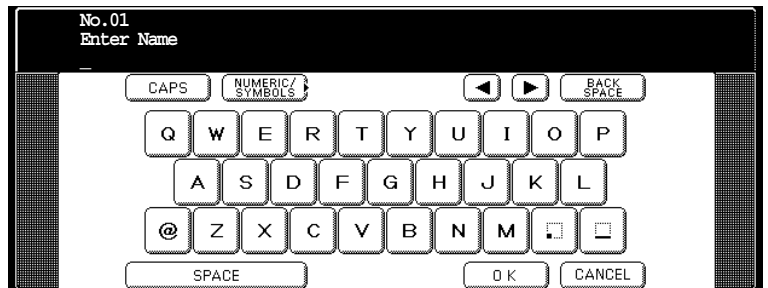

**7**

Enter your User Name (Up to 25 characters) by using character keys, and press **OK**.

Ex: P A N A S O N I C SPACE S A L E S OK

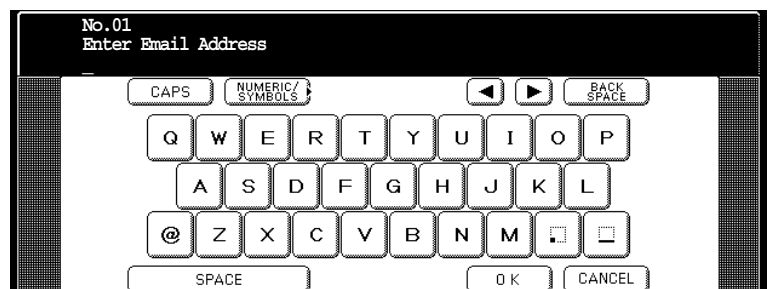

## Setting the Sender Selection

- 8** Enter an email address to be printed on the "From" field of the email message (Up to 60 characters), and press **OK**.

Ex: abc@panasonic.com **OK**

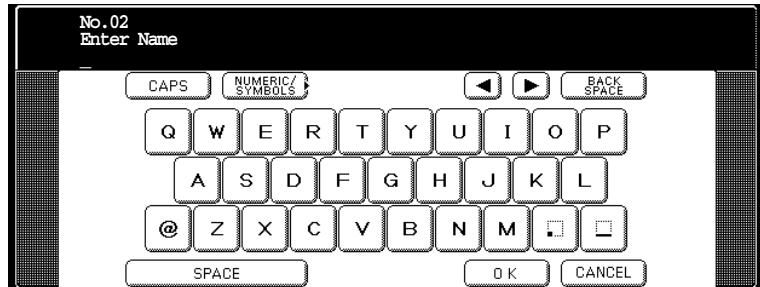

- 9** To record another User Name, repeat Steps 6 to 8.  
To return to standby, press **STOP**.

# Sender Selection

## Sending Document with Sender Selection

Make sure that the FAX/EMAIL lamp is ON. If not, press  to select the "FAX/EMAIL" mode.





Place original(s) face up on the ADF.  
or

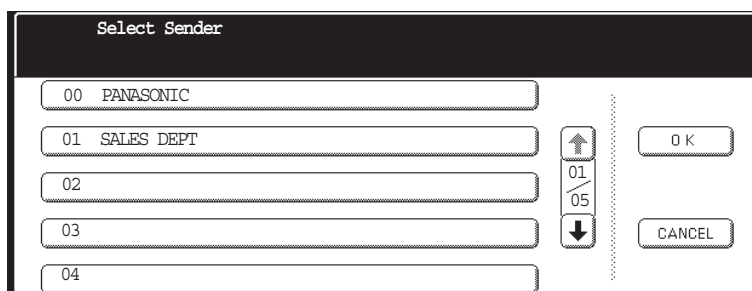

Place a book, or an original face down on the Platen Glass.

**2** Enter email address, or telephone number.  
(See Note 1)



**4** Press  or  to scroll the display to select the User Name that you want to use. (See Note 2)

Ex:

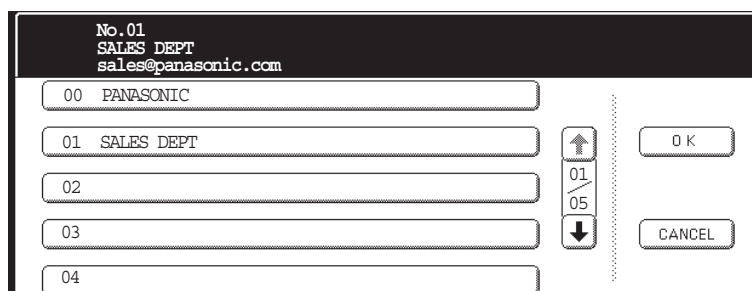

The document is sent as an email message with the selected user name, and/ or email address appearing in the "From" field of the email message.

### NOTE

1. The Sender Selection function cannot be used in the Voice Dialing Mode for ordinary transmission.
2. If you do not select a User Name in the Step 4, the unit selects the default User Name (00) that was programmed in the User Parameters for ordinary transmission.



## Printing the Sender Selection List

The Sender Selection List can be printed out following the Fax Parameter List.

To enable the printing of the Sender Selection List, change the setting of Fax Parameter No. 145 (SENDER SELECTION) to "Valid". (See page 194)

Make sure that the FAX/EMAIL lamp is ON. If not, press  to select the "FAX/EMAIL" mode.

- 1  

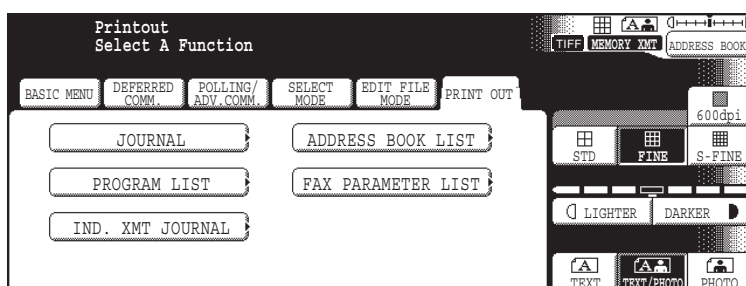

- 2 

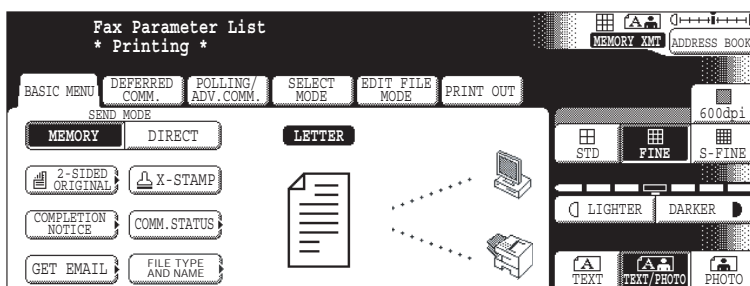

# Sender Selection

## Printing the Sender Selection List

Sample Sender Selection List (Prints following the Fax Parameter List)

```
***** -FAX PARAMETER LIST- ***** DATE MMM-dd-yyyy ***** TIME 15:00 ***P.03

      SENDER SELECTION LIST

      (1)          (2)          (3)
      NO.         USER NAME     EMAIL ADDRESS

      01          Panafax Sales   sales@panasonic.com
      02          Panafax Service service@panasonic.com
      03          Panafax Accounting account@panasonic.com

      {           {           {

      24          Panafax Engineering engineering@panasonic.com

      ***** DP-xxxx ***** -HEAD OFFICE - ***** - 201 555 1212- *****
                                     - PANASONIC -
```

### Explanation of Contents

- (1) Sender Selection Number : 01-24
- (2) User Name : Up to 25 characters
- (3) Email Address : Up to 60 characters

# Inbound Routing

## Setting the Routing Parameters

Your machine can route documents received from a G3 fax machine to email address(s), or to Internet Fax machine(s) connected to a LAN as an email, as well as to other G3 fax machine(s) over the telephone line.

To use this feature, the Fax Parameter No. 152 "Sub-Addr Routing", and/or No. 153 "TSI Routing" must be set to "2:Valid".

No. 152 Sub-Addr Routing: Set this parameter to perform an ITU-T sub-address query within its auto dialer, and to route the received document(s) to the corresponding stations email address(s), or telephone number(s).

No. 153 TSI Rout: Set this parameter to perform a Numeric ID (TSI frame information) query within its auto dialer, and to route the received document(s) to the corresponding stations email address(s), or telephone number(s).

No. 154 Rout Header FMT: Use this parameter to select the type of email header to be included in the "From" field of each routed faxes. (Default setting is "1:Originator")

Originator : The originating fax machine's TSI will appear in the "From" field of the routed email.

Relay Station : The routing station's email address will appear in the "From" field of the routed email.

No. 155 Print Routed Doc: Set this parameter to select whether a received fax to be routed is always printed on your machine, or only when the routing operation fails.

**To set the above Inbound Routing parameters, follow the steps below.**

# Inbound Routing

## Entering Address Book Dialing Numbers for Inbound Routing

If the Inbound Routing parameters are set, an ITU-T sub-address, and/or originator's Numeric ID (TSI frame information) can be programmed with each email address in Address Book numbers.

1

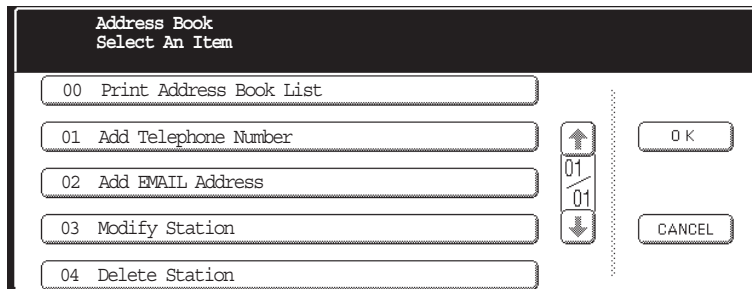

2



or

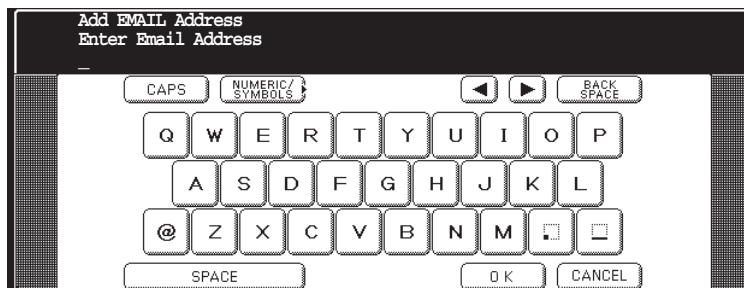
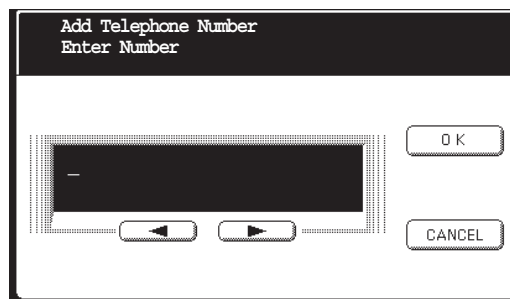

## Entering Address Book Dialing Numbers for Inbound Routing

- 3** Enter a telephone number (Up to 36 digits), or an email address (Up to 60 characters) .

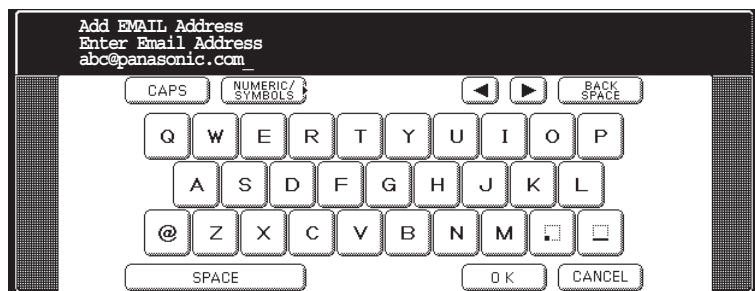
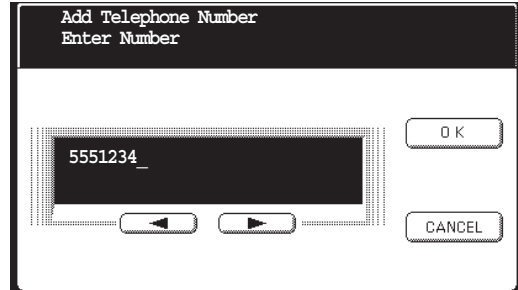

- 4** 

then enter the station name by using the QWERTY keyboard. (Up to 15 characters)

Ex:

(Use the same procedure for the remaining steps, as they are the same for adding Email Addresses, and Telephone numbers)

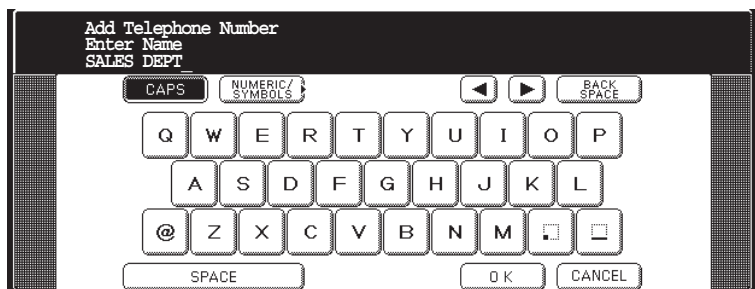

- 5** 

then enter the key name (Up to 15 characters). (By default, the key name is the first 15 characters of the station's name. If you do not want to change it, press .)

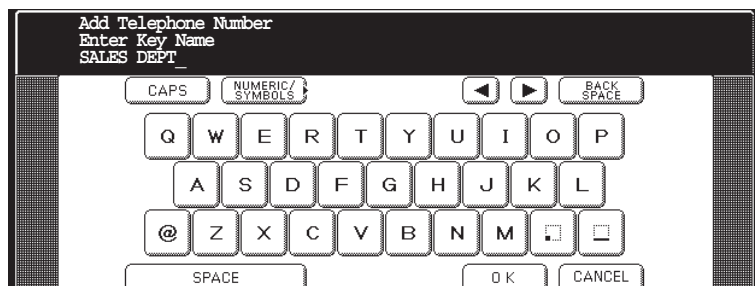

Continued on the next page...

# Inbound Routing

## Entering Address Book Dialing Numbers for Inbound Routing

6



Selecting whether to add to the favorites.

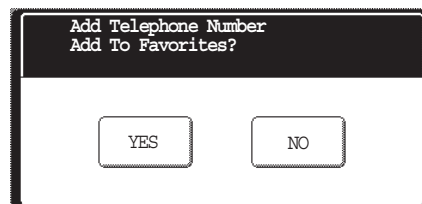

7



or



then enter the Sub-Address (Up to 20 characters).

Ex: ① ② ③ ④ ⑤ ⑥ ⑦

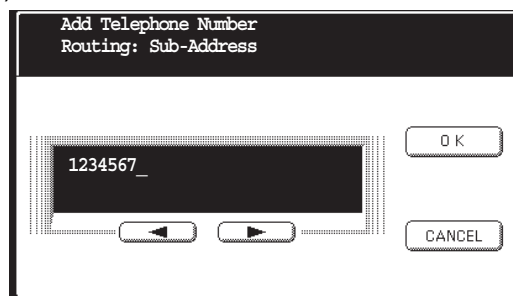

8



then enter a Numeric ID (TSI) (Up to 20 characters).

Ex: ⑤ ⑤ ⑤ ⑥ ⑦ ⑧ ⑨

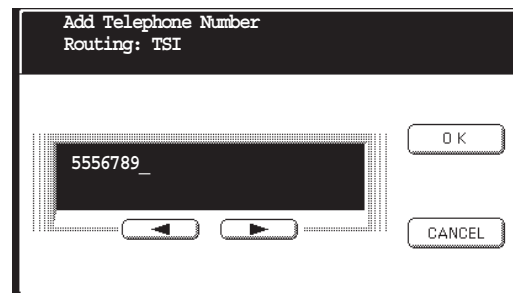

9



To return to standby, press .

**NOTE**

1. "+", and "SPACE" entries in the "ROUTING: TSI" field are ignored by the receiving machine.

# Fax Forward

## Setting Fax Forward

This feature allows all incoming faxes, or emails to be forwarded to the station registered in the Address Book. Once the faxes, or emails are received in the memory, the machine will forward the received document(s) to the telephone number, or the email address registered in the Address Book.

This function is convenient when you would like to receive faxes, or emails in another place (**Ex:** your home) at night, or during a holiday.

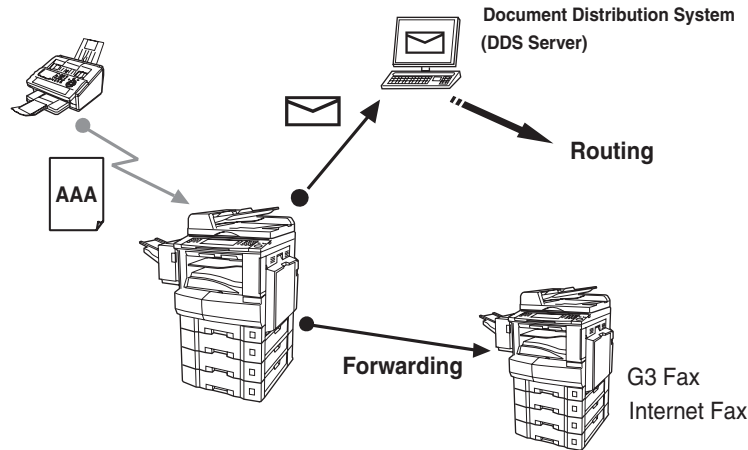

- 1 First register the destination telephone number, or email address into the Address Book.  
(See page 180)

- 2  FUNCTION

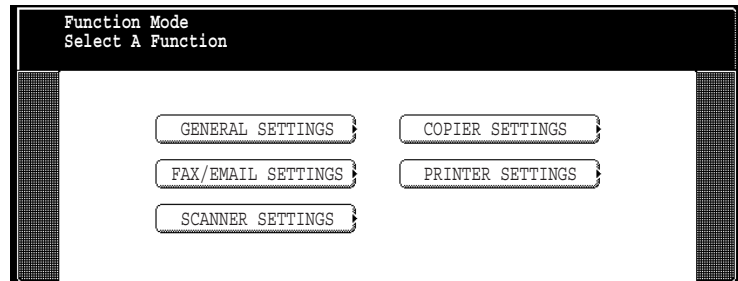

- 3  FAX/EMAIL SETTINGS       04 Key Operator Mode

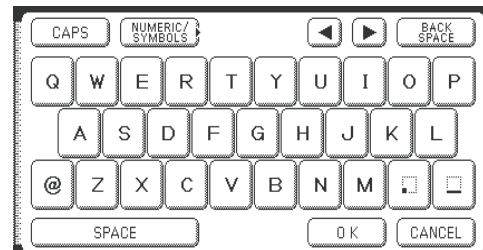

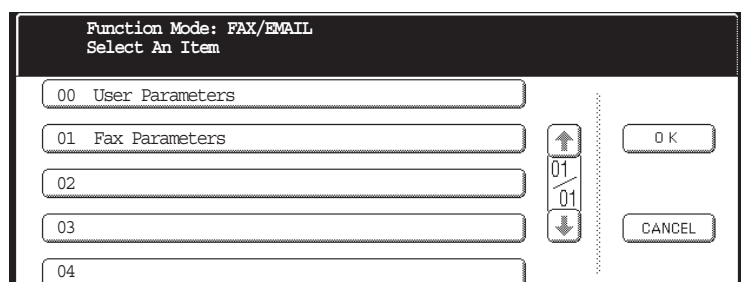

- 4 Input Key Operator's password, and press **OK**.  
(8 digits: alpha-numeric; alphabet (case-sensitive), numbers, symbols (@,..,\_ and SPACE))



Continued on the next page...

# Fax Forward

## Setting Fax Forward

**5** Press **01 Fax Parameters**  or  to scroll the display to the desired Fax Parameter. (See page 190)



or

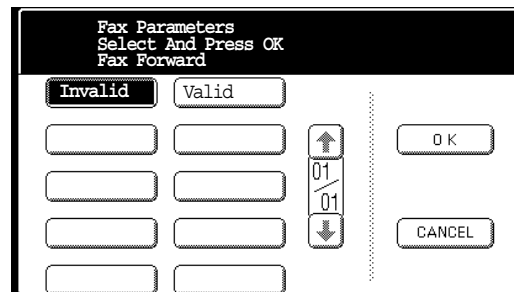

Press **01 Fax Parameters** and enter the Fax Parameter number directly from the keypad, and press **SET** or **START** key.

**6**

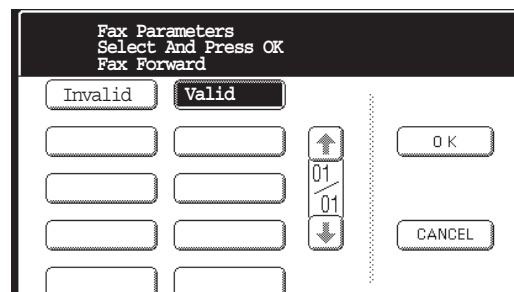

**7**

then enter the station to forward the received faxes, or emails to, by assigning a destination station in the Address Book.

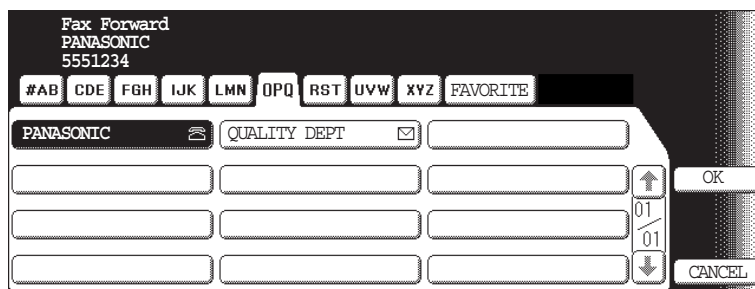

**8**  

### NOTE

1. When the Fax Forward feature is set, the assigned address book station will be restricted from editing. Please change this function to "Invalid" when you would like to edit the telephone number, or email address.
2. If the communication to transfer a received fax, or email fails, the received fax, or email will print out, and then is erased from memory. If the Fax Parameter No. 156 (PRT FORWARD. DOC) is set to "Always", the received fax, or email will print even when the transmission is successful.
3. It is not possible to receive a document if the memory of your machine overflows or, is about 95% used.
4. When the Fax Forward feature is set, the Manual POP Reception will not be available. (See pages 140, and 143)



## Fax Forward (Using Document Distribution System)

When your machine is installed with the Fax Communication Board (DA-FG300) options, your machine will allow Fax Forwarding to the Document Distribution System (DA-WR10).

This function is convenient when receiving faxes, or emails, as you can route them using the Document Distribution System.

- 1 Setup the Fax Forward setting by following steps 1 to 6. (See page 155)

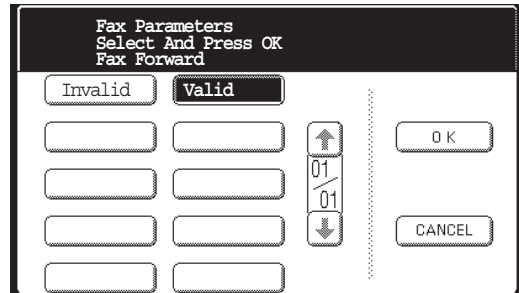

- 2 

then enter the email address of the DDS Server into the Address Book.

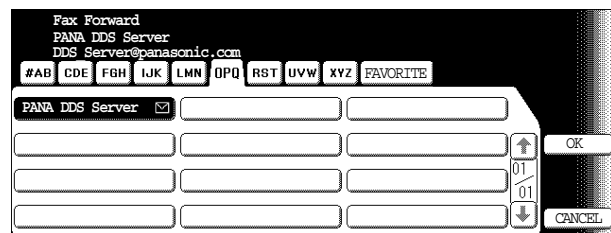

**Ex:** PANA DDS Server  
(Document Distribution System Server)

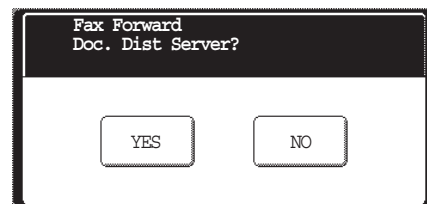

- 3 

When you select an email address station, the DDS Server confirmation request will be displayed.



- 4  

# Internet Fax Return Receipt

## General Description

Your machine automatically sends an Internet Fax Return Receipt to the sender confirming email reception from another Panasonic Internet Fax.

To disable this feature, follow the steps below.

**1** 

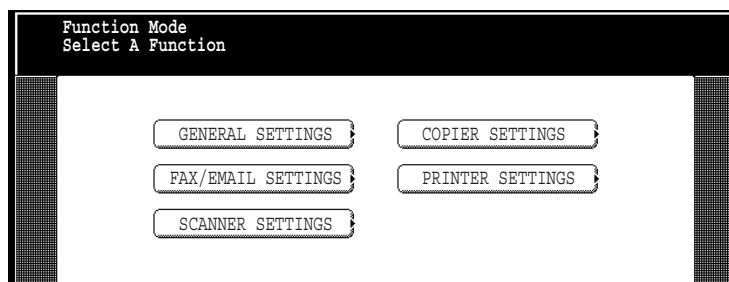

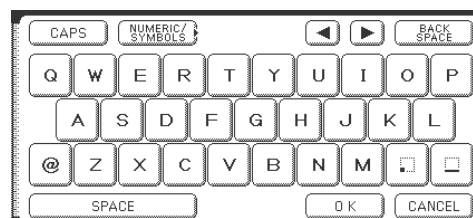

**2**  

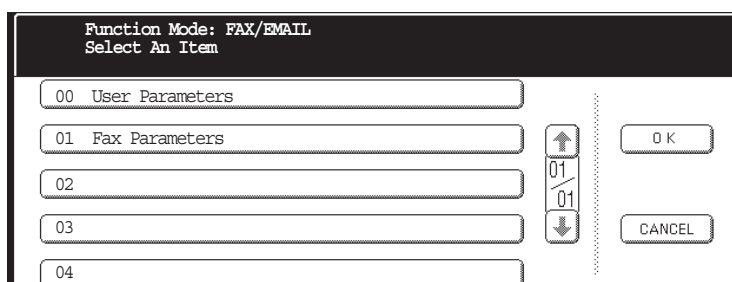

**3** Input Key Operator's password, and press **OK**.  
(8 digits: alpha-numeric; alphabet (case-sensitive), numbers, symbols (@,.,\_, and SPACE))



**4** Press **01 Fax Parameters**  or  to scroll the display to the desired Fax Parameter. (See page 190)



or

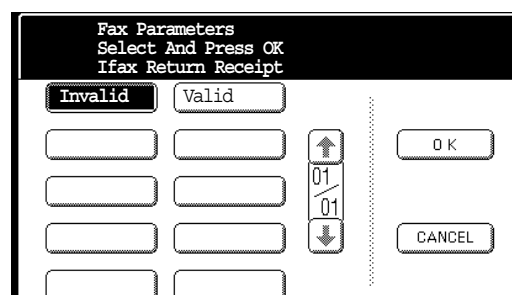

Press **01 Fax Parameters** and enter the Fax Parameter number directly from the keypad, and press **SET** or **START** key.

## General Description

**5** Select the desired setting, and press **OK**.

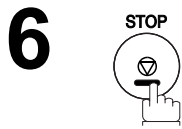

To return to standby.

### NOTE

1. *Your machine sends the Internet Fax Return Receipt only when receiving from another Panasonic brand Internet Fax. It will not confirm email sent from a PC. (The default setting for this parameter is "2:Valid".)*

# Relayed Transmission

## General Description

The Internet Relayed Transmission feature can save you time, and transmission costs if you need to send the same documents to multiple G3 fax machines.

This is especially true if the transmissions are long distance.

You can send documents to any G3 fax machine by using the Internet via a LAN from your machine to another Relay Station.

You can also send an email with attached TIFF-F file(s) to any G3 fax machine from your PC using your current email application through a Relay Station.

To use the Internet Relayed Transmission, the Relay Station must be set up properly.

### Example 1: Internet Relay Transmission

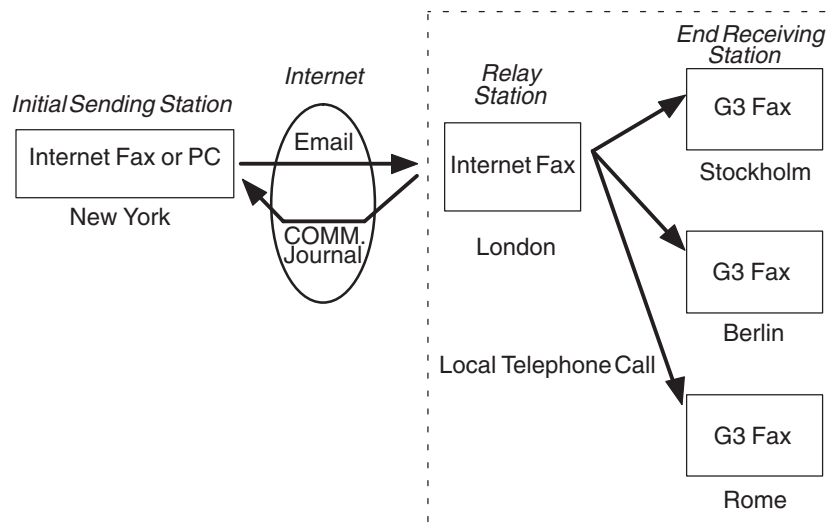

From your PC, or your machine you can send documents to a Relay Station with the telephone number of the End Receiving Station(s).

After the Relay Station completes its transmission to the End Receiving Station, your PC, or your machine receives a COMM. Journal from the Relay Station. This COMM. Journal confirms whether the Internet Relayed Transmission was successful.

### Example 2: Fax Server (Intranet Relay Transmission)

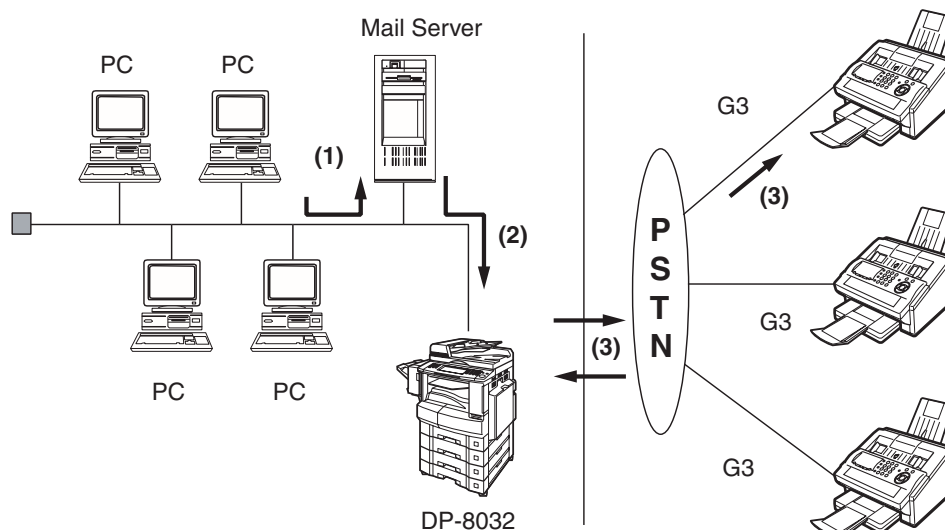

(1) Initiate a Relay Transmission via email to the Mail Server

(2) Mail Server transfers the email to your machine with relay instructions to transmit to a G3 machine

(3) Your machine initiates a telephone call to a G3 machine, and transmits the document

## Relay Network

This Feature saves you time, and long distance phone line costs when sending an Internet Fax directly from your machine to the end receiving station(s).

A Relay Network is basically composed of an Originating Station, which can be an Internet Fax Machine (your machine), or a PC, a Relaying Internet Fax Machine (another machine), and End-receiving station(s), which can be regular G3 Fax machines.

By simply sending a Document(s) from your machine, or an email message from a PC, to the Relay Machine, which is then transmitted by your machine to the end receiving station(s) using regular phone lines as a normal G3 Fax message. (PC can have TIFF-F, or text (.txt) file attachment)

The end receiving station(s) are usually local in relation to the Relay Station, which incurs a local telephone charge for the Fax Transmission.

After the Relay Station completes its transmission to the end receiving station(s), a Communication Journal is sent back to the originator from the Relaying Internet Fax confirming whether the Internet Relayed Transmission was successful. Any Relay activity information is sent by email from the Relaying Internet Fax to its Manager's Email Address, which is programmed in the Relaying Internet Fax machine's User Parameters. (See page 122)

To use the Internet Relayed Transmission, just follow the set up procedure described on pages 163 to 174, and obtain certain information provided by the Relaying machine operator. A sample network is shown in Figure 1.

Figure 1 shows a sample network as seen from **New York (Initiating Station)**, **London, and Singapore are (Relay Stations)** connected to New York, and the **(End Receiving Stations)** are **Stockholm, Rome, Tokyo, Hong Kong, and Sydney**.

With this simple network using two Relay Stations, you can send a document with one operation to any combination of stations in the network via the London Relay Station, and/or Singapore Relay Station.

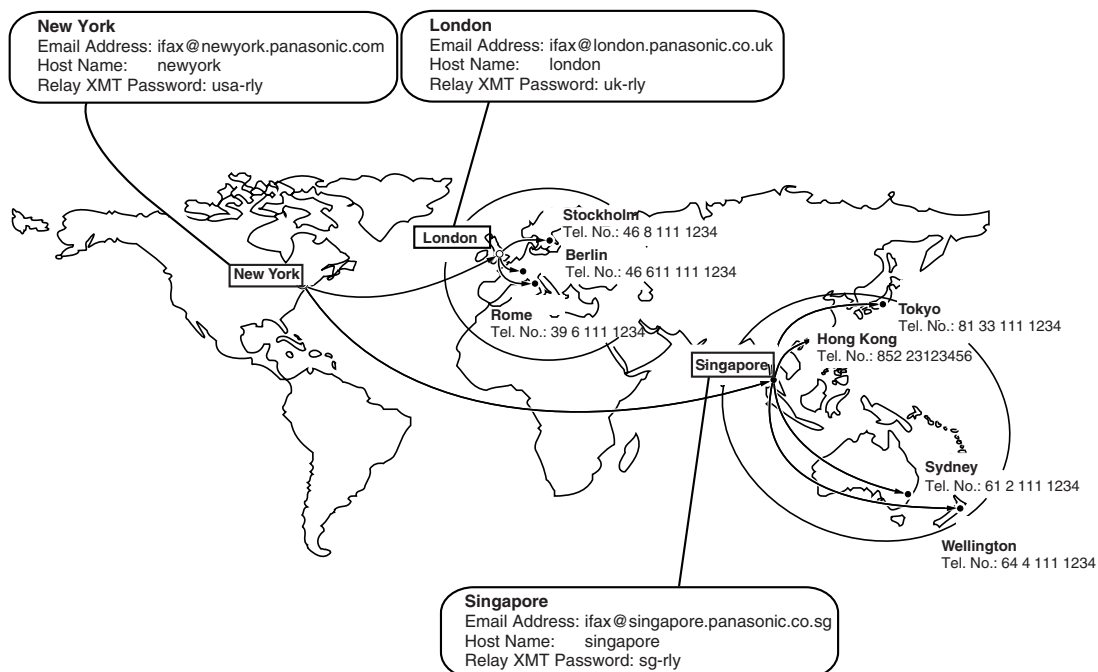

Figure 1 : Sample Network

# Relayed Transmission

## Relay Network

Table 2, 3, and 4 are sample settings for the Sample Network shown in Figure 1.

**Table 2 : Sample Parameter and Address Book Dialing Number Table for New York (Originating Station)**

Telephone Number : 212 111 1234  
 Email Address(SMTP) : ifax@newyork.panasonic.com  
 Host Name : newyork  
 Relay XMT Password : usa-rly

Station Name	Email Address / Telephone Number	Relay Station Address
London	ifax@london.panasonic.co.uk	---
Stockholm	46 8 111 1234	[London Relay]
Singapore	ifax@singapore.panasonic.co.sg	---
Tokyo	81 33 111 1234	[Singapore Relay]
London Relay	uk-rly@london.panasonic.co.uk	---
Singapore Relay	sg-rly@singapore.panasonic.co.sg	---
Rome	39 6 111 1234	[London Relay]
Hong Kong	852 23123456	[Singapore Relay]
Sydney	61 2 111 1234	[Singapore Relay]

**Table 3 : Sample Parameter and Address Book Dialing Number Table for London (Relaying Station)**

Telephone Number : 71 111 1234  
 Email Address(SMTP) : ifax@london.panasonic.co.uk  
 Host Name : london  
 Relay XMT Password : uk-rly

Station Name	Email Address / Telephone Number	Relay Station Address
New York	ifax@newyork.panasonic.com	---
Stockholm	46 8 111 1234	[London Relay]
Singapore	ifax@singapore.panasonic.co.sg	---
Tokyo	81 33 111 1234	[Singapore Relay]
Singapore Relay	sg-rly@singapore.panasonic.co.sg	---
Rome	39 6 111 1234	[London Relay]
Hong Kong	852 23123456	[Singapore Relay]
Sydney	61 2 111 1234	[Singapore Relay]
London Relay	uk-rly@london.panasonic.co.uk	---

**Table 4 : Sample Parameter and Address Book Dialing Number Table for Singapore (Relaying Station)**

Telephone Number : 65 111 1234  
 Email Address(SMTP) : ifax@singapore.panasonic.co.sg  
 Host Name : singapore  
 Relay XMT Password : sg-rly

Station Name	Email Address / Telephone Number	Relay Station Address
London	ifax@london.panasonic.co.uk	---
Stockholm	46 8 111 1234	[London Relay]
New York	ifax@newyork.panasonic.com	---
Tokyo	81 33 111 1234	[Singapore Relay]
London Relay	uk-rly@london.panasonic.co.uk	---
Rome	39 6 111 1234	[London Relay]
Hong Kong	852 23123456	[Singapore Relay]
Sydney	61 2 111 1234	[Singapore Relay]
Singapore Relay	sg-rly@singapore.panasonic.co.sg	---

### NOTE

1. The Relay XMT Password must be registered for your machine to work as a Relay Station. (See page 163)
2. To prevent unauthorized stations from accessing your Relay Station for Internet Relayed Transmissions, you must setup your network security. Enter acceptable Domain Name(s), and the Manager's Email Address for notification of all Internet Relayed Transmissions. (See page 163)

## Setting Up Your Machine as an Internet Relay Station

To set up your machine as a Relay Station, the following parameters must be set properly.

### 1. Relay XMT (Fax Parameter No. 142)

Selecting whether the machine will accept, and performs G3 relayed transmission. (See page 193)

- 1) **Invalid** - Machine will not accept a Relay XMT request.
- 2) **Valid** - Machine will accept a Relay XMT request.

### 2. Relay XMT Report (Fax Parameter No. 143)

Selecting how the COMM. Journal for relayed transmission is sent to the originator.

- 1) **Off** - Do not send
- 2) **Always** - The COMM. Journal is always sent after a Relay Communication is completed, or has failed.
- 3) **Inc. Only** - The COMM. Journal is sent if the Relay Communication to the destination has failed.

### 3. Relay XMT Password (User's Parameter) (See Note 1)

Enter a Relay XMT Password (Up to 10 characters) to be used for protection against unauthorized (outside) stations from accessing your machine to relay messages to a G3 fax machine via PSTN. This password should be given out to authorized people only.

### 4. Relay Address (Auto Dialer)

Enter the address book station that will assign the Relay Email Address of the Relay Station your machine will use.

### 5. Manager's Email Address (User's Parameter)

Register the Department Manager's Email Address for supervision, and cost control purposes. Once registered, the machine will send an email notification to this email address for each Relayed XMT Request received from a remote station. The following information is sent.

*(From : The email address of the originating station.)*

*(To : The telephone number of the destination G3 fax machine.)*

### 6. Domain Names (User's Parameter) (See Note 2)

Register up to 10 Domain Names (Up to 30 characters) that your machine will accept Relayed Transmission Requests to relay a message to another G3 fax machine via PSTN.

**Ex:** Registered Domain Names

- (01): abc.co.jp
- (02): def.co.jp
- (03): panasonic.com

In the example above, the Relayed XMT Request will be accepted only from the email addresses that include the Domain Name of abc.co.jp, def.co.jp, or panasonic.com.

## NOTE

1. This should be different than your machine's Email Address used to receive regular email, or Internet Fax, as your machine's Email Address is always included in the header of all email messages sent. So, anyone receiving an Internet Fax from the machine will easily know the Relay XMT Password if it is the same as the Email Address.
2. If all the Domain Names are left blank, the Internet Fax will accept Relayed XMT Requests from any domain.

# Relayed Transmission

## Setting Up Your Machine for Relayed Transmission

### Programming the End Receiving Station into your Address Book

If the Fax Parameter No. 140 (LAN RELAY XMT REQUEST) is set to "Valid", you can enter the Relay Address by the following procedure.

#### To set an Address Book Station for Relayed Transmission Request

1

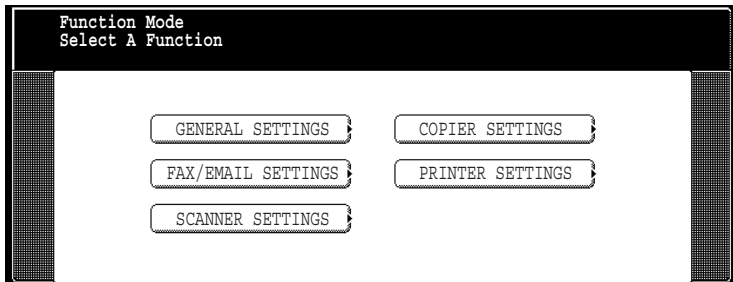

2

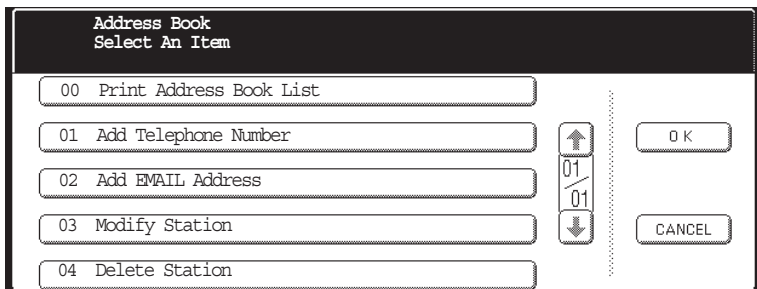

3

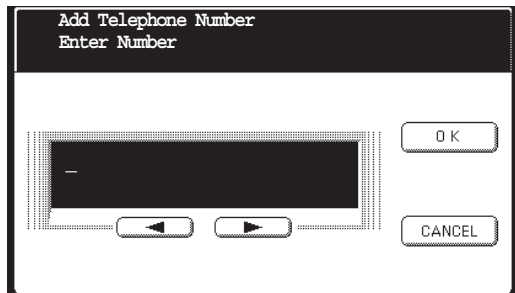

4

Enter the telephone number.  
(Up to 36 digits including pauses, and spaces)

Ex: ③ ⑨ ⑥ ① ① ① ② ③ ④

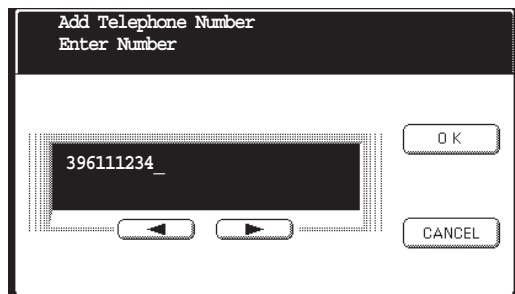



## Setting Up Your Machine for Relayed Transmission

5



then enter the station name by using the QWERTY keyboard.  
(Up to 15 characters)

Ex:

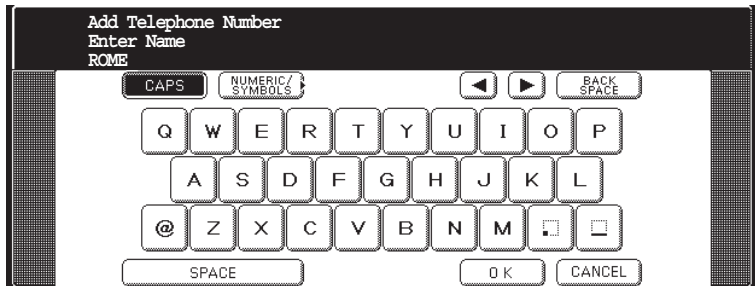

6



then enter the key name (Up to 15 characters).  
(By default, the key name is the first 15 characters of the station's name. If you do not want to change it, press .

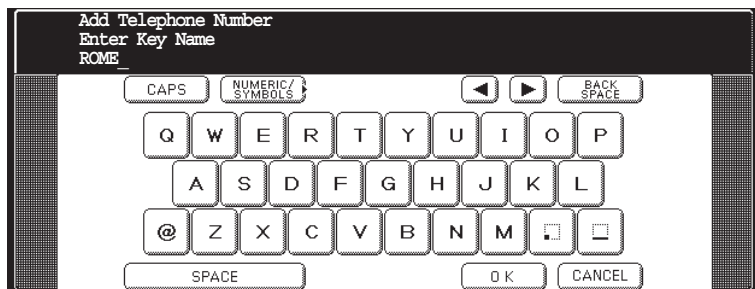

7

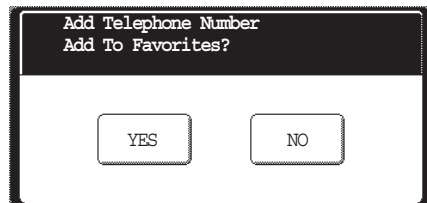

8

Select the favorite setting.

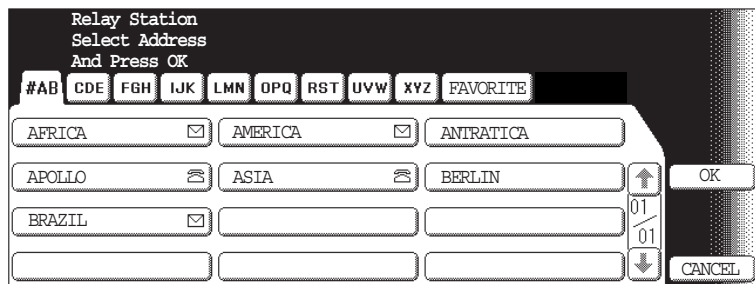

## Relayed Transmission

### Setting Up Your Machine for Relayed Transmission

**9** Enter the Address Book station of the Relay Station that you want to assign to this End Receiving Station.

Ex:

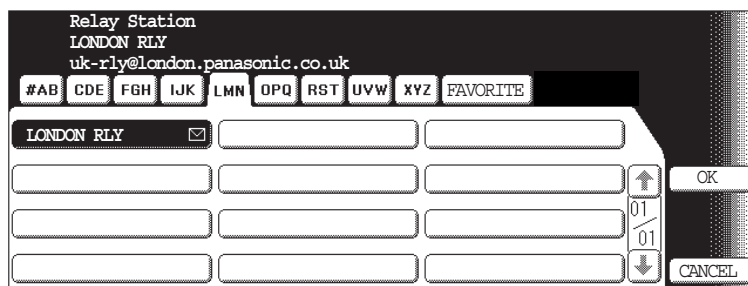

**10** To record another Relay Station, repeat Steps 5 to 9.  
To return to standby, press .

## Sending Documents via Internet Relay

Once you have recorded all the necessary parameters in your machine, you can send a document to one, or multiple G3 fax machines automatically through the Internet Relay Station by using the procedure described below. The Internet Relay Station must have all the necessary parameters setup.

### To a Location That Has a Pre-programmed Relay Station



Place original(s) face up on the ADF.  
or

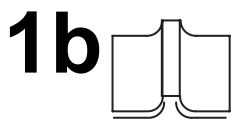

Place a book, or an original face down on the Platen Glass.

**2** Enter only the telephone number(s) of the End Receiving Station(s) that is pre-programmed the Relay Station.

Using any combination of the following methods:

- Address Book Email Addressing.  
(Up to 200 stations)  
(For details, see page 22.)

Ex: STOCKHOLM

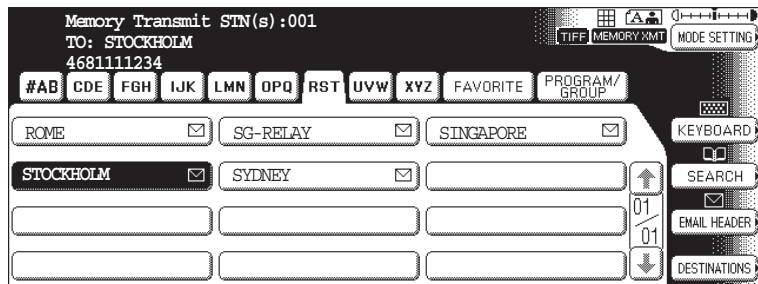

## Relayed Transmission

### Sending Documents via Internet Relay

**3**

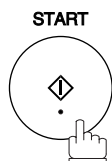

The document(s) is stored into memory, and your machine starts sending the document(s) to the Relay email address of the Relay Station with the telephone number for the End Receiving Station.

**Ex:** End Receiving Station: 4681111234  
(Telephone number)  
[see Note 1]  
Relay Station: uk-rly@london.panasonic.co.uk

After the Relay Station completes its transmission to the End Receiving Station(s), your machine receives a COMM. Journal from the Relay Station. This Journal confirms whether the Internet Relayed Transmission was successful.

#### NOTE

1. If the Relay Station requires a special access number to get an outside line, enter that access number first then press **PAUSE** to enter a pause (represented by a "-") before entering the full number.

## Sending Documents via Internet Relay

### To a Location That Does Not Have a Pre-programmed Relay Station

Make sure that the FAX/EMAIL lamp is ON. If not, press  to select the "FAX/EMAIL" mode.



Place original(s) face up on the ADF.  
or



Place a book, or an original face down on the Platen Glass.

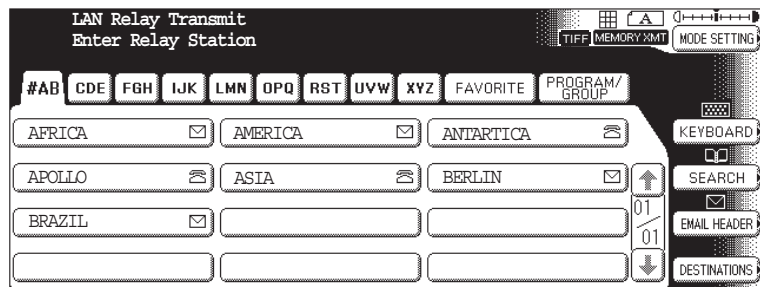

**3** Assign a Relay Station by the following method.  
• Address Book Email Addressing

Ex: LONDON RLY

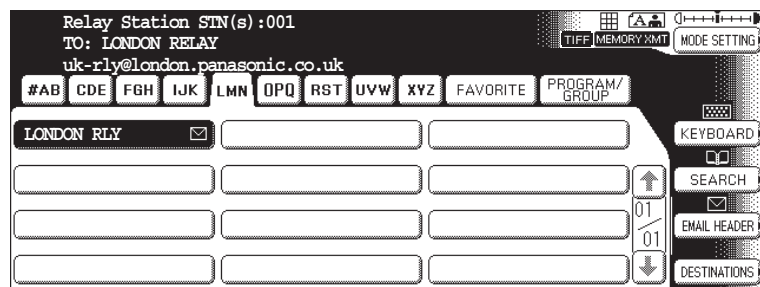

# Relayed Transmission

## Sending Documents via Internet Relay

4

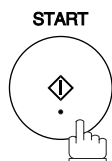

Enter only the telephone number(s) of the End Receiving Station(s) that is pre-programmed the Relay Station.

Using any combination of the following methods:

- Manual Number Dialing, press **OK** after each station is entered. (Up to 70 stations)  
(See Note 1)
- Address Book Dialing.  
(Up to 200 stations)

Ex: **STOCKHOLM**

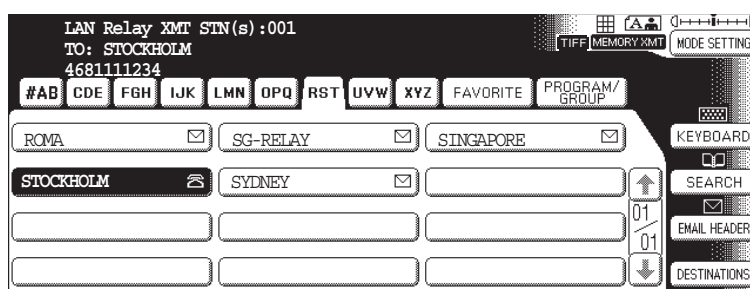

5

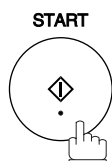

The document(s) is stored into memory, and your machine starts sending the document(s) to the Relay email address of the Relay Station with the telephone number for the End Receiving Station.

Ex: End Receiving Station: 4681111234

(Telephone number)

[see Note 1]

Relay Station: uk-rly@london.panasonic.co.uk

After the Relay Station completes its transmission to the End Receiving Station(s), your machine receives a COMM. Journal from the Relay Station.

This Journal confirms whether the Internet Relayed Transmission was successful.

### NOTE

1. If the Relay Station requires a special access number to get an outside line, enter that access number first then press **PAUSE** to enter a pause (represented by a "-") before entering the full number.
2. The "#" character is not available for the email address of the relay station.

### Sending Document(s) from a PC to a G3 Fax Machine

Using your email application, you can send any document(s) from your PC as a TIFF-F attachment to one, or multiple G3 fax machines automatically through the Internet Relay Station.

The Internet Relay Station (your machine) must be properly setup with all the required parameters.

To send a Relayed Transmission from your PC using your email application, follow the example below.

**Ex:** In the "To:" box of your email application, type the following:

sg-rly#81331111234@singapore.panasonic.co.sg

- Relay XMT Password: sg-rly
- # + End Receiving Station (with Phone Number): #81331111234 (See Note 1)
- @ + Relay Station's Domain Name: @singapore.panasonic.co.sg

Your PC sends the text document(s) to the Relay email address of the Relay Station with the telephone number of the End Receiving Station.

After the Relay Station completes its transmission to the End Receiving Station(s), your PC receives a COMM. Journal from the Relay Station. This Journal confirms whether the Internet Relayed Transmission was successful.

#### NOTE

1. The "#", and "\*" symbol must be entered after the Relay XMT Password as it indicates to your machine that a phone number for the End Receiving Station will follow.
2. If the Relay Station requires a special access number to get an outside line, enter that access number first then enter a hyphen (represented by a "-") before entering the full number.

## Relayed Transmission

### Sending Document(s) from a PC to a G3 Fax Machine

**A TIFF Converter** software is used on your PC to convert document(s) into a "TIFF" file format, which allows the Internet FAX to receive the document as an attachment to an email. When you are sending a detailed graphic document(s) to a Panasonic Internet Fax, you can specify 600 dpi resolution for better clarity.

**Internet Fax Mailer** software is an add-in program for the TIFF Converter that links the email client for MAPI to the TIFF converter for the Internet FAX.

Before sending a printing image as email from the application to the Internet FAX, you have to convert the file into the format that the Internet FAX is allowed to receive, and print as an email using the TIFF file creation function. You also have to send that file to the Internet FAX as an attached document.

Internet Fax Mailer, allows you to automatically create TIFF files by pressing one button from the TIFF Converter for the Internet FAX.

You can download the Panasonic's TIFF Converter, and Internet Fax Mailer software, and their respective User's Guides from any of the following URL addresses.

<http://panasonic.co.jp/pcc/en/>

To simplify the Relay Transmission operation, Panasonic has an Optional Panafax Fax Gateway software. Please visit the following URL address for more details:

<http://www.panasonic.com/office>



## Printouts and Reports

When you use Relayed Transmission, relay station will send the following two reports to help you check, and keep track of your faxes.

### 1. Relay XMT Report (COMM. JOURNAL)

When the relay station finishes transmitting to the End Receiving Station, it will send a Comm. Journal to you when the Fax Parameter No. 143 is set to "Always", or "Inc. only", this tells you whether the transmission was successful, or not.

### 2. Transmission Journal

When the Relay Station receives instructions for a relayed transmission, a notification is emailed to the registered manager (see "Setting up Your machine as an Internet Relay Station" on page 163).

### Sample Relay XMT Report (COMM. JOURNAL)

```

***** -COMM. JOURNAL - ***** DATE MMM-dd-yyyy **** TIME 15:00 *****
(1)                                (2)                                (3)
MODE = RELAYED TRANSMISSION        START=MMM-dd 15:00        END=MMM-dd 15:00
FILE NO.= 050 (4)
(5)    (6)    (7)    (8)                                (9)    (10)
STN    COMM.  KEY NAME  STATION NAME/EMAIL ADDRESS/TELEPHONE NO.  PAGES  DURATION
NO.
001    R-OK   STOCKHOLM  001/001  00:00:15
002    R-OK   ROME                001/001  00:00:15
                                - PANASONIC -
***** DP-xxxx ***** - HEAD OFFICE - ***** - 201 555 1212 - *****
    
```

### Explanation of Contents

- (1) Indication of communication mode
- (2) Start time of communication
- (3) End time of communication
- (4) File number : 001 to 999
- (5) Sequential number of the stations
- (6) Communication result : "R-OK" indicates that the Relayed XMT Request was successful.  
"3-digit Info Code" (see page 217) indicates that the communication has failed.
- (7) Key Name
- (8) Telephone Number, Email Address, or Station Name of the end receiving station
- (9) Number of pages transmitted : 3-digit number represents the number of pages successfully transmitted.
- (10) Duration of Communication

### NOTE

1. If you transmit through more than one Relay Station, you will receive a separate Result Report.

# Relayed Transmission

## Printouts and Reports

### Sample Relayed Transmission Notification Email to a Manager

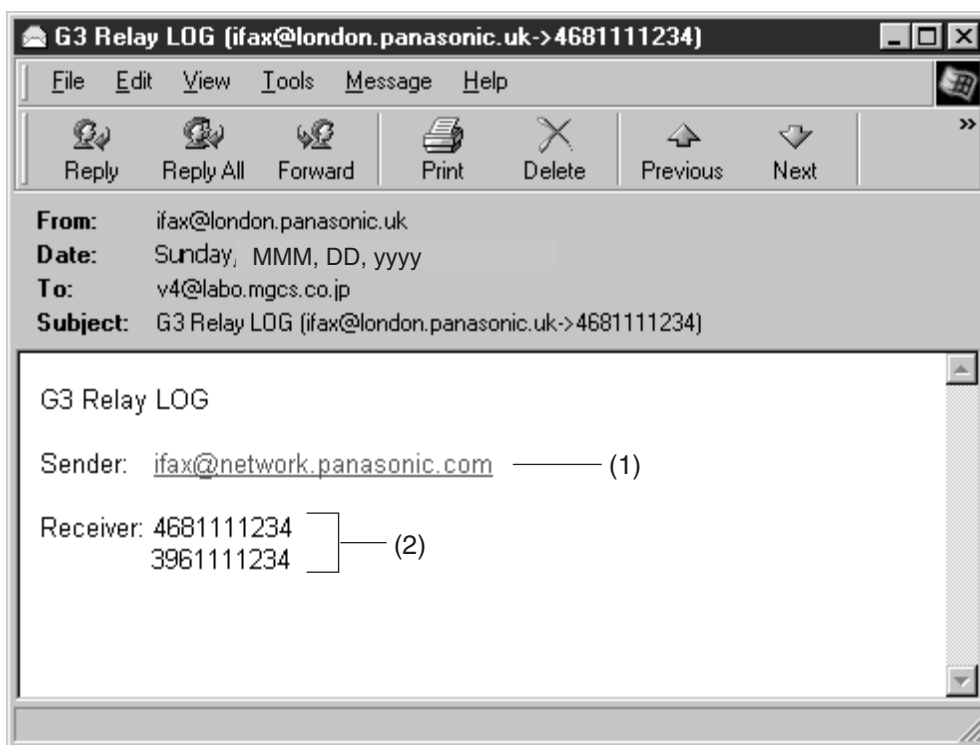

#### Explanation of Contents

- (1) Email address of the sender's Internet Fax (Your machine), or PC
- (2) End Receiving Station's G3 fax telephone number(s)

# Setting the Dialing Method (Tone or Pulse)

## General Description

Your machine can operate with either of two dialing methods (Tone or Pulse), depending on the type of telephone line you are connected to. If you need to change the dialing method to Tone or Pulse, follow the procedure below.

1

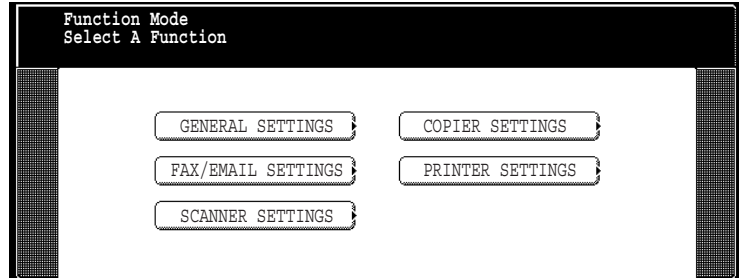

2

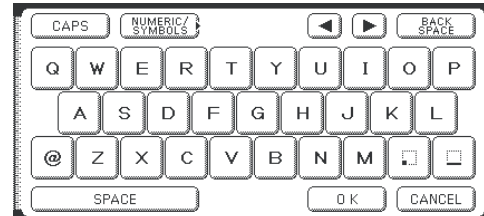
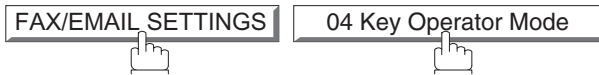

3

Input Key Operator's password, and press **OK**.  
(8 digits: alpha-numeric; alphabet (case-sensitive), numbers, symbols (@,.,\_, and SPACE))

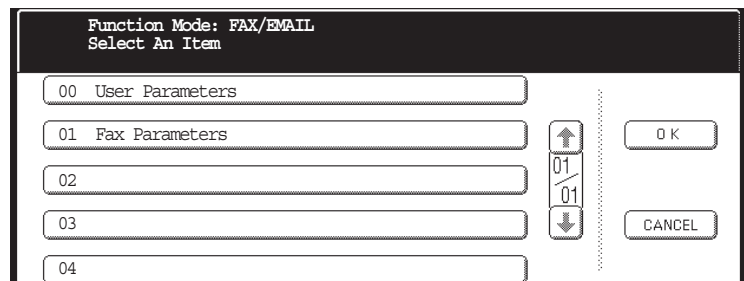

4

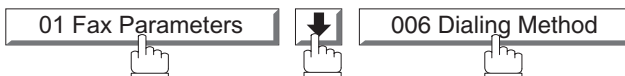

5

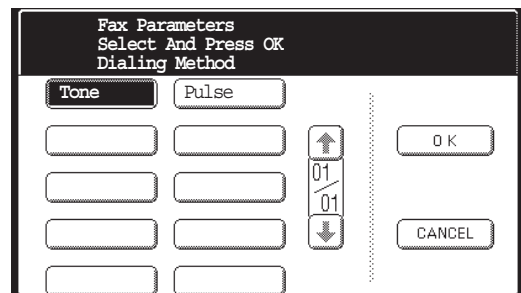
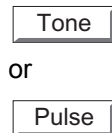

6

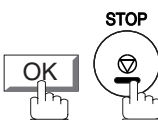

# Adjusting the Volume

## General Description

You can adjust the monitor volume on your machine. The built-in speaker enables you to hear the dial tone, dialing signals, and busy tone.

## Setting the Monitor Volume

Make sure that the FAX/EMAIL lamp is ON. If not, press  to select the "FAX/EMAIL" mode.

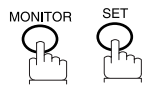

**1**

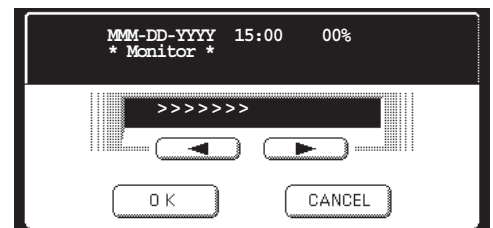

You will hear the dial tone through the speaker.



**2**

Press  or  repeatedly to raise, or lower the Volume.

**3**

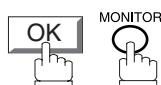

# User Parameters

## General Description

Your facsimile machine has several basic settings (User Parameters) to help you keep records of the documents you send, or receive. For example, the built-in clock keeps the current date, and time, and your LOGO, and ID Number help to identify you when you send, or receive documents.

## Setting the User Parameter

At standby the display will show the date, and time. Once the standby display is set, it will automatically be updated.

1

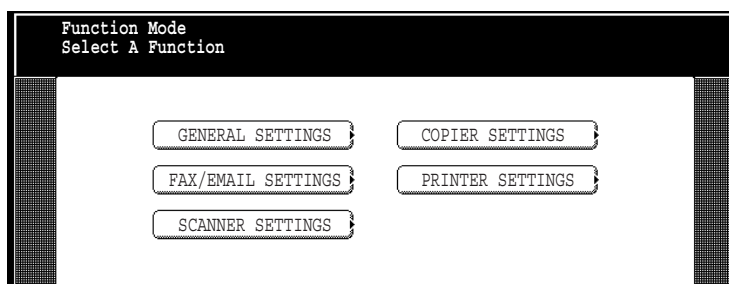

2

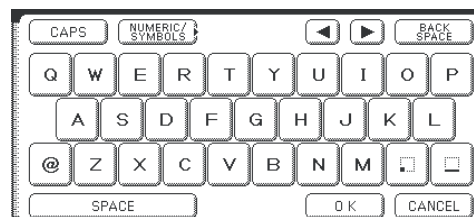

3

Input Key Operator's password, and press **OK**.  
(8 digits: alpha-numeric; alphabet (case-sensitive), numbers, symbols (@,.,\_, and SPACE))

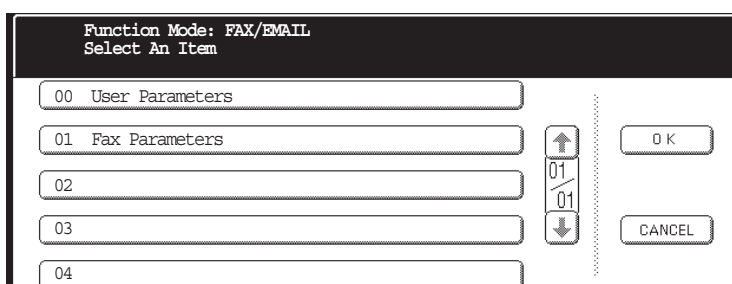

4

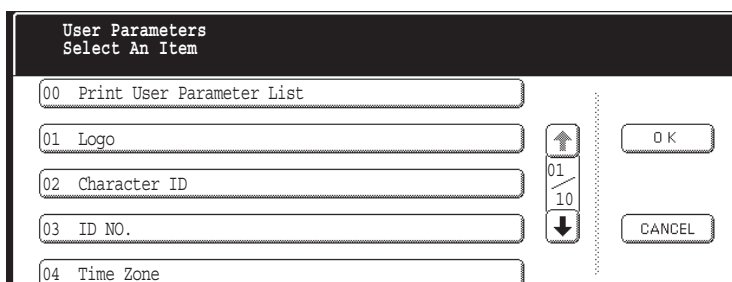

Continued on the next page...

## User Parameters

### Setting the User Parameter

5

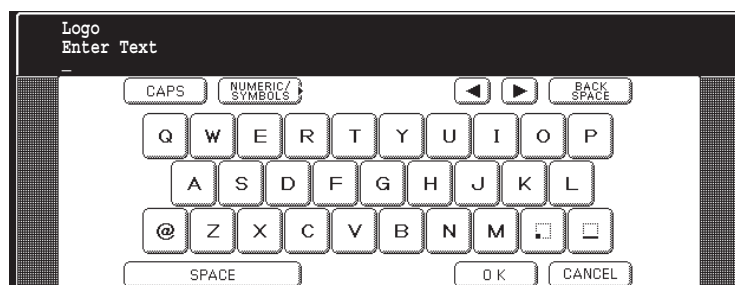
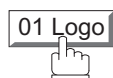

6

Enter your LOGO (Up to 25 characters, and digits) by using the QWERTY Keyboard.

Ex: **CAPS** P A N A S O N I C

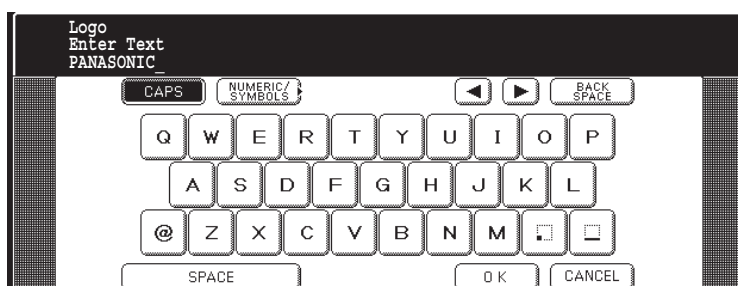

If you make a mistake, use ◀ or ▶ to move the cursor one space beyond the incorrect character, press **CLEAR** then re-enter the new character.

7

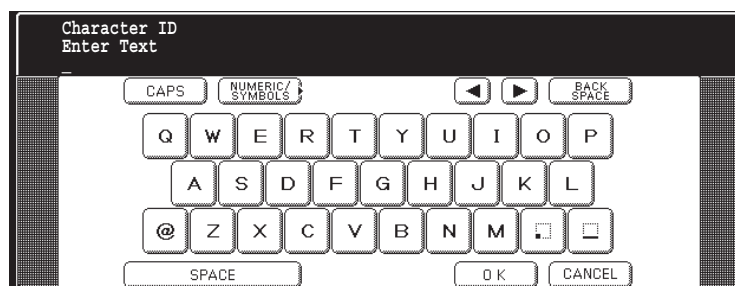
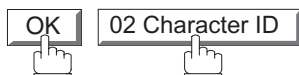

8

Enter your Character ID (Up to 16 characters, and digits) by using the QWERTY Keyboard.

Ex: **CAPS** H E A D SPACE O F F I C E

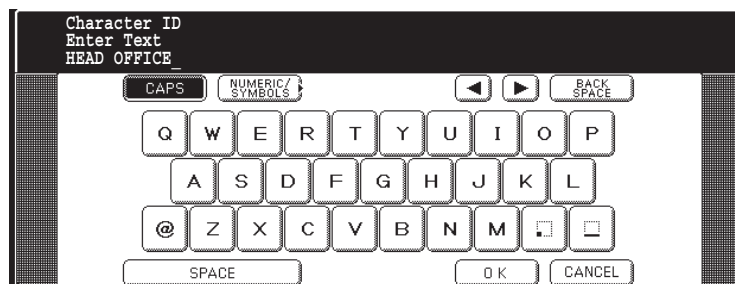

If you make a mistake, use ◀ or ▶ to move the cursor one space beyond the incorrect character, press **CLEAR** then re-enter the new character.

## Setting the User Parameter

9

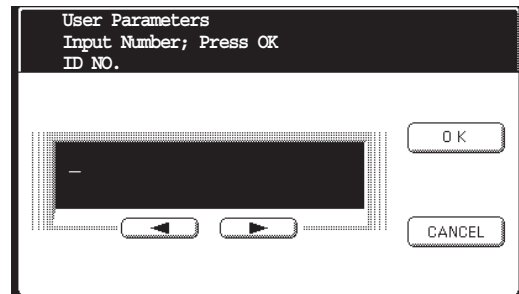

10

Enter your ID (Up to 20 digits) by using the keypad, and **MONITOR** key to enter a space between numbers.

Ex: 2 0 1 **MONITOR** 5 5 5 **MONITOR** 1 2 1 2

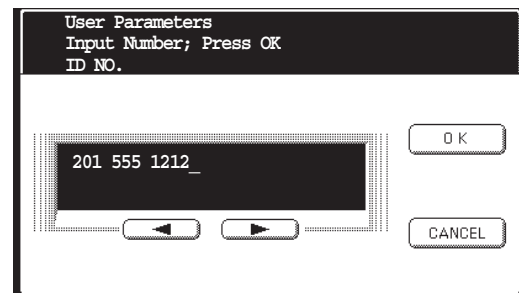

If you make a mistake, use **◀** or **▶** to move the cursor one space beyond the incorrect number, press **CLEAR** then re-enter the new number.

11

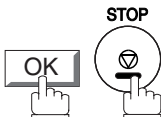

### NOTE

1. The current Date & Time must be set because it is required by the Telephone Consumer Act of 1991. (For details, see FCC NOTICE at the end of this User's Guide)
2. Your Company Name, or your name must be set because it is required by the Telephone Consumer Act of 1991. (For details, see FCC NOTICE at the end of this User's Guide)
3. You may use **\*** to enter a "+" character at the beginning of the ID number to indicate the following digit(s) for your country code.  
**Ex:** +1 201 555 1212 +1 for U.S.A. country code.  
 +81 3 111 2345 +81 for Japan country code.
4. Your Fax Telephone Number must be set as your ID Number because it is required by the Telephone Consumer Act of 1991. (For details, see FCC NOTICE at the end of these Operating Instructions)

# Address Book

## Adding Address Book Dialing Numbers

The Address Book contains Speed dialing numbers. To use this dialing method, you must first store the telephone numbers, or Email addresses using the following procedure. (Up to 200 stations, plus an additional 800 with the optional Hard Disk Drive (DA-HD31) is installed)

To add a Telephone Number, or Email Address, follow the steps below

**1** 

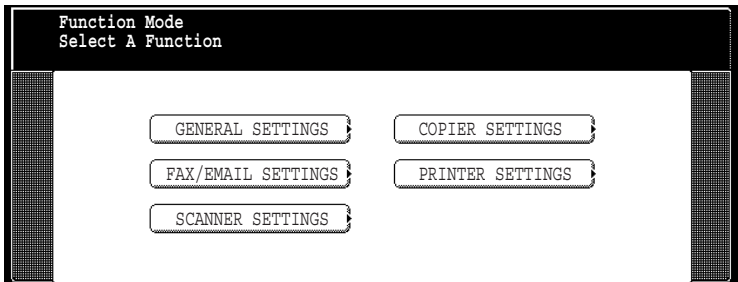

**2**  

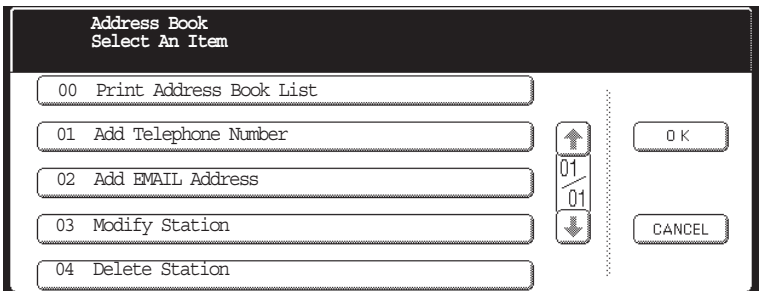

**3** 

or



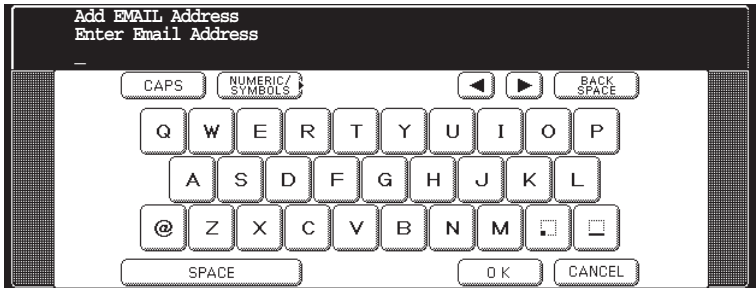
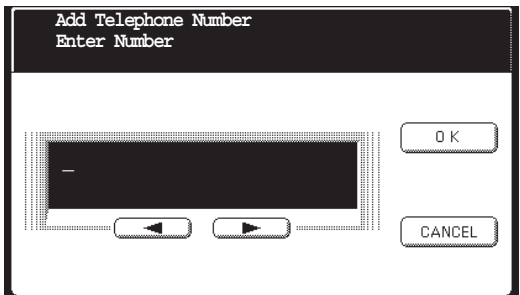



# Adding Address Book Dialing Numbers

**4** Enter a telephone number (Up to 36 digits), or an email address (Up to 60 characters).

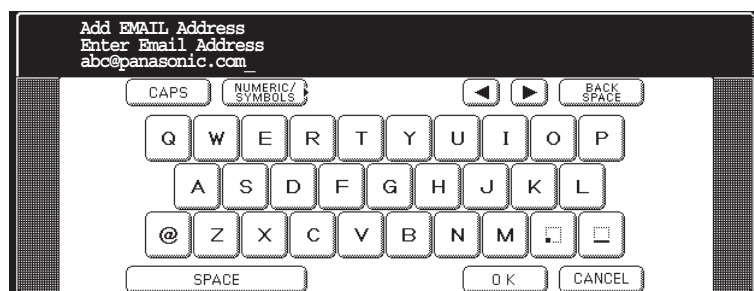
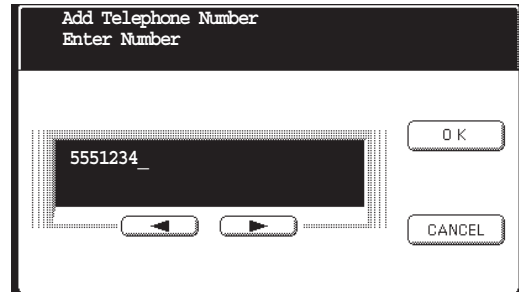

**5**

then enter the station name by using the QWERTY keyboard.  
(Up to 15 characters)

**Ex:** **CAPS** **S** **A** **L** **E** **S** **SPACE** **D** **E** **P** **T**

(As for the rest, it is the same procedure of the add Email address as the Telephone number.)

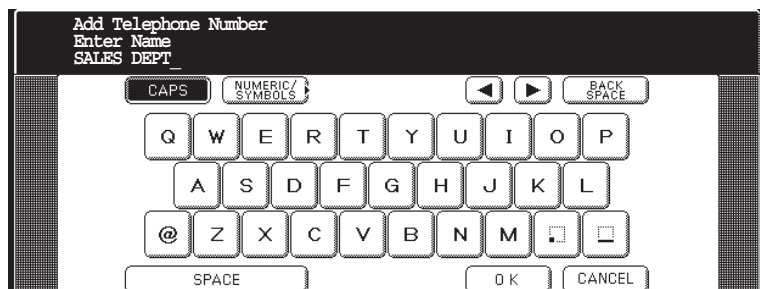

# Address Book

## Adding Address Book Dialing Numbers

6



then enter the key name (Up to 15 characters).  
(By default, the key name is the first 15 characters of the station's name. If you do not want to change it, press **OK**.)

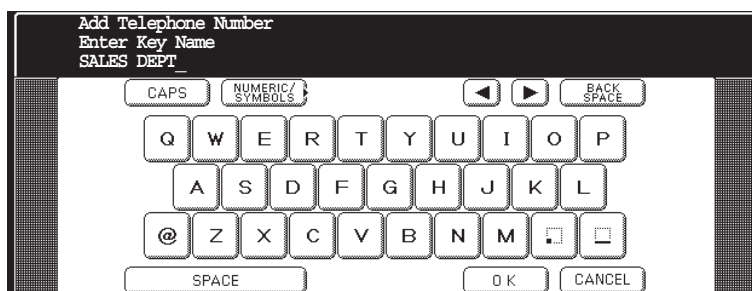

7

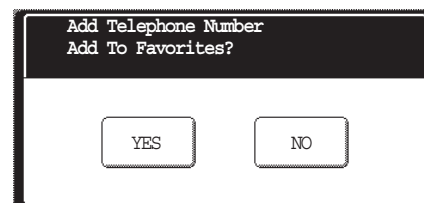

8

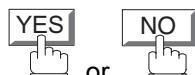

To record another number repeat steps 4 to 8.  
To return to standby, press **STOP**.

## Editing the Address Book

If you have to change, or erase any of the Speed dialing numbers, follow the steps below.

### To change the settings of a Speed dialing number

1

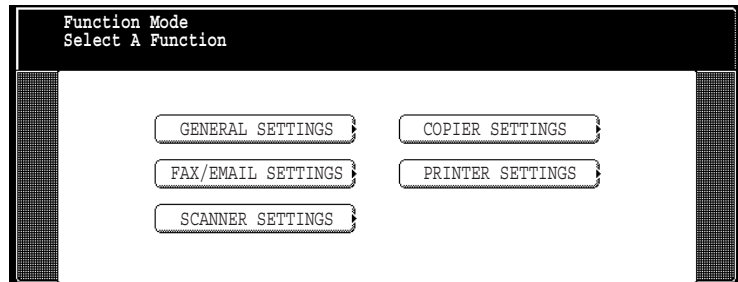

2

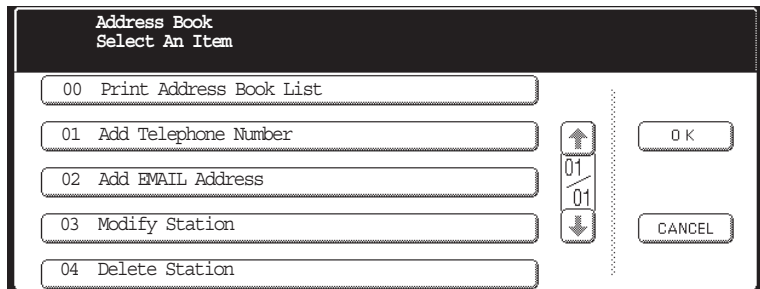

3

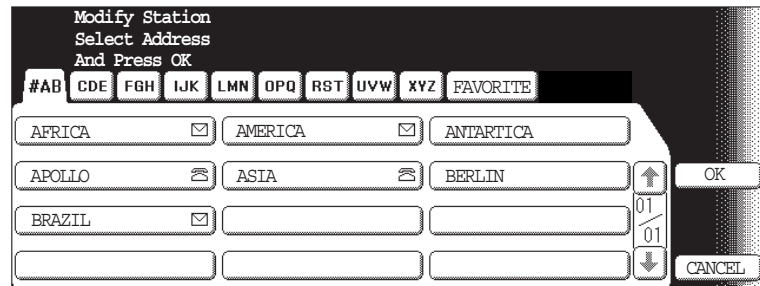

4

Select the station you wish to change.

Ex: PANASONIC

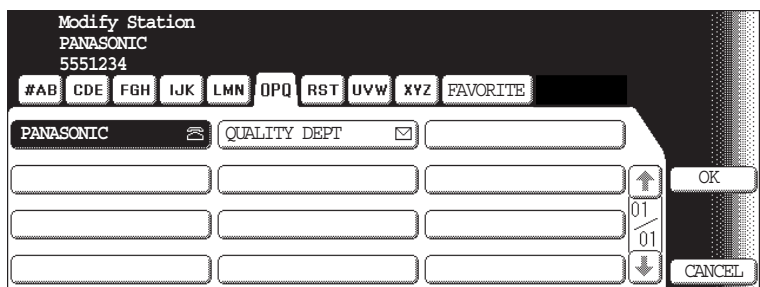

# Address Book

## Editing the Address Book

5

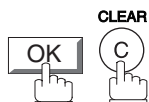

then enter a new telephone number. (See Note 1)  
(Up to 36 digits including pauses, and spaces)

Ex: 9 PAUSE 5 5 5 MONITOR 3 4 5 6

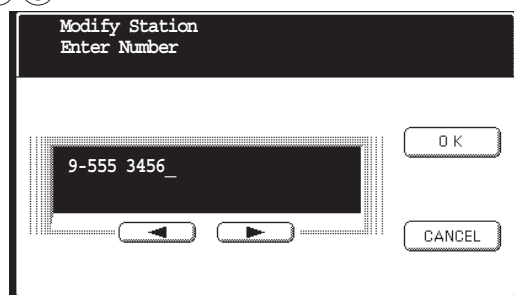

6

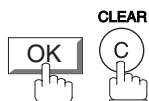

then enter a new station name. (See Note 1)

Ex: CAPS P A N A F A X

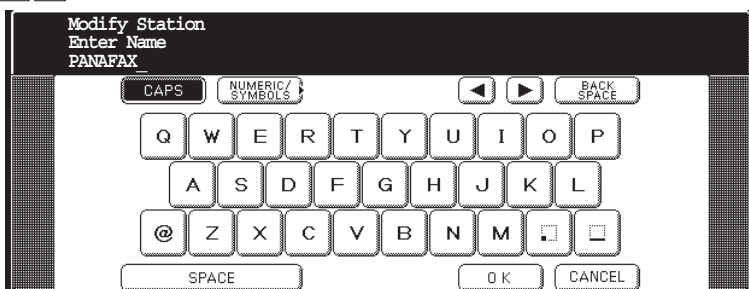

7

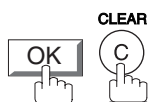

then enter a new key name. (See Note 1)

Ex: CAPS P A N A F A X

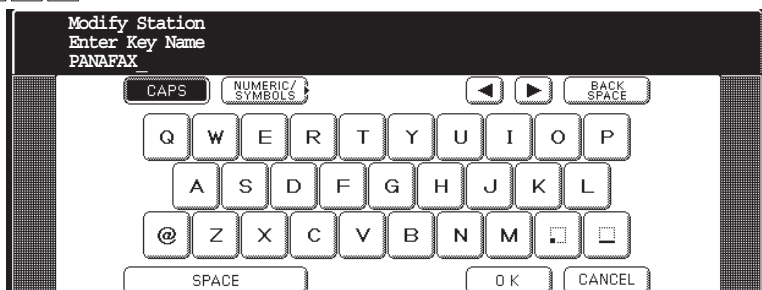

## Editing the Address Book

8

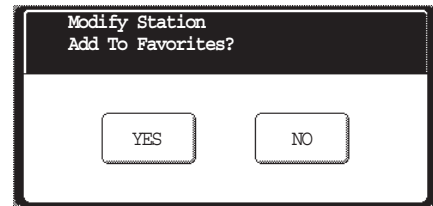

9

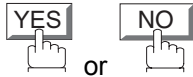

To return to standby, press **STOP**.

### NOTE

1. If you make a mistake, use **◀** or **▶** to move the cursor beyond the incorrect number, press then **CLEAR** re-enter the new number.
2. The Address Book cannot be changed, or erased until the communication has finished. To change, or erase the settings, cancel the communication first by Edit File Mode. (See pages 100 to 102)

# Address Book

## Editing the Address Book

To erase an entry from the Address Book

**1** 

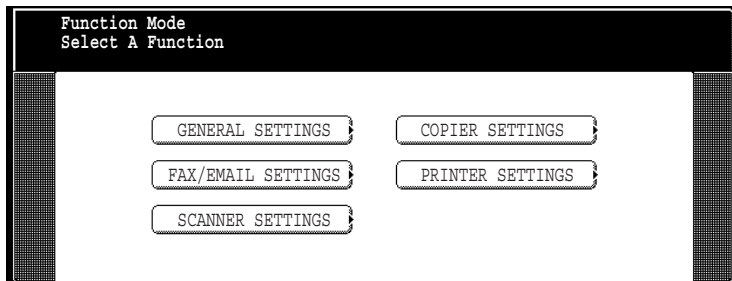

**2**  

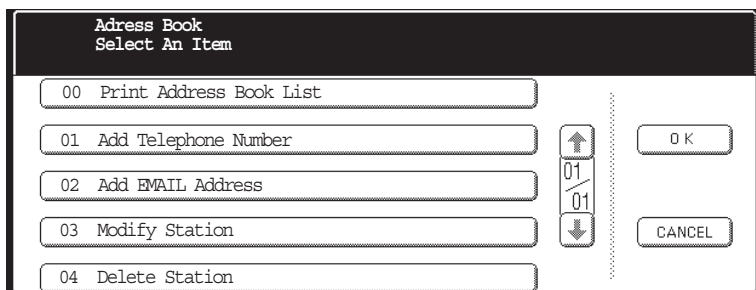

**3** 

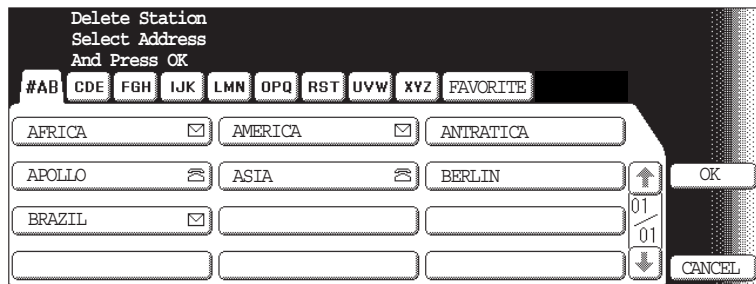

**4** Enter the station you wish to erase.  
Ex: 

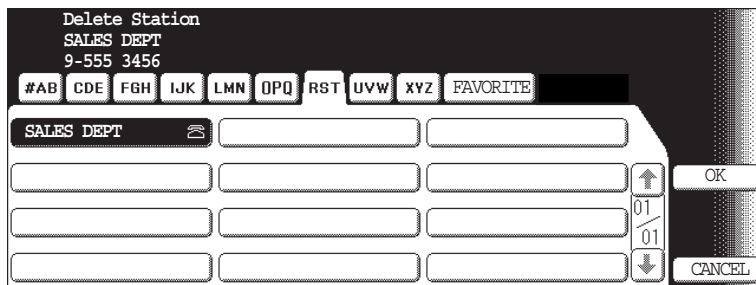

## Editing the Address Book

5

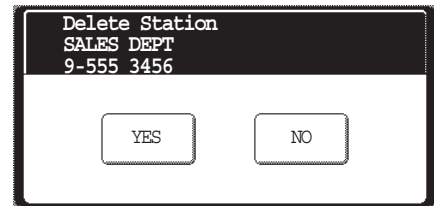

6



To return to standby, press .

### NOTE

1. If the Address Book Station has been used for a communication reservation, the settings cannot be changed, or erased until the communication has finished. To change, or erase the settings, cancel the communication first by Edit File Mode. (See pages 100 to 102)

# Customizing Your Machine

## General Description

Your facsimile machine has a variety of adjustable Fax Parameters. These parameters, listed in the Parameter Table, are preset for you, and do not need to be changed. If you do want to make a change, read the table carefully. Some parameters, such as the Resolution, Contrast, and Verification Stamp parameters, can be temporarily changed by simple key operation just before a transmission is made. When the transmission ends, however, these parameters return to their preset values (Home position). Other parameters can only be changed by the procedure described below.

## Setting the Fax Parameters

1

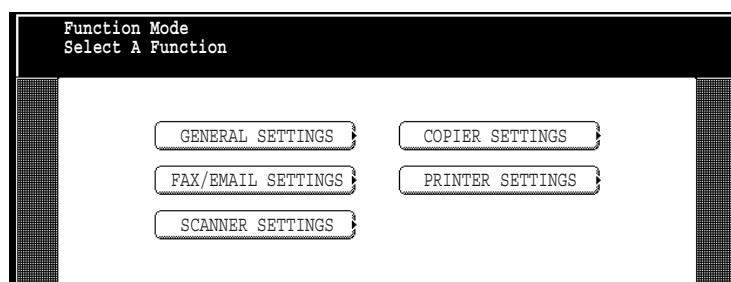

2

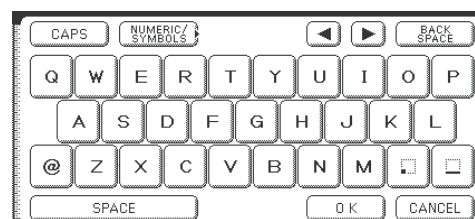

3

Input Key Operator's password, and press **OK**.  
(8 digits: alpha-numeric; alphabet (case-sensitive), numbers, symbols (@,.,\_, and SPACE))

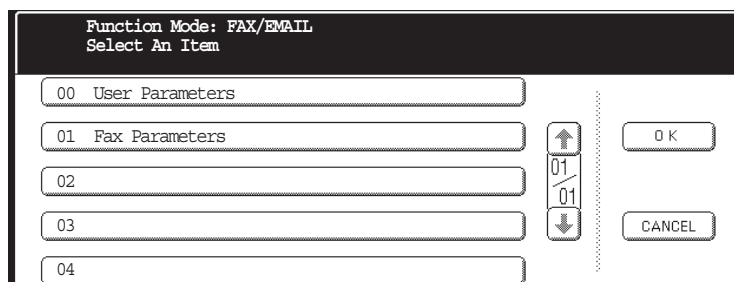



## Setting the Fax Parameters

- 4** Press **[01 Fax Parameters]** **[↑]** or **[↓]** to scroll the display to the desired Fax Parameter.  
(See page 190)

Ex: **[004 Stamp]**

or

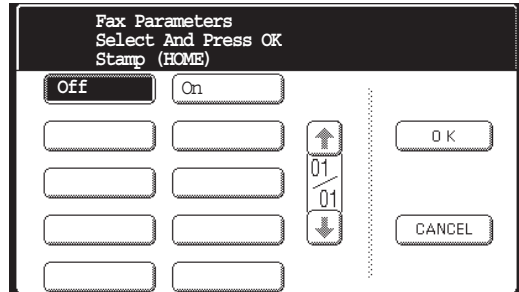

Press **[01 Fax Parameters]** and enter the Fax Parameter number directly from the keypad, and press **[SET]** or **[START]** key.

- 5** Enter the new setting value.

Ex: **[On]**

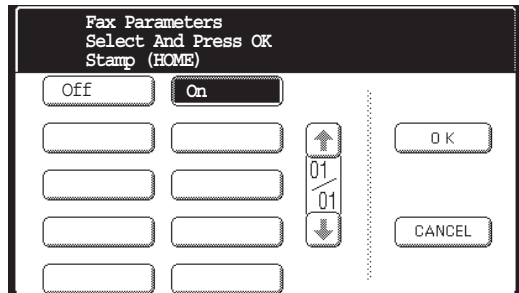

- 6** **[OK]**

To set another parameter, press **[CANCEL]** to return to Step 3, or press **[STOP]** to return to standby.

### NOTE

1. To scroll the Fax Parameters in Step 4, press **[↑]** or **[↓]**.
2. To print out a Fax Parameter List, see page 214.

# Customizing Your Machine

## Fax Parameter Table

\* = Factory default setting

No.	Parameter	Setting	Comments
000	Print Fax Parameter List	Stop	Prints the Fax Parameter List.
		Start	
001	Contrast (HOME)	1 (Lightest)	Setting the home position for the CONTRAST.
		----	
		*4 (Normal)	
		----	
002	Resolution (HOME)	STD	Setting the home position for the RESOLUTION.
		*Fine	
003	Original (HOME)	S-Fine	Setting the home position for the ORIGINAL.
		*Text	
		Txt/Pht	
004	Stamp (HOME)	Photo	Setting the home position for the STAMP. To select the stamp function when document is stored in memory, see Fax Parameter No. 28.
		*Off	
005	Memory (HOME)	On	Setting the home position for the MEMORY.
		*Off	
006	Dialing Method	Off	Selecting the dialing method.
		*On	
007	Header Print	Pulse	Selecting the printing position of the header. <b>Inside</b> : Inside TX copy area. <b>Outside</b> : Outside TX copy area. <b>No Print</b> : Header is not printed.
		*Tone	
		*Inside	
008	Header Format	Outside	Selecting the header format.
		*Logo, ID No.	
009	RCV'D Time Print	From To	Selecting whether the machine prints the received date & time, remote ID, percentage of reduction, and page number on the bottom of each received document.
		*Invalid	
012	Comm. Journal (HOME)	Valid	Selecting the home position of printout mode for COMM. Journal Off/Always/Inc. only. <b>Off</b> : Does not print <b>Always</b> : Always prints <b>Inc. only</b> : Prints only when communication has failed.
		Off	
		Always	
013	Auto JRNL Print	*Inc. only	Selecting whether the machine prints the journal automatically after every 200 transactions.
		Invalid	
		*Valid	

## Fax Parameter Table

\* = Factory default setting

No.	Parameter	Setting	Comments
014	File Acceptance Report	*Invalid	Selecting whether the machine prints the file acceptance journal. If you set this parameter to valid, a journal will print out after any memory communication.
		Valid	
017	Receive Mode	Manual	Setting the reception mode to automatic, or manual.
		*Auto	
022	Substitute Receive	Invalid	Selecting whether the machine receives to memory when the recording paper runs out, toner runs out, or the recording paper is jammed.
		*Valid	
024	Print Reduction	Fixed	Selecting print reduction mode. <b>Fixed</b> : Reduce received document according to setting of Parameter No. 25. <b>Auto</b> : Automatically determines, and reduces the incoming document to print onto the paper loaded in the machine.
		*Auto	
025	Reduction Ratio	70%	Selecting the fixed print reduction ratio from 70% to 100%. This parameter functions only when the fixed print reduction is selected on Fax Parameter No. 24.
		----	
		100%	
026	Polling Password	(----	Setting a 4-digit password for secured polling. (See page 48)
027	Polled File Save	*Invalid	Selecting whether the machine retains the polled document in memory even after the document is polled once.
		Valid	
028	Stamp At Memory XMT	Invalid	Selecting whether the machine stamps the original documents when storing the documents into memory. (Depends on the Stamp setting on the Control Panel)
		*Valid	
031	Incomplete File Save	*Invalid	Selecting whether the machine retains the document in memory if the document is not successfully transmitted.
		Valid	
033	XMT Reduction	Invalid	Selecting whether the machine performs reduction when the transmitting original is wider than the recording paper used at the receiving machine.
		*Valid	
037	Receive to Memory	(----	Enter a 4-digit password for printing the received document(s) in memory by using <b>MODE SETTING</b> <b>SELECT MODE</b> <b>RECEIVE TO MEMORY</b>  When <b>RECEIVE TO MEMORY</b> is set to ON, this parameter is not selectable on the LCD display. (See page 84)
039	PIN Code Access	*None	Selecting the access method (Prefix or Suffix) to dial a number with PIN Code. (See page 87)
		Suffix	
		Prefix	
042	Conf. File Save	*Invalid	Selecting whether the machine saves the confidential polled file even after the file is polled once.
		Valid	

Continued on the next page...

# Customizing Your Machine

## Fax Parameter Table

\* = Factory default setting

No.	Parameter	Setting	Comments
043	Password-Transmit	*Off	Setting a 4-digit XMT-Password, and selecting whether the machine performs, and checks the XMT-Password of the receiving station when transmitting. (See page 77)
		On	
044	Password-Receive	*Off	Setting a 4-digit RCV-Password, and selecting whether the machine performs, and checks the RCV-Password of the transmitting station when receiving. (See page 79)
		On	
046	Select Receive	*Invalid	Selecting whether the machine performs selective reception. (See page 91)
		Valid	
052	Diagnostic Password	(----	Setting the password for Remote Diagnostic Mode. Please ask your Panasonic Authorized Dealer for details.
053	Sub Address Password	(----	Setting a 20-digit password for secured sub-address communication.
054	Fax Forward	*Invalid	Selecting whether the machine performs Fax Forwarding to the specified destination.
		Valid	
056	Cover Sheet (HOME)	*Off	Setting the home position of the Cover Sheet parameter in the Select Mode. (See page 73)
		On	
077	Department Code	*Invalid	Selecting whether the machine performs the Department Code operation. (See page 93)
		Valid	
078	Rotation XMT	Invalid	Selecting whether the machine performs rotation transmission.
		*Valid	
082	Quick Memory XMT	Invalid	Selecting whether the machine performs Quick Memory Transmission. <b>Invalid</b> :Stores all documents into memory first before dialing the telephone number. <b>Valid</b> :Starts dialing the telephone number immediately after storing the first page.
		*Valid	
086	Ringer Volume	Off	Setting the home position of the ringer volume when your machine receives a call.
		* Soft	
		Loud	
089	List Output Tray	*Upper	Selecting the Output Tray home position for List printout. Upper :The List printout exits to the Upper Output Tray. Bottom :The List printout exits to the Bottom Output Tray.
		Bottom	
		Inner 1	
		Inner 2	
		Outer	
095	Duplex Print	*Invalid	Selecting whether the machine performs duplex print when Letter/A4 originals are received.
		Valid	

## Fax Parameter Table

\* = Factory default setting

No.	Parameter	Setting	Comments
097	Special Tray No.1 - 3	*None	Select up to 3 Special Trays that will not be used for printing received faxes. One Tray must always be available for receiving Faxes. (You can specify one Tray (1 ~ 3) for each selection No. 1, No. 2, and/or No 3.)
		Tray 1	
		Tray 2	
		Tray 3	
099	Memory Size (Flash Memory)	-	Displays the amount of base, and optional memory installed. (Base Memory + Optional Memory)
118	FAX Function Detect	Invalid	Setting the number of digits for detecting a Fax Telephone number. Upon detecting the specified number of digits, the machine will automatically switch to the FAX Mode when it is in the Copier Mode.
		4-Digits	
		5-Digits	
		*6-Digits	
		7-Digits	
		8-Digits	
131	Job Tracking	*None	Selecting Job Tracking function. <b>None</b> : Does not function. <b>TX</b> : Valid only in sending. <b>Rx</b> : Valid only in receiving. <b>Tx&amp;Rx</b> : Valid both in sending, and receiving. <b>Note:</b> • Before performing this setup, you first need to set the FAX FORWARD (Fax Parameter No. 054) parameter to Invalid. • Copy, Fax, Scanner, or Printer in the User Authentication (General setting - Key Operator Mode No. 050) need to set "Valid".
		Tx	
		Rx	
		Tx&Rx	
132	Via Fax Server Fax Server Mail Address	*Invalid	Enter the Email address of the RightFax server when you enable the RightFax function for the first time. <b>Note:</b> • Before performing this setup, you first need to set the User Parameter setting (General setting - Key Operator Mode No. 000) in the General settings (For Key Operator) and, FAX/ EMAIL Settings (For Key Operator).
		Valid	
140	LAN RLY XMT Request	*Invalid	Selecting whether the machine performs LAN Relay XMT Request.
		Valid	
141	LAN XMT Reduce	*Invalid	Selecting whether to automatically reduce from LEDGER / B4 to A4, when LEDGER / B4 documents are transmitted via LAN. <b>Invalid</b> :No reduction <b>Valid</b> :Automatic reduction from LEDGER / B4 to A4
		Valid	
142	Relay XMT	Invalid	Selecting whether the machine accepts, and performs G3 relayed transmission. (Relay Station Functions)
		*Valid	
143	Relay XMT Report	Off	Setting how the COMM. Journal for relayed transmission is sent to the originator. <b>Off</b> : Don't send. <b>Always</b> : Always send. <b>Inc. only</b> : Send only if communication has failed.
		*Always	
		Inc. only	

# Customizing Your Machine

## Fax Parameter Table

\* = Factory default setting

No.	Parameter	Setting	Comments
144	EMAIL Character Set	Japanese	Selecting the Character Set when receiving, or sending email text.
		*English	
145	Sender Selection	*Invalid	Selecting a pre-programmed sender's name, and email address before each transmission.
		Valid	
146	POP Timer	0 to 60 min.	Setting the time interval for the machine to check for email on the POP Server. (0 = Does not check the POP Server for email.)
147	Auto POP Receive	Invalid	Selecting whether the machine automatically downloads an email from the POP Server.
		*Valid	
148	Del POP Receive Mail	Invalid	Selecting whether the email will be deleted automatically after retrieval from the POP Server.
		*Valid	
149	Del POP Error Mail	*Invalid	Selecting whether to delete the email that includes an incompatible file attachment from the POP Server.
		Valid	
150	Ifax Return Receipt	Invalid	Selecting whether to send a return receipt when receiving from another Panasonic Internet Fax.
		*Valid	
151	EMAIL Header FMT	All	Selecting the header information to print when an email is received. (Normally used for Troubleshooting. It shows the path of the email transmission before arriving at your machine.)
		S/F/T	
		Off	
152	Sub-Addr Routing	*Invalid	Selecting whether to automatically route a received fax, or email using ITU-T sub-address.
		Valid	
153	TSI Routing	*Invalid	Selecting whether to route a received fax to a telephone number, or an email address preprogrammed in the Address Book using the originating fax's Numeric ID (TSI frame information).
		Valid	
154	Route Header FMT	*Originator	Selecting the type of email header to be included in the "From" field of each routed fax. <b>Originator</b> : The originating fax machine's TSI will appear in the "From" field of the routed email. <b>Relay Station</b> : The routing station's email address will appear in the "From" field of the routed email.
		Relay Station	
155	Print Routed Doc	*Inc. only	Selecting whether a received fax to be routed is always printed, or only when the routing operation fails.
		Always	
156	Print Forward Doc	*Inc. only	Selecting whether a memory received fax, or email to be forwarded is always printed, or only when forwarding is incomplete.
		Always	
157	Transaction JRNL	*Invalid	Selecting whether the machine sends a transaction journal to the pre-programmed email address.
		Valid	

## Fax Parameter Table

\* = Factory default setting

No.	Parameter	Setting	Comments
158	PC Remote Update	*Invalid	Selecting whether the machine will accept commands from an email application, to: (a) Program the Internet Parameters (b) Program the Address Book (c) Allow retrieval of the Journal
		Valid	
160	Default Domain	Invalid	Selecting whether the machine accepts to insert the Default Domain when entering Manual Number Dialing.
		*Valid	
162	TIFF Viewer URL	None	Selecting whether to include the URL address in the email message body.
		*English	
		English+ Japanese	
163	Routing Header	*Off	Selecting whether to add the Header Print information of the Routing Station on the top edge of each routed page.
		On	
164	Ifax XMT Header (Email only)	*Included	Selecting whether to include the header when sending a document to an addressee in the same Domain as specified in the Default Domain parameter. (This is useful when using the machine to scan documents back to your PC)  <b>Note:</b> When sending to a Domain other than as specified in the Default Domain parameter, the header will be included regardless of the selection.
		Not Inc	
170	SMTP Authentication	*Invalid	If you transmit to the SMTP server, user name, and password are used for authentication. Selecting "Valid" allows you to set up the user name, and password.
		Valid	
171	POP Before SMTP	*Invalid	If you transmit to the SMTP server, POP user name, and POP password are used for authentication.
		Valid	
172	Direct IFax XMT	*Invalid	Selecting whether to be prompted during Address Book registration if the station you are programming is to receive Internet Fax directly without going through a Mail Server.
		Valid	
173	Delivery Notice	*Off	Setting the home position of whether to request a Message Disposition Notification (MDN) for a delivery processing confirmation indicating that the message (email) was read, when sending an email/Internet Fax. Delivery Notice key will appear by pressing <b>[MODE SETTING] [SELECT MODE]</b> .
		On	
174	APOP Authentication	*Invalid	This parameter allows you to encrypt the protocol for the POP password security when connecting with the POP server.
		Valid	
177	XMT File Type	*TIFF	Selecting whether the document(s) are converted into a TIFF-F, or PDF format when sending an Internet Fax. (The setting can be temporarily changed when sending an Internet Fax.)  <b>Note:</b> PDF file is only available if sending the document(s) to a PC (Network Scanning).
		PDF	

Continued on the next page...

# Customizing Your Machine

## Fax Parameter Table

\* = Factory default setting

No.	Parameter	Setting	Comments
182	Send Comm. JNL	*Print	Selecting whether the Communication Journal is printed, emailed, or both. <b>Print</b> : Prints <b>Email</b> : Emailed to the address selected in the Sender Selection (See page 145). <b>Both</b> : Prints and Emailed
		Email	
		Both	

**NOTE**

1. The factory standard, and the current settings are also shown on the Fax Parameter List printout. To print the Fax Parameter List, see page 214.



# Setting Up IPv6

## General Description

This chapter describes the procedures for setting up the IPv6

**Note:**

Although the address setting of "IPv6" can choose an automatic setting or manual setting, it recommends an automatic setting.

No.	Modes	Function	Initial Setting
27	DNS Server Address	Set up IPv6 primary server address and IPv6 secondary DNS server address. * Set up "HOST NAME", "DOMAIN NAME" and IPv6 sever address in the same screen. ● No, Yes	Yes
60	IPv6	Set the IPv6. ● Off, On	Off
61	IPv6 Link-Local Address	Address used by communication in the same link. It will be generated automatically.	-
62	IPv6 Auto Configuration	Based on the information from a router, IPv6 address and IPv6 Default Router address are generated automatically. ● Off, On	On
63	IPv6 Address	Set up IPv6 address. It is possible to be set up when IPv6 Auto Configuration is Off.	-
64	IPv6 Default Router	Sets up IPv6 Default Router address. It is possible to be setup when IPv6 Auto Configuration is Off.	-

\* When Functions No. 27 and No. 60 to 64 are set, cycle the power by turning the Power Switch on the Left side of the machine OFF and ON.

### Functional restriction item

Although all the functions of this machine can be used in the dual network environment of IPv4 and IPv6, a function except PC Print and Internet Fax Features cannot be used in the network environment of only IPv6.

■ When you use the following functions, please use it in the network environment of IPv4.

- To set Automatic Reduction mode.
  - Network Scanner
  - Global Search
  - Internet Fax function
  - User Authentication
  - Tandem / Remote Copy
- Standard attachment software
  - Fax Driver
  - Panafax Desktop
  - Device Explorer / Device Monitor
  - Network Configuration and Address Book Editor
  - Job Status Utility
- Optional software
  - Accounting Software
  - Document Distribution System
  - DD Server Software

#### NOTE

1. For IPv6 address, contact your network administrator

\* This machine corresponds to IPv6 (Internet Protocol Version 6). IPv6 is the new Internet Protocol developed to deal with the problem by former style (IPv4) like IP address shortage and others. It is possible to set up almost infinite address by using 128 bit IP address. Therefore, it is thought to be possible to construct the Internet environment used new function like interactive Internet communication and others that was difficult in former IPv4 style.

# Setting Up IPv6

## General Description

### Preparation of a setup

Arrangement and explanation of an IPv6 address input key

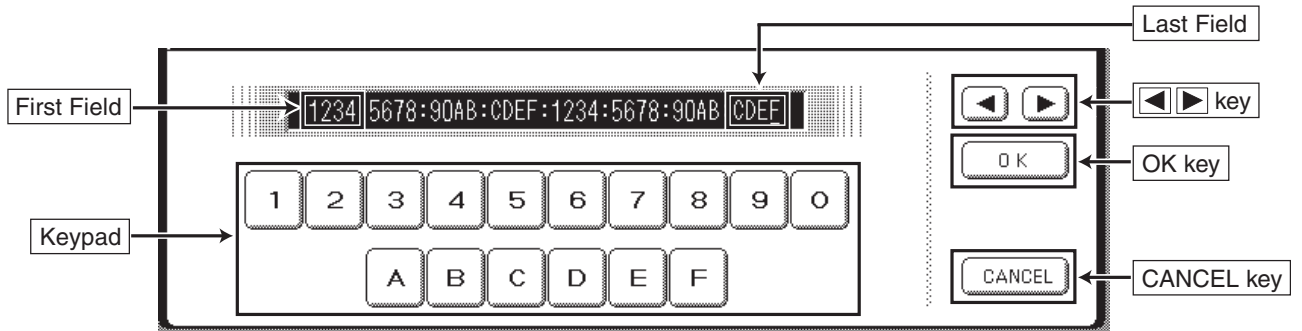

<LCD panel key board screen>

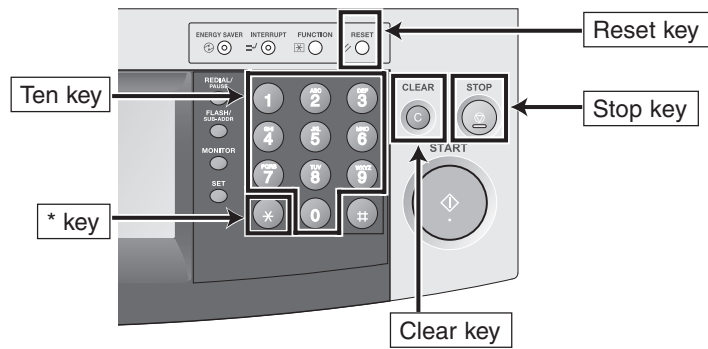

<Arrangement of an operation panel key>

Key name	Function
Field	Display 4 characters address divided by [ : ] of IPv6. Call [First Field] [Second Field] from the left ... [Last Field] for the last.
Ten key	An IP address is inputted. Since it sets up by a hexadecimal number, 1 - F can be inputted. Either a panel screen or a control panel can be inputted.
◀ ▶ key	Move the cursor in the input field. Press ◀ key, and then the cursor moves to the left fields. If it is in the [First Field], it moves to the [Last Field]. Press ▶ key, and then the cursor moves to the right fields. If it is in the [Last Field], it moves to the [First Field].
OK key	The input content is fixed, and then advances to the following screen.
CANCEL key	Cancel the input content, and then returns to previous screen.
* key	Move the cursor to the right field. If it is on the [Last Field], it moves to the [First Field].
Reset key	Return to the start screen.
Clear key	Delete a letter on the cursor in the Field. If all the indicated letters are deleted, only the cursor [ _ ] will be indicated.
Stop key	Return to the start screen.

## IPv6 Address

### Setting the IPv6 Address

The setting method of the IPv6 address is explained.

A setup of IPv6 is performed by FUNCTION MODE on a panel screen.

Setting Item

- IPv6
- IPv6 Auto Configuration
- IPv6 Address
- IPv6 Default Router

**1**

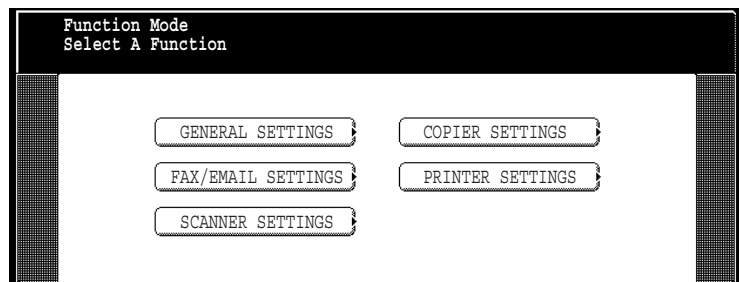

**2**

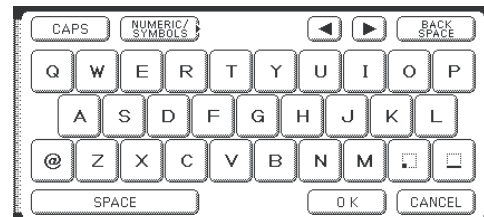

**3**

Input Key Operator's password, and press **OK**.

(8 digits: alpha-numeric; alphabet (case-sensitive), numbers, symbols (@,.,\_, and SPACE))



x12

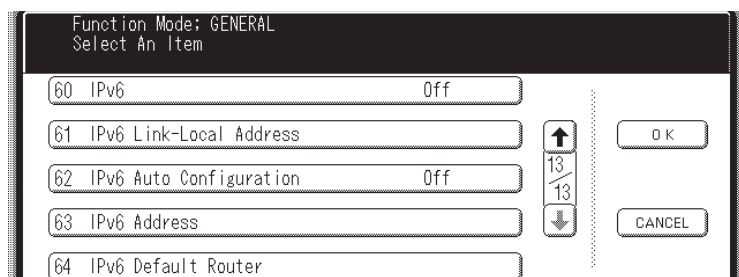

**4**

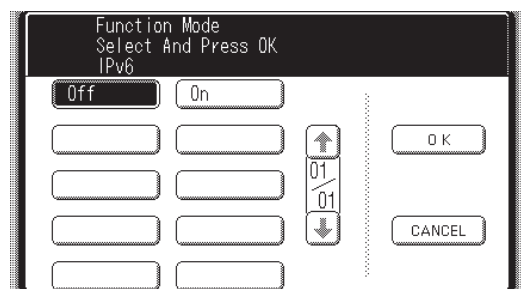

Continued on the next page...

# Setting Up IPv6

## IPv6 Address

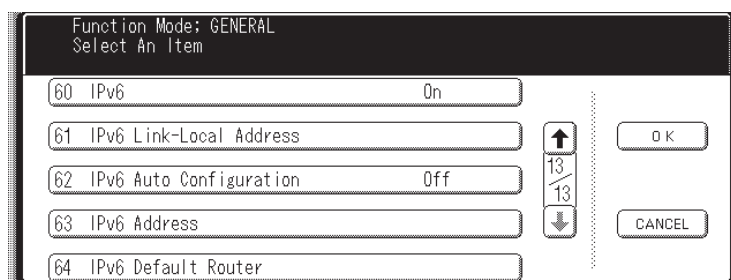
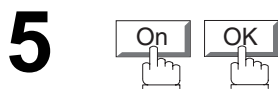

IPv6 will become effective if  On is chosen.

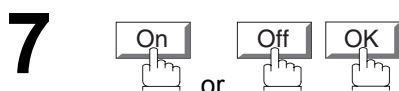
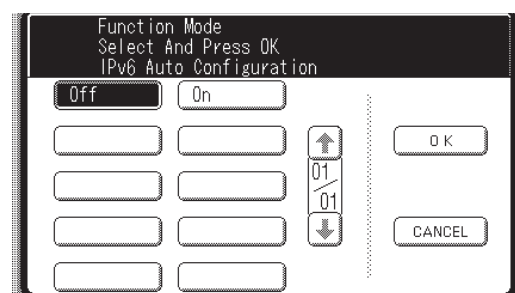
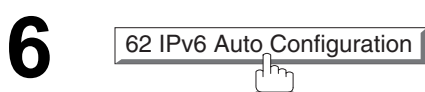

When  On is chosen, IPv6 address and IPv6 Default Router address is set automatically.

When  Off is chosen, IPv6 address IPv6 Default Router address is set up manually.

Ex:  On

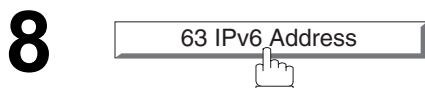
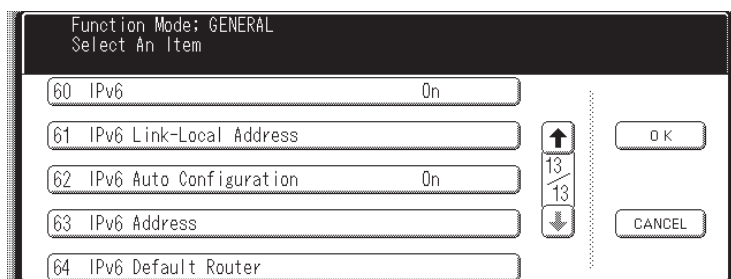

**9a** Ex: In case  62 IPv6 Auto Configuration is  On .  
IPv6 Address will be indicated.

or

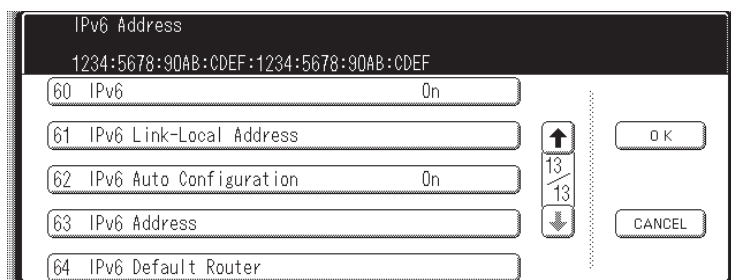

## IPv6 Address

**9b** Ex: In case  IPv6 Auto Configuration is  Off .  
Input the IPv6 address.

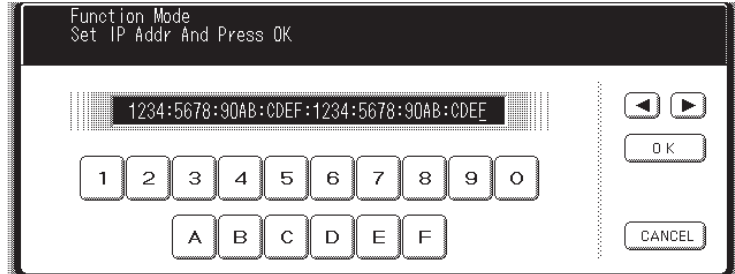

**10**

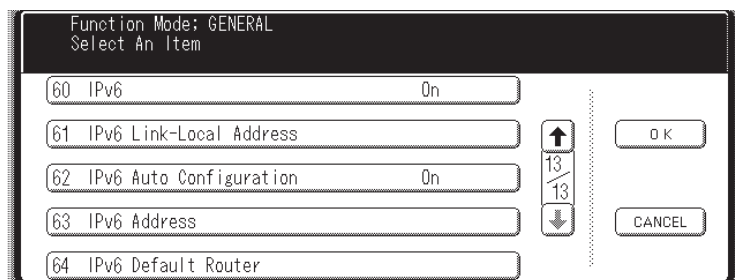

**11**  64 IPv6 Default Router

**12a** Ex: In case  IPv6 Auto Configuration is  On .  
IPv6 Default Router Address will be indicated.

or

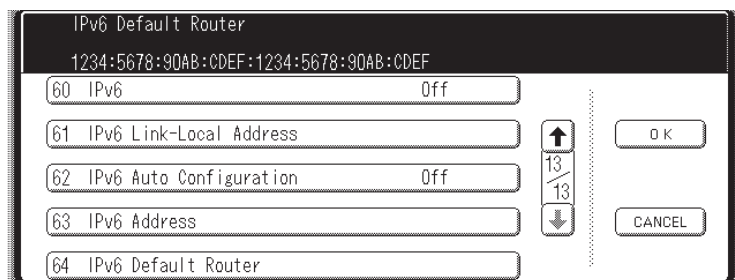

**12b** Ex: In case  IPv6 Auto Configuration is  Off .  
Input the IPv6 Default Router address.

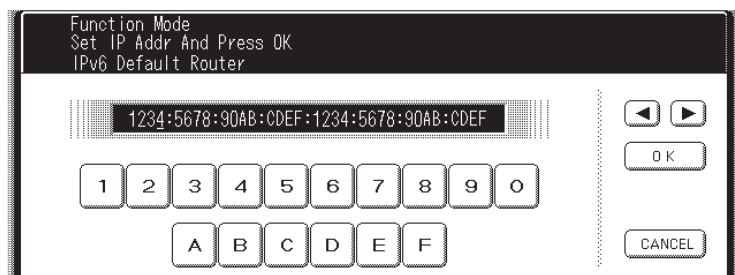

## Setting Up IPv6

### IPv6 Address

**13** 

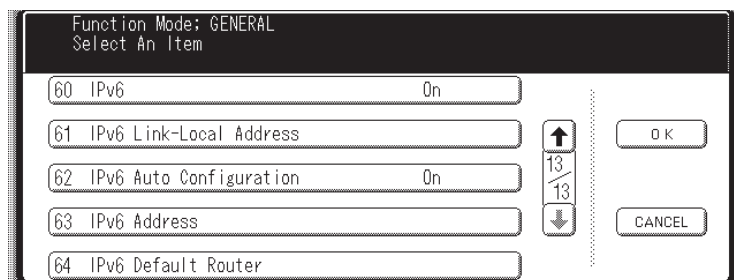

**14** After completing the setup, cycle the power by turning the Power Switch on the Left side of the machine OFF and ON.

**NOTE**

1 *Link-Local Address will be generated automatically.*

## DNS Server Address

### Setting the DNS Server Address

DNS Server Address is set up about the IPv6 Address.  
DNS Server Address setting screen

No.	Function
①	HOST NAME
②	DOMAIN NAME
③	1. IPv4 Primary DNS server address 2. IPv4 Secondly DNS server address
④	1. IPv6 Primary DNS server address 2. IPv6 Secondly DNS server address

### Setting up the DNS Server Address

**1** FUNCTION

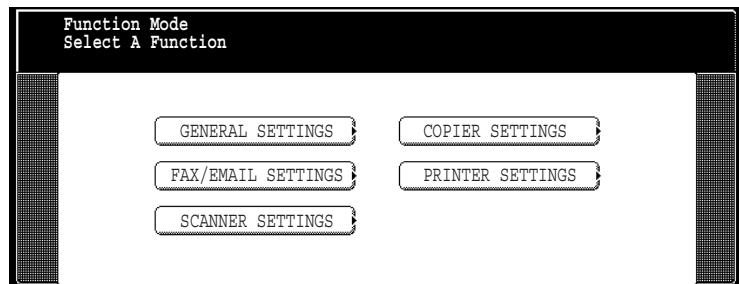

**2** GENERAL SETTINGS 09 Key Operator Mode

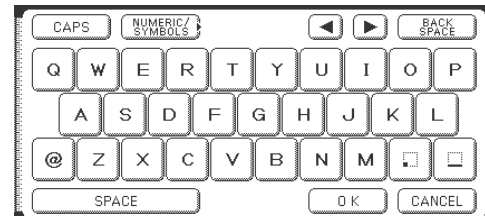

**3** Input Key Operator's password, and press **[OK]**.  
(8 digits: alpha-numeric; alphabet (case-sensitive), numbers, symbols (@,..,\_and SPACE))

x5  
**27 DNS Server Address**

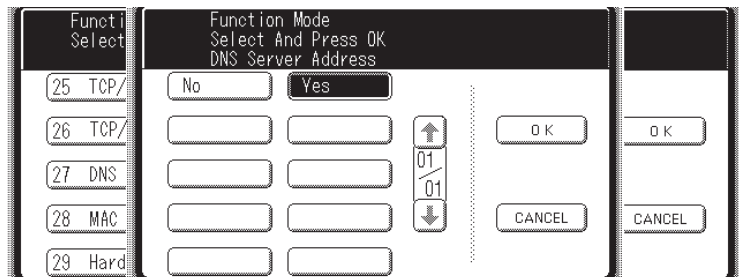

# Setting Up IPv6

## DNS Server Address

4

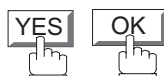

Selection of **NO** will forbid Internet Fax by IPv6.

5



IPv6 DNS server address setting

6



The IPv6 address will be indicated.

7

After completing the setup, cycle the power by turning the Power Switch on the Left side of the machine OFF and ON.

### NOTE

- 1 Please refer to the Operating Instructions for Setting Up about the setting of "HOST NAME", "DOMAIN NAME", "IPv4".
- 2 If IPv4 DNS server address is set up, IPv4 will be connected preferentially.



# Journals and Lists

## General Description

To help you maintain records of the documents you sent, and received, as well as lists of the numbers you record, your facsimile machine is equipped to print the following journals, and lists: Transaction Journal, Individual Transmission Journal, Communication Journal, Address Book List, Program List, Fax Parameter List, File List.

## Transaction Journal

The "Journal" is a record of the last 200 transactions (a transaction is recorded each time you send, or receive a document). It is printed out automatically after every 200 transactions (see Note 1), or you can print, or view it manually by using the following procedure:

Make sure that the FAX/EMAIL lamp is ON. If not, press  to select the "FAX/EMAIL" mode.

- 1**  

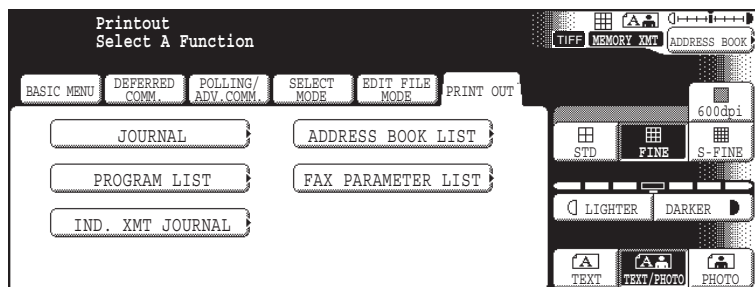

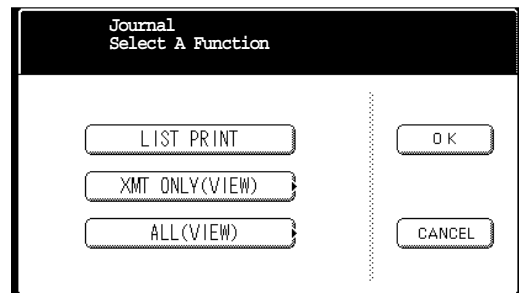

- 2** 



- 3a**  to print a Journal

- 3b**  to view transmission transactions only

- 3c**  to view all transactions

You can view the transactions in the journal by pressing ◀ or ▶. Press  to return to standby.

Continued on the next page...

# Journals and Lists

## Transaction Journal

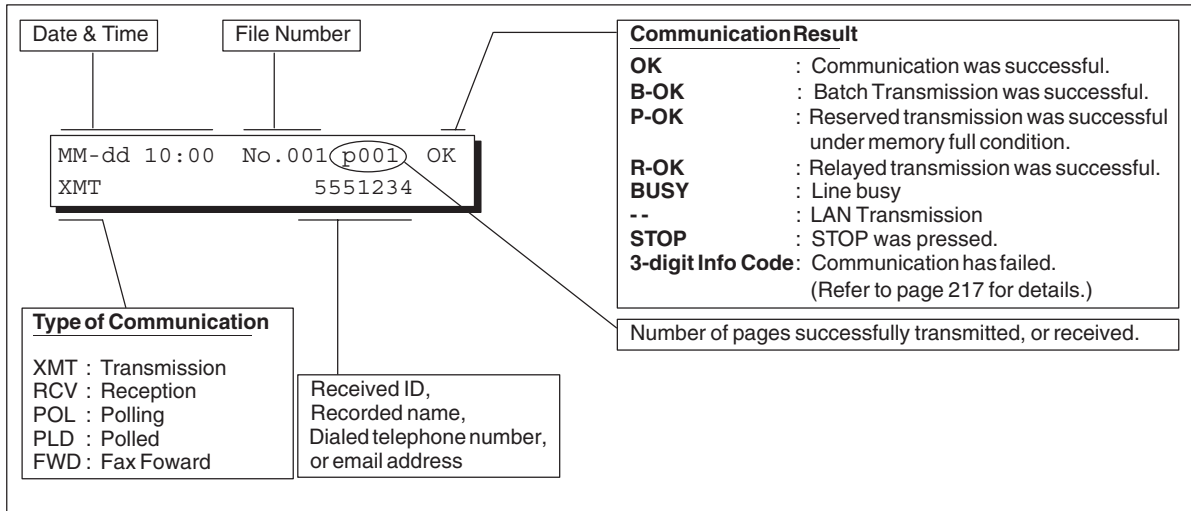

### NOTE

1. If you wish to disable the automatic printing of the Transaction Journal, change the setting of Fax Parameter No. 13 to "Invalid". (See page 190)

## Transaction Journal

### Sample Transaction Journal

***** -JOURNAL- *****													
							(1)	(2)					
							DATE	MMM-dd-yyyy	*****	TIME	15:00	*****	p.01
(3)	(4)	(5)	(6)	(7)	(8)	(9)	(10)	(11)	(12)				
NO.	COMM.	PAGES	FILE	DURATION	X/R	IDENTIFICATION	DATE	TIME	DIAGNOSTIC				
01	OK	001/001	149	00:00:52	XMT	☎ 214	MMM-dd	20:04	C8444B0577000				
02	--	001/001	151	00:00:02	XMT	TEST	MMM-dd	20:07	01 STN(S) LAN				
03	--	003/003	153	00:00:20	XMT	fax@nwfax1	MMM-dd	20:09	01 STN(S) LAN				
04	OK	003	154	00:00:21	RCV	fax@panasonic.com	MMM-dd	20:10	LAN				
05	OK	001	155	00:00:19	XMT	☎ 215	MMM-dd	20:11	C0542B0577000				
06	634	000/003	156	00:00:00	XMT	☎ 216	MMM-dd	20:14	0800420000000				
07	408	*003		00:02:14	XMT	☎ 217	MMM-dd	21:17	0040440A30080				
<p style="text-align: center;">} } } } }</p>													
49	OK	000/001	159	00:00:07	XMT	TEL XMT	MMM-dd	20:18	CA40462000000				
50	OK	001/001	160	00:00:16	XMT	TEL XMT	MMM-dd	20:19	C8444B0577000				
<< CONTINUE >>													
(13)													
-PANASONIC													
***** DP-xxxx ***** -HEAD OFFICE - ***** - 201 555 1212- *****													
(15)						(14)							

***** -JOURNAL- *****													
							(1)	(2)					
							DATE	MMM-dd-yyyy	*****	TIME	15:00	*****	p.04
(3)	(4)	(5)	(6)	(7)	(8)	(9)	(10)	(11)	(12)				
NO.	COMM.	PAGES	FILE	DURATION	X/R	IDENTIFICATION	DATE	TIME	DIAGNOSTIC				
151	OK	001/001	229	00:00:48	XMT	PANAFAX	MMM-dd	22:04	C8444B0577000				
152	--	001/001	230	00:00:01	XMT	PANASONIC	MMM-dd	23:07	01 STN(S) LAN				
153	--	003/003	231	00:00:12	XMT	fax@nwfax1	MMM-dd	23:09	01 STN(S) LAN				
154	OK	003	231	00:00:14	RCV	fax@panasonic.com	MMM-dd	24:10	LAN				
<p style="text-align: center;">} } } }</p>													
200	OK	000/001	332	00:01:10	XMT	AAAAAA	MMM-dd	23:19	C8444B0577000				
(13)													
-PANASONIC													
***** DP-xxxx ***** -HEAD OFFICE - ***** - 201 555 1212- *****													
(15)						(14)							

Continued on the next page...

### NOTE

1. Email transmission sent to multiple locations is recorded as a single transaction on the Journal.

# Journals and Lists

## Transaction Journal

### Explanation of Contents

- |  |  |
|--|--|
| (1) Printout date                            |  |
| (2) Printout time                            |  |
| (3) Journal number                           |  |
| (4) Communication result                     | "OK" indicates that the communication was successful.<br>"BUSY" indicates that the communication has failed because of busy line.<br>"STOP" indicates that <b>STOP</b> was pressed during communication.<br>"P-OK" indicates that memory overflow occurred while storing the documents into memory for transmission but successfully stored document(s) was sent.<br>"R-OK" indicates that the Relayed XMT was successful.<br>"B-OK" indicates that the Batch Transmission was successful.<br>"- -" indicates LAN transmission.<br>"3-digit Info Code" (See page 217) indicates that the communication has failed. |
| (5) Number of pages transmitted, or received | The 3-digit number is the number of pages successfully transmitted, or received.<br>When the documents are stored into memory, two 3-digit numbers will appear. The first 3-digit number represents the number of pages successfully transmitted. The second 3-digit number represents the total number of pages that were attempted to be transmitted.<br>Asterisk "*" indicates that the quality of some received copies was poor.   |
| (6) File number                              | 001 to 999 (If the communication is stored into memory, a file number is assigned for each communication.)   |
| (7) Duration of communication                |  |
| (8) Type of communication                    | "XMT" means Transmission<br>"RCV" means Reception<br>"POL" means Polling<br>"PLD" means Polled<br>"FWD" means Fax Forward  |
| (9) Remote station identification            | Name : Recorded name in the Address Book, or remote station's Character ID.<br>☎ number : Dialed telephone number. (PIN code will not be shown)<br>Number : Remote station's ID number.<br>Email address   |
| (10) Communication date                      |  |
| (11) Communication Start time                |  |
| (12) Diagnostic                              | For service personnel only   |
| (13) Own LOGO                                | Up to 25 characters  |
| (14) Own ID number                           | Up to 20 digits  |
| (15) Own Character ID                        | Up to 16 characters  |

## Communication Journal (COMM. JOURNAL)

The Communication Journal (COMM. JOURNAL) lets you verify whether the transmission, or polling was successful. You may select the printout condition (Off/Always/Inc. only) in Fax Parameter No. 12.

### Sample COMM. JOURNAL

\*\*\*\*\* - COMM. JOURNAL - \*\*\*\*\* DATE MMM-dd-yyyy \*\*\*\* TIME 15:00 \*\*\*\* p.01

(1) MODE = MEMORY TRANSMISSION (2) START=MMM-dd 14:50 (3) END=MMM-dd 15:00

FILE NO.= 050 (4)

(5) STN NO.	(6) COMM.	(7) KEY NAME	(8) STATION NAME/EMAIL ADDRESS/TELEPHONE NO.	(9) PAGES	(10) DURATION
001	OK	[SERVICE ]	SERVICE DEPT.	001/001	00:01:30
002	OK	[SALES DEPT]	SALES DEPT.	001/001	00:01:25
003	407	[ACCOUNTING]	ACCOUNTING DEPT.	000/001	00:01:45
004	BUSY	☎	021 111 1234	000/001	00:00:00

- PANASONIC -

\*\*\*\*\* DP-xxxx \*\*\*\*\* - HEAD OFFICE - \*\*\*\*\* - 201 555 1212 - \*\*\*\*\*

### THE SLEREXE COMPANY LIMITED

SAPORS LANE . BOOLE . DORSET . BH25 8 ER

TELEPHONE BOOLE (945 13) 51617 - TELEX 123456

Our Ref. 350/PJC/EAC

18th January, 1972.

Dr. P.N. Cundall,  
Mining Surveys Ltd

... variations of print density ...  
cause the photocell to generate an analogous electrical video signal.  
This signal is used to modulate a carrier, which is transmitted to a  
remote destination over a radio or cable communications link.

At the remote terminal, demodulation reconstructs the video  
signal, which is used to modulate the density of print produced by a  
printing device. This device is scanning in a raster scan synchronised  
with that at the transmitting terminal. As a result, a facsimile  
copy of the subject document is produced.

Probably you have uses for this facility in your organisation.

Yours sincerely,

*Phil.*

P.J. CROSS  
Group Leader - Facsimile Research

# Journals and Lists

## Communication Journal (COMM. JOURNAL)

### Explanation of Contents

- (1) Indication of communication mode
- (2) Start time of communication
- (3) End time of communication
- (4) File number  
001 to 999 (When the communication is stored into memory, a file number is assigned for each communication.)
- (5) Station number  
Sequential number of the Stations.
- (6) Communication result  
"OK" indicates that the communication was successful.  
"BUSY" indicates that the communication has failed because of busy line.  
"STOP" indicates that **STOP** was pressed during communication.  
"P-OK" indicates that memory overflow occurred while storing the documents into memory for transmission but successfully stored document(s) was sent.  
"B-OK" indicates that the Batch Transmission was successful.  
"R-OK" indicates that the Relayed XMT was successful.  
"- -" indicates LAN transmission.  
"3-digit Info Code" (See page 217) indicates that the communication has failed. In this case, the machine will print the attached report with first page of your document as shown on the previous page.
- (7) Key name or ☎ mark  
☎ mark indicates dialed by direct number dial.
- (8) Recorded name in the Address Book, direct dialing number, or email address
- (9) Number of pages transmitted, or received  
The 3-digit number is the number of pages successfully transmitted, or received.  
When the documents are stored into memory, two 3-digit numbers will appear.  
The first 3-digit number represents the number of pages successfully transmitted.  
The second 3-digit number represents the total number of pages that were attempted to be transmitted.
- (10) Duration of Communication

## Address Book List

To print a Address Book List of the telephone numbers, and email addresses you have stored.

Make sure that the FAX/EMAIL lamp is ON. If not, press  to select the "FAX/EMAIL" mode.

1

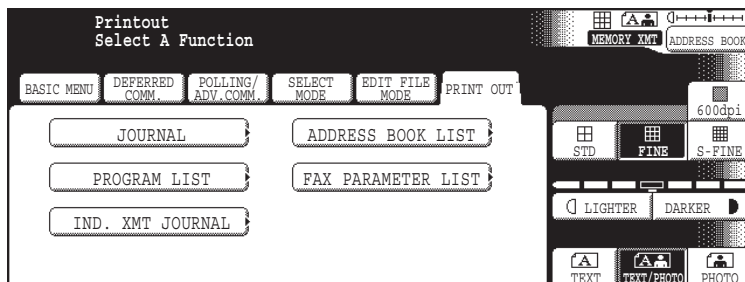

2



Continued on the next page...

# Journals and Lists

## Address Book List

### Sample Address Book List

```

***** -ADDRESS BOOK LIST- ***** DATE MMM-dd-yyyy ***** TIME 11:11 *****
(1) (2) (3) (4)
KEY NAME STATION NAME EMAIL ADDRESS / TELEPHONE NO.
ROUTING SUB-ADDR (6) ROUTING TSI (7) (8) RELAY ADDR

[B] [Bob Jones ] Bob Jones Jonesb@abcdefg.com
123456 201 555 1212
[J] [John Smith] John Smith ☎ 201 555 3456
4452 +1 201 123 4567 [RELAY1]
 [Jane Smith] Jane Smith ☎ 201 555 1212
1212 212 555 1234 [RELAY2]
[P] [Panafax1 ] Panafax1 panafax1@panasonic.com co.jp
4827 +81 03 5251 1234
 [Panafax2 ] Panafax2 panafax2@panasonic.com co.jp
1773 +81 0467 5251 1234

NO. OF STATIONS = 05 (5)

-PANASONIC -
***** DP-xxxx ***** -HEAD OFFICE - ***** 201 555 1212- *****
    
```

### Explanation of Contents

- (1) The first letter of station name recorded in your machine
- (2) Key name recorded in the machine Up to 15 characters
- (3) Station name recorded in the machine Up to 15 characters
- (4) Telephone number recorded in the machine Up to 36 digits (Telephone number)  
Email address recorded in the machine Up to 60 characters (Email address)
- (5) Number of recorded Address Book stations Telephone Number/Email Address programmed into the Address Book.
- (6) Routing Sub-address Up to 20 digits
- (7) Routing TSI Up to 20 digits
- (8) Relay Address



## Group and Program List

To print a Program List of the Dialing Patterns that you have previously entered into the Program Keys.

Make sure that the FAX/EMAIL lamp is ON. If not, press  to select the "FAX/EMAIL" mode.

1

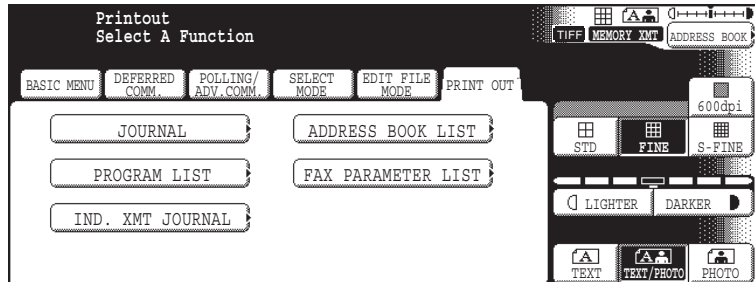

2



### Sample Program List

```
***** -PROGRAM LIST- ***** DATE MMM-dd-yyyy ***** TIME 15:00 *****

(1)      (2)      (3)      (4)
KEY NAME PROGRAM NAME TYPE     TIMER  DESTINATION(S)

[TEST   ] TEST     GROUP   ----- [PANAFAX] [SALES DEPT]
[ACCOUNT] ACCOUNT  POP     ----- DELETE EMAIL : Invalid (5)
[ACC    ] ACC      POP     ----- DELETE EMAIL : Valid
[PROG.B ] PROG.B   GROUP   ----- [PANAFAX] [PANASONIC]

                               -PANASONIC -

***** DP-xxxx ***** -HEAD OFFICE - ***** 201 555 1212- *****
```

### Explanation of Contents

- |   |   |
|---|---|
| (1) Key name                            |   |
| (2) Program name                        | Up to 15 characters   |
| (3) Type of communication               | "GROUP" indicates that the Program key is programmed as a group key.<br>"POP" indicates that the Program key is programmed as a POP access key. |
| (4) Numbers recorded in the program key | ADDRESS BOOK numbers, or password.<br>Email address programmed into Program Key.*   |
| (5) Deletion of received Email          | "Valid" means that the received email will be deleted. "Invalid" means that the received email will be retained.                                |

\* When using group dialing, or program dialing, the key name specified as a sender in the Fax Address Book appears in the program list.

# Journals and Lists

## Fax Parameter List

To Print a Fax Parameter List:

Make sure that the FAX/EMAIL lamp is ON. If not, press  to select the "FAX/EMAIL" mode.

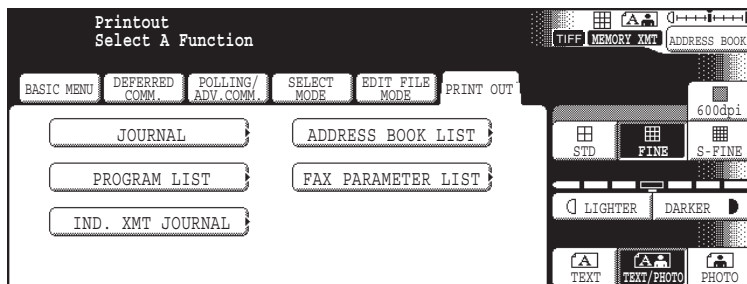

### Sample Fax Parameter List

```

***** -FAX PARAMETER LIST- ***** DATE MMM-dd-yyyy ***** TIME 15:00 ***** p.01

(1)      (2)      (3)      (4)      (5)
No.      DESCRIPTION      SELECTION      CURRENT      STANDARD
SETTING      SETTING

000      Print Fax Parameter List
(6)001   Contrast (HOME)      (1 2 3 4 5 6 7)      4      4
* 002   Resolution (HOME)      (STD Fine S-Fine)      STD      Fine
)
)
)
182     Send Comm. JNL      (Print Email Both)      Print      Print

                                     -PANASONIC



***** DP-xxxx ***** -HEAD OFFICE - ***** 201 555 1212- *****
    
```

### Explanation of Contents

- |                      |                                       |                      |   |
|----------------------|---------------------------------------|----------------------|---|
| (1) Parameter number |                                       | (4) Current setting  | "----" indicates code, or password is not set. When the code, or password is set, it is represented by asterisk(*). |
| (2) Description      | "(HOME)" means home position setting. | (5) Standard setting | Factory preset standard setting   |
| (3) Selection        |                                       | (6) Changed setting  | "*" indicates that the Factory preset setting was changed.  |

# Troubleshooting

## If You Have Any of These Problems

Mode	Symptom	Possible Cause / Action	Page
During Transmission	Document doesn't feed/multiple feed	<ol style="list-style-type: none"> <li>1. Check that your document is free of staples, and paper clips, and that it is not greasy, or torn.</li> <li>2. Check that your document is the right type to send through an ADF by consulting the list on "Originals You Cannot Send". If your document has the characteristics listed, use the Platen instead.</li> <li>3. Check that the document is loaded properly.</li> </ol>	17
	Does not stamp	Check Fax parameter No. 04, and No. 28 settings.	190 191
	Stamp too light	Replace stamp, or refill ink.	220
Transmission Copy Quality	Vertical lines on the transmitted document	Check own copy quality. If copy is OK, your machine has no problem, report to the receiving party that they have a problem. If copy is NG, clean the Document Scanning Area.	---
	Transmitted document is blank		
During Reception	 : Add Paper	Replenish the recording paper.	---
	Recording paper misfeed	Remove the misfed paper. (See the Operating Instructions for Copier)	---
	Recording paper doesn't advance into machine	Make sure that there is paper in the Paper Cassette. Follow the instructions for loading paper.	---
	Recording paper doesn't eject after printing	Check to see if the recording paper is jammed inside of the machine.	---
	Document auto reduction doesn't work	Check Print Reduction settings.	34
	 : Add Toner	Replace the Toner Bottle.	---
	 : No Waste Toner Box	Install the Waste Toner Box.	---

Continued on the next page...

## Troubleshooting

Mode	Symptom	Possible Cause / Action	Page
Communication	No dial tone	1. Check the connection of the telephone line. 2. Check the telephone line.	221
	No auto answer	1. Check the connection of the telephone line. 2. Check the Reception mode setting. 3. If the Fax Parameter No. 013 (AUTO JOURNAL PRINT) is set to "Valid" (default setting), and the machine is printing the received document(s) from memory, which also happens to be the 200th transaction, the machine will not auto answer until the Transaction Journal completes printing.	221 32
	Cannot transmit, or receive	An information code will be shown on the display. Refer to the information code table to find out the trouble.	217
No Unit Operation	No unit operation	To reset the machine, turn-off the Power Switch for a few seconds then turn it on again.	12

## Information Codes

When something unusual occurs, the display may show one of the Information Codes listed below. These will help you to identify, and correct the problem.

Info. Code	Meaning	Possible Action	Page								
030	Document is misfeeding.	1. Reload the document properly. 2. Remove the document jam. 3. Adjust ADF.	17								
031	Document is too long, or jammed. Document length exceeds 78.8 inches (2 meters) in "Normal", and "Fine" mode only. The length limitation for "Super Fine", and "600 dpi" mode, is subject to the available Memory size.  <table border="0" style="margin-left: auto; margin-right: auto;"> <tr> <td style="text-align: center;"><b>Super Fine</b></td> <td style="text-align: center;"><b>600dpi</b></td> </tr> <tr> <td style="text-align: center;">(Max. Length)</td> <td style="text-align: center;">(Max. Length)</td> </tr> <tr> <td>A4/Letter Width: 55 in (1400 mm)</td> <td>24 in (600 mm)</td> </tr> <tr> <td>A3/Ledger Width : 39 in (990 mm)</td> <td>17 in (430 mm)</td> </tr> </table>	<b>Super Fine</b>	<b>600dpi</b>	(Max. Length)	(Max. Length)	A4/Letter Width: 55 in (1400 mm)	24 in (600 mm)	A3/Ledger Width : 39 in (990 mm)	17 in (430 mm)	1. Reload the document properly. 2. Remove the document jam. 3. Add additional Flash Memory.	17
<b>Super Fine</b>	<b>600dpi</b>										
(Max. Length)	(Max. Length)										
A4/Letter Width: 55 in (1400 mm)	24 in (600 mm)										
A3/Ledger Width : 39 in (990 mm)	17 in (430 mm)										
061	ADF Door (Document Return Guide) is open.	Close the ADF Door.	--								
400	During initial handshake, receiving station did not respond, or communication error occurred.	1. Check with the other party. 2. Reload the document, and send again.	--								
401	Remote station required a Receiving Password to receive the document. Remote station does not have Confidential Mailbox.	Check the remote station.	--								
402	During initial handshake, communication error occurred.	Reload the document, and send again.	--								
403	No polling capability at the remote side.	Ask remote side to set "POLLED=ON".	--								
404/405	During initial handshake, communication error occurred.	Reload the document, and send again.	--								
406	Transmission Password does not match. Receiving Password does not match. Received from an unauthorized station in Selective Reception mode.	Check the password, or the telephone number in Address Book.	77 91								
407	No confirmation from the receiving station for the previous page sent.	Wait a few minutes, and send again.	--								
408/409	Remote side confirmation of previous page is illegible.	Wait a few minutes, and send again.	--								
410	Communication aborted by the transmitting side.	Check with the other party.	--								
411	Polling password does not match.	Check the polling password.	46								
412	No data from the transmitting side.	Check with the other party.	--								
414	Polling password does not match.	Check the polling password.	46								
415	Polling transmission error.	Check the polling password.	46								
416/417/ 418/419	Received data has too many errors.	Check with the other party.	--								
420/421	Machine goes to receiving mode, but receives no command from the transmitting side.	1. Remote side misdial. 2. Check with the other party.	--								
422/427	Interface is incompatible.	Check with the other party.	--								
430/434	Communication error occurred while receiving.	Check with the other party.	--								
436/490	Received data has too many errors.	Check with the other party.	--								

Continued on the next page...

# Troubleshooting

## Information Codes

Info. Code	Meaning	Possible Action	Page
456	<ul style="list-style-type: none"> <li>• Unit received a confidential document, or was requested to be polled of a confidential document under any of following conditions.               <ol style="list-style-type: none"> <li>1. Not enough space in memory to receive the confidential document.</li> <li>2. Confidential Mailbox is full.</li> <li>3. While printing received document.</li> </ol> </li> <li>• Unit was requested to relay a document.</li> </ul>	<ol style="list-style-type: none"> <li>1. Print a File List, and check the contents.</li> <li>2. Wait until unit finishes printing.</li> </ol>	98
492/493/ 494	Communication error occurred while receiving.	Check with the other party.	--
495	Telephone line disconnected.	Check with the other party.	--
501/502/ 504	Communication error occurred using the internal V.34 Modem.	Check with the other party.	--
540/541/ 542/ 543/544	Communication error occurred while transmitting.	<ol style="list-style-type: none"> <li>1. Reload the document, and send again.</li> <li>2. Check with the other party.</li> </ol>	--
550	Telephone line disconnected.	Check with the other party.	--
552/553/ 554/555	Communication error occurred while receiving.	Check with the other party.	--
580	Sub-address transmission to a unit that has no Sub-address function.	Check the remote station.	66
581	Sub-address Password transmission to a unit that has no Password Sub-address function.	Check the remote station.	66
630	Redial was not successful due to a busy line.	Reload the document, and send again.	--
631	During dialing, STOP was pressed.	Reload the document, and send again.	--
634	<p>Redial was not successful due to no response from the called station, or wrong number dialed.</p> <p><b>Note:</b> If busy tone was not detected, the machine will only redial once.</p>	Check the telephone number, and send again.	--
638	Power failure occurred during the communication.	Check the power cord, and plug.	--
711	Incorrect LDAP settings.	Check the LDAP Server Name, LDAP Log in Name, LDAP password, LDAP Search Base.	122
712	Incorrect email address.	Check the registered email address. Check the IP Address of the SMTP Server with the Network Administrator.	--
714	Cannot Log on to the LAN.	Check the 10Base-T/100Base-TX cable connection. An unexpected LAN problem occurred. Contact the Network Administrator.	--
715	TCP/IP connection timed out.	Check the Internet Fax parameter settings. Verify the IP Address, Default Gateway IP Address, SMTP Server IP Address.	--
716	Cannot logon to the designated SMTP Server.	Check the SMTP Server IP Address setting. Contact the Network Administrator.	--
717	Incomplete SMTP Protocol transmission. SMTP Server's hard disk may be full.	SMTP Server is defective. Contact the Network Administrator.	--

## Information Codes

Info. Code	Meaning	Possible Action	Page
718	Page Memory Overflow occurred while receiving printing data. The paper size selected within your application to print is larger than the paper size loaded in the cassette(s).	Check the document size, and resolution. Ask originator to re-send in a supported size, and resolution.	--
719	Received data via LAN is in a format that is not supported.	Ask the originator to re-send with a supported file attachment format: * In a TIFF-F format. * Image data conforming to recording paper size.	--
720	Cannot connect to the POP Server. (Incorrect POP Server IP Address) POP Server is down.	Check the POP Server IP Address. Contact the Network Administrator.	--
721	Cannot connect to the POP Server. (User Name, or Password error)	Check the POP User Name, and Password, or the APOP settings. Contact the Network Administrator.	--
722	Failed to obtain IP address from the DHCP server.	Check the 10Base-T/100Base-TX cable connection. Confirm that the Internet Parameter, and the DHCP server are correctly configured before turning on, or turning off the power. Contact the Network Administrator.	12
725	DNS Server connection timed out. DNS Server is down.	Check the DNS Server IP Address. Contact the Network Administrator.	--
726	Received an error response from the DNS Server.	Check the POP Server Name. Check the SMTP Server Name.	--
728	The document was sent to the Internet Fax in an incompatible file format (PDF). <b>Note:</b> PDF file format is only used when sending an Internet Fax to a PC (Network Scanning).	Change the XMT File Format (Fax Parameter #177) to "TIFF".	195
729	Failed to authenticate (SMTP AUTHENTICATION) when connecting with the SMTP server.	Check the SMTP AUTHENT. User Name, and Password. Contact the Network Administrator.	195
730	Cannot retrieve the Journal nor program the Internet Parameters, and the Auto Dialer remotely via email from a PC.	Check that the Fax Parameter No. 158 (PC REMOTE UPDATE) is set to "2:Valid".	195
731	The dialer buffer for manual dialing was full (70 stations) when the Relay Transmission Request was received.	Request the originator to re-send the Relay Transmission Request after the reserved communication is finished.	--
742	Unable to dial to Key Operator (Job Tracking, NYSE)	Incorrect setting or wrong number set.	--
800/814 /816/825	Unit was requested to relay a document, or Confidential Communication but has no capability.	Check with the other party.	--
815	Mailbox is full.	Install Optional Flash Memory Card.	--
850	Because the Dept. code that had been input to Fax Driver / Panafax Desktop was not in accord with the Dept. code registered in the machine, the directed relay was refused.	Confirm the Dept. code registered in the Fax Driver / Panafax Desktop or the machine.	--
870	Memory overflow occurred while storing documents into memory for transmission.	1. Transmit documents without storing into memory. 2. Install Optional Memory Card.	29

### NOTE

1. After identifying the problem, and verifying the recommended action, if the information Codes keep reoccurring, or for help on Information Codes that appear on your machine but are not listed above, please contact your local Panasonic Authorized Dealer.  
(For mechanical failures, see the Troubleshooting section in the Operating Instructions (For Copy & Network Scan Functions) included on the CD)

# Troubleshooting

## Verification Stamp

To remove the Stamp

1

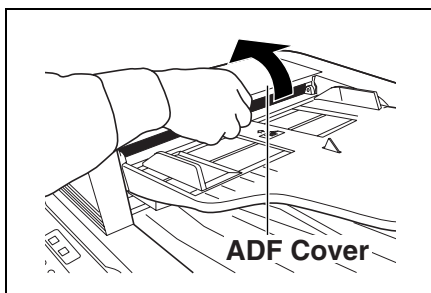

Open the ADF cover.

2

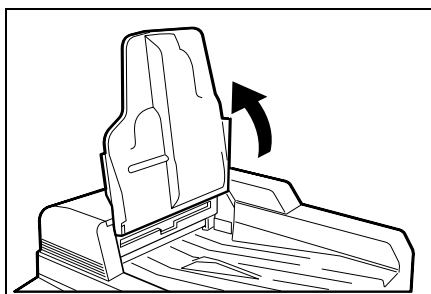

Open the ADF Input Tray.

3

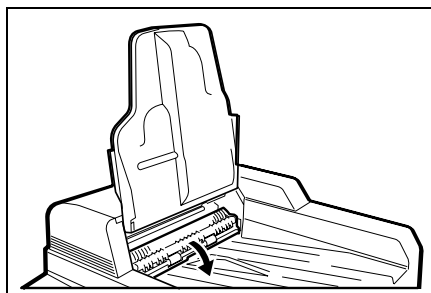

Open the ADF Exit Cover.

4

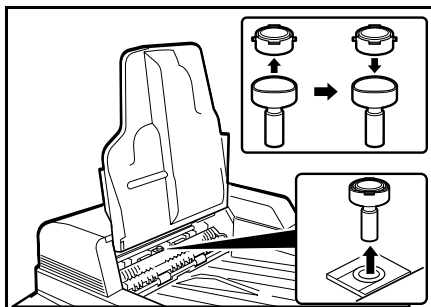

1. Remove by pulling the Stamp Assembly upward.

2. Remove the Stamp. Replace the stamp with a new one, or refill the stamp with a few drops of the specified ink into the back of the stamp.

**Verification Stamp Order No.:**

DZHT000027 (for USA and Canada)

DZHT000004 (for other countries)

5

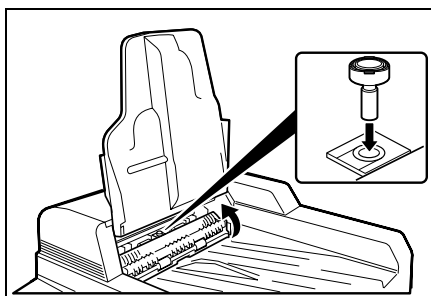

Reinstall the Stamp Assembly.

### CAUTION

Keep stamp, and small parts out of reach of children to prevent choking, or poisoning. If a stamp is swallowed accidentally, get medical treatment immediately.

#### NOTE

1. Please contact your local Authorized Panasonic Dealer to purchase a new stamp.
2. Stamp ink refills can be purchased from a stationary store. Use blue Shachihata" X" Stamp ink (No. 22113), or its equivalent.



## Checking the Telephone Line

If you do not hear a dial tone when the **MONITOR** key is pressed, or the incoming call does not ring on your machine (No automatic receive).

**1**

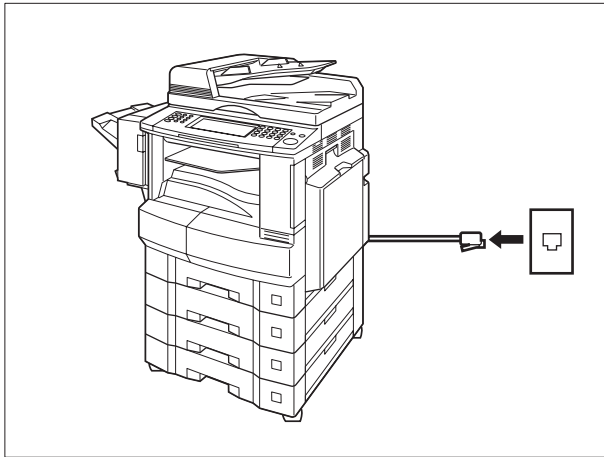

Unplug the Telephone Line Cable from the telephone jack that was supplied by the telephone company.

**2**

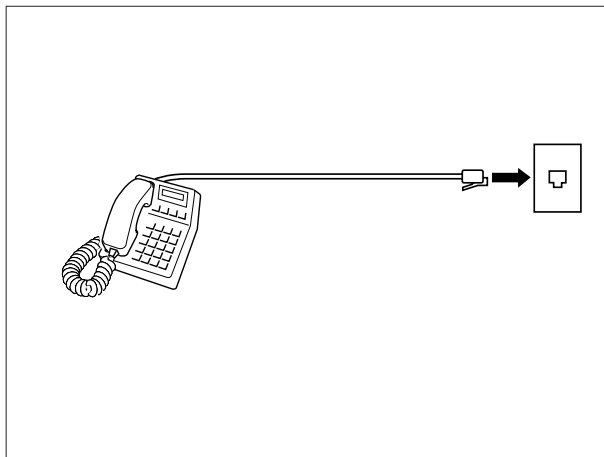

Plug a different regular telephone into the same telephone jack.

**3**

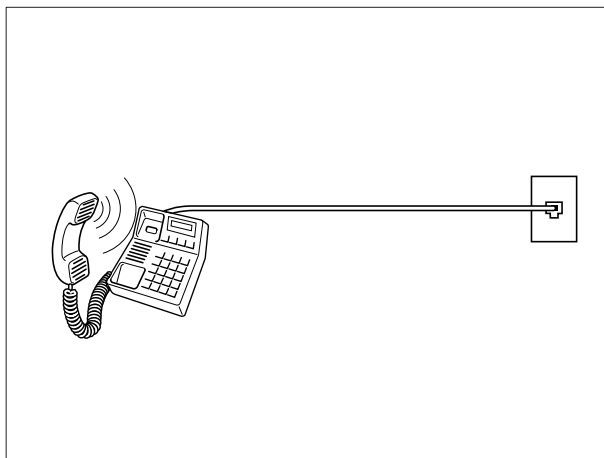

Check for dial tone through the handset. If there is still no dial tone, report it to your local telephone company.

or

Call from another telephone to this number. If the telephone does not ring, report it to your local telephone company.

memo

# Specifications

## [ For G3 Facsimile ]

<b>Compatibility</b>	ITU-T Group 3
<b>Coding Scheme</b>	JBIG, MH, MR, MMR (Conforms to ITU-T Recommendations)
<b>Modem Type</b>	ITU-T V.34, V.17, V.33, V.29, V.27 ter, and V.21
<b>Modem Speed</b>	2,400 - 33,600 bps
<b>Document Size</b>	Ledger/Legal/Letter/Letter-R/Invoice/Invoice-R <b>Max</b> : <b>Platen Glass</b> : 11" x 17" (Ledger) <b>ADF</b> : 11.7" (Original's Width) <b>Min</b> : <b>Platen Glass</b> : No Minimum <b>ADF</b> : 5.5" x 8.5" (Invoice)
<b>Scanning Method</b>	Sheet Feeding with CCD type image sensor
<b>Effective Scanning Width</b>	11.5" (292 mm)
<b>Scanner Resolution</b>	<b>Horizontal</b> : 203 pels/inch (8 pels/mm) : Standard and Fine Resolution : 406 pels/inch (16 pels/mm) : Super Fine Resolution <b>Vertical</b> : 98 lines/inch (3.85 lines/mm) : Standard Resolution : 196 lines/inch (7.7 lines/mm) : Fine Resolution : 391 lines/inch (15.4 lines/mm) : Super Fine Resolution
<b>Address Book Memory Capacity</b>	200 stations (plus an additional 800 stations with the optional Hard Disk Drive (DA-HD31) installed) Each station can register up to 36 digits for each telephone number (including pauses and spaces), and up to 15 characters for each station name
<b>Image Memory Capacity</b>	<b>Base Memory</b> : 180 pages <b>with 4 MB Flash Memory Card</b> : 500 pages <b>with 8 MB Flash Memory Card</b> : 820 pages (Base on ITU-T Image No.1 using Standard Resolution)
<b>Power Consumption</b>	<b>Normal Operation Mode</b> : Approx. 140 Wh <b>Energy-Saver Mode</b> : Approx. 28 Wh <b>Sleep Mode</b> : Approx. 18 Wh
<b>FCC Registration Number</b>	US:ACJFA15BDP-3010
<b>Ringer Equivalence</b>	1.5 B

## [ For Internet Fax (Email) ]

<b>Standard Compliance</b>	10Base-T Ethernet (IEEE 802.3), 100Base-TX Fast Ethernet (IEEE802.3u)
<b>Connector Interfaces</b>	10/100 Base-TX port: RJ-45
<b>Compatibility</b>	IETF RFC 3965, ITU-T T.37
<b>Communication Protocol</b>	TCP/IP, SMTP, POP3, MIME

# Specifications

<b>File Format</b>	TIFF [IETF RFC 3949 Profile S, F, J] PDF
<b>Email Receiving Width</b>	Maximum LEDGER size

# FCC Notice for User in USA

## **WARNING**

This equipment has been tested, and found to comply with the limits for a Class A digital device, pursuant to part 15 of the FCC Rules. These limits are designed to provide reasonable protection against harmful interference when the equipment is operated in a commercial environment. This equipment generates, uses, and can radiate radio frequency energy, and if not installed, and used in accordance with the Operating Guide, may cause harmful interference to radio communications.

Operation of this equipment in a residential area is likely to cause harmful interference in which case the user will be required to correct the interference at his/her own expense.

Any unauthorized changes, or modifications to this equipment would void the users authority to operate this device.

**Warning:** To assure continued compliance, use only shielded interface cable when connecting the facsimile machine parallel interface port to host computer. Also, any changes, or modifications not expressly approved by the party responsible for compliance could void the user's authority to operate this equipment.

This device complies with Part 15 of the FCC Rules. Operation is subject to the following two conditions:

- (1) This device may not cause harmful interference, and
- (2) This device must accept any interference received, including interference that may cause undesired operation.

Responsible Party: Panasonic Corporation of North America  
One Panasonic Way, Secaucus, NJ 07094

FCC Inquiries Only: Panasonic Communications Company of North America/Technical Support  
Department  
Three Panasonic Way, Secaucus, NJ 07094  
1-800-225-5329 (see **Note** below)  
Email: [consumerproducts@us.panasonic.com](mailto:consumerproducts@us.panasonic.com)

**Note:** For Technical Support, please contact your Authorized Panasonic selling dealer.

This equipment complies with Part 68 of the FCC rules, and the requirements adopted by the ACTA. On the rear panel of this equipment is a label that contains, among other information, a product identifier in the format US:AAAEQ##TXXXX. If requested, this number must be provided to the telephone company.

Ask your telephone company, or installer to install the jack suitable for your device if such is not available.

A plug, and jack used to connect this equipment to the premises wiring, and telephone network must comply with the applicable FCC Part 68 rules, and requirements adopted by the ACTA. A compliant telephone cord, and modular plug is provided with this product. It is designed to be connected to a compatible modular jack that is also compliant. See installation instructions for details.

The REN is used to determine the number of devices that may be connected to a telephone line. Excessive RENs on a telephone line may result in the devices not ringing in response to an incoming call. In most but not all areas, the sum of RENs should not exceed five (5.0). To be certain of the number of devices that may be connected to a line, as determined by the total RENs, contact the local telephone company. The REN for this product is part of the product identifier that has the format US:AAAEQ##TXXXX. The digits represented by ## are the REN without a decimal point (**Ex:** 03 is a REN of 0.3).

If your telephone equipment causes harm to the telephone network, the Telephone Company may discontinue your service temporarily. If possible, they will notify you in advance. But if advance notice isn't practical, you will be notified as soon as possible. You will be informed of your right to file a complaint with FCC.

*Continued on the next page...*

# FCC Notice for User in USA

Your telephone company may make changes in its facilities, equipment, operations, or procedures that could affect the proper functioning of your equipment. If they do, you will be notified in advance to give you an opportunity to maintain uninterrupted telephone service.

If you experience trouble with this telephone equipment, please contact the manufacturer's authorized service agency for information on obtaining service, or repairs. The telephone company may ask that you disconnect this equipment from the network until the problem has been corrected, or until you are sure that the equipment is not malfunctioning.

For protection against the risk of electric shock, always disconnect all cables from the wall outlet before servicing, modifying, or installing the equipment.

This equipment may not be used on coin service provided by the telephone company nor connected to party lines. Connection to party line service is subject to state tariffs. (Contact the state public utility commission, public service commission, or corporation commission for information.)



If your home has specially wired alarm equipment connected to the telephone line, ensure the installation of this equipment does not disable your alarm equipment. If you have questions about what will disable alarm equipment, consult your company, or a qualified installer.

The Telephone Consumer Protection Act of 1991 makes it unlawful for any person to use a computer, or other electronic device to send any message via telephone facsimile machine unless such message clearly contains in a margin at the top, or bottom of each transmitted page, or on the first page of transmission the following information:

1. Date and Time of transmission, and
2. Identification of either business, business entity, or individual sending the message, and
3. Telephone number of either the sending machine, business, business entity, or individual.

In order to program this information into your facsimile machine, you should refer to page number 177, and 179 in this Operating Instructions to complete the steps.

### Example of Header Format (LOGO, ID Number setting)

MMM-dd-yyyy 09:00	PANASONIC	201 348 7000	P.01/05
			
1) Date and Time	2) LOGO	3) ID Number	

# Notice to User in Canada

## NOTICE

Before installing this equipment, users should ensure that it is permissible to be connected to the facilities of the local telecommunications company. The equipment must also be installed using an acceptable method of connection. The customer should be aware that compliance with the above conditions may not prevent degradation of service in some situations.

Repairs to this equipment should be made by an authorized Canadian maintenance facility designated by supplier. Any repairs, or alterations made by the user to this equipment, or equipment malfunctions, may give the telecommunications company cause to request the user to disconnect the equipment.

Users should ensure for their own protection that the electrical ground connections of the power utility, telephone lines, and internal metallic water pipe system, if present, are connected together. This precaution may be particularly important in rural areas.

## CAUTION

Users should not attempt to make such connections themselves, but should contact the appropriate electric inspection authority, or electrician, as appropriate.

## NOTICE

This equipment meets the applicable Industry Canada Terminal Equipment Technical Specifications. This is confirmed by the registration number. The abbreviation, IC, before the registration number signifies that registration was performed based on a Declaration of Conformity indicating that Industry Canada technical specifications were met. It does not imply that Industry Canada approved the equipment.

On the rear panel of this equipment is a label that contains, among other information, the Registration Number, and Ringer Equivalence Number (REN) for this equipment.

The REN assigned to each terminal equipment provides an indication of the maximum number of terminals allowed to be connected to a telephone interface. The termination on an interface may consist of any combination of devices subject only to the requirement that the sum of the Ringer Equivalence Numbers of all devices does not exceed five.

*Continued on the next page...*

## Notice to User in Canada

### Avis

Avant d'installer ce matériel, l'utilisateur doit s'assurer qu'il est permis de le raccorder aux installations de l'entreprise locale de télécommunication. Le matériel doit également être installé en suivant une méthode acceptée de raccordement. L'abonné ne doit pas oublier qu'il est possible que la conformité aux conditions énoncées ci-dessus n'empêche pas la dégradation du service dans certaines situations.

Les réparations de matériel homologué doivent être effectuées par un centre d'entretien canadien autorisé désigné par le fournisseur. La compagnie de télécommunications peut demander à l'utilisateur de débrancher un appareil à la suite de réparations ou de modifications effectuées par l'utilisateur ou à cause de mauvais fonctionnement.

Pour sa propre protection, l'utilisateur doit s'assurer que tous les fils de mise à la terre de la source d'énergie électrique, des lignes téléphoniques et des canalisations d'eau métalliques, s'il y en a, sont raccordé ensemble. Cette précaution est particulièrement importante dans les régions rurales.

### Avertissement

L'utilisateur ne doit pas tenter de faire ces raccordements lui-même; il doit avoir recours à un service d'inspection des installations électriques, ou à un électricien, selon le cas.

### Avis

Le présent matériel est conforme aux spécifications techniques d'Industrie Canada applicables au matériel terminal. Cette conformité est confirmée par le numéro d'enregistrement. Le sigle IC, placé devant le numéro d'enregistrement, signifie que l'enregistrement s'est effectué conformément à une déclaration de conformité et indique que les spécifications techniques d'Industrie Canada ont été respectées. Il n'implique pas qu'Industrie Canada a approuvé le matériel.

Sur le panneau arrière de cet appareil se trouve une étiquette, sur laquelle est indiqué, entre autres, le numéro d'enregistrement et le Numéro d'Equivalence de Sonnerie (REN) pour cet appareil.

L'IES assigné à chaque dispositif terminal indique le nombre maximal de terminaux qui peuvent être raccordés à une interface téléphonique. La terminaison d'une interface peut consister en une combinaison quelconque de dispositifs, à la seule condition que la somme d'indices d'équivalence de la sonnerie de tous les dispositifs n'excède pas 5.



# Glossary

<b>10Base-T/100Base-TX</b>	An Ethernet standard for cable. The 10/100 refers to its 10/100 Mbps bandwidth, the base to single channel baseband, and the T to the Twisted pair. The cable uses two pairs of unshielded twisted wires.
<b>Access Code</b>	A 4-digit programmable access code that prevents unauthorized operation of your Fax.
<b>Address Book</b>	The ability to store full phone numbers, or email addresses into the dialer, and then utilizing a single keystroke to speed dial that number/email address in the future.
<b>Address Book Dialing</b>	The ability to dial an entire telephone number/email address by pressing one key.
<b>ADF (Automatic Document Feeder)</b>	The mechanism that delivers a stack of document pages to the scanner one page at a time.
<b>Auto Print Reduction</b>	The method of automatically reducing a received document so that it can be printed onto a standard size piece of plain paper. For example, your machine will reduce an incoming legal size page to 75% of its original size so it could fit on a letter size page.
<b>Automatic Reception</b>	The mode that allows you to receive fax documents without user intervention.
<b>Batch Transmission</b>	The ability to accumulate different document files for the same destination(s) to be transmitted in a single phone call.
<b>BPS (Bits Per Second)</b>	The amount of data that is transmitted over the phone line. Your machine can start at each Max. Modem speed, and automatically steps down to suitable speed depending on the phone line condition, and the receiving machines capabilities. (Max. Modem Speed is 33600 BPS)
<b>CCITT</b>	Consultative Committee on International Telegraph, and Telephone. This organization has presently developed four groups of industry standards that insure facsimile compatibility.
<b>Character ID</b>	A programmed proprietary code name that allows up to 16 alphanumeric characters identifying your facsimile machine.
<b>Character Keys</b>	The keys that are used to enter letters, and symbols for various programming functions.
<b>Client</b>	Clients are computers that run software programs used to contact, and obtain data from Server software program on another computer, often across a great distance.
<b>Coding Scheme</b>	The data compression method used by facsimile machines. Your machine utilizes Modified Huffman (MH), Modified Read (MR), Modified Modified Read (MMR), and Joint Bi-level Experts Group (JBIG) coding schemes.
<b>Comm. Journal</b>	Refers to either the Communication Journal, Relay Transmission Report, or the Confidential XMT Report.
<b>Confidential RCV Report</b>	The report that gives you information about a confidential document(s) that is held in your machine's memory.
<b>Contrast</b>	Signifies the scanning sensitivity in terms of lightness, and darkness of your original transmitting pages.
<b>Cover Sheet</b>	A Fax Cover Sheet can be attached to your transmit document(s) that shows the recipient's name, originator's name, and number of pages attached.

*Continued on the next page...*

# Glossary

<b>DDD (Direct Distance Dialing)</b>	A telephone service that allows unassisted dialing, no operator assistance is required.
<b>DDS (Document Distribution System)</b>	The Document Distribution System automatically distributes received data (scanner data, data received via FAX, and data received via Internet Fax) to specified recipients via a predefined delivery mechanism. The system administrator uses the system to specify the delivery mechanisms, and the recipients.
<b>Default Gateway IP Address</b>	This is your Gateway's Address, it is used by other Networks to determine which route to take when communicating with your Internet Fax.
<b>Deferred Polling</b>	The ability to retrieve documents from other stations at a later time.
<b>Deferred Transmission</b>	The ability to send documents to other stations at a later time.
<b>Delivery Notice</b>	Delivery Notice is a Message Disposition Notification (MDN) request initiated by the sending Internet Fax to the destination Internet Fax. The receiving Internet Fax replies with a delivery processing confirmation after the message (email) was read.
<b>Department Code</b>	This operation require the user to input a preset 4-digit Department Code before transmission. The Department Name of selected Department Code is printed on the Header of each page sent, Cover Sheet, Comm. Journal, and Individual Transmission Journal.
<b>Direct Dialing</b>	The method of dialing where you enter the entire telephone number through the keypad.
<b>Direct Internet Fax XMT</b>	Allows Internet Fax machines to communicate directly with each other within the Firewall (Intranet) without going through the Mail Server, thus alleviating the burden on the mail server.
<b>Directory Search Dialing</b>	Allows you to dial a full telephone number, or email address by searching the station's name entered in the Address Book.
<b>Directory Sheet</b>	The list that contains the station names that are programmed into your unit.
<b>DNS (Domain Name Server)</b>	The purpose of the DNS is to store records containing domain information, such as Fully Qualified Domain Names (FQDN), and translate them to TCP/IP addresses.
<b>Domain Name</b>	A unique name that identifies an Internet site. Domain Names always have 2, or more parts, separated by dots. The part on the left is the most specific, and the part on the right is the most general.
<b>DTMF (Dual Tone Multi-Frequency)</b>	Dialing method that sends a different set of frequencies for each digit of the telephone keypad. Commonly refers to touch tone dialing.
<b>Duplex Scan</b>	The ability to scan both sides of 2-sided original(s) for transmission.
<b>ECM (Error Correction Mode)</b>	The ability to correct transmission errors as detected during the transmitting phone call.
<b>Email Address</b>	The address for sending, and receiving data by email. It consists of User name, Sub-domain name, and Domain name.
<b>End Receiving Station</b>	In a relay network, the final station designated to receive the document.
<b>Energy-Saver Mode</b>	Saves energy by consuming less power than when in standby mode by turning off the fuser unit after the specified time.

<b>Ethernet</b>	A very common method of networking computers, and equipment in a LAN. Ethernet can handle up to 100 Mbps, and can be used with almost any kind of computer.
<b>FCC</b>	Federal Communications Commission. The U.S. Government organization that regulates communications originating, or terminating in the United States.
<b>Fax Forward</b>	The ability to forward all incoming faxes to the specified station registered in the Address Book.
<b>Fax Parameter List</b>	The list that contains the home FAX parameters settings that you have programmed into your machine.
<b>FAX/TEL Auto Switching</b>	The ability to share a single telephone line for both fax, and voice usage.
<b>File</b>	A task that has been stored into the memory of your unit. Examples are deferred transactions.
<b>Fixed Print Reduction</b>	The method that allows you to determine one reduction rate, such as 75%, for all incoming documents.
<b>Function</b>	The control panel key that will be utilized to begin an operation, or configuration of a feature.
<b>G3 Mode (Group 3)</b>	Refers to the standards, and transmission capabilities of the current generation of facsimile machines.
<b>Group Dialing</b>	The ability to program many telephone numbers into a single station so that many locations can be dialed in sequence utilizing a single keystroke.
<b>Handshaking</b>	The exchange of a group of control signals that communicate between the transmitter, and receiver. These signals determine the condition at which communication can occur.
<b>Header</b>	A row of information that is transmitted by the sending machine, and printed on the top of each page by the receiving unit. This identifies the transmitting unit, and information about the transmission, such as time, and date.
<b>Home Page</b>	The page that your Browser displays when it starts up, or the main web page for a business, organization, etc.
<b>Host</b>	Any computer on a network that is a repository for services available to other computers on the network. A Host must have a unique Host name within a domain. The host is the first (left most) section of the Fully Qualified Domain Name (FQDN). The remainder of the FQDN is the domain, and often tells you something about where your machine is located ( <b>Ex:</b> at Panasonic). <b>Ex:</b> Your machine's email address is: Fax@fax01.panasonic.com In the example above "fax01" is the host, and "panasonic.com" is the domain.
<b>ID</b>	A programmable address of up to 20 digits identifying your machine.
<b>Image Memory Capacity</b>	This signifies the amount of memory available in your unit capable of storing pages of documents. All page units of measure are based on the ITU-T Image No.1.
<b>Index Keys</b>	A series of alphabetized keys for easy access to the stations programmed in the Address Book.

# Glossary

<b>Individual Transmission Journal</b>	A report that is printed by the transmitting unit stating information regarding the last document transaction.
<b>Industry Canada (D.O.C)</b>	Department of Communications. The Canadian Government organization that regulates communications originating, or terminating in Canada.
<b>Information Code</b>	A code that is internally generated by your Fax stating a specific operational error, or machine failure.
<b>Initial Sending Station</b>	In a relay network, the station that is originating the document transmission.
<b>Internet</b>	The vast collection of inter-connected networks that all use the TCP/IP protocols. The Internet connects independent networks into a vast global internet.
<b>Intranet</b>	A private network inside a company, or organization that uses the same kinds of software that you would find on the public Internet, but that is only for internal use.
<b>IP Address</b>	A unique number used to identify equipment, or host computers on the Internet.
<b>ISP (Internet Service Provider)</b>	An institution that provides access to the Internet in some form, usually for money.
<b>ITU-T</b>	International Telecommunication Union - Telecommunication, formerly known as C.C.I.T.T.
<b>ITU-T Image No.1</b>	An industry standard document that allows comparisons of the transmission speeds, and capabilities of facsimile machines.
<b>Journal</b>	A report that is printed by your unit listing the last 200 transactions.
<b>Key Name</b>	An alternate to the station name that can be programmed for each Address Book dialing key. (By default it displays the first 15-characters of the station Name)
<b>Key Operator's password</b>	A password for the Key Operator (administrator) to set the machine. Key Operator's password is set by combining the alphanumeric characters of eight digits, including four kinds of symbol characters (@. _ space). The capital letter, and the small letter of the alphabet are distinguished.
<b>Keypad</b>	A group of numeric keys located on your control panel.
<b>LAN (Local Area Network)</b>	A computer network system, and printer limited to an immediate area, such as an Office, Factory, and University used to integrate, and exchange data.
<b>LCD</b>	Liquid Crystal Display. The display area of your machine.
<b>LDAP</b>	Lightweight Directory Access Protocol (LDAP) is a directory service protocol that runs over TCP/IP.
<b>LOGO</b>	Your programmed company name, or identification up to 25 alphanumeric characters.
<b>MAC Address</b>	Its the hardware address, often referred to as MAC (Media Access Control) address that is assigned to the equipment. MAC address is hard-coded, and is not configurable. The MAC address consists of 6 hexadecimal numbers separated by colons. <b>Ex:</b> 00:00:c0:34:f1:50
<b>Mail Gateway IP Address</b>	The Address of the Mail Server. The Internet Fax communicates with your existing Mail Server for all communication traffic.

<b>Mailing List</b>	A system that allows people to send an email to one address, whereupon their message is conveyed to multiple subscribers on the Mailing List.
<b>Manual Reception</b>	A mode that requires operator intervention to receive an incoming document.
<b>MAPI</b>	Acronym for Message Application Programming Interface. A standard Windows interface for messaging that enables different mail programs, and other mail-aware applications like word processors, and spreadsheets to exchange messages, and attachments with each other.
<b>MDN</b>	This Message Disposition Notification (MDN) is requested by the sender for a delivery processing confirmation indicating that the message (email) was read.
<b>Memory Transmission</b>	The documents are scanned into memory before actual connection to the phone line for transmission.
<b>MIME (Multipurpose Internet Mail Extension)</b>	A standard used for attaching non-text (image) files to Internet email messages.
<b>Modem</b>	A device that converts signals from your fax machine into signals that can be transmitted over telephone lines.
<b>Multi-station Transmission</b>	The ability to broadcast the same set of documents to a programmed number of locations.
<b>Multiple Logo</b>	The user can select one of 25 preset LOGOs before a transmission.
<b>Network</b>	Any time you connect 2, or more computers together so that they can share resources, you have a computer network. Connect 2, or more networks together, and you have an internet.
<b>Network Address</b>	An individual 4-digit addressing number assigned to an Address Book station that identifies a particular station in a relay network.
<b>Network Password</b>	A 4-digit password assigned to a network address to prevent unauthorized stations from accessing a relay station.
<b>Off-hook Dialing</b>	The direct dialing of a telephone number with the handset out of the cradle, or "off the hook."
<b>On-hook Dialing</b>	The direct dialing of a telephone number with the handset in the cradle, or "on the hook."
<b>Overlap Printing</b>	Documents too long to be reduced are automatically printed on two pages with approximately 13 mm overlap.
<b>Panasonic Super Smoothing</b>	An electronic image enhancement (Panasonic Super Smoothing) that will create a particular pattern for the improvement of copy quality.
<b>PDF</b>	Adobe® Portable Document Format (PDF) is a universal file format that preserves all the fonts, formatting, graphics, and color of any source document, regardless of the application, and platform used to create it.
<b>Photo</b>	A scanning technique to distinguish levels of gray from black, and white. Your machine can detect up to 256 levels of gray in photo mode.
<b>Polling</b>	The ability to retrieve a document from another facsimile machine.
<b>Polling Password</b>	A 4-digit programmed code that enables the security of a document being polled.

*Continued on the next page...*

# Glossary

<b>POP (Post Office Protocol)</b>	POP refers to the way email software such as Eudora, or your machine gets email from a mail server. You must always have a POP account that you tell your email software to use to retrieve your mail.
<b>Power Saver Mode</b>	To reduce the power consumption of the machine in standby, select the time period to turn OFF the high temperature fuser unit when the printer is idle.
<b>Print Collation</b>	The ability to stack received documents in the correct order.
<b>Print Reduction Modes</b>	The methods used to determine how an incoming document will be reduced to print onto the paper loaded in your machine.
<b>Program Keys</b>	Keys that are defined for storing a sequence of stations to be dialed, or polled.
<b>Protocol</b>	A protocol is the special set of rules for communicating that the end points in a telecommunication connection use when they send signals back, and forth. Both end points must recognize, and observe the protocol.
<b>PSTN</b>	Public Switched Telephone Network. Network of interconnected switching equipment, and transmission facilities.
<b>Qwerty Keyboard</b>	A keyboard on the Touch Panel Display that is used to enter letters, and symbols for various programming functions.
<b>Receiving Password</b>	A 4-digit password that is checked before a document is received.
<b>Relay Address</b>	A 3-digit code that identifies your machine is programmed in a relay network.
<b>Relay Network</b>	A group of facsimile machines that communicate via a relay station.
<b>Relay Station</b>	A certain type of facsimile machine that can store, and forward documents to an end receiving station, and/or a relay station in another relay network. Your machine can not be used as a relay station.
<b>Relay Transmission Report</b>	A report that contains information regarding the last document transmission to a relay station.
<b>Relayed Transmission</b>	Sending a document to a relay station, which in turn, sends the document to the end receiving station.
<b>Resolution</b>	Relates to the number of dots scanned, or printed per certain square. The quality of the image increases as the number of dots per certain square increases.
<b>Rotation XMT</b>	The document is set as (←□), the image is rotated by 90°, and then transmitted as (←□).
<b>Router (Gateway)</b>	A special purpose computer (or software package) that handles the connection between 2, or more networks. Gateways act like traffic cops, they spend their time looking at the destination addresses of the packets passing through them, and deciding which route to send them on.
<b>Selective Reception</b>	A function that can be set so that your unit will receive from only those machines programmed into your dialer.
<b>Sender Selection</b>	The user can select one of 24 pre-programmed sender's name, and email address/telephone number before each transmission.

<b>Server</b>	A computer, or a software package, that provides a specific kind of service to client software running on other computers. A single server machine could have several different server software packages running on it, thus providing many different servers to clients on the network.
<b>Sleep Mode</b>	The lowest power state that the machine enters after the specified time without actually turning off.
<b>SMTP (Simple Mail Transfer Protocol)</b>	This is the main communication protocol used to send, and receive email on the Internet.
<b>Station Name</b>	Alphanumeric ID which can be programmed for each phone number, or email address location in the Address Book.
<b>Stored Documents</b>	Documents that have been scanned, and now are stored in your machine's memory.
<b>Sub-address</b>	ITU-T recommendation for further routing, forwarding, or relaying of incoming faxes.
<b>Sub-address Password</b>	ITU-T recommendation for additional security that corresponds to the Sub-address.
<b>Subnet Mask</b>	A mask bit used to manage sub-segments of the network which is defined with network IDs.
<b>Substitute Memory Reception</b>	Your machine's ability to store an incoming document into its memory, when it runs out of recording paper, or toner.
<b>TCP/IP (Transmission Control Protocol/ Internet Protocol)</b>	TCP/IP is a suite of protocols used to connect to the Internet, and wide-area networks.
<b>TIFF Image Viewer</b>	An application software to view the contents of TIFF-F File. Some TIFF Image Viewers may not display the data properly.
<b>TIFF-F (Tagged Image File Format)</b>	An image file format for attachments of graphic data for smooth transmission between different units. The coding method of this format supports the same coding as Modified Huffman (MH), and multiple-page image data.
<b>Transmission Password</b>	A 4-digit password that is checked when a document is transmitted.
<b>Transmission Reservation</b>	The ability to preset a telephone number so that you may reserve a transmission while your unit is performing another function.
<b>User Parameter</b>	Programmed parameters that provide information to other stations. Examples are logo, character ID, date, and time.
<b>Verification Stamp</b>	A user selectable transmission verification stamp can be placed on scanned documents that are successfully transmitted, or stored in memory.
<b>View Mode - File List</b>	Allows you to view the brief contents of the memory files through the LCD display without having to print the Memory File List.
<b>View Mode - Journal</b>	Allows you to view the brief contents of the journal through the LCD display without having to print the journal.

# ITU-T Image No. 1

All specifications are based on the ITU-T Image No. 1 (The sample shown below is not to scale).



## THE SLEREXE COMPANY LIMITED

SAPORS LANE · BOOLE · DORSET · BH25 8 ER

TELEPHONE BOOLE (945 13) 51617 · TELEX 123456

Our Ref. 350/PJC/EAC

18th January, 1972.

Dr. P.N. Cundall,  
Mining Surveys Ltd.,  
Holroyd Road,  
Reading,  
Berks.

Dear Pete,

Permit me to introduce you to the facility of facsimile transmission.

In facsimile a photocell is caused to perform a raster scan over the subject copy. The variations of print density on the document cause the photocell to generate an analogous electrical video signal. This signal is used to modulate a carrier, which is transmitted to a remote destination over a radio or cable communications link.

At the remote terminal, demodulation reconstructs the video signal, which is used to modulate the density of print produced by a printing device. This device is scanning in a raster scan synchronised with that at the transmitting terminal. As a result, a facsimile copy of the subject document is produced.

Probably you have uses for this facility in your organisation.

Yours sincerely,

*Phil.*

P.J. CROSS  
Group Leader - Facsimile Research

Registered in England: No. 2038  
Registered Office: 80 Vicars Lane, Ilford, Essex.



# Index

## Numerics

2-Sided Transmission (Receiving) ..... 27

## A

Activating the Department Code Feature ..... 93  
Adding Telephone Numbers ..... 180  
Address Book ..... 180  
Address Book Email Addressing ..... 126  
Address Book List ..... 212  
ADF ..... 17  
Automatic Reception ..... 32  
Automatic Reduction ..... 34

## B

Batch Transmission ..... 41

## C

Communication Journal (COMM. JOURNAL) ... 209  
Confidential Mailbox ..... 57  
Contrast ..... 18  
Control Panel ..... 14

## D

Deferred Polling ..... 44  
Deferred Transmission ..... 42  
Department Code ..... 93  
Dialing Method (Tone or Pulse) ..... 175  
Direct Internet Fax XMT ..... 113  
Direct Transmission Reservation ..... 29  
DNS Server Address ..... 203  
Document Size ..... 223

## E

Edit File Mode ..... 98  
Editing the Address Book ..... 183

## F

Fax Cover Sheet ..... 73  
Fax Forward ..... 155  
Fax Parameter List ..... 214  
Fax Parameter Table ..... 190  
Fixed Reduction ..... 34  
Flatbed Scanning ..... 23

## G

Group and Program List ..... 213  
Group Dialing ..... 50

## I

Image Memory Capacity ..... 223  
Inbound Routing ..... 115, 151  
Internet Communication ..... 112  
Internet Fax Return Receipt ..... 158  
Internet Parameters ..... 2, 122  
IPv6 Address ..... 199  
ITU-T Image No. 1 ..... 236

## J

Journal ..... 205

## L

LAN Interface ..... 122  
LDAP ..... 111, 117  
Ledger Size Document Transmission ..... 129  
Loading Documents ..... 17

## M

Mailing List ..... 134  
Manual Email Addressing ..... 124  
Manual Reception ..... 32  
Memory Transmission ..... 25  
Monitor Volume ..... 176  
Multi Email Station Addressing (Broadcasting) .. 128

## O

On-Hook Dialing ..... 28  
Original (Text/Photo) ..... 20  
Overlap Printing ..... 35

## P

Pause ..... 15  
PIN Code Access ..... 87  
Polling ..... 46  
POP Email Retrieval Key ..... 141, 143  
POP Parameters ..... 137  
POP Server ..... 137  
POP3 Client ..... 109  
Pre Installation Information ..... 107  
Print Reduction Mode ..... 34  
Printing Documents ..... 85  
Program Keys ..... 50, 141

## R

Receive To Memory ..... 83  
Receiving Documents via LAN ..... 135  
Receiving Password ..... 79  
Redialing ..... 31  
Relay Network ..... 161  
Relay XMT Report (COMM. JOURNAL) ..... 173  
Relayed Transmission ..... 160  
Resolution ..... 19  
Retry an Incomplete File ..... 105  
Returned Email ..... 133  
Rotated Transmission ..... 27

## S

Scanner Resolution ..... 223  
Selective Reception ..... 91  
Sender Selection ..... 145  
Sender Selection List ..... 149  
Sending Documents via LAN ..... 124  
Sending Non-Standard Size Documents ..... 17  
Setting RCV To Memory ..... 84

## Index

Setting the RCV To Memory Password .....	83
Setting Up IPv6 .....	197
Setting Up Your Machine as an Internet Relay Station .....	163
SMTP Authentication .....	116
SMTP Mail Server .....	108
Sub-Addressing .....	66
Substitute Memory Reception .....	36

### T

Transmission Password .....	77
-----------------------------	----

### U

User Parameters .....	120, 177
-----------------------	----------

### V

Verification Stamp .....	20, 220
--------------------------	---------

memo

The following trademarks and registered trademarks are used throughout this manual:

Microsoft, Windows, Windows NT, Windows Server, Windows Vista, Excel, PowerPoint, Outlook & Windows logo are either registered trademarks or trademarks of Microsoft Corporation in the USA and other countries.

Adobe, Acrobat Reader & Adobe logo are either registered trademarks or trademarks of Adobe Systems Incorporated.

All other trademarks identified herein are the property of their respective owners.

Eudora is a registered trademark of QUALCOMM Incorporated.

PEERLESSPage™ is a trademark of the PEERLESS Systems Corporation, and PEERLESSPrint™ and Memory Reduction Technology® are registered trademarks of PEERLESS Systems Corporation, and COPYRIGHT © 2002 PEERLESS Systems Corporation.

Monotype® is a registered trademark of Monotype Imaging Inc. registered in the U.S. Patent and Trademark Office and may be registered in other jurisdictions.

ColorSet™ is a registered trademark of Monotype Imaging Inc. registered in the U.S. Patent and Trademark Office and may be registered in other jurisdictions.

ColorSet™ Profile Tool Kit, Profile Studio and Profile Optimizer are trademarks of Monotype Imaging Inc. and may be registered in certain jurisdictions.

Captaris and RightFax are trademarks of Captaris, Inc.

Novell and NetWare are registered trademarks of Novell, Inc. in the United States and other countries.

## USA Only

### ■ WARRANTY

PANASONIC COMMUNICATIONS COMPANY OF NORTH AMERICA MAKES NO WARRANTIES, GUARANTEES OR REPRESENTATIONS, EXPRESSED OR IMPLIED, TO CUSTOMER WITH RESPECT TO THIS PANASONIC MACHINE, INCLUDING BUT NOT LIMITED TO, ANY IMPLIED WARRANTY OF MERCHANTABILITY OR FITNESS FOR A PARTICULAR PURPOSE.

PANASONIC COMMUNICATIONS COMPANY OF NORTH AMERICA ASSUMES NO RISK AND SHALL NOT BE SUBJECT TO LIABILITY FOR ANY DAMAGE, INCLUDING, BUT NOT LIMITED TO DIRECT, INDIRECT, SPECIAL, INCIDENTAL OR CONSEQUENTIAL DAMAGES OR LOSS OF PROFITS SUSTAINED BY THE CUSTOMER IN CONNECTION WITH THE USE OR APPLICATION OF THIS PANASONIC MACHINE. SEE YOUR DEALER FOR DETAILS OF DEALER'S WARRANTY.

For Service, Call: \_\_\_\_\_

Panasonic Communications Company of North America  
Unit of Panasonic Corporation of North America  
One Panasonic Way  
Secaucus, New Jersey 07094  
<http://panasonic.co.jp/pcc/en/>

Panasonic Canada Inc.  
5770 Ambler Drive,  
Mississauga, Ontario L4W 2T3  
<http://www.panasonic.ca>

© 2008 Panasonic Communications Co., Ltd. All Rights Reserved.  
Unauthorized copying and distribution is a violation of law.  
The contents of these Operating Instructions are subject to change without notice.

C0708-0 (01)  
PJQMC1208ZB  
July 2008  
Published in Japan

## Free Manuals Download Website

<http://myh66.com>

<http://usermanuals.us>

<http://www.somanuals.com>

<http://www.4manuals.cc>

<http://www.manual-lib.com>

<http://www.404manual.com>

<http://www.luxmanual.com>

<http://aubethermostatmanual.com>

Golf course search by state

<http://golfingnear.com>

Email search by domain

<http://emailbydomain.com>

Auto manuals search

<http://auto.somanuals.com>

TV manuals search

<http://tv.somanuals.com>