

# Panasonic®

## Facsimile Operating Instructions (For Internet Fax)

Model No. **DX-600**

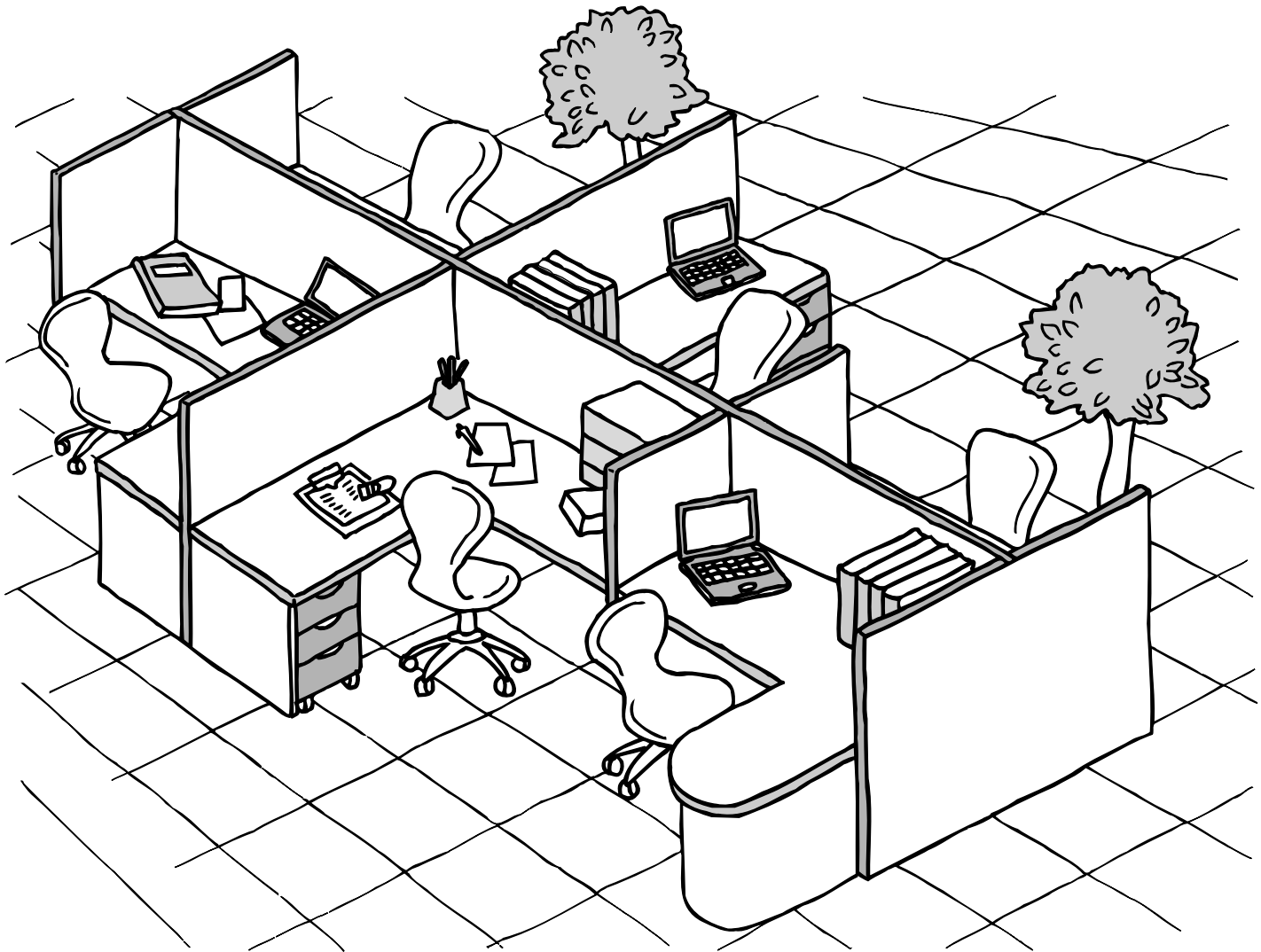

Before operating this equipment, please read these instructions completely and keep these operating instructions for future reference.

English

# IMPORTANT INFORMATION

When requesting information, supplies or service, always refer to the model and serial number of your machine. The model and serial number plate (Main Name Plate) is located on the machine as shown below. For your convenience, space is provided below to record information you may need in the future for reference or troubleshooting.

Model No.	Serial No.
Date of Purchase	
Dealer	
Address	
Telephone Number	( ) -
Supplies Telephone Number	( ) -
Service Telephone Number	( ) -

For the total system to work properly via LAN, certain information and additional parameters must be set. Please contact your network administrator for the required information and connection to the LAN.

User Information		
Company Name:		
Address:		
Dept.:		
City:	State:	Zip Code:
Tel. No.:	Fax No.:	

Internet Parameters (See page 50)		
IP Address:		
Subnet Mask:		
Default Gateway IP Address:		
Primary DNS IP Address:		
Secondary DNS IP Address:		
Email Address:		
SMTP Server IP Name:	or	SMTP Server IP Address:
POP Server Name:	or	POP Server IP Address:
POP User Name:		
POP Password: <i>(for security, do not write it in - but keep it in a safe place)</i>		
LDAP Server Name:	or	LDAP Server IP Address:
LDAP Log In Name:		
LDAP Password:		
LDAP Search Base:		
Host Name:		

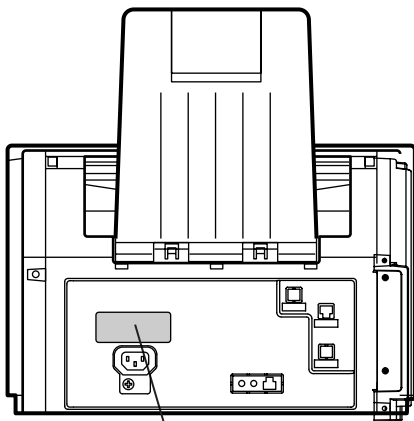

**Model and Serial Number**

Copyright © 2002 by Matsushita Graphic Communication Systems, Inc. All rights reserved. Unauthorized copying and distribution is a violation of law. Printed in Japan. The contents of these Operating Instructions are subject to change without notice.

# Table of Contents

## Getting to Know Your Machine

<b>Safety Information</b> .....	<b>9</b>
<b>Precaution</b> .....	<b>11</b>
<b>Function Key</b> .....	<b>12</b>
<b>External View</b> .....	<b>13</b>
<b>Control Panel</b> .....	<b>14</b>
<b>Pre Installation Information</b> .....	<b>16</b>
■ Setup as SMTP Mail Server.....	17
■ Setup as POP3 Client.....	18
<b>Internet Communication Features</b> .....	<b>21</b>
■ Internet Fax Transmission.....	21
■ Direct SMTP (Direct IFAX XMT).....	22
■ Internet Mail Reception.....	23
■ Inbound Routing.....	24
■ Fax Forward.....	25
■ Network Scanner.....	25
■ Network Printer.....	26
■ Relayed Transmission.....	27
■ Dynamic Host Configuration Protocol (DHCP).....	28
■ SMTP Authentication.....	28
■ Lightweight Directory Access Protocol (LDAP).....	28
<b>Important Information</b> .....	<b>29</b>

## Installing Your Machine

<b>Main Unit and Accessories</b> .....	<b>32</b>
<b>Installing the Accessories</b> .....	<b>33</b>
<b>Installing the Toner Cartridge</b> .....	<b>34</b>
<b>Loading the Recording Paper</b> .....	<b>36</b>
■ How to Load the Recording Paper.....	36
<b>Adjusting the Paper Cassette for the Paper Length</b> .....	<b>38</b>
■ How to Adjust the Paper Cassette for the Paper Length.....	38
<b>Adjusting the Paper Cassette for the Paper Width</b> .....	<b>39</b>
■ How to Adjust the Paper Cassette for the Paper Width.....	39
<b>Connecting the LAN Cable, Telephone Line Cable and Power Cord</b> .....	<b>40</b>
<b>Setting Your Country Code</b> .....	<b>42</b>
<b>Setting the Dialling Method (Tone or Pulse)</b> .....	<b>43</b>
<b>Adjusting the Volume</b> .....	<b>44</b>
<b>User Parameters</b> .....	<b>45</b>
■ General Description.....	45
■ Setting the Date and Time.....	45
■ Setting Your LOGO.....	46
■ Setting Your Character ID.....	47
■ Setting Your ID Number (Fax Telephone Number).....	48
<b>Setting the Internet Parameters</b> .....	<b>49</b>
■ Setting the User (Internet) Parameters.....	49
■ Setting the User Parameters for the LAN Interface.....	50

# Table of Contents

## Installing Your Machine

<b>Programming or Retrieving Parameters via Email.....</b>	<b>51</b>
■ Using Email to Program or Retrieve Parameters .....	51
■ Using a PC to Input the Internet Parameters Remotely .....	51
■ To Input the Internet Parameters for the First Time .....	52
■ To Retrieve the Internet Parameters for Backup .....	54
■ To Edit the Retrieved or Backup Internet Parameters File .....	57
■ Using a PC to Update the Auto Dialler Remotely .....	60
■ Deleting the Entire Auto Dialler .....	61
■ To Program One-Touch/ABBR. No. for the First Time.....	62
■ To Retrieve One-Touch/ABBR. No. Data for Backup .....	64
■ To Edit the Retrieved or Backup One-Touch/ABBR. No. Data File .....	66
■ Using Email to Retrieve the Journal.....	68

## Programming Your Machine

<b>Programming Email Address and Telephone Numbers .....</b>	<b>69</b>
■ Programming the Auto Dialler .....	69
■ Editing or Erasing the Auto Dialling Number / Email Address.....	73
■ Printing Out a Directory Sheet .....	76
<b>Customizing Your Machine .....</b>	<b>77</b>
■ General Description .....	77
■ Setting the Fax Parameters .....	77
■ Fax Parameter Table .....	78

## Basic Operations

<b>Loading Documents.....</b>	<b>85</b>
■ Documents You Can Send .....	85
■ Documents You Cannot Send .....	85
■ How to Load Documents.....	86
<b>Basic Transmission Settings .....</b>	<b>87</b>
■ General Description .....	87
■ Contrast .....	87
■ Resolution .....	87
■ Verification Stamp.....	88
■ Communication Journal (COMM. JOURNAL) .....	89

## Basic Operations

<b>Sending Documents via LAN .....</b>	<b>90</b>
■ General Description.....	90
■ Manual Email Addressing.....	91
■ One-Touch Email Addressing .....	92
■ Abbreviated Email Addressing .....	93
■ Directory Search Dialling.....	94
■ Multi-Station Transmission (Broadcasting).....	96
■ Memory Transmission Reservation (Multi-tasking) .....	97
■ Automatic Redialling.....	98
■ Manual Redialling.....	98
■ Selectable Domains .....	99
■ Internet Fax Delivery Notice (MDN) .....	101
■ Returned Email.....	102
■ Using a Mailing List .....	103
<b>Sending Documents via Telephone Line .....</b>	<b>104</b>
■ General Description.....	104
■ Memory Transmission .....	105
■ Direct Transmission.....	111
■ Voice Mode Transmission .....	115
■ Transmission Reservation.....	117
■ Redialling.....	120
<b>Receiving Documents via LAN .....</b>	<b>122</b>
■ General Description.....	122
■ Receiving Email from a POP Server .....	124
<b>Receiving Documents via Telephone Line .....</b>	<b>127</b>
■ Reception Modes .....	127
■ Telephone Mode .....	128
■ Fax / Tel Auto Switching Mode.....	129
■ Fax Mode .....	130
■ TAM (Telephone Answering Machine) Interface Mode .....	131
■ Print Reduction.....	133
■ Receiving Oversize Documents .....	134
■ Substitute Memory Reception .....	135
■ Print Collation Mode .....	135
<b>Making Copies .....</b>	<b>136</b>

# Table of Contents

<b>Advanced Features</b>	
<b>Timer Controlled Communications .....</b>	<b>137</b>
■ General Description .....	137
■ Deferred Transmission.....	137
■ Deferred Polling .....	138
<b>Polling .....</b>	<b>139</b>
■ General Description .....	139
■ Setting the Polling Password .....	139
■ Preparing to be Polled .....	140
■ To Poll Documents from Another Station.....	141
<b>Program Keys .....</b>	<b>142</b>
■ General Description .....	142
■ Setting for Group Dialling.....	142
■ Setting for Deferred Transmission .....	143
■ Setting for Deferred Polling.....	144
■ Setting for Normal Polling .....	145
■ Setting for One-Touch Key .....	146
■ Setting the POP Access Key .....	147
■ Using the POP Access Key .....	148
■ Changing or Erasing the Program Key Settings .....	149
<b>Sender Selection .....</b>	<b>150</b>
■ General Description .....	150
■ Setting the Sender Selection .....	150
■ Sending Document with Sender Selection.....	152
■ Printing the Sender Selection List.....	153
<b>Subject Line Entry .....</b>	<b>154</b>
■ General Description .....	154
■ Sending Email with Subject Line Entry .....	154
<b>Inbound Routing.....</b>	<b>156</b>
■ Setting the Routing Parameters.....	156
■ Entering One-Touch/Abbreviated Dialling Numbers for Inbound Routing.....	158
<b>Edit File Mode .....</b>	<b>160</b>
■ General Description .....	160
■ Printing a File List .....	160
■ Viewing the Contents of a File List.....	161
■ Changing the Start Time or the Station of a File.....	162
■ Deleting a File .....	164
■ Printing Out a File .....	165
■ Adding Documents into a File .....	166
■ Retry an Incomplete File .....	167
<b>Access Code .....</b>	<b>168</b>
■ General Description .....	168
■ Setting the Access Code.....	168
■ Operating Your Machine with the Access Code (Restrict all Operations) .....	169
■ Operating Your Machine with the Access Code (Restrict Access of Fax Parameters Only).....	169

## Advanced Features

<b>Receive To Memory</b> .....	<b>170</b>
■ General Description.....	170
■ Setting the RCV To Memory Password.....	170
■ Setting RCV To Memory .....	170
■ Printing Out Documents .....	171
<b>Distinctive Ring Detector (DRD)</b> .....	<b>172</b>
■ General Description.....	172
<b>Fax Cover Sheet</b> .....	<b>173</b>
■ General Description.....	173
■ To use the Fax Cover Sheet .....	173
<b>PIN Code Access</b> .....	<b>175</b>
■ General Description.....	175
■ Selecting the Access Method (Prefix or Suffix) .....	175
■ Dialling with a PIN Code.....	176
<b>Fax Forward</b> .....	<b>177</b>
■ Setting Fax Forward .....	177
<b>Ifax Return Receipt</b> .....	<b>178</b>
■ General Description.....	178

## Network Features

<b>Network Scanner</b> .....	<b>179</b>
■ General Description.....	179
<b>Network Printer</b> .....	<b>180</b>
■ General Description.....	180
<b>Relayed Transmission</b> .....	<b>181</b>
■ General Description.....	181
■ Relay Network .....	182
■ Setting up your machine as an Internet Relay Station .....	184
■ Setting Up Your Machine for Relayed Transmission.....	185
■ Sending Documents via Internet Relay .....	187
■ Sending Document(s) from a PC to a G3 Fax Machine .....	190
■ Printouts and Reports.....	192
<b>Selective Reception</b> .....	<b>194</b>
■ General Description.....	194
■ Setting the Selective Reception .....	194
<b>Password Communications</b> .....	<b>195</b>
■ General Description.....	195
■ Compatibility with Other Machines .....	195
■ Setting Password Transmission .....	196
■ Setting Password Reception .....	197
■ Using Password Transmission .....	198
■ Using Password Reception .....	199

# Table of Contents

## Network Features

<b>Confidential Mailbox</b> .....	<b>200</b>
■ General Description .....	200
■ Confidential Mailbox.....	200
■ Sending a Confidential Document to a Remote Station's Mailbox.....	201
■ Polling a Confidential Document from a Remote Station's Mailbox.....	202
■ Receiving a Confidential Document to Your Machine's Mailbox.....	203
■ Storing a Confidential Document in Your Machine's Mailbox .....	204
■ Printing Out a Confidential Document from Your Machine's Mailbox .....	205
■ Deleting a Confidential Document Stored in Your Machine's Mailbox .....	206
<b>Sub-addressing</b> .....	<b>207</b>
■ General Description .....	207
■ To set the Sub-address into a One-Touch/ABBR. Dialling Numbers.....	208
■ To send a Document with Sub-address.....	209

## Printout Journals and Lists

<b>Journals and Lists</b> .....	<b>210</b>
■ General Description .....	210
■ Transaction Journal .....	210
■ Individual Transmission Journal (IND. XMT JOURNAL).....	211
■ Communication Journal (COMM. JOURNAL).....	214
■ One-Touch/Abbreviated and Directory Search List .....	216
■ Program List.....	219
■ FAX Parameter List.....	220
■ Toner Cartridge Order Forms .....	221

## Problem Solving

<b>Troubleshooting</b> .....	<b>222</b>
■ Information Codes.....	226
■ Email ABBR Programming Errors .....	229
■ Clearing a Recording Paper Jam .....	231
■ Clearing a Document Jam .....	232
■ Cleaning the Document Scanning Area.....	233
■ Cleaning the Printer Roller.....	234
■ Adjusting the Automatic Document Feeder (ADF).....	235
■ Verification Stamp.....	236
■ Checking the Telephone Line .....	237

## Appendix

<b>Specifications</b> .....	<b>238</b>
<b>Recording Paper Specifications</b> .....	<b>241</b>
<b>Options and Supplies</b> .....	<b>242</b>
■ Installing the Flash Memory Card .....	243
<b>Regulatory Information</b> .....	<b>244</b>
<b>Glossary</b> .....	<b>247</b>
<b>ITU-T Image No. 1</b> .....	<b>252</b>
<b>Index</b> .....	<b>253</b>



# Safety Information

**⚠ WARNING** denotes a potential hazard that could result in serious injury or death.

- TO PREVENT FIRE OR SHOCK, DO NOT EXPOSE THIS PRODUCT TO RAIN OR ANY TYPE OF MOISTURE.
- TO MINIMIZE THE POSSIBILITY OF SHOCK OR DAMAGE TO THE MACHINE, IT MUST BE PROPERLY GROUNDED.
- THIS PRODUCT UTILIZES A LASER. ONLY QUALIFIED SERVICE PERSONNEL SHOULD ATTEMPT TO SERVICE THIS DEVICE DUE TO POSSIBLE EYE INJURY.

**CAUTION** - USE OF CONTROLS OR ADJUSTMENTS OR PERFORMANCE OF PROCEDURES OTHER THAN THOSE SPECIFIED HEREIN MAY RESULT IN HAZARDOUS RADIATION EXPOSURE.



- THE MAINS PLUG ON THIS EQUIPMENT MUST BE USED TO DISCONNECT THE MAINS POWER. PLEASE ENSURE THAT THE SOCKET OUTLET IS INSTALLED NEAR THE EQUIPMENT AND SHALL BE EASILY ACCESSIBLE.
- MAKE SURE THAT THE MACHINE IS INSTALLED IN A SPACIOUS OR WELL VENTILATED ROOM SO AS NOT TO INCREASE THE AMOUNT OF OZONE IN THE AIR. SINCE OZONE IS HEAVIER THAN AIR, IT IS RECOMMENDED THAT AIR AT FLOOR LEVEL BE VENTILATED.

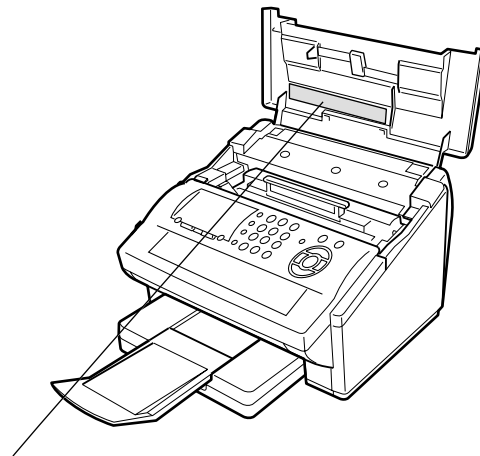

- **DANGER** : Invisible laser radiation when open and interlock defeated. AVOID DIRECT EXPOSURE TO BEAM.
- **CAUTION** : Invisible and hazardous laser radiation when interlocks defeated. AVOID EXPOSURE TO BEAM.
- **ATTENTION** : Rayonnement laser invisible dangereux lorsque la sécurité est neutralisée. EXPOSITION DANGEREUSE AU FAISCEAU.
- **VORSICHT** : Unsichtbare Laserstrahlung, wenn Sicherheitsverriegelung überbrückt. NICHT DEM STRAHL AUSSETZEN.
- **PELIGRO** : Cuando se invalida el bloqueo, se producen radiaciones invisibles de láser. EVITESE LA EXPOSICIÓN DIRECTA A TALES RAYOS.
- **VARO!** : Näkymätöntä ja vaarallista lasersäteilyä suojalukitus ohitettaessa. Vältä suoraan altistumista säteelle.
- **ADVARSEL** : USYNLIG LASERSTRÅLING NÅR SIKKERHEDSAF-BRYDERE ER UDE AF FUNKTION. UNDGÅ UDSETTELSE FOR STRÅLING.
- **ADVARSEL** : USYNLIG LASERSTRÅLING NÅR SIKKERHEDS-LÅS BRYTES. UNNGÅ EKSPONERING FOR STRÅLEN.
- **WARNING** : OSYNLIG LASERSTRÅLING NÅR SPÄRRAR ÄR URKOPPLADE. STRÅLEN ÄR FARLIG.
- **注意** : 为防止激光照射, 当连接本机时, 请勿暴露在光柱下。
- **주의** : 연결장치가 고장 났을 때에는 눈에 보이지않고 위험한 레이저 방사선이 빛에 직접 닿지않도록 해 주십시오.

FBS8902

# Safety Information

**⚠ CAUTION** denotes hazards that could result in minor injury or damage to the machine.

- TO REDUCE THE RISK OF SHOCK OR FIRE, USE ONLY NO. 26 AWG OR LARGER TELEPHONE LINE CABLE.
- DISCONNECT ALL POWER TO THE MACHINE BEFORE COVER(S) ARE REMOVED. REPLACE THE COVER(S) BEFORE THE UNIT IS RE-ENERGIZED.

## **⚠ IMPORTANT SAFETY INSTRUCTIONS**

When using your telephone equipment, basic safety precautions should always be followed to reduce the risk of fire, electric shock and injury to persons, including the following:

- DO NOT USE THIS PRODUCT NEAR WATER, FOR EXAMPLE, NEAR A BATH TUB, WASH BOWL, KITCHEN SINK OR LAUNDRY TUB, IN A WET BASEMENT OR NEAR A SWIMMING POOL.
- AVOID USING A TELEPHONE (OTHER THAN A CORDLESS TYPE) DURING AN ELECTRICAL STORM. THERE MAY BE A REMOTE RISK OF ELECTRIC SHOCK FROM LIGHTNING.
- DO NOT USE THE TELEPHONE TO REPORT A GAS LEAK IN THE VICINITY OF THE LEAK.
- USE ONLY THE POWER CORD INDICATED IN THIS MANUAL.

# Precaution

**⚠ CAUTION** denotes hazards that could result in minor injury or damage to the machine.

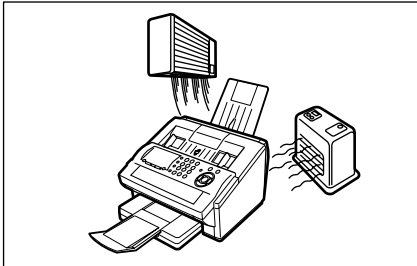

Do not install the machine near heating or an air conditioning unit.

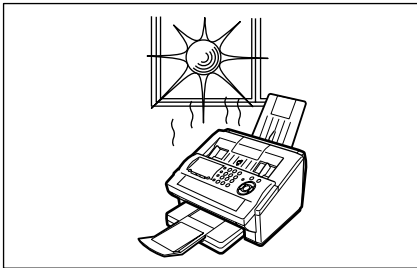

Avoid exposure to direct sunlight.

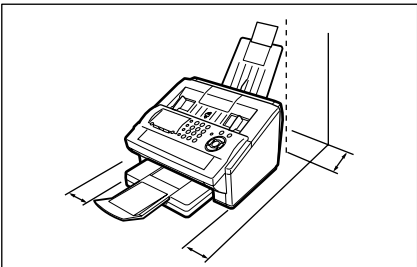

Install the machine on a flat surface, leave at least 4 inches (10 cm) of space between the machine and other objects.

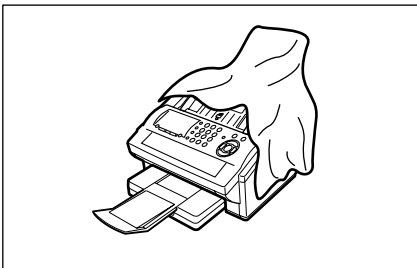

Do not block the ventilation openings.

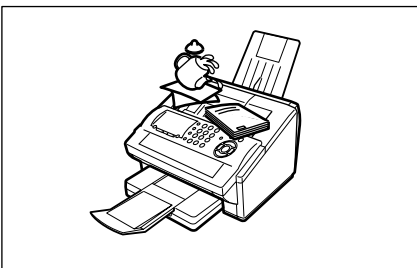

Do not place heavy objects or spill liquids on the machine.

# Function Key

Any function can be started by first pressing **FUNCTION** and then enter the function number, or by pressing **▼** or **▲** scroll key repeatedly until the desired function appears on the display.

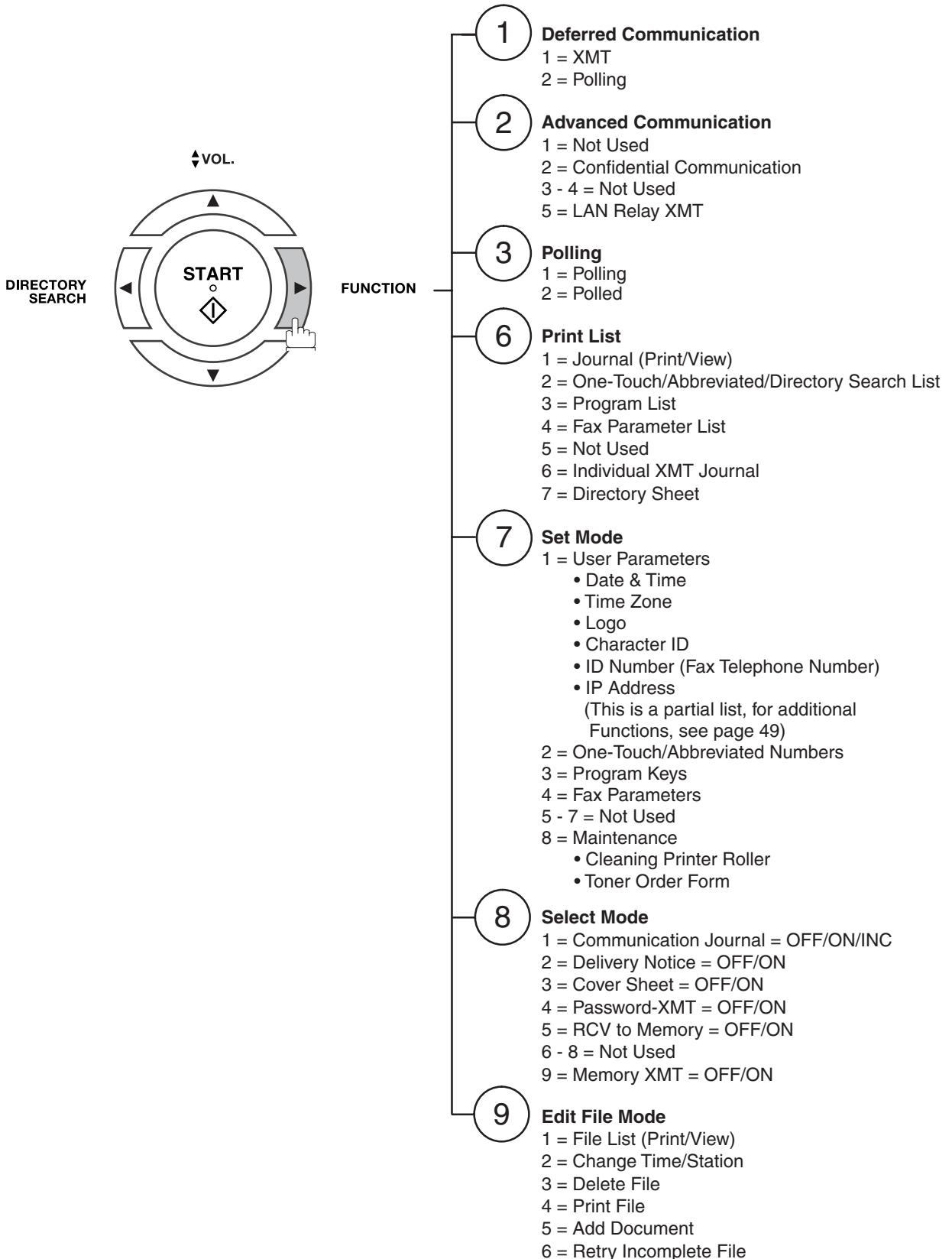



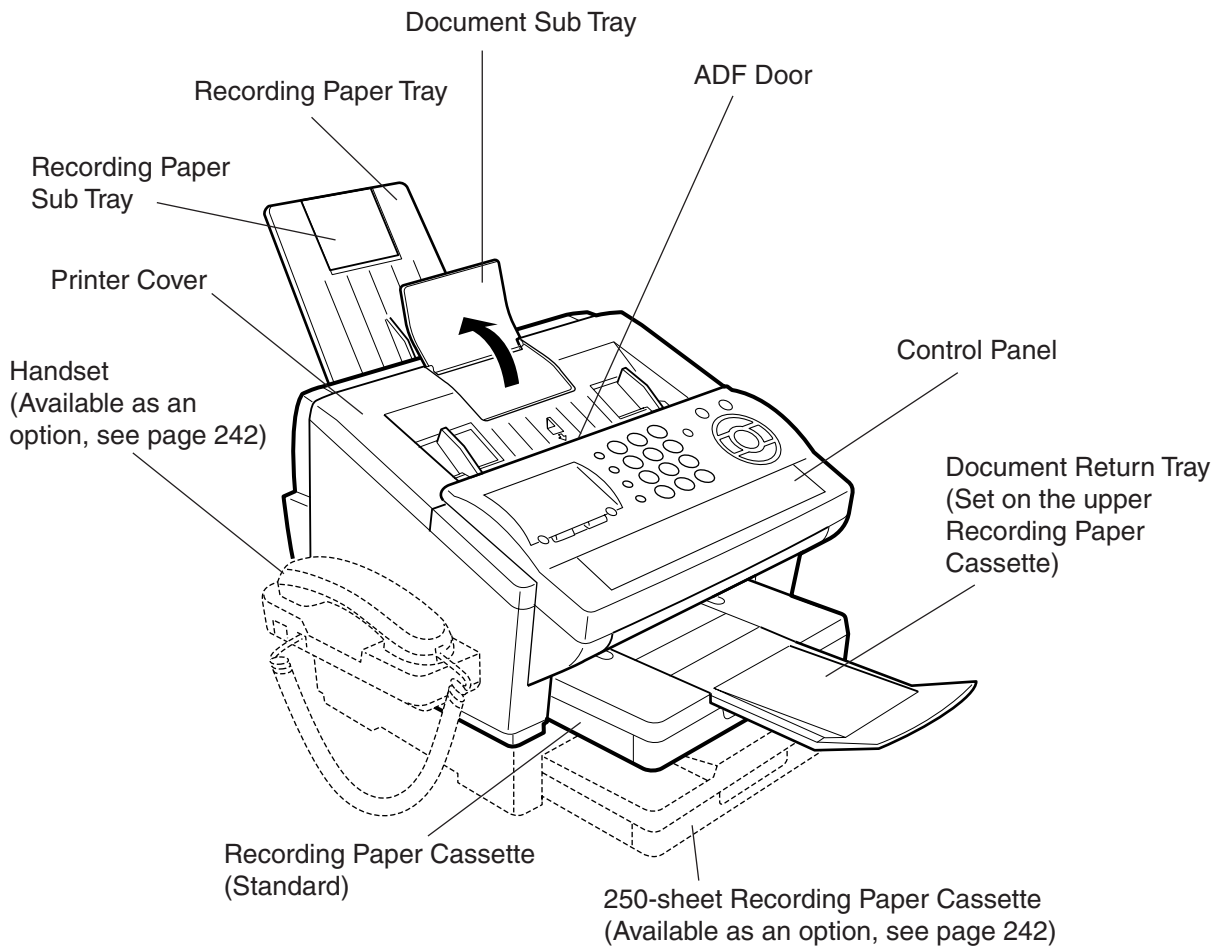

# External View



## NOTE





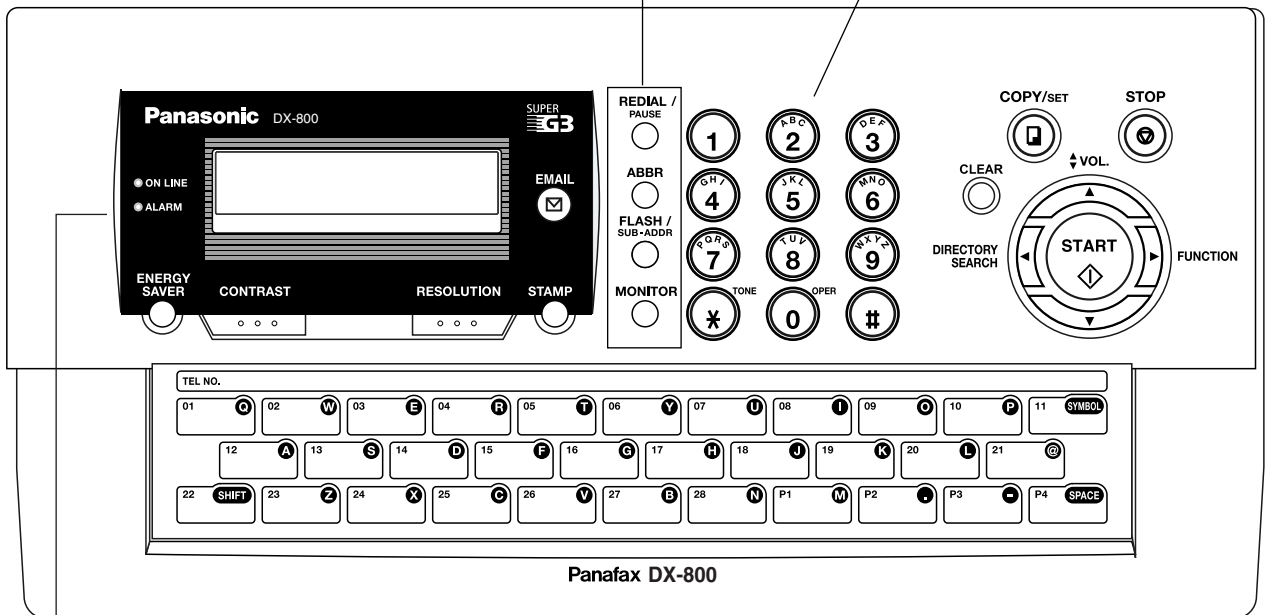

1. For some countries, the handset may not be available because of the country's regulation or specification.

# Control Panel

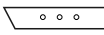
- 
 - Used to enter a pause when recording or dialing a telephone number, or to redial the last dialed number.
- 
 - Used to start Abbreviated Dialing. (See pages 108 and 113)
- 
 - Used to separate the Sub-Address from the telephone number when dialing, or to access some features of your PBX.
- 
 - Used to start On-Hook Dialing. (See page 116)

- Keypad**
- Used for manual number dialing, recording phone numbers, and numerical entries.
- Tone Key**
- Used to temporarily change the dialing mode to Tone when Pulse mode is set. As a convenience it can also be used to enter a period "." while entering IP Address information.



- 
 - Used to switch the machine into energy saving mode. (See page 80)
- 
 - Used to set Normal, Lighter or Darker. (See page 87)
- 
 - Used to set Standard, Fine, Super-Fine, Halftone (Fine) or Halftone (S-Fine). (See page 87)
- 
 - Used to turn the verification stamp On or OFF. Lights when the verification stamp is set to ON.
- 
 - Blinks when the machine is transmitting a document or receiving.
- 
 - Lights when trouble occurs.
- 
 - Used to select Email communication (Internet Fax).

**STOP**



- Press this button when you want to stop the communication, registration operation, or audible tone.

**COPY / SET**



- Used to make copies and set operations. (See page 136)

**CLEAR**



- Used to reset all the previously set functions.
- Used to correct entered numbers or characters (Backspace).



Used for the following:

- Start or select a function.
- Search for a station name. (See pages 94, 109 and 114)
- Adjust the monitor and ringer volumes. (See page 44)
- Move the cursor while entering numbers and characters.
- Search the station name for Directory Search Dialing.
- Confirm the entered station for multi-station communication.
- Confirm the current communication modes (e.g. Page number, ID, Dialed Telephone number, File number) when the unit is ON LINE.

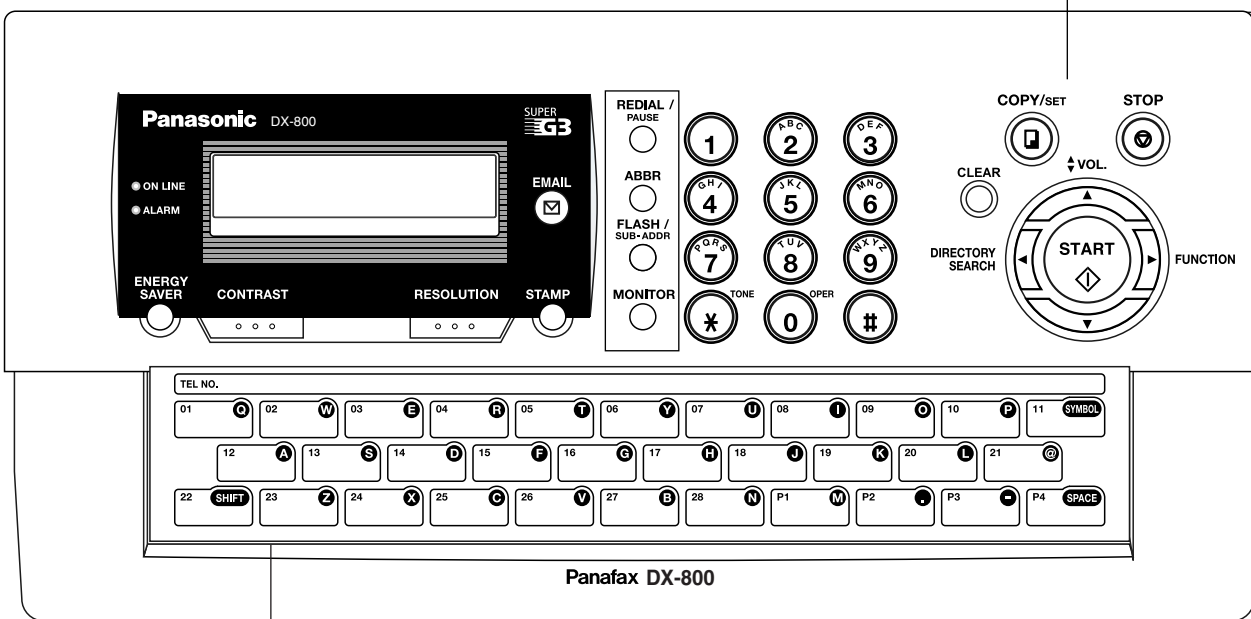

### One-Touch Keys (01-28)



- Used for One-Touch Dialing. (See pages 92, 108 and 112)

### Program Keys (P1-P4)

- Used to record long dialing procedures or Group Dialing Number keys. (See pages 142 to 149)

### Character Keys

- The One-Touch Keys and Program Keys serve as character and symbol input keys which are used to record your LOGO, character ID and station name.

- SYMBOL** - Used to enter a symbol for the LOGO, character ID, station name and for the email address. Use  or  to select the desired symbol(s).
- SPACE** - Used to insert a space while entering LOGO, character ID, station name and email address.
- SHIFT** - Used to switch between upper and lower character set.

# Pre Installation Information

Before setting up your Panasonic machine on your network, please read this entire section to be familiar with its functions.

Your machine is able to perform the following when connected to a 10Base-T/100Base-TX Ethernet LAN (local area network):

- Send paper-based information as an Internet Email.
- Send Internet fax message (Direct IFAX XMT).
- Receive and print an Internet Email automatically.
- Forward received G3 fax message or Email automatically to the preprogrammed Email address or regular G3 fax machine (see "Fax Forward" on pages 177).
- Route received G3 fax message automatically to the sender-specified Email address or G3 fax machine using ITU-T SUB-Address (see "Inbound Routing" on pages 156 to 159).
- Route received G3 fax messages automatically to the preprogrammed Email address or G3 fax machine using the sender's fax ID code (see "Inbound Routing" on pages 156 to 159).
- Relay an Internet Email to a G3 fax machine via regular fax transmission (see "Relayed Transmission" on pages 181 to 194).
- Network scanning and printing.

To utilize the above functions, your machine needs to be set up properly on your network. **Please contact your network administrator for actual network setup.**

Copy the Pre-installation Information form found at the end of this section on page 19, record the MAC Address on the form and ask your network administrator to complete the remaining information on the form. The MAC Address of your machine can be found in the Fax Parameter List printout (press **FUNCTION** **6** **4** **SET** ).

Your machine can be set up as either **SMTP mail server** or **POP3 client**. Dependent on the type of setup, different functions are available as follows.

Function	SMTP Server Setup	POP3 Client Setup
Sending paper-based information as an Internet Email	Yes	Yes
Sending and Receiving the Internet fax message with Direct SMTP protocol.	Yes	No
Receive and print an Internet Email automatically	Yes	Yes
Receive and print an Internet Email manually	No	Yes
Forward received G3 fax message or Email automatically	Yes	Yes
Route received G3 fax message automatically	Yes	Yes
Relay an Internet Email to G3 fax machine	Yes	No

## NOTE

1. To function as SMTP mail server, your machine's email address must include its unique Host name within your company domain. This unique Host name must be registered within your network's DNS (Domain Name System) server. Example: Internet\_Fax@fax01.panasonic.com
2. Automatically refers to immediate SMTP transfer or immediate POP3 retrieval. Manually refers to manual retrieval of mail when configured as POP3 client.
3. If you are using DHCP to acquire the network parameters, contact your Network Administrator to reserve the obtained IP Address printed on the Fax Parameter List.
4. Your machine will receive, print, forward or relay emails in text message format and TIFF-F image file attachment only.



## Pre Installation Information

## Setup as SMTP Mail Server

To install your machine as SMTP mail server, the following network parameters need to be programmed on your network and on your machine.

- IP Address of the DNS Server (if not available, see Note 2)
- IP Address of your machine
- Subnet Mask of your machine
- Name or IP Address of the Default SMTP mail server
- IP Address of the Default Gateway
- Email Address of your machine (see Note 1)
- Host Name
- SMTP Authentication Name (when authentication with the SMTP server is required)
- SMTP Authentication Password (when authentication with the SMTP server is required)

## Email (from your machine to a PC) and Direct IFAX XMT Transmission

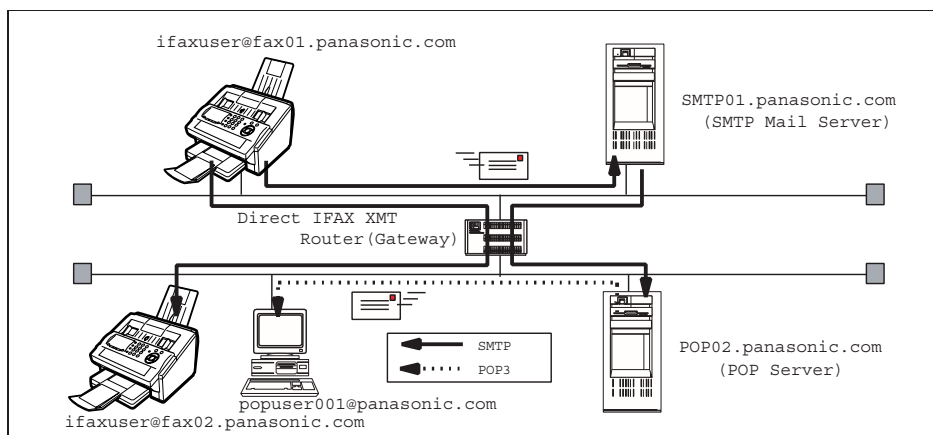

## Email (from a PC to your machine) and Direct IFAX XMT Reception

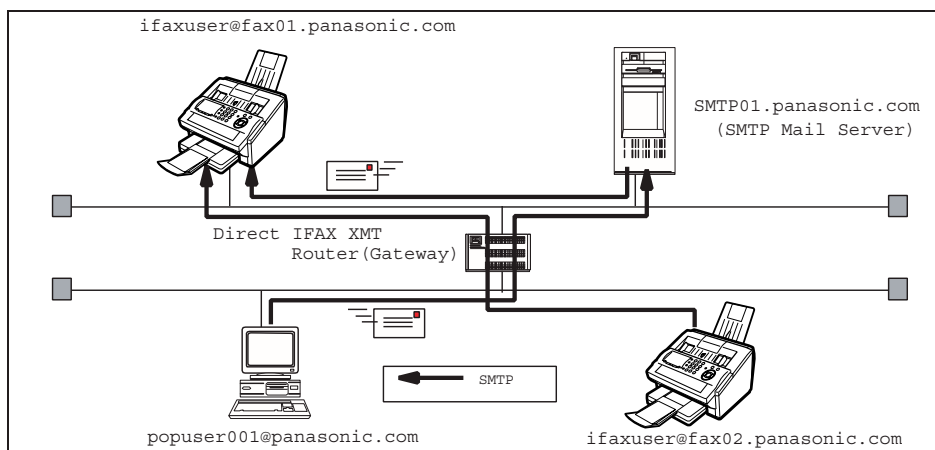

## NOTE

1. To function as SMTP mail server, your machine's email address must include its unique Host name within your company domain. This unique Host name must be registered within your network's DNS (Domain Name System) server. Example: Internet\_Fax@fax01.panasonic.com
2. By default the machine requires the IP Address of the DNS Server and prompts you to enter the SMTP Server Name. If the DNS Server is not available, change the Fax Parameter No. 161 (DNS SERVER) to "1:Invalid". Then the machine will prompt you to enter the IP Address of the SMTP Server.

# Pre Installation Information

## Setup as POP3 Client

To install your machine as POP3 Client, the following network parameters need to be programmed on your network.

- IP Address of the DNS Server (if not available, see Note 2)
- IP Address of your machine
- Subnet Mask of your machine
- Name or IP Address of the Default SMTP mail server
- IP Address of the Default Gateway
- POP Server Name or IP Address
- POP User Account Name
- POP Password
- Email Address of your machine (see Note 1)

### Email Transmission (from your machine to a PC)

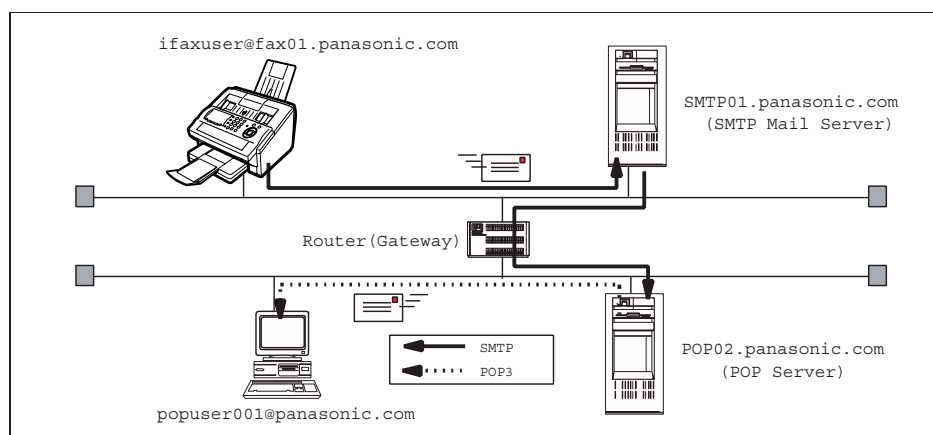

### Email reception (from a PC to your machine)

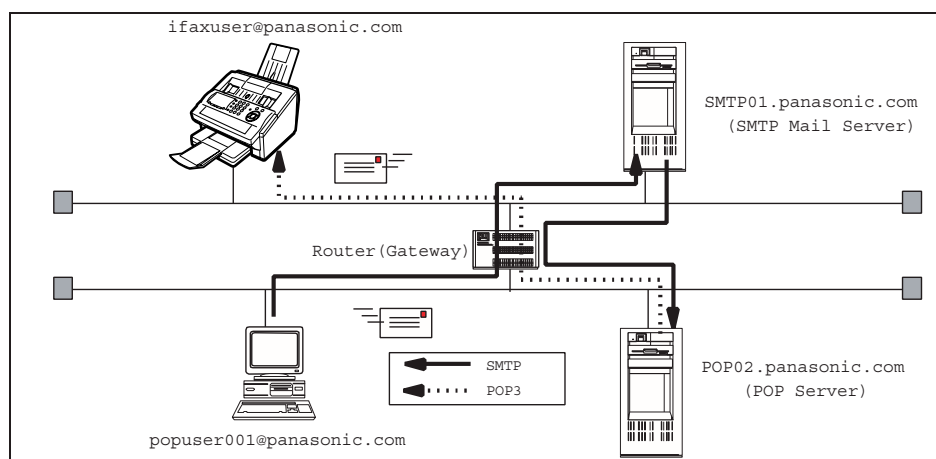

### NOTE

1. The email address format can be the same as your regular email address. If your email address is `popuser001@panasonic.com`, your machine's email address can be `Internet_Fax@panasonic.com`.
2. By default the machine requires the IP Address of the DNS Server and prompts you to enter the SMTP and POP Server Names. If the DNS Server is not available, change the Fax Parameter No. 161 (DNS SERVER) to "1:Invalid". Then the machine will prompt you to enter the IP Address of the SMTP and POP Servers.

## Pre Installation Information

For the total system to work properly via LAN, certain information and additional parameters must be set. Please contact your network administrator for the required information and connection to the LAN.

**Important:** Make a copy of this page and ask the Network Administrator to complete the required information. After its returned, transfer the information to the back side of the front cover of this manual for future reference and troubleshooting.

User Information		
Company Name		
Address		
Dept.		
City	State	Zip Code
Tel. No.	Fax No.	

Internet Parameters (See page 50)		
(1) <b>IP Address:</b>		
(2) <b>Subnet Mask:</b>		
(3) <b>Default Gateway IP Address:</b>		
(4) <b>Primary DNS IP Address:</b>		
(5) <b>Secondary DNS IP Address:</b>		
(6) <b>Email Address:</b>		
(7) <b>SMTP Server IP Name :</b>	or	<b>*SMTP Server IP Address:</b>
(8) <b>POP Server Name:</b>	or	<b>*POP Server IP Address:</b>
(9) <b>POP User Name:</b>		
(10) <b>POP Password:</b>		
(11) <b>LDAP Server Name:</b>	or	<b>LDAP Server IP Address</b>
(12) <b>LDAP Log In Name:</b>		
(13) <b>LDAP Password:</b>		
(14) <b>LDAP Search Base:</b>		
(15) <b>Host Name:</b>		
(16) <b>Default Subject:</b>		
(17) <b>Default Domain:</b>		
(18) <b>Selectable Domains:</b>		
1.	6.	
2.	7.	
3.	8.	
4.	9.	
5.	10.	
(19) <b>Remote Password:</b>		
(20) <b>Relay XMT Password:</b>		
(21) <b>Manager's Email Address:</b>		
(22) <b>Relay Domains (Domains Authorized for Relay Transmission):</b>		
1.	6.	
2.	7.	
3.	8.	
4.	9.	
5.	10.	
(23) <b>Community Name (1):</b>		
(24) <b>Community Name (2):</b>		
(25) <b>Device Name:</b>		
(26) <b>Device Location:</b>		

### NOTE

1. Items in Bold, depict information obtained from you Network Administrator.
2. By default the machine requires the IP Address of the DNS Server and prompts you to enter the SMTP and POP Server Names (items 3 and 7 above). If the DNS Server is not available, change the Fax Parameter No. 161 (DNS SERVER) to "1:Invalid". Then the machine will prompt you to enter the IP Address of the SMTP and POP Servers.
3. If required, the MAC Address of your machine can be obtained from the Fax Parameter List printout, by pressing **FUNCTION** **6** **4** **SET**.

# Pre Installation Information

## Explanation of Contents

- MAC Address : MAC Address of your machine can be found in the Fax Parameter List printout (press **FUNCTION** **6** **4** **SET** ).
- (1) IP Address : The Internet Protocol (IP) address assigned to your machine.
- (2) Subnet Mask : The Subnet Mask number.
- (3) Default Gateway IP Address : The Default Gateway's IP Address.
- (4) Primary DNS Server IP Address : The IP address of the Primary DNS Server.
- (5) Secondary DNS Server IP Address : The second IP address of the Primary DNS Server.
- (6) Email Address : The email address assigned to your machine. (Up to 60 characters)
- (7) SMTP Server Name or SMTP Server IP Address : The SMTP Server Name (up to 60 characters). The SMTP Server IP Address.
- (8) POP Server Name or POP Server IP Address : The POP Server Name. (Up to 60 characters) The POP Server IP Address.
- (9) POP User Name : POP User Name. (Up to 40 characters)
- (10) POP Password : POP Password. (Up to 10 characters)
- (11) LDAP Server Name : The LDAP Server Name or IP Address. (Up to 60 characters)
- (12) LDAP Log In Name : LDAP Login Name. (Up to 40 characters)
- (13) LDAP Password : LDAP Password. (Up to 10 characters)
- (14) LDAP Search Base : LDAP Search Base. (Up to 60 characters)
- (15) Default Subject : The information to be added to the Subject Line for all outgoing emails. (Up to 40 characters)
- (16) Default Domain : Specify the Domain Name (up to 50 characters) to be added to frequently used or incomplete outgoing email addresses (i.e. @yourcompany.com).
- (17) Host Name : The name assigned to your machine. (Up to 60 characters)
- (18) Selectable Domains : Enter up to 10 Domain Names that can be selected during manual email addressing. (Up to 30 characters)
- (19) Remote Password : Enter a security password (up to 10 characters) to allow Remote Programming of the Internet Parameters and Auto Dialler or the retrieval of the Journal via email.
- (20) Relay XMT Password : Enter a password to provide network security to your Relay Station (for G3 relay purposes). (Up to 10 characters)
- (21) Manager's Email Address : Enter you Department Manager's email address for notification of all Internet relayed transmissions for supervision and cost control purposes. (Up to 60 characters)
- (22) Relay Domain (01 to 10) : Enter up to 10 Domain Names that are authorized to access your Internet Fax for Relayed Transmission Request. (Up to 30 characters)
- (23) Community Name (1) : Community Name used for the Network Device Locator. (Up to 32 characters).
- (24) Community Name (2) : Community Name used for the Network Device Locator. (Up to 32 characters).
- (25) Device Name : Device Name used for the Network Device Locator. (Up to 32 characters).
- (26) Device Location : Device Location for the Network Device Locator. (Up to 32 characters).

### NOTE

1. All IP Addresses consist of 4 parts separated by periods "." (i.e. 165.113.245.2). For your convenience, you can use the TONE key to enter a period "." while entering the IP Address information.

# Internet Communication Features

## Internet Fax Transmission

Your machine allows you to transmit documents over the Internet to another Internet Fax or a PC. The document is first scanned and converted into a TIFF-F formatted image file, and then transmitted to the remote location as an attachment file to an email using MIME encoding.

The email system at the receiving end must support MIME. Otherwise, the attachment file will be detached and lost.

When you send an email message to someone, your machine uses Simple Mail Transfer Protocol (SMTP) to transfer your outgoing mail to your SMTP mail server, which in turn uses SMTP to send your mail to the Internet.

## Internet Fax Delivery Notice (MDN)



If the sender (Internet Fax) desires a processing confirmation, it must request a Message Disposition Notification when sending the message itself to a device supporting this notification function.

Several email applications such as Eudora and Outlook Express support and are able to respond to the delivery confirmation notification sent from the Internet Fax. As well as send a request for notification to the Internet Fax by email applications that support MDN (Message Disposition Notification) function.

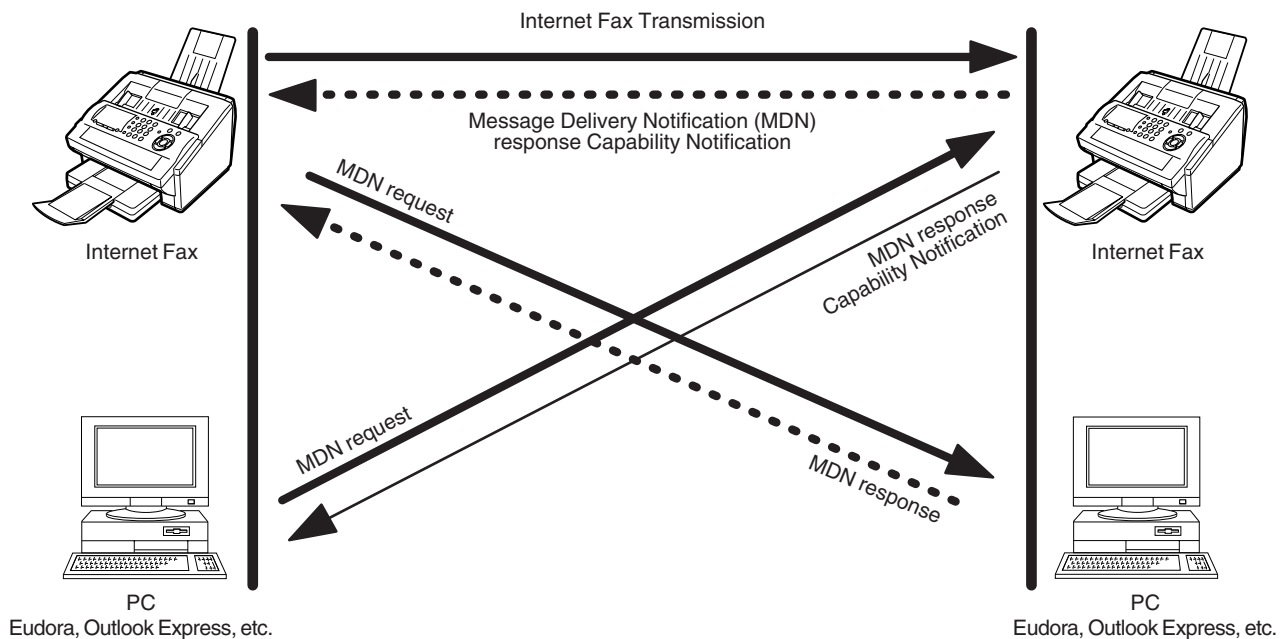
For additional details on MDN, consult a suitable reference such as the Help file and the User's guide of each respective email application.



Legend :

-  : MDN Request from the Originator
-  : MDN Response with Capability Notification from the Receptient
-  : MDN Response from the Recipient

# Internet Communication Features

## Direct SMTP (Direct IFAX XMT)

Simple Mail Transfer Protocol (SMTP) is used to transfer mail reliably and efficiently. An important feature of SMTP is its capability to transport mail across networks, usually referred to as SMTP mail relay by employing SMTP server.

Direct SMTP allows you to transmit documents to another Internet Fax directly without using an SMTP server. For this feature to work reliably, the IP Address should remain unchanged (ask your Network Administrator to reserve the IP Address). The Domain Name of the machines and other record information must be properly registered in the DNS server.

Further more, in common cases only email and web service from the Internet are permitted into the corporate intranet, and corporate network administrators are extremely unwilling to open the firewall for other, incoming services, since each opened path represents additional, potential security threats.

This makes Direct SMTP attractive because it can operate throughout the organization's Intranet.

Capability exchanges and content negotiations are also available to take advantageous communication between Internet Fax communications.

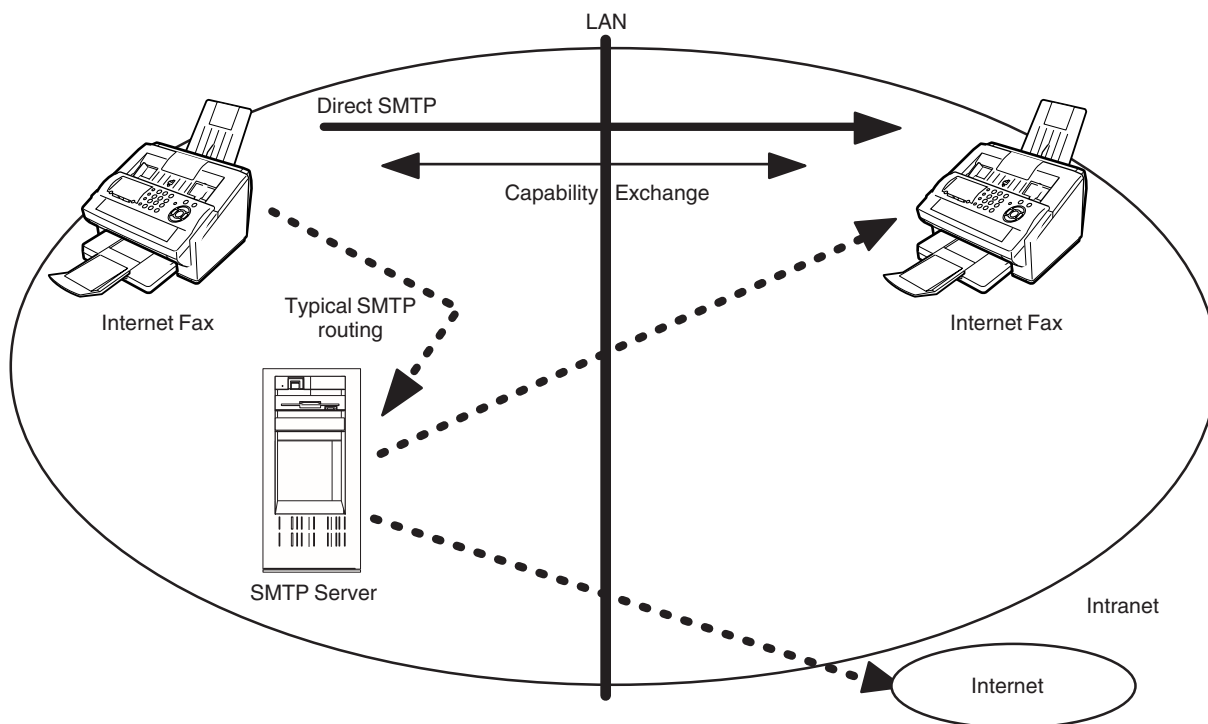

## Internet Communication Features

## Internet Mail Reception

Your machine allows you to receive and print a PC transmitted email automatically or manually, depending on its setup configuration. However, if the received email includes a file attachment in a format other than TIFF-F, such as Word, Excel, Power Point, your machine prints an error message instead.

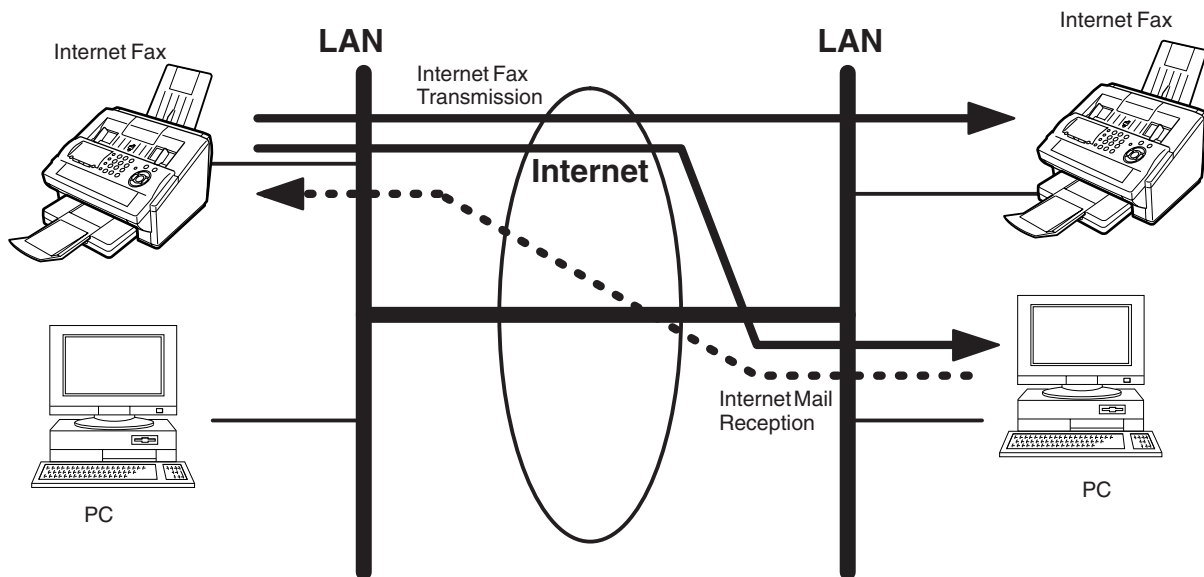

# Internet Communication Features

## Inbound Routing

Using the Inbound Routing feature, your machine can route documents received from a G3 fax machine to email address(s) or to Internet Fax machine(s) connected to a LAN as an email, as well as to other G3 fax machine(s) over the telephone line.

When an incoming Internet Fax, email or a regular fax document is received, your machine, checks for the following:

1. First, your machine checks whether a sub-address is included. If it is, it will look for a sub-address match within its auto dialler and will route the documents to the corresponding stations email address(s) and/or fax telephone number(s).
2. If no sub-address is specified, then your machine tries to match the originating fax machine's Numeric ID (TSI) with the TSI routing information within its auto dialler and will route the documents to the corresponding stations email address(s) and/or fax telephone number(s).

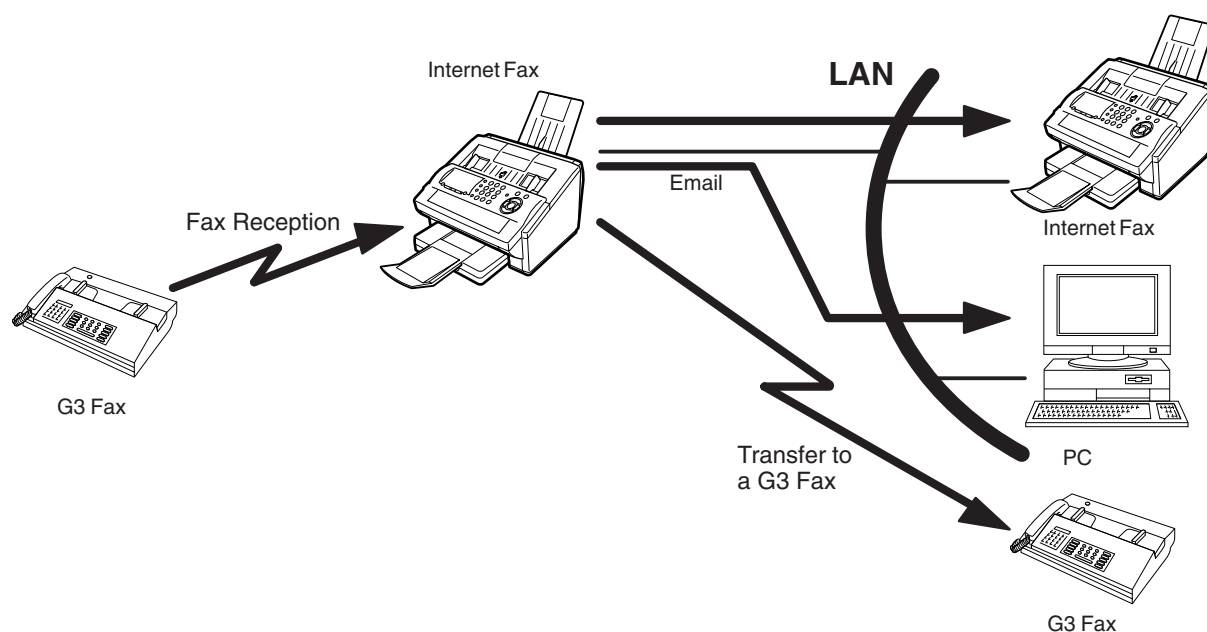

### NOTE

1. If the originating fax machine does not support the above sub-address function, sub-address destination(s) cannot be selected.
2. Your machine will allow you to register the same sub-address number for an email address and a telephone number. It will also allow you to "tag" multiple email addresses and/or fax telephone numbers for routing.



# Internet Communication Features

## Fax Forward

Your machine is capable of transferring all received Internet email or regular G3 fax documents to a pre-programmed G3 fax or a PC destination.

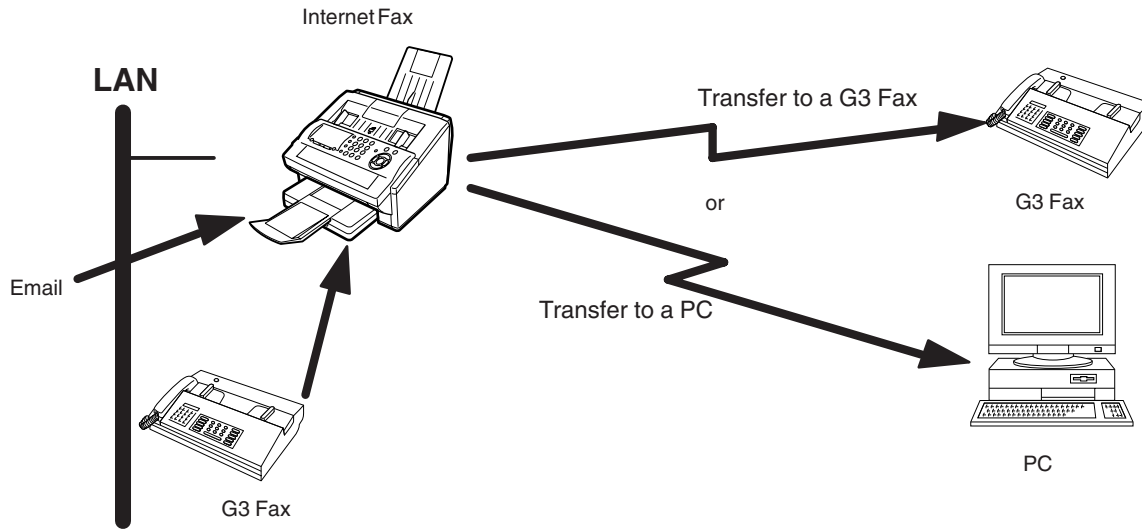

## Network Scanner

Your machine can be utilized as a network scanner by simply transmitting an image to a PC as TIFF-F attachment to an email.

This feature was enhanced with an addition of a new Fax Parameter No. 164 (IFAX XMT HEADER), giving you a selection of whether to include the header when sending a document to an address in the same Domain as specified in the Default Domain parameter. (See Note 1)

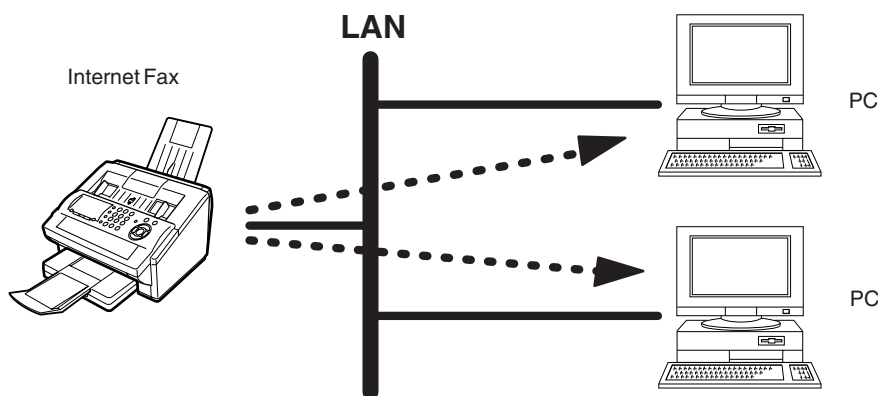

**NOTE**

1. When sending to a Domain other than as specified in the Default Domain parameter, the header will be included regardless of the selection.

# Internet Communication Features

## Network Printer

Your machine can be utilized as a network printer by simply sending the documents created on your PC using various software applications to your machine via TCP/IP protocol.

There are two parts to setting up your machine as a network printer. Part 1 requires you to download the software (printer driver and LPR) from the web site listed below or install the software from the CD-ROM included with the machine.

The second part requires you to install and configure the software on your PC to work with your machine, (See the web site for details about the printer driver installation and operation.)

You can download the Panasonic's printer driver and LPR monitor from any of the following URL addresses:

<http://www.panasonic.co.jp/mgcs/internetfax/>

<http://www.panasonic.com/internetfax>

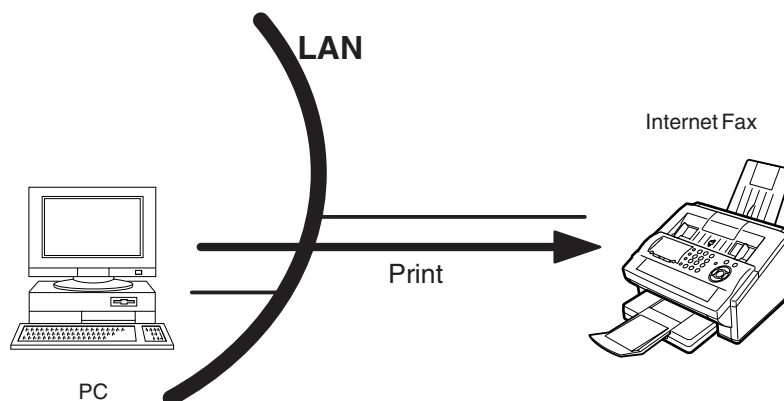

### NOTE

1. The IP Address, Subnet Mask and Default Gateway IP Address (TCP/IP Gateway Address) must be programmed on your machine to use as a Network Printer.

## Internet Communication Features

### Relayed Transmission

Your machine allows you to transmit an email received from an Internet Fax or PC connected to the LAN to multiple fax machines via a telephone line. You can attach files with the TIFF-F format to this email.

Using the Sub-address specified by the originating fax machine, your machine can then route the received documents to the remote machine via an email, which can then relay these documents to final destinations where the final recipient is a regular G3 fax machine.

Your machine also allows you to convert a data file from various application programs such as spreadsheet into a TIFF-F format file and then transmit this file attached to an email.

To convert applications into a TIFF-F formatted file, however, requires you to first download the software (TIFF Converter and MAPI Mail Linking program) from the web site listed below or install the software from the CD-ROM included with the machine. (Saved under the English\Extra\Tiff Converter folder) The second part requires you to install the software on your PC.

(See the web site for details about the software installation and operation.)

You can download the Panasonic software from any of the following URL addresses:

<http://www.panasonic.co.jp/mgcs/internetfax/>

<http://www.panasonic.com/internetfax>

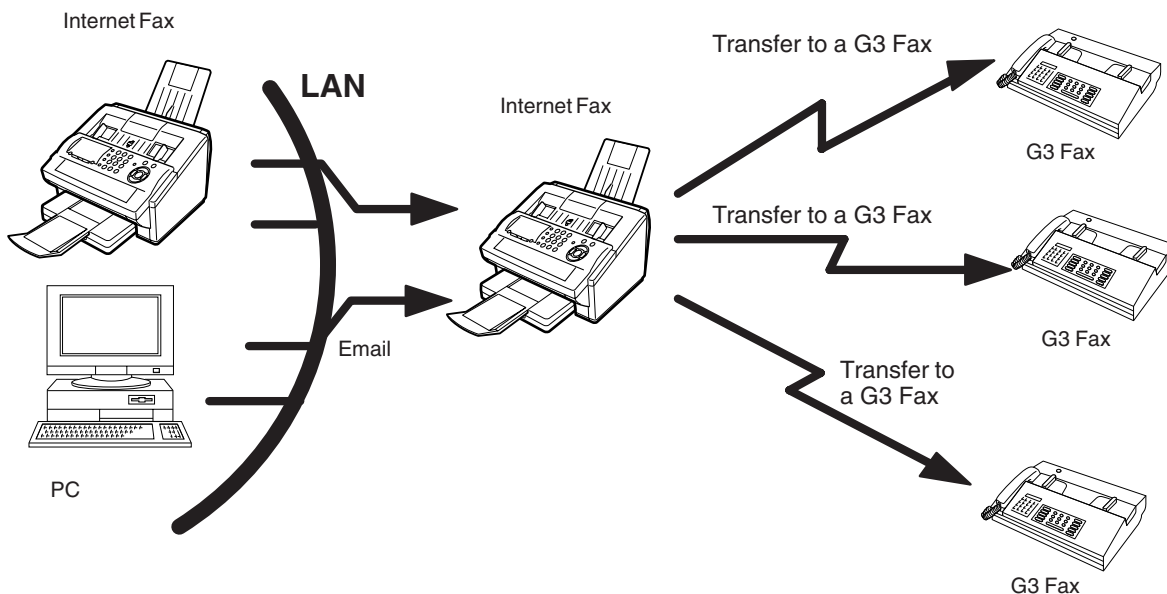

## Internet Communication Features

### Dynamic Host Configuration Protocol (DHCP)

DHCP is a protocol for dynamically assigning IP addresses to Internet Fax and client PCs. With DHCP, an Internet Fax can automatically acquire a unique IP address each time it connects to a network making IP address management an easier task for network administrators. When an Internet Fax logs on to the network, the DHCP server selects an IP address from a master list and assigns it to the system.

If you wish to enable the following options on your Internet Fax, a static (reserved by a Network Administrator) IP address and configurations must be used instead of the DHCP operation.

- SMTP Receiving
- G3 Gateway
- Direct SMTP (Direct IFAX XMT)

### SMTP Authentication

The Internet's emergence as a worldwide digital infrastructure has dramatically encouraged a market for communications-oriented appliances. However, the no object security technique has gained widespread and dominant use over the Internet due to several reasons.

1. Internet mail is a multi-hop store and forward architecture, and use of channel-based security is generally difficult.
2. No single technique is recommended by the Internet Fax standard.

To improve and robust the system, Authentication through encryption based techniques are provided as a typical solution. The techniques may be associated with the transmission channel, such as by using Simple Authentication and Security layer (SASL).

Some Internet Service Providers (ISP) take advantage of Internet mail service by providing an Authentication feature.

Your Internet Fax provides the following three Authentication options.

1. SMTP Service Extension for Authentication (SMTP AUTH) -- while sending
2. Lightweight challenge-response mechanism POP (APOP) -- while receiving
3. POP before SMTP -- performs POP procedure prior to every SMTP transaction

### Lightweight Directory Access Protocol (LDAP)

For convenience, your Internet Fax has an LDAP client feature to enable the search for recipient's email addresses from the LDAP server, which assists the entering of long email addresses.

The Lightweight Directory Access Protocol (LDAP) is a protocol for accessing online directory services. An LDAP client connects to an LDAP server and asks a question. The server responds with an answer.

Your Internet Fax indicates the search result from the LDAP server on the LCD display. This enables you to easily choose the recipients you wish to send to and saves you time from entering long and intricate email addresses.

# Important Information

Your machine uses the same communication protocols as email: the Simple Mail Transfer Protocol (SMTP). The differences from a standard G3 fax communication using the Public Telephone Network (PSTN) are as follows.

## Differences between Internet Fax and Regular Fax

A regular Fax machine goes off-hook, dials, and the phone network completes a circuit over phone lines to the receiving fax. You pay for the circuit. The two faxes negotiate a connection, synchronize and exchange image data.

The Internet Fax works like an email, the image data is broken down into packets and transmitted through your Local Area Network (LAN) to the Internet or Intranet instead of using a telephone company's network, thus saving you long distance costs.

## Transmitted Document Confirmation

1. Your machine does not directly connect to the final destination (see Note below), but rather connects to a Mail Server via LAN. Therefore, if a document cannot be correctly transmitted due to an error, the erroneous mail may be returned from the Mail Server to your machine.
2. The erroneous mail may take a long time to return (20 to 30 minutes) depending on the destination location, traffic on the network or LAN system configuration.
3. Depending on the Mail Server, it is also possible that erroneous mail is not returned at all. Therefore, when transmitting important or time sensitive documents, it is recommended that you follow up with a telephone call to confirm reception.
4. Documents cannot be transmitted correctly if the destination Mail Server does not conform to the MIME protocol. Erroneous mail may not be returned depending on the Mail Server.

### Note:

- 1) Fax Parameter 172 (DIRECT IFAX XMT), if set to "Valid," allows you to configure One-Touch/ABBR so that you can directly send to the destination without medium of SMTP.
- 2) Your machine supports the Delivery Notice feature (see page 101).

## Your machine Cannot Make a Phone Call via LAN

Your machine can only make a phone call using a regular telephone line (PSTN).

## Dual Port Communication

Your machine's dual port capability, allows simultaneous G3 Fax Communication over regular telephone line (PSTN) and LAN Communication.

## Transmission Resolution

In view of PC transmission, the factory default setting for the resolution is set to FINE mode. If required, this setting can be changed to Normal.

## Internet Mail Reception

1. Your machine can receive text email from a PC and print ANSI characters. It will print a "■" symbol if an unrecognized character is received.
2. Received email font and character size are fixed and cannot be changed.
3. Text email will be printed at about 72 lines per page. It is recommended that you use A4/Letter size recording paper.
4. If the received text email includes a file attachment in a format other than TIFF-F, such as Word, Excel, Power Point, your machine prints an error message instead.
5. If the received email includes attached TIFF-F formatted image files, the text and TIFF-F formatted image file will be printed on separate pages.

## Important Information

### **Sending a Document to a PC via LAN**

When transmitting a document to an email address, the following instructions are sent as text message in addition to the TIFF-F formatted image file.

An Image data in TIFF-F format has been attached to this email. You can download the TIFF-F Image Viewer from the following URL addresses:

<http://www.panasonic.co.jp/mgcs/internetfax/>

<http://www.panasonic.com/internetfax>

### **Internet Relayed Transmission**

To prevent unauthorized stations from accessing your Relay Station for Internet Relayed Transmission, you must set up your Network security. Enter a Relay Station Name, which is concealed from the final destinations and a Manager's Email Address for notification of all Internet Relayed Transmissions.

memo

# Main Unit and Accessories

Unpack the carton and check that you have all the accessories illustrated.

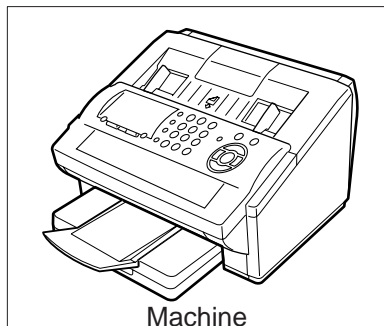

Machine

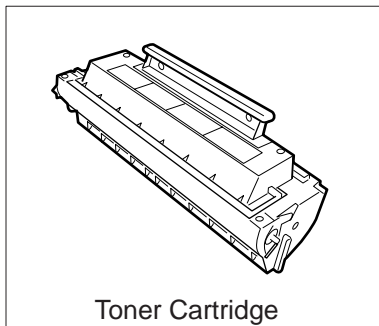

Toner Cartridge

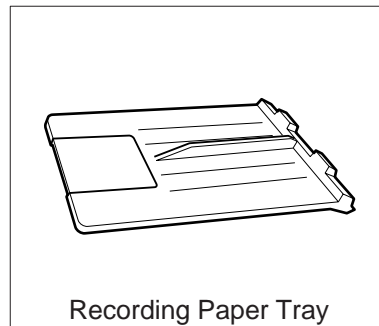

Recording Paper Tray

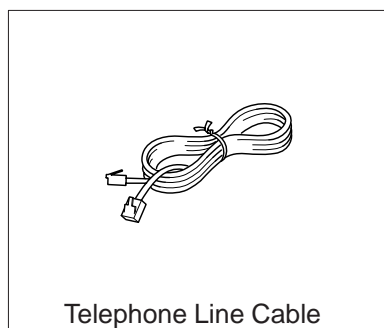

Telephone Line Cable

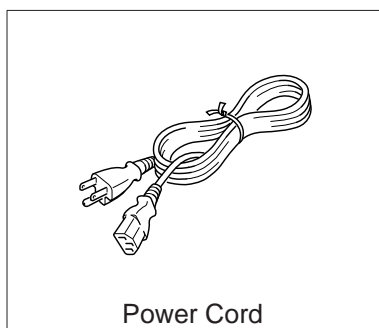

Power Cord

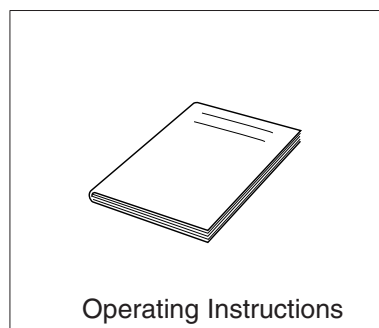

Operating Instructions



CD-ROM

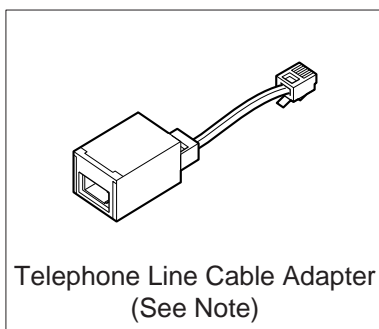

Telephone Line Cable Adapter  
(See Note)



Directory Sheet Cover  
(See Note)

## NOTE

1. The shape of the telephone line cable and power cord may differ depending on each country's regulation or specification.
2. The Telephone Line Cable Adapter and Directory Sheet Cover is available in certain countries only.



# Installing the Accessories

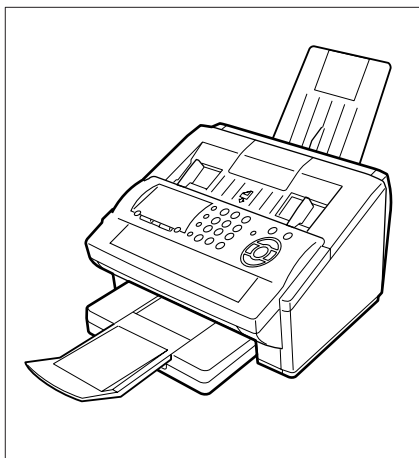

Final Installed View

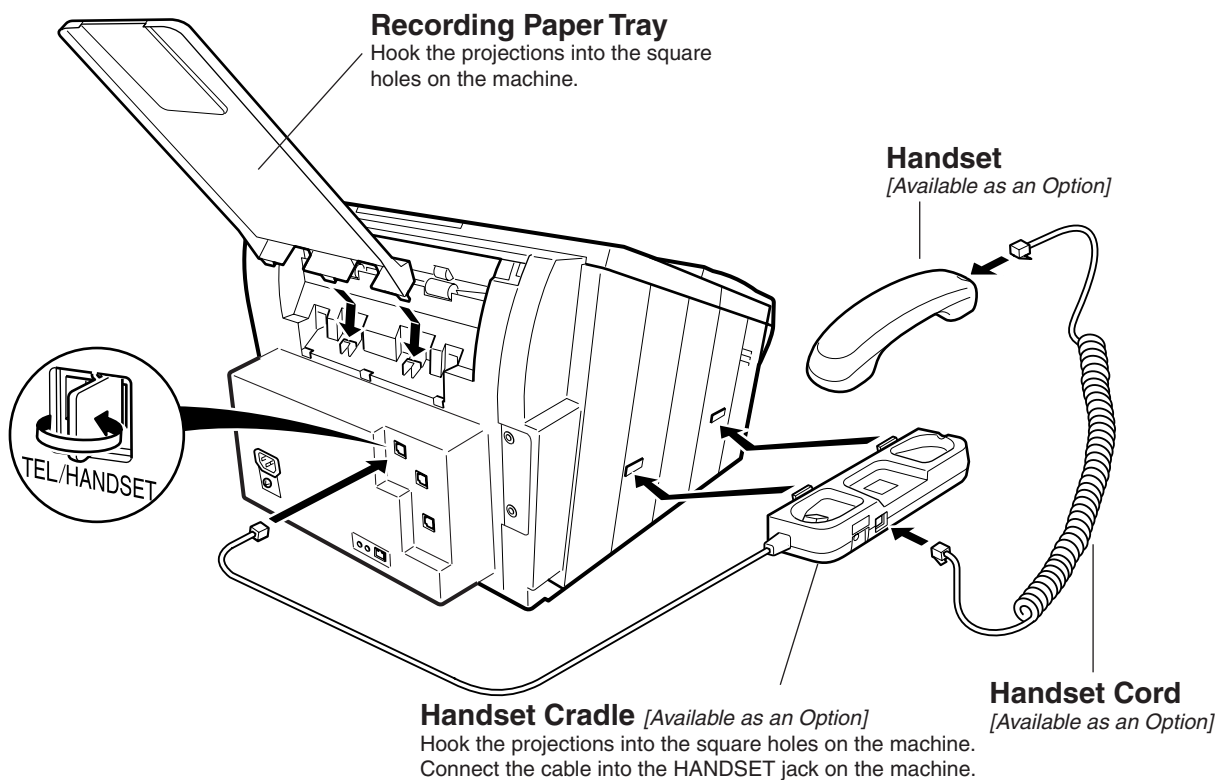

## NOTE

1. For some countries, the handset may not be available because of the country's regulation or specification.

# Installing the Toner Cartridge

1

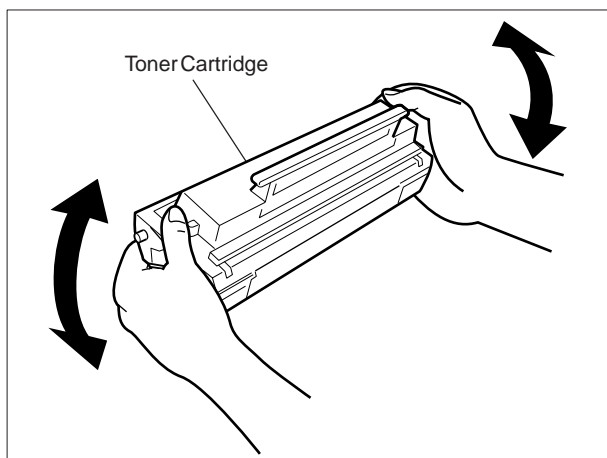

Unpack the Toner Cartridge and rock it back and forth as shown 5 or 6 times to even the toner inside.

2

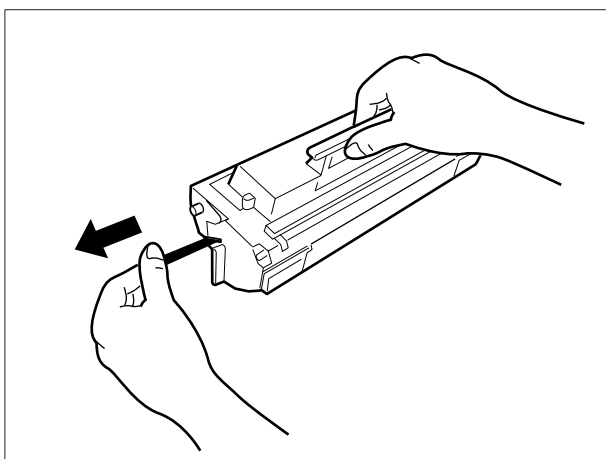

Remove the protective seal.  
**Note:** Pull the seal slowly and straight out.

3

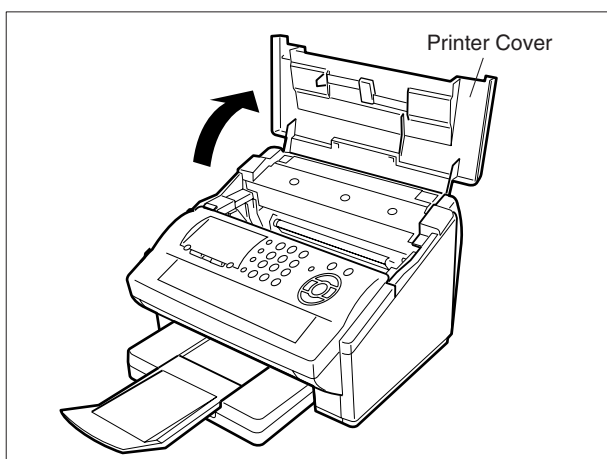

Open the Printer Cover.

## Installing the Toner Cartridge

4

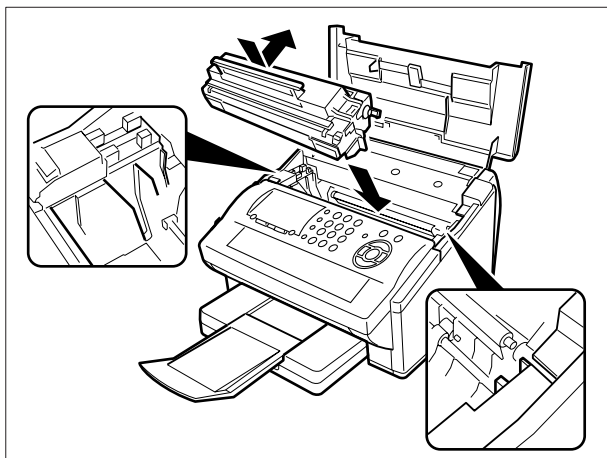

Align the projections on both sides of the Toner Cartridge with the grooves in the machine as shown and insert the Toner Cartridge into the machine.

**Note:** Lock the Toner Cartridge into place by pressing the handle down and then pushing towards the rear of the machine.

5

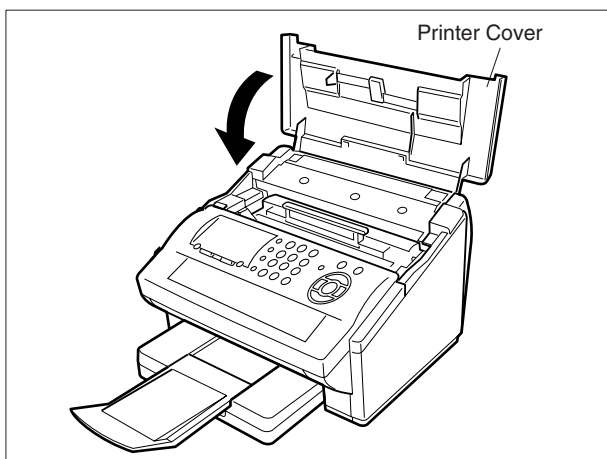

Close the Printer Cover.

6

If you are replacing the Toner Cartridge, it is recommended to clean the Printer Roller to maintain good printing quality. To clean the Printer Roller, follow the procedure on page 235.

### NOTE

1. Used toner cartridge should be disposed properly according to local regulations.

# Loading the Recording Paper

## How to Load the Recording Paper

### Paper Specifications

In general, most bond papers will produce excellent results. Most photocopy papers will also work very well. There are many "name" and "generic" brands of paper available. We recommend that you test various papers until you obtain the results you are looking for. For detailed recommended paper specifications, (See page 241).

### How to Load the Recording Paper

1

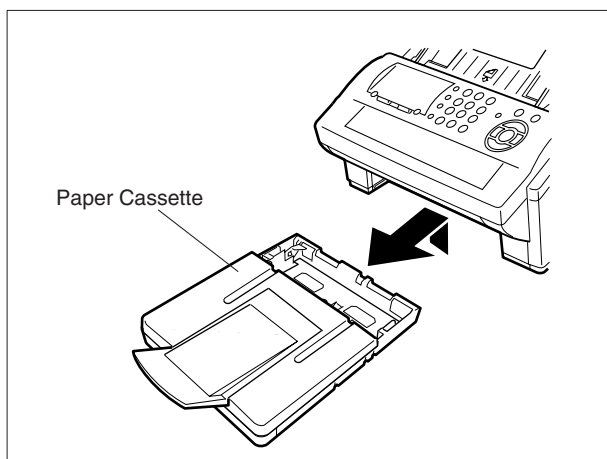

Lift up the Paper Cassette slightly and slide it out from the machine.

2

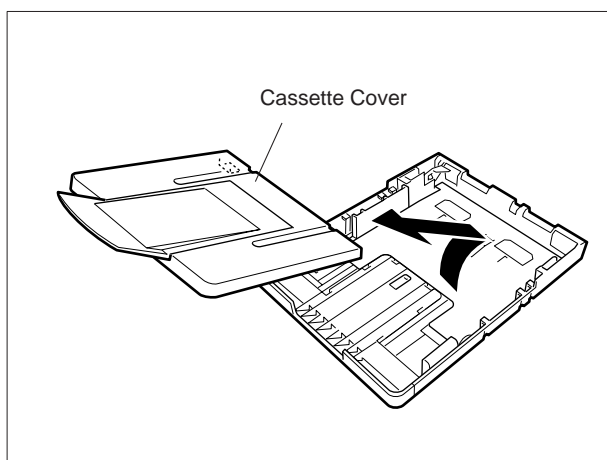

Remove the Paper Cassette Cover.

3

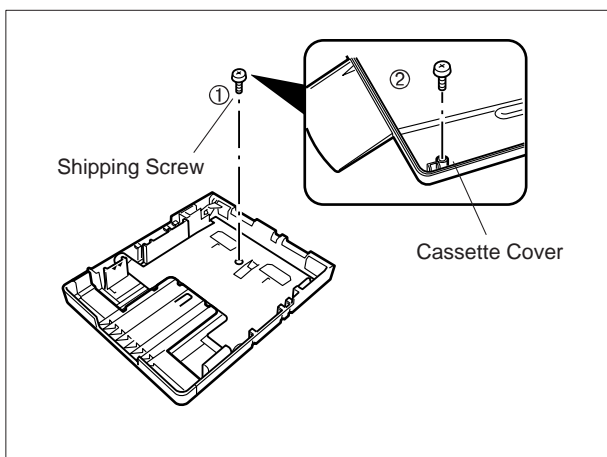

1. Remove the Shipping Screw securing the Pressure Plate.
2. Store the screw by attaching it to the post provided under the Paper Cassette Cover for future use.

## How to Load the Recording Paper

4

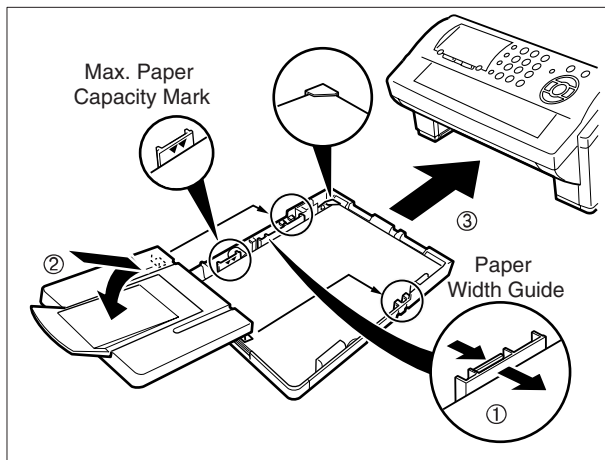

1. Load the paper into the Paper Cassette. Slide the paper width guide to the left until it lightly touches the stack of paper without bending the paper. The paper must fit squarely and firmly between the Paper Width Guide and the right side of the tray. If it does not, the paper may feed into the printer incorrectly resulting in a paper jam.

**Caution:** Make sure that the paper is set under the metal Paper Separation Clips and that it does not exceed the Maximum Paper Capacity Mark. You can load about 250 sheets (75g/m<sup>2</sup> weight). For paper specification, see page 241.

2. Re-install the Paper Cassette Cover.
3. Slide the Paper Cassette into the machine.

# Adjusting the Paper Cassette for the Paper Length

## How to Adjust the Paper Cassette for the Paper Length

The factory default Paper Length setting for the Paper Cassette is on Letter size. To change the paper length to A4 or Legal size, follow the steps below.

1

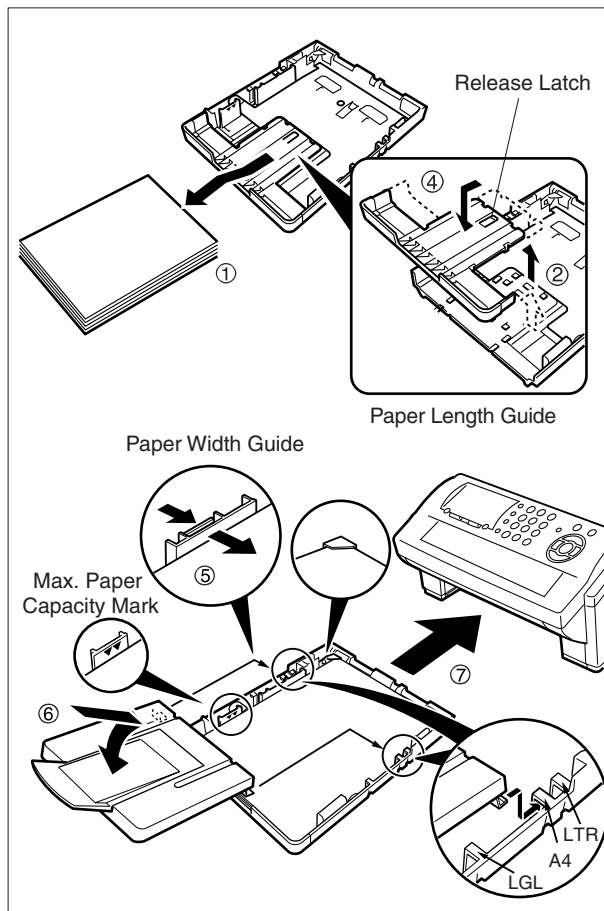

1. Remove the paper from the Paper Cassette and place the cassette upside down on a flat surface.
2. While pushing down on the release latch, pull out the Paper Length Guide.
3. Turn the Paper Cassette upright.
4. Insert the Paper Length Guide hooks into the appropriate paper length slots (A4 or Legal) and slide the guide towards the back of the cassette until it locks in place.
5. Load the paper into the Paper Cassette.

Slide the paper width guide to the left until it lightly touches the stack of paper without bending the paper. The paper must fit squarely and firmly between the Paper Width Guide and the right side of the tray. If it does not, the paper may feed into the printer incorrectly resulting in a paper jam.

**Caution:** Make sure that the paper is set under the metal Paper Separation Clips and that it does not exceed the Maximum Paper Capacity Mark. You can load about 250 sheets (75g/m<sup>2</sup> weight). For paper specification, see page 241.

6. Replace the Paper Cassette Cover to the appropriate paper position (LTR, A4 or LGL).
7. Slide the Paper Cassette into the machine.

2

The Recording Paper Size setting of the Fax Parameter No. 23 must match the paper loaded in the cassette. If you change the Recording Paper Size, please change the setting accordingly. (See page 79)

### NOTE

1. If you forget to change the Recording Paper Size setting in Fax Parameter No. 23 when different paper is installed in the cassette, the unit will Stop printing after the 1st page of an Incoming Fax and display a "PAPER SIZE MISMATCH" error. Then, the Recording Paper Size setting automatically adjusts to the proper size and the unit resumes printing the Incoming Fax from the 1st page.

# Adjusting the Paper Cassette for the Paper Width

## How to Adjust the Paper Cassette for the Paper Width

The factory default Paper Width setting for the Paper Cassette is on Letter/Legal size. To change the paper width to A4 size, follow the steps below.

1

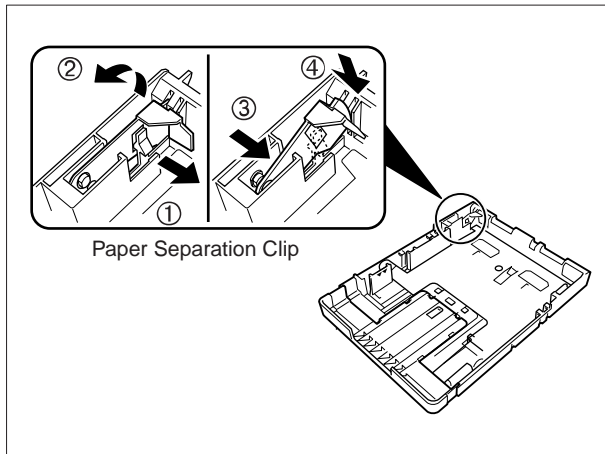

1. Release the left Paper Separation Clip latch.
2. Pull up the Paper Separation Clip to remove it.
3. Reposition the Paper Separation Clip into the A(A4) slot.
4. Swing the Paper Separation Clip downward to latch it in place.

2

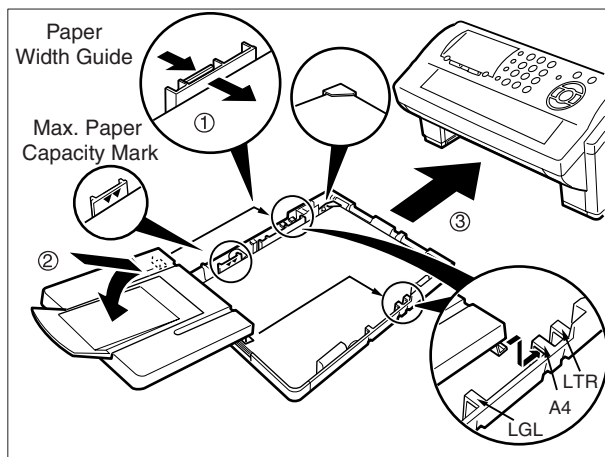

1. Load the paper into the Paper Cassette. Slide the paper width guide to the left until it lightly touches the stack of paper without bending the paper. The paper must fit squarely and firmly between the Paper Width Guide and the right side of the tray. If it does not, the paper may feed into the printer incorrectly resulting in a paper jam.

**Caution:** Make sure that the paper is set under the metal Paper Separation Clips and that it does not exceed the Maximum Paper Capacity Mark. You can load about 250 sheets (75g/m<sup>2</sup> weight). For paper specification, see page 241.

2. Replace the Paper Cassette Cover to the appropriate paper position (LTR, A4 or LGL).
3. Slide the Paper Cassette into the machine.

3

The Recording Paper Size setting of the Fax Parameter No. 23 must match the paper loaded in the cassette. If you change the Recording Paper Size, please change the setting accordingly. (See page 79)

### NOTE

1. If you forget to change the Recording Paper Size setting in Fax Parameter No. 23 when different paper is installed in the cassette, the unit will Stop printing after the 1st page of an Incoming Fax and display a "PAPER SIZE MISMATCH" error. Then, the Recording Paper Size setting automatically adjusts to the proper size and the unit resumes printing the Incoming Fax from the 1st page.

# Connecting the LAN Cable, Telephone Line Cable and Power Cord

## ■ Power Cord

Plug the supply cord into the mains AC socket outlet. Connect the supply cord coupler into the mains supply inlet on the rear of the machine.

**Warning:** This apparatus must be properly earthed.  
Do not modify the AC outlet.

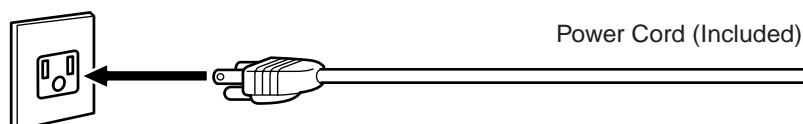

## ■ Telephone Line Cable

Plug one end of the telephone line cable into the telephone jack supplied by the telephone company and the other end into the LINE jack on the left side of the machine.

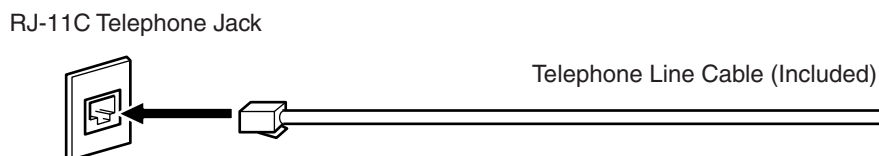

## ■ Ethernet LAN Cable

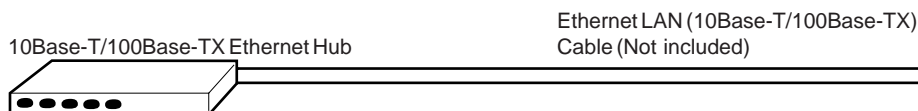

### NOTE

1. Your machine uses little power and you should keep it ON at all times. If the power is turned OFF for too long, the clock contents may be lost.
2. The shape of the telephone line cable and power cord may differ depending on each country's regulation or specification.
3. The Telephone Line Cable Adapter is available in certain countries only.



## Connecting the LAN Cable, Telephone Line Cable and Power Cord

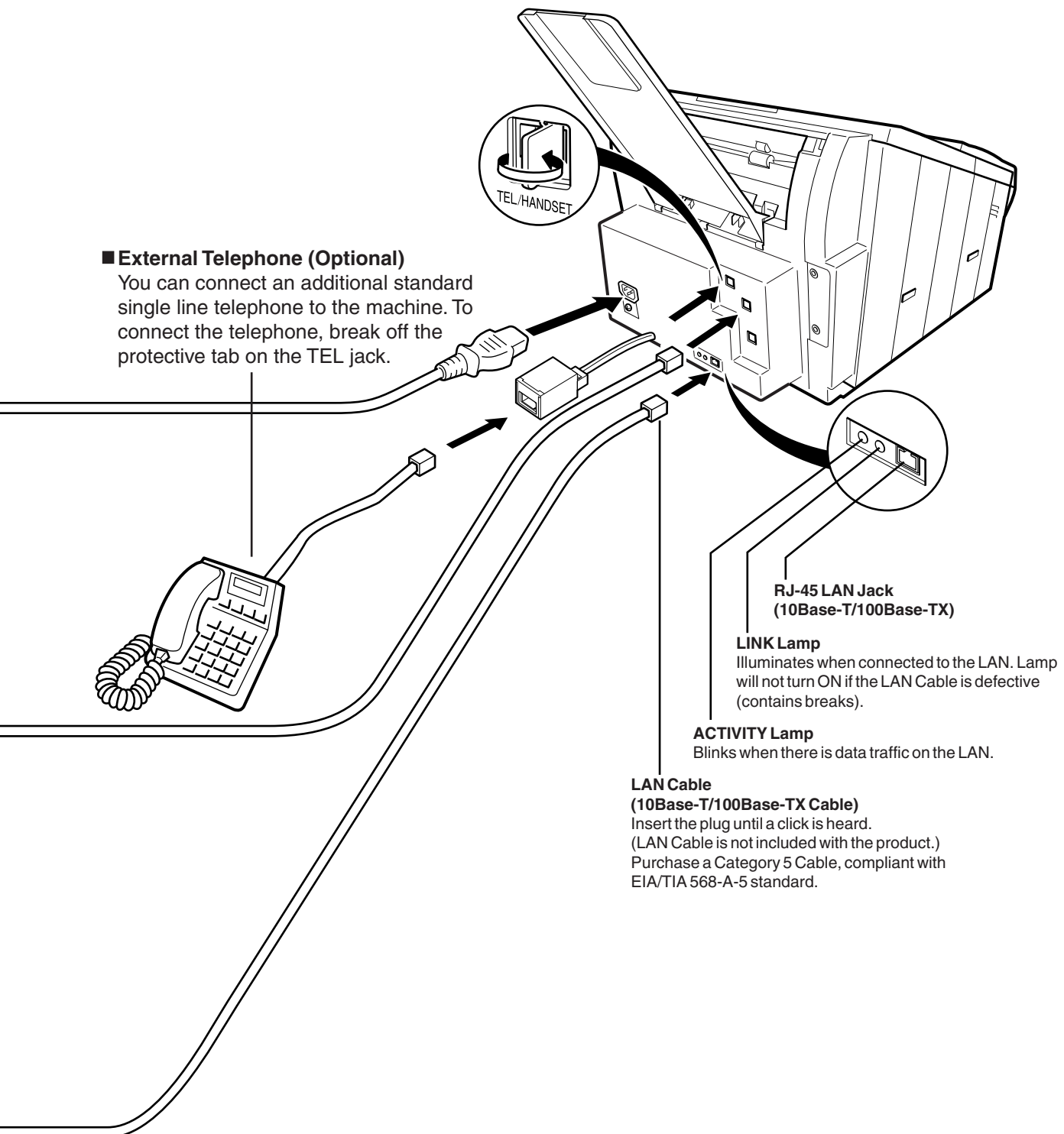

# Setting Your Country Code

For some countries, the machine will ask to set your country code after applying power to the machine. The display shows the following message.

COUNTRY CODE :  
PRESS ∨ ^ TO SELECT

Follow the procedure below to set up your country code.

1

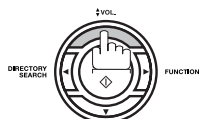

repeatedly until display shows your country.

or

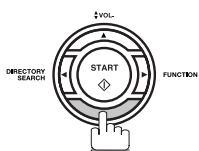

repeatedly until display shows your country.

2

COPY / SET

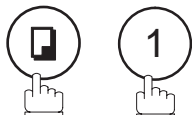

UNITED KINGDOM?  
PRESS SET TO SELECT

COMPLETED

# Setting the Dialling Method (Tone or Pulse)

Your machine can operate with either of two dialling methods (Tone or Pulse), depending on the type of telephone line you are connected to. If you need to change the dialling method to Tone or Pulse, follow the procedure below.

1

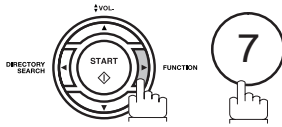

SET MODE (1-8)  
ENTER NO. OR ∨ ^

2

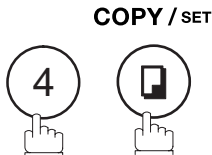

FAX PARAMETER (1-174)  
NO. = ■

3

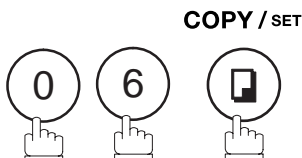

06 DIALLING METHOD  
2:TONE

4

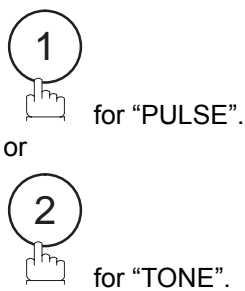

06 DIALLING METHOD  
1:PULSE

or

06 DIALLING METHOD  
2:TONE

5

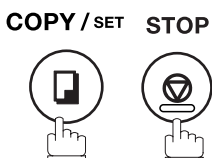

## NOTE

1. For some countries, this feature is not available depending on the country's regulation. The display may not show this feature.

# Adjusting the Volume

You can adjust the monitor and ringer volume on your machine. The built-in speaker enables you to hear the dial tone, dialling signals, and busy tone. The ringer sounds when your machine receives a call.

## Setting the Monitor Volume

**1**

**MONITOR**



You will hear the dial tone through the speaker.

**2**

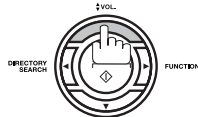

repeatedly to raise the volume.

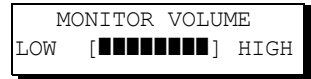

OR

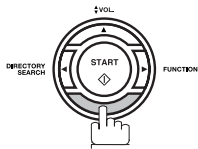

repeatedly to lower the volume.

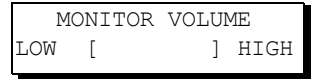

**3**

**MONITOR**



## Setting the Ringer Volume

**1**

Standby

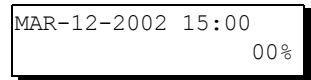

**2**

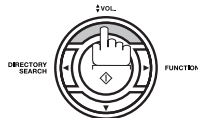

repeatedly to raise the volume.



OR

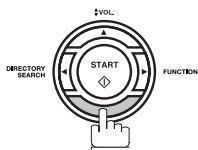

repeatedly to lower the volume.



**3**

**STOP**



**NOTE**

1. You can also adjust the volume of the key touch tone and the volume of the buzzer in the Fax Parameter No. 10 (KEY/BUZZER VOLUME). (See page 78)

# User Parameters

## General Description

Your machine has several basic settings (User Parameters) to help you keep records of the documents you send or receive. For example, the built-in clock keeps the current date and time, and your LOGO and ID Number help to identify you when you send or receive documents.

## Setting the Date and Time

In standby, the display will show the date and time. Once the date and time is set, it will automatically be updated.

1

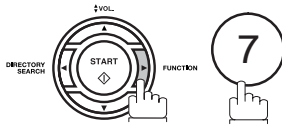

```
SET MODE      (1-8)
ENTER NO. OR ∨ ^
```

2



```
1:USER PARAMETERS?
PRESS SET TO SELECT
```

3

COPY / SET



```
DATE & TIME
■1-01-2002 00:00
```

4

Enter the new date and time.

Ex: ① ③                      Date        : 3rd  
     ① ②                      Month     : December  
     ② ① ① ②                  Year     : 2002  
     ① ⑤ ① ①                  Time     : 3:00 PM

If you make a mistake, use ◀ or ▶ to move the cursor over the incorrect number, then overwrite it with a correct one.

```
DATE & TIME
03-12-2002 15:00
```

5

COPY / SET    STOP



# User Parameters

## Setting Your LOGO

When you send a document, your LOGO appears on the top of the copy printed out at the other station. The LOGO helps to identify you to someone who receives your document.

1

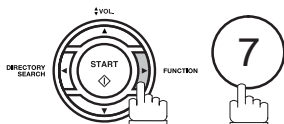

SET MODE (1-8)  
ENTER NO. OR V ^

2



1:USER PARAMETERS?  
PRESS SET TO SELECT

3

**COPY / SET**



repeatedly until display shows;

LOGO  
█

4

Enter your LOGO (max. 25 characters and digits) by using the Character keys.

**Ex:** P A N A S O N I C

If you make a mistake, use ◀ or ▶ to move the cursor one space beyond the incorrect character, press **CLEAR** then re-enter the new character.

If more than 19 characters are entered, the left side characters will scroll off the display.

LOGO  
PANASONIC█

5

**COPY / SET STOP**



## Setting Your Character ID

If the remote machine has a Character ID capabilities, when you are sending or receiving, your Character ID will appear on the remote machine's display and the remote machine's Character ID will appear on your display.

**1**

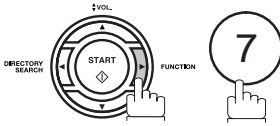

```
SET MODE          (1-8)
ENTER NO. OR ∨ ^
```

**2**



```
1:USER PARAMETERS?
PRESS SET TO SELECT
```

**3**

**COPY / SET**





repeatedly until display shows;

```
CHARACTER ID
█
```

**4**

Enter your Character ID (max. 16 characters and digits) by using the Character keys.

**Ex:** H E A D  O F F I C E

If you make a mistake, use  or  to move the cursor beyond the incorrect character, press **CLEAR** then re-enter the new character.

```
CHARACTER ID
HEAD OFFICE█
```

**5**

**COPY / SET STOP**



**NOTE**

1. The special characters of Å, Ä, Ö, Ü, Æ, è and é cannot be used for Character ID.

# User Parameters

## Setting Your ID Number (Fax Telephone Number)

If the remote machine does not have a Character ID but it has an ID Number, when sending or receiving, your ID Number will appear on the remote machine's display and their ID Number will appear on your display.

We suggest you use your facsimile telephone number as your ID number (max. 20 digits).

1

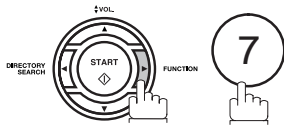

SET MODE (1-8)  
ENTER NO. OR V ^

2



1:USER PARAMETERS?  
PRESS SET TO SELECT

3

**COPY / SET**





ID NO.

repeatedly until display shows;

4

Enter your ID (max. 20 digits) by using the keypad and  key to enter a space between numbers.

Ex: (2)(0)(1)  (5)(5)(5)  (1)(2)(1)(2)

If you make a mistake, use  or  to move the cursor one space beyond the incorrect number, press **CLEAR** then re-enter the new number.

ID NO.  
201 555 1212

5

**COPY / SET STOP**



### NOTE

1. You may use  to enter a "+" character at the beginning of the ID number to indicate the following digit(s) for your country code.

Ex: +1 201 555 1212 +1 for U.S.A. country code.  
+81 3 111 2345 +81 for Japan country code.



# Setting the Internet Parameters

## Setting the User (Internet) Parameters

Before starting, you will need a completed copy of page 19 (Pre Installation Information). For your machine to be able to operate on the Network properly, the following five (5) Basic Parameters must be pre-programmed into the machine.

- IP Address
- Subnet Mask
- Default Gateway IP Address
- SMTP Server Name or IP Address
- Email Address

**Note:** If DHCP server is available on your network, the IP Address, Subnet Mask and Default Gateway IP Address will be acquired automatically.

1

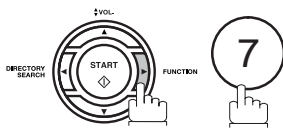

```
SET MODE      (1-8)
ENTER NO. OR ▾ ▴
```

2



```
1:USER PARAMETERS?
PRESS SET TO SELECT
```

3



COPY / SET



repeatedly until display shows;

```
IP ADDRESS
█
```

4

Enter the IP Address using the keypad. Press  or  to enter the period ".". (See Note 3)

```
IP ADDRESS
123.178.240.3█
```

**Ex:**             

5





COPY / SET



```
SUBNET MASK
█
```

To continue setting other parameters, or press  to return to standby.

### NOTE

1. To scroll the display to desired User Parameter in Step 3, press  or .
2. If the DNS Server is not available, change the setting of the Fax Parameter No. 161 (DNS SERVER) to "Invalid", then enter the IP Address instead.
3. For convenience, you can use  to enter a period "." while programming IP Addresses only. Otherwise  is used to enter an asterisk under other conditions.

## Setting the Internet Parameters

### Setting the User Parameters for the LAN Interface

Depending on how your machine will be configured to communicate on the LAN, the appropriate parameters listed in the table below must be stored first. (See pages 16 to 20)

	Parameter	Comments
1	DATE & TIME	Current Date and Time.
2	TIME ZONE	The Time Zone is required as part of the Email header information when sending Internet faxes.
3	LOGO	Up to 25 characters & digits.
4	CHARACTER ID	Up to 16 characters & digits.
5	ID NO.	Your Fax Telephone Number. (Up to 20 digits)
6	(MAC ADDRESS)	Hardware Address hard-coded into your machine. (If required, can be obtained from the Fax Parameter List printout, by pressing [FUNCTION] [6] [4] [SET])
7	IP ADDRESS	IP Address assigned to your machine by the Network Administrator or the DHCP Server.
8	SUBNET MASK	Subnet Mask assigned by the Network Administrator or the DHCP Server.
9	DEFAULT GATEWAY IP ADDR	Default Gateway IP Address assigned by the Network Administrator or the DHCP Server.
10	PRIMARY DNS SERVER IP ADDRESS	IP Address of the primary DNS Server. If the DNS Server is not available, change the setting of the Fax Parameter No. 161 (DNS SERVER) to "Invalid", then enter the IP Address instead.
11	SECONDARY DNS SERVER IP ADDRESS	IP Address of the secondary DNS Server.
12	EMAIL ADDRESS	The Email Address assigned to your machine for sending and receiving. (Up to 60 characters)
13	SMTP SERVER NAME	The name of the SMTP Mail Server. (Up to 60 characters)
14	SMTP SERVER IP ADDR	IP Address of the SMTP Mail Server.
15	SMTP AUTH NAME	User name required to login to the SMTP Server before it allow to send email messages. (Up to 40 characters).
16	SMTP PASSWORD	Password assigned to your machine. (Up to 10 characters)
17	POP SERVER NAME	The name of the POP Mail Server. (Up to 60 characters).
18	POP SERVER IP ADDR	IP Address of the POP Mail Server.
19	POP USER NAME	User Name assigned to your machine. (Up to 40 characters)
20	POP PASSWORD	Password assigned to your machine. (Up to 10 characters)
21	LDAP SERVER NAME	The name of the LDAP Server. (Up to 60 characters) (Available for some countries only.)
22	LDAP LOG IN NAME	Login Name assigned to your machine. (Up to 40 characters) (Available for some countries only.)
23	LDAP PASSWORD	Password assigned to your machine. (Up to 10 characters) (Available for some countries only.)
24	LDAP SEARCH BASE	ID for starting the search in the directory on the LDAP server. (Up to 60 Characters) (Available for some countries only.)
25	HOST NAME	The Host Name assigned to your machine. (Up to 60 characters)
26	DEFAULT SUBJECT	The default information to be added to the Subject Line for all outgoing Email (up to 40 characters). To manually input this information before transmission, change the Fax Parameter No. 159 (SUBJECT LINE ENTRY) to "2.Valid".
27	DEFAULT DOMAIN	When the outgoing email address is incomplete by SMTP standards, the Frequently Sent Domain specified here will be automatically added to the email address. This feature is also useful as a shortcut when manually entering email addresses to a frequently used Domain. (Up to 50 characters)
28	SELECTABLE DOMAINS (01) ~ (10)	Enter up to 10 Domain Names that can be selected after the Domain "@" key is pressed using the "V or ^" key during Manual email addressing. (Up to 30 characters)
29	REMOTE PASSWORD	This is a security password that allows Remote Programming of the Internet Parameters and Auto Dialler or the retrieval of the Journal via an Email. (Up to 10 characters)
30	RELAY XMT PASSWORD	A password that provides Network security for your Relay Station (used exclusively for G3 relay purposes). (Up to 10 characters)
31	MANAGER'S EMAIL ADDR	Department Manager's Email Address for notification of all Internet relayed transmissions for supervision and cost control purposes. (Up to 60 characters)
32	RELAY DOMAIN (01) ~ (10)	Enter up to 10 Domain Name(s) that have been authorized to access your Internet Fax for Relayed XMT Request. (Up to 30 characters) Relay Domain, a.k.a. Domain Name in your machine.
33	COMMUNITY NAME (01) ~ (02)	Community Name used for the Network Device Locator.
34	DEVICE NAME	Device Name used for the Network Device Locator.
35	DEVICE LOCATION	Device Location for the Network Device Locator.

# Programming or Retrieving Parameters via Email

## Using Email to Program or Retrieve Parameters

This feature is a powerful tool, which provides a convenient and easy way of retrieving or programming Internet Parameters, One-Touch, ABBR Dialling Numbers, Program keys and Journal retrieval from your PC by sending a text email message to your machine.

Using your email application's "Subject:" line as a command-input field, you can request your machine to perform the following commands:

	"Subject:" Line Command	Function
1	#set parameters(password)#	Programs the Internet Parameters
2	#get parameters(password)#	Retrieves the Internet Parameters
3	#set abbr(password)#	Programs the Auto Dialler
4	#get abbr(password)#	Retrieves the Auto Dialler Data
5	#get jnl(password)#	Retrieves the current Journal data

Where:

- "set" is used to program the data
- "get" is used to retrieve the data
- "parameters" represents Internet Parameters
- "abbr" represents Auto Dialler
- "jnl" represents Journal
- "password" is the Remote Password programmed in your machine's User Parameters (i.e. 123456789). Must be enclosed within the parenthesis "( )".
- The command must be enclosed within the hash (#) signs.

## Using a PC to Input the Internet Parameters Remotely

This feature provides a convenient and an easy way to input the Internet Parameters right from your PC by sending a text email message to your machine.

The following parameters can be input remotely via a PC. The other parameters must be entered from the machine in the User Parameters. (See page 49)

- Sender Selection (up to 24 User Names, see page 150)
- Default Domain
- Selectable Domains (up to 10 additional Domain Names)
- Remote Password
- Manager's Email Address
- Relay XMT Password
- Relay Domain (up to 10 Domain Names authorized for Relay XMT Request)
- LDAP Server Name (Available for some countries only.)
- LDAP Login Name (Available for some countries only.)
- LDAP Password (Available for some countries only.)
- LDAP Search Base (Available for some countries only.)
- Community Name (up to 2 Community Names)
- Device Name
- Device Location

Your machine interprets the command that you enter in the "Subject" line of your email message and performs one of the following functions, it Retrieves or Stores data into the Internet Parameters (User Parameters).

The two types of commands that can be entered in the "Subject" line of your email:

- 1) To Store : **#set parameters(password)#** : where the "password" is the Remote Password programmed in your machine's User Parameters (i.e. 123456789).  
data, type  
You can enter the Internet Parameters shown above with this command the first time. However, if these fields already contain data, do not use this command as the existing information will be deleted and overwritten. Use the Retrieve command below instead, refer to pages 54 to 55.
- 2) To Retrieve : **#get parameters(123456789)#**  
data, type

### NOTE

1. To activate this feature, change the Fax Parameter No. 158 (PC REMOTE UPDATE) to "Valid". (See page 83)

# Programming or Retrieving Parameters via Email

## To Input the Internet Parameters for the First Time

Create a script in the message body of a plain text email and send it to your machine's email address. The "Subject" line of the email must be as follows:

- #set parameters(password)#** : where the "password" is the Remote Password programmed in your machine's User Parameters. For security, always input a Remote Password in the User Parameters. [If the password was not programmed, represent it with "( )" and assign a password now.  
Ex: #set parameters( )#].
- Important** : Do not use the above command if these fields already contain data, the existing information will be deleted and overwritten. Retrieve and backup the existing data onto your PC first by following the procedures for Retrieving and Editing the Internet Parameters on pages 54 to 57.

The script sample to input the Internet Parameters is shown below.

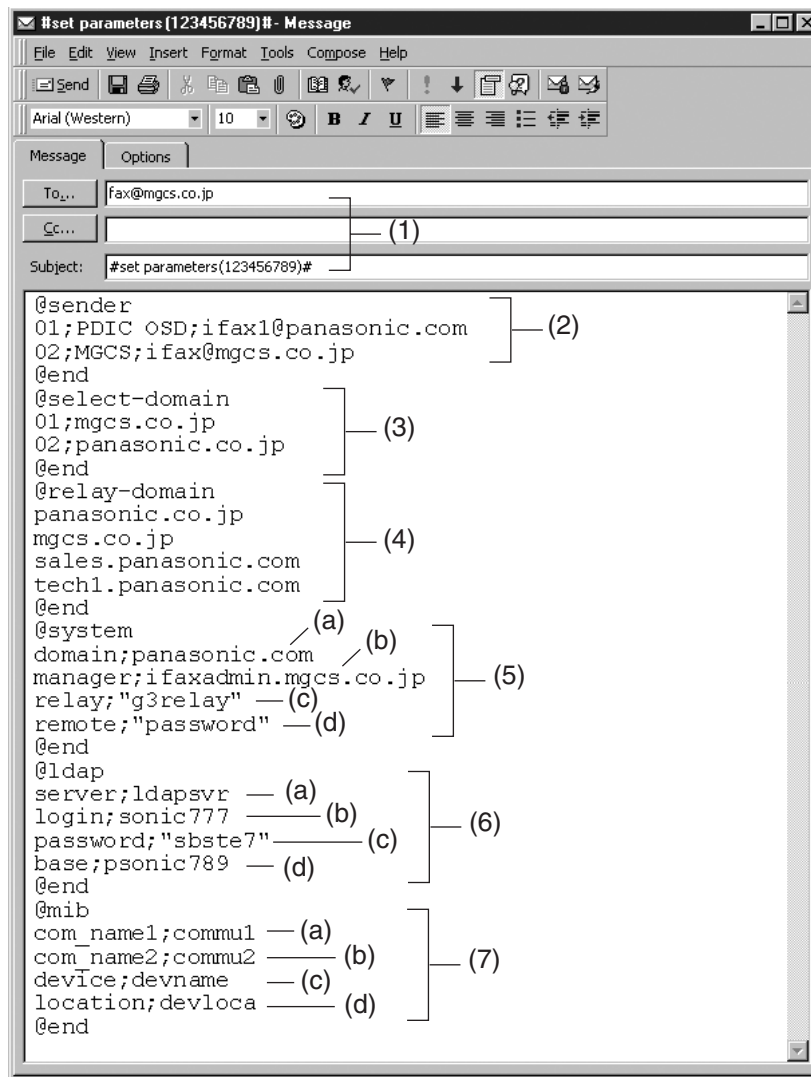

- (1) To : Your machine's email address.  
From : This field is normally not visible when creating new email message(s). It is your default email address (email application), for retrieving the Internet Parameters and for error message notification. (Can be programmed with the configuration tool of your email program.)  
Subject : To Store data, type: #set parameters(password)#

## To Input the Internet Parameters for the First Time

- (2) @sender to @end : Defines the Sender information to be set in section (2) between @sender to @end block. Register up to 24 User Names and their Email Addresses for the Sender Selection feature (See page 150).  
Separate each data field with a semicolon (;). (If the remaining fields are to remain blank, insert a semicolon (;) for each blank field)  
The data string for each Sender Selection should be defined within a single line.  
The syntax is: <Sender Selection Number>;<User Name>;<Email Address>  
(a) 01 to 24: Indicates the Sender Selection Numbers  
(b) User Name (25-characters maximum)  
(c) Email Address (60-characters maximum)
- (3) @select-domain to @end : Defines the Selectable Domains to be set in section (3) between @select-domain to @end block. Register up to 10 Domain Names that can be selected during manual email addressing. (30-characters maximum)  
The syntax is: <Number>;<Domain>
- (4) @relay-domain to @end : Defines the Domain Names to be set in section (4) between @relay-domain to @end block. Register up to 10 Domain Names that have been authorized to access your Internet Fax for Relayed XMT Request. (30-characters maximum)
- (5) @system to @end : Defines the Internet Parameters to be set in section (5) between @system to @end block. Register the following Internet Parameters.  
(a) Default Domain (50-characters maximum).  
The syntax is: domain; <Default domain name>  
(b) Manager's Email Address (60-characters maximum).  
The syntax is: manager; <Manager's Email Address>  
(c) Relay XMT Password (10-characters maximum).  
The syntax is: relay; <Relay XMT Password>. Quotation marks " " enclosing the password, is required, as shown in the example above.  
(d) Remote Password (10-characters maximum).  
The syntax is: remote; <Remote Password>. Quotation marks " " enclosing the password, is required, as shown in the example above.
- (6) @ldap to @end : Defines the LDAP Parameters to be set in section (6) between @ldap to @end block. Register the following Internet Parameters.  
(a) LDAP Server Name (60-characters maximum).  
The syntax is: server;<LDAP Server Name>  
(b) LDAP Login Name (40-characters maximum).  
The syntax is: login;<LDAP Login Name>  
(c) LDAP Password (10-characters maximum).  
The syntax is: password;<LDAP Password>Quotation marks " " enclosing the password, is required, as shown in the example above.  
(d) LDAP Search Base (40-characters maximum).  
The syntax is: base;<LDAP Search Base>
- (7) @mib to @end : Defines the MIB to be set in section (7) between @mib to @end block. Register the following Internet Parameters.  
(a) Community Name(1) (32-characters maximum).  
The syntax is: com\_name1;<Community Name(1)>  
(b) Community Name(2) (32-characters maximum).  
The syntax is: com\_name2;<Community Name(2)>  
(c) Device Name(32-characters maximum).  
The syntax is: device;<Device Name>  
(d) Device Location(32-characters maximum).  
The syntax is: location;<Device Location>

### NOTE

1. The machine cannot be programmed via email while it is communicating or printing.

# Programming or Retrieving Parameters via Email

## To Retrieve the Internet Parameters for Backup

To retrieve the existing Internet Parameters, send a plain text email to the your machine's email address with the following command in the "Subject" line:

**#get parameters(password)#** : where the "password" is the Remote Password programmed in your machine's User Parameters (i.e. 123456789). For security, always input a Remote Password in the User Parameters. If it was not programmed, signify with "()" (i.e. #get parameters()).  
Make sure that the CC..., Bcc... lines and the body of the email message is Blank.

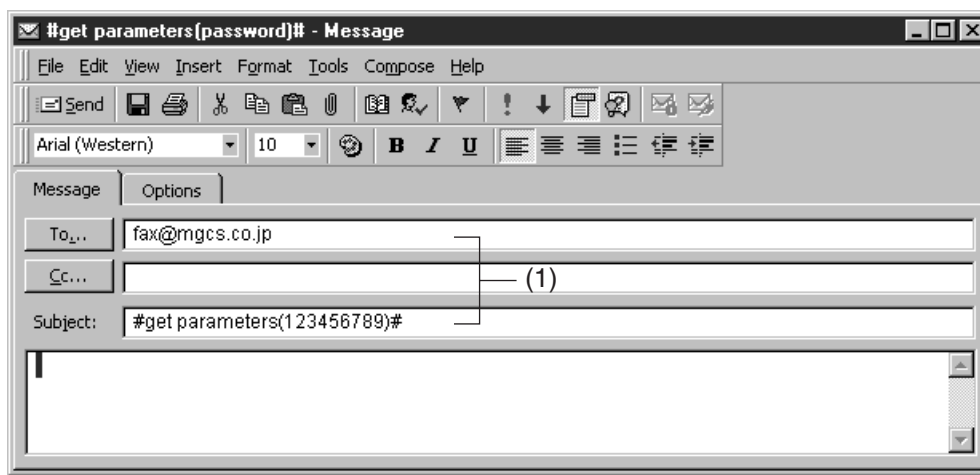

- (1) To : Your machine's email address.  
From : This field is normally not visible when creating new email message(s). It is your default email address (email application), for retrieving the Internet Parameters and for error message notification. (Can be programmed with the configuration tool of your email program.)  
Subject : To Retrieve data, type: #get parameters(password)#

# Programming or Retrieving Parameters via Email

## To Retrieve the Internet Parameters for Backup

After receiving the email message requesting the Internet Parameters, your machine sends back an email to the address specified in the "From:" line with the Internet Parameters in the body of the email.

### Your Machine's Internet Parameters Email Sample

```
From: fax@mgcs.co.jp
To: user@mgcs.co.jp
Cc:
Subject: Your Machine's SYSTEM PARAMETER List

#-----
# Your Machine's SYSTEM PARAMETER List
#
# STATION      : Internet_Fax
# EMAIL       : fax@mgcs.co.jp
# DATE/TIME   : MMM-dd-yyy hh:mm
#-----
# Internet parameters
#
# IP ADDRESS   :192.168.1.100
# SUBNET MASK  :255.255.255.0
# SMTP SERVER  :smtp.server.mgcs.co.jp
# DEF.ROUTER  :192.168.1.1
# DNS SERVER   :192.168.1.10
# POP SERVER   :pop3.server.mgcs.co.jp
# POP USER NAME :Internet_Fax
#-----
@sender
01;PDIC OSD;ifax1@panasonic.com
02;MGCS;ifax@mgcs.co.jp
@end
@select-domain
01;mgcs.co.jp
02;panasonic.co.jp
@end
@relay-domain
panasonic.co.jp
mgcs.co.jp
sales.panasonic.com
tech1.panasonic.com
@end
@system
domain;panasonic.com
manager;ifaxadmin@mgcs.co.jp
relay;"g3relay"
remote;"123456789"
@end
@ldap
server;ldapsvr
login;sonic777
password;"sbste7"
base;psonic789
@end
@mib
com_name1;commu1
com_name2;commu2
device;devname
location;devloca
@end
```

- (1) To : Your email address that was used to retrieve the Internet Parameters.  
From : Your machine's email address.  
Subject : Your machine's System Parameter List
- (2) @sender to @end : Defines up to 24 User Names and their Email Addresses programmed in your machine for the Sender Selection in section (2) between @sender to @end block.
- (3) @select-domain to @end : Defines up to 10 alternate Domain Names programmed in your machine for the Selectable Domains in section (3) between @select-domain to @end block.
- (4) @relay-domain to @end : Defines up to 10 Domain Names programmed in your machine that have been authorized to access your Internet Fax for Relayed XMT Request in section (4) between @relay-domain to @end block.

## Programming or Retrieving Parameters via Email

### To Retrieve the Internet Parameters for Backup

- (5) @system to @end : Defines the following Internet Parameters programmed in your machine in section (5) between @system to @end block.
  - (a) Default Domain
  - (b) Manager's Email Address
  - (c) Relay XMT Password
  - (d) Remote Password
  
- (6) @ldap to @end : Defines the following Internet Parameters programmed in your machine in section (6) between @ldap to @end block.
  - (a) LDAP Server Name
  - (b) LDAP Login Name
  - (c) LDAP Password
  - (d) LDAP Search Base
  
- (7) @mib to @end : Defines the following Internet Parameters programmed in your machine in section (7) between @mib to @end block.
  - (a) Community Name(1)
  - (b) Community Name(2)
  - (c) Device Name
  - (d) Device Location



# Programming or Retrieving Parameters via Email

## To Edit the Retrieved or Backup Internet Parameters File

After receiving your machine's email with the Internet Parameters, store the email file as text (.txt) on your PC for backup purposes.

To change or update the Internet Parameters, follow the steps below:

1. Create a New Email Message, fill out the "To" and "From" Address line and the Subject line information for section (1) below:

To : Your machine's email address.  
From : This field is normally not visible when creating new email message(s).  
It is your default email address (email application), for retrieving the Internet Parameters and for error message notification.  
Subject : To Store data, type: #set parameters(password)#

2. Open the backup, Internet Parameter text file. Copy the body text and paste it on the body of the newly created email message.
3. Delete any headers that may be present in the body of the email, as unsupported data will be rejected. The information following the "#" sign is ignored by your machine.
4. Edit a parameter and/or add additional Sender Name(s) or Domain Name(s).
5. When finished, use the "File/Save as..." command and save the updated file with ".txt" extension as a backup.
6. Send the email message to your machine to update the Internet Parameters.

# Programming or Retrieving Parameters via Email

## To Edit the Retrieved or Backup Internet Parameters File

### Your Machine's Internet Parameters Email Sample

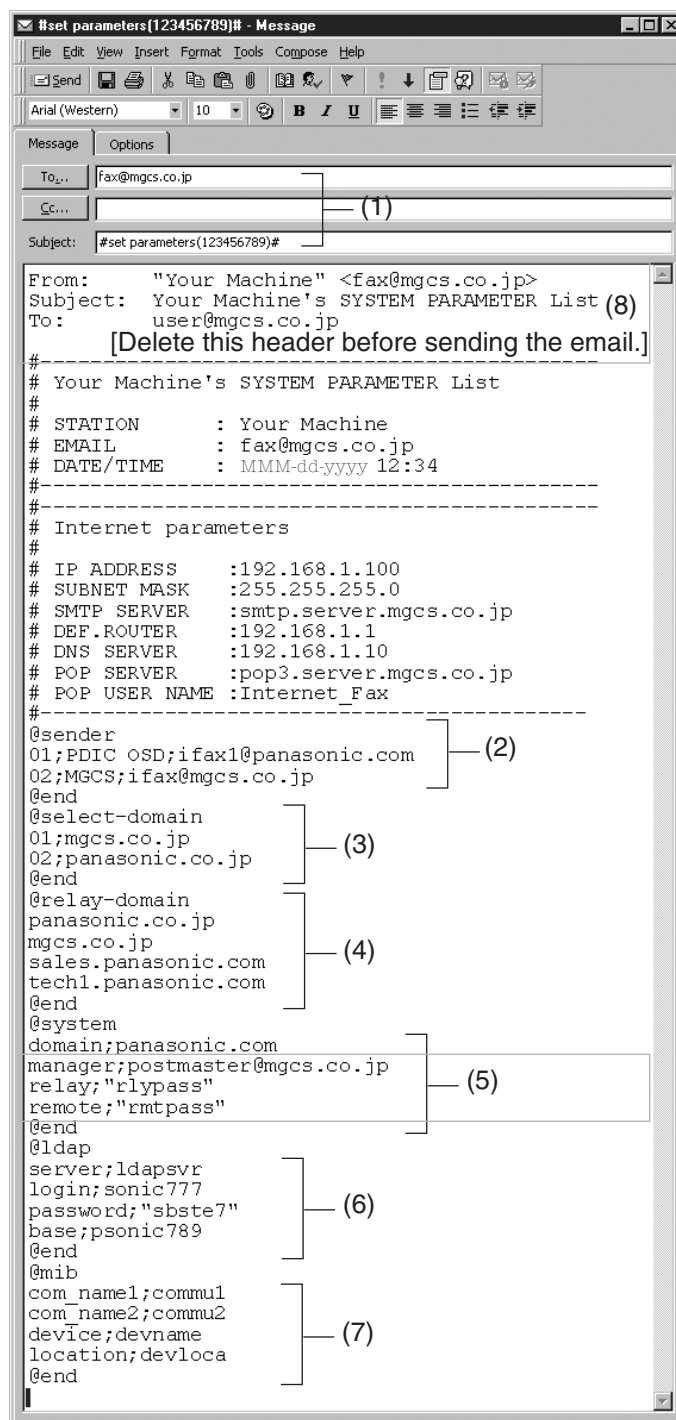

- (1) To : Your machine's email address.
- From : This field is normally not visible when creating new email message(s). It is your default email address (email application), for retrieving the Internet Parameters and for error message notification. (Can be programmed with the configuration tool of your email program.)
- Subject : To Store data, type: #set parameters(password)#

# Programming or Retrieving Parameters via Email

## To Edit the Retrieved or Backup Internet Parameters File

- (2) @sender to @end : Defines the Sender information to be set in section (2) between @sender to @end block. Edit, Delete or Register up to 24 User Names and their Email Addresses for the Sender Selection feature (See page 150).  
Separate each data field with a semicolon (;). (If the remaining fields are to remain blank, insert a semicolon (;) for each blank field)  
The data string for each Sender Selection should be defined within a single line.  
The syntax is: <Sender Selection Number>;<User Name>;<Email Address>  
(a) 01 to 24: Indicates the Sender Selection Numbers  
(b) User Name (25-characters maximum)  
(c) Email Address (60-characters maximum)
- (3) @select-domain to @end : Defines the Selectable Domains to be set in section (3) between @select-domain to @end block. Register up to 10 alternate Domain Names that can be selected during manual email addressing. (30-characters maximum)  
The syntax is: <Number>;<Domain>
- (4) @relay-domain to @end : Defines the Domain Names to be set in section (4) between @relay-domain to @end block. Register up to 10 Domain Names that have been authorized to access your Internet Fax for Relayed XMT Request. (30-characters maximum)
- (5) @system to @end : Defines the Internet Parameters to be set in section (5) between @system to @end block. Register the following Internet Parameters.  
(a) Default Domain (50-characters maximum).  
The syntax is: domain; <Default domain name>  
(b) Manager's Email Address (60-characters maximum).  
The syntax is: manager; <Manager's Email Address>  
(c) Relay XMT Password (10-characters maximum).  
The syntax is: relay; <Relay XMT Password>. Quotation marks " " enclosing the password, is required, as shown in the example above.  
(d) Remote Password (10-characters maximum).  
The syntax is: remote; <Remote Password>. Quotation marks " " enclosing the password, is required, as shown in the example above.  
(Notice that for the above example, we have changed the Manager's Email Address, Relay XMT Password and the Remote Password)
- (6) @ldap to @end : Defines the LDAP Parameters to be set in section (6) between @ldap to @end block. Register the following Internet Parameters.  
(a) LDAP Server Name (60-characters maximum).  
The syntax is: server;<LDAP Server Name>  
(b) LDAP Login Name (40-characters maximum).  
The syntax is: login;<LDAP Login Name>  
(c) LDAP Password (10-characters maximum).  
The syntax is: password;<LDAP Password>Quotation marks " " enclosing the password, is required, as shown in the example above.  
(d) LDAP Search Base (40-characters maximum).  
The syntax is: base;<LDAP Search Base>
- (7) @mib to @end : Defines the MIB to be set in section (7) between @mib to @end block. Register the following Internet Parameters.  
(a) Community Name(1) (32-characters maximum).  
The syntax is: com\_name1;<Community Name(1)>  
(b) Community Name(2) (32-characters maximum).  
The syntax is: com\_name2;<Community Name(2)>  
(c) Device Name(32-characters maximum).  
The syntax is: device;<Device Name>  
(d) Device Location(32-characters maximum).  
The syntax is: location;<Device Location>
- (8) : This header must be deleted before the email is sent to your machine for reprogramming of Internet Parameters.  
The information following the "#" sign is ignored by your machine, therefore, you can leave it as is, or delete it if you wish.

# Programming or Retrieving Parameters via Email

## Using a PC to Update the Auto Dialler Remotely

This feature provides a convenient and an easy way to Update, Backup or Restore the Phone Book data right from your PC by sending a text email message to your machine.

Your machine interprets the command that you enter in the "Subject" line of your email message and performs one of the following functions, it Retrieves or Stores data into the Auto Dialler (Phone Book).

The two types of commands that can be entered in the "Subject" line of your email:

- 1) To Store : **#set abbr(password)#** : where the "password" is the Remote Password programmed in your machine's User Parameters (i.e. 123456789).  
data, type  
You can program any known unused Auto Dialler location(s) with this command for the first time, without having to Retrieve the Phone Book data first. If the desired Auto Dialler location already contains data, your machine will overwrite the existing data, therefore, we recommend that you use the Retrieve command below instead.  
To edit existing Auto Dialler locations, refer to pages 66 to 67.
- 2) To Retrieve : **#get abbr(123456789)#**  
data, type

### NOTE

1. To activate this feature, change the Fax Parameter No. 158 (PC REMOTE UPDATE) to "Valid".  
(See page 83)

# Programming or Retrieving Parameters via Email

## Deleting the Entire Auto Dialler

If you wish to delete the entire Auto Dialler data in your machine, type the following command in the body of the email message:

```
@command  
delete  
@end
```

This command can also be inserted before the @begin to @end block, to erase the entire Auto Dialler data first, then reprogram it with new data.

This method will also prevent the "Overwrite Warning Message" that is sent back from your machine, when the current Auto Dialler station is overwritten.

To erase the entire Auto Dialler data, type the following command in the "Subject" line of your email:

**#set abbr(password)#** : where the password is the Remote Password programmed in your machine's User Parameters.  
Retrieve and backup the existing data onto your PC first by following the procedures for Retrieving and Editing on pages 64 to 67.

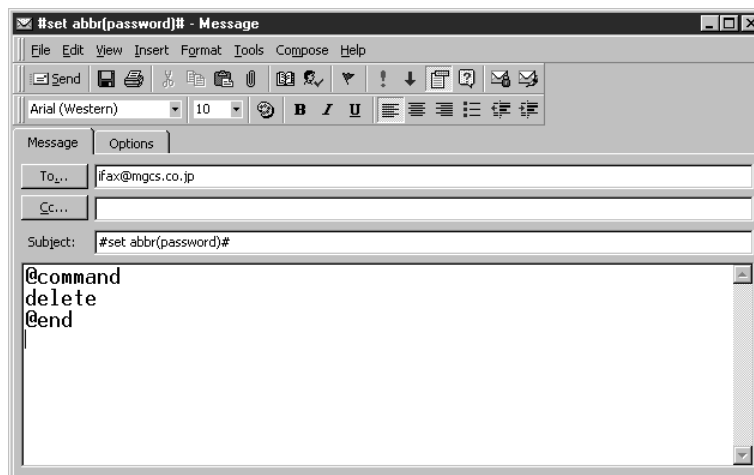

# Programming or Retrieving Parameters via Email

## To Program One-Touch/ABBR. No. for the First Time

Create a script in the message body of a plain text email and send it to your machine's email address. The "Subject" line of the email must be as follows:

**#set abbr(password)#** : where the password is the Remote Password programmed in your machine's User Parameters.

The script sample to program the One-Touch/ABBR. No. for the first time is shown in the illustration below:

### First Time Remote Programming of One-Touch/ABBR. No. Sample

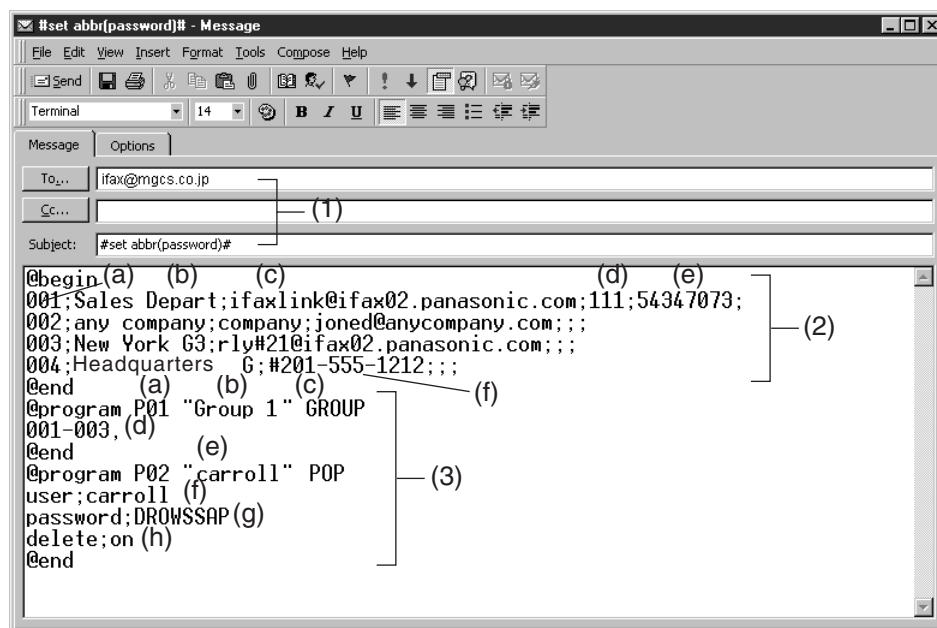

# Programming or Retrieving Parameters via Email

## To Program One-Touch/ABBR. No. for the First Time

### Explanation of Contents

- (1) To : Your machine's email address.
- From : This field is normally not visible when creating new email message(s). It is your default email address (email application), for retrieving the Phone Book data and for error message notification. (Can be programmed with the configuration tool of your email program.)
- Subject : To Store data, type: #set abbr(password)#  
To Retrieve data, type: #get abbr(password)#
- (2) @begin to @end block : Defines the data to be set into the Phone Book between @begin to @end block. Separate each data field with a semicolon (;). (If the remaining fields are to remain blank, insert a semicolon (;) for each blank field)  
The data string for each station should be defined within a single line.
- (a) Entry-number: One-Touch, ABBR. No. or Program Keys to be programmed
    - 001 to 100: indicates ABBR. No. 001 to 100 (100 stations maximum)
    - 1001 to 1028: indicates One-Touch numbers from 01 to 28
    - 2001 to 2004: indicates Program Keys (P1 to P4 programmed as One-Touch dialling number)
  - (b) Station-name: Name of the station being programmed (15 alpha-numeric characters maximum)
  - (c) Station-address: email address or telephone number of the station being programmed
  - (d) Routing-subaddress: sub-address to be used for routing (20-digit maximum)
  - (e) Routing-id-number: TSI to be used for routing (20-digit maximum)
  - (f) The End Receiving Station's telephone number is entered after the hash sign (#).
- (3) @program to @end : Defines the data to be set into Program Keys as a Group Key or POP Access Key between @program to @end block.
- (a) Program Key: P01 - P04
  - (b) Station-name as a Group Key: Name of the station being programmed (15 alpha-numeric characters maximum)
  - (c) GROUP: The syntax used to set the Program Key as a Group Key
  - (d) Entry-number: One-Touch, ABBR. No. or Program Keys to be programmed
    - 001 to 100: indicates ABBR. No. 001 to 100 (100 stations maximum)
    - 1001 to 1028: indicates One-Touch numbers from 01 to 28
    - 2001 to 2004: indicates Program Keys (P1 to P4 programmed as One-Touch dialling number)
  - (e) POP: The syntax used to set the Program Key as a POP Access Key
  - (f) POP User-name: Name of the station being programmed (40 alpha-numeric characters maximum)
  - (g) POP Password: POP Password (10 alpha-numeric characters maximum)
  - (h) Set whether the emails on the POP Server are deleted after retrieving the emails.

### NOTE

1. If a POP user account is programmed into the P1 to P4 program keys, the data programmed for this key cannot be deleted, even when the delete command is specified.
2. The email address and the telephone number cannot be programmed via email when:
  - One-Touch Number has been used for communication reservation.
  - Received documents are stored in the image data memory of the machine.
  - While the machine is communicating or printing.
3. When the email address and telephone number are programmed via email, a program result email is sent back.
4. Some email applications automatically insert a line feed in the middle of a line when the number of characters in a line exceed a specific number. Turn "Off" the automatic line feed, or define the number of characters per line to prevent a line feed, or the data will be ignored.

# Programming or Retrieving Parameters via Email

## To Retrieve One-Touch/ABBR. No. Data for Backup

To retrieve the existing auto dialler data, send a plain text email to your machine's email address with the following command in the "Subject" line:

**#get abbr(password)#** : where the "password" is the Remote Password programmed in your machine's User Parameters (i.e. 123456789).

Make sure that the Cc, Bcc lines and the body of the email message is Blank.

### Retrieving One-Touch/ABBR. No. Data Sample

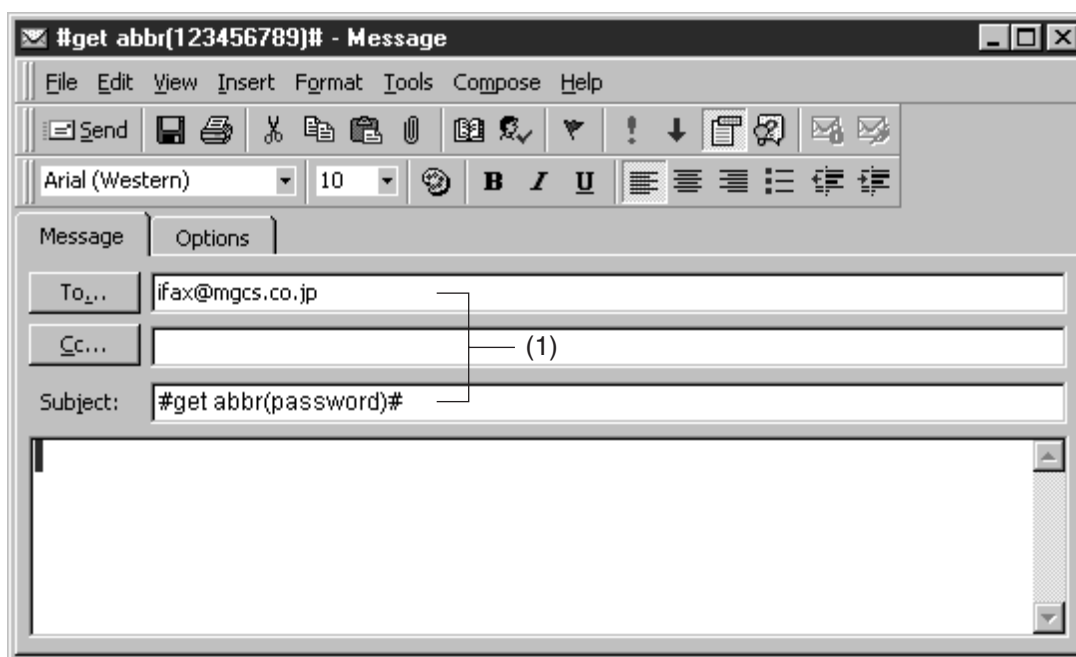

- (1) To : Your machine's email address.  
From : This field is normally not visible when creating new email message(s). It is your default email address (email application), for retrieving the One-Touch/ABBR. No. data and for error message notification. (Can be programmed with the configuration tool of your email program.)  
Subject : To Retrieve data, type: #get abbr(password)#



# Programming or Retrieving Parameters via Email

## To Retrieve One-Touch/ABBR. No. Data for Backup

After receiving the email message requesting the existing auto dialler data, your machine sends back an email to the address specified in the "From:" line with the auto dialler information in the body of the email.

### Your Machine's Auto Dialler Email Sample

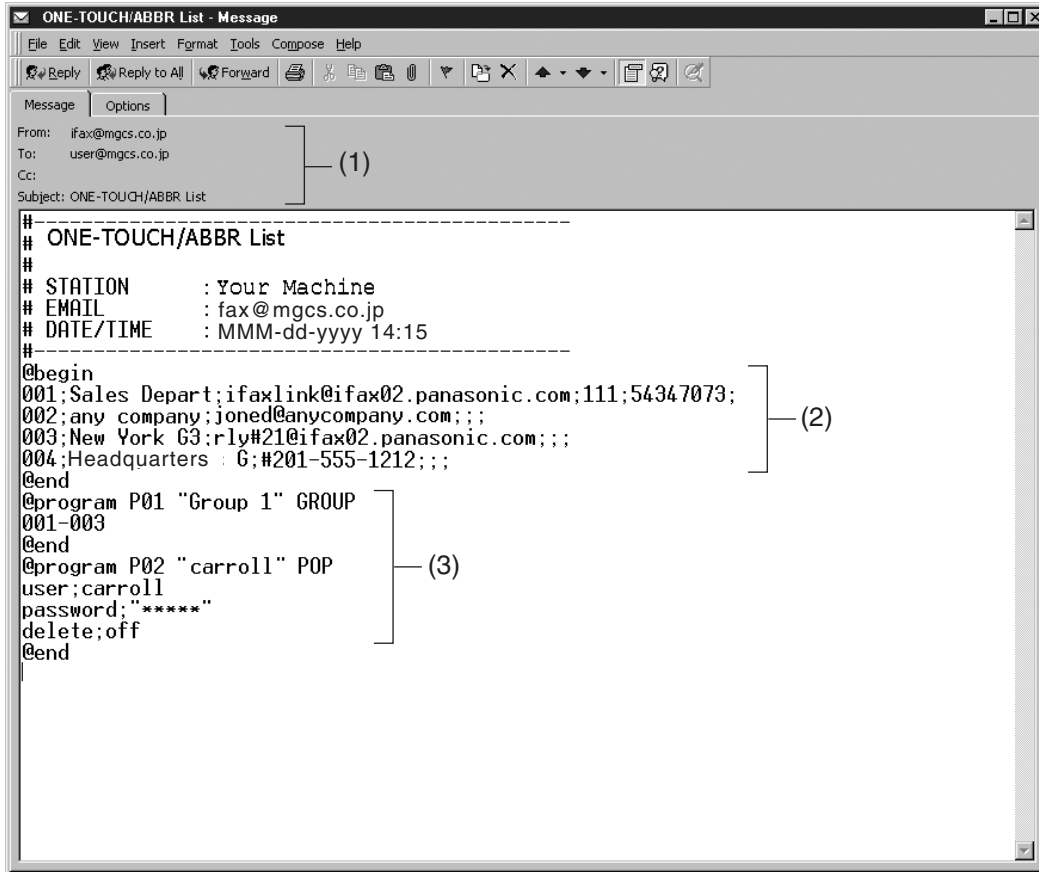

- (1) To : Your email address that was used to retrieve the Auto Dialler data.  
From : Your machine's email address.  
Subject : ONE-TOUCH/ABBR. List
- (2) @begin to @end block : Defines One-Touch Keys, Abbreviated Dialling Numbers and Program Keys stored as a One-Touch Key programmed in your machine in section (2) between @begin to @end block.
- (3) @program to @end : Defines Program Keys stored as a Group Key or POP Access Key programmed in your machine in section (3) between @program to @end block.

# Programming or Retrieving Parameters via Email

## To Edit the Retrieved or Backup One-Touch/ABBR. No. Data File

After receiving your machine email with the auto dialler data, store the email file as text (.txt) on your PC for backup purposes.

To change or update the auto dialler, follow the steps below:

1. Create a New Email Message, fill out the "To" and "From" Address line and the Subject line information for section (1) below:

To : Your machine's email address.  
From : This field is normally not visible when creating new email message(s). It is your default email address (email application), for retrieving the One-Touch/ABBR. No. data and for error message notification.  
Subject : To Store data, type: #set abbr(password)#

2. Open the backup, auto dialler text file. Copy the body text and paste it on the body of the newly created email message.
3. Delete any headers that may be present in the body of the email, as unsupported data will be rejected. The information following the "#" sign is ignored by your machine.
4. Edit and/or add additional One-Touch/ABBR. No. stations.
5. When finished, use the "File/Save as..." command and save the updated file with ".txt" extension as a backup.
6. Send the email message to your machine to update the auto dialler.

### Your Machine's Auto Dialler Email Sample

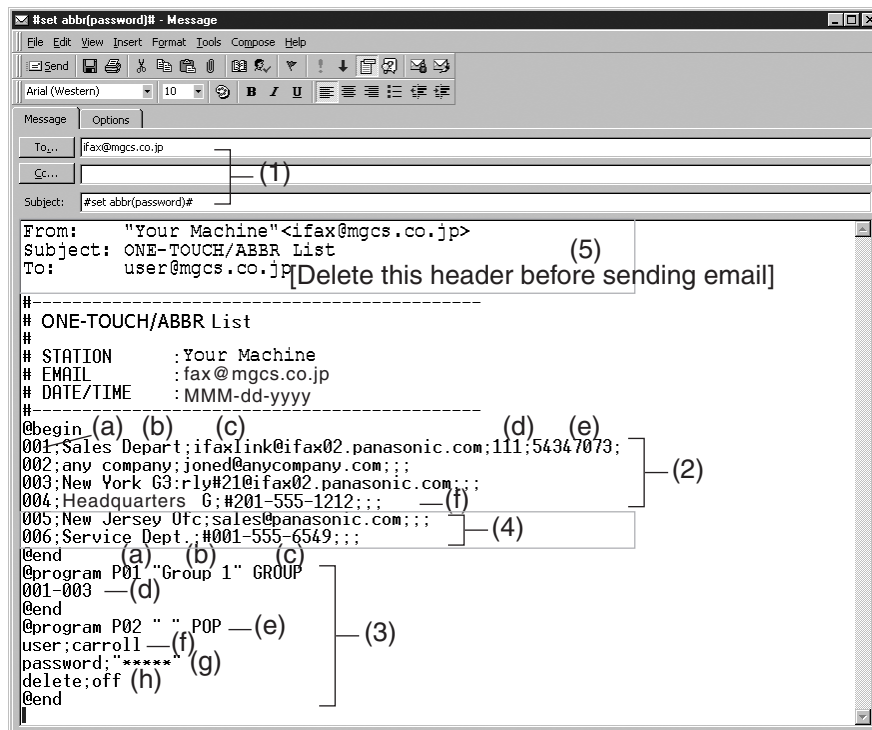

```
#set abbr(password)# - Message
File Edit View Insert Format Tools Compose Help
Send [Icons]
Arial (Western) 10 [Icons]
Message Options
To: fax@mgcs.co.jp
Cc:
Subject: #set abbr(password)#
From: "Your Machine" <ifax@mgcs.co.jp>
Subject: ONE-TOUCH/ABBR List
To: user@mgcs.co.jp [Delete this header before sending email]
#-----
# ONE-TOUCH/ABBR List
#
# STATION : Your Machine
# EMAIL : fax@mgcs.co.jp
# DATE/TIME : MMM-dd-yyyy
#
@begin (a) (b) (c) (d) (e)
001;Sales Depart;ifaxlink@ifax02.panasonic.com;111;54347073;
002;any company;ioned@anycompany.com;;;
003;New York G3;rly#21@ifax02.panasonic.com;;;
004;Headquarters G;#201-555-1212;;; (f)
005;New Jersey Ufc;sales@panasonic.com;;;
006;Service Dept.;#001-555-6549;;; (4)
@end (a) (b) (c)
@program P01 "Group 1" GROUP
001-003 (d)
@end
@program P02 " " POP (e)
user;carroll (f)
password;"*****" (g)
delete;off (h)
@end
```

# Programming or Retrieving Parameters via Email

## To Edit the Retrieved or Backup One-Touch/ABBR. No. Data File

- (1) To : Your machine's email address.  
From : This field is normally not visible when creating new email message(s).  
It is your default email address (email application), for retrieving the One-Touch/ABBR. No. data and for error message notification.  
(Can be programmed with the configuration tool of your email program.)  
Subject : To Store data, type: #set abbr(password)#
- (2) @begin to @end block : Defines the One-Touch Keys, Abbreviated Dialling Numbers and Program Keys stored as a One-Touch Key to be set in section (2) between @begin to @end block.  
Edit, Delete or Register the information.  
Separate each data field with a semicolon (;). (If the remaining fields are to remain blank, insert a semicolon (;) for each blank field)  
The data string for each station should be defined within a single line. The syntax is:<Entry-number>;<Station-name>;<Station-address>;<Routing-subaddress>;<Routing-id-number>  
(a) Entry-number: One-Touch, ABBR. No. or Program Keys to be programmed  
001 to 100: indicates ABBR. No. 001 to 100 (100 stations maximum)  
1001 to 1028: indicates One-Touch numbers from 01 to 28  
2001 to 2004: indicates Program Keys (P1 to P4 programmed as One-Touch dialling number)  
(b) Station-name: Name of the station being programmed (15 alpha-numeric characters maximum)  
(c) Station-address: email address or telephone number of the station being programmed  
(d) Routing-subaddress: sub-address to be used for routing (20-digit maximum)  
(e) Routing-id-number: TSI to be used for routing (20-digit maximum)  
(f) The End Receiving Station's telephone number is entered after the hash sign (#).
- (3) @program to @end : Defines the Program Keys stored as a Group Key or POP Access Key to be set in section (3) between @program to @end block.  
Edit, Delete or Register the information.  
(a) Program Key: P01 - P04  
(b) Station-name as a Group Key: Name of the station being programmed (15 alpha-numeric characters maximum)  
(c) GROUP: The syntax used to set the Program Key as a Group Key  
(d) Entry-number: One-Touch, ABBR. No. to be programmed  
001 to 100: indicates ABBR. No. 001 to 100 (100 stations maximum)  
1001 to 1028: indicates One-Touch numbers from 01 to 28  
2001 to 2004: indicates Program Keys (P1 to P4 programmed as One-Touch dialling number)  
(e) POP: The syntax used to set the Program Key as a POP Access Key.  
(f) POP User-name: Name of the POP user account (40 alpha-numeric characters maximum)  
(g) POP Password: POP Password (10 alpha-numeric characters maximum)  
(h) Set whether the emails on the POP Server are deleted after retrieving the emails.
- (4) These 2 ABBR. No. stations were added to the list.
- (5) This header must be deleted before the email is sent to your machine for reprogramming of One-Touch/ABBR. No. The information following the "#" sign is ignored by your machine, therefore, you can leave it as is or delete it if you wish.

# Programming or Retrieving Parameters via Email

## Using Email to Retrieve the Journal

To retrieve the existing Journal data, send an email to your machine's email address with the following command in the "Subject" line:

**#get jnl(password)#** : where the "password" is the Remote Password programmed in your machine's User Parameters (i.e. 123456789).

The Journal will be send back to the originating station's email address.

After receiving the journal, use a fixed width font (i.e. Courier), in order to align the received journal's contents on the PC.

A separate email message is sent by your machine, an "Internet Fax Return Receipt" to the Manager's email address programmed in the User Parameters, informing of the Journal transfer.

---

### NOTE

1. To activate this feature, change the Fax Parameter No. 158 (PC REMOTE UPDATE) to "Valid". (See page 83)

# Programming Email Address and Telephone Numbers

## Programming the Auto Dialler

One-Touch and Abbreviated dialling / email addressing are two fast ways of dialling full telephone numbers or email addresses. To use these dialling or addressing methods, you must first store the telephone numbers or email addresses into the Auto Dialler.

To program the One-Touch key, follow the steps below

1

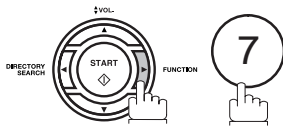

```
SET MODE      (1-8)
ENTER NO. OR ∨ ^
```

2

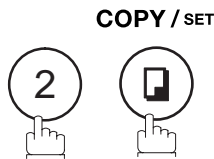

```
1: ONE-TOUCH
2: ABBR NO.
```

3



```
ONE-TOUCH< >
PRESS ONE-TOUCH
```

4

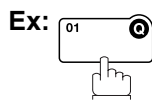

```
<01>
ENTER EMAIL ADDRESS
```

or

To change the input mode (between "ENTER EMAIL ADDRESS" and "ENTER TEL. NO."),



```
<01>
ENTER TEL. NO.
```

5

Enter the email address using character keys (up to 60 characters).

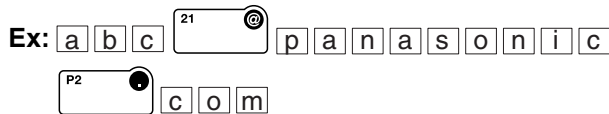

```
<01>
abc@panasonic.com
```

or

or

Enter the telephone number (up to 36 digits including pauses and spaces).



```
<01>
9-555 1234
```

6



```
<01>ENTER NAME
abc@panasonic.com
```

or

```
<01>ENTER NAME
9-555 1234
```

# Programming Email Address and Telephone Numbers

## Programming the Auto Dialler

**7** Enter the station name using character keys (up to 15 characters).

Ex: **S** **A** **L** **E** **S** **↵** **D** **E** **P** **T**

```
<01> SALES DEPT  
abc@panasonic.com
```

or

```
<01> SALES DEPT  
9-555 1234
```

**8**

**COPY / SET**



To record another number, repeat Steps 4 to 8.

To return to standby, press **STOP**.

```
ONE-TOUCH< >  
PRESS ONE-TOUCH
```

### NOTE

1. If you enter the Station name with the Fax Parameter 172 (DIRECT IFAX XMT) set to "Valid," you are allowed to select the usage of Direct IFAX XMT.

# Programming Email Address and Telephone Numbers

## Programming the Auto Dialler

To program the ABBR. dialling number or email address

1

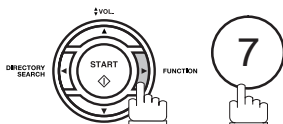

```
SET MODE      (1-8)
ENTER NO. OR ∨ ^
```

2

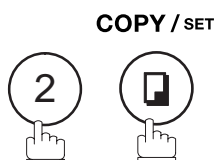

```
1:ONE-TOUCH
2:ABBR NO.
```

3



```
ABBR[ ]
ENTER ABBR NO.
```

4

Ex: ① ② ② (001 to 100, up to 100 stations)

To change the input mode (between "ENTER EMAIL ADDRESS" and "ENTER TEL. NO."),



```
[022]
ENTER EMAIL ADDRESS
```

or

```
[022]
ENTER TEL. NO.
```

5

Enter the email address using character keys (up to 60 characters).

Ex: a b c <sup>21</sup> @ p a n a s o n i c <sub>P2</sub> c o m

or

Enter the telephone number (up to 36 digits including pauses and spaces).

Ex: ⑨ PAUSE ⑤ ⑤ ⑤ ② ③ ④ ⑤

```
[022]
abc@panasonic.com
```

or

```
[022]
9-555 2345
```

6

COPY / SET



```
[022]ENTER NAME
abc@panasonic.com
```

or

```
[022]ENTER NAME
9-555 2345
```

7

Enter the station name using character keys (up to 15 characters).

Ex: A C C O U N T I N G

```
[022]ACCOUNTING
abc@panasonic.com
```

or

```
[022]ACCOUNTING
9-555 2345
```

# Programming Email Address and Telephone Numbers

## Programming the Auto Dialler

# 8

**COPY / SET**



ABBR[■ ]  
ENTER ABBR NO.

To record another number, repeat Steps 4 to 8.

To return to standby, press **STOP**.

### NOTE

1. If you require a special access number to get an outside line, enter it first and then press **PAUSE**. A hyphen "-" is displayed for pause.
2. If you are using Pulse dialling and you wish to change to Tone dialling in the middle of dialling, press **\*** (represented by a "/"). The dialling method will be changed from Pulse to Tone after dialling the digit "/".  
**Ex : 9 PAUSE \* 5551234**
3. If you enter the Station name with the Fax Parameter 172 (DIRECT IFAX XMT) set to "Valid," you are allowed to select the usage of Direct IFAX XMT.



# Programming Email Address and Telephone Numbers

## Editing or Erasing the Auto Dialling Number / Email Address

If you have to change or erase any of the One-Touch/Abbreviated dialling numbers or email addresses, follow the steps below.

To edit One-Touch/ABBR dialling number or email address

1

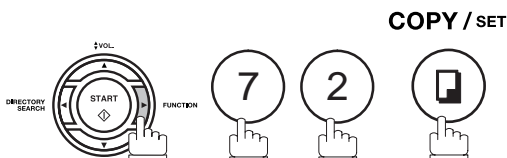

```
1:ONE-TOUCH
2:ABBR NO.
```

2

Select ① for One-Touch dialling number / email address.  
Select ② for ABBR dialling number / email address.

```
ONE-TOUCH< >
PRESS ONE-TOUCH
```

3

Ex: ①  
Enter the station you wish to change.

```
<01> SALES DEPT
abc@panasonic.com
```

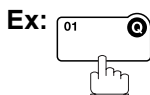

or

```
<01> SALES DEPT
9-555 1234
```

4

CLEAR



```
<01> SALES DEPT
ENTER EMAIL ADDRESS
```

or

```
<01> SALES DEPT
ENTER TEL. NO.
```

5

To change the input mode (between "ENTER EMAIL ADDRESS" and "ENTER TEL. NO."),



6

Enter a new email address. (See Note 1 and 2)

Ex: x y z <sup>21</sup> @ p a n a s o n i c  
P2 <sup>2</sup> c o m

```
<01> SALES DEPT
xyz@panasonic.com
```

or

```
<01> SALES DEPT
9-555 3456
```

or

Enter a new telephone number. (See Note 1 and 2)

Ex: ⑨ PAUSE ⑤ ⑤ ⑤ ③ ④ ⑤ ⑥

7

COPY / SET



```
<01>SALES DEPT
xyz@panasonic.com
```

# Programming Email Address and Telephone Numbers

## Editing or Erasing the Auto Dialling Number / Email Address

### 8

**CLEAR**



Enter a new station name. (See Note 1)

Ex:

```
<01>ENTER NAME  
xyz@panasonic.com
```

or

```
<01>ENTER NAME  
9-555 3456
```

```
<01> PANAFAX  
xyz@panasonic.com
```

or

```
<01> PANAFAX  
9-555 3456
```

### 9

**COPY / SET**



To return to standby, press .

```
ONE-TOUCH< >  
PRESS ONE-TOUCH
```

### NOTE

1. If you make a mistake, use  or  to move the cursor one space beyond the incorrect number, press  then re-enter the new number.
2. If the One-Touch/Abbreviated dialling number / email address has been used for a communication reservation, the settings cannot be changed or erased until the communication has finished.  
To change or erase the settings, cancel the communication first by Edit File Mode. (See page 160)

# Programming Email Address and Telephone Numbers

## Editing or Erasing the Auto Dialling Number / Email Address

To erase the One-Touch/ABBR. dialling number or email address

1

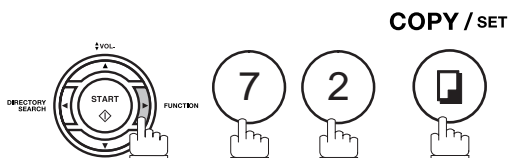

```
1:ONE-TOUCH  
2:ABBR NO.
```

2

Select ① for One-Touch dialling number / email address.  
Select ② for ABBR dialling number / email address.

```
ONE-TOUCH< >  
PRESS ONE-TOUCH
```

Ex: ①

3

Enter the station you wish to erase.

Ex: 01

```
<01> SALES DEPT  
abc@panasonic.com
```

or

```
<01> SALES DEPT  
9-555 1234
```

4

CLEAR



```
<01> SALES DEPT  
ENTER EMAIL ADDRESS
```

or

```
<01> SALES DEPT  
ENTER TEL. NO.
```

5

COPY / SET



To return to standby, press  .

```
ONE-TOUCH< >  
PRESS ONE-TOUCH
```

### NOTE

1. If the One-Touch/Abbreviated dialling number / email address has been used for a communication reservation, the settings cannot be changed or erased until the communication has finished.

To change or erase the settings, cancel the communication first by Edit File Mode. (See page 160)

# Programming Email Address and Telephone Numbers

## Printing Out a Directory Sheet

After programming the Auto Dialler, you can print out the directory sheet which includes the first 12 characters of each station name. Cut along the dotted line and place it over the One-Touch keys under the Directory Sheet Cover. To print a directory sheet, follow the steps below.

**1**

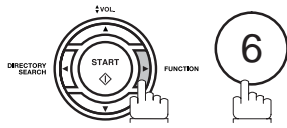

PRINT OUT (1-7)  
ENTER NO. OR V ^

**2**

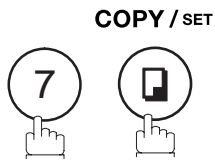

\* PRINTING \*  
DIRECTORY SHEET

Your machine prints out the directory sheet.

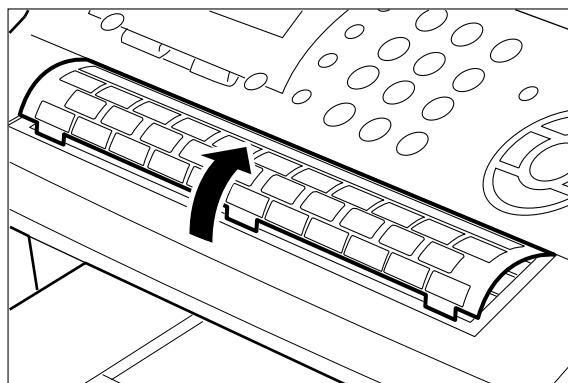
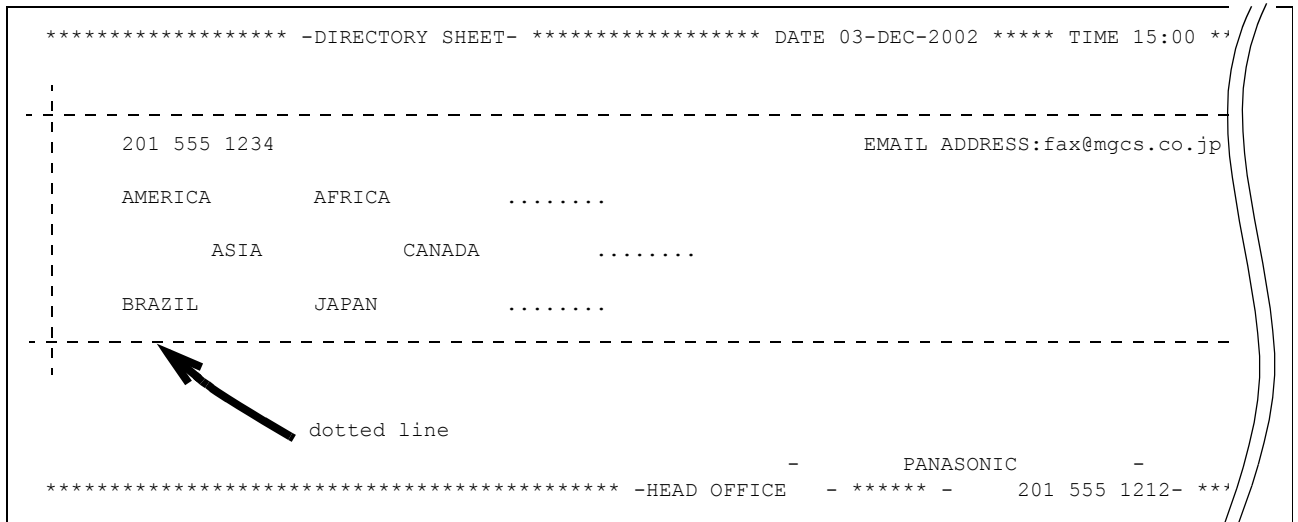

# Customizing Your Machine

## General Description

Your machine has a variety of adjustable Fax Parameters. These parameters, listed in the Parameter Table, are preset for you and do not need to be changed. If you do want to make a change, read the table carefully. Some parameters, such as the Resolution and Contrast parameters, can be temporarily changed by simple key operation just before a transmission is made. When the transmission ends, however, these parameters return to their preset values (Home position). Other parameters can only be changed by the procedure described below.

## Setting the Fax Parameters

1

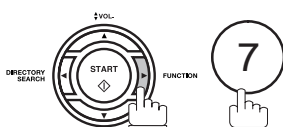

```
SET MODE      (1-8)
ENTER NO. OR ∨ ^
```

2

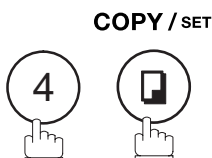

```
FAX PARAMETER (1-174)
NO. =■
```

3

Enter Fax Parameter number from the Parameter Table.  
Ex: 0 0 1 for **CONTRAST**

```
FAX PARAMETER (1-174)
NO. =001
```

4



```
01 CONTRAST
1: NORMAL
```

5

Enter the new setting value.  
Ex: 2 for **LIGHTER**

```
01 CONTRAST
2: LIGHTER
```

6



```
02 RESOLUTION
2: FINE
```

To set another parameter, press **CLEAR** to return to step 3 or press **STOP** to return to standby.

### NOTE

1. To scroll the Fax Parameters in Step 2 or 4, press ▼ or ▲.
2. To print out a Fax Parameter List, see page 220.

# Customizing Your Machine

## Fax Parameter Table

No.	Parameter	Setting Number	Setting	Comments
001	CONTRAST	1	Normal	Setting the home position of the CONTRAST key.
		2	Lighter	
		3	Darker	
002	RESOLUTION	1	Standard	Setting the home position for the RESOLUTION.
		2	Fine	
		3	S-Fine	
		4	Halftone (Fine)	
		5	Halftone (S-Fine)	
004	STAMP	1	Off	Setting the home position of the STAMP key. To select the stamp function when document is stored in memory, see Fax Parameter No. 28.
		2	On	
005	MEMORY	1	Off	Setting the home position for memory transmission/copy mode. (This setting can be temporarily changed by using F8-9 (MEMORY XMT))
		2	On	
006	DIALLING METHOD	1	Pulse	Selecting the dialling method.
		2	Tone	
007	HEADER PRINT	1	Inside	Selecting the printing position of the header. <b>Inside</b> : Inside TX copy area. <b>Outside</b> : Outside TX copy area. <b>No print</b> : Header is not printed.
		2	Outside	
		3	No print	
008	HEADER FORMAT	1	Logo, ID No.	Selecting the header format.
		2	From To	
009	RCV'D TIME PRINT	1	Invalid	Selecting whether the machine prints the received date & time, remote ID, percentage of reduction and page number on the bottom of each received page.
		2	Valid	
010	KEY/BUZZER VOLUME	1	Off	Selecting the volume of the Key/Buzzer tone.
		2	Soft	
		3	Loud	
012	COMM. JOURNAL	1	Off	Selecting the home position of printout mode for COMM. Journal Off/Always/INC. <b>Off</b> : Does not print <b>Always</b> : Always prints <b>Inc. Only</b> : Prints only when communication has failed.
		2	Always	
		3	Inc. Only	
013	AUTO JOURNAL PRINT	1	Invalid	Selecting whether the machine prints the journal automatically after every 32 transactions.
		2	Valid	

## Fax Parameter Table

No.	Parameter	Setting Number	Setting	Comments
017	RECEIVE MODE	1	TEL	Setting the receive mode.
		2	FAX	
		3	FAX/TEL SW.	
		4	TAM/FAX	
018	OPERATOR CALL TIMER	1	20 sec.	Selecting the length of time that your machine signals (rings) for an incoming voice call in Fax/Tel Auto Switching mode. (See page 129)
		2	30 sec.	
		3	40 sec.	
		4	50 sec.	
019	OGM LENGTH (TAM I/F)	1	1 sec.	Setting for the OGM length of your TAM from 1 to 60 seconds. The machine will not start to detect SILENCE until the time setting has lapsed. (Default = 20 sec.)
		---	---	
		60	60 sec.	
020	SILENT DETECTION (TAM I/F)	1	Invalid	Selecting the Silent Detection Mode.
		2	Valid	
022	SUBSTITUTE RCV	1	Invalid	Selecting whether the machine receives to memory when recording paper runs out, toner runs out or recording paper is jammed.
		2	Valid	
023	RECORDING PAPER SIZE	1	A4	Setting the recording paper size installed in your machine.
		2	Letter	
		3	Legal	
024	PRINT REDUCTION	1	Fixed	Selecting print reduction mode. <b>Fixed</b> : Reduce received document according to setting of Parameter No. 25. <b>Auto</b> : Reduce received document according to the length of received documents.
		2	Auto	
025	REDUCTION RATIO	70	70%	Selecting fixed print reduction ratio from 70% to 100%. This parameter functions only when fixed print reduction is selected on Fax Parameter No. 24.
		----	----	
		100	100%	
026	POLLING PASSWORD		(----	Setting a 4-digit password for secured polling.
027	POLLED FILE SAVE	1	Invalid	Selecting whether the machine retains the polled document in memory even after the document is polled once.
		2	Valid	
028	STAMP AT MEM. XMT	1	Invalid	Selecting whether the machine stamps the original documents when storing the documents into memory. (Depending on the Stamp setting on the Control Panel)
		2	Valid	
30	DRD SERVICE	1	Invalid	Selecting whether or not the machine is available "DRD Service". If this parameter is set to "Valid", your machine detects the specified ring pattern only to receive a document automatically.
		2	Valid	

Continued on the next page...

# Customizing Your Machine

## Fax Parameter Table

No.	Parameter	Setting Number	Setting	Comments
031	INCOMPLETE FILE SAVE	1	Invalid	Selecting whether the machine retains the document in memory if the document is not successfully transmitted.
		2	Valid	
032	COPY REDUCTION	1	Manual	Selecting whether the machine performs the copy reduction ratio automatically or manually. <b>Manual</b> : The machine will prompt you for the Zoom ratio (100% to 70%) when making copies. <b>Auto</b> : The machine will automatically determine the reduction ratio according to the length of the original document.
		2	Auto	
034	ENERGY SAVER MODE	1	Off	To reduce the power consumption in standby, select either Energy-Saver or Sleep mode and specify the Delay Time (1 to 120 minutes) for the machine to enter into the selected mode. The Delay Timer setting is only available in the Energy-Saver or Sleep Modes. <b>Off</b> : The unit will remain in standby mode and consume more energy than when in Energy-Saver or Sleep modes. <b>Energy-Saver Mode</b> : Saves energy by consuming less power than when in standby mode by turning off the fuser unit after the specified time.
		2	Energy-Saver	
035	DAYLIGHT TIME	1	Invalid	Selecting whether the clock adjusts for Daylight Saving Time automatically. The built-in clock will advance 1 hour at 2:00 am on the first Sunday in April and fallback 1 hour at 2:00 am on the last Sunday in October.
		2	Valid	
037	RCV TO MEMORY		(----	Enter a 4-digit password used to print out the received document in memory by using F8-5 (RCV TO MEMORY). When F8-5 is set to On, this parameter will not be shown on the LCD display. (See page 170)
038	ACCESS CODE		(----	Enter a 4-digit Access Code to secure the machine from unauthorized use. (See page 168)
039	PIN CODE ACCESS	1	None	Selecting the access method (Prefix or Suffix) to dial a number with PIN Code. (See page 175)
		2	Suffix	
		3	Prefix	
042	CONF. POLLED FILE SAVE	1	Invalid	Selecting whether the machine saves the confidential polled file even after the file is polled once.
		2	Valid	
043	PASSWORD-XMT	1	Off	Setting a 4-digit XMT-Password and selecting whether the machine performs and checks the XMT-Password of the receiving station when transmitting. (See page 196)
		2	On	
044	PASSWORD-RCV	1	Off	Setting a 4-digit RCV-Password and selecting whether the machine performs and checks the RCV-Password of the transmitting station when receiving. (See page 197)
		2	On	
046	SELECT RCV	1	Invalid	Selecting whether the machine performs selective reception. (See page 194)
		2	Valid	



## Fax Parameter Table

No.	Parameter	Setting Number	Setting	Comments
047	REMOTE RECEPTION	1	Invalid	Selecting whether or not the machine accepts remote reception command. (See page 128)
		2	Valid	
48	TELEPHONE LINE	1	PSTN	Selecting the type of line connected.
		2	PBX	
49	PSTN ACCESS CODE		(----	Setting PSTN Access Code. (max. 4 digits)
051	REMOTE DIAGNOSTIC	1	Invalid	Selecting whether or not the machine accepts to update the firmware or Remote Diagnostics from the remote station. Please ask your Panasonic Authorized Dealer for details.
		2	Valid	
052	DIAGNOSTIC PASSWORD		(----	Setting the password for Remote Diagnostic Mode. Please ask your Panasonic Authorized Dealer for details.
053	SUB-ADDRESS PASSWORD		(----	Setting a 20-digit password for secured sub-address communication.
054	FAX FORWARD	1	Invalid	Selecting whether the machine performs Fax Forwarding to the specified destination. (See page 177)
		2	Valid	
056	COVER SHEET	1	Off	Setting the home position of the Cover Sheet parameter in the Select Mode. (See page 173)
		2	On	
57	COUNTRY CODE			Selecting the country code when installing your machine.
58	LANGUAGE			Selecting the language to be shown on the display and reports.
64	CHANGE KEYBOARD	1	DEFAULT	Selecting the type of the Directory Sheet Cover. Change the setting to CHANGE if using the Directory Sheet Cover included with the accessory box.
		2	CHANGE	
065	PRINT COLLATION	1	Invalid	Selecting whether the machine prints out documents in sequence. (See page 135)
		2	Valid	
082	QUICK MEMORY XMT	1	Invalid	Selecting whether the machine performs Quick Memory Transmission. (See page 107 to 109) <b>Invalid</b> : Stores all documents into memory first before dialling the telephone number. <b>Valid</b> : Starts dialling the telephone number immediately after storing the first page.
		2	Valid	
099	MEMORY SIZE (Flash Memory)	-	-	Displays the amount of base and optional memory installed. (Base Memory + Optional Memory)
140	LAN RELAY XMT REQUEST	1	Invalid	Selecting whether the machine performs LAN Relay XMT Request.
		2	Valid	
142	RELAY XMT (a.k.a. LAN RELAY STATION on UF-770i)	1	Invalid	Selecting whether the machine accepts and performs G3 relayed transmission. (Relay Station Functions)
		2	Valid	

Continued on the next page...

# Customizing Your Machine

## Fax Parameter Table

No.	Parameter	Setting Number	Setting	Comments
143	RELAY XMT REPORT	1	Off	Setting how the COMM. Journal for relayed transmission is sent to the originator. <b>Off</b> : Don't send. <b>Always</b> : Always send. <b>Inc. Only</b> : Send only if communication has failed.
		2	Always	
		3	Inc. Only	
144	EMAIL CHARACTER SET	1	Japanese	Selecting the Character Set when receiving or sending email text.
		2	English	
145	SENDER SELECTION	1	Invalid	Selecting a pre-programmed sender's name and email address before each transmission.
		2	Valid	
146	POP TIMER	----	0 to 60 min.	Setting the time interval for the machine to check for email on the POP Server. (0 = Does not check the POP Server for email.)
		3		
147	AUTO POP RCV	1	Invalid	Selecting whether the machine automatically downloads an email from the POP Server.
		2	Valid	
148	DELETE POP RCV EMAIL	1	Invalid	Selecting whether the email will be deleted automatically after retrieval from the POP Server.
		2	Valid	
149	DELETE POP ERR EMAIL	1	Invalid	Selecting whether to delete the email that includes an incompatible file attachment from the POP Server.
		2	Valid	
150	IFAX RETURN RECEIPT	1	Invalid	Selecting whether to send a return receipt when receiving from another Panasonic Internet Fax.
		2	Valid	
151	EMAIL HEADER FORMAT	1	All	Selecting the header information to print when an email is received. (Normally used for Troubleshooting. It shows the path of the email transmission before arriving at your machine.)
		2	Subject/From/To	
		3	Off	
152	SUB-ADDRESS ROUTING	1	Invalid	Selecting whether to automatically route a received fax or email using ITU-T Sub-address.
		2	Valid	
153	TSI ROUTING	1	Invalid	Selecting whether to route a received fax to a telephone number or an email address preprogrammed in Phone Book using the originating fax's Numeric ID (TSI frame information).
		2	Valid	
154	ROUTING HEADER FORMAT	1	Originator	Selecting the type of email header to be included in the "From" field of each routed faxes. <b>Originator</b> : The originating fax machine's TSI will appear in the "From" field of the routed email. <b>Relay Station</b> : The routing station's email address will appear in the "From" field of the routed email.
		2	Relay Station	
155	PRINT ROUTED DOCUMENT	1	Inc. Only	Selecting whether a received fax to be routed is always printed or only when the routing operation fails.
		2	Always	

## Fax Parameter Table

No.	Parameter	Setting Number	Setting	Comments
156	PRINT FORWARDED DOCUMENT	1	Inc. Only	Selecting whether a memory received fax or email to be forwarded is always printed or only when forwarding is incomplete.
		2	Always	
157	TRANSACTION JOURNAL	1	Invalid	Selecting whether the machine sends a transaction journal to the pre-programmed email address.
		2	Valid	
158	PC REMOTE UPDATE	1	Invalid	Selecting whether the machine will accept commands from an email application, to: (a) Program the Internet Parameters (b) Program the Auto Dialler (c) Allow retrieval of the Journal
		2	Valid	
159	SUBJECT LINE ENTRY	1	Invalid	Selecting whether the "Subject" line can be programmed during each transmission.
		2	Valid	
160	DEFAULT DOMAIN	1	Invalid	Selecting whether the machine accepts to insert the Default Domain when entering Manual Number Dialling.
		2	Valid	
161	DNS SERVER	1	Invalid	Selecting whether to use the DNS Server for the Internet communication.
		2	Valid	
162	TIFF VIEWER URL	1	None	Selecting whether to include the URL address in the email message body.
		2	English	
		3	English+ Japanese	
163	ROUTING HEADER	1	Invalid	Selecting whether to add the Header Print information of the Routing Station on the top edge of each routed pages.
		2	Valid	
164	IFAX XMT HEADER (Email only)	1	Included	Selecting whether to include the header when sending a document to an addressee in the same Domain as specified in the Default Domain parameter. (This is useful when using the machine to scan documents back to your PC) <b>Note:</b> When sending to a Domain other than as specified in the Default Domain parameter, the header will be included regardless of the selection.
		2	Not Included	
169	DHCP CLIENT	1	Invalid	Select whether the machine would automatically acquire the Network Parameters from the DHCP Server. (Such as IP Address, Subnet Mask, Default Gateway IP Address, etc.) <b>Note:</b> If you change the setting of this parameter, the machine will reboot automatically.
		2	Valid	
170	SMTP AUTHENTICATION (See Note 3)	1	Invalid	Selecting whether your SMTP Server (Outgoing Mail Server) requires authentication with a user name and password before accepting email. After change the setting to "Valid", you can enter the user name and password assigned to your machine by your network administrator.
		2	Valid	
171	POP BEFORE SMTP (See Note 3)	1	Invalid	Selecting whether your SMTP Server (Outgoing Mail Server) requires authentication by first retrieving incoming email from the POP Server before accepting email. (Please consult with your network administrator).
		2	Valid	

Continued on the next page...

## Customizing Your Machine

### Fax Parameter Table

No.	Parameter	Setting Number	Setting	Comments
172	DIRECT IFAX XMT	1	Invalid	Selecting whether to be prompted during One-Touch/ABBR registration if the station you are programming is to receive Internet Fax directly without going through a Mail Server.
		2	Valid	
173	DELIVERY NOTICE (HOME)	1	Off	Setting the home position of requesting a Delivery Notice (MDN) on the Function Select Mode (F8-2) when sending an email/Internet Fax. The delivery notice received will not be printed. It is used to update the communication status on the Transaction Journal of the original email sent.
		2	On	
174	APOP AUTHENTICATION (See Note 3)	1	Invalid	Selecting whether to use APOP authentication method when retrieving email/Internet Fax from the POP Server. (This setting is server dependant; consult with your network administrator).
		2	Valid	

#### NOTE

1. The standard settings are printed on the Fax Parameter List. To print out Fax Parameter List, see page (See page 220).
2. The contents of Fax Parameter may differ depending on the each country's regulation or specification.
3. "Valid" can be selected when the SMTP server or the POP server support the capabilities.

# Loading Documents

## Documents You Can Send

In general, your machine will send any document printed on A4, Letter or Legal size paper.

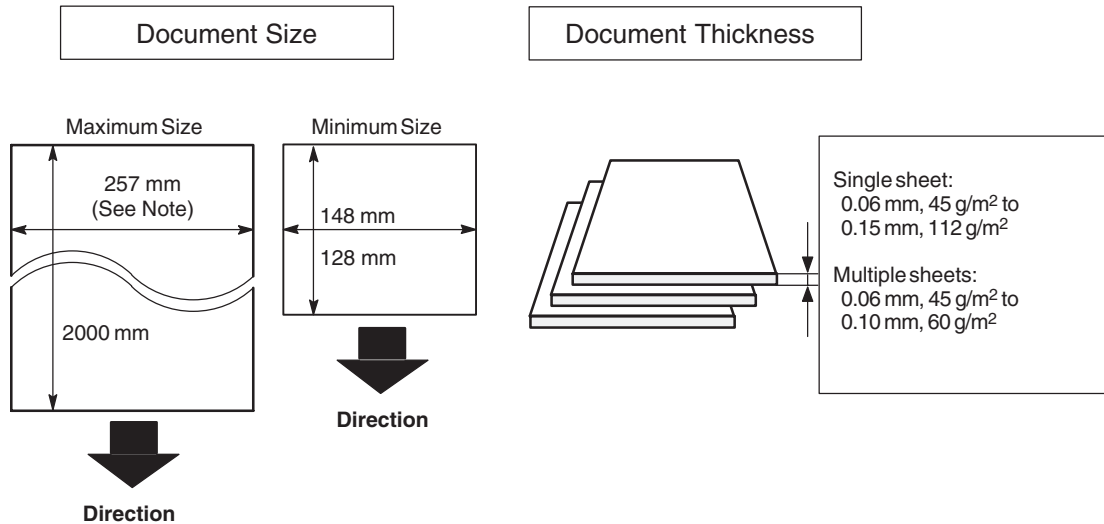

**Note:** The maximum document width that can be sent through the machine is 257mm. However, the effective scanning width is 208mm.

## Documents You Cannot Send

You must never try to send documents that are:

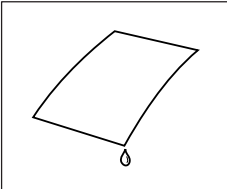
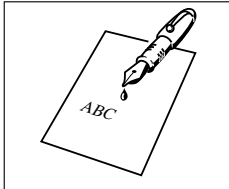
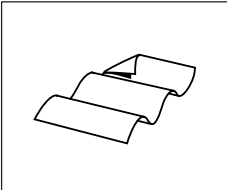
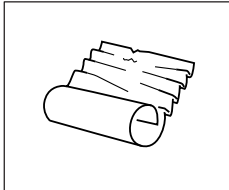
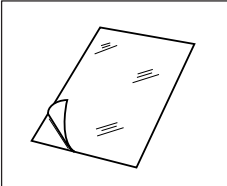
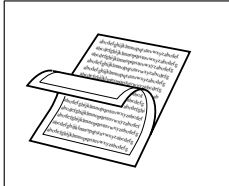
	Wet		Covered with wet ink or paste
	Too thin (e.g., onionskin, airmail paper, pages from some magazines, etc.)		Wrinkled, curled or folded
	Coated (e.g., glossy paper, etc.)		Chemically processed (e.g., pressure-sensitive paper, carbon-coated paper, etc.) or made of cloth or metal

To transmit these kinds of documents, make a photocopy first and then transmit the copy instead.

# Loading Documents

## How to Load Documents

1. Be sure the document(s) is free of staples, paper clips and is not torn, greasy or covered by foreign objects.
2. Place the document(s) **FACE DOWN** on the Automatic Document Feeder (ADF) until the leading edge placed into the machine stops.  
If you are sending multiple pages, make sure that **the bottom sheet enters first**. You can also stack up **to 30 PAGES** on the ADF at one time **by staggering the documents as illustrated below**. If you have more than 30 pages, wait until transmission or storing in memory starts as pages feed through, place any remaining pages on top of the last page in the feeder.
3. Adjust the Document Guides to center the document(s) on the ADF.

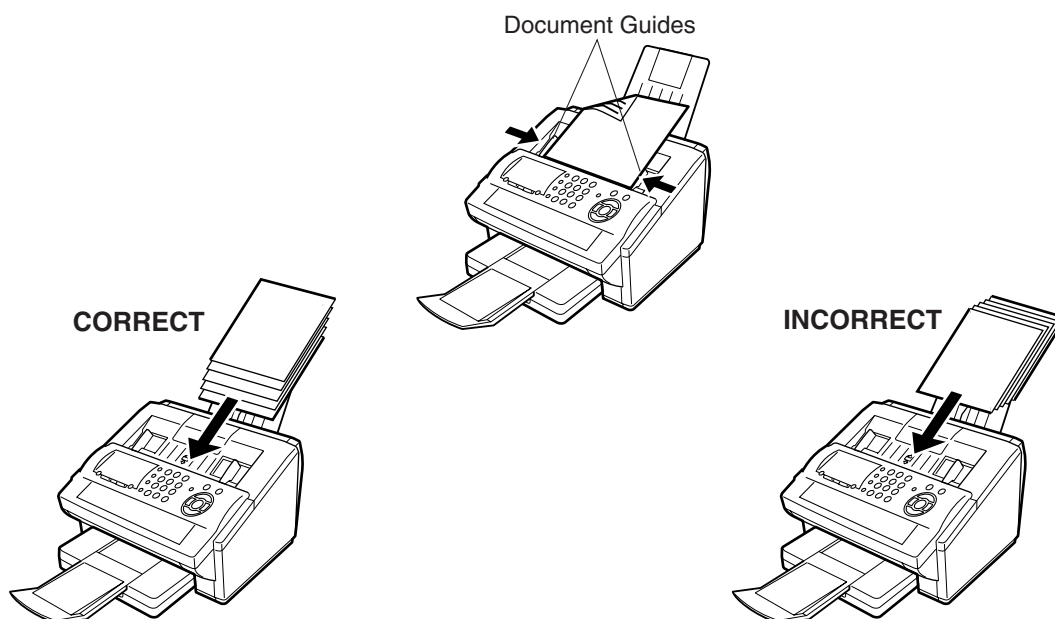

When you set a document on the ADF, the display message will change from date and time (standby) to the following message. You can now change basic transmission settings, or begin the dialling procedure.

ENTER STATION(S)  
THEN PRESS START 00%

### NOTE

1. The multiple page sending limitation is as follows.

	Document Size	Document Thickness
Up to 20 pages	Up to 257mm X 364mm	0.06 mm to 0.12 mm
Up to 30 pages*	A4 size	0.06 mm to 0.10 mm

\* Please note that although the size and thickness meets the specifications, you might not be able to set 30 pages with some types of papers.

- 2 Transmitting documents longer than 356 mm requires user's assistance.
- 3 When transmitting documents longer than A4 size, please extend the sub-tray as shown below.

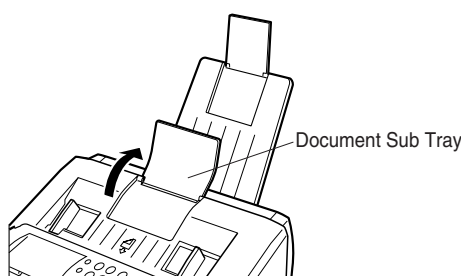

# Basic Transmission Settings

## General Description

You can temporarily change the transmission settings either before or after you place the document on the ADF.

These settings are as follows

- Contrast
- Resolution
- Stamp
- Communication Journal

After your document(s) have been sent, your machine will automatically return to the preset settings.

## Contrast

Your machine is preset to **Normal** contrast. If you wish to send a document with lighter contrast, change the setting to **Lighter**. If you wish to send a document with darker contrast, change the setting to **Darker**.

Press **CONTRAST** to:

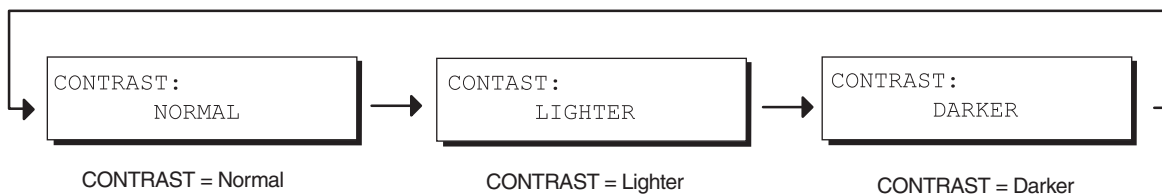

## Resolution

Your machine is preset to **Standard** resolution, which is suitable for most documents.

If you want to send it with more detail, change the setting to **Fine**, **Super Fine** or **Halftone**.

Press **RESOLUTION** to:

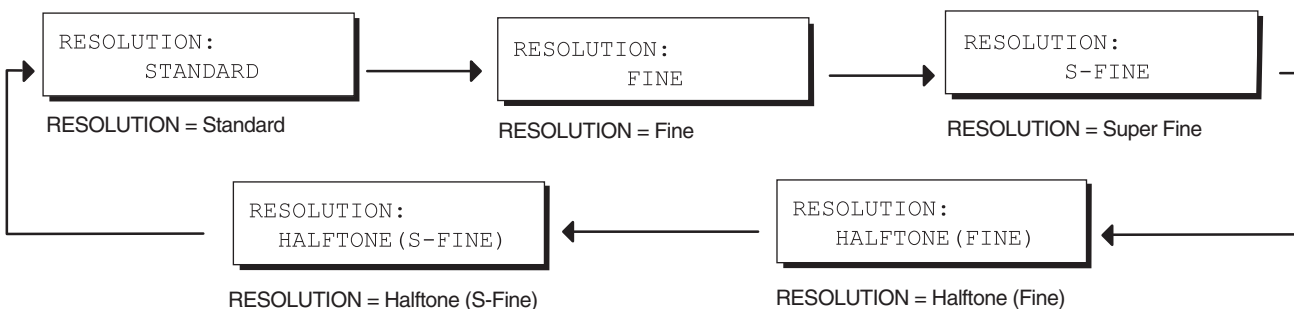

### NOTE

1. To change the preset Contrast position, change the setting of Fax Parameter No. 01. (See page 78)
2. To change the preset Resolution position, change the setting of Fax Parameter No. 02. (See page 78)

# Basic Transmission Settings

## Verification Stamp

The Verification Stamp helps you to confirm successful transmissions by stamping the bottom of each successfully transmitted page with a small ⊗ mark.

Press **STAMP** to:

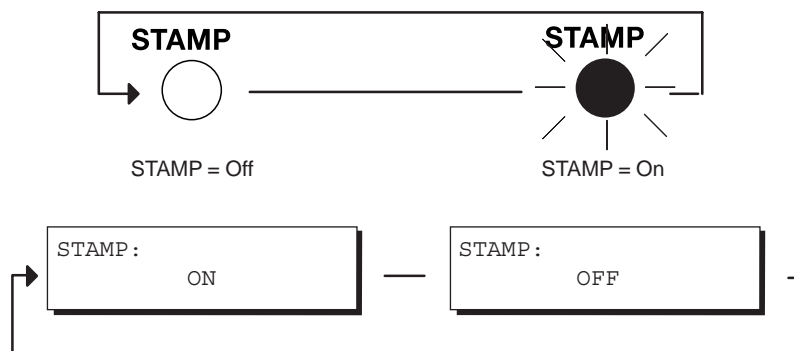

### NOTE

1. When you store a document in memory, the Verification Stamp will stamp on the document if it is successfully stored in memory. In this case the Verification Stamp is not a confirmation that the document was successfully transmitted. If you wish to disable the use of the Verification Stamp when storing document in memory, change the setting of Fax Parameter No. 28. (See page 79)
2. To change the preset Verification Stamp position, change the setting of Fax Parameter No. 04. (See page 78)



## Communication Journal (COMM. JOURNAL)

A Communication Journal lets you verify if the transmission was successful. You can select the condition to print out the Communication Journal as follows.

- When you set COMM. JOURNAL = **OFF** : a Communication Journal does not print.
- When you set COMM. JOURNAL = **ON** : a Communication Journal will print automatically after every communication.
- When you set COMM. JOURNAL = **INC** : a Communication Journal will print automatically only if the communication has failed.

1

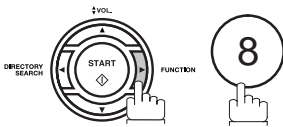

```
SELECT MODE (1-9)
ENTER NO. OR V ^
```

2

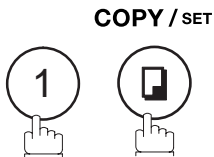

```
COMM. JOURNAL=INC
1:OFF 2:ON 3:INC
```

3



for OFF (Does not print).

or



for "ON" (Always prints).

or



for "INCOMPLETE" (Prints only when communication has failed).

```
COMM. JOURNAL=OFF
1:OFF 2:ON 3:INC
```

or

```
COMM. JOURNAL=ON
1:OFF 2:ON 3:INC
```

or

```
COMM. JOURNAL=INC
1:OFF 2:ON 3:INC
```

4



### NOTE

1. To change the preset Comm. Journal condition, change the setting of Fax Parameter No. 12. (See page 78)

# Sending Documents via LAN

## General Description

Document(s) can be sent via LAN to a single or multiple email addresses. The following Email Addressing methods can be selected:

- Manual Email Addressing
- One-Touch Email Addressing
- Abbreviated Email Addressing
- Directory Search Email Addressing (Auto Dialler & LDAP)
- Multiple Station Email Addressing

The Memory Transmission mode is automatically selected by your machine if an email address is registered into the chosen One-Touch key(s), Program key(s), or Abbreviated Number key(s).

The document is always stored into memory first, then the machine starts to send the email message.

Direct Transmission, Voice Mode Transmission, and Redialling features are not available for sending documents via LAN.

## Manual Email Addressing

**1**



Set document(s) face down.

ENTER STATION(S)  
THEN PRESS START 00%

**2**



To choose Manual Email Addressing mode.

ENTER EMAIL ADDRESS

**3a**

Enter the full email address using the Character keys (up to 60 characters).

abc@panasonic.com

Ex: a b c 21 @ p a n a s o n i c  
P2 . c o m

If you make a mistake, press CLEAR to erase the character then re-enter the correct character.

**3b**

Enter the User portion of the email address and press SET. The machine will complete the email address with the Default Domain preprogrammed in the User (Internet) Parameters. (i.e. will add "panasonic.com" to the email address)

abc

**3c**

If you want to send to a different Domain, enter the first part of an email address, press 21 @ and use the ▼ or ▲ key to display domain names in the Selectable Domains List. Choose the desired domain and press START. (See Note 3 and page 99)

abc@mgcs.com

**4**

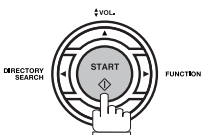

The document(s) is stored into memory with a file number. Then connects to the LAN and starts sending the email message.

\* STORE \* NO.001  
PAGES=001 01%

\* STORE \* COMPLETED  
TOTAL PAGE=005 25%

ON LINE \* MEM.MXT \*  
ID:abc@panasonic.com

**NOTE**

1. If your machine sounds an alarm (pi-pi-pi) in Step 2 above, this indicates that the Dialler is Full (more than 70 full email addresses are entered or 70 transmission reservations including G3 communication have been already reserved).
2. If the transmission cannot be completed for any reason, the email may be returned undelivered; otherwise no reply will be printed.
3. For the machine to perform the email address completion the Fax Parameter No. 160 (DEFAULT DOMAIN) must be set to "Valid" and the DEFAULT DOMAIN must be preprogrammed in the User (Internet) Parameters. (See page 50)

# Sending Documents via LAN

## One-Touch Email Addressing

One-Touch dialling / addressing is a fast way of dialling full telephone numbers or email addresses. To use these dialling or addressing methods, you must first store the telephone numbers or email addresses into One-Touch keys. (See page 69)

1



Set document(s) face down.

```
ENTER STATION(S)  
THEN PRESS START 00%
```

2

Press a One-Touch key (01 - 28).

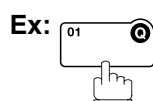

```
<01>(Station name)  
abc@panasonic.com
```

```
<01>(Station name)  
5551234
```

If a telephone number is stored into the One-Touch key, the display shows:

3

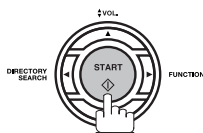

The document(s) is stored into memory with a file number. Then connects to the LAN and starts sending the email message.

```
* STORE * NO.001  
PAGES=001 01%
```

```
* STORE * COMPLETED  
TOTAL PAGE=005 25%
```

```
ON LINE * MEM.MXT *  
ID:(Station name)
```

### NOTE

1. If your machine sounds an alarm (pi-pi-pi) in Step 2 above, this indicates that the Dialler is Full (more than 70 full email addresses are entered or 70 transmission reservations including G3 communication have been already reserved).
2. If the transmission cannot be completed for any reason, the email may be returned undelivered; otherwise no reply will be printed.

## Abbreviated Email Addressing

Abbreviated dialling / addressing is a fast way of dialling full telephone numbers or email addresses. To use these dialling or addressing methods, you must first store the telephone numbers or email addresses into the Auto Dialler with a 3-digit abbreviated code. (See page 71)

**1**



Set document(s) face down.

ENTER STATION(S)  
THEN PRESS START 00%

**2**

Press ABBR and then enter a 3-digit code (001 - 100).

Ex: ABBR

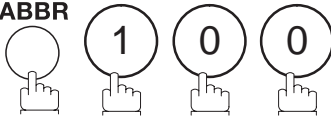

[100] (Station name)  
xyz@panasonic.com

[100] (Station name)  
5553456

If a telephone number is stored into the ABBR station, the display shows:

**3**

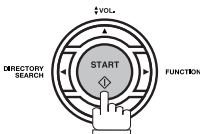

The document(s) is stored into memory with a file number. Then connects to the LAN and starts sending the email message.

\* STORE \* NO.001  
PAGES=001 01%

\* STORE \* COMPLETED  
TOTAL PAGE=005 25%

ON LINE \* MEM.MXT \*  
ID: (Station name)

**NOTE**

1. If your machine sounds an alarm (pi-pi-pi) in Step 2 above, this indicates that the Dialler is Full (more than 70 full email addresses are entered or 70 transmission reservations including G3 communication have been already reserved).
2. If the transmission cannot be completed for any reason, the email may be returned undelivered; otherwise no reply will be printed.

# Sending Documents via LAN

## Directory Search Dialling

When sending via LAN, the Directory Search function allows you to dial a full email address or telephone number by searching for the station name or email address entered in the Auto Dialler and the LDAP (Lightweight Directory Access Protocol) Server. (See Note 3)

1



Set document(s) face down.

ENTER STATION(S)  
THEN PRESS START 00%

2a

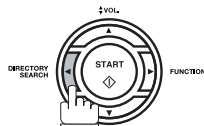

To search for the station name.

ENTER LETTER(S)  
█

or

2b



To search for email address.

ENTER EMAIL ADDRESS  
█

3a

Enter the full station name or part of a station name by using the Character keys. (See page 14)

ENTER LETTER(S)  
PANA█

Ex: **P** **A** **N** **A** to search for **PANASONIC**

If you make a mistake, press **CLEAR** to erase the character then re-enter the correct character.

or

3b

Enter the full or part of an email address using the Character keys.

x  
xyz@panasonic.com

Ex: **x** to search for xyz@panasonic.com

4

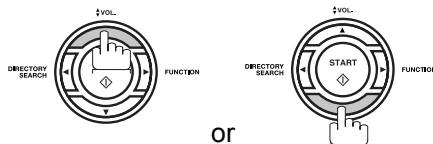

or

repeatedly until the display shows the station name and telephone number / email address you want to send to.

The search priority is the LDAP Server first (retrieves up to 50 stations per search), then it searches the Auto Dialler. (See Note 4)

To refine your search add additional characters to the searched station name / email address.

(01) Panasonic NY002  
NEW\_YORK@panasonic.c

or

x  
xyz@panasonic.com

5

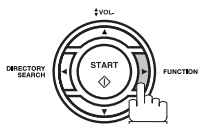

Use the **▶** to change the retrieved station's display format from Station Name & Email Address to Station Name only or to Email Address only.

(01) Panasonic NY002  
New\_York@panasonic.c

(01) Panasonic NY002

(02) New\_York@pasonic

## Directory Search Dialling

# 6

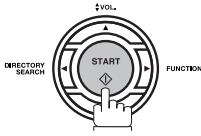

The document(s) is stored into memory with a file number. Then connects to the LAN and starts sending the email message.

```
* STORE *      NO.001
      PAGES=001  01%
```

```
* STORE * COMPLETED
TOTAL PAGE=005  25%
```

```
ON LINE * MEM.MXT *
ID: PANASONIC
```

### NOTE

1. If your machine sounds an alarm (pi-pi-pi) in Step 2 above, this indicates that the Dialler is Full (more than 70 full email addresses are entered or 70 transmission reservations including G3 communication have been already reserved).
2. If the transmission cannot be completed for any reason, the email may be returned undelivered; otherwise no reply will be printed.
3. For some countries, the LDAP Server may not be available because of the country's specification.
4. Some special characters are shown as ■ when searching from the LDAP Server.

# Sending Documents via LAN

## Multi-Station Transmission (Broadcasting)

You can store the document(s) into memory and then send to multiple stations (up to 202 addresses) via LAN.

1



Set document(s) face down.

```
ENTER STATION(S)  
THEN PRESS START 00%
```

2

Enter the email addresses by any combination of the following methods:

- One-Touch Dialling
- Abbreviated Dialling
- Directory Search Dialling, press **SET** after each email address is entered.
- Manual Number Dialling, press **SET** after each station is entered (up to 70 addresses).

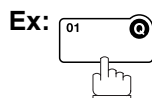

```
<01>(Station name)  
abc@panasonic.com
```

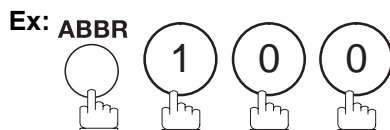

```
[100](Station name)  
xyz@panasonic.com
```

```
2 STN(S) ARE SET  
ADD MORE OR START
```

If you want to confirm the number of stations you have entered, press **SET**.

3

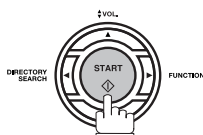

The document(s) is stored into memory with a file number. Then connects to the LAN and starts sending the email message.

```
* STORE * NO.001  
PAGES=001 01%
```

```
* STORE * COMPLETED  
TOTAL PAGE=005 25%
```

```
ON LINE * MEM.MXT *  
ID:abc@panasonic.com
```

### NOTE

1. If your machine sounds an alarm (pi-pi-pi) in Step 2 above, this indicates that the Dialler is Full (more than 70 full email addresses are entered or 70 transmission reservations including G3 communication have been already reserved).
2. If the transmission cannot be completed for any reason, the email may be returned undelivered; otherwise no reply will be printed.
3. The unit will accept a combination of email addresses and PSTN dialling numbers.
4. Generally, LAN transmission to multiple destinations will be completed in a single transmission to the SMTP server. However, when the "DELIVERY NOTICE=ON" or when using the DIRECT IFAX XMT modes, separate transmission is required for each destination.



## Memory Transmission Reservation (Multi-tasking)

If your machine is on-line busy transmitting from memory, receiving or printing received documents, you can reserve a transmission by the following procedure.

- 1** Your machine is on-line, the ON LINE lamp is blinking or printing received documents.

ON LINE * PC MODE *	ON LINE * MEM.XMT * ID:(Identification)
ON LINE * PRT MODE *	ON LINE * RCV * ID:(Identification)
* PRINTING * PC DATA	* PRINTING * MEMORY RCV'D DOC

- 2**  Set document(s) face down.

ENTER STATION(S)  
THEN PRESS START 00%

- 3** Dial by any combination of the following methods:
- One-Touch Dialling
  - Abbreviated Dialling
  - Manual Number Dialling, press SET after each station is entered (Up to 70 stations)
  - Directory Search Dialling, press SET after each station is entered (For details, see page 91 to 95)

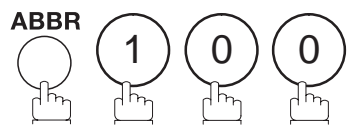
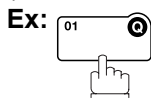

- If you want to confirm the number of stations you have entered, press SET.

<01>(Station name)  
abc@panasonic.com

[100](Station name)  
xyz@panasonic.com

2 STN(S) ARE SET  
ADD MORE OR START

- 4** COPY / SET 

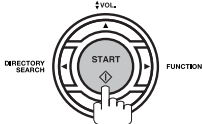
- 5** 

Your machine will store the document(s) into memory.

\* STORE \* NO.005  
PAGES=001 01%

\* STORE \* COMPLETED  
TOTAL PAGE=005 25%

**NOTE**

1. To cancel the memory transmission reservation, see page 164.

# Sending Documents via LAN

## Automatic Redialling

If the Network connection is not available or the destination device (IFax) is busy, the machine will retry connecting up to 3 times at 3 minutes interval. During that time, a message will appear as shown to the right.

WAIT TO DIAL NO.001  
(Email address)

A file number is shown in the upper right hand corner of the display if it is a memory transmission file.

## Manual Redialling

You can also retry connecting manually by pressing **REDIAL** key.

1



Set document(s) face down.

ENTER STATION(S)  
THEN PRESS START 00%

2

REDIAL /  
PAUSE



abc@panasonic.com

3

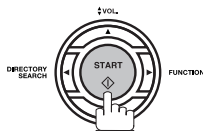

The document is stored into memory with a file number. Then the machine redials and sends to the last dialled email address.

\* STORE \* NO.002  
PAGES=001 01%

### NOTE

1. While the unit is displaying "WAIT TO DIAL", you can press **REDIAL** to initiate the Network connection immediately.

## Selectable Domains

Using the Selectable Domains feature speeds the process of completing the email address by attaching often used Domain Names.

- Advance registration of up to 10 often used, domain names into the "Selectable Domains" list is required. (See page 50)

**Ex:** To send an email to the Sales Department of Panasonic "sales@panasonic.com" using the "panasonic.com" domain that has been pre-registered in the Selectable Domains list, follow the steps below:

1



Set document(s) face down.

ENTER STATION(S)  
THEN PRESS START 00%

2



To choose Manual Email Addressing mode.

ENTER EMAIL ADDRESS

3

Enter the User portion of the email address using the Character keys.

sales@

**Ex:** s a l e s  @

(Note: The "@" symbol indicates to the machine that a Domain Name will follow)

4

▼ or ▲ key repeatedly until the desired Selectable Domain Name is displayed on the LCD.

panasonic.com

**Ex:** panasonic.com

5

Press  to add the displayed Domain Name to the User portion of the email address.

(If you make a mistake selecting the Domain Name, simply press the ▼ or ▲ key followed by  to replace the selected Domain Name)

sales@panasonic.com

*Continued on the next page...*

## Sending Documents via LAN

### Selectable Domains

6

Press  to specify other destinations.

1 STN(S) ARE SET  
ADD MORE OR START

or

7

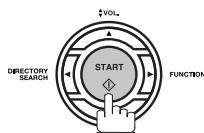

The document(s) is stored into memory with a file number.  
(See Note 2)  
Then connects to the LAN and starts sending the email message.

#### NOTE

1. If the desired Domain Name is not found, press  to exit the Selectable Domains List.
2. If the Fax Parameter No. 145 (SENDER SELECTION) setting is on "Valid", the Sender Selection screen appears after pressing  in step 7 above. Select the sender to be added to the "From:" field on the email and press  to start storing the document(s). The factory default setting for this parameter is on "Invalid".

# Sending Documents via LAN

## Internet Fax Delivery Notice (MDN)

You can request a Message Disposition Notification (MDN) to the receiving side. If the receiving side supports the MDN feature, a delivery processing confirmation reply indicating that the message (email) was read is sent to the originator.

The result field in your machine's Journal will indicate "OK" if the Delivery Notice is returned.

1



Set document(s) face down.

ENTER STATION(S)  
THEN PRESS START 00%

2

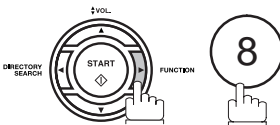

SELECT MODE (1-9)  
ENTER NO. OR ∨ ^

3

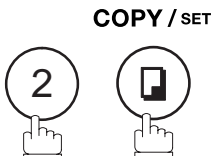

DELIVERY NOTICE=OFF  
1:OFF 2:ON

4

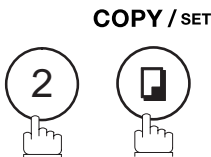

ENTER STATION(S)  
THEN PRESS START 00%

5

Dial by any combination of the following methods:

- One-Touch Dialling
- Abbreviated Dialling
- Directory Search Dialling, press  after each email address is entered.
- Manual Number Dialling, press  after each station is entered (up to 70 addresses).

<01>(Station name)  
panasonic.usa@panas

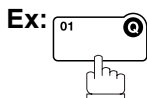

### NOTE

1. If you transmit to separate stations with Delivery Notice request, your machine will connect to the LAN for each station and request a Delivery Notice from each station.
2. To change the preset Delivery Notice condition, change the setting of Fax Parameter No.173.

# Sending Documents via LAN

## Returned Email

When using the Internet communication mode, a failure report will print automatically for each transaction if the email is returned undelivered by the mail server. The printout will consist of the undelivered message contents supplied by the mail server and a portion of the first page's image for that particular transaction.

### Failure Report Sample (User unknown)

```
Received: from localhost (localhost) by ifeif1.rdmg.mgcs.mei.co.jp (8.6.12/3.4W3) with
internal id OAA24381; Sun, dd Mmm yyyy 14:52:57 +0900
Date: Sun, dd Mmm yyyy 14:52:57 +0900
From: Mail Delivery Subsystem <MAILER-DAEMON@ifeif1.rdmg.mgcs.mei.co.jp>
Subject: Returned mail: User unknown
Message-Id: <200011120552.OAA24381@ifeif1.rdmg.mgcs.mei.co.jp>
To: <fax@nwpc31.rdmg.mgcs.mei.co.jp>

The original message was received at Sun, dd Mmm yyyy 14:52:54 +0900
from nwpc31.rdmg.mgcs.mei.co.jp [172.21.22.51]

----- The following addresses had delivery problems -----
<error@nwr39.rdmg.mgcs.mei.co.jp> (unrecoverable error)

----- Transcript of session follows -----
... while talking to nwr39.rdmg.mgcs.mei.co.jp.:
>>> RCPT To:<error@nwr39.rdmg.mgcs.mei.co.jp>
<<< 550 <error@nwr39.rdmg.mgcs.mei.co.jp>... User unknown
550 <error@nwr39.rdmg.mgcs.mei.co.jp>... User unknown

----- Original message follows -----
Return-Path: fax@nwpc31.rdmg.mgcs.mei.co.jp
Received: from nwpc31.rdmg.mgcs.mei.co.jp (Internet FAX) (nwpc31.rdmg.mgcs.mei.co.jp [172.21
.22.51]) by ifeif1.rdmg.mgcs.mei.co.jp (8.6.12/3.4W3) with SMTP id OAA24380 for <error@nwr39
.rdmg.mgcs.mei.co.jp>; Sun, dd Mmm yyyy 14:52:54 +0900
Message-Id: <200011120552.OAA24380@ifeif1.rdmg.mgcs.mei.co.jp>
Mime-Version: 1.0
Content-Type: image/tiff
Content-Transfer-Encoding: base64
Content-Disposition: attachment; filename="image.tif"
Content-Description: image.tif
X-Mailer: Internet FAX, MGCS
Date: Sun, dd Mmm yyyy 14:49:00 +0900
From: "DP-2000" <fax@nwpc31.rdmg.mgcs.mei.co.jp>
Subject: IMAGE from Internet FAX
To: error@nwr39.rdmg.mgcs.mei.co.jp
```

dd Mmm yyyy 14:49

5  
DX/800

P.01/01

### THE SLEREXE COMPANY LIMITED

SAPORS LANE . BOOLE . DORSET . BH 25 8 ER  
TELEPHONE BOOLE (945 13) 51617 - TELEX 123456

Our Ref. 350/PJC/EAC

dd Mmm yyyy

Dr. P.N. Cundall,  
Mining Surveys Ltd.,  
Holroyd Road  
Reading,  
Berks.

Dear Pete,

Permit me to introduce you to the facility of facsimile  
transmission.

In facsimile a photocell is caused to perform a raster scan over  
the subject copy. The variations of print density on the document cause

### Using a Mailing List

Using a Mailing List stored in the mail server simplifies the process of entering multiple locations and allows you to send to an unlimited number of email addresses with one easy operation.

Ask your Network System administrator for information on how to utilize the Mailing List.

# Sending Documents via Telephone Line

## General Description

You can choose either Memory or Direct Transmission.

Use Memory Transmission if:

- You want to send the document to multiple stations.
- You have to retrieve the document immediately.
- You want to take advantage of Dual Operation design.

Use Direct Transmission if:

- The memory is full.
- You want to send the document immediately.

Use Voice Mode Transmit if:

- You want to send the document after talking with the other party.
- You want to send the document after listening to a voice prompting.



# Sending Documents via Telephone Line

## Memory Transmission

Your machine quickly stores the document into the machine's memory.

Then, starts to dial the telephone number.

If the transmission fails, your machine will re-transmit the remaining unsuccessful page(s) automatically.

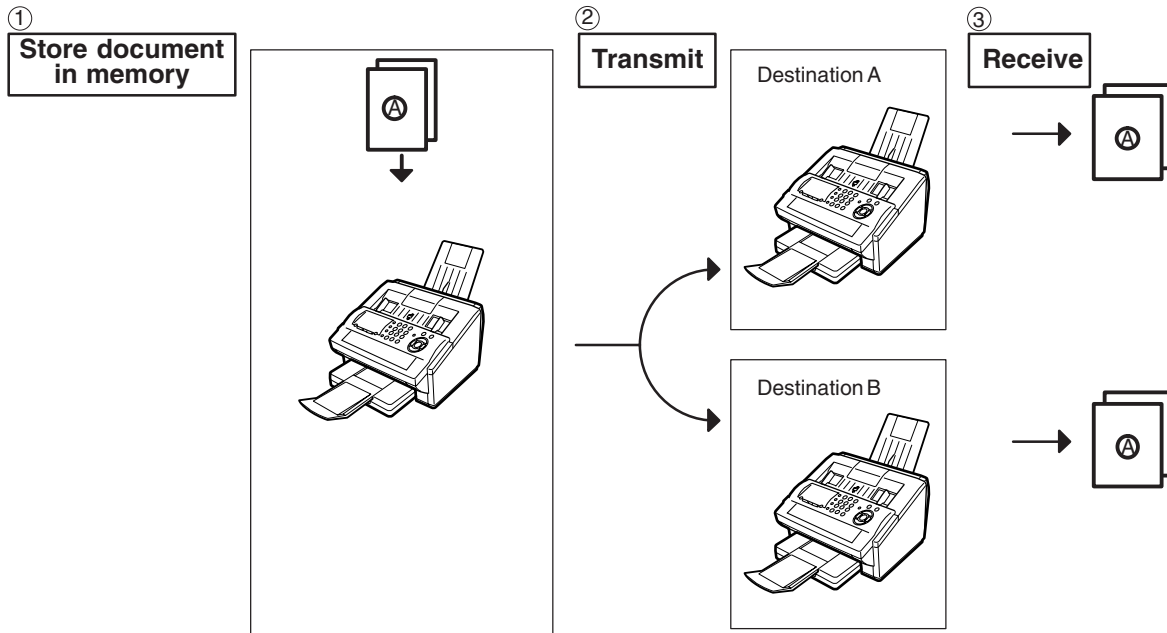

### NOTE

1. The File Number of the document being stored is shown at the upper right corner of the display while storing the document. It is also printed on the Communication Journal (COMM. JOURNAL), Transaction Journal and File List. The percentage of memory used is shown on the lower right corner of the display after each page is stored.

```
* STORE *      NO.003
      PAGES=002  10%
```

```
* STORE * COMPLETED
TOTAL PAGES=005  30%
```

2. If memory overflow occurs while storing documents, the remaining documents on the ADF will be ejected. The machine prompts you whether to transmit the successfully stored documents or to cancel the transmission. Press ① to cancel or press ② to transmit.

```
MEMORY OVERFLOW
INFO. CODE=870
```

See the Specifications on page 239 for the image memory capacity.

If no action is taken within 10 seconds, the machine will start transmitting the stored documents.

```
15 PAGES COMPLETED
DELETE? 1:YES 2:NO
```

3. An Information Code will be displayed if the transmission has failed or no answer at the receiving side after the last automatic redial.

The document stored for this transmission will be erased from the memory automatically and the information code is printed for the transmission on the Communication Journal (COMM. JOURNAL).

If you need to retain the incomplete documents even after the last redial, change Fax Parameter No. 31 (INC. FILE SAVE) to "Valid" in advance. (See page 80) To retry the incomplete documents, refer to page 167.

```
INCOMPLETE
INFO. CODE=XXX
```

# Sending Documents via Telephone Line

## Memory Transmission

4. To stop the transmission, press **STOP**.

The display shows:

```
COMMUNICATION STOP ?  
1: YES 2: NO
```

Press **1** to stop the transmission. The document you stored will be erased automatically. If you do not want to erase the documents, change the setting of Fax Parameter No. 31 (INC. FILE SAVE) to "Valid" in advance. (See page 80)  
Then the following display will appear and you can select whether to save the file as an incomplete file for editing and retry, or delete the file manually.

```
SAVE AS INCOMP. FILE ?  
1: YES 2: NO
```

5. If you would like to print a Communication Journal (COMM. JOURNAL) after stopping a transmission, press **1** when the display shows:

```
PRINT COMM. JOURNAL ?  
1: YES 2: NO
```

6. If the file memory capacity reaches 70 files and you try to store another file, the following display appears and the machine will not accept additional files until a file is completed and becomes available.

```
FILE STORAGE IS FULL  
PLEASE WAIT!
```

# Sending Documents via Telephone Line

## Memory Transmission

### Manual Number Dialling

To dial the telephone number manually, follow the steps below.

1



Set document(s) face down.

```
ENTER STATION(S)
THEN PRESS START 00%
```

2

Enter a telephone number from the keypad.  
(Up to 36 digits)  
You can also designate more than one destination.

```
TEL. NO.
5551234
```

Ex: (5) (5) (5) (1) (2) (3) (4)

3

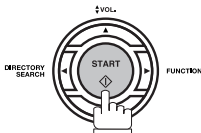

The document is stored into memory with a file number.  
Then starts dialling the telephone number immediately  
after storing the first page. (See Note 3)  
The remaining page(s) continue to store into memory.

```
* STORE *      NO.002
      PAGES=001  05%
```

```
* DIALLING *   NO.00
5551234
```

### NOTE

1. If you need a special access number to get an outside line, dial it first then press **PAUSE** to enter a pause (represented by a "-") before dialling the full number.  
**Ex: 9 PAUSE 5551234**
2. If you are using Pulse dialling and you wish to change to Tone dialling in the middle of dialling, press **\*** (represented by a "/").  
The dialling mode will be changed from Pulse to Tone after dialling the digit "/".  
**Ex: 9 PAUSE \* 5551234**
3. This feature is called "Quick Memory Transmission". If you wish to store all the document(s) into memory first before transmitting, change the Fax Parameter No. 82 (QUICK MEMORY XMT) to "Invalid". (See page 81)

# Sending Documents via Telephone Line

## Memory Transmission

### One-Touch Dialling

One-Touch Dialling allows you to dial a full telephone number by pressing a single key. To set up the One-Touch keys, see page 69.

1



Set document(s) face down.

```
ENTER STATION(S)  
THEN PRESS START 00%
```

2

Press a One-Touch key.

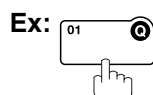

```
<01> (Station name)  
5551234
```

3

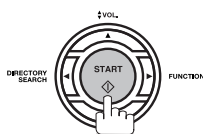

The document is stored into memory with a file number.  
Then starts dialling the telephone number immediately  
after storing the first page. (See Note 1)  
The remaining page(s) continue to store into memory.

```
* STORE * NO.002  
PAGES=001 05%
```

```
* DIALLING * NO.00  
(Station name)
```

### Abbreviated Dialling

Abbreviated dialling is a speedy way to dial a frequently dialled telephone number by preprogramming the telephone number into the built-in auto-dialler with a 3-digit abbreviated code. To program an abbreviated dialling number, see page 71.

1



Set document(s) face down.

```
ENTER STATION(S)  
THEN PRESS START 00%
```

2

Press **ABBR** then enter a 3-digit code.

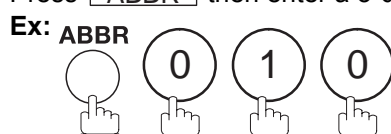

```
[010] (Station name)  
5553456
```

3

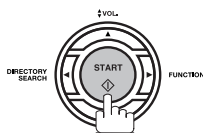

The document is stored into memory with a file number.  
Then starts dialling the telephone number immediately  
after storing the first page. (See Note 1)  
The remaining page(s) continue to store into memory.

```
* STORE * NO.002  
PAGES=001 05%
```

```
* DIALLING * NO.00  
(Station name)
```

#### NOTE

1. This feature is called "**Quick Memory Transmission**". If you wish to store all the document(s) into memory first before transmitting, change the Fax Parameter No. 82 (QUICK MEMORY XMT) to "Invalid". (See page 81)

# Sending Documents via Telephone Line

## Memory Transmission

### Directory Search Dialling

Directory Search dialling allows you to dial a full telephone number by searching the station name entered in One-Touch keys or Abbreviated dialling numbers.

1



Set document(s) face down.

ENTER STATION(S)  
THEN PRESS START 00%

2

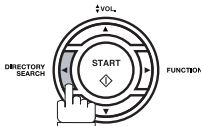

ENTER LETTER(S)  
█

3

Enter the full station name or part of a station name by using the Character keys. (See page 14)

Ex: **P** **A** **N** **A** for searching **PANASONIC**

ENTER LETTER(S)  
PANA█

4

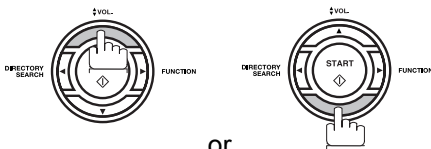

or

repeatedly until the display shows the station name you want to send to.

(01) PANASONIC  
5553456

5

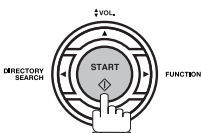

The document is stored into memory with a file number. Then starts dialling the telephone number immediately after storing the first page. (See Note 1)  
The remaining page(s) continue to store into memory.

\* STORE \* NO.002  
PAGES=001 05%

\* DIALLING \* NO.00  
PANASONIC

#### NOTE

1. This feature is called "**Quick Memory Transmission**". If you wish to store all the document(s) into memory first before transmitting, change the Fax Parameter No. 82 (QUICK MEMORY XMT) to "Invalid". (See page 81)

# Sending Documents via Telephone Line

## Memory Transmission

### Multi-Station Transmission (Broadcasting)

If you have to send the same document(s) to multiple stations, you can save time in feeding the document(s) by using memory transmission. That is, you can store the document(s) into memory and then send it to the station(s) automatically.

1



Set document(s) face down.

ENTER STATION(S)  
THEN PRESS START 00%

2

Dial by any combination of the following methods:

- One-Touch Dialling
- Abbreviated Dialling
- Manual Number Dialling, press **SET** after each station is entered (Up to 70 stations)
- Directory Search Dialling, press **SET** after each station is entered (For details, see page 107 to 109.)

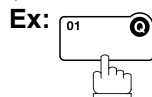

ABBR

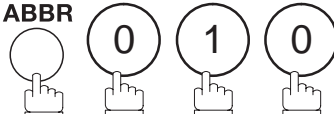

- If you want to confirm the number of stations you have entered, press **SET**.

<01> (Station name)  
5551234

[010] (Station name)  
5553456

2 STN(S) ARE SET  
ADD MORE OR START

3

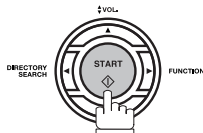

The document is stored into memory with a file number. Then starts dialling the telephone numbers in sequence.

\* STORE \* NO.001  
PAGES=001 01%

\* STORE \* COMPLETED  
TOTAL PAGE=005 25%

\* DIALLING \* NO.00  
(Station name)

#### NOTE

1. You can review the stations you entered in step 3 before storing your document into memory by pressing **▼** or **▲**. Press **CLEAR** to clear an entered station or group shown on the display if needed.
2. The "Quick Memory Transmission" is disabled if multiple stations are set.

# Sending Documents via Telephone Line

## Direct Transmission

If your machine's memory is full or you wish to send the document immediately, use Direct Transmission.

### Manual Number Dialling (Direct Transmission)

To dial the telephone number manually, follow the steps below.

1



Set document(s) face down.

```
ENTER STATION(S)  
THEN PRESS START 00%
```

2

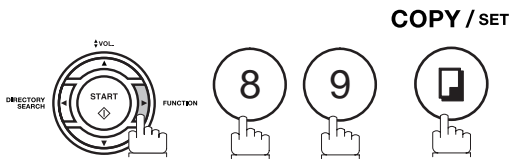

```
MEMORY XMT=ON  
1:OFF 2:ON
```

3

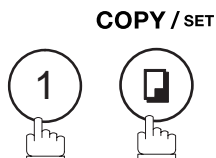

```
ENTER STATION  
00%
```

4

Enter a telephone number from the keypad.

Ex: ⑤ ⑤ ⑤ ① ② ③ ④

```
PRESS START TO DIAL  
5551234■
```

5

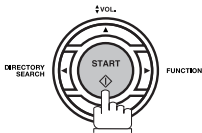

Your machine starts to dial the telephone number.

```
* DIALLING *  
5551234
```

### NOTE

1. If you need a special access number to get an outside line, dial it first then press **PAUSE** to enter a pause (represented by a "-") before dialling the full number.  
**Ex: 9 PAUSE 5551234**
2. If you are using Pulse dialling and you wish to change to Tone dialling in the middle of dialling, press **\*** (represented by a "/").  
The dialling mode will be changed from Pulse to Tone after dialling the digit "/".  
**Ex: 9 PAUSE \* 5551234**
3. To stop the transmission, press **STOP**.  
The display shows:

```
COMMUNICATION STOP ?  
1:YES 2:NO
```



Press **1** to stop the transmission. The Communication Journal will not print out regardless of the printout mode setting of the Communication Journal.

# Sending Documents via Telephone Line

## Direct Transmission

### One-Touch Dialling (Direct Transmission)

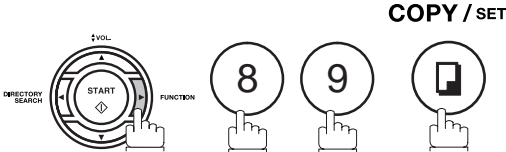
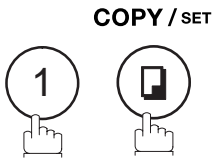
One-Touch Dialling allows you to dial a full telephone number by pressing a single key. To set up the One-Touch keys, see page 69.

<b>1</b>	 Set document(s) face down.	<div style="border: 1px solid black; padding: 2px; width: fit-content;">ENTER STATION(S) THEN PRESS START 00%</div>
<b>2</b>	 COPY / SET	<div style="border: 1px solid black; padding: 2px; width: fit-content;">MEMORY XMT=ON 1:OFF 2:ON</div>
<b>3</b>	 COPY / SET	<div style="border: 1px solid black; padding: 2px; width: fit-content;">ENTER STATION 00%</div>
<b>4</b>	Press a One-Touch key. <b>Ex:</b> 	<div style="border: 1px solid black; padding: 2px; width: fit-content;">&lt;01&gt;(Station name) 5551234</div>
	The display will show the One-Touch number and station name. The full number (e.g. 5551234) will then be dialled.	<div style="border: 1px solid black; padding: 2px; width: fit-content;">* DIALLING * (Station name)</div>



# Sending Documents via Telephone Line

## Direct Transmission

### Abbreviated Dialling (Direct Transmission)

Abbreviated dialling is a speedy way to dial a frequently dialled telephone number by preprogramming the telephone number into the built-in auto-dialler with a 3-digit abbreviated code. To program an abbreviated dialling number, see page 71.

1



Set document(s) face down.

```
ENTER STATION(S)  
THEN PRESS START 00%
```

2

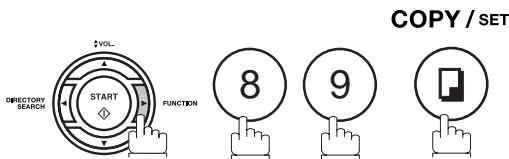

```
MEMORY XMT=ON  
1:OFF 2:ON
```

3

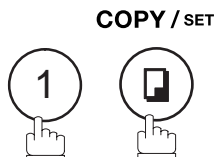

```
ENTER STATION  
00%
```

4

Press **ABBR** and a 3-digit code.

Ex: **ABBR**

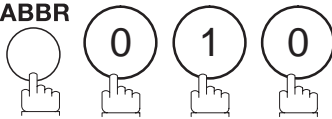

The display will show the ABBR number and station name.

The full number (e.g. 5553456) will then be dialled.

```
[010] (Station name)  
5553456
```

```
* DIALLING *  
(Station name)
```

# Sending Documents via Telephone Line

## Direct Transmission

### Directory Search Dialling (Direct Transmission)

Directory Search dialling allows you to dial a full telephone number by searching the station name entered in One-Touch keys or Abbreviated dialling numbers.

1



Set document(s) face down.

ENTER STATION(S)  
THEN PRESS START 00%

2

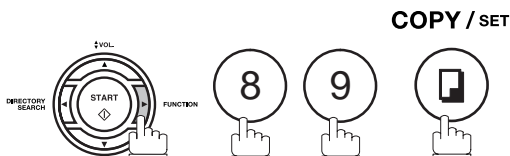

MEMORY XMT=ON  
1:OFF 2:ON

3

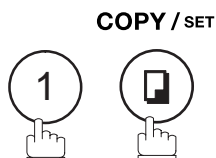

ENTER STATION  
00%

4

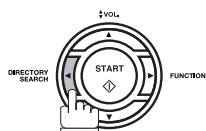

ENTER LETTER(S)  
█

5

Enter the full station name or part of a station name by using the Character keys. (See page 14)

Ex: **P** **A** **N** **A** for searching **PANASONIC**

ENTER LETTER(S)  
PANA█

6

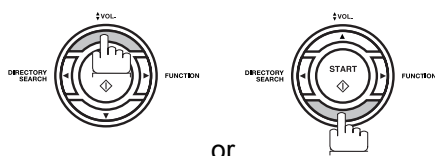

repeatedly until the display shows the station name you want to send to.

(01) PANASONIC  
5553456

7

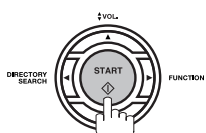

The full number (e.g. 5553456) will be dialled.

\* DIALLING \*  
PANASONIC

# Sending Documents via Telephone Line

## Voice Mode Transmission

If you wish to send the document after talking with other party, use Voice Mode Transmission. Your machine requires an optional fax handset or an external telephone.

### Off-Hook Dialling

For Off-Hook Dialling, follow the steps below.

1



Set document(s) face down.

```
ENTER STATION(S)
THEN PRESS START 00%
```

2

Lift the fax handset or the external telephone and dial the telephone number from the keypad.

Ex: ⑤ ⑤ ⑤ ① ② ③ ④

```
* PHONE OFF HOOK *
```

```
* DIALLING *
5551234█
```

3

When you hear the voice of the other party, tell the other party to prepare to receive a document.

```
ON LINE * XMT *
```

Then, when you hear a beep,

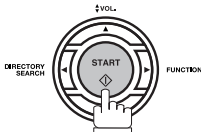

and hang up the handset.

### NOTE

- To stop the transmission, press **STOP**.  
The display shows:

```
COMMUNICATION STOP ?
1: YES 2: NO
```

Press ① to stop the transmission. The Communication Journal will not print out regardless of the printout mode setting of the Communication Journal.

# Sending Documents via Telephone Line

## Voice Mode Transmission

### On-Hook Dialling

For On-Hook Dialling, follow the steps below.

1



Set document(s) face down.

ENTER STATION(S)  
THEN PRESS START 00%

2

MONITOR



You will hear dial tone through the monitor speaker.

\* MONITOR \*

3

Dial the telephone number from the keypad.

Ex: (5) (5) (5) (1) (2) (3) (4)

\* DIALLING \*  
5551234 ■

4

When you hear a beep,

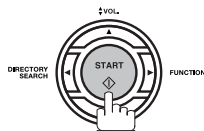

ON LINE \* XMT \*

#### NOTE

1. If you need a special access number to get an outside line, dial it first then press **PAUSE** to enter a pause (represented by a "-") before dialling the full number.  
**Ex: 9 PAUSE 5551234**
2. If you are using Pulse dialling and you wish to change to Tone dialling in the middle of dialling, press **\*** (represented by a "/").  
The dialling mode will be changed from Pulse to Tone after dialling the digit "/".  
**Ex: 9 PAUSE \* 5551234**

# Sending Documents via Telephone Line

## Transmission Reservation

You can do the following while sending a document from memory or receiving a document.

- Reserve the next transmission into memory. (Up to 70 different files)
- Reserve a priority transmission.

### Memory Transmission Reservation (Multi-tasking)

If your machine is on-line busy transmitting from memory, receiving or printing received documents, you can reserve a transmission by the following procedure.

**1** Your machine is on-line, the ON LINE lamp is blinking or printing received documents.

ON LINE * PC MODE *	ON LINE * MEM.XMT * ID: (Identification)
ON LINE * PRT MODE *	ON LINE * RCV * ID: (Identification)
* PRINTING * PC DATA	* PRINTING * MEMORY RCV'D DOC

**2**



Set document(s) face down.

ENTER STATION(S)  
THEN PRESS START 00%

**3**

Dial by any combination of the following methods:

- One-Touch Dialling
- Abbreviated Dialling
- Manual Number Dialling, press SET after each station is entered (Up to 70 stations)
- Directory Search Dialling, press SET after each station is entered (For details, see page 107 to 109.)

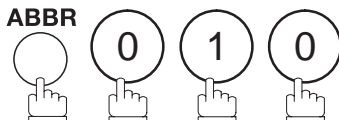
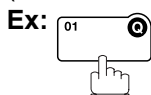

- If you want to confirm the number of stations you have entered, press SET.

<01>(Station name)  
5551234

[010](Station name)  
5553456

**4**

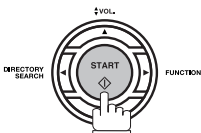

Your machine will store the document(s) into memory.

\* STORE \* NO.005  
PAGES=001 01%

\* STORE \* COMPLETED  
TOTAL PAGE=005 25%

**NOTE**

1. To cancel the memory transmission reservation, see page 164.

# Sending Documents via Telephone Line

## Transmission Reservation

### Direct Transmission Reservation (Priority Transmission Reservation)

If you are in a rush to send an urgent document, however there are many files in the memory, use Direct Transmission Reservation to send the urgent document. The urgent document will be sent immediately after the current communication is finished.

Note that you cannot send documents to multiple stations.

#### To reserve your machine for sending the urgent documents

**1** Your machine is on-line, the ON LINE lamp is blinking or printing received documents.

```
ON LINE * PC MODE *
```

```
ON LINE * MEM.XMT *  
ID:(Identification)
```

```
ON LINE * PRT MODE *
```

```
ON LINE * RCV *  
ID:(Identification)
```

```
* PRINTING *  
PC DATA
```

```
* PRINTING *  
MEMORY RCV'D DOC
```

**2**



Set document(s) face down.

```
ENTER STATION(S)  
THEN PRESS START 00%
```

**3**

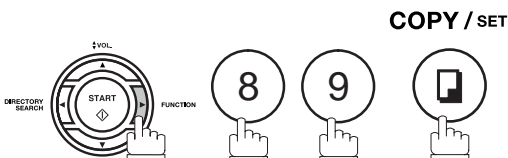

```
MEMORY XMT=ON  
1:OFF 2:ON
```

**4**

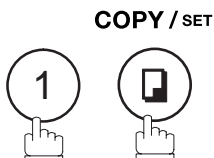

```
ENTER STATION 00%
```

**5**

Dial by using any one of the following methods:

- One-Touch Dialling
- Abbreviated Dialling
- Manual Number Dialling and press **START**
- Directory Search Dialling and press **START**  
(For details, see pages 111 to 114.)

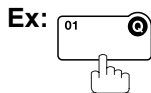

```
<01>(Station name)  
5551234
```

You can reserve sending an urgent document to a single station only.

A message "DIRECT XMT RESERVED" will be shown on the display.

# Sending Documents via Telephone Line

## Transmission Reservation

To cancel the direct transmission reservation

**1** Make sure the document is on the ADF.

```
DIRECT XMT RESERVED  
<01>(Station name)
```

**2** **STOP**  

```
CANCEL XMT RESERVE ?  
1:YES 2:NO
```

**3**  and then remove the document from ADF.

# Sending Documents via Telephone Line

## Redialling

### Automatic Redialling

If a busy line is detected, the machine will redial the number up to 3 times at 3 minutes interval. During that time, a message will appear as shown to the right.

```
WAIT TO DIAL NO.001  
<01>(Station name)
```

A file number is shown in the upper right hand corner of the display if it is a memory transmission file.

### Manual Redialling

You can also redial the last dialled number manually by pressing **REDIAL** key.

#### To redial the last dialled number through memory

1



Set document(s) face down.

```
ENTER STATION(S)  
THEN PRESS START 00%
```

2



```
TEL. NO.  
5551234
```

3

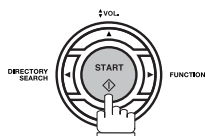

The document is stored into memory with a file number. Then dials the last dialled number.

```
* STORE * NO.002  
PAGES=001 01%
```

```
* DIALLING * NO.002  
5551234
```



# Sending Documents via Telephone Line

## Redialling

To redial the last dialled number through ADF

1



Set document(s) face down.

ENTER STATION(S)  
THEN PRESS START 00%

2

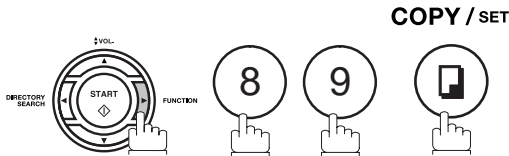

MEMORY XMT=ON  
1:OFF 2:ON

3

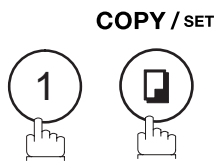

ENTER STATION  
00%

4

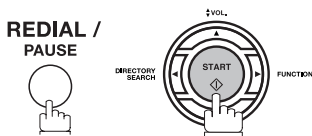

Your machine starts to dial the last dialled number.

PRESS START TO DIAL  
5551234

\* DIALLING \*  
5551234

### NOTE

1. While the unit is displaying "WAIT TO DIAL", you can press **REDIAL** to start redialling immediately.

# Receiving Documents via LAN

## General Description

Your machine offers you a choice to receive Fax documents unattended (by default) or manually over regular telephone lines.

Your machine also offers the same choice to receive and print Internet email messages via LAN unattended or manually when subscribing to a POP mail server. However, when your machine is configured to receive email using SMTP protocol, the email can only be received and printed unattended.

## Internet Fax Received on a PC

Figure 1: Outlook Express Inbox Sample

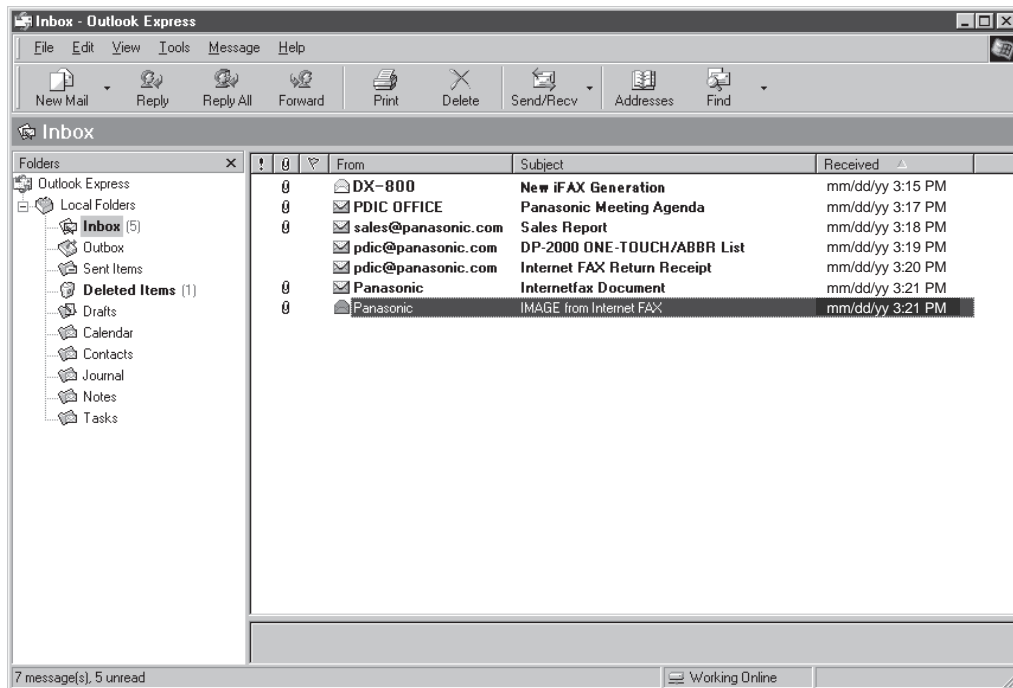

- The "Subject" column in the above example shows samples of email messages received on a PC from your machine, and Internet FAX.
- For your reference, the above example is from Outlook Express Inbox running under Microsoft® Windows 95®. If you are using a different email application software, please refer to your application's User Manual.

## General Description

Figure 2: Internet Fax Received on a PC

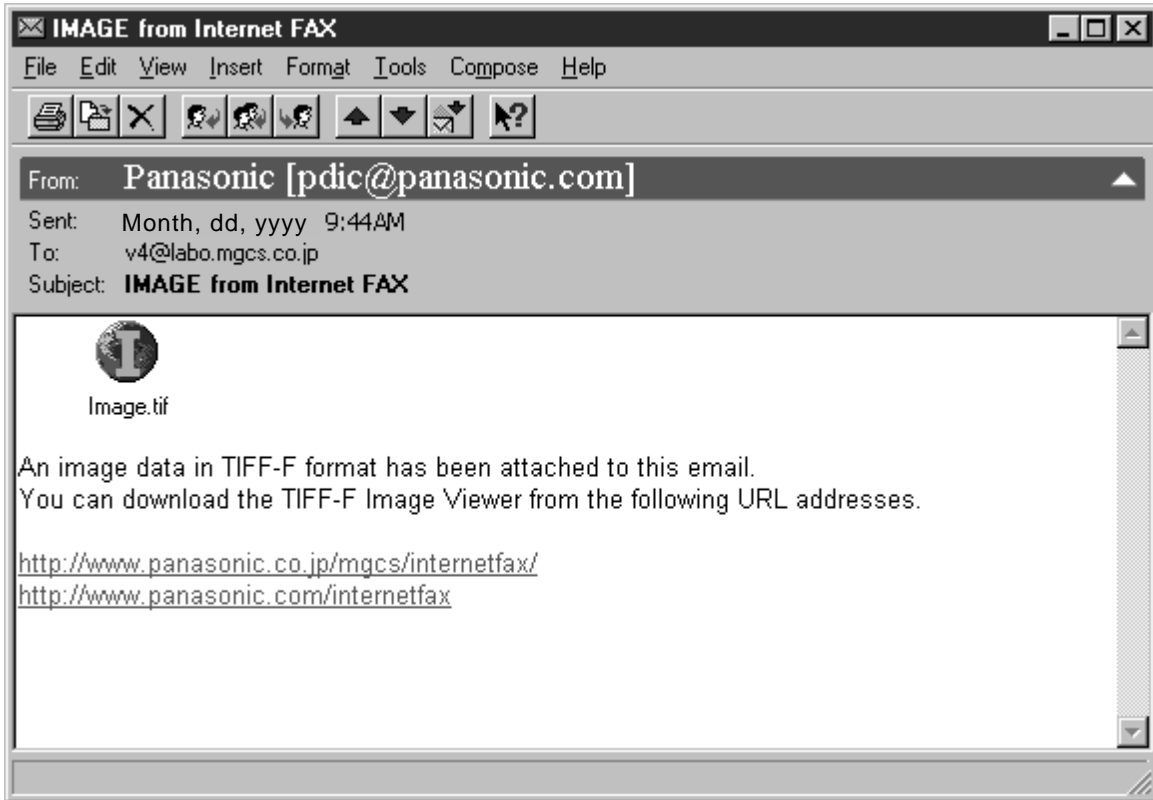

- For your reference, the above example is from Windows Messaging running under Microsoft® Windows 95®.
- To run the Viewer, please refer to your application's User Manual. The attached file is composed of TIFF-F (Tagged Image File Format with Modified Hoffman coded image). TIFF Viewers come in many flavors, a majority of TIFF Viewers will open and view this file, however, a handful of Viewers may not support this format.
- You can download the TIFF-F Image Viewer into your PC from the following URL addresses:  
<http://www.panasonic.co.jp/mgcs/internetfax/>  
<http://www.panasonic.com/internetfax/>
- License agreement of Panasonic's TIFF-F Image Viewer application

You must carefully read the license agreement before installing the TIFF-F Image Viewer application on your PC. If you do not agree to all the terms of this agreement, do not use the software and destroy all of the copies thereof.

You must assume full responsibility for selection of the software and its operation/non-operation and results obtained therefrom.

# Receiving Documents via LAN

## Receiving Email from a POP Server

Your machine offers a choice to receive and print Internet email messages via LAN unattended or manually when subscribing to a POP mail server.

### Setting the POP Parameters

Set the parameters pertinent to the POP server (Fax Parameters No. 146 to 149).

No. 146 (POP TIMER): Enter the interval to check and retrieve email from the POP server (0 to 60 minutes). If "0 minutes" is entered, the POP server is not checked for mail.

No. 147 (AUTO POP RCV): When there is mail to be retrieved from the POP server, your machine will retrieve it and print the email unattended. If this parameter is set to "1:Invalid", the machine will not retrieve it, but displays the number of mails on the POP server.

No. 148 (DEL POP RCV MAIL): Select whether the email is deleted from the POP server after it is retrieved by your machine.

No. 149 (DEL POP ERR MAIL): Select whether to delete the email from the POP server when the file attachment format is not supported.

To set the above POP parameters, follow the steps below.

1

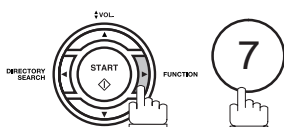

```
SET MODE          (1-8)
ENTER NO. OR v ^
```

2

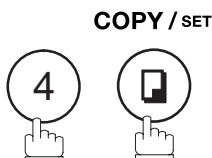

```
FAX PARAMETER(1-174)
NO. =■
```

3

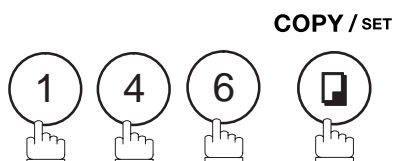

```
146 POP TIMER
3 min. (0-60)
```

4

Enter the desired download interval (0 to 60 minutes).

Ex: ① ⑤

If you make a mistake, press **CLEAR** to erase the digit and then re-enter the correct value.

```
146 POP TIMER
5 min. (0-60)
```

5

COPY / SET



```
147 AUTO POP RCV
2:VALID
```

6

① for "INVALID"

or

② for "VALID"

```
147 AUTO POP RCV
2:VALID
```

## Receiving Email from a POP Server

7

COPY / SET



```
148 DEL POP RCV MAIL
2:VALID
```

8

① for "INVALID"

or

② for "VALID"

```
148 DEL POP RCV MAIL
2:VALID
```

9

COPY / SET



```
149 DEL POP ERR MAIL
1:INVALID
```

10

① for "INVALID"

or

② for "VALID"

```
149 DEL POP ERR MAIL
1:INVALID
```

11

COPY / SET



```
150 IFAX RET RECEIPT
1:INVALID
```

12

STOP



### NOTE

1. When an unsupported file attachment is received, an error message is printed to inform you that the file attachment could not be printed.
2. When Fax Parameter No. 148 (DEL POP RCV MAIL) and/or Fax Parameter No. 149 (DEL POP ERR MAIL) are set to 1:Invalid, email with errors will not be erased. This will allow you to retrieve this email from your PC later.

Furthermore, if these Fax Parameters are set to "1:Invalid", you will need to delete mails from the POP server periodically. POP servers allocate a certain amount of space per account and if mail is not deleted regularly, your mail box will overflow and new incoming mail will be rejected.

Either retrieve these mails from your PC or set the Fax Parameters to "2:Valid" triggering your machine to receive, print and delete all the mails from the POP server. This procedure, however, might cause mail that had been printed before to print again.

# Receiving Documents via LAN

## Receiving Email from a POP Server

### Unattended Reception from the POP Server

When the Fax Parameter No. 146 (POP TIMER) is set to a value between 1 and 60 minutes, and Fax Parameter No. 147 (AUTO POP RCV) is set to "2:Valid", the machine will query the POP server at the specified interval for new mail.

Any mail on the POP server is retrieved and printed unattended.

```
1 NEW MAIL(S)
```

When the Fax Parameter No. 146 (POP TIMER) is set to "0", the machine will not query the POP server and the mail is not retrieved automatically. With this setting, mail must be retrieved manually from the POP server.

```
03-DEC-2002 17:15  
< NEW MAIL(S)>
```

When the Fax Parameter No. 147 (AUTO POP RCV) is set to "1:Invalid", the machine will query the POP server for new mail at the interval specified by Fax Parameter No. 146. If new mail has arrived at POP server, the machine will not retrieve it, but displays the number of mails on the POP server.

### Manual Reception from the POP Server

To receive manually from the POP server, follow the steps below:

1

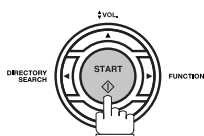

```
03-DEC-2002 17:15  
00%
```

or

```
03-DEC-2002 17:15  
< NEW MAIL(S)>
```

2

If the POP server has not received any new mail, the following message is displayed.

```
NO NEW MAIL
```

3

If POP server received new mail, the machine will display the number of mails on the server, then receive and print the email.

```
ON LINE * RCV *  
ID:abc@panasonic.com
```

#### NOTE

1. If you program a user name and password in the Program key, you can receive mail from the POP server using a user name other than the name set as the user parameter.

# Receiving Documents via Telephone Line

## Reception Modes

You can select one of the four modes as shown below.

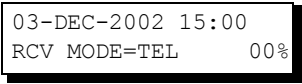
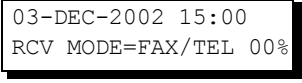
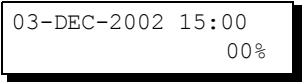
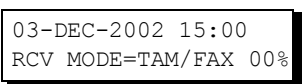
Conditions	Suggested Reception Mode	Settings
You normally receive only voice calls.	<u>Telephone Mode</u> You can answer the incoming call via an External Telephone (Optional). If you receive a fax calling signal, simply press START to receive manually. (See page 128)	Fax Parameter No. 17 set to 1: Tel. 
You receive both voice and fax calls.	<u>Fax / Tel Auto Switching Mode</u> Unit will answer the incoming call then distinguishes whether it is voice or fax call. If it is a fax call, the unit will receive automatically. if it is a voice call, the unit will signal (ring) through the speaker for your attention. (See page 129)	Fax Parameter No. 17 set to 3: Fax / Tel SW. 
You normally receive fax calls only.	<u>Fax Mode</u> Unit will receive the document automatically. All incoming calls (including a voice call) are answered by the fax machine. (See page 130)	Fax Parameter No. 17 set to 2: Fax. 
You receive both voice and fax calls and a Telephone Answering Machine (TAM) is connected.	<u>TAM Interface Mode</u> The TAM answers the incoming call. During that time, the unit also monitors whether it is a voice call, the TAM continues to operate. If it is a fax call, the unit will automatically switch the line to the Fax and begin receiving document. (See page 131)	Fax Parameter No. 17 set to 4: TAM / FAX. 

### NOTE

1. Depending on the model of the Telephone Answering Machine (TAM) that is connected, some of the features may not be compatible with your fax machine operating in the TAM Interface mode.
2. If you are using the "Distinctive Ring Service" provided by your local telephone company, please note that the ring pattern for your fax number must match with the setting of Fax Parameter No. 30 (DRD SERVICE). (See page 79)  
If the setting does not match with the ring pattern, your machine will not receive a document automatically and the telephone will continue to ring.  
Furthermore, if your TAM does not support the "Distinctive Ring Detector" service, it may not function properly in TAM Interface.

# Receiving Documents via Telephone Line

## Telephone Mode

When your machine is set to this mode, your machine will not receive documents automatically. If you receive a fax call, follow the procedure below to receive documents manually.

### Setting the Telephone Mode

- 1 Change Fax Parameter No. 17 (RECEIVE MODE) to 1: Tel.  
(See page 79)

### Operation of Telephone Mode

- 1 When your telephone rings, lift the handset of the External Telephone.  
If you hear a beep from the phone, it means someone wants to send a fax. Or, if the caller answers and says he/she wants to send a fax, then...

- 2 Remove any document from the ADF.

- 3a If you answered the call using the External Telephone,

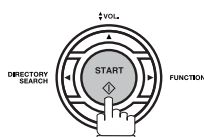

- 3b If you answered the call on an Extension phone,

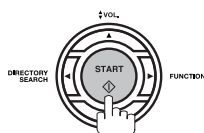

OR

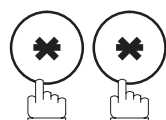

within 1 second from the telephone key pad. (See

Note 1)

Your machine will be activated remotely.

- 4 Hang up the phone.

#### NOTE

1. This procedure is called "REMOTE RCV" and will only work on a touch tone phone. If your extension phone is not a touch tone phone, press **START** on the control panel of your fax machine.



# Receiving Documents via Telephone Line

## Fax / Tel Auto Switching Mode

When your machine is set to this mode, your machine will switch to document reception or voice communication automatically.

### Setting the Fax / Tel Auto Switching Mode

- 1** Change Fax Parameter No. 17 (RECEIVE MODE) to 3: Fax / Tel SW.  
(See page 79)

### Operation of Fax / Tel Auto Switching Mode

If it is a Fax call,

- 1** Your machine will answer the call when a call is received, then distinguish whether it is a voice or fax call.
- 2** Your machine begins to receive the documents.

If it is a Voice call,

- 1** Your machine will answer the call when a call is received, then distinguish whether it is a voice or fax call.
- 2** Your machine begins to signal (ringing) through the machine's speaker for your attention. (See Note 1)
- 3** Lift the handset of the External Telephone and press .
- 4** Begin the conversation.

#### NOTE

1. The length of time the machine signals can be changed by Fax Parameter No.18 (OP CALL TIMER). (See page 79)
2. To adjust the Ringer Volume refer to page 44.

# Receiving Documents via Telephone Line

## Fax Mode

When your machine is set to this mode, it will immediately begin to receive documents automatically when a call is received.

### Setting the Fax Mode

- 1 Change Fax Parameter No. 17 (RECEIVE MODE) to 2: Fax.  
(See page 79)

### Operation of Fax Mode

Your machine will begin receiving automatically when a fax call is received.

# Receiving Documents via Telephone Line

## TAM (Telephone Answering Machine) Interface Mode

Your machine is equipped with a unique feature called TAM Interface which enables it to automatically switch a single telephone line either to Fax or TAM. You can connect most TAMs in the market to your machine and use your existing telephone line very efficiently. However, some TAMs may not be compatible with this machine. Answering Services (Voice Mail) provided by your Local Phone company are not compatible with this feature. For the operation of your TAM, please refer to the User's Guide of the TAM.

### Installing your TAM

1

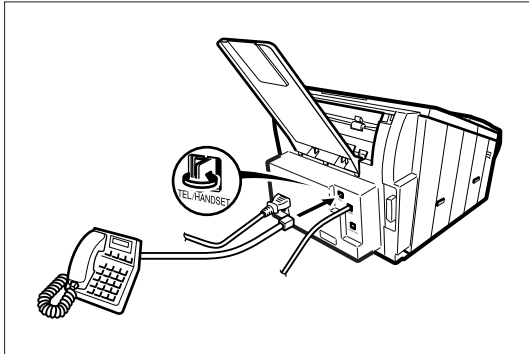

2

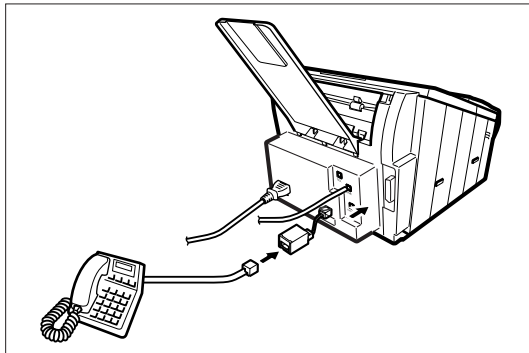

3

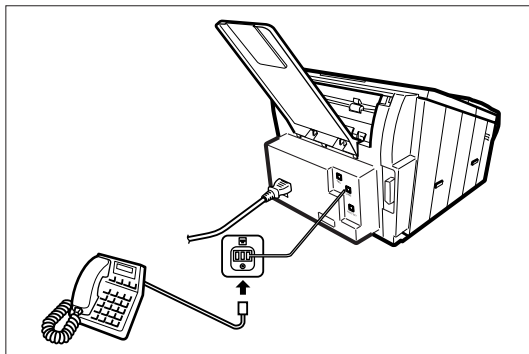

4

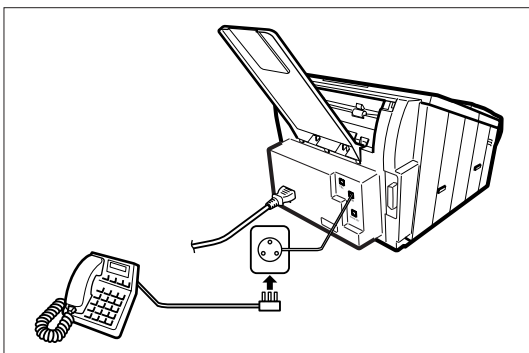

1. Remove the telephone line cable of your TAM from the wall jack.
2. Plug the telephone line cable of your TAM into the TEL jack on the rear of the fax machine as shown.

**Note:** The connecting method for TAM may differ depending on the each country regulation. Please follow appropriate method for your country above methods. For details, please ask to your local Panasonic dealer.

# Receiving Documents via Telephone Line

## TAM (Telephone Answering Machine) Interface Mode

### Setting the TAM Interface Mode

- 1** Change Fax Parameter No. 17 (RECEIVE MODE) to 4: TAM / FAX. (See page 79)

### Operation of TAM Interface Mode

#### If it is a Fax call,

- 1** When your TAM and Fax receives an incoming call, the TAM always answers the call first and then the TAM plays the OGM (Outgoing Message) recorded in your TAM to the calling station. During the time the TAM is answering the call, your fax machine will be monitoring the line to distinguish whether it is a voice or fax call.
- 2** Your machine will switch the line to the fax and then begin to receive the documents immediately from the calling station.

#### If it is a Voice call,

- 1** When your TAM and Fax receives an incoming call, the TAM always answers the call first and then the TAM plays the OGM (Outgoing Message) recorded in your TAM to the calling station. During the time the TAM is answering the call, your fax machine will be monitoring the line to distinguish whether it is a voice or fax call.
- 2** Your TAM continues to record a message (ICM) after playing the OGM.

#### Sample of OGM

Hello, this is Smith. Sorry I am unable to take your call. Please leave your message after the beep or if you are calling to send a fax, press the asterisk button twice on your touch tone phone now and start your machine. Thank you for calling.

#### Silent Detection Mode

Enables your Fax machine to switch to the Fax Mode when receiving from units that do not send fax signal (short beep) and prevents your TAM from recording blank (long silence) incoming message.

To activate this feature,

1. Change Fax Parameter No. 20 (SILENT DET.) to 2 : Valid. (See page 79)
2. Set the time length of the OGM recorded in your TAM with the Fax Parameter No. 19 (OGM LENGTH). (See page 79)  
*[We recommend to set the time length 5 or 6 seconds longer than the actual time length of the OGM.]*

# Receiving Documents via Telephone Line

## Print Reduction

This machine can use Letter, Legal or A4 size plain paper for recording. Sometimes, oversized documents sent to you by the other parties cannot be printed within a single page. When this occurs, the document will be divided into separate pages.

This machine is equipped with a Print Reduction function to solve this problem. You may select the most appropriate setting from the selections described below.

### 1. Automatic Reduction

Each page of a received document is first stored in memory. Based on the document length, your machine will automatically calculate the suitable reduction ratio (70% to 100%) to print the entire document on a single page. If the received document is extremely long (over 39% longer than the recording paper), the document will be divided into separate pages and print without reduction.

### 2. Fixed Reduction

You can pre-determine the reduction ratio from 70% to 100% in 1% steps. The document(s) you receive will be reduced to the fixed ratio regardless of size.

## Selecting the Print Reduction Mode

Set Fax Parameters as shown below. (See page 79)

#### 1. To set Automatic Reduction mode.

- 1) No. 24 Print Reduction set to "Auto".

#### 2. To set Fixed Reduction mode.

- 1) No. 24 Print Reduction set to "Fixed".

- 2) No. 25 Reduction Ratio set to any number between 70% through 100%. (See Note 1)

<b>Ex:</b> A4 to A4	- 96%
A4 to Letter	- 90%
Letter to Letter	- 96%
Legal to Letter	- 75%

### NOTE

1. If the sending side is set to print the header on the outside of the copy area, more reduction ratio will be required.

# Receiving Documents via Telephone Line

## Receiving Oversize Documents

If the received document is extremely long (over 39% longer than the recording paper), the document will be divided into separate pages. When printing on separate pages, the bottom 0.4 in (10 mm) of first page will be overlapped on top of the next page.

Transmitted Document

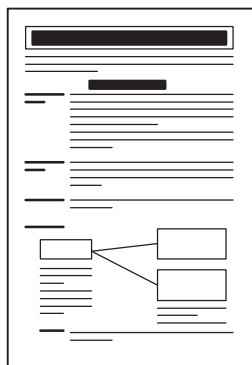

Received Document

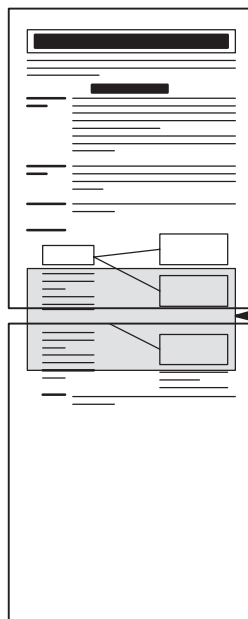
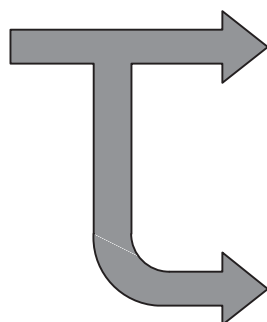

Overlap print.  
0.4 in (10 mm)

The receiving document is divided into two sheets with overlap printing.

### NOTE

1. If the reduction method is set to the Automatic Reduction mode, the document is printed out with no reduction when printing out separate pages. If the reduction method is set to Fixed Reduction mode, the document is printed out by the ratio you set in Fax Parameter No. 25. (See page 79)

# Receiving Documents via Telephone Line

## Substitute Memory Reception

If the recording paper runs out or jams or if the toner runs out during reception, the machine automatically starts receiving documents into its image data memory. Stored documents are printed automatically after replacing the recording paper or the toner cartridge. (See Note 1 and 2)

**1** When the machine finishes the memory reception and there is no recording paper or toner, an Information Code appears on the display.

NO RECORDING PAPER  
INFO. CODE=010

**2** Install the recording paper (See page 36) or replace the toner cartridge (See page 34).

OUT OF TONER  
INFO. CODE=041

The machine will automatically start printing the document stored in the memory.

\* PRINTING \*  
MEMORY RCV' D DOC

## Print Collation Mode

The printing mechanism of your machine is a Reverse Order Stacking construction. Your machine has a Print Collation Mode that stacks received documents in the correct order. When the Print Collation Mode is enabled, all received documents are stored into memory first, then printed out in Correct Order Stacking. The requirements for the Print Collation Mode to be active are; 1) Fax Parameter No. 65 PRINT COLLATION set to "Valid", and 2) enough remaining memory.

The unit will print in Reverse Order Stacking (Non-Collation Mode) whenever one of the above requirements is not met.

To use this function, we recommend installing an Optional Flash Memory Card. See page 242 (Options and Supplies).

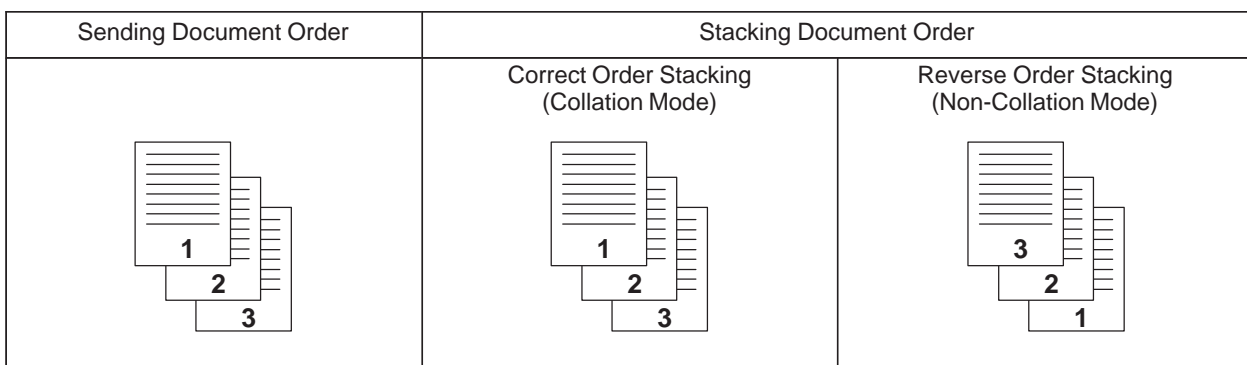

### NOTE

1. If the memory overflows, the machine will stop receiving and release the communication line. The document(s) stored in the memory up to that moment will be printed out.
2. If you wish to turn off the substitute reception function, change the setting of Fax Parameter No. 22 to "Invalid". (See page 79)

# Making Copies

Your machine has a copy function which can make single or multiple copies.

1



Set document(s) face down.

ENTER STATION(S)  
THEN PRESS START 00%

2

COPY / SET



COPY  
NO. OF COPY=1

3

Enter the number of copies (max. 99).

Ex: ① ⑩

COPY  
NO. OF COPY=10

4

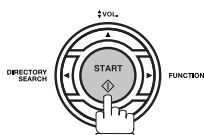

The machine stores the document, then prints the copies.

\* STORE \* NO.005  
PAGES=001 01%

\* COPY \*  
NO. OF COPY=01/10

## NOTE

1. The copy will be reduced automatically depending on the length of the original document. If you wish to be prompted for the reduction ratio when making copies, change the setting of Fax Parameter No. 32 (COPY REDUCTION) to "Manual". (See page 80)

If Copy Reduction is set to Manual, press ▼ and ▲ to set the zoom ratio in 1% steps. (100% to 70%)

2. If you make a copy with Super Fine resolution, it will be reduced slightly even if the reduction ratio is set to 100% in order to fit the data on one page.

3. You can change the Contrast and Resolution without Standard Resolution in Copy Mode.

4. If you experience a memory overflow error while making copies, you may turn "Off" the Memory XMT feature temporarily by pressing [FUNCTION] ⑧ ⑨ [SET] ①. However, the printed copies will not be collated.



# Timer Controlled Communications

## General Description

You can send a document to one or multiple stations at any preset time within the next 24 hours. Up to 70 built-in timers can be set for deferred transmission and deferred polling.

## Deferred Transmission

1



Set document(s) face down.

ENTER STATION(S)  
THEN PRESS START 00%

2

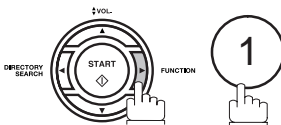

DEFERRED COMM. (1-2)  
ENTER NO. OR ∨ ^

3

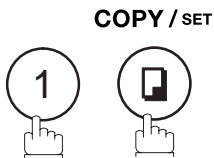

DEFERRED XMT  
START TIME ■ :

4

Enter the start time from the keypad.  
(Use a 4-digit, 24-hour clock)

Ex: ② ③ ③ ① (11:30 p.m.) and

ENTER STATION(S)  
THEN PRESS START

5

Dial by any combination of the following methods:

- One-Touch Dialling
- Abbreviated Dialling
- Manual Number Dialling, press  after each station is entered (Up to 70 stations)
- Directory Search Dialling, press  after each station is entered (For details, see page 107 to 109.)

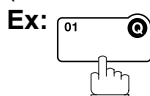

<01>(Station name)  
5551234

6

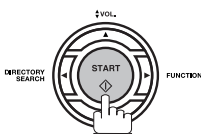

to store documents into the memory.

\* STORE \* NO.002  
PAGES=001 05%

\* STORE \* COMPLETED  
TOTAL PAGES=005 30%

### NOTE

1. If you enter a wrong number in Step 4, press  then re-enter the right number.
2. To change or cancel the Deferred Communication settings, see page 162 and 164.
3. When you reserve a deferred transmission without storing a document into memory, the following message will be shown on the display after pressing  in the last step.

DEF DIRECT XMT RSV'D  
<01>(Station name)

# Timer Controlled Communications

## Deferred Polling

1

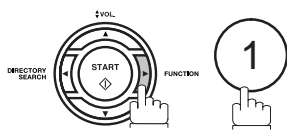

DEFERRED COMM. (1-2)  
ENTER NO. OR ∨ ^

2

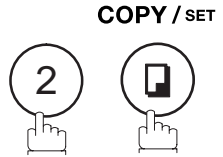

DEFERRED POLLING  
START TIME ■ :

3

Enter the start time from the keypad.  
(Use a 4-digit, 24-hour clock)

Ex: ③ ③ ③ ③ (3:30 a.m.) and

DEFERRED POLLING  
PASSWORD=■■■■

4

Enter a 4-digit polling password.

Ex: ⑨ ⑧ ⑦ ⑥ and

ENTER STATION(S)  
THEN PRESS START

5

Dial by any combination of the following methods:

- One-Touch Dialling
- Abbreviated Dialling
- Manual Number Dialling, press  after each station is entered (Up to 70 stations)
- Directory Search Dialling, press  after each station is entered (For details, see page 107 to 109.)

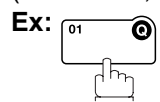

<01>(Station name)  
5551234

6

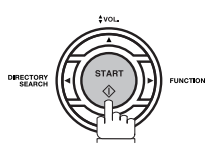

\* STORE \* NO.001

**NOTE**

1. If you enter a wrong number in Step 3, press , then re-enter the right number.
2. To change or cancel the Deferred Communication settings, see page 162 and 164.

# Polling

## General Description

Polling means calling other station(s) to retrieve a document. The other station must know in advance that you will call and must have a document set on the ADF or stored in the memory. You may need to set a polling password, shared by the other station, to ensure security.

## Setting the Polling Password

If the polling password does not match with the polled station, your polling request will be refused automatically.

To set the polling password, follow the steps below.

1

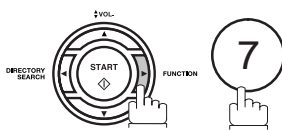

SET MODE (1-8)  
ENTER NO. OR ∨ ^

2

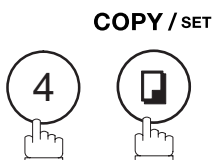

FAX PARAMETER (1-174)  
NO. = ■

3

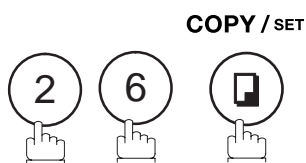

26 POLLING PASSWORD  
■■■■

4

Enter a 4-digit polling password.

Ex: ① ② ③ ④

26 POLLING PASSWORD  
1234

5

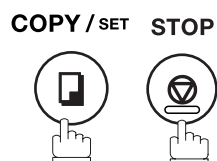

### NOTE

1. Polling might not function with all fax machines. We suggest you attempt a trial polling before you actually poll important documents.
2. If a password is not set in the polled station, you may poll the other station even though your machine has a password.

# Polling

## Preparing to be Polled

In order to let other stations poll your machine, you must prepare your machine with a document stored in memory. Be sure to set the polling password before storing the document into memory. After being polled, the documents stored in the memory will be erased automatically. To retain the documents in memory so that they can be polled repeatedly change Fax Parameter No. 27 (POLLED FILE SAVE) to "Valid".

1



Set document(s) face down.

```
ENTER STATION(S)  
THEN PRESS START 00%
```

2

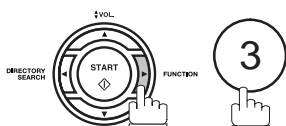

```
POLLING NO.=  
1:POLLING 2:POLLED
```

3



```
POLLED  
PASSWORD=1234
```

4

Enter a 4-digit polling password. (See Note 3)

Ex: ④ ③ ② ①

```
POLLED  
PASSWORD=4321
```

5

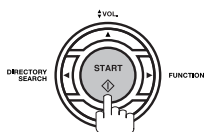

The document(s) will be stored into memory.

```
* STORE * NO.015  
PAGES=001 01%
```

```
* STORE * COMPLETED  
TOTAL PAGES=005 24%
```

### NOTE

1. You can still send or receive documents even when set to be polled.
2. Only 1 polled file can be stored in memory. If you need to add document(s) into the same polled file, see page 166.
3. If you have set the polling password in Fax Parameter No. 26, the password will appear on the display.  
You can still change the password temporarily by overwriting it with a new one.

## To Poll Documents from Another Station

The following procedure lets you poll a document from one or multiple stations. Be sure to set the polling password before polling. (See page 139)

1

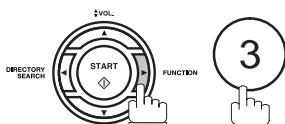

```
POLLING          NO.=
1:POLLING 2:POLLED
```

2



```
POLLING
PASSWORD=1234
```

3

Enter a 4-digit polling password. (See Note 2)

Ex: (1) (1) (1) (1)

```
POLLING
PASSWORD=1111
```

4

**COPY / SET**



```
ENTER STATION(S)
THEN PRESS START
```

5

Dial by any combination of the following methods:

- One-Touch Dialling
- Abbreviated Dialling
- Manual Number Dialling, press **SET** after each station is entered (Up to 70 stations)
- Directory Search Dialling, press **SET** after each station is entered (For details, see page 107 to 109.)

Ex: 01

```
<01>(Station name)
5551234
```

6

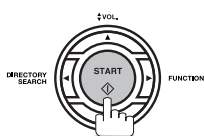

```
* STORE *      NO.001
```

### NOTE

1. You can review the entered stations in step 5 by pressing or key, press **CLEAR** to erase the displayed station or group as needed.
2. If you have set the polling password in Fax Parameter No. 26, the password will appear on the display.  
You can still change the password temporarily by overwriting it with a new one.

# Program Keys

## General Description

Your fax machine has special Program Keys. These keys are useful if you frequently need to send or poll the same group of stations. You can use these keys to store a One-Touch group key, a sequence of stations to be polled, a deferred transmission or polling sequence or an additional One-Touch key.

## Setting for Group Dialling

To set a Program Key for Group Dialling

1

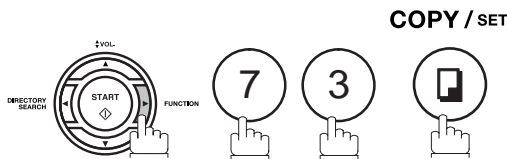

```
PROGRAM (1-5)
ENTER NO. OR v ^
```

2

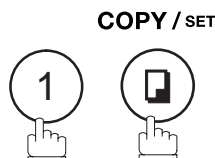

```
PROGRAM[P ]
PRESS PROGRAM KEY
```

3

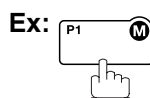

```
PROGRAM[P1] NAME
ENTER NAME
```

4

Enter the station name (up to 15 characters) by using the Character keys. (See page 14)

Ex: PROG. A and

```
ENTER STATION(S)
THEN PRESS START
```

5

Enter the station numbers by using One-Touch Key or  and 3-digit code.

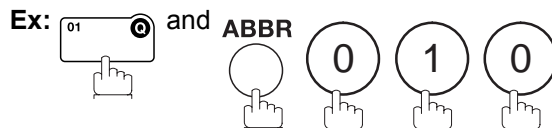

You may use the  or  keys to review the entered station(s) before going to next step. If you find an error, press  to erase the displayed station.

```
<01>(Station name)
5551234
```

```
[010](Station name)
5553456
```

6

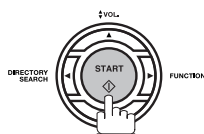

You can now set other Program Keys by repeating the procedures from Step 3, or return to standby by pressing

.

```
PROGRAM[P ]
PRESS PROGRAM KEY
```

## Setting for Deferred Transmission

To set a Program Key for deferred transmission

**1**

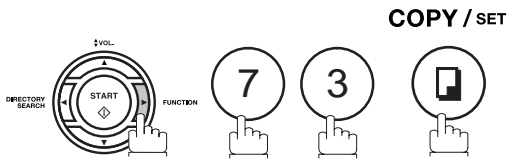

PROGRAM (1-5)  
ENTER NO. OR ∨ ^

**2**

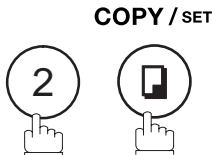

PROGRAM[P ]  
PRESS PROGRAM KEY

**3**

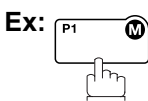

PROGRAM[P1] NAME  
ENTER NAME

**4**

Enter the station name (up to 15 characters) by using the Character keys. (See page 14)

Ex: PROG. A and SET

PROGRAM[P1]  
PRESS FUNCTION KEY

**5**

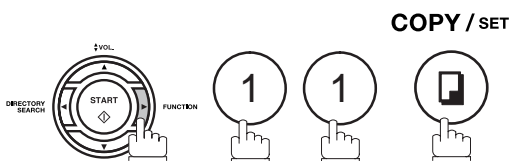

DEFERRED XMT  
START TIME ■ :

**6**

Enter the starting time using 4 digits.

Ex: 2 3 3 0 (11:30 p.m.) and SET

ENTER STATION(S)  
THEN PRESS START

**7**

Enter the station by any combination of the following methods:

- One-Touch Dialling
- Abbreviated Dialling
- Directory Search Dialling, press SET after each station is entered (For details, see page 107 to 109.)

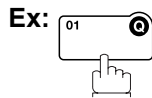

<01>(Station name)  
5551234

**8**

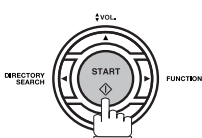

PROGRAM[P ]  
PRESS PROGRAM KEY

You can now set other Program Keys by repeating the procedures from Step 3, or return to standby by pressing

STOP .

# Program Keys

## Setting for Deferred Polling

To set a Program Key for deferred polling

1

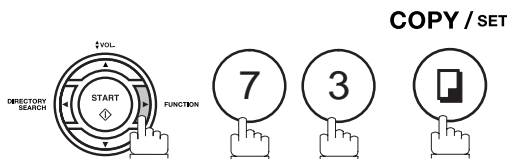

PROGRAM (1-5)  
ENTER NO. OR ∨ ^

2

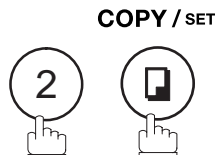

PROGRAM[P ]  
PRESS PROGRAM KEY

3

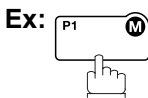

PROGRAM[P1] NAME  
ENTER NAME

4

Enter the station name (up to 15 characters) by using the Character keys. (See page 14)

Ex: PROG.A and

PROGRAM[P1]  
PRESS FUNCTION KEY

5

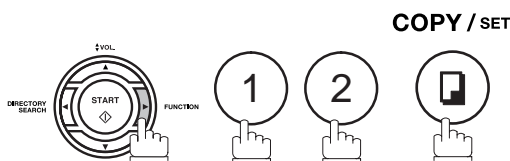

DEFERRED POLLING  
START TIME ■ :

6

Enter the starting time.

Ex: (2)(2)(0)(0) (10:00 p.m.) and

DEFERRED POLLING  
PASSWORD=■■■■

7

Enter a 4-digit polling password.

Ex: (1)(1)(1)(1) and

The polling password appears if it has been previously set.

ENTER STATION(S)  
THEN PRESS START

8

Enter the station by any combination of the following methods:

- One-Touch Dialling
- Abbreviated Dialling
- Directory Search Dialling, press  after each station is entered

(For details, see page 107 to 109.)

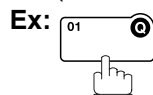

<01>(Station name)  
5551234

9

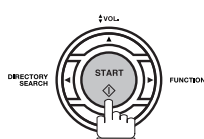

PROGRAM[P ]  
PRESS PROGRAM KEY

You can now set other Program Keys by repeating the procedures from Step 3, or return to standby by pressing

.



## Setting for Normal Polling

To set a Program Key for normal polling

1

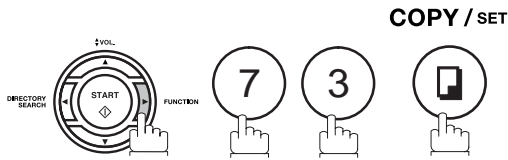

```
PROGRAM          (1-5)
ENTER NO. OR ∨ ^
```

2

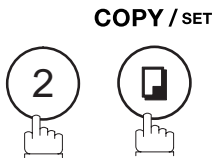

```
PROGRAM[P ]
PRESS PROGRAM KEY
```

3

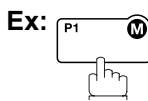

```
PROGRAM[P1]      NAME
ENTER NAME
```

4

Enter the station name (up to 15 characters) by using the Character keys. (See page 14)

Ex: PROG.A and

```
PROGRAM[P1]
PRESS FUNCTION KEY
```

5

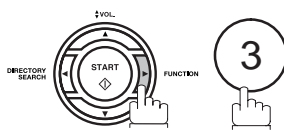

```
POLLING
PASSWORD=■■■■
```

6

Enter a 4-digit polling password.

Ex:     and

The polling password appears if it has been previously set.

```
ENTER STATION(S)
THEN PRESS START
```

7

Enter the station by any combination of the following methods:

- One-Touch Dialling
- Abbreviated Dialling
- Directory Search Dialling, press  after each station is entered (For details, see page 107 to 109.)

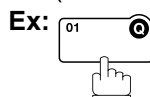

```
<01>(Station name)
5551234
```

8

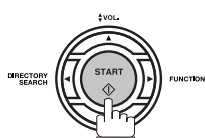

```
PROGRAM[P ]
PRESS PROGRAM KEY
```

You can now set other Program Keys by repeating the procedures from Step 3, or return to standby by pressing

# Program Keys

## Setting for One-Touch Key

To set a Program Key for One-Touch Key

1

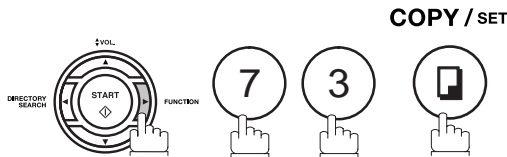

PROGRAM (1-5)  
ENTER NO. OR V ^

2

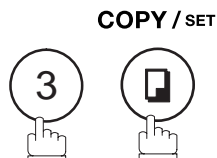

PROGRAM[P ]  
PRESS PROGRAM KEY

3

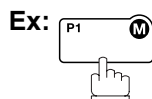

PROGRAM[P1] NAME  
ENTER NAME

4

Enter the station name (up to 15 characters) by using the Character keys. (See page 14)

Ex: PROG.A and

[P1] PROG.A  
ENTER TEL. NO.

5a

Enter a telephone number (up to 36 digits including pauses and spaces).

Ex:

[P1] PROG.A  
9-555 1234

5b

Enter the email address using character keys (up to 60 characters).

Ex: EMAIL

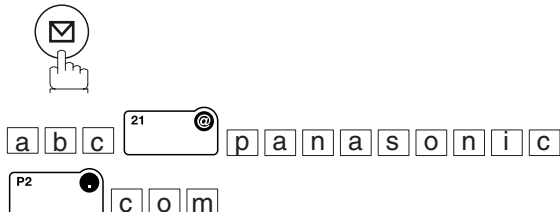

[P1]PROG.A  
abc@panasonic.com

6

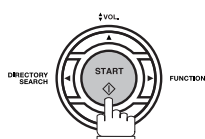

You can now set other Program Keys by repeating the procedures from Step 3, or return to standby by pressing

.

PROGRAM[P ]  
PRESS PROGRAM KEY

## Setting the POP Access Key

This function allows others to share your machine to retrieve their emails from the POP server by preprogramming their POP User Names and POP Passwords into the Program Keys (P1 to P4). They will be able to retrieve their emails by simply pressing the associated Program Key. (See Note 1)

1

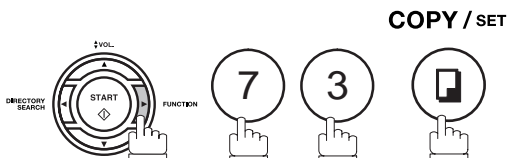

PROGRAM (1-5)  
ENTER NO. OR ∨ ^

2

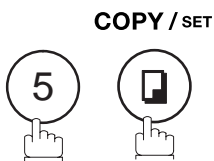

PROGRAM[P ]  
PRESS PROGRAM KEY

3

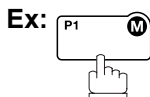

POP USER NAME  
█

4

Enter a POP User Name (up to 40 characters) using the Character keys and press **SET**.

Ex: **k a t e** and **SET**

POP USER NAME  
kate█

POP PASSWORD  
█

5

Enter a POP Password (up to 10 characters) using the Character keys and press **SET**.

Ex: **p a n a** ① ② ③ and **SET**

POP PASSWORD  
pana123█

6

① to leave messages on server after retrieval

or

② to delete messages on server after retrieval

DELETE EMAIL NO.=1  
1:NO 2:YES

PROGRAM[P ]  
PRESS PROGRAM KEY

You can now set other Program Keys by repeating the procedures from Step 3, or return to standby by pressing

**STOP**.

### NOTE

1. If security is a concern and to prevent unauthorized personnel from retrieving your email from the POP server, when programming the Program Key, leave the POP Password field "Blank". By leaving it "Blank", the machine will prompt you to enter the POP Password when the Program Key is pressed to retrieve mail.

# Program Keys

## Using the POP Access Key

To retrieve your Email from the POP Server by using the Program Key, follow the procedure below.

**1** Press the Program key programmed for POP Access Key.

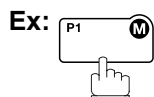

```
POP RCV USER NAME
kate
```

If the POP User Name is not entered in the Program Key, enter the POP User Name (up to 40 characters).

**2**

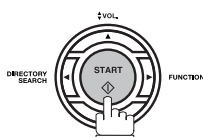

If the POP Password is not entered in the Program Key, enter the POP Password (up to 10 characters) and press

**START**.

**3**

If the POP server has not received any new mail, the following message is displayed.

```
NO NEW MAIL
```

**4**

If POP server received new mail, the machine will display the number of mails on the server, then receive and print the email.

```
1 NEW MAIL(S)
```

```
ON LINE * RCV *
ID:abc@panasonic.com
```

## Changing or Erasing the Program Key Settings

To change the settings in a Program Key, follow the procedure on setting a Program Key on pages 142 to 146.

- Start time or station(s) for deferred transmission
- Station(s) for normal polling
- Start time or station(s) for deferred polling
- Station(s) for group dialling
- Telephone number and station name for One-Touch key

### To erase the settings in a Program Key

**1**

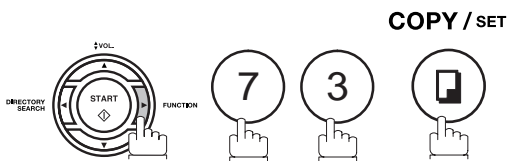

PROGRAM (1-5)  
ENTER NO. OR ∨ ^

**2**

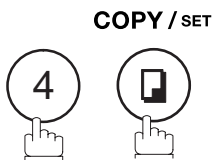

PROGRAM[P ]  
PRESS PROGRAM KEY

**3**

Press the Program key you want to erase.

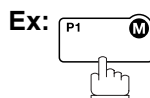

PROGRAM[P1]  
DELETE? 1:YES 2:NO

**4**



\* DELETING \*  
PROGRAM[P1]

**5**

You can now erase other Program Keys by repeating the procedures from Step 3, or return to standby by pressing

**STOP**.

PROGRAM[P ]  
PRESS PROGRAM KEY

# Sender Selection

## General Description

This operation allows the user to select one of the 25 preset User Names and Email Addresses before a transmission. The selected User Names is printed on the Header of each page sent and on the COMM. Journal. When sending email, the selected user name and/or email address appears in the "From:" field of the email message.

## Setting the Sender Selection

1

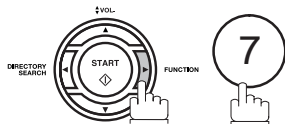

```
SET MODE      (1-8)
ENTER NO. OR ∨ ^
```

2

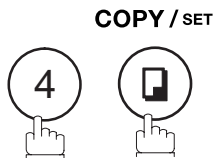

```
FAX PARAMETER(1-174)
NO.=■
```

3

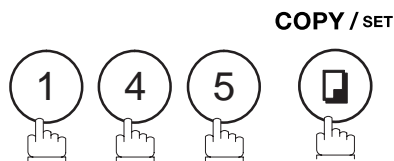

```
145 SENDER SELECTION
1:INVALID
```

4



```
145 SENDER SELECTION
2:VALID
```

5



```
SENDER SELECTION
ENTER NO. OR ∨ ^
```

6

Enter the Sender Selection number.

```
ENTER USER NAME
12 ■
```

Ex: ① ② (01 to 24)

7

Enter your User Name (max. 25 characters and digits) by using character keys. (See page 14)

```
ENTER USER NAME
12 PANASONIC SALES■
```

Ex: P A N A S O N I C SPACE  
S A L E S and SET (See Note 1)

8

Enter an email address to be printed on the "From" field of the email message (max. 60 characters).

```
ENTER EMAIL ADDRESS
12 ■
```

Ex: a b c <sup>21</sup> p a n a s o n i c  
P2 <sup>9</sup> c o m

```
ENTER EMAIL ADDRESS
12 abc@panasonic.com
```

Continued on the next page...

## Setting the Sender Selection

# 9

**COPY / SET**



ENTER USER NAME  
13 ■

To record another User Name, repeat step 6 to 9. To return to standby, press **STOP**.

### NOTE

1. Use **COPY** to copy the default User Name that was programmed in the User Parameters. You can add the department name following the default User Name.

# Sender Selection

## Sending Document with Sender Selection

1



Set document(s) face down.

ENTER STATION(S)  
THEN PRESS START 00%

2

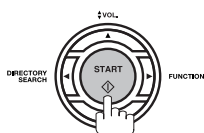

Enter email address or telephone number.

3



SELECT SENDER(00-24)  
ENTER NO. OR ∨ ^

4

Enter a number or use  or  to select the User Name that you want to use. (See Note 2)

12 PANASONIC SALES  
abc@panasonic.com

Ex: ① ②

5

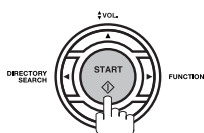

The document is sent as an email message with the selected user name and/or email address appearing in the "From" field of the email message.

### NOTE

1. The Sender Selection function cannot be used in the Voice Dialling Mode for ordinary transmission.
2. If you do not select a User Name in the step 4, the unit selects the default User Name (00) that was programmed in the User Parameters for ordinary transmission.



## Printing the Sender Selection List

The Sender Selection List can be printed out following the Fax Parameter List.

To enable the printing of the Sender Selection List, change the setting of Fax Parameter No. 145 (SENDER SELECTION) to "Valid". (See page 150)

**1**

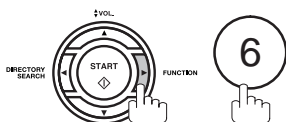

```
PRINT OUT      (1-7)
ENTER NO. OR ∨ ^
```

**2**

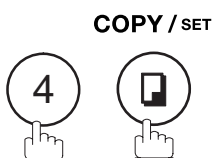

```
* PRINTING *
FAX PARAMETER LIST
```

### Sample Sender Selection List (Prints following the Fax Parameter List)

```
***** -FAX PARAMETER LIST- ***** DATE 03-DEC-2002 ***** TIME 15:00 ***P.02

SENDER SELECTION LIST

(1)      (2)      (3)
NO.      USER NAME      EMAIL ADDRESS

01      Panafax Sales      sales@panasonic.com
02      Panafax Service      service@panasonic.com
03      Panafax Accounting      account@panasonic.com

}              }              }

24      Panafax Engineering      engineering@panasonic.com

***** -HEAD OFFICE - ***** PANASONIC ***** - 201 555 1212- *****
```

### Explanation of Contents

- (1) Sender Selection Number : 01-24
- (2) User Name : Up to 25 characters
- (3) Email Address : Up to 60 characters

# Subject Line Entry

## General Description

Your machine will automatically add the Default Subject information that was entered during the User Parameter setup, to the Subject Line of all outgoing emails.

If you would like for the machine to prompt you for the Subject before each email transmission, change the Fax Parameter No. 159 (SUBJECT LINE ENTRY) to "2:Valid".

## Sending Email with Subject Line Entry

1



Set document(s) face down.

```
ENTER STATION(S)  
THEN PRESS START 00%
```

2

Enter the email addresses by any combination of the following methods:

- One-Touch Dialling
- Abbreviated Dialling
- Directory Search Dialling, press  after each email address is entered.
- Manual Number Dialling, press  after each station is entered (up to 70 addresses).

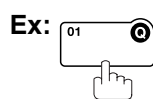

```
<01>(Station name)  
abc@panasonic.com
```

3

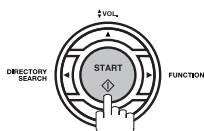

```
ENTER SUBJECT OR  
PRESS START TO SEND
```

4

Enter the Subject (max. 40 characters and digits) by using the Character keys. (See page 14) To use the Default Subject pre-programmed in the User Parameter, just press .

Ex: **FAX from Mr. Jones**

```
SUBJECT  
FAX from Mr. Jones
```

## Sending Email with Subject Line Entry

# 5

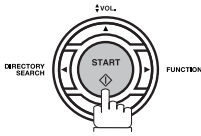

The document(s) is stored into memory with a file number. Then connects to the LAN and starts sending the email message.

```
* STORE *      NO.001
      PAGES=001  01%
```

```
* STORE * COMPLETED
      PAGES=001  10%
```

```
ON LINE * MEM.MXT *
ID: (Station name)
```

### NOTE

1. If no default subject is programmed, the message is shown as "IMAGE from Internet FAX" for the subject.

# Inbound Routing

## Setting the Routing Parameters

Your machine can route documents received from a G3 fax machine to email address(s) or to Internet Fax machine(s) connected to a LAN as an email, as well as to other G3 fax machine(s) over the telephone line.

To use this feature, the Fax Parameter No. 152 "SUB-ADDRESS ROUTING" and/or No. 153 "TSI ROUTING" must be set to "2:Valid".

**No. 152 SUB-ADDRESS ROUTING:** Set this parameter to perform an ITU-T sub-address query within its auto dialler and to route the received document(s) to the corresponding stations email address(s) or telephone number(s).

**No. 153 TSI ROUTING:** Set this parameter to perform a Numeric ID (TSI frame information) query within its auto dialler and to route the received document(s) to the corresponding stations email address(s) or telephone number(s).



**No. 154 ROUTING HEADER FORMAT:** Use this parameter to select the type of email header to be included in the "From" field of each routed faxes. (Default setting is "1:Originator")

Originator : The originating fax machine's TSI will appear in the "From" field of the routed email.

Relay Station : The routing station's email address will appear in the "From" field of the routed email.

**No. 155 PRINT ROUTED DOCUMENT:** Set this parameter to select whether a received fax to be routed is always printed on your machine or only when the routing operation fails.

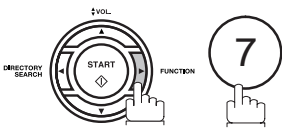
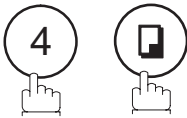
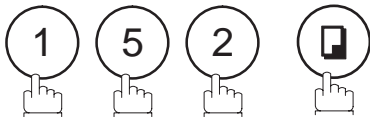
To set the above Inbound Routing parameters, follow the steps below.

<b>1</b>		<pre>SET MODE          (1-8) ENTER NO. OR v ^</pre>
<b>2</b>	<b>COPY / SET</b> 	<pre>FAX PARAMETER(1-174) NO.=■</pre>
<b>3</b>	<b>COPY / SET</b> 	<pre>152 SUB-ADDR ROUTING 1:INVALID</pre>
<b>4</b>	① for "INVALID" or ② for "VALID"	<pre>152 SUB-ADDR ROUTING 1:INVALID  152 SUB-ADDR ROUTING 2:VALID</pre>
<b>5</b>	<b>COPY / SET</b> 	<pre>153 TSI ROUTING 1:INVALID</pre>

## Setting the Routing Parameters

**6**

① for "INVALID"

or

② for "VALID"

153 TSI ROUTING  
1:INVALID

153 TSI ROUTING  
2:VALID

**7**

**COPY / SET**



154 ROUTE HEADER FMT  
1:ORIGINATOR

**8**

① for "ORIGINATOR"

or

② for "RELAY STATION"

154 ROUTE HEADER FMT  
1:ORIGINATOR

154 ROUTE HEADER FMT  
2:RELAY STATION

**9**

**COPY / SET**



155 PRINT ROUTED DOC  
1:INC. ONLY

**10**

① for "INC. ONLY"

or

② for "ALWAYS"

155 PRINT ROUTED DOC  
1:INC. ONLY

155 PRINT ROUTED DOC  
2:ALWAYS

**11**

**COPY / SET**



156 PRT FORWARD DOC  
1:INC. ONLY

**12**

① for "INC. ONLY"

or

② for "ALWAYS"

156 PRT FORWARD DOC  
1:INC. ONLY

156 PRT FORWARD DOC  
2:ALWAYS

**13**

**COPY / SET STOP**



# Inbound Routing

## Entering One-Touch/Abbreviated Dialling Numbers for Inbound Routing

If the Inbound Routing parameters are set, an ITU-T sub-address and/or originator's Numeric ID (TSI frame information) can be programmed with each email address in One-Touch, Abbreviated numbers or Program Keys. (See page 24)

**1**

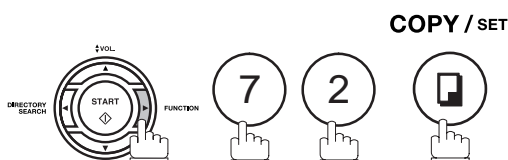

```
1:ONE-TOUCH
2:ABBR NO.
```

**2**

Select ① for One-Touch dialling number / email address.  
Select ② for ABBR dialling number / email address.

```
ONE-TOUCH< >
PRESS ONE-TOUCH
```

Ex: ①

**3**

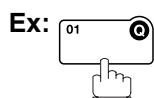

```
<01>
ENTER EMAIL ADDRESS
```

or

To change the input mode (between "ENTER EMAIL ADDRESS" and "ENTER TEL. NO."),

```
<01>
ENTER TEL. NO.
```



**4**

Enter an email address (up to 60 characters) or a telephone number (up to 36 digits).

```
<01>
abc@panasonic.com█
```

or

```
<01>
55512342762█
```

**5**

COPY / SET



```
<01>ENTER NAME
abc@panasonic.com
```

or

```
<01>ENTER NAME
55512342762
```

**6**

Enter the station name using character keys (up to 15 characters).

```
<01> SALES DEPT█
abc@panasonic.com
```

or

Ex: [S][A][L][E][S] [ ] [D][E][P][T]

```
<01> SALES DEPT█
55512342762
```

**7**

COPY / SET



```
ROUTING: SUB-ADDRESS█
```

## Entering One-Touch/Abbreviated Dialling Numbers for Inbound Routing

8

Enter the sub-address (up to 20 characters) and press .

```
ROUTING: SUB-ADDRESS  
1234567
```

9

Enter a Numeric ID (TSI) (up to 20 characters) and press .

To return to standby, press .

```
ROUTING: TSI
```

```
ROUTING: TSI  
1234567
```

```
ONE-TOUCH< >  
PRESS ONE-TOUCH
```

**NOTE**

1. "+" and "SPACE" entries in the "ROUTING: TSI" field are ignored by the receiving machine.

# Edit File Mode

## General Description

Your machine has a document image memory which enables you to reserve memory transmission, memory deferred transmission, memory polling and so on.

After reserving the communications in memory, you may need to change the settings of the communication(s) while it is still in memory. This section describes how to use the file editing features.

## Printing a File List

The contents of the communication settings may have to be modified or deleted. To verify the contents, follow the steps below to print out a file list.

1

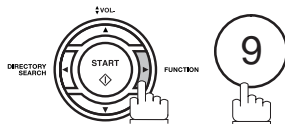

```
EDIT FILE MODE (1-6)
ENTER NO. OR V ^
```

2



```
1:FILE LIST?
PRESS SET TO SELECT
```

3



```
FILE LIST
1:PRINT 2:VIEW
```

4



```
* PRINTING *
FILE LIST
```

### Sample File List

```
***** -FILE LIST- ***** DATE 03-DEC-2002 ***** TIME 15:00 *****
```

(1)	(2)	(3)	(4)	(5)	(6)
FILE No.	COMM. TYPE	CREATED TIME	START TIME	PAGES	DESTINATION(S)
001	DEFERRED XMT	MAR-12 13:20	20:30		[001]
002	MEM. DEF. XMT	MAR-12 13:20	22:30	003	[011] [012] [013] [016] [017]
					-PANASONIC -
		***** -HEAD OFFICE		- ***** - 201 555 1212- *****	

### Explanation of Contents

- (1) File number : If the file is now being executed, a "\*" is indicated on the left of the file number.
- (2) Communication type
- (3) Stored date/time : Date/time that these files were stored.
- (4) Executing time : If the file is a Timer Controlled Communication, the start time is printed in this column.  
If the file is an incomplete file, "INCOMP" is printed in this column.
- (5) Number of stored page(s)
- (6) Destination : ABBR. No./One-Touch No./Manual Dialling No.



## Viewing the Contents of a File List

To view the contents of a file list on the display without printing it, follow the steps below.

**1**

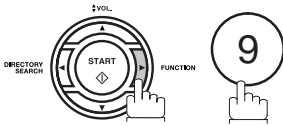

```
EDIT FILE MODE (1-6)
ENTER NO. OR V ^
```

**2**



```
1:FILE LIST?
PRESS SET TO SELECT
```

**3**

**COPY / SET**



```
FILE LIST
1:PRINT 2:VIEW
```

**4**



```
USE THE V ^ KEYS TO
SCROLL EACH FILE
```

**5**

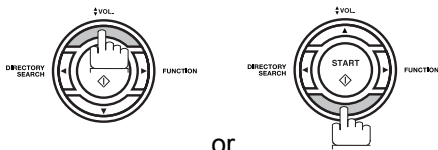

repeatedly until the display shows a file you want to edit.

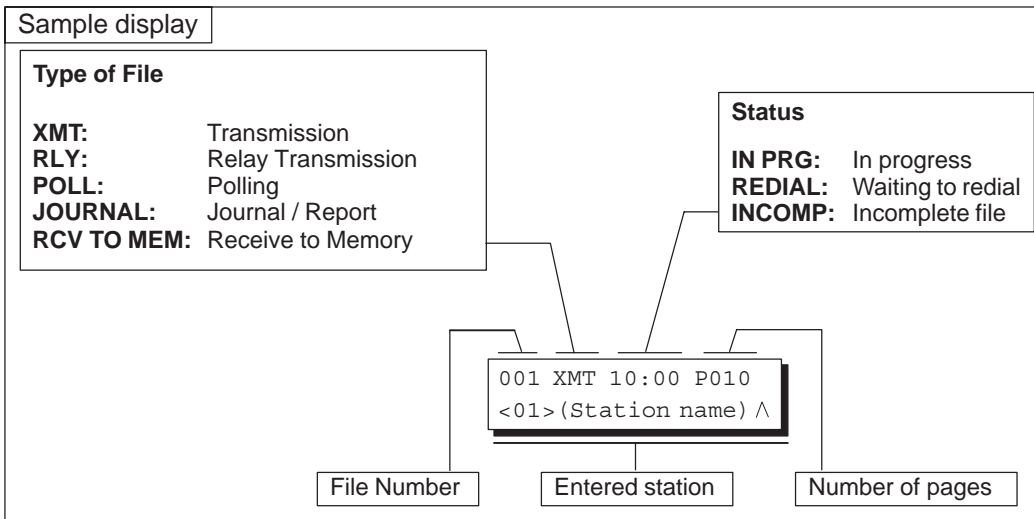

**6**

**STOP**



# Edit File Mode

## Changing the Start Time or the Station of a File

To change the start time and/or stations in a communication file, follow the steps below.

**1**

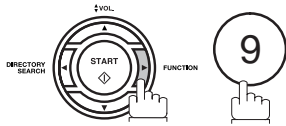

```
EDIT FILE MODE (1-6)
ENTER NO. OR V ^
```

**2**

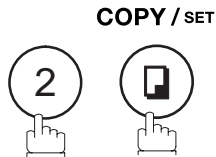

```
ENTER FILE NO. OR V ^
FILE NO. =■■■
```

**3**

Enter the file number or use  $\blacktriangledown$  or  $\blacktriangle$  to select the file that you want to change.

Ex: 0 0 1

```
ENTER FILE NO. OR V ^
FILE NO. =001
```

**4**

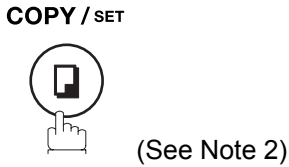

```
DEFERRED XMT
START TIME      22:30
```

**5**

Enter a new start time.

Ex: 0 6 0 0 (6:00 a.m.)  
(If you do not have to change the time, skip to step 6.)

```
DEFERRED XMT
START TIME      06:00
```

**6**



```
<01>(Station name)
5551234
```

**7**

To delete the station(s), press  $\blacktriangledown$  or  $\blacktriangle$  key until the station you want to delete appears. Then press **CLEAR**.  
OR

Enter the station(s) you want to add.

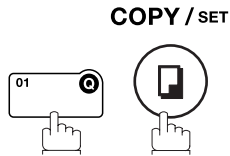

```
ENTER STATION(S)
THEN PRESS START
```

```
1 STN(S) ARE SET
ADD MORE OR START
```

**8**

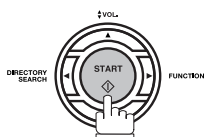

```
* STORE *      NO.005
```

## Changing the Start Time or the Station of a File

### NOTE

1. Your machine cannot change the start time and/or stations in the file while it is being sent or waiting to redial.
2. If the file is not a Deferred Communication File, the following message is shown on the display.

```
SET DEFERRED COMM. ?  
1: YES 2: NO
```

Press ① to change the type of the file for deferred communication file.

3. If you edit the file that is saved as an incomplete file, after pressing **START** in step 8, your machine will prompt you whether to execute the file immediately.  
The display shows:

```
RETRY INCOMP FILE ?  
1: YES 2: NO
```

Press ① to execute the file immediately.

# Edit File Mode

## Deleting a File

To delete the file in memory, follow the steps below.

1

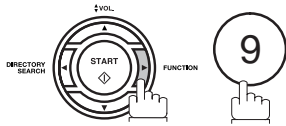

```
EDIT FILE MODE (1-6)
ENTER NO. OR V ^
```

2

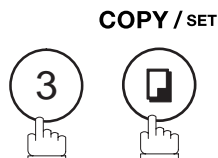

```
ENTER FILE NO. OR V ^
FILE NO. =■■■
```

3

Enter the file number or use ▼ or ▲ to select the file that you want to delete.

Ex: ① ① ① (See Note 2)

```
ENTER FILE NO. OR V ^
FILE NO. =001
```

4



```
DELETE FILE NO.001?
1:YES 2:NO
```

5



Enter the next file number you want to delete or press **STOP** to return to standby.

```
* DELETING *
FILE NO. =001
```

```
ENTER FILE NO. OR V ^
FILE NO. =■■■
```

### NOTE

1. Your machine cannot delete the file while it is being sent.
2. Enter \* \* \* as the file number and press **SET** to delete all files (except when there is the file in progress).  
The following message is shown on the display.

```
DELETE ALL FILES?
1:YES 2:NO
```

Press ① to delete all files.

## Printing Out a File

To print the contents of the communication file, follow the steps bellow.

**1**

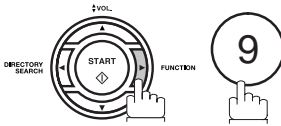

```
EDIT FILE MODE (1-6)
ENTER NO. OR ∨ ^
```

**2**

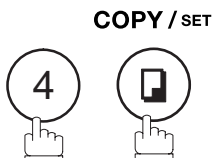

```
ENTER FILE NO. OR ∨ ^
FILE NO. =■■■
```

**3**

Enter the file number or use ▼ or ▲ to select the file that you want to print.

Ex: 0 0 1

```
ENTER FILE NO. OR ∨ ^
FILE NO. =001
```

**4**

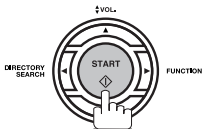

```
* PRINTING *
PAGE=001/003
```

Your machine will print the file. The document(s) will remain in memory even after printing the file.

### NOTE

1. Your machine cannot print the file while it is being sent.

# Edit File Mode

## Adding Documents into a File

To add documents into the file, follow the steps bellow.

1



Set document(s) face down.

ENTER STATION(S)  
THEN PRESS START 05%

2

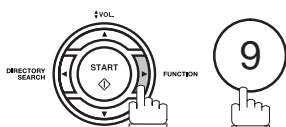

EDIT FILE MODE (1-6)  
ENTER NO. OR v ^

3

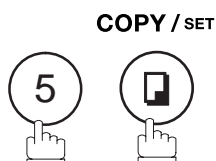

ENTER FILE NO. OR v ^  
FILE NO. =■■■

ENTER FILE NO. OR v ^  
FILE NO. =001

Enter the file number or use ▼ or ▲ to select the file that you want to add.

Ex: 0 0 1

4

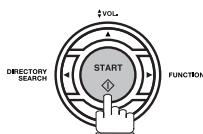

\* STORE \* NO.001  
PAGES=002 10%

Your machine will start storing the document(s) into a file.

**NOTE**

1. Your machine cannot add the document into a file while it is being sent or waiting to redial.

## Retry an Incomplete File

If a memory communication has been unsuccessful due to a busy line or no answer, the document you stored is automatically erased from memory after the last redial.

If you need to retain the document even if the communication failed, change the setting of Fax Parameter No. 31 (INC. FILE SAVE) to Valid in advance. (See page 80)

To retry the incomplete file, print a File List first to verify the file number. (See page 160)  
Then, follow the steps below.

### 1

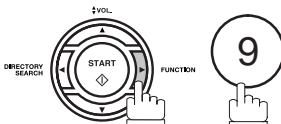

```
EDIT FILE MODE (1-6)
ENTER NO. OR v ^
```

### 2

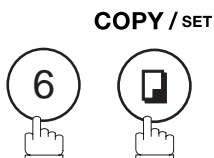

```
ENTER FILE NO. OR v ^
FILE NO. =■■■
```

### 3

Enter the file number or use ▼ or ▲ to select the file that you want to retry.

Ex: 0 0 1

```
ENTER FILE NO. OR v ^
FILE NO. =001
```

### 4

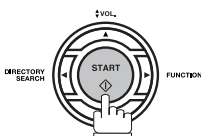

Your machine will retry the file and start dialling immediately.

```
* STORE * NO.001
<01>(Station name)
```

```
* DIALLING * NO.00
(Station name)
```

### NOTE

- To confirm or change the entered telephone number for the file, see page 160 and 162.
- If you set Fax Parameter No.31 to Valid, all incomplete files will remain in the memory. To avoid memory overflow, please check the memory content frequently. We recommend that optional flash memory card is installed when this function is used. (See page 242)

# Access Code

## General Description

The Access Code prevents an unauthorized user from operating the machine. Once a 4-digit Access Code is registered, no one can operate the machine without entering the correct access code.

Automatic Receiving, however, is always available. After you complete any operation, such as mode setting or transmission, and the display returns to standby, you have to re-enter the access code in order to use the machine again. Registering the Access Code does not affect the use of the machine in any other way.

## Setting the Access Code

1

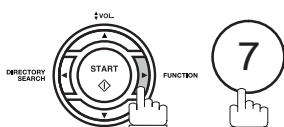

SET MODE (1-8)  
ENTER NO. OR ∨ ^

2

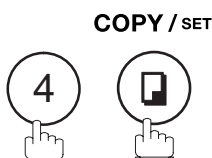

FAX PARAMETER (1-174)  
NO. = ■

3

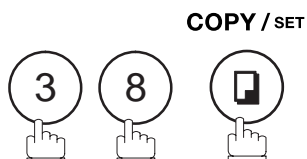

38 ACCESS CODE ■■■■

4

Enter a 4-digit Access Code.  
Ex: ① ② ③ ④

38 ACCESS CODE 1234

5



38 ACCESS CODE  
1:ALL 1234

6

Select Restriction Level.  
① for All operations  
or  
② for Setting and Printing the Fax Parameters only.  
Ex: ②

38 ACCESS CODE  
2:PARAMETERS 1234

7

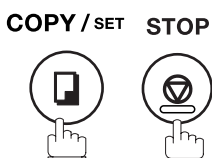

### NOTE

1. To erase the Access Code, enter the Access Code and press **SET** and follow the procedure above to step 3, then press **CLEAR**, **SET** and **STOP**.



## Operating Your Machine with the Access Code (Restrict all Operations)

**1** Enter the Access Code.  
Ex: ① ② ③ ④

MAR-12-2002 15:00  
ACCESS CODE=■

**2** COPY / SET  

MAR-12-2002 15:00  
ACCESS CODE=\*\*\*\*\*

MAR-12-2002 15:00  
00%

Now you can operate the machine normally.

## Operating Your Machine with the Access Code (Restrict Access of Fax Parameters Only)

The machine can restrict the operation of setting/printing the Fax Parameters only.  
EX: When setting the Fax Parameter.

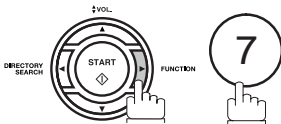
**1** 

SET MODE (1-8)  
ENTER NO. OR ∨ ^

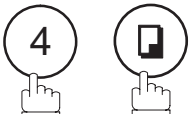
**2** COPY / SET  

ENTER ACCESS CODE  
■

**3** Enter a 4-digit Access Code.  
Ex: ① ② ③ ④

ENTER ACCESS CODE  
\*\*\*\*\*

**4** COPY / SET  

FAX PARAMETER(1-174)  
NO.=■

Now you can operate the machine normally.

# Receive To Memory

## General Description

This feature is used to secure all received documents by storing them into the memory. To print out the document from memory, the authorized operator must enter the correct password.

## Setting the RCV To Memory Password

1

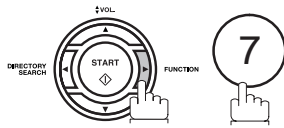

SET MODE (1-8)  
ENTER NO. OR V ^

2

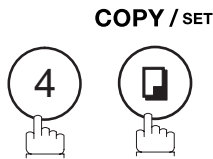

FAX PARAMETER(1-174)  
NO.=■

3

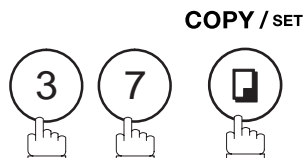

37 RCV TO MEMORY ■■■■

4

Enter a 4-digit RCV to Memory Password.

Ex: ① ② ③ ④

37 RCV TO MEMORY 1234

5

COPY / SET STOP

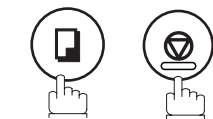

## Setting RCV To Memory

1

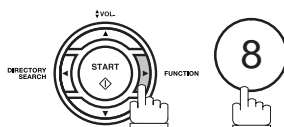

SELECT MODE (1-9)  
ENTER NO. OR V ^

2

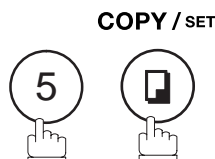

RCV TO MEMORY=OFF  
1:OFF 2:ON 3:PRINT

3



RCV TO MEMORY=ON  
1:OFF 2:ON 3:PRINT

4

COPY / SET



MAR-12-2002 15:00  
< RCV TO MEMORY >

### NOTE

1. When the memory overflows, the machine will stop receiving and release the line. The machine will not answer the next incoming call until there is space available in the memory.
2. We recommend that optional flash memory card is installed when this function is used. See 239 on Image Memory Capacity.

## Printing Out Documents

After receiving a document with the Receive To Memory feature, the following message will appear on the display.

```
MESSAGE IN MEMORY
< RCV TO MEMORY >
```

To print the document, follow the steps below.

**1**

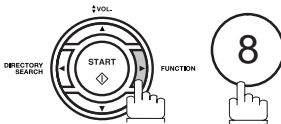

```
SELECT MODE (1-9)
ENTER NO. OR ∨ ^
```

**2**

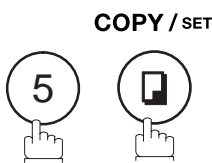

```
RCV TO MEMORY=ON
1:OFF 2:ON 3:PRINT
```

**3**



```
RCV TO MEMORY=PRINT
1:OFF 2:ON 3:PRINT
```

**4**



```
INPUT PASSWORD
```

**5**

Enter the password to print the documents.  
(See Note 1)

Ex: ① ② ③ ④

```
INPUT PASSWORD
1234
```

**6**

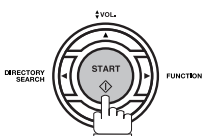

Machine will start to print the documents.

```
* PRINTING *
MEMORY RCV' D DOC
```

### NOTE

1. If the password has not been set, your machine will not prompt you to enter the password.
2. The documents will be printed immediately after pressing **SET** in step 4.
3. Once the RCV TO MEMORY feature is set to "On", the password cannot be changed (Fax Parameter No. 37 will not be shown on the LCD display). If you wish to change the password, set RCV TO MEMORY feature to "Off" first. Then change the password. (See page 170)

# Distinctive Ring Detector (DRD)

## General Description

This function is only effective for companies in countries which offer the DRD Service.

Your machine has a special feature in conjunction with an optional service provided by many local telephone companies. It can distinguish up to 2 telephone numbers with a corresponding ring pattern identifying each number. "DRD" lets you provide multiple phone numbers, one for your fax, business or personal use with only one single phone line.

Please check with your local telephone company on the availability of this service in your area.

Your machine can be programmed to respond to the specified ring pattern only for the DRD Service. To enable your machine to detect the ring pattern only for fax communication, change the setting of Fax Parameter No. 30 (See page 79).

The following table shows a typical example with 2 telephone numbers on a single phone line.

**Ex:** Specified Ring Pattern = Double Ring

Telephone No.	Usage	Distinctive Ring Sound	Ring Pattern
555-1111	Business	Riiing.....Riiing.....	Standard Ring
555-2222	Fax	Ring..Ring.....Ring..Ring.....	Specified Ring (Double Ring)

The following illustration shows a typical set up, with your machine set to detect Specified Ring (Double Ring).

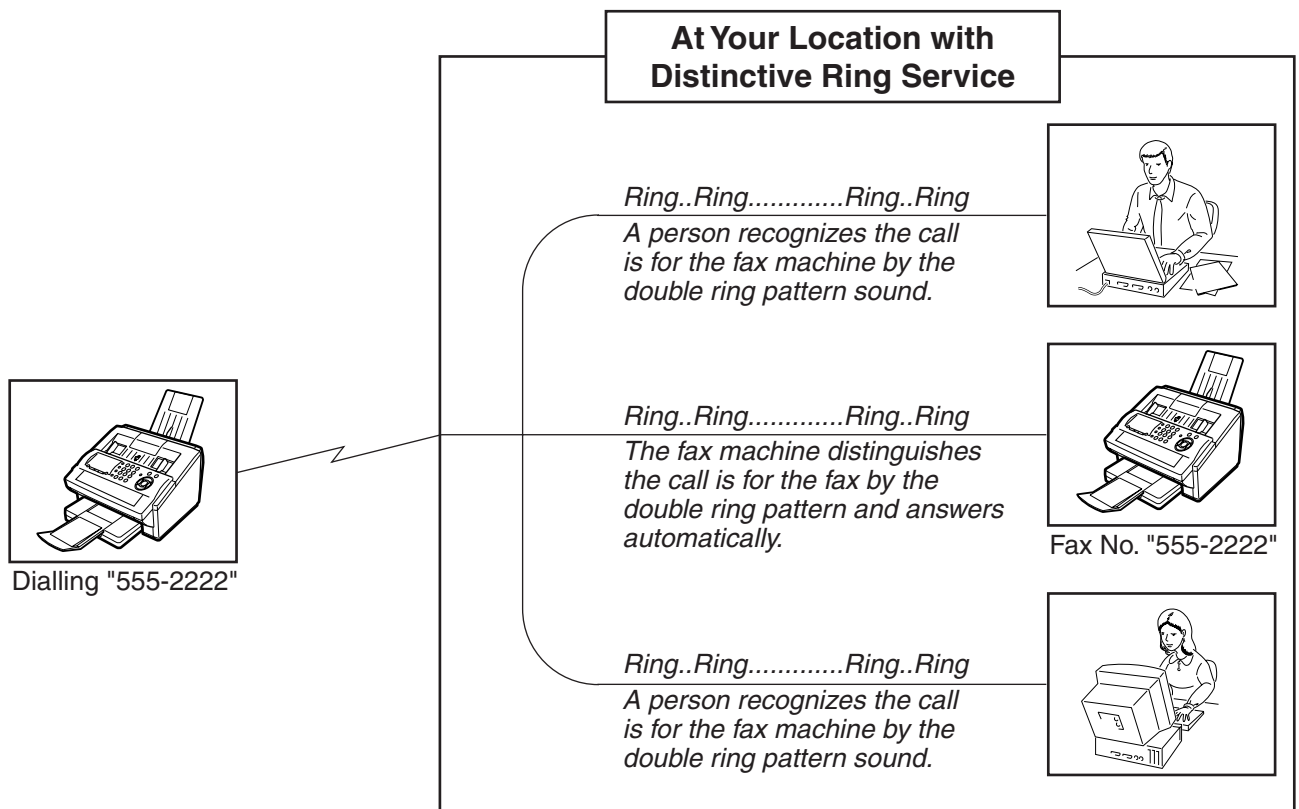

### NOTE

1. "Riiing" means a long ringing sound and "Ring" means a short ringing sound.
2. The specified ring pattern may differ depending on the each country's regulation or specification.

# Fax Cover Sheet

## General Description

A Fax Cover Sheet can be automatically attached to your transmit document(s) that shows the recipient's name, originator's name and the number of pages attached.

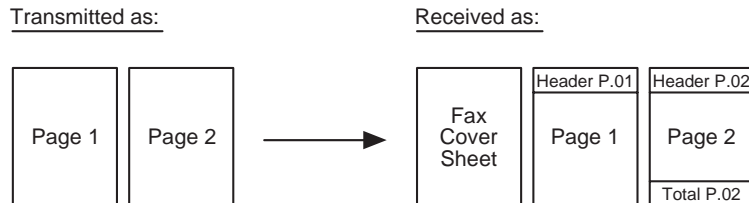

## To use the Fax Cover Sheet

To attach a Fax Cover Sheet to a transmission, follow the procedure below.

**1**



Set document(s) face down.

ENTER STATION(S)  
THEN PRESS START 00%

**2**

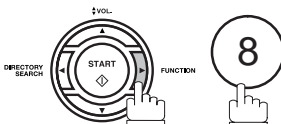

**COPY / SET**

SELECT MODE (1-9)  
ENTER NO. OR ∨ ^

**3**

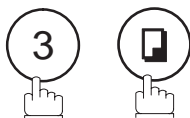

COVER SHEET=OFF  
1:OFF 2:ON

**4**



for "OFF" (Cover Sheet is not attached)

COVER SHEET=OFF  
1:OFF 2:ON

or



for "ON" (Cover Sheet is attached)

or

COVER SHEET=ON  
1:OFF 2:ON

**5**

**COPY / SET**



**6**

Dial the station(s) you wish to send the documents to.

Ex:

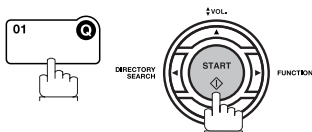

ENTER STATION(S)  
THEN PRESS START 00%

### NOTE

- To change the preset Fax Cover Sheet Setting, change the setting of Fax Parameter No. 56, see page 81.
- This function is available for memory or direct transmission modes.
- The Fax Cover Sheet is not counted in the number of pages column of the journals.

# Fax Cover Sheet

## To use the Fax Cover Sheet

### Fax Cover Sheet Sample

\*\*\*\*\* FACSIMILE COVER SHEET \*\*\*\*\*

**(1)**  
MAR-12-2002 15:00

**(2)**  
Message To:

SALES DEPT.

**(3)**  
Message From:

PANASONIC  
201 555 1212

**(4)**  
02  
Page(s)  
Following This Cover Page

### Explanation of Contents

- (1) Starting time of communication.
- (2) Recorded name in the One-Touch, ABBR. No. or dialled telephone number.
- (3) Your LOGO (up to 25 characters) and ID Number. (Up to 20 digits)
- (4) The number of pages to follow. This information is not shown when transmitting by Direct Transmission Mode.

# PIN Code Access

## General Description

If your PBX requires a PIN (Personal Identification Number) code to get an outside line, your machine can be set to prompt the user to enter a PIN code before any dialling.

## Selecting the Access Method (Prefix or Suffix)

1

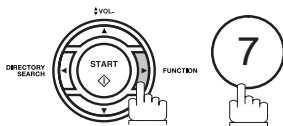

```
SET MODE (1-8)
ENTER NO. OR ∨ ^
```

2

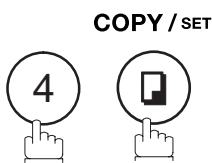

```
FAX PARAMETER (1-174)
NO. =■
```

3

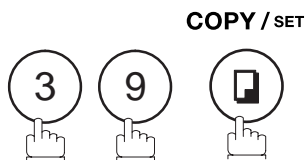

```
39 PIN CODE ACCESS
1:NONE
```

4

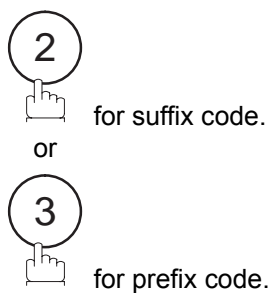

```
39 PIN CODE ACCESS
2:SUFFIX
```

or

```
39 PIN CODE ACCESS
3:PREFIX
```

5

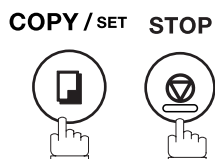

### NOTE

1. This feature is available in certain countries only.

# PIN Code Access

## Dialling with a PIN Code

1



Set document(s) face down.

ENTER STATION(S)  
THEN PRESS START 00%

2

Dial by any combination of the following methods:

- One-Touch Dialling
- Abbreviated Dialling
- Manual Number Dialling, press **SET** after each station is entered (Up to 70 stations)
- Directory Search Dialling, press **SET** after each station is entered (For details, see page 107 to 109.)

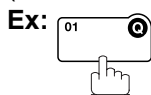

ABBR

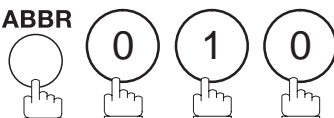

- If you want to confirm the number of stations you have entered, press **SET**.

<01>(Station name)  
5551234

[010](Station name)  
5553456

2 STN(S) ARE SET  
ADD MORE OR START

3

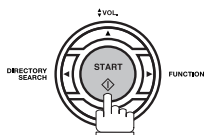

ENTER PIN CODE  
■

4

Ex: **9 8 7 6** (up to 36 digits)

ENTER PIN CODE  
9876■

5

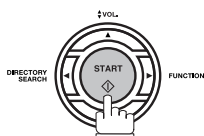

Your machine stores the document and starts dialling the PIN code and telephone number as you specified.

\* STORE \* NO.002  
PAGES=001 05%

\* DIALLING \* NO.00  
(Station name)

**NOTE**

1. The PIN code is shown as " ■ " on the display when dialling the number.
2. This feature is not available when dialling a number by using Off-Hook or On-Hook Direct Dialling mode.



# Fax Forward

## Setting Fax Forward

This feature allows all incoming faxes to be forwarded to the station registered in the one-touch or abbreviated dialling number. Once the faxes are received in the memory, the machine will forward the received document(s) to the telephone number registered in the one-touch or abbreviated dialling number.

This function is convenient when you would like to receive faxes in another place (i. e. your home) at night or during a holiday.

1

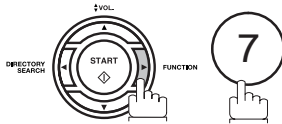

SET MODE (1-8)  
ENTER NO. OR ∨ ^

2

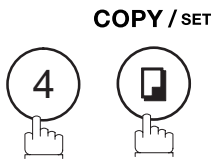

FAX PARAMETER(1-174)  
NO. =■

3

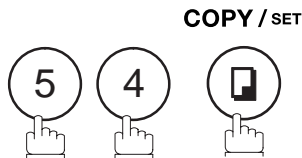

54 FAX FORWARD  
1:INVALID

4



54 FAX FORWARD  
2:VALID

5



54 FAX FORWARD  
ENTER STATION

6

Enter the station to forward the received faxes to, by assigning a one-touch key or an abbreviated dialling number.

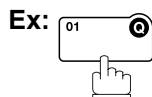

<01>(Station name)  
5551234

or

7

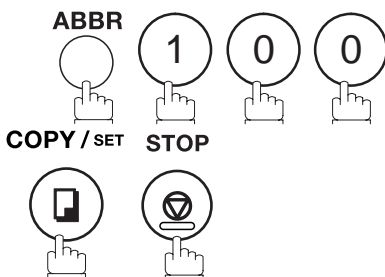

[100] (Station name)  
xyz@panasonic.com

### NOTE

- When the Fax Forward feature is set, the one-touch or the abbreviated dialling number is restricted from editing. Please change this function to "Invalid" when you would like to edit the telephone number.
- If the communication to transfer a received document(s) fails, the received document will print out and then is erased from memory even if the Fax Parameter No. 31 (INC. FILE SAVE) is set to "Valid".  
If you wish to save the document into memory in case of communication failure, set your machine to Receive To Memory. (See page 170)
- It is not possible to receive a document if the memory of your machine overflows or is about 95% used.

# Ifax Return Receipt

## General Description

Your machine automatically sends an Ifax Return Receipt to the sender confirming email reception from another Panasonic Internet Fax.

To disable this feature, follow the steps below.

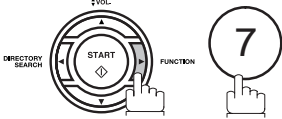
- 

1

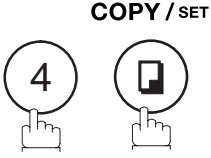
SET MODE (1-8)  
ENTER NO. OR ∨ ^
- 

2

COPY / SET

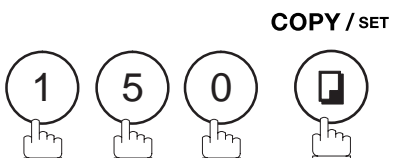
FAX PARAMETER(1-174)  
NO.=■
- 

3

COPY / SET

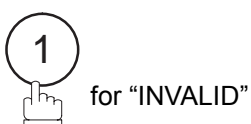
150 IFAX RET RECEIPT  
2:VALID
- 

4

1 for "INVALID"

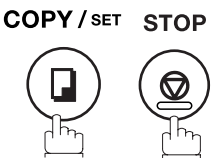
150 IFAX RET RECEIPT  
1:INVALID
- 

5

COPY / SET STOP

### NOTE

1. Your machine sends the Ifax Return Receipt only when receiving from another Panasonic brand Internet Fax. It will not confirm email sent from a PC. (The default setting for this parameter is "2:VALID".)

# Network Scanner

## General Description

You can import Fax images by using your machine transmission function.  
Storing a specific email address into a One-Touch Key/Program Key allows you to import picture images by pressing a single key.

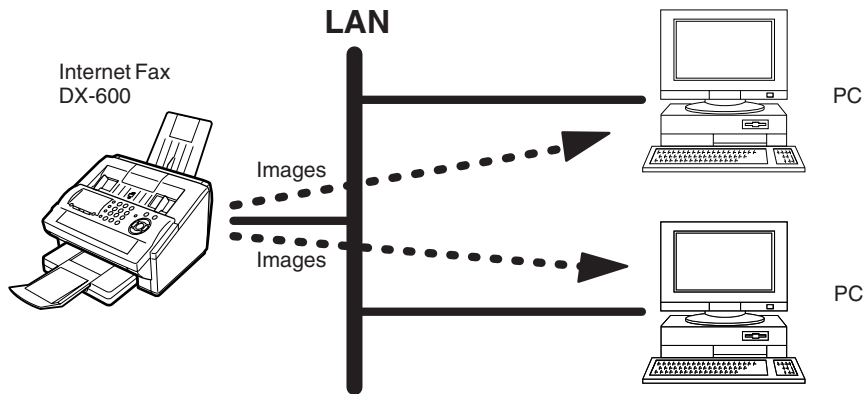

1



Set document(s) face down.

ENTER STATION(S)  
THEN PRESS START 00%

2

To improve the scanning quality, you can temporarily change the Resolution to "S-FINE" and if you are scanning color photographs or illustrations with gray tones, change the Halftone setting to "PHOTO".

3

Dial by any combination of the following methods:

- One-Touch Dialling
- Abbreviated Dialling
- Directory Search Dialling
- Manual Number Dialling

4

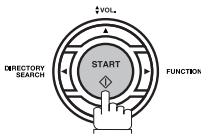

# Network Printer

## General Description

Your machine allows you to print documents created on your PC using various software applications.

To be able to use this function, install the Printer Driver and LPR software downloaded from the web site first. (See page 26)

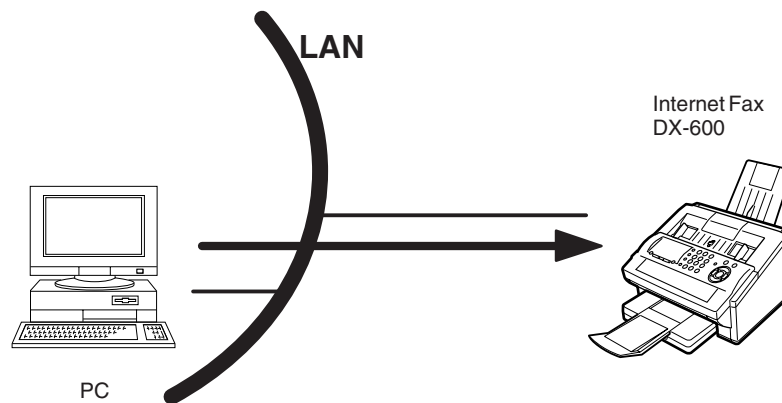

- 1** Select your machine as your default printer on the PC.
- 2** From any software application, instruct your PC to print to your machine.
- 3** Your machine receives and prints the document.

### NOTE

- The IP Address, Subnet Mask and Default Gateway IP Address (TCP/IP Gateway Address) must be programmed on your machine to use as a Network Printer.*

# Relayed Transmission

## General Description

The Internet Relayed Transmission feature can save you time and transmission costs if you need to send the same documents to multiple G3 fax machines.

This is especially true if the transmissions are long distance.

You can send documents to any G3 fax machine by using the Internet via a LAN from your machine to another Relay Station.

You can also send an email with attached TIFF-F file(s) to any G3 fax machine from your PC using your current email application through a Relay Station.

To use the Internet Relayed Transmission, the Relay Station must be set up properly.

### Example 1: Internet Relay Transmission

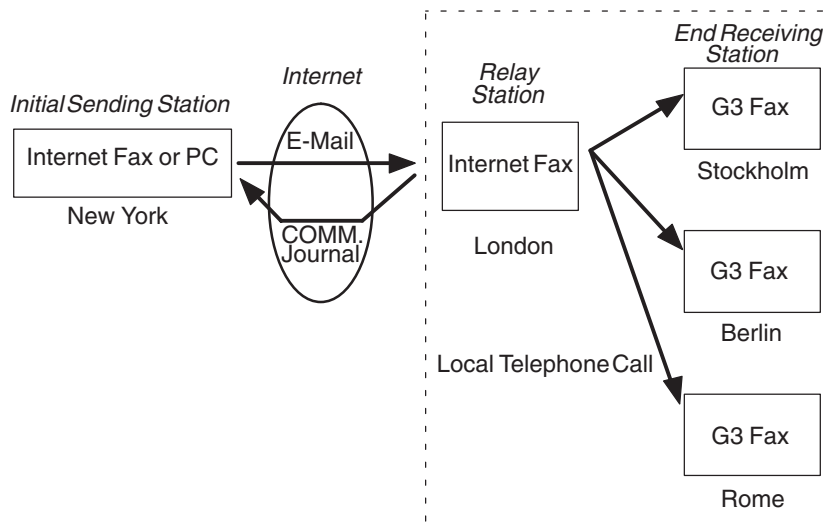

From your PC or your machine you can send documents to a Relay Station with the telephone number of the End Receiving Station(s).

After the Relay Station completes its transmission to the End Receiving Station, your PC or your machine receives a COMM. Journal from the Relay Station. This COMM. Journal confirms whether the Internet Relayed Transmission was successful.

### Example 2: Fax Server (Intranet Relay Transmission)

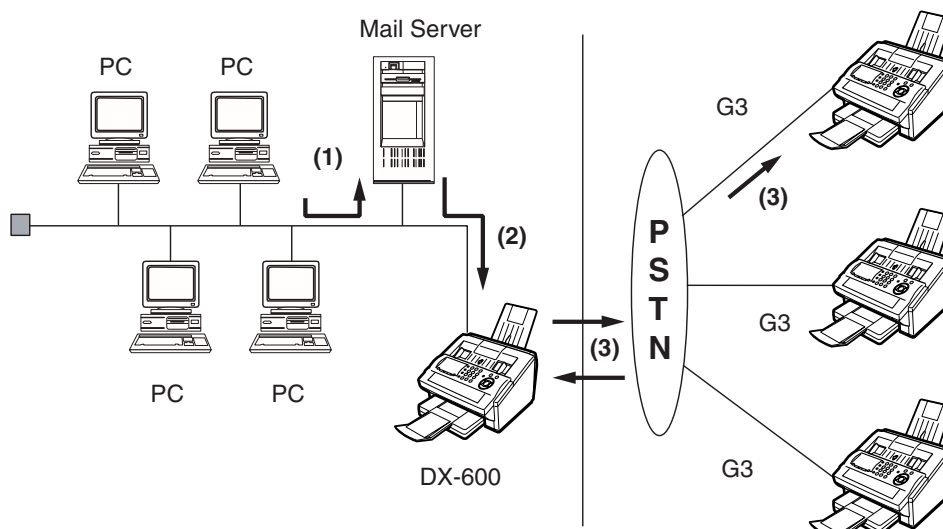

(1) Initiate a Relay Transmission via email to the Mail Server

(2) Mail Server transfers the email to your machine with relay instructions to transmit to a G3 machine

(3) Your machine initiates a telephone call to a G3 machine and transmits the document

# Relayed Transmission

## Relay Network

This Feature saves you time and long distance phone line costs when sending an Internet Fax directly from your machine to the end receiving station(s).

A Relay Network is basically composed of an Originating Station, which can be an Internet Fax Machine (your machine) or a PC, a Relaying Internet Fax Machine (another machine), and End-receiving station(s), which can be regular G3 Fax machines.

By simply sending a Document(s) from your machine or an email message from a PC, to the Relay Machine, which is then transmitted by your machine to the end receiving station(s) using regular phone lines as a normal G3 Fax message. (PC can have TIFF-F or text (.txt) file attachment)

The end receiving station(s) are usually local in relation to the Relay Station, which incurs a local telephone charge for the Fax Transmission.

After the Relay Station completes its transmission to the end receiving station(s), a Communication Journal is sent back to the originator from the Relaying Internet Fax confirming whether the Internet Relayed Transmission was successful. Any Relay activity information is sent by email from the Relaying Internet Fax to its Manager's Email Address, which is programmed in the Relaying Internet Fax machine's User Parameters. (See page 50)

To use the Internet Relayed Transmission, just follow the set up procedure described on pages 184 to 193 and obtain certain information provided by the Relaying machine operator. A sample network is shown in Figure 1.

Figure 1 shows a sample network as seen from **New York (Initiating Station)**, **London and Singapore are (Relay Stations)** connected to New York, and the **(End Receiving Stations)** are **Stockholm, Rome, Tokyo, Hong Kong, and Sydney**.

With this simple network using two Relay Stations, you can send a document with one operation to any combination of stations in the network via the London Relay Station and/or Singapore Relay Station.

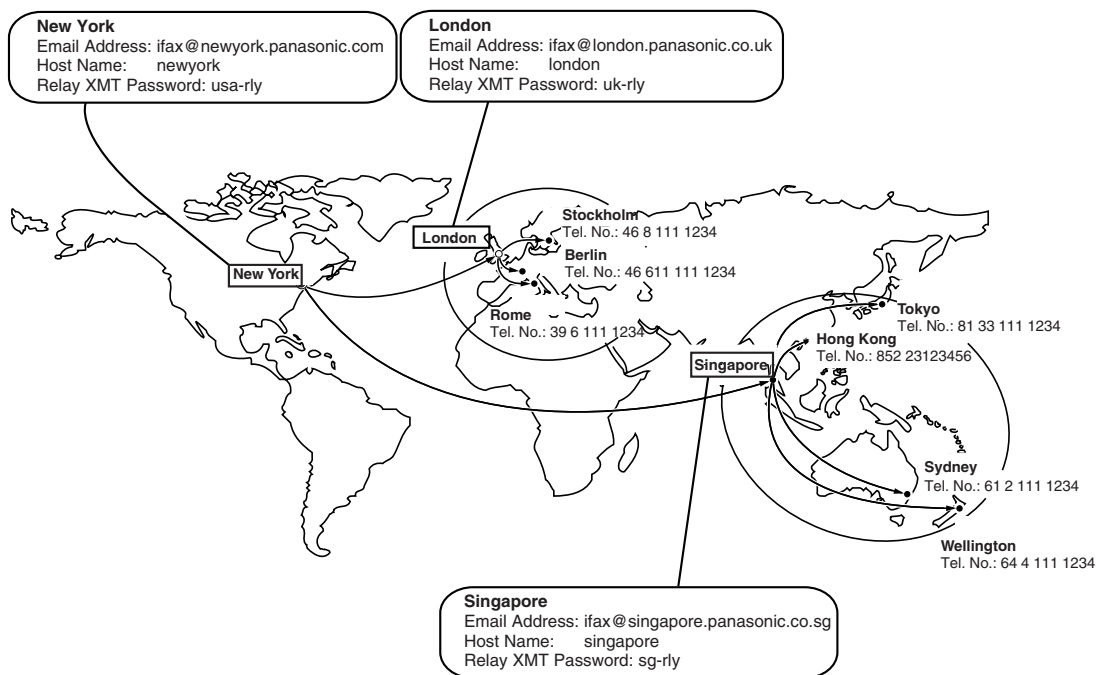

Figure 1 : Sample Network

## Relay Network

Table 2, 3 and 4 are sample settings for the Sample Network shown in Figure 1.

**Table 2 : Sample Parameter and Phone Book Dialling Number Table for New York (Originating Station)**

Telephone Number : 212 111 1234  
 Email Address(SMTP) : ifax@newyork.panasonic.com  
 Host Name : newyork  
 Relay XMT Password : usa-rly

Station Name	Email Address / Telephone Number	Relay Station Address
London	ifax@london.panasonic.co.uk	---
Stockholm	46 8 111 1234	[London Relay]
Singapore	ifax@singapore.panasonic.co.sg	---
Tokyo	81 33 111 1234	[Singapore Relay]
London Relay	uk-rly@london.panasonic.co.uk	---
Singapore Relay	sg-rly@singapore.panasonic.co.sg	---
Rome	39 6 111 1234	[London Relay]
Hong Kong	852 23123456	[Singapore Relay]
Sydney	61 2 111 1234	[Singapore Relay]

**Table 3 : Sample Parameter and Phone Book Dialling Number Table for London (Relaying Station)**

Telephone Number : 71 111 1234  
 Email Address(SMTP) : ifax@london.panasonic.co.uk  
 Host Name : london  
 Relay XMT Password : uk-rly

Station Name	Email Address / Telephone Number	Relay Station Address
New York	ifax@newyork.panasonic.com	---
Stockholm	46 8 111 1234	[London Relay]
Singapore	ifax@singapore.panasonic.co.sg	---
Tokyo	81 33 111 1234	[Singapore Relay]
Singapore Relay	sg-rly@singapore.panasonic.co.sg	---
Rome	39 6 111 1234	[London Relay]
Hong Kong	852 23123456	[Singapore Relay]
Sydney	61 2 111 1234	[Singapore Relay]
London Relay	uk-rly@london.panasonic.co.uk	---

**Table 4 : Sample Parameter and Phone Book Dialling Number Table for Singapore (Relaying Station)**

Telephone Number : 65 111 1234  
 Email Address(SMTP) : ifax@singapore.panasonic.co.sg  
 Host Name : singapore  
 Relay XMT Password : sg-rly

Station Name	Email Address / Telephone Number	Relay Station Address
London	ifax@london.panasonic.co.uk	---
Stockholm	46 8 111 1234	[London Relay]
New York	ifax@newyork.panasonic.com	---
Tokyo	81 33 111 1234	[Singapore Relay]
London Relay	uk-rly@london.panasonic.co.uk	---
Rome	39 6 111 1234	[London Relay]
Hong Kong	852 23123456	[Singapore Relay]
Sydney	61 2 111 1234	[Singapore Relay]
Singapore Relay	sg-rly@singapore.panasonic.co.sg	---

### NOTE

1. The Relay XMT Password must be registered for your machine to work as a Relay Station. (See page 185)
2. To prevent unauthorized stations from accessing your Relay Station for Internet Relayed Transmissions, you must setup your network security. Enter acceptable Domain Name(s) and the Manager's Email Address for notification of all Internet Relayed Transmissions. (See page 184)

# Relayed Transmission

## Setting up your machine as an Internet Relay Station

To set up your machine as a Relay Station, the following parameters must be set properly.

### 1. Relay XMT (Fax Parameter No. 142)

Selecting whether the machine will accept and performs G3 relayed transmission. (See page 81)

- 1) **Invalid** - Machine will not accept a Relay XMT request.
- 2) **Valid** - Machine will accept a Relay XMT request.

### 2. Relay XMT Report (Fax Parameter No. 143)

Selecting how the COMM. Journal for relayed transmission is sent to the originator.

- 1) **Off** - Do not send
- 2) **Always** - The COMM. Journal is always sent after a Relay Communication is completed or has failed.
- 3) **Inc. Only** - The COMM. Journal is sent if the Relay Communication to the destination has failed.

### 3. Relay XMT Password (User's Parameter) (See Note 1)

Enter a Relay XMT Password (up to 10 characters) to be used for protection against unauthorized (outside) stations from accessing your machine to relay messages to a G3 fax machine via PSTN. This password should be given out to authorized people only.

### 4. Relay Address (Auto Dialler)

Enter a 3-digit Abbreviated Number which will assign the Relay Email Address of the Relay Station your machine will use.

### 5. Manager's Email Address (User's Parameter)

Register the Department Manager's Email Address for supervision and cost control purposes. Once registered, the machine will send an email notification to this email address for each Relayed XMT Request received from a remote station. The following information is sent.

*(From : The email address of the originating station.)*

*(To : The telephone number of the destination G3 fax machine.)*

### 6. Domain Names (User's Parameter) (See Note 2)

Register up to 10 Domain Names (up to 30 characters) that your machine will accept Relayed Transmission Requests to relay a message to another G3 fax machine via PSTN.

**Ex:** Registered Domain Names

- (01): rdnn.mgcs.co.jp
- (02): rdmg.mgcs.co.jp
- (03): panasonic.com

In the example above, the Relayed XMT Request will be accepted only from the email addresses that include the Domain Name of rdnn.mgcs.co.jp, rdmg.mgcs.co.jp or panasonic.com.

#### NOTE

1. This should be different than your machine's Email Address used to receive regular email / Internet Fax, as your machine's Email Address is always included in the header of all email messages sent. So, anyone receiving an Internet Fax from the machine will easily know the Relay XMT Password if it is the same as the Email Address.
2. If all the Domain Names are left blank, the Internet Fax will accept Relayed XMT Requests from any domain.



## Setting Up Your Machine for Relayed Transmission

### Programming the End Receiving Station into your Auto Dialler

If the Fax Parameter No. 140 (LAN RELAY XMT REQUEST) is set to "Valid", you can enter the Relay Address (ABBR No.) by the following procedure.

#### To set a One-Touch/ABBR for Relayed Transmission Request

**1**

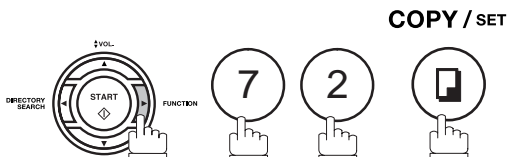

```
1:ONE-TOUCH
2:ABBR NO.
```

**2**



Ex:

```
ONE-TOUCH< >
PRESS ONE-TOUCH
```

**3**

Press a One-Touch key (01 - 28).

Ex:



```
<01>
ENTER EMAIL ADDRESS
```

**4**

To change the input mode (between "ENTER EMAIL ADDRESS" and "ENTER TEL. NO."),



press

```
<01>
ENTER TEL. NO.
```

**5**

Enter the telephone number (up to 36 digits).

If the Relay and the End Receiving Stations are both in the same area, omit the Country Code and the Area Code from the End Receiving Station. The End Receiving Station is a local telephone number as viewed from the Relay Station.

```
<01>
3961111234█
```

**6**

**COPY / SET**



```
<01>ENTER NAME
3961111234
```

**7**

Enter the station name by using the character keys (up to 15 characters).

Ex: R O M E

```
<01> ROME█
3961111234
```

**8**

**COPY / SET**



```
<01> RELAY ADDRESS
█
```

# Relayed Transmission

## Setting Up Your Machine for Relayed Transmission

**9** Enter the 3-digit Abbreviated number of the Relay Station that you want to assign to this End Receiving Station.

The Abbreviated number must contain the Relay XMT Password of the Relay Station.

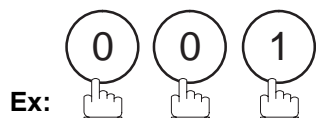

```
<01> RELAY ADDRESS  
                                001
```

**10** COPY / SET 

```
ONE-TOUCH< >  
PRESS ONE-TOUCH
```

You can now set an additional One-Touch/Abbreviated numbers for Relayed Transmission Request by repeating the procedures from Step 3 to 8, or return to standby by pressing **STOP**.

## Sending Documents via Internet Relay

Once you have recorded all the necessary parameters in your machine, you can send a document to one or multiple G3 fax machines automatically through the Internet Relay Station by using the procedure described below. The Internet Relay Station must have all the necessary parameters setup.

### To a Location That Has a Pre-programmed Relay Station

1



Set document(s) face down.

```
ENTER STATION(S)
THEN PRESS START 00%
```

2

Enter only the telephone number(s) of the End Receiving Station(s) using any combination of the following methods:

- One-Touch Dialling
- Abbreviated Dialling
- Manual Number Dialling (up to 70 stations), press **SET** after each station is entered. (see Note)
- Directory Search Dialling, press **START** after each station is entered (For details, see pages 91 to 94.)

```
<02> STOCKHOLM
4681111234
```

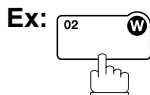

3

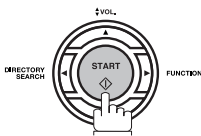

The document(s) is stored into memory and your machine starts sending the document(s) to the Relay email address of the Relay Station with the telephone number for the End Receiving Station.

**Ex:** End Receiving Station: 4681111234  
(Telephone number)  
[see Note 1]

Relay Station : uk-rly@london.panasonic.co.uk

After the Relay Station completes its transmission to the End Receiving Station(s), your machine receives a COMM. Journal from the Relay Station.

This Journal confirms whether the Internet Relayed Transmission was successful.

```
* STORE * NO.002
PAGES=001 05%
```

```
* STORE * COMPLETED
TOTAL PAGES=005 25%
```

```
ON LINE *MEM.XMT*
ID:uk-rly#4681111234
```

### NOTE

1. If the Relay Station requires a special access number to get an outside line, enter that access number first then press **PAUSE** to enter a pause (represented by a "-") before entering the full number.

# Relayed Transmission

## Sending Documents via Internet Relay

### To a Location That Does Not Have a Pre-programmed Relay Station

1



Set document(s) face down.

```
ENTER STATION(S)  
THEN PRESS START 00%
```

2

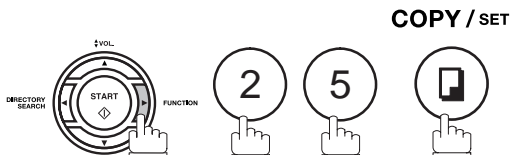

COPY / SET

```
RELAY XMT  
ENTER RELAY STATION
```

3

Assign a Relay Station by either one of the following methods.

- Manual Dialling (press the **INTERNET** key first, then enter the email address for the Relay Station)
- One-Touch Dialling
- Abbreviated Dialling
- Directory Search Dialling  
(For details, see pages 91 to 94.)

```
[001]LONDON RELAY  
uk-rly@london.panas
```

Ex: **ABBR** 0 0 1

```
RELAY XMT  
ENTER STATION(S)
```

4

Enter only the telephone number(s) of the End Receiving Station(s) using any combination of the following methods:

- One-Touch Dialling
- Abbreviated Dialling
- Manual Number Dialling (up to 70 stations), press **SET** after each station is entered. (see Note)
- Directory Search Dialling, press after each station is entered  
(For details, see pages 91 to 94.)

Ex: 02 

```
<02> STOCKHOLM  
4681111234
```

## Sending Documents via Internet Relay

# 5

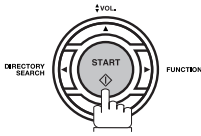

The document(s) is stored into memory and your machine starts sending the document(s) to the Relay email address of the Relay Station with the telephone number for the End Receiving Station.

**Ex:** End Receiving Station: 4681111234

(Telephone number)

[see Note 1]

Relay Station : uk-rly@london.panasonic.co.uk

After the Relay Station completes its transmission to the End Receiving Station(s), your machine receives a COMM. Journal from the Relay Station.

This Journal confirms whether the Internet Relayed Transmission was successful.

```
* STORE *      NO.002
      PAGES=001 05%
```

```
* STORE * COMPLETED
TOTAL PAGES=005 25%
```

```
ON LINE *MEM.XMT*
ID:uk-rly#4681111234
```

### NOTE

1. If the Relay Station requires a special access number to get an outside line, enter that access number first then press **PAUSE** to enter a pause (represented by a "-") before entering the full number.
2. The "#" character is not available for the email address of the relay station.

# Relayed Transmission

## Sending Document(s) from a PC to a G3 Fax Machine

Using your email application, you can send any document(s) from your PC as a TIFF-F attachment to one or multiple G3 fax machines automatically through the Internet Relay Station.

The Internet Relay Station (your machine) must be properly setup with all the required parameters.

To send a Relayed Transmission from your PC using your email application, follow the example below.

**Ex:** In the "To:" box of your email application, type the following:

sg-rly#81331111234@singapore.panasonic.co.sg

or

sg-rly#\*001@singapore.panasonic.co.sg

- Relay XMT Password:sg-rly
- # + End Receiving Station (with Phone Number): #81331111234 (see Note 1)
- # \*+ End Receiving Station (with Abbreviated Dialling Number): #\*001 - #\*100 (see Note 1)
- # \*+ End Receiving Station (with One-Touch Number): #\*1001 - #\*1028 (see Note 1)
- # \*+ End Receiving Station (with Program Key as a Group Dialling): #\*2001 - #\*2004 (see Note 1)
- @ + Relay Station's Domain Name: @singapore.panasonic.co.sg

Your PC sends the text document(s) to the Relay email address of the Relay Station with the telephone number of the End Receiving Station.

After the Relay Station completes its transmission to the End Receiving Station(s), your PC receives a COMM. Journal from the Relay Station. This Journal confirms whether the Internet Relayed Transmission was successful.

### NOTE

1. The "#" and "\*" symbol must be entered after the Relay XMT Password as it indicates to your machine that a phone number for the End Receiving Station will follow.
2. If the Relay Station requires a special access number to get an outside line, enter that access number first then enter a hyphen (represented by a "-") before entering the full number.

### Sending Document(s) from a PC to a G3 Fax Machine

**A TIFF Converter** software is used on your PC to convert document(s) into a "TIFF" file format, which allows the Internet FAX to receive the document as an attachment to an email. When you are sending a detailed graphic document(s) to a DP-1810F/2000/2500/3000, DX-600/800/1000/2000, you can specify 400 dpi resolution for better clarity.

**Ifax Mailer** software is an add-in program for the TIFF Converter that links the email client for MAPI to the TIFF converter for the Internet FAX.

To send a printing image as email from the application to the Internet FAX, you have to convert the file into the format that the Internet FAX is allowed to receive and print as an email using the TIFF file creation function. You also have to send that file to the Internet FAX as an attached document.

Ifax Mailer, allows you to automatically create TIFF files by pressing one button from the TIFF Converter for the Internet FAX.

You can download the Panasonic's TIFF Converter and ifax Mailer software and their respective User's Guides from any of the following URL addresses.

<http://www.panasonic.co.jp/mgcs/internetfax/>

<http://www.panasonic.com/internetfax>

To simplify the Relay Transmission operation, Panasonic has an Optional Panafax Fax Gateway software. Please visit the following URL address for more details:

<http://www.panasonic.com/office>

# Relayed Transmission

## Printouts and Reports

When you use Relayed Transmission, relay station will send the following two reports to help you check and keep track of your faxes.

### 1. Relay XMT Report (COMM. JOURNAL)

When the relay station finishes transmitting to the End Receiving Station, it will send a COMM. Journal to you when the Fax Parameter No. 143 is set to "Always" or "Inc. Only", this tells you whether the transmission was successful or not.

### 2. Transmission Journal

When the Relay Station receives instructions for a relayed transmission, a notification is emailed to the registered manager (see "Setting up Your machine as an Internet Relay Station" on page 184).

### Sample Relay XMT Report (COMM. JOURNAL)

```
***** -COMM. JOURNAL - ***** DATE 03-DEC-2002 **** TIME 15:00 *****

(1)                                (2)                                (3)

MODE = RELAYED TRANSMISSION        START=03-DEC 15:00        END=03-DEC 15:00

FILE NO.= 050 (4)

(5)    (6)                        (7)                                (8)    (9)

STN    COMM.    ONE-TOUCH    STATION NAME/EMAIL ADDRESS/TELEPHONE NO.    PAGES    DURATION
NO.    ABBR NO.
001    R-OK    STOCKHOLM    001/001    00:00:15
002    R-OK    ROMA    001/001    00:00:15

- PANASONIC -

***** - HEAD OFFICE - ***** - 201 555 1212 - *****
```

### Explanation of Contents

- (1) Indication of communication mode
- (2) Start time of communication
- (3) End time of communication
- (4) File number : 001 to 999
- (5) Sequential number of the stations
- (6) Communication result : "R-OK" indicates that the Relayed XMT Request was successful. 3-digit Info Code (see page 226) indicates that the communication has failed.
- (7) Telephone Number, Email Address or Station Name of the end receiving station
- (8) Number of pages transmitted : 3-digit number represents the number of pages successfully transmitted.
- (9) Duration of Communication

**NOTE**

1. If you transmit through more than one Relay Station, you will receive a separate Result Report.



## Printouts and Reports

### Sample Relayed Transmission Notification Email to a Manager

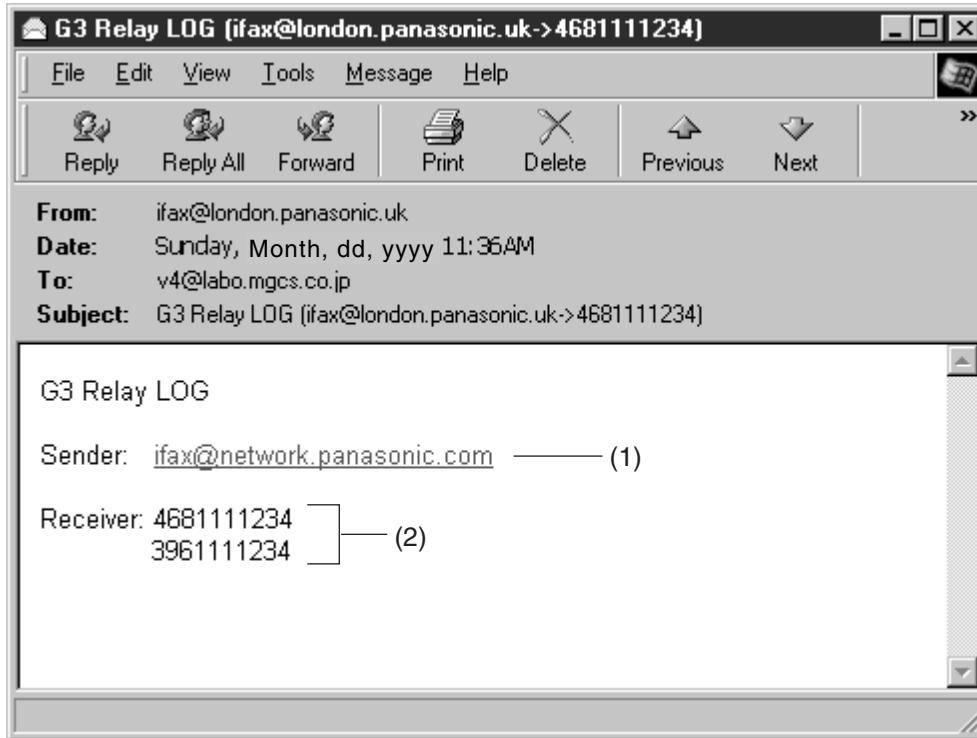

#### Explanation of Contents

- (1) Email address of the sender's Internet Fax (Your machine) or PC
- (2) End Receiving Station's G3 fax telephone number(s)

# Selective Reception

## General Description

Your machine has a special feature, Selective Reception, which can prevent the receiving of unnecessary documents (i.e. junk fax, direct mail, etc.).

Before receiving the document, the last 4 digits of the ID Number received from the sending machine will be compared with the last 4 digits of the telephone number programmed in each One-Touch or Abbreviated station. When a match is found, your machine will start receiving the document. If a match is not found, your machine will cancel the reception and an Information Code 406 will be recorded on the Journal.

## Setting the Selective Reception

1

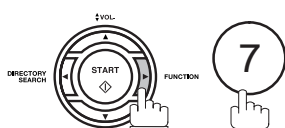

SET MODE (1-8)  
ENTER NO. OR ∨ ^

2

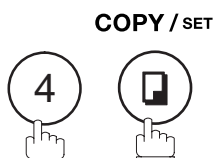

FAX PARAMETER(1-174)  
NO. = ■

3

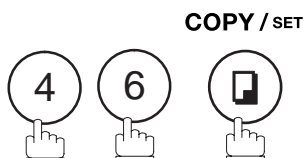

46 SELECT RCV  
1:INVALID

4



46 SELECT RCV  
2:VALID

5

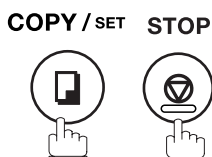

### NOTE

1. When the Selective Reception is set, your machine can receive only from those stations which are programmed in the built-in auto-dialler.
2. If your ID number has not been set, your machine might not be able to receive from some models. To set your ID number, see page 48.

# Password Communications

## General Description

Password Communications, including Password Transmission and Password Reception will prevent your machine from sending a fax to a wrong station or receiving a fax from an unauthorized stations. You can set Password Transmission and Password Reception independently, or both together.

To use Password Transmission, you must set a 4-digit transmission password in advance. The password must be shared with other compatible Panasonic machine(s). If the transmission password in your machine does not match the transmission password in the other compatible Panasonic machine(s), the transmission will fail. You can select password transmission by setting Fax Parameter No. 43 (PASSWORD-XMT) to **"ON"** when you send a document.

To use Password Reception, you must set a 4-digit receiving password in advance. The password must be shared with the other compatible Panasonic machine(s). If the password in your machine does not match the receiving password in the other compatible Panasonic machine(s), the reception will fail. Once you set password reception and set the parameter to **"ON"**, it stays until you change the setting to **"OFF"**.

## Compatibility with Other Machines

You can only use password transmission and reception with another Panasonic compatible machine(s) listed below.

- DF-1100
- DF-1810F
- DP-2000
- DP-2500
- DP-3000
- DP-3510
- DP-4510
- DP-6010
- DX-600
- DX-800
- FP-D250F
- FP-D350F
- UF-160
- UF-160M
- UF-170
- UF-260
- UF-270
- UF-270M
- UF-280M
- UF-300
- UF-312
- UF-322
- UF-550
- UF-560
- UF-585
- UF-590
- UF-595
- UF-650
- UF-733
- UF-744
- UF-745
- UF-750
- UF-750D
- UF-755
- UF-755e
- UF-766
- UF-770
- UF-788
- UF-790
- UF-880
- UF-885
- UF-890
- UF-895
- UF-990
- UF-M500

# Password Communications

## Setting Password Transmission

To set transmission password and parameter,

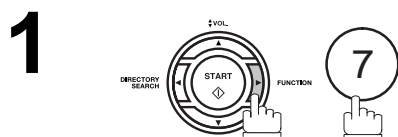

```
SET MODE          (1-8)
ENTER NO. OR V ^
```

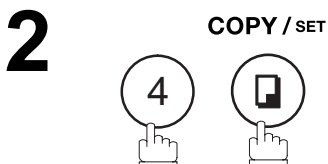

```
FAX PARAMETER(1-174)
NO.=■
```

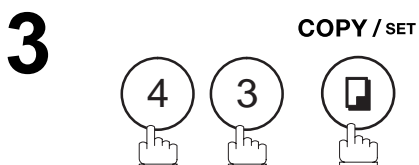

```
43 PASSWORD-XMT
```



```
43 PASSWORD-XMT
1:OFF          1234
```

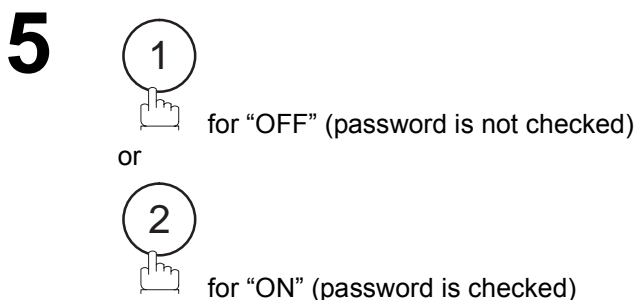

```
43 PASSWORD-XMT
1:OFF          1234
```

or

```
43 PASSWORD-XMT
2:ON          1234
```

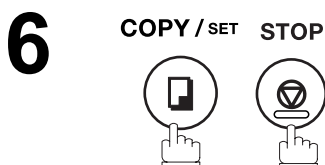

**NOTE**

1. You can change the setting temporarily by using FUNCTION 8-4 (PASSWORD-XMT) for each transmission. See page 198 for details.
2. To change the password, press **CLEAR** in step 4. Then re-enter a new one.

## Setting Password Reception

To set the receiving password and parameter,

**1**

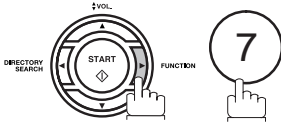

```
SET MODE          (1-8)
ENTER NO. OR ∨ ^
```

**2**

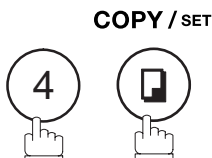

```
FAX PARAMETER(1-174)
NO.=■
```

**3**

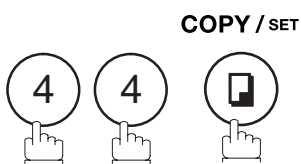

```
44 PASSWORD-RCV
```

**4**

Enter a 4-digit Receiving Password.

Ex: ① ② ③ ④ and press **SET**

```
44 PASSWORD-RCV
1:OFF          1234
```

**5**



for "OFF" (password is not checked)

or



for "ON" (password is checked)

```
44 PASSWORD-RCV
1:OFF          1234
```

or

```
44 PASSWORD-RCV
2:ON          1234
```

**6**

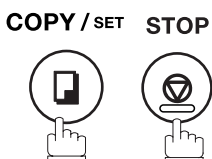

### NOTE

- Once you set the parameter, you cannot select the parameter, "OFF" or "ON", for each reception. It is always "OFF" or "ON" until you change the setting.
- To change the password, press **CLEAR** in step 4. Then re-enter a new one.

# Password Communications

## Using Password Transmission

To use Password Transmission, you can select PASSWORD-XMT "OFF" or "ON" for each Transmission by following the procedure below.

1



Set document(s) face down.

ENTER STATION(S)  
THEN PRESS START 00%

2

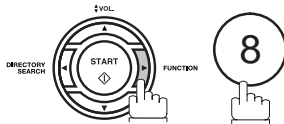

SELECT MODE (1-9)  
ENTER NO. OR V ^

3

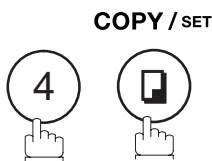

PASSWD-XMT=OFF  
1:OFF 2:ON

4

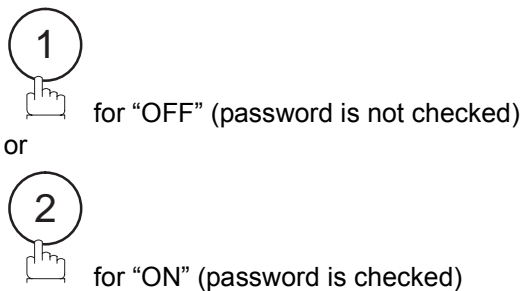

PASSWD-XMT=OFF  
1:OFF 2:ON

or

PASSWD-XMT=ON  
1:OFF 2:ON

5



ENTER STATION(S)  
THEN PRESS START 00%

6

Dial by any combination of the following methods:

- One-Touch Dialling
- Abbreviated Dialling
- Manual Number Dialling, press  after each station is entered (Up to 70 stations)
- Directory Search Dialling, press  after each station is entered (For details, see page 107 to 109.)

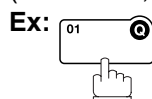

<01>(Station name)  
5551234

# 7

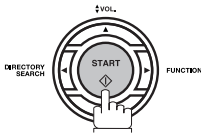

If your machine's Transmission Password coincides with the other station's Transmission Password, your machine starts sending the document.

When transmission is completed, PASSWORD-XMT returns to standard setting (**“OFF”** or **“ON”**).

## Using Password Reception

There is no additional operation required once you set the parameter by following the procedure on page 197. The parameter, **“OFF”** or **“ON”**, cannot be selected for each reception. It is always **“OFF”** or **“ON”** until you change the setting.

# Confidential Mailbox

## General Description

Your machine is equipped with two Confidential Communication features which ensure that the Confidential information you send is received only by the person with the correct confidential code.

## Confidential Mailbox

The confidential mailbox feature can be used as a mailbox to communicate with other compatible models using a 4-digit confidential code. The Confidential Mailbox feature receives document(s) with a confidential code into memory. These documents can only be printed by the person who has the correct confidential code.

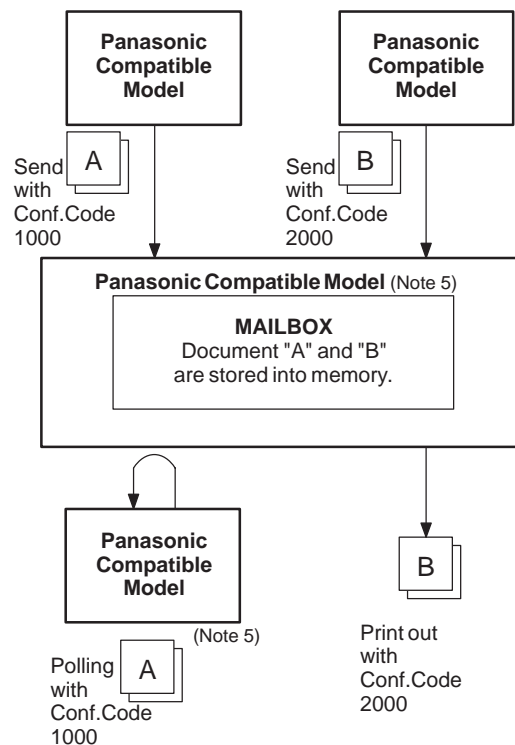

## Compatibility with Other Machines

Table 1 shows a list of compatible Panasonic models which have the Confidential Mailbox feature. It also shows whether or not special settings are required.

**Table 1 : Confidential Mailbox Requirement**

Compatible Model								Special Settings
DF-1100	DP-1810F	DP-2000	DP-2500	DP-3000	DP-3510	DP-4510	DP-6010	Not required.
DX-600	DX-800	UF-280M	UF-312	UF-322	UF-332	UF-333	UF-342	
UF-344	UF-550	UF-560	UF-585	UF-590	UF-595	UF-733	UF-744	
UF-745	UF-755	UF-755e	UF-766	UF-770	UF-788	UF-790	UF-880	
UF-885	UF-890	UF-895						

### NOTE

1. If your machine receives two confidential faxes with same confidential code, both documents are stored together in the same confidential mailbox.
2. Up to 10 Mailbox files can be stored in memory. So, you can receive the confidential fax using 10 different confidential codes.
3. If the memory overflows, the machine will stop receiving and release the line.
4. We recommend that optional flash memory card be installed when this function is used. See page 239 on Image Memory Capacity.
5. If confidential faxes were received in the mailbox of UF-733, you cannot poll those documents. The UF-733 is designed to print out the received confidential document locally only.



## Sending a Confidential Document to a Remote Station's Mailbox

**1**



Set document(s) face down.

ENTER STATION(S)  
THEN PRESS START 00%

**2**

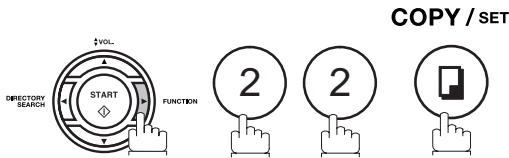

CONF. COMM. (1-5)  
ENTER NO. OR ∨ ^

**3**

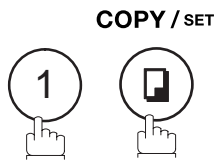

CONFIDENTIAL XMT  
CONF. CODE=■■■■

**4**

Enter a 4-digit Confidential Code.

Ex: ② ② ③ ③

CONFIDENTIAL XMT  
CONF. CODE=2233

**5**



ENTER STATION  
THEN PRESS START

**6**

Dial by any one of the following methods:

- One-Touch Dialling
- Abbreviated Dialling
- Manual Number Dialling
- Directory Search Dialling

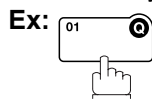

<01>(Station name)  
5551234

**7**

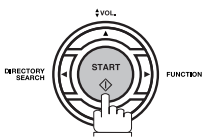

If necessary, inform the receiving person and tell them the Confidential Code.

# Confidential Mailbox

## Polling a Confidential Document from a Remote Station's Mailbox

After you have been informed that someone has transmitted a confidential document to a remote station's mailbox, you can poll the confidential document from the remote station by following the procedure below.

1

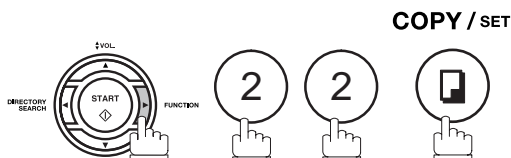

CONF. COMM. (1-5)  
ENTER NO. OR V ^

2

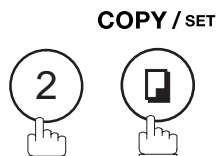

CONFIDENTIAL POLL  
CONF. CODE=■■■■

3

Enter a 4-digit Confidential Code.

Ex: (2) (2) (3) (3)

CONFIDENTIAL POLL  
CONF. CODE=2233

4

**COPY / SET**



ENTER STATION  
THEN PRESS START

5

Dial by any one of the following methods:

- One-Touch Dialling
- Abbreviated Dialling
- Manual Number Dialling
- Directory Search Dialling

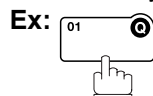

<01>(Station name)  
5551234

6

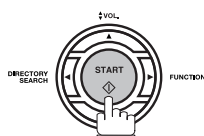

### NOTE

1. The confidential file will be erased automatically at the center station after being polled.

## Receiving a Confidential Document to Your Machine's Mailbox

No special setting is required, your machine comes with this feature ready to use. Your machine receives a confidential fax the same way it receives a normal fax message. When receiving the confidential fax, the display shows the following message (CONF. RCV REPORT) and prints out the Confidential Receive Report.

MESSAGE IN MAIL BOX

### Sample CONF. RCV Report

```

***** -CONF. RCV REPORT- ***** DATE 03-DEC-2002 ***** TIME 15:00 *****

** NOTICE OF CONFIDENTIAL DOCUMENT HELD **

(1)      (2)      (3)      (4)
FILE NO. RECEIVED FROM      PAGES      TIME RECEIVED

    040    PANAFAX              001          03-DEC 15:00

                                -PANASONIC              -

***** -HEAD OFFICE      - ***** -      201 555 1212- *****
    
```

### Explanation of Contents

- (1) File number : 001 to 999
- (2) Received remote station's ID : Character ID or Numeric ID
- (3) Number of pages received
- (4) Received date and time

### NOTE

1. If your machine receives two confidential faxes with same confidential code, both documents are stored together in the same confidential mailbox.
2. Up to 10 Mailbox files can be stored in memory. So, you can receive the confidential fax using 10 different confidential codes.
3. If the memory overflows, the machine will stop receiving and release the line.
4. You can verify whether the unit has received a confidential fax by printing out the File List. (See page 160)

# Confidential Mailbox

## Storing a Confidential Document in Your Machine's Mailbox

Use the following procedure to store a document in a confidential mailbox in your machine. Once the confidential document is stored in your machine, it can be polled by another machine.

1



Set document(s) face down.

```
ENTER STATION(S)  
THEN PRESS START 00%
```

2

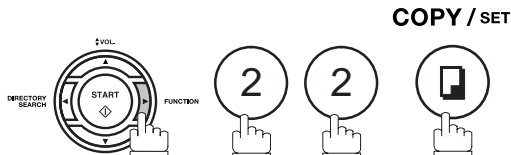

```
CONF. COMM. (1-5)  
ENTER NO. OR V ^
```

3

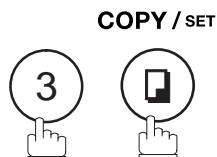

```
CONFIDENTIAL POLLED  
CONF. CODE=■■■■
```

4

Enter a 4-digit Confidential Code.

Ex: ② ② ③ ③

```
CONFIDENTIAL POLLED  
CONF. CODE=2233
```

5

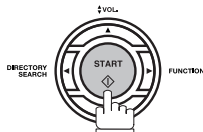

The document(s) will be stored into memory.

If necessary, inform the receiving party of the confidential document and tell them the confidential code needed to poll the document.

```
* STORE * NO.002  
PAGES=001 01%
```

### NOTE

1. The confidential file will be erased automatically after being polled.

If you wish to retain the confidential file even after being polled, change the setting of Fax Parameter No. 42 (CONF. POLLED FILE SAVE) to "Valid".

## Printing Out a Confidential Document from Your Machine's Mailbox

After you have been notified that someone has transmitted a confidential document to your machine's mailbox, use the following procedure to print out the confidential document.

### 1

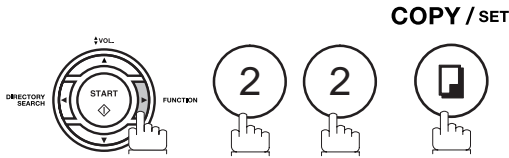

```
CONF. COMM.      (1-5)
ENTER NO. OR ∨ ^
```

### 2

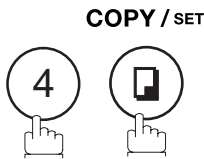

```
PRINT CONF. FILE
CONF. CODE=■■■■
```

### 3

Enter the Confidential Code of the document you want to print out.

Ex: (2) (2) (3) (3)

```
PRINT CONF. FILE
CONF. CODE=2233
```

### 4

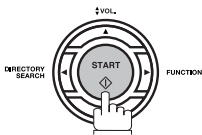

```
* PRINTING *
PAGE=001/001
```

The machine will print out the confidential documents.

#### NOTE

- The confidential file will be erased automatically after being printed out even if the setting of Fax Parameter No. 42 (CONF. POLLED FILE SAVE) is changed to "Valid".

# Confidential Mailbox

## Deleting a Confidential Document Stored in Your Machine's Mailbox

If your memory becomes full, or you just want to clean out your confidential documents, you may delete one or more confidential faxes stored in your machine by using the following procedure.

There are two types of confidential file deletions, one is to delete the file individually by its Confidential Code, and the other is to delete all confidential files in memory.

### To delete a file using Confidential Code

1

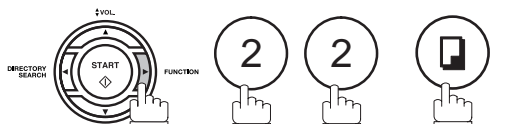

```
CONF. COMM. (1-5)
ENTER NO. OR v ^
```

2

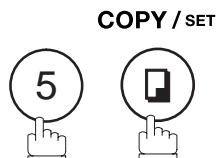

```
DELETE CONF. FILE
CONF. CODE=■■■■
```

3

Enter a 4-digit Confidential Code.

Ex: ② ② ③ ③

```
DELETE CONF. FILE
CONF. CODE=2233
```

4

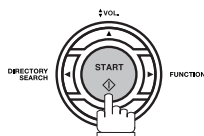

```
* DELETING *
CONF. CODE=2233
```

### To delete all confidential files in memory

1

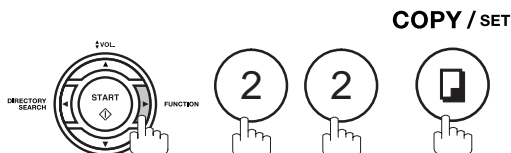

```
CONF. COMM. (1-5)
ENTER NO. OR v ^
```

2

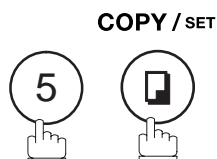

```
DELETE CONF. FILE
CONF. CODE=■■■■
```

3



```
DELETE ALL CONF.
FILES? 1:YES 2:NO
```

4



```
* DELETING *
ALL CONF. FILES
```

# Sub-addressing

## General Description

The Sub-Addressing function allows you further routing, forwarding or relaying of document(s) to the desired recipient(s) when used in combination with Panasonic Internet Fax capable models and/or the Networking version of HydraFax/LaserFAX software. This function conforms to the ITU-T recommendation for T. Routing-Facsimile Routing utilizing the Sub-Address.

### Example of a Network

Dial to: 555 1234  
Sub-address: 0001  
TSI: 555 9999

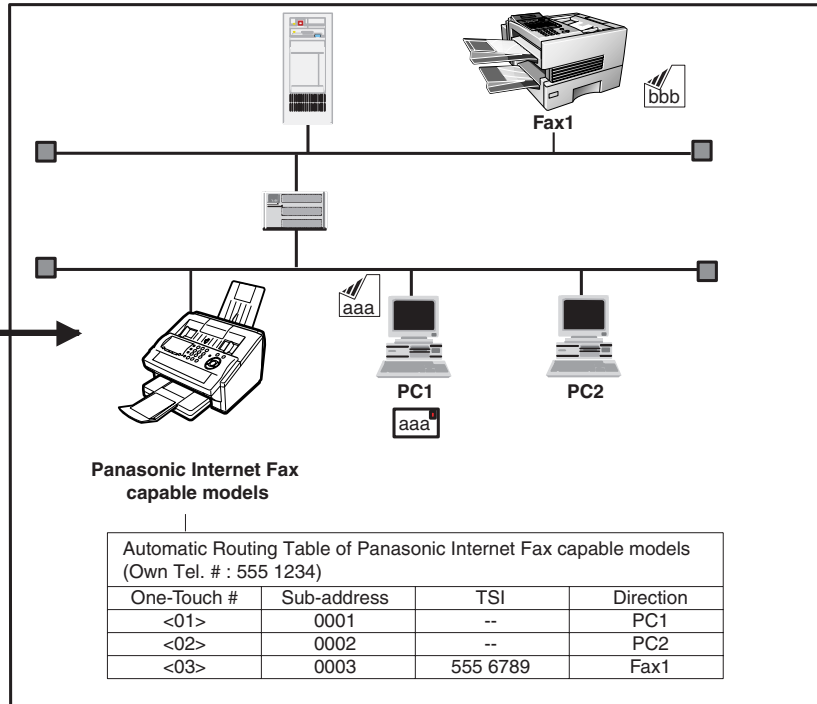
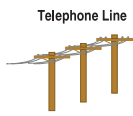
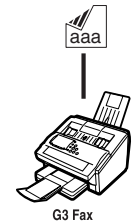

Dial to: 555 1234  
Sub-address: None  
TSI: 555 6789

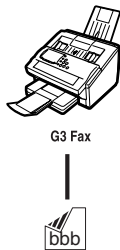

### Compatibility with Other Machines

- Sub-addressing Transmission: DF-1100/DP-135FP/150FP/150FX/DP-2000/2500/3000/DX--600/800/1000/2000/FP-D250F/D350F/UF-332/333/342/344/490/550/560/585/595/770/788/790/880/885/895 (see Note 2)
- Sub-addressing Reception: DX--600/800/1000/2000/DP-2000/2500/3000 with I-FAX Option and DF-1100/UF-342/344/550/560/585/595/770/788/880 with PC Interface using the Networking version of HydraFax/LaserFAX software.

### Sub-addressing Transmission Methods

You can send a document with Sub-address information to the desired recipient by the following methods.

- By registering the Sub-address information into One-Touch/ABBR. Dialling Numbers.
- By specifying the Sub-address information in the Manual Number Dialling Mode.

### Setting of Routing, Forwarding or Relaying

You can customize the Automatic Routing to any combination of LAN (Local Area Network), PSTN (Public Switched Telephone Network) or PBX Extension with Panasonic Internet Fax capable models and/or HydraFax/LaserFAX Routing Table (Please refer to the operating instructions of the applicable Panasonic models and/or the HydraFax/LaserFAX User Manual).

#### NOTE

1. HydraFax and LaserFAX are trademarks of Wordcraft International Ltd.
2. UF-788 with PC Interface Option or the Option ROM installed.

# Sub-addressing

## To set the Sub-address into a One-Touch/ABBR. Dialling Numbers

1

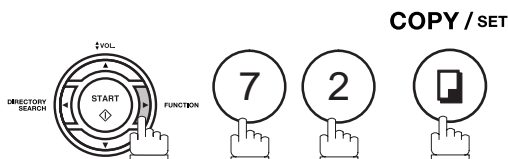

1:ONE-TOUCH  
2:ABBR NO.

2

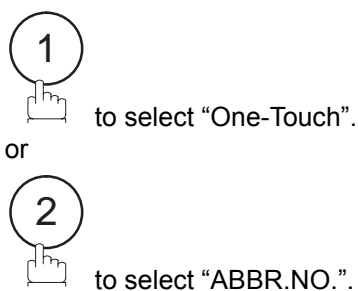

ONE-TOUCH< >  
PRESS ONE-TOUCH

3

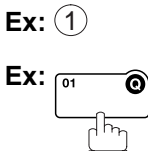

<01>  
ENTER TEL. NO.

4

Enter the telephone number, press **SUB-ADDR** then enter the Sub-address. (Up to 20 digits)  
(Up to 36 digits including telephone number, pauses, spaces, FLASH and Sub-address)  
Ex: Telephone number = 5551234, Sub-address =2762  
Enter as: ⑤ ⑤ ⑤ ① ② ③ ④  
**SUB-ADDR** ② ⑦ ⑥ ②

<01>  
5551234s2762■

5



Enter the station name. (See page 69)  
Ex: SALES DEPT

<01> SALES DEPT■  
5551234s2762

6

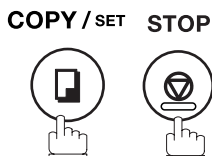

**NOTE**

1. **SUB-ADDR** separates the Sub-address from the Telephone number and is indicated by an "s" in the display.



## To send a Document with Sub-address

### Using One-Touch/ABBR. Number Dialling

The operation is the same as for normal dialling

1



Set document(s) face down.

```
ENTER STATION(S)
THEN PRESS START 00%
```

2

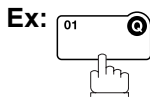

```
<01>(Station name)
5551234s2762
```

3

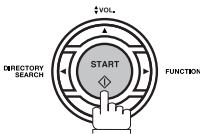

The document is stored into memory and your machine starts to dial the number of the station and sends the document(s) with Sub-addressing information.

```
* STORE *      NO.001
      PAGES=001  01%
```

### Using Manual Number Dialling

Use **FLASH** to separate the Telephone number and the Sub-address.

1



Set document(s) face down.

```
ENTER STATION(S)
THEN PRESS START 00%
```

2

Enter the telephone number, press **FLASH** then enter the Sub-address (up to 20 digits).  
(Up to 36 digits including telephone number, pauses, spaces, FLASH and Sub-address)

Ex: Telephone number = 5551234, Sub-address =2762

Enter as: (5) (5) (5) (1) (2) (3) (4)

**FLASH** (2) (7) (6) (2)

```
TEL. NO.
5551234s2762■
```

3

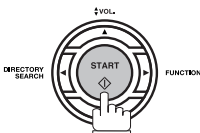

The document is stored into memory and your machine starts to dial the number of the station and sends the document(s) with Sub-addressing information.

```
* STORE *      NO.001
      PAGES=001  01%
```

### NOTE

1. **FLASH** separates the Sub-address from the Telephone number and is indicated by an "s" in the display.
2. Manual Off-Hook or On-Hook Dialling cannot be used with the Sub-addressing Transmission.
3. The Sub-address is not transmitted during Manual Redial Mode.

# Journals and Lists

## General Description

To help you maintain records of the documents you sent and received, as well as lists of the numbers you record, your machine is equipped to print the following journals and lists: Transaction Journal, Individual Transmission Journal, Communication Journal, One-Touch/Abbreviated/Directory Search No. List, Program List, Fax Parameter List, Directory Sheet and File List.

## Transaction Journal

The "Journal" is a record of the last 32 transactions (a transaction is recorded each time you send or receive a document). It is printed out automatically after every 32 transactions (See Note 1) or you can print or view it manually by using the following procedure:

**1**

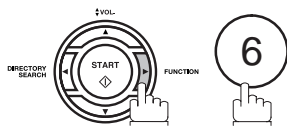

```
PRINT OUT      (1-7)
ENTER NO. OR v ^
```

**2**

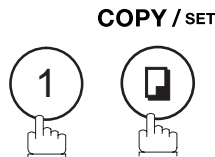

```
JOURNAL
1:PRINT 2:VIEW
```

**3a**

① To print a Journal

```
* PRINTING *
JOURNAL
```

**3b**

② To view a Journal

```
JOURNAL VIEW
1:XMT ONLY 2:ALL
```

**4**

Select the viewing mode.

- ① to view transmission transactions only
- ② to view all transactions

**Ex:** ②

You can view the transactions in the journal by pressing

▼ or ▲. Press **STOP** to return to standby.

```
USE THE v ^ KEYS TO
SCROLL EACH RECORD
```

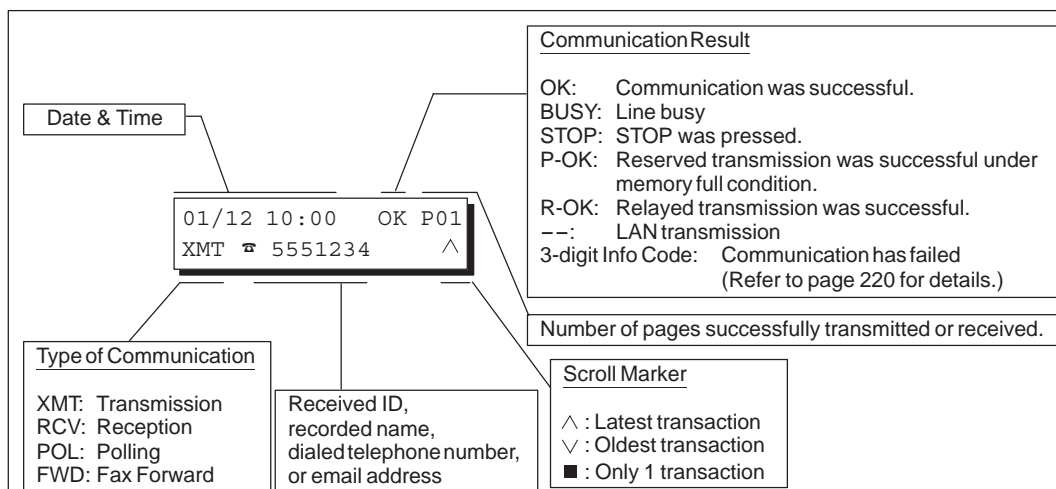

### NOTE

1. If you wish to disable the automatic print out of the Transaction Journal, change the setting of Fax Parameter No. 13 to "Invalid". (See page 78)

# Individual Transmission Journal (IND. XMT JOURNAL)

An Individual Transmission Journal contains the information on the latest transmission.

**1**

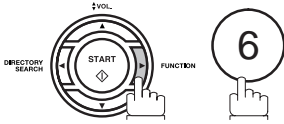

PRINT OUT (1-7)  
ENTER NO. OR V ^

**2**



6:IND. XMT JOURNAL?  
PRESS SET TO PRINT

**3**

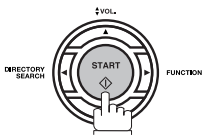

\* PRINTING \*  
IND. XMT JOURNAL

# Journals and Lists

## Individual Transmission Journal (IND. XMT JOURNAL)

### Sample Transaction Journal

***** -JOURNAL- ***** DATE 03-DEC-2002 ***** TIME 15:00 ***** P.01									
(3)	(4)	(5)	(6)	(7)	(8)	(9)	(10)	(11)	(12)
NO.	COMM.	PAGES	FILE	DURATION	X/R	IDENTIFICATION	DATE	TIME	DIAGNOSTIC
01	OK	001/001	149	00:00:52	XMT	☎215	03-DEC	20:04	C8444B0577000
02	--	001/001	151	00:00:02	XMT	TEST	03-DEC	20:07	01 STN(S) LAN
03	--	003/003	153	00:00:20	XMT	fax@nwfax1	03-DEC	20:09	01 STN(S) LAN
04	OK	003	154	00:00:21	RCV	fax@nwfax1.rdmg.mgcs	03-DEC	20:10	LAN
05	OK	001	155	00:00:19	RCV	215	03-DEC	20:11	C0542B0577000
06	634	000/003	156	00:00:00	XMT	☎216	03-DEC	20:14	0800420000000
07	408 *	003		00:02:14	XMT	☎217	03-DEC	21:17	0040440A30080
<p style="text-align: center;">} } } } }</p>									
31	OK	000/001	159	00:00:07	XMT	TEL XMT	03-DEC	20:18	CA40462000000
32	OK	001/001	160	00:00:16	XMT	TEL XMT	03-DEC	20:19	C8444B0577000
<< CONTINUE >> (13) -PANASONIC -									
***** -HEAD OFFICE - ***** 201 555 1212- *****									
(15) (14)									

### Sample Individual Transmission Journal (IND. XMT JOURNAL)

***** -IND. XMT JOURNAL- ***** DATE 03-DEC-2002 ***** TIME 15:00 *****									
(10)	(11)								
		DATE/TIME	= 03-DEC-2002 09:00						
(3)		JOURNAL No.	= 21						
(4)		COMM. RESULT	= OK						
(5)		PAGE(S)	= 001/001						
(7)		DURATION	= 00:00:16						
(6)		FILE No.	= 010						
(16)		MODE	= MEMORY TRANSMISSION						
(17)		DESTINATION	= [001] / 555 1234 /ABCDEFG						
(18)		RECEIVED ID	=						
(19)		RESOLUTION	= STD						
(13) -PANASONIC -									
***** -HEAD OFFICE - ***** 201 555 1212- *****									
(15) (14)									

## Individual Transmission Journal (IND. XMT JOURNAL)

### Explanation of Contents

- (1) Printout date
- (2) Printout time
- (3) Journal number
- (4) Communication result : "OK" indicates that the communication was successful.  
 "BUSY" indicates that the communication has failed because of busy line.  
 "STOP" indicates that **STOP** was pressed during communication.  
 "P-OK" indicates that memory overflow or document misfeeding occurred while storing the documents into memory for transmission but successfully stored document(s) was sent.  
 "R-OK" indicates that the Relayed XMT or Confidential Communication was successful.  
 "- -" indicates LAN transmission. (See Note 2)  
 "3-digit Info Code (See page 226) indicates that the communication has failed.
- (5) Number of pages transmitted or received : The 3-digit number is the number of pages successfully transmitted or received.  
 When the documents are stored into memory, two 3-digit numbers will appear.  
 The first 3-digit number represents the number of pages successfully transmitted.  
 The second 3-digit number represents the total number of pages that were attempted to be transmitted.  
 Asterisk "\*" indicates that the quality of some received copies was poor.
- (6) File number : 001 to 999 (If the communication is stored into memory, a file number is assigned for each communication.)
- (7) Duration of communication
- (8) Type of communication : "XMT" means Transmission  
 "RCV" means Reception  
 "POL" means Polling  
 "FWD" means Fax Forward
- (9) Remote station identification : Name : Recorded name in One-Touch or ABBR. Numbers or remote station's Character ID.  
 ☎ number : Dialed telephone number.  
 Number : Remote station's ID number.  
 Email address
- (10) Communication date
- (11) Communication Start time
- (12) Diagnostic : For service personnel only  
 The 2-digits number is the number of final destinations.  
 "STN(S) LAN" indicates LAN transmission.  
 "(MDN) LAN" indicates LAN transmission with Delivery Notice.
- (13) Own LOGO : Up to 25 characters
- (14) Own ID number : Up to 20 digits
- (15) Own Character ID : Up to 16 characters
- (16) Type of communication : Transmission or memory transmission
- (17) Destination : One-Touch or ABBR. No./Email Address or Telephone Number/Recorded Name  
 If not : Email Address or Telephone number
- (18) Received remote station's ID : Character ID or ID number
- (19) Resolution : "STD" means standard resolution  
 "FINE" means fine resolution  
 "S-FINE" means super fine resolution

### NOTE

1. Email transmission sent to multiple locations is recorded as a single transaction on the Journal.
2. The communication result shows "OK" when the sender receives the DELIVERY NOTICE as a response for mail from the other party. It usually takes time until the DELIVERY NOTICE is returned; so "--" is shown immediately after the sending. When the DIRECT IFAX XMT is successfully communicated, the result field also shows "OK".

# Journals and Lists

## Communication Journal (COMM. JOURNAL)

The Communication Journal (COMM. JOURNAL) lets you verify whether the transmission or polling was successful. You may select the printout condition (Off/Always/Inc. only) in Fax Parameter No. 12.

### Sample COMM. JOURNAL

```
***** - COMM. JOURNAL - ***** DATE 03-DEC-2002 *** TIME 15:00 *****

(1)                                (2)                                (3)
MODE = MEMORY TRANSMISSION        START=03-DEC 14:50        END=03-DEC 15:00

FILE NO.= 050 (4)

(5)  (6)  (7)  (8)  (9)  (10)
STN  COMM. ONE-TOUCH/ STATION NAME/EMAIL ADDRESS/TELEPHONE NO. PAGES  DURATION
NO.  ABBR NO.

001  OK    <01>        SERVICE DEPT.                001/001  00:01:30
002  OK    <02>        SALES DEPT.                  001/001  00:01:25
003  407   <03>        ACCOUNTING DEPT.            000/001  00:01:45
004  BUSY  ☎          021 111 1234                000/001  00:00:00

                                - PANASONIC -
***** - HEAD OFFICE          - ***** - 201 555 1212 - *****

                                THE SLEREXE COMPANY LIMITED
                                SAPORS LANE - BOOLE - DORSET - BH 25 8 ER
                                TELEPHONE BOOLE (945 13) 51617 - TELEX 123456

                                Our Ref. 350/PJC/EAC                                18th January, 1972.

                                Dr. P.N. Cundall,
                                Mining Surveys Ltd
```

... variations of print density ...  
cause the photocell to generate an analogous electrical video signal.  
This signal is used to modulate a carrier, which is transmitted to a  
remote destination over a radio or cable communications link.

At the remote terminal, demodulation reconstructs the video  
signal, which is used to modulate the density of print produced by a  
printing device. This device is scanning in a raster scan synchronised  
with that at the transmitting terminal. As a result, a facsimile  
copy of the subject document is produced.

Probably you have uses for this facility in your organisation.

Yours sincerely,



P.J. CROSS  
Group Leader - Facsimile Research

## Communication Journal (COMM. JOURNAL)

### Explanation of Contents

- (1) Indication of communication mode
- (2) Start time of communication
- (3) End time of communication
- (4) File number : 001 to 999 (When the communication is stored into memory, a file number is assigned for each communication.)
- (5) Station number : Sequential number of the Stations.
- (6) Communication result : "OK" indicates that the communication was successful.  
 "BUSY" indicates that the communication has failed because of busy line.  
 "STOP" indicates that **STOP** was pressed during communication.  
 "P-OK" indicates that memory overflow or document misfeeding occurred while storing the documents into memory for transmission but successfully stored document(s) was sent.  
 "R-OK" indicates that the Relayed XMT or Confidential Communication was successful.  
 "- -" indicates LAN transmission.  
 "3-digit Info Code (See page 226) indicates that the communication has failed.  
 In this case, the machine will print out the attached report with first page of your document as shown on the previous page.
- (7) One-Touch/Abbreviated number or : ☎ mark indicates dialled by direct number dial.  
 ☎ mark
- (8) Recorded name in the Phone Book, direct dialling number, or email address
- (9) Number of pages transmitted or received : The 3-digit number is the number of pages successfully transmitted or received.  
 When the documents are stored into memory, two 3-digit numbers will appear.  
 The first 3-digit number represents the number of pages successfully transmitted.  
 The second 3-digit number represents the total number of pages that were attempted to be transmitted.
- (10) Duration of communication

# Journals and Lists

## One-Touch/Abbreviated and Directory Search List

To print a One-Touch/Abbreviated Number and Directory Search List of the telephone numbers you have stored.

**1**

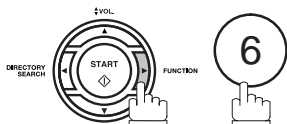

PRINT OUT (1-7)  
ENTER NO. OR V ^

**2**



2:ONE-TCH/ABBR LIST?  
PRESS SET TO PRINT

**3**

**COPY / SET**



1:ONE-TOUCH/ABBR NO.  
2:DIR. SEARCH

**4**



for One-Touch/ABBR. Number List

\* PRINTING \*  
ONE-TOUCH/ABBR LIST



for Directory Search List

\* PRINTING \*  
DIR. SEARCH LIST



## One-Touch/Abbreviated and Directory Search List

### Sample One-Touch List

```

***** -ONE-TOUCH LIST- ***** DATE 03-DEC-2002 ***** TIME 11:11 *** P.01
(1)      (2)      (3)      (7)
ONE- STATION NAME      EMAIL ADDRESS / TELEPHONE NO.
TOUCH      ROUTING SUB-ADDR (5)  ROUTING TSI (6)      RELAY ADDR (ABBR NO.)

<01> John Smith      ☎201 555 3456
      4452              +1 201 123 4567      [001]
<02> Jane Smith      ☎201 555 1212
      1212              212 555 1234        [002]
<03> Bob Jones      jonesb@abcdefg.com
      123456              201 555 1212
<04> Panafax1      panafax1@rdmg.mgcs.mei.co.jp
      4827              +81 03 5251 1234
<05> Panafax2      panafax2@rdnn.mgcs.mei.co.jp
      1773              +81 0467 5251 1234

      NO. OF STATION = 05 (4)

                                  -PANASONIC
*****-HEAD OFFICE - ***** - 201 555 1212- *****
    
```

### Sample ABBR. Number List

```

***** -ABBR NO. LIST- ***** DATE 03-DEC-2002 ***** TIME 11:11 *** P.01
(1)      (2)      (3)      (7)
ABBR STATION NAME      EMAIL ADDRESS / TELEPHONE NO.
NO.      ROUTING SUB-ADDR (5)  ROUTING TSI (6)      RELAY ADDR (ABBR NO.)

[001] John Smith      ☎201 555 3456
      4452              +1 201 123 4567      [009]
[002] Jane Smith      ☎201 555 1212
      1212              212 555 1234        [010]
[003] Bob Jones      jonesb@abcdefg.com
      123456              201 555 1212
[004] Panafax1      panafax1@rdmg.mgcs.mei.co.jp
      4827              +81 03 5251 1234
[005] Panafax2      panafax2@rdnn.mgcs.mei.co.jp
      1773              +81 0467 5251 1234

      NO. OF STATION = 005 (4)

                                  -PANASONIC
*****-HEAD OFFICE - ***** - 201 555 1212- *****
    
```

# Journals and Lists

## One-Touch/Abbreviated and Directory Search List

### Sample Directory Search List

```

***** -DIR. SEARCH LIST- ***** DATE 03-DEC-2002 ***** TIME 11:11 *** P.01
(8)      (2)      (1)      (3)      (7)
STATION NAME  ONE-TOUCH/  EMAIL ADDRESS / TELEPHONE NO.
      ABBR NO.  ROUTING SUB-ADDR (5)  ROUTING TSI (6)      RELAY ADDR (ABBR NO.)

[B]   Bob Jones   [003]   jonesb@abcdefg.com
      123456           201 555 1212

[J]   John Smith  [001]   ☎201 555 3456
      4452           +1 201 123 4567      [009]

      Jane Smith  [002]   ☎201 555 1212
      1212           212 555 1234        [010]

[K]   Panafax1    [004]   panafax1@rdmg.mgcs.mei.co.jp
      4827           +81 03 5251 1234

[M]   PAnafax2    [005]   panafax2@rdnn.mgcs.mei.co.jp
      1773           +81 0467 5251 1234

      NO. OF STATIONS = 005 (4)

                                  -PANASONIC
*****-HEAD OFFICE - ***** - 201 555 1212- *****
    
```

- (1) One-Touch number or Abbreviated number : <nn>= One-Touch number, [nnn] = Abbreviated number
- (2) Station name recorded in the machine : Up to 15 characters
- (3) Telephone number recorded in the machine : Up to 36 digits (Telephone number)
- Email address recorded in the machine : Up to 60 characters (Email address)
- ☎number : Telephone Number programmed into One-Touch / ABBR NO.
- (4) Number of recorded One-Touch and ABBR. numbers
- (5) Routing Sub-address : Up to 20 digits
- (6) Routing TSI : Up to 20 digits
- (7) Relay Address : 3-digit
- (8) The first letter of station name recorded in your machine

## Program List

To print a Program List of the Dialling Patterns that you have previously entered into the Program Keys.

**1**

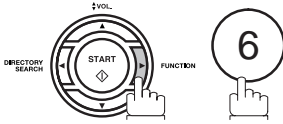

PRINT OUT (1-7)  
ENTER NO. OR V ^

**2**



3:PROGRAM LIST?  
PRESS SET TO PRINT

**3**

**COPY / SET**



\* PRINTING \*  
PROGRAM LIST

### Sample Program List

```
***** -PROGRAM LIST- ***** DATE 03-DEC-2002 ***** TIME 15:00 *****

(1)      (2)      (3)      (4)      (5)
PROGRAM  PROGRAM NAME  TYPE     TIMER    ABBR NOS.

[P1]     TIMER XMT     XMT      12:00    [001]
[P2]     TIMER POLL    POLL     19:00    [002]
[P3]     PROG. A      POLL     -----  [001] [002]

                                -PANASONIC          -

***** -HEAD OFFICE - ***** - 201 555 1212- *****
```

### Explanation of Contents

- (1) Program key
- (2) Program name : Up to 15 characters
- (3) Type of communication : "XMT" indicates transmission.  
"POLL" indicates polling.  
"ABBR/GRP" indicates that the Program key is programmed as a group key.  
"ONE-TOUCH" indicates that the Program key is programmed as a One-Touch key.
- (4) Timer : Indicates the starting time.  
"----" indicates that the Program key contains "non-deferred" program.
- (5) Numbers recorded in the program : One-Touch/ABBR. numbers

# Journals and Lists

## FAX Parameter List

**1**

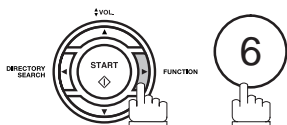

PRINT OUT (1-7)  
ENTER NO. OR ∨ ^

**2**



4:FAX PARAM. LIST?  
PRESS SET TO PRINT

**3**

**COPY / SET**



\* PRINTING \*  
FAX PARAMETER LIST

### Sample FAX Parameter List

```

***** -FAX PARAMETER LIST- ***** DATE 03-DEC-2001 ***** TIME 15:00 ***** P.01

(1)      (2)      (3)      (4)      (5)
PARAMETER DESCRIPTION SELECTION CURRENT STANDARD
NUMBER                                     SETTING   SETTING

(7)001   CONTRAST (HOME) (1:Normal  2:Lighter  3:Darker)   1         1
* 002   RESOLUTION (HOME) (1:Standard 2:Fine    3:S-Fine
         4:Halftone (Fine) 5:Halftone (S-Fine)) 2         1

099     MEMORY SIZE                                     (4MB) (6)

                                     -PANASONIC -

***** -HEAD OFFICE - ***** 201 555 1212- *****
    
```

### Explanation of Contents

- (1) Parameter number
- (2) Description : "(HOME)" means home position setting.
- (3) Selection
- (4) Current setting : "----" indicates code or password is not set. When the code or password is set, it is shown in parenthesis.
- (5) Standard setting : Factory preset standard setting
- (6) Memory size
- (7) Changed setting : "\*" indicates that the Factory preset setting was changed.

# Toner Cartridge Order Forms

To print the Toner Cartridge Order Forms

1

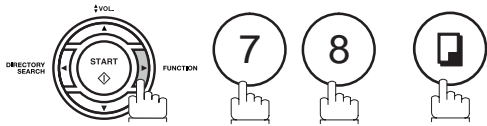

1:CLEAN ROLLER?  
3:PRINT ORDER FORM?

2



\* PRINTING \*  
TONER ORDER FORM

## Sample Toner Cartridge Order Form

\*\*\*\*\*  
> TONER CARTRIDGE ORDER FORM <  
\*\*\*\*\*

\*\*\*\* The toner supply in your machine is running low \*\*\*\*  
To order a replacement Cartridge from your Authorized Dealer

by Phone:  
by Fax:

Thank you for your order.

Customer Name and Address  
=====

Ship to: _____	Bill to: _____
_____	_____
_____	_____
Attention: _____	Attention: _____
Phone No.: _____	Phone No.: _____
Customer ID: _____	P.O. No. (if required): _____
Toner Cartridge: UG-3350 _____	Serial No.: _____

\_\_\_\_\_  
Print your name and title

\_\_\_\_\_  
Signature & Date

# Troubleshooting

## If You Have Any of These Problems

Mode	Symptom	Cause / Action	page
During Transmission	Document doesn't feed/multiple feed	1. Check that your document is free of staples and paper clips, and that it is not greasy or torn.	85
		2. Check that your document is the right type to send through a fax machine by consulting the list on "Documents You Cannot Send". If your document has the characteristics listed, make a photocopy of your document and send the copy instead.	86
		3. Check that the document is loaded properly.	
		4. Adjust the ADF Pressure.	235
	Document jam	The information code 031 will appear on the display if the document becomes jammed.	232
	Does not stamp	1. Check if Stamp LED is lit. 2. Check Fax parameter No. 04 and No. 28 settings.	88 78
	Stamp too light	Replace stamp.	236
Transmission Copy Quality	Vertical lines on the transmitted document	Check own copy quality. If copy is OK, your machine has no problem, report to the receiving party that they have a problem. If copy is NG, clean the Document Scanning Area.	233
	Transmitted document is blank	1. Make sure the document is set face down. 2. Check own copy quality. If copy is OK, your machine has no problem, report to the receiving party that they have a problem. If copy is NG, clean the Document Scanning Area.	233
During Reception	No recording paper	The information code 010 will appear on the display if the paper runs out.	36
	Recording paper jam	The information code 001, 002, 007 or 008 will appear on the display if the paper gets jammed.	231
	Recording paper doesn't advance into machine	Make sure that there is paper in the Paper Cassette. Follow the instructions for loading paper.	36
	Recording paper doesn't eject after printing	Check to see if the recording paper is jammed inside of the machine.	231
	Recording papers are not stacked in sequence. Machine does not print from the last page received.	1. Check if Fax Parameter No. 65 is set to valid. 2. If memory becomes full during reception, the machine will start to print from the 1st page received. We recommend that optional flash memory card is installed if this symptom occurs frequently.	81 242
	Document auto reduction doesn't work	Check Print Reduction settings.	133
	Out of toner	The information code 041 will appear on the display if the Toner Cartridge runs out of toner.	34

# Troubleshooting

Mode	Symptom	Cause / Action	page
Print Copy Quality	Vertical lines printing on the received document	Print out a Journal report (e.g. FUNCTION, 6, 1, SET and 1) and check quality to make sure whether your machine has trouble. If Journal report quality is OK, your machine has no problem, report to the sending party that they have a problem. If copy is NG, replace the Toner Cartridge.	210  34
	Fuzzy print	1. Make sure you are using the correct paper for the best possible print quality. 2. Try reversing the recording paper to the other side.	241
	Missing dots or lines/ inconsistent darkness within print	1. Make sure you are using the correct paper for the best possible print quality. 2. Replace the Toner Cartridge.	241 34
	Fading print	Your Toner Cartridge may be running out of toner. Replace the Toner Cartridge.	34
	Faint print	You may need to choose a different paper for the best possible print quality.	241
Communication	No dial tone	1. Check the connection of the telephone line. 2. Check the telephone line.	237
	No auto answer	1. Check the connection of the telephone line. 2. Check the Reception mode setting. 3. If the Fax Parameter No. 13 (AUTO JOURNAL PRINT) is set to "Valid" (default setting) and the machine is printing the received document from memory, which also happens to be the 32th transaction, the machine will not auto answer until the Transaction Journal completes printing.	237 127
	Cannot transmit or receive	An information code will be shown on the display. Refer to the information code table to find out the trouble.	226
No Unit Operation	No unit operation	To reset the machine, turn-off the Power Supply for a few seconds then turn it on again.	40

# Troubleshooting

Mode	Symptom	Cause / Action	page
<b>TAM Interface Trouble in Unattended TAM I/F Mode (OUT Mode)</b>	Cannot utilize the remote turn-on feature of the telephone answering machine (TAM). The fax machine always answers after the 8th ring.	This feature is not compatible. The fax machine is designed to answer after 8 rings if the TAM does not answer.	--
	Fax machine will not start up when the telephone answering machine is set to give only an outgoing message (OGM).	TAM that gives outgoing announcement only is not compatible. The fax machine will work with a TAM that will record Incoming message (ICM).	--
	A beep...beep sound is recorded on the telephone answering machine.	Speak a little slower between each word while recording an outgoing message (OGM).	--
	Fax machine starts up in the middle of the outgoing message even though the caller wants to leave a voice message.	Make sure the outgoing message (OGM) does not have a silent pause longer than 5 seconds.	--
	Cannot record any incoming message (ICM). The fax machine always starts up at the end of the OGM and before the tape advances to the end of last ICM. (Your TAM only uses a single cassette tape to give OGM and record ICM.)	Set Fax Parameter No. 20 (Silent Detection) to "Invalid". And, instruct the calling party to press * twice on their touch-tone phone during the OGM to start up your fax machine remotely.	79
	Cannot receive from a machine that does not send CNG signal (a short beep tone every 3 seconds) after dialling.	Set Fax Parameter No. 20 (Silent Detection) to "Valid". Or, Instruct the calling party to press * twice on their touch-tone phone during the OGM to start up your fax machine remotely.	79
	Cannot retrieve message from the answering machine remotely, the fax machine always starts up after the command code is entered.	Set Fax Parameter No. 20 (Silent Detection) to "Invalid".	79
	Cannot receive a fax message, but can record voice message.	Check your outgoing message, if it is too long, the calling fax machine may have timed out. Try to shorten your outgoing message to less than 15 seconds, or ask the calling party to program your telephone number in their fax machine with 3 pauses and a "#" at the end. (ex. 5551212 PAUSE PAUSE PAUSE #)	--



# Troubleshooting

Mode	Symptom	Cause / Action	page
<b>TAM Interface Trouble In Unattended Fax Mode (OUT Mode)</b>	Fax machine will not start to receive with the telephone answering machine in the auto-answer mode.	Increase the ring count for detection on the telephone answering machine.	--

# Troubleshooting

## Information Codes

When something unusual occurs, the display may show one of the Information Codes listed below. These will help you to identify and correct the problem.

Info. Code	Meaning	Action	page
001	Recording paper jammed when feeding from the 1st cassette.	Remove the jammed paper.	231
002	Recording paper jammed when feeding from the 2nd cassette.	Remove the jammed paper.	231
007	Recording paper did not completely exit out of machine.	Remove the Toner Cartridge and remove the jammed paper.	231
008	Paper cassette is opened while paper is feeding.	Remove the jammed paper and close the cassette.	231
010	No recording paper.	Load the recording paper.	36
011	Recording Paper Cassette is not installed properly.	Install the Recording Paper Cassette.	--
017	Incorrect paper size loaded in the Paper Cassette.	Load the Paper Cassette with proper paper size (A4, LTR or LGL).	38 39
030	Document is misfeeding.	1. Reload the document properly. 2. Remove the document jam. 3. Adjust ADF.	86 232 235
031	Document paper is too long or jammed. Document length exceeds 78.8 inches (2 meters).	1. Reload the document properly. 2. Remove the document jam.	86 232
041	Out of toner.	Replace the Toner Cartridge.	34
043	Toner is getting low.		
045	Toner Cartridge is not installed.	Install the Toner Cartridge.	34
060	Printer Cover is open.	Close the Printer Cover.	--
061	ADF Door is open.	Close the ADF Door.	--
400	During initial handshake, receiving station did not respond or communication error occurred.	1. Check with the other party. 2. Reload the document and send again.	--
401	Remote station required a Receiving Password to receive the document. Remote station does not have Confidential Mailbox. Remote station requires the sending unit's ID Number. (Fax Telephone Number)	Check the remote station. Program your ID Number (Fax Telephone Number). (See page 48)	--
402	During initial handshake, communication error occurred.	Reload the document and send again.	--
403	No polling capability at the remote side.	Ask remote side to set "POLLED=ON".	--
404/405	During initial handshake, communication error occurred.	Reload the document and send again.	--
406	Transmission Password does not match. Receiving Password does not match. Received from an unauthorized station in Selective Reception mode.	Check the password or the telephone number in One-Touch or Abbreviated station.	194 196 197
407	No confirmation from the receiving station for the previous page sent.	Wait a few minutes and send again.	--
408/409	Remote side confirmation of previous page is illegible.	Wait a few minutes and send again.	--
410	Communication aborted by the transmitting side.	Check with the other party.	--
411	Polling password does not match.	Check the polling password.	139

## Information Codes

Info. Code	Meaning	Action	page
412	No data from the transmitting side.	Check with the other party.	--
414	Polling password does not match.	Check the polling password.	139
415	Polling transmission error.	Check the polling password.	139
416/417 418/419	Received data has too many errors.	Check with the other party.	--
420/421	Machine goes to receiving mode, but receives no command from the transmitting side.	1. Remote side misdial. 2. Check with the other party.	--
422/427	Interface is incompatible.	Check with the other party.	--
430/434	Communication error occurred while receiving.	Check with the other party.	--
436/490	Received data has too many errors.	Check with the other party.	--
456	<ul style="list-style-type: none"> <li>• Unit received a confidential document or was requested to be polled of a confidential document under any of following conditions:                             <ol style="list-style-type: none"> <li>1. Not enough space in memory to receive the confidential document.</li> <li>2. Confidential Mailbox is full.</li> <li>3. While printing received document.</li> </ol> </li> <li>• Unit was requested to relay a document.</li> </ul>	<ol style="list-style-type: none"> <li>1. Print a File List and check the contents.</li> <li>2. Wait until unit finishes printing.</li> </ol>	160
492/493/ 494	Communication error occurred while receiving.	Check with the other party.	--
495	Telephone line disconnected.	Check with the other party.	--
501/502	Communication error occurred using the internal V.34 Modem.	Check with the other party.	--
540/541/ 542/543/ 544	Communication error occurred while transmitting.	<ol style="list-style-type: none"> <li>1. Reload the document and send again.</li> <li>2. Check with the other party.</li> </ol>	--
550	Telephone line disconnected.	Check with the other party.	--
552/553/ 554/555	Communication error occurred while receiving.	Check with the other party.	--
580	Sub-address transmission to a unit that has no Sub-address function.	Check the remote station.	195
581	Sub-address Password transmission to a unit that has no Password Sub-address function.	Check the remote station.	195
601	ADF Door was opened during ADF transmission.	Close the ADF Door and send again.	232
623	No document loaded on the ADF.	Reload the document and send again.	--
630	Redial was not successful due to a busy line.	Reload the document and send again.	--
631	During dialling, STOP was pressed.	Reload the document and send again.	--
634	Redial was not successful due to no response from the called station or wrong number dialled.  <b>Note:</b> If busy tone was not detected, the machine will only redial once.	Check the telephone number and send again.	--
638	Power failure occurred during the communication.	Check the power cord and plug.	40
711	Incorrect LDAP settings.	Check the LDAP Server Name, LDAP Log in Name, LDAP Password, LDAP Search Base.	
712	Incorrect email address.	Check the registered email address. Check the IP Address of the SMTP Server with the Network Administrator.	--
714	Cannot Log on to the LAN.	Check the 10Base-T/100Base-TX cable connection. An unexpected LAN problem occurred. Contact the Network Administrator.	--
715	TCP/IP connection timed out.	Check the Internet Fax parameter settings. Verify the IP Address, Default Gateway IP Address, SMTP Server IP Address.	--

# Troubleshooting

## Information Codes

Info. Code	Meaning	Action	page
716	Cannot logon to the designated SMTP Server.	Check the SMTP Server IP Address setting. Contact the Network Administrator.	--
717	Incomplete SMTP Protocol transmission. SMTP Server's hard disk may be full.	SMTP Server is defective. Contact the Network Administrator.	--
718	Page Memory Overflow occurred while receiving printing data. The paper size selected within your application to print is larger than the paper size loaded in the cassette(s).	Check the document size and resolution. Ask originator to re-send in a supported size and resolution.	--
719	Received data via LAN is in a format that is not supported.	Ask the originator to re-send with a supported file attachment format: * In a TIFF-F format. * Image data conforming to recording paper size.	--
720	Cannot connect to the POP Server. (Incorrect POP Server IP Address) POP Server is down.	Check the POP Server IP Address. Contact the Network Administrator.	--
721	Cannot connect to the POP Server. (User Name or Password error)	Check the POP User Name and Password or the APOP settings. Contact the Network Administrator.	--
722	Failed to obtain the Network Parameters (such as: IP Address, Subnet Mask, Default Gateway IP Address, etc.) from the DHCP server.	1. Check the LAN Cable connection. 2. Contact your Network Administrator and verify whether the DHCP is available on your network. If it is not, change the Fax Parameter No. 169 (DHCP CLIENT) to "Invalid" and set the other Network Parameters manually (see page 16).	
725	DNS Server connection timed out. DNS Server is down.	Check the DNS Server IP Address. Contact the Network Administrator.	--
726	Received an error response from the DNS Server.	Check the POP Server Name. Check the SMTP Server Name.	--
729	Failed to authenticate (SMTP AUTHENTICATION) when connecting with the SMTP server.	Check the SMTP AUTHENT. User Name and Password. Contact the Network Administrator.	
730	Cannot retrieve the Journal nor program the Internet Parameters and the Auto Dialler remotely via email from a PC.	Check that the Fax Parameter No. 158 (PC REMOTE UPDATE) is set to "2:Valid".	83
731	The dialler buffer for manual dialling was full (70 stations) when the Relay Transmission Request was received.	Request the originator to re-send the Relay Transmission Request after the reserved communication is finished.	--
800/816/ 825	Unit was requested to relay a document or Confidential Communication but has no capability.	Check with the other party.	--
815	Mailbox is full.		200
870	Memory overflow occurred while storing documents into memory for transmission.	1. Transmit documents without storing into memory. 2. Install Optional Flash Memory Card.	111 242

### NOTE

1. After identifying the problem and verifying the recommended action, if the information Codes keep reoccurring or for help on Information Codes that appear on your machine but are not listed above, please contact your local Panasonic Authorized Dealer.

## Email ABBR Programming Errors

### Error Message Sent to the Sender

Error messages that are emailed from your machine to the original sender during remote programming of the Auto Dialler via email.

	Error message	Possible cause
1	554 Data transfer error (broken header)	The header or sub header decoding is being processed while the message finished, try again.
2	554 Data transfer error (broken data)	Multiple contents are present and being processed while the message finished, try again.
3	554 Data transfer error (FAX module)	Data transfer error occurred in the FAX module while communicating with the LAN module, try again.
4	554 MIME attachment not supported (message/file)	MIME attachment is not supported during this operation, re-send using plain text in the message body only.
5	554 MIME format not supported	MIME file type is not supported, re-send using plain text in the message body only.
6	554 G3 relay permission denied	The requested domain for Relayed XMT is not registered.
7	554 Relay address unknown	The telephone number of end receiving station for the Relayed XMT is unknown.
8	554 Memory full (FAX module)	FAX Memory is full, try again later.
9	554 Data transfer error	Other errors not listed above, try again later.

### Internet FAX Return Receipt Errors Messages

Error messages that are printed on the Internet Fax Return Receipt when remote programming of the Auto Dialler via email fails.

	Error message	Possible cause
1	Format Error : <@command block, the "@end" command is missing.>	The block termination command "@end" is missing in the "@command" block, add the "@end" command and try again.
2	Format Error : <@begin block, the "@begin" command is missing.>	The block start command "@begin" is missing in the "@begin" block, add the "@begin" command and try again.
3	Format Error : <@begin block, the "@end" command is missing.>	The block termination command "@end" is missing in the "@begin" block, add the "@end" command and try again.
4	Format Error : <@system block, the "@end" command is missing.>	The block termination command "@end" is missing in the "@system" block, add the "@end" command and try again.
5	Format Error : <@sender block, the "@end" command is missing.>	The block termination command "@end" is missing in the "@sender" block, add the "@end" command and try again.
6	Format Error:<@domain block, the "@end" command is missing.>	The block termination command "@end" is missing in the "@domain" block, add the "@end" command and try again.
7	Format Error : <@program block, the "@end" command is missing.>	The block termination command "@end" is missing in the "@program" block, add the "@end" command and try again.
8	Format Error : <@system block, the "@system" command is missing.>	The system block start command "@system" is missing in the "@system" block, add the "@system" command and try again.
9	Permission denied : <Fax Forward parameter is set to "Valid".>	Change the Fax Forward parameter to "Invalid" and try again.
10	Permission denied : <Fax machine is busy performing a task.>	Try again later when the machine is not busy.

## Troubleshooting

### Email ABBR Programming Errors

	<b>Error message</b>	<b>Possible cause</b>
11	Error : <Programmed ABBR overwrite prohibited. Use open ABBR only.>	Can not overwrite existing programmed data, use the "Delete" command to erase the existing data first.
12	Permission denied : <Password is incorrect.>	Correct the password and try again.
13	Permission denied : <Remote Dialler Update parameter is set to "Invalid".>	Set the Remote Dialler Update parameter to "Valid".
14	Format Error : <error line>	The format of the Entry is incorrect / incomplete or the data string for each station is not defined within a single line.
15	Warning : <error line>	The format of the Entry is incorrect or the number of characters entered, exceed the maximum allowed in the field. Correct it and try again.
16	Warning : Field limit exceeded<error line>	The maximum number of Station Name, Domain Name, Sender Name, Program Name, etc were exceeded.

## Clearing a Recording Paper Jam

If the recording paper becomes jammed in the machine, the display will show an Information Code 001, 002, 007 or 008.

To clear the jam, Info. Code 001, 002 or 008

1

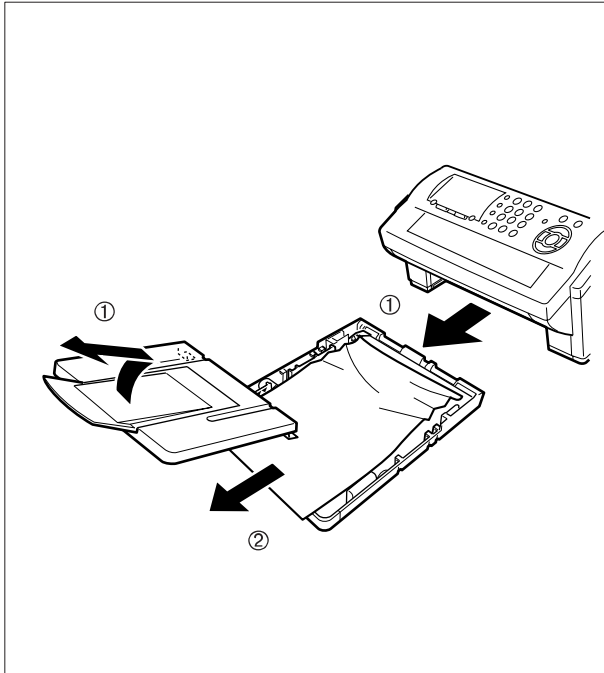

- (1) Slide out the Paper Cassette and remove the Paper Cassette Cover.
- (2) Remove the jammed or wrinkled paper and reload the recording paper into the paper cassette.

To clear the jam, Info. Code 007

1

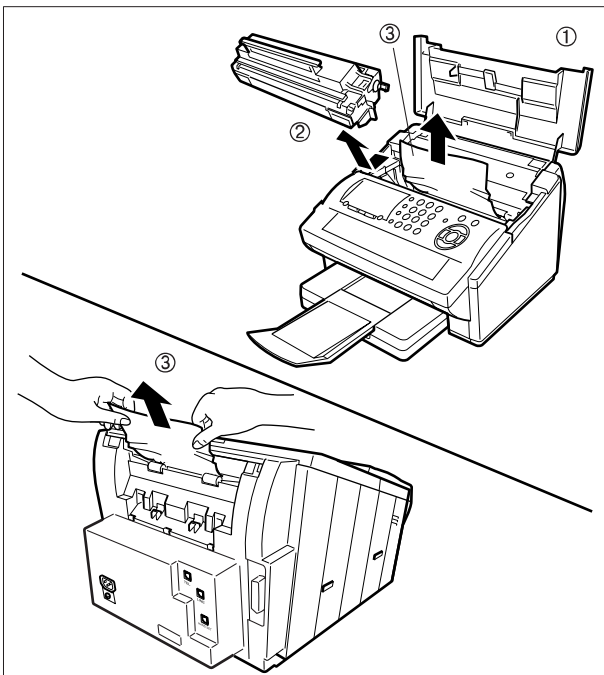

- (1) Open the Printer Cover.
- (2) Remove the Toner Cartridge.
- (3) Remove the jammed paper.

**Note:** 1 If at all possible, try removing the jammed paper from inside of the unit first (as shown in the upper figure) to prevent toner that has not been fused on the paper from rubbing off and dirtying the Fuser Roller.

- 2 To remove the jammed paper from the rear of the unit (as shown in the lower figure), remove the Recording Paper Tray Assembly first and gently pull the jammed paper straight out; taking care not to tear it.

### NOTE

1. The Recording Paper Jam message display is reset only by opening and closing of the Printer Cover.

## Troubleshooting

### Clearing a Document Jam

If a document becomes jammed in the machine, the display will show the Information Code 030 or 031.

To clear the jam

1

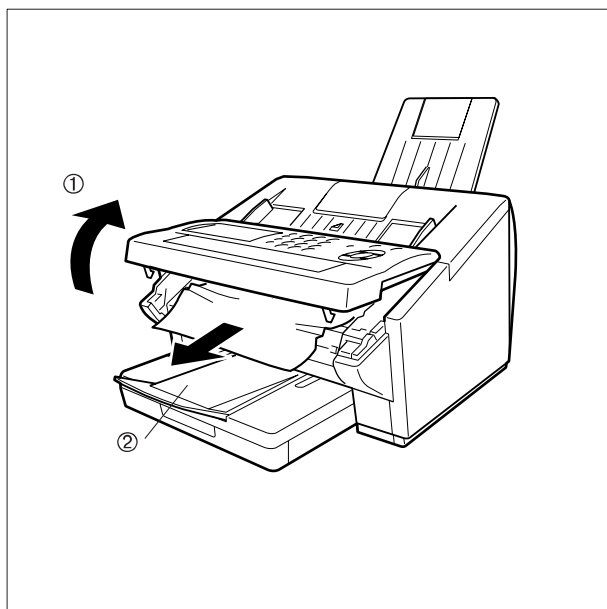

(1) Open the ADF Door.

(2) Remove the jammed document.



## Cleaning the Document Scanning Area

If the receiving party reports that the received documents were black, or contained black lines, try making a copy on your unit to verify. If the copy is black or has black lines, the document Scanning Area is probably dirty and must be cleaned.

### To clean the Scanning Area

1

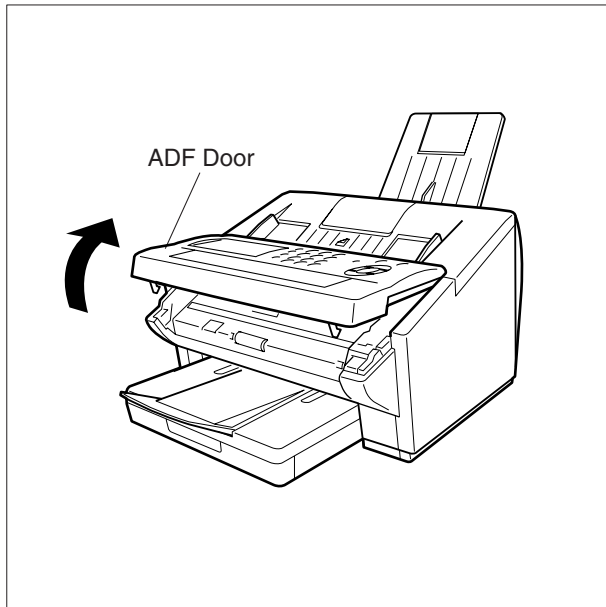

Open the ADF Door.

2

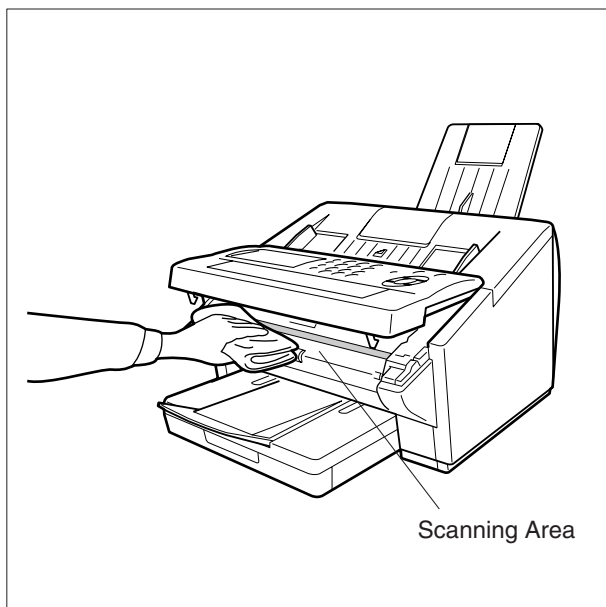

Wipe the Scanning Area gently with a soft cloth gauze wet with ethyl alcohol. Be sure to use a clean cloth, the scanning area can be easily scratched.

# Troubleshooting

## Cleaning the Printer Roller

If you find toner on the back of the recording paper, the printer roller in the fuser unit is probably dirty.

### To clean the Printer Rollers

1

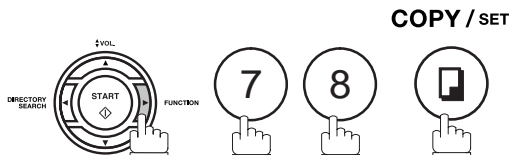

1:CLEAN ROLLER?  
3:PRINT ORDER FORM?

2

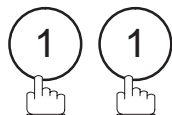

\* PRINTING \*  
CLEANING CHARTS

The machine will print out 3 Cleaning Charts.  
Then, return to standby.

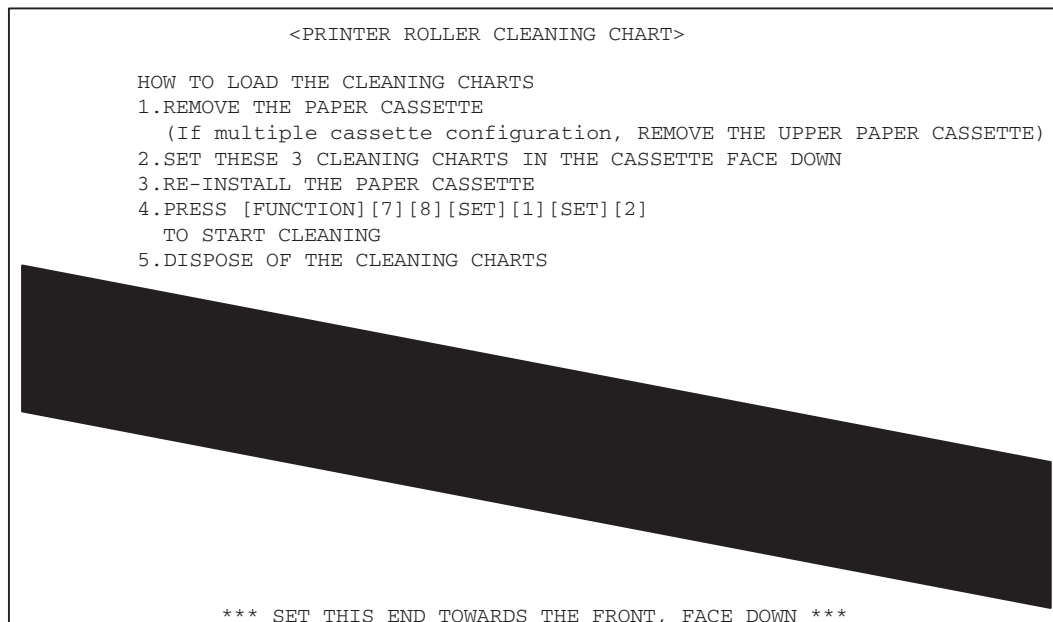

3

Load the Cleaning Charts into the cassette face down.  
(See Note 1)

4

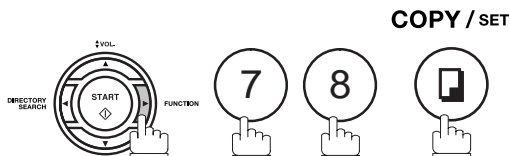

1:CLEAN ROLLER?  
3:PRINT ORDER FORM?

5

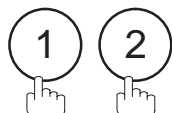

\* CLEANING \*  
PRINTER ROLLER

The Machine will feed out the charts and clean the printer roller.

### NOTE

1. If you have installed the optional cassette(s), load the Cleaning Charts into the upper cassette.

## Adjusting the Automatic Document Feeder (ADF)

If document misfeeding occurs frequently, we suggest you adjust the ADF.

### To adjust the ADF

1

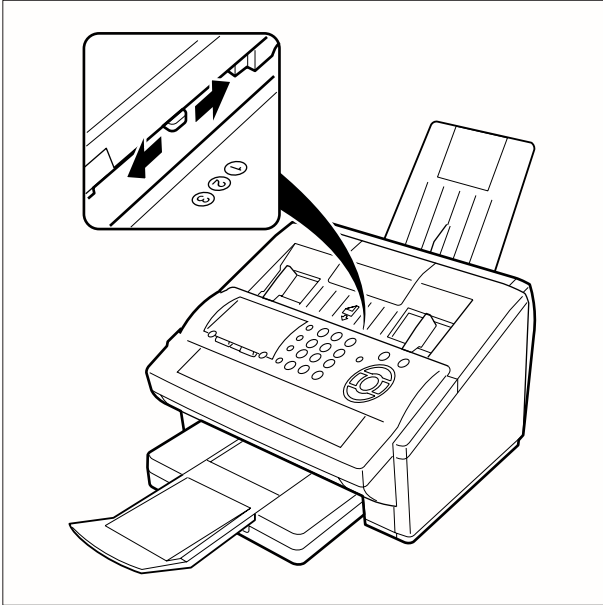

Slide the Pressure Adjusting Lever to the desired position depending on the condition.

Position	Condition
①	To prevent no feed trouble
②	Standard position
③	To prevent multiple feed trouble

# Troubleshooting

## Verification Stamp

The Verification Stamp contains ink. When the stamp mark appears faded or hard to see, the stamp should be replaced or refilled with ink.

### To remove the stamp

1

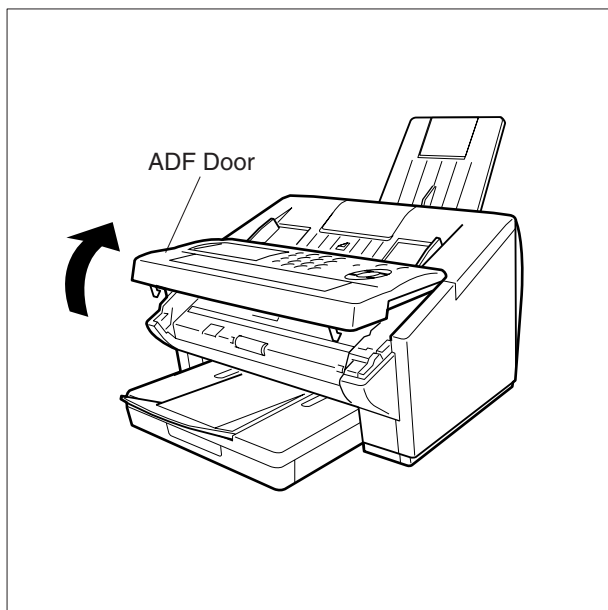

Open the ADF Door.

2

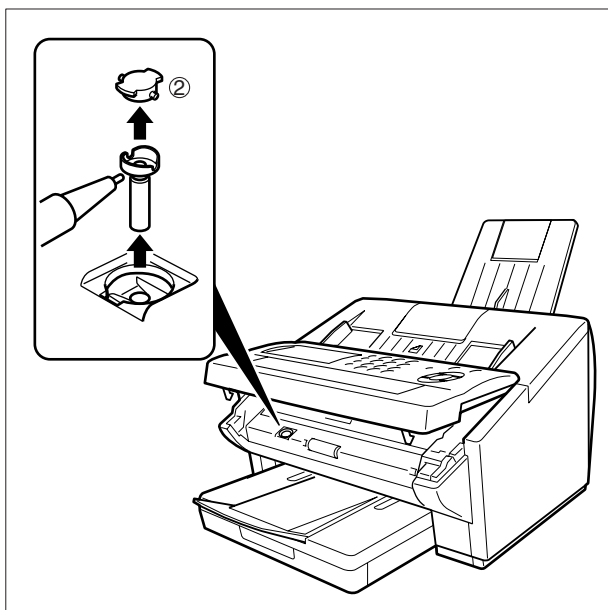

- (1) Remove by pulling the Stamp Assembly upward.
- (2) Remove the Stamp. Replace the stamp with a new one.

### NOTE

1. Please contact your local Panasonic dealer to purchase a new stamp. See page 242 Verification Stamp for order number.

## Checking the Telephone Line

When you do not hear a dial tone through the telephone connected to the machine or when the telephone does not ring (No automatic receive).

**1**

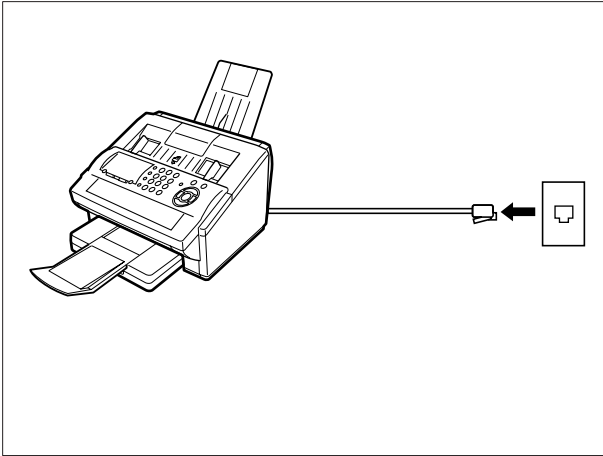

Unplug the Telephone Line Cable from the telephone jack that was supplied by the telephone company.

**2**

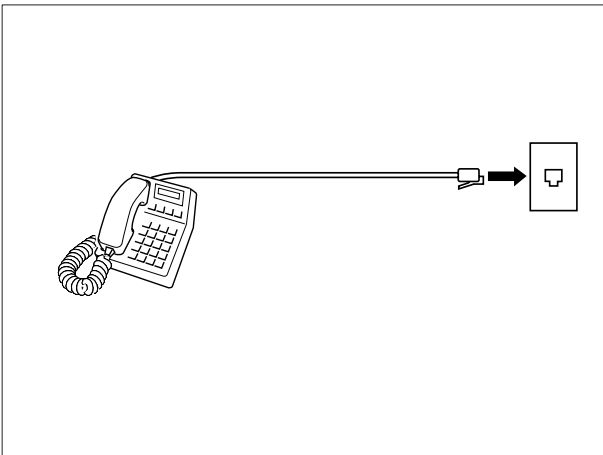

Plug a different regular telephone into the same telephone jack.

**3**

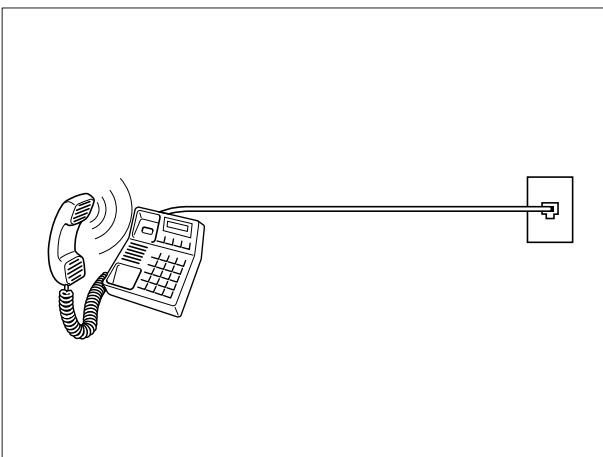

Check for dial tone through the handset. If there is still no dial tone, report it to your local telephone company.

or

Call from another telephone to this number. If the telephone does not ring, report it to your local telephone company.

# Specifications

Compatibility (G3 Fax)	ITU-T Group 3		
Compatibility (LAN)	IETF RFC 2305, ITU-T T.37		
Standard Compliance (LAN)	10Base-T Ethernet (IEEE 802.3), 100Base-TX Fast Ethernet (IEEE802.3u)		
Connector Interfaces (LAN)	10/100 Base-TX port: RJ-45		
Communication Protocol (LAN)	TCP/IP, SMTP, POP3, MIME		
File Format (LAN)	TIFF MH [IETF RFC 2301 Profile S], MMR (400 dpi only)		
Email Receiving Width (LAN)	Maximum size: LETTER		
Coding Scheme	MH, MR, MMR (Conforms to ITU-T Recommendations)		
Modem Type	ITU-T V.34, V.17, V.29, V.27ter and V.21		
Modem Speed	33600 - 2400 bps		
Document Size	Max. : (257 x 2000 mm) (with operator's assistance) Min. : (148 x 128 mm)		
Document Thickness	Single page : 0.06 mm (45 g/m <sup>2</sup> ) to 0.15 mm (112 g/m <sup>2</sup> ) Multiple pages : 0.06 mm (45 g/m <sup>2</sup> ) to 0.12 mm (75 g/m <sup>2</sup> )		
ADF Capacity (Automatic Document Feeder)	Built-in, up to 50 Sheets Note : The document limitation to send multiple pages is as follows		
	<i>Document Size</i>	<i>Document Thickness</i>	
	<i>Up to 20 pages</i>	<i>257 x 364 mm</i>	<i>0.06 to 0.12 mm</i>
	<i>Up to 30 pages</i>	<i>A4 or Letter size</i>	<i>0.06 to 0.10 mm</i>
	<i>* Please note that although the size and thickness meets the specifications, you might not be able to set 30 pages with some types of papers.</i>		
Scanning Method	Sheet Feeding with CCD type image sensor		
Effective Scanning Width	208 mm		
Scanner Resolution		<b><u>Horizontal</u></b>	<b><u>Vertical</u></b>
	Standard :	8 pels/mm x	3.85 lines/mm
	Fine :	8 pels/mm x	7.7 lines/mm
	Super Fine :	8 pels/mm x	15.4 lines/mm
Recording Method	Laser printer		
Recording Paper	Plain Paper		
Recording Paper Size	Letter, A4 or Legal		
Printer Resolution	Fax/Copy Mode	: 406 x 391 dpi	
	Printer Mode	: 600 x 600 dpi	
		300 x 300 dpi	
Effective Recording Size	Letter	: 208 x 271 mm	
	A4	: 202 x 289 mm	
	Legal	: 208 x 348 mm	

Print Margin (See Note 1)

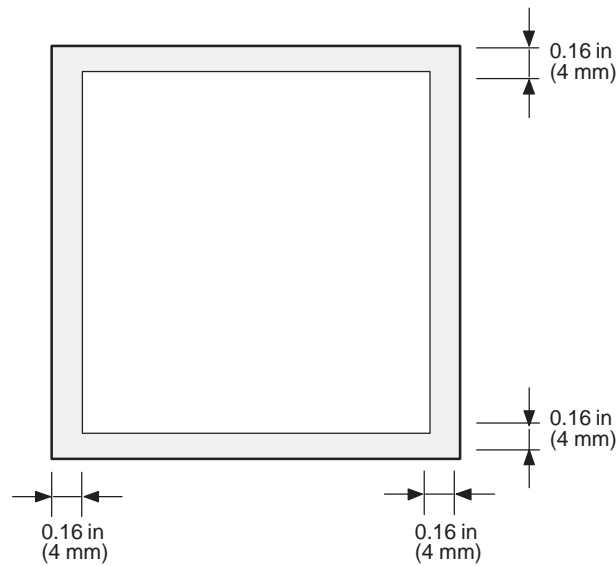

Recording Paper Capacity	Approx. 250 sheets (using 75g/m <sup>2</sup> paper)								
One-Touch/Abbreviated Dialling Memory Capacity	132 stations (including 28 One-Touch keys and 4 Program keys) Each station can register up to 36 digits for each telephone number (including pauses and spaces) and up to 15 characters for each station name.								
Manual Dialler	70 stations (email address/telephone numbers)								
Image Memory Capacity	<table border="0"> <tr> <td>Base Memory (4 MB)</td> <td>240 pages</td> </tr> <tr> <td>with 2 MB Flash Memory Card</td> <td>400 pages</td> </tr> <tr> <td>with 4 MB Flash Memory Card</td> <td>560 pages</td> </tr> <tr> <td>with 8 MB Flash Memory Card</td> <td>880 pages</td> </tr> </table> (Based on ITU-T Image No.1 using Standard Resolution)	Base Memory (4 MB)	240 pages	with 2 MB Flash Memory Card	400 pages	with 4 MB Flash Memory Card	560 pages	with 8 MB Flash Memory Card	880 pages
Base Memory (4 MB)	240 pages								
with 2 MB Flash Memory Card	400 pages								
with 4 MB Flash Memory Card	560 pages								
with 8 MB Flash Memory Card	880 pages								

**NOTE**

1. The left and right print margin is (5.5 mm) when printing a Letter or Legal size document with 600 dpi from a PC.

# Specifications



Power Supply	108-132 VAC, 47-63 Hz, Single Phase: 100V Version 198-255 VAC, 47-63 Hz, Single Phase: 200V Version		
Power Consumption		(200 V Version,	100 V Version)
	Standby (Energy-Saver : On)	Approx. 8.0 Wh	8.0 Wh
	Standby (Energy-Saver : Off)	Approx. 25.0 Wh	23 Wh
	[Room temperature : 25°C]		
	Transmission	Approx. 19.0 W	19.0 W
	Reception	Approx. 480 W	470 W
Dimensions	Copy	Approx. 480 W	470 W
	Maximum	Approx. 490 W	470 W
	370 (W) x 457 (D) x 250 (H) mm (excluding Projections and optional Paper Cassette)		
Weight	Approx. 9.0 kg (excluding consumable supplies and options)		
Operating Environment	Temperature	: 10 to 35°C	
	Relative Humidity	: 15 to 70%	



# Recording Paper Specifications

In general, most photocopy papers will also work very well. There are many "name" and "generic" brands of paper available. We recommend that you test various papers until you obtain the results you are looking for.

The following table summarizes the major specifications to consider when selecting white or colored paper.

Basic Weight	60 to 90 g/m <sup>2</sup>
Cut Edge Conditions	Cut with sharp blades, no visible frayed edges
Grain	Long grain
Moisture Content	3.7 to 5.3% by weight
Opacity	88% minimum
Packing	Polylaminated moisture-proof ream wrap
Sizes	Letter : 216 mm x 279 mm A4 : 210 mm x 297 mm Legal : 216 mm x 356 mm
Type	Cut sheet



## NOTE

1. *It is possible that the paper could meet all of the specifications listed above and still not print well because of the variations in paper manufacturing. Therefore, we recommend that you test the paper thoroughly before purchasing.*

# Options and Supplies

Please contact your local Panasonic dealer for availability.

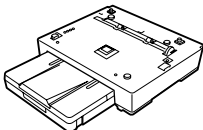
## A. Options:

Order No.	Picture	Description
UE-403176		Handset Kit
UE-409070		250 sheets Letter / Legal / A4 Size Paper Cassette with the Feeder Unit
UE-410046		Expansion Flash Memory Card, 2 MB
UE-410047		Expansion Flash Memory Card, 4 MB
UE-410048		Expansion Flash Memory Card, 8 MB

## B. Supplies:

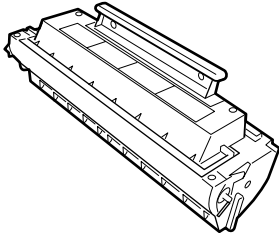
Order No.	Picture	Description
DZHT000004		Verification Stamp
UG-3350		Toner Cartridge

### Installing the Flash Memory Card

Before installing, make sure that there is no document file(s) stored in the memory. You may confirm by printing out a File List (See page 160). When the memory card is installed, the machine will initialize the document memory, all contents stored in the document memory at that time will be lost.

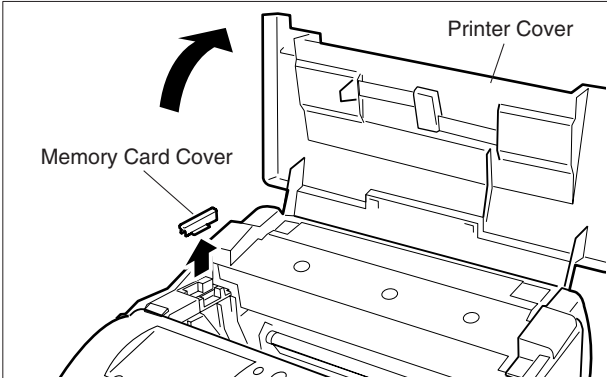
- 1**  

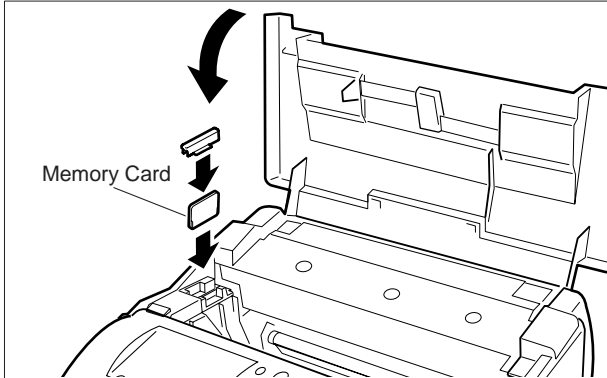
(1) Unplug the Power Cord.  
(2) Open the Printer Cover and remove the Memory Card Cover.
- 2**  

(1) Insert the Flash Memory Card gently into the card slot with the Panasonic logo facing to the outside of the machine.  
**Caution:** Installing the Memory Card(s) in the wrong direction may damage the connecting pins inside the machine.  
(2) Re-install the Memory Card Cover and close the Printer Cover.
- 3**

Plug in the Power Cord. Print out the Fax Parameter List (See page 220) and confirm that the memory size on Fax Parameter No. 99. (See page 81)

#### NOTE

1. The document(s) stored in memory will be lost if the memory card is removed.

# Regulatory Information



## Declaration of Conformity (DoC)

"Hereby Matsushita Graphic Communication Systems, Inc./ Panasonic Testing Centre (Europe) GmbH (PTC), declares that this G3 Facsimile equipment is in compliance with the essential requirements and other relevant provisions of the Directive 1999/5/EC"

### Hint:

If you want to get a copy of the original DoC of our products which relates to the R&TTE, please contact to our web address: <http://doc.panasonic-tc.de>.

### Network Compatibility

This product, Model DX-600-\*\* (\*\* means country suffixes as table below), is designed as to work with an analogue Public Switched Telephone Network (PSTN) in the each country.

**	Country	**	Country	**	Country	**	Country
AG	Austria	EP	Spain	EP	Italy	EB	U.K./Ireland
ER	Denmark	EP	Switzerland	ER	Belgium	AG	Germany
ER	Finland	ER	Norway	ER	Sweden	EP	Greece
ER	The Netherlands	EP	Portugal	AV	France		

**⚠ WARNING** denotes a potential hazard that could result in serious injury or death.

- Plug power supply cord into ordinary AC outlet before connecting telephone line cord. Disconnect telephone line cord before unplugging power supply cord from AC outlet.
- Disconnect the equipment immediately should it ever suffer physical damage which results in the internal parts becoming accessible in normal use. In this instance users should have the equipment repaired or dispose of.
- If the power supply cord and/or telephone line cord of this equipment are damaged, they must be replaced by the special cords supplied by an authorized Panasonic service centre.

**⚠ CAUTION** denotes hazards that could result in minor injury or damage to the

- When you know that a thunderstorm is coming, we recommend that you;
  1. Unplug the telephone line cord from the phone jack.
  2. Turn off the power and unplug the power supply cord from AC outlet.
- This equipment may not necessarily provide for the effective hand-over of a call to or from a telephone connected to the same line.
- The operation of this equipment on the same line as telephones or other equipment with audible warning devices or automatic ring detectors will give rise to bell tinkle or noise and may cause false tripping of the ring detector. Should such problem occur, the user is not to contact telecom (telephone company) faults service.

# Regulatory Information

## <For U.K Users.>

This appliance is supplied with a moulded three pin mains plug for your safety and convenience.

A 5 amp fuse is fitted in this plug.

Should the fuse need to be replaced please ensure that the replacement fuse has a rating of 5 amps and that it is approved by ASTA or BSI to BS1362.

Check for the ASTA mark  or the BSI mark  on the body of the fuse.

If the plug contains a removable fuse cover you must ensure that it is refitted when the fuse is replaced.

If you lose the fuse cover the plug must not be used until a replacement cover is obtained.

A replacement fuse cover can be purchased from your local Panasonic Dealer.

IF THE FITTED MOULDED PLUG IS UNSUITABLE FOR THE SOCKET OUTLET IN YOUR OFFICE THEN THE FUSE SHOULD BE REMOVED AND THE PLUG CUT OFF AND DISPOSED OF SAFELY. THERE IS A DANGER OF SEVERE ELECTRICAL SHOCK IF THE CUT OFF PLUG IS INSERTED INTO ANY 13 AMP SOCKET.

If a new plug is to be fitted please observe the wiring code as shown below.

If in any doubt please consult a qualified electrician.

**WARNING : THIS APPLIANCE MUST BE EARTHED.**

**IMPORTANT:** The wires in this mains lead are coloured in accordance with the following code:

Green and Yellow	: Earth
Blue	: Neutral
Brown	: Live

As the colours of the wires in the main lead of this appliance may not correspond with the coloured markings identifying the terminals in your plug, proceed as follows:

The wire which is coloured GREEN-AND YELLOW must be connected to the terminal in the plug which is marked by letter E or by the safety Earth symbol "⏏" or coloured GREEN or GREEN-AND-YELLOW.

The wire which is coloured BLUE must be connected to the terminal in the plug which is marked with the letter N or coloured BLACK.

The wire which is coloured BROWN must be connected to the terminal in the plug which is marked with the letter L or coloured RED.

How to replace the fuse.

Open the fuse compartment with a screwdriver and replace the fuse.

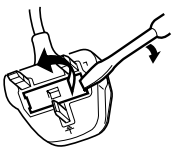

## Regulatory Information

### <For Germany Users>

Machine Noise Information Ordinance 3. GSGV, January 18, 1991: The maximum sound pressure level is equal or less than 70 dB(A) according to ISO 7779.

### <For New Zealand Users>

Different characteristics of the equipment at the other end of the call, and/or variations in line conditions, may mean that it will not always be possible to communicate at the higher speeds for which this machine has been designed. Neither Telecom or Panasonic New Zealand can accept responsibility should this situation arise.

### IMPORTANT NOTICE

Under power failure conditions, this telephone may not operate. Please ensure that a separate telephone, not dependent on local power, is available for emergency use in emergencies.

This equipment should not be used under any circumstances which may constitute a nuisance to other Telecom customers.

This equipment shall not be set to make automatic calls to the Telecom '111' Emergency Service.

Not all telephones will respond to incoming ringing when connected to the extension socket.

### <For European Countries>



As an ENERGY STAR<sup>®</sup> Partner, Panasonic has determined that this product meets the ENERGY STAR<sup>®</sup> guidelines for energy efficiency.

This voluntary program specifies certain energy consumption and usage standards. This product will automatically "power down" after a specified period of non-use. The use of this ENERGY STAR<sup>®</sup> compliant product will reduce energy consumption and ultimately benefit the environment.

The default functions can be adjusted depending on your office requirements. Please ask your authorized Panasonic dealer for more details.

### <For Australian Users>

For user in Australia, please contact Panasonic Customer Care Center on 132 600 for all warranty details.

### WARNING

This is a class A product. In a domestic environment this product may cause radio interference in which case the user may be required to take adequate measures.

# Glossary

<b>10Base-T/100Base-TX</b>	An Ethernet standard for cable. The 10/100 refers to its 10/100 Mbps bandwidth, the base to single channel baseband, and the T to the Twisted pair. The cable uses two pairs of unshielded twisted wires.
<b>ABBR. No. (Abbreviated Number)</b>	The ability to store a full telephone number or email address into the dialler and then utilizing a short series of keystrokes to speed dial that number in the future.
<b>Access code</b>	A 4-digit programmable access code that prevents unauthorized operation of your Fax.
<b>ADF (Automatic Document Feeder)</b>	The mechanism that delivers a stack of document pages to the scanner one page at a time.
<b>Auto print reduction</b>	The method of automatically reducing a received document so that it can be printed onto a standard size piece of plain paper. For example, your machine will reduce an incoming legal size page to 75% of its original size so it could fit on a letter size page.
<b>Automatic reception</b>	The mode that allows you to receive fax documents without user intervention.
<b>BPS (Bits Per Second)</b>	The amount of data that is transmitted over the phone line. Your machine can start at each Max. Modem speed and automatically steps down to suitable speed depending on the phone line condition and the receiving machines capabilities.
<b>C.C.I.T.T.</b>	Consultative Committee on International Telegraph and Telephone. This organization has presently developed four groups of industry standards that insure facsimile compatibility.
<b>Character ID</b>	A programmed proprietary code name that allows up to 16 alphanumeric characters identifying your machine.
<b>Character keys</b>	The keys that are used to enter letters and symbols for various programming functions.
<b>Client</b>	Clients are computers that run software programs used to contact and obtain data from Server software program on another computer, often across a great distance.
<b>Coding scheme</b>	The data compression method used by machines. Your machine utilizes Modified Huffman (MH), Modified Read (MR) and Modified Modified Read (MMR) coding schemes.
<b>COMM. JOURNAL</b>	Refers to either the Communication Journal, Relay Transmission Report, or the Confidential XMT Report.
<b>CONTRAST</b>	Signifies the scanning sensitivity in terms of lightness and darkness of your original transmitting pages.
<b>Cover Sheet</b>	A Fax Cover Sheet can be attached to your transmit document(s) that shows the recipient's name, originator's name and number of pages attached.
<b>DDD (Direct Distance Dialling)</b>	A telephone service that allows unassisted dialling, no operator assistance is required.
<b>Default Gateway IP Address</b>	This is your Gateway's Address, it is used by other Networks to determine which route to take when communicating with your Internet Fax.
<b>Deferred polling</b>	The ability to retrieve documents from other stations at a later time.
<b>Deferred transmission</b>	The ability to send documents to other stations at a later time.
<b>Delivery Notice</b>	Delivery Notice is a Message Disposition Notification (MDN) request initiated by the sending IFax to the destination IFax. The receiving IFax replies with a delivery processing confirmation after the message (email) was read.
<b>Direct Dialling</b>	The method of dialling where you enter the entire telephone number or email address through the keypad.
<b>Direct SMTP</b>	Allows IFax machines to communicate directly with each other within the Firewall (Intranet) without going through the Mail Server, thus alleviating the burden on the mail server.
<b>Directory Search Dialling</b>	Allows you to dial a full telephone number or email address by searching the station's name entered in the One-Touch keys or Abbreviated dialling numbers.
<b>Directory Sheet</b>	The list that contains the station names that are programmed into your unit.
<b>Domain Name</b>	A unique name that identifies an Internet site. Domain Names always have 2 or more parts, separated by dots. The part on the left is the most specific, and the part on the right is the most general.

# Glossary

<b>DTMF (Dual Tone Multi-Frequency)</b>	Dialling method that sends a different set of frequencies for each digit of the telephone keypad. Commonly refers to touch tone dialling.
<b>ECM (Error Correction Mode)</b>	The ability to correct transmission errors as detected during the transmitting phone call.
<b>Email Address</b>	The address for sending and receiving data by email. It consists of User name, Sub-domain name and Domain name.
<b>End receiving station</b>	In a relay network, the final station designated to receive the document.
<b>Energy-Saver Mode</b>	Saves energy by consuming less power than when in standby mode by turning off the fuser unit after the specified time.
<b>Ethernet</b>	A very common method of networking computers and equipment in a LAN. Ethernet can handle up to 100 Mbps and can be used with almost any kind of computer.
<b>F.C.C.</b>	Federal Communications Commission. The U.S. Government organization that regulates communications originating or terminating in the United States.
<b>FAX Forward</b>	The ability to forward all incoming faxes to the registered station in the specified ABBR No.
<b>FAX Parameter List</b>	The list that contains the home FAX parameters settings that you have programmed into your machine.
<b>FAX/TEL Auto Switching</b>	The ability to share a single telephone line for both fax and voice usage.
<b>File</b>	A task that has been stored into the memory of your unit. Examples are deferred transactions.
<b>Fixed print reduction</b>	The method that allows you to determine one reduction rate, such as 75%, for all incoming documents.
<b>FUNCTION</b>	The control panel key that will be utilized to begin an operation or configuration of a feature.
<b>G3 mode (Group 3)</b>	Refers to the standards and transmission capabilities of the current generation of machines.
<b>Group dialling</b>	The ability to program many telephone numbers into a single station so that many locations can be dialled in sequence utilizing a single keystroke.
<b>HALFTONE</b>	A scanning technique to distinguish levels of gray from black and white. Your machine can detect up to 64 levels of gray in halftone mode.
<b>Handshaking</b>	The exchange of a group of control signals that communicate between the transmitter and receiver. These signals determine the condition at which communication can occur.
<b>Header</b>	A row of information that is transmitted by the sending machine and printed on the top of each page by the receiving unit. This identifies the transmitting unit and information about the transmission, such as time and date.
<b>Home Page</b>	The page that your Browser displays when it starts up or the main web page for a business, organization, etc.
<b>Host</b>	Any computer on a network that is a repository for services available to other computers on the network. A Host must have a unique Host name within a domain. The host is the first (left most) section of the Fully Qualified Domain Name (FQDN). The remainder of the FQDN is the domain and often tells you something about where your machine is located (i.e., at Panasonic). <b>Example:</b> Your machine's email address is: Fax@fax01.panasonic.com In the example above "fax01" is the host and "panasonic.com" is the domain.
<b>ID</b>	A programmable address of up to 20 digits identifying your machine.
<b>Image memory capacity</b>	This signifies the amount of memory available in your unit capable of storing pages of documents. All page units of measure are based on the ITU-T Image No.1.
<b>Individual Transmission Journal</b>	A report that is printed by the transmitting unit stating information regarding the last document transaction.
<b>Industry Canada (D.O.C)</b>	Department of Communications. The Canadian Government organization that regulates communications originating or terminating in Canada.



<b>Information code</b>	A code that is internally generated by your Fax stating a specific operational error or machine failure.
<b>Information Code</b>	A code that is internally generated by your Fax stating a specific operational error or machine failure.
<b>Initial Sending Station</b>	In a relay network, the station that is originating the document transmission.
<b>Internet</b>	The vast collection of inter-connected networks that all use the TCP/IP protocols. The Internet connects independent networks into a vast global internet.
<b>Intranet</b>	A private network inside a company or organization that uses the same kinds of software that you would find on the public Internet, but that is only for internal use.
<b>IP Address</b>	A unique number used to identify equipment or host computers on the Internet.
<b>ISP (Internet Service Provider)</b>	An institution that provides access to the Internet in some form, usually for money.
<b>ITU-T</b>	International Telecommunication Union - Telecommunication, formerly known as C.C.I.T.T.
<b>ITU-T Image No.1</b>	An industry standard document that allows comparisons of the transmission speeds and capabilities of machines.
<b>Journal</b>	A report that is printed by your unit listing the last 32 transactions.
<b>Keypad</b>	A group of numeric keys located on your control panel.
<b>LAN (Local Area Network)</b>	A computer network system and printer limited to an immediate area, such as an Office, Factory, and University used to integrate and exchange data.
<b>LCD</b>	Liquid Crystal Display. The display area of your machine.
<b>LDAP</b>	Lightweight Directory Access Protocol (LDAP) is a directory service protocol that runs over TCP/IP.
<b>LOGO</b>	Your programmed company name or identification up to 25 alphanumeric characters.
<b>MAC Address</b>	Its the hardware address, often referred to as MAC (Media Access Control) address that is assigned to the equipment. MAC address is hard-coded and is not configurable. The MAC address consists of 6 hexadecimal numbers separated by colons. <b>Example:</b> 00:00:c0:34:f1:50
<b>Mail Gateway IP Address</b>	The Address of the Mail Server. The Internet Fax communicates with your existing Mail Server for all communication traffic.
<b>Mailing List</b>	A system that allows people to send an email to one address, whereupon their message is conveyed to multiple subscribers on the Mailing List.
<b>Manual reception</b>	A mode that requires operator intervention to receive an incoming document.
<b>MAPI</b>	Acronym for Message Application Programming Interface. A standard Windows interface for messaging that enables different mail programs and other mail-aware applications like word processors and spreadsheets to exchange messages and attachments with each other.
<b>MDN</b>	This Message Disposition Notification (MDN) is requested by the sender for a delivery processing confirmation indicating that the message (email) was read.
<b>Memory transmission</b>	The documents are scanned into memory before actual connection to the phone line for transmission.
<b>MIME (Multipurpose Internet Mail Extension)</b>	A standard used for attaching non-text (image) files to Internet email messages.
<b>Modem</b>	A device that converts signals from your fax machine into signals that can be transmitted over telephone lines.
<b>Multi-Station Transmission</b>	The ability to broadcast the same set of documents to a programmed number of locations.
<b>Multiple Logo</b>	The user can select one of 25 preset LOGOs before a transmission.

# Glossary

<b>Network</b>	Any time you connect 2 or more computers together so that they can share resources, you have a computer network. Connect 2 or more networks together and you have an internet.
<b>Network address</b>	An individual 4-digit addressing number assigned to a One-Touch/ Abbreviated number that identifies a particular station in a relay network.
<b>Network password</b>	A 4-digit password assigned to a network address to prevent unauthorized stations from accessing a relay station.
<b>Off-hook dialling</b>	The direct dialling of a telephone number with the handset out of the cradle or "off the hook."
<b>On-hook dialling</b>	The direct dialling of a telephone number with the handset in the cradle or "on the hook."
<b>One-Touch dialling</b>	The ability to dial an entire telephone number by pressing one key.
<b>Overlap Printing</b>	Documents too long to be reduced are automatically printed on two pages with approximately 10 mm overlap.
<b>Panasonic Super Smoothing</b>	An electronic image enhancement (Panasonic Super Smoothing) that will create a particular pattern for the improvement of copy quality.
<b>Polling</b>	The ability to retrieve a document from another machine.
<b>Polling password</b>	A 4-digit programmed code that enables the security of a document being polled.
<b>POP (Post Office Protocol)</b>	POP refers to the way email software such as Eudora or your machine gets email from a mail server. You must always have a POP account that you tell your email software to use to retrieve your mail.
<b>Power Saver Mode</b>	To reduce the power consumption of the machine in standby, select the time period to turn OFF the high temperature fuser unit when the printer is idle.
<b>Print Collation</b>	The ability to stack received documents in the correct order.
<b>Print reduction modes</b>	The methods used to determine how an incoming document will be reduced to print onto the paper loaded in your machine.
<b>Program keys</b>	Keys that are defined for storing a sequence of stations to be dialled or polled.
<b>Protocol</b>	A protocol is the special set of rules for communicating that the end points in a telecommunication connection use when they send signals back and forth. Both end points must recognize and observe the protocol.
<b>PSTN</b>	Public Switched Telephone Network. Network of interconnected switching equipment and transmission facilities.
<b>Receiving password</b>	A 4-digit password that is checked before a document is received.
<b>Relay Address</b>	A 3-digit code that identifies your machine is programmed in a relay network.
<b>Relay Network</b>	A group of machines that communicate via a relay station.
<b>Relay Station</b>	A certain type of machine that can store and forward documents to an end receiving station and/or a relay station in another relay network. Your machine can not be used as a relay station.
<b>Relayed Transmission</b>	Sending a document to a relay station, which in turn, sends the document to the end receiving station.
<b>Relayed Transmission Report</b>	A report that contains information regarding the last document transmission to a relay station.
<b>RESOLUTION</b>	Relates to the number of dots scanned or printed per certain square. The quality of the image increases as the number of dots per certain square increases.
<b>Router (Gateway)</b>	A special purpose computer (or software package) that handles the connection between 2 or more networks. Gateways act like traffic cops, they spend their time looking at the destination addresses of the packets passing through them and deciding which route to send them on.
<b>Selective reception</b>	A function that can be set so that your unit will receive from only those machines programmed into your dialler.

<b>Sender Selection</b>	The user can select one of 24 pre-programmed sender's name and email address/telephone number before each transmission.
<b>Server</b>	A computer, or a software package, that provides a specific kind of service to client software running on other computers. A single server machine could have several different server software packages running on it, thus providing many different servers to clients on the network.
<b>Sleep Mode</b>	The lowest power state that the machine enters after the specified time without actually turning off.
<b>SMTP (Simple Mail Transfer Protocol)</b>	This is the main communication protocol used to send and receive email on the Internet.
<b>Station name</b>	Alphanumeric ID which can be programmed for each One-Touch dialling and Abbreviated dialling number.
<b>Stored documents</b>	Documents that have been scanned and now are stored in your machine's memory.
<b>Sub-address</b>	ITU-T recommendation for further routing, forwarding or relaying of incoming faxes.
<b>Sub-address Password</b>	ITU-T recommendation for additional security that corresponds to the Sub-address.
<b>Subnet Mask</b>	A mask bit used to manage sub-segments of the network which is defined with network IDs.
<b>Substitute memory reception</b>	Your machine's ability to store an incoming document into its memory, when it runs out of recording paper or toner.
<b>TAM Interface</b>	A capability of your unit to be connected and operate with a Telephone Answering Machine (TAM).
<b>TCP/IP (Transmission Control Protocol/ Internet Protocol)</b>	TCP/IP is a suite of protocols used to connect to the Internet and wide-area networks.
<b>TIFF Image Viewer</b>	An application software to view the contents of TIFF-F File. Some TIFF Image Viewers may not display the data properly.
<b>TIFF-F (Tagged Image File Format)</b>	An image file format for attachments of graphic data for smooth transmission between different units. The coding method of this format supports the same coding as Modified Huffman (MH) and multiple-page image data.
<b>Transmission password</b>	A 4-digit password that is checked when a document is transmitted.
<b>Transmission reservation</b>	The ability to preset a telephone number so that you may reserve a transmission while your unit is performing another function.
<b>User parameter</b>	Programmed parameters that provide information to other stations. Examples are logo, character ID, date and time.
<b>Verification stamp</b>	A user selectable transmission verification stamp can be placed on scanned documents that are successfully transmitted or stored in memory.
<b>View Mode - File List</b>	Allows you to view the brief contents of the memory files through the LCD display without having to print the Memory File List.
<b>View Mode - Journal</b>	Allows you to view the brief contents of the journal through the LCD display without having to print the journal.

# ITU-T Image No. 1

All specifications are based on the ITU-T Image No. 1 (The sample shown below is not to scale).



## THE SLEREXE COMPANY LIMITED

SAPORS LANE . BOOLE . DORSET . BH25 8 ER

TELEPHONE BOOLE (945 13) 51617 - TELEX 123456

Our Ref. 350/PJC/EAC

18th January, 1972.

Dr. P.N. Cundall,  
Mining Surveys Ltd.,  
Holroyd Road,  
Reading,  
Berks.

Dear Pete,

Permit me to introduce you to the facility of facsimile transmission.

In facsimile a photocell is caused to perform a raster scan over the subject copy. The variations of print density on the document cause the photocell to generate an analogous electrical video signal. This signal is used to modulate a carrier, which is transmitted to a remote destination over a radio or cable communications link.

At the remote terminal, demodulation reconstructs the video signal, which is used to modulate the density of print produced by a printing device. This device is scanning in a raster scan synchronised with that at the transmitting terminal. As a result, a facsimile copy of the subject document is produced.

Probably you have uses for this facility in your organisation.

Yours sincerely,

*Phil.*

P.J. CROSS  
Group Leader - Facsimile Research

Registered in England: No. 2038  
Registered Office: 80 Vicars Lane, Ilford, Essex.

**A**

ABBR. Dialling Number .....	71
ABBR. Number List .....	217
Abbreviated Dialling .....	108, 113
Abbreviated Email Addressing .....	93
Access Code .....	168
ADF Capacity .....	238
Adjusting the Automatic Document Feeder (ADF) .....	235
APOP AUTHENTICATION .....	84
Auto Dialing Number .....	73
Auto Dialler .....	60, 61, 69
Automatic Document Feeder .....	86
Automatic Reduction .....	133

**B**

Backup .....	54, 64
--------------	--------

**C**

Character ID .....	47
Cleaning the Document Scanning Area .....	233
Cleaning the Printer Roller .....	234
Communication Journal (COMM. JOURNAL) ...	89, 214
Confidential Mailbox .....	200
Contrast .....	87
Control Panel .....	14
Copy .....	136
Cover Sheet .....	173

**D**

Date and Time .....	45
Deferred Polling .....	138
Deferred Transmission .....	137
Delivery Notice .....	101
DELIVERY NOTICE (HOME) .....	84
DHCP CLIENT .....	83
Diagnostic Password .....	81
Dialling Method (Tone or Pulse) .....	43, 78
Dimensions .....	240
DIRECT IFAX XMT .....	84
Direct Transmission .....	111
Direct Transmission Reservation .....	118
Directory Search Dialing .....	94, 109, 114
Directory Sheet .....	76
Distinctive Ring Detector (DRD) .....	172
DNS SERVER .....	83
Document Jam .....	232
Document Size .....	238
Document Thickness .....	238

**E**

Edit File Mode .....	160
Email ABBR Programming Errors .....	229
Email Address .....	73
Email Character Set .....	82
Email Header Format .....	82

**F**

Fax / Tel Auto Switching Mode .....	129
Fax Forward .....	177
Fax Mode .....	130
FAX Parameter List .....	220
Fax Parameter Table .....	78
File List .....	160
Fixed Reduction .....	133
Function Key List .....	12

**G**

Group Dialling .....	142
----------------------	-----

**H**

Header Format .....	78
Header Print .....	78

**I**

ID Number .....	48
Ifax Return Receipt .....	178
Image Memory Capacity .....	239
Inbound Routing .....	24, 156
Incomplete File Save .....	80
Individual Transmission Journal .....	211
Information Codes .....	226
Internet Communication .....	21
Internet Parameters .....	2, 49
Internet Relay Station .....	184
ITU-T Image No. 1 .....	252

**J**

Journal .....	68, 210
---------------	---------

**K**

Key/Buzzer Volume .....	78
-------------------------	----

**L**

LAN Interface .....	50
LDAP .....	20
Loading Documents .....	85
LOGO .....	46

# Index

## M

Mailing List .....	103
Manual Email Addressing .....	91
Manual Number Dialing .....	107
Manual Number Dialling.....	111
Memory Card .....	243
Memory Transmission.....	105
Memory Transmission Reservation .....	97, 117
Monitor Volume.....	42, 44
Multi-Station Transmission (Broadcasting) .	96, 110

## N

Network Printer .....	26
Network Scanner .....	25, 179

## O

Off-Hook Dialling.....	115
One-Touch Dialing .....	112
One-Touch Dialling .....	108
One-Touch Email Addressing .....	92
One-Touch Key.....	69
One-Touch List .....	217
One-Touch/ABBR. No.....	62
On-Hook Dialing.....	116
Operating Environment.....	240
Overlap Printing .....	134

## P

Paper Specifications .....	241
Password Reception .....	197
Password Transmission.....	196
Pause.....	14
PIN Code .....	175
Polling .....	139
Polling Password .....	139
POP Access Key.....	147, 148
POP Parameters.....	124
POP Server.....	124
POP3 Client .....	18
Power Consumption.....	240
Pre Installation Information .....	16
Print Collation.....	135
Print Margin.....	239
Print Reduction .....	133
Print Reduction Ratio.....	133
Priority Transmission Reservation .....	118
Program Keys .....	142
Program List.....	219
Programming or Retrieving Parameters .....	51

## R

Receive To Memory .....	170
Received Time Print .....	78
Receiving Documents via LAN .....	122
Receiving Email from a POP Server .....	124
Receiving Password.....	197
Reception Modes.....	127
Recording Paper Jam.....	231
Redialing.....	120
Reduction Ratio .....	79
Relay Network .....	182
Relay XMT Report (COMM. JOURNAL) .....	192
Relayed Transmission .....	181
Resolution.....	87
Retry an Incomplete File.....	167
Returned Email.....	102
Ringer Volume.....	44

## S

Scanner Resolution .....	238
Selectable Domains.....	99
Selective Reception.....	194
Sender Selection .....	150
Sender Selection List.....	153
Sending Documents via LAN.....	90
SMTP AUTHENTICATION .....	83
SMTP Mail Server .....	17
Sub-Address Password .....	81
Sub-Addressing .....	207
Subject Line Entry .....	154
Substitute Memory Reception .....	135

## T

TAM Interface Mode .....	131
Telephone Mode.....	128
Toner Cartridge .....	34
Toner Cartridge Order Forms .....	221
Transaction Journal .....	83, 210
Transmission Password .....	196
Transmission Reservation .....	117

## U

User Parameters .....	45
-----------------------	----

## V

Verification Stamp .....	88, 236
Viewing Mode File List.....	161

## W

Weight .....	240
--------------	-----

For Service, Call: \_\_\_\_\_

Matsushita Electric Industrial Co., Ltd.  
Web Site : <http://www.panasonic.co.jp/global/>

T0502-0  
DZSD001832-0  
May 2002  
Printed in Japan

## Free Manuals Download Website

<http://myh66.com>

<http://usermanuals.us>

<http://www.somanuals.com>

<http://www.4manuals.cc>

<http://www.manual-lib.com>

<http://www.404manual.com>

<http://www.luxmanual.com>

<http://aubethermostatmanual.com>

Golf course search by state

<http://golfingnear.com>

Email search by domain

<http://emailbydomain.com>

Auto manuals search

<http://auto.somanuals.com>

TV manuals search

<http://tv.somanuals.com>