

OPERATING INSTRUCTIONS

Panasonic

Plain Paper Facsimile

Model No. **KX-F1000NZ**

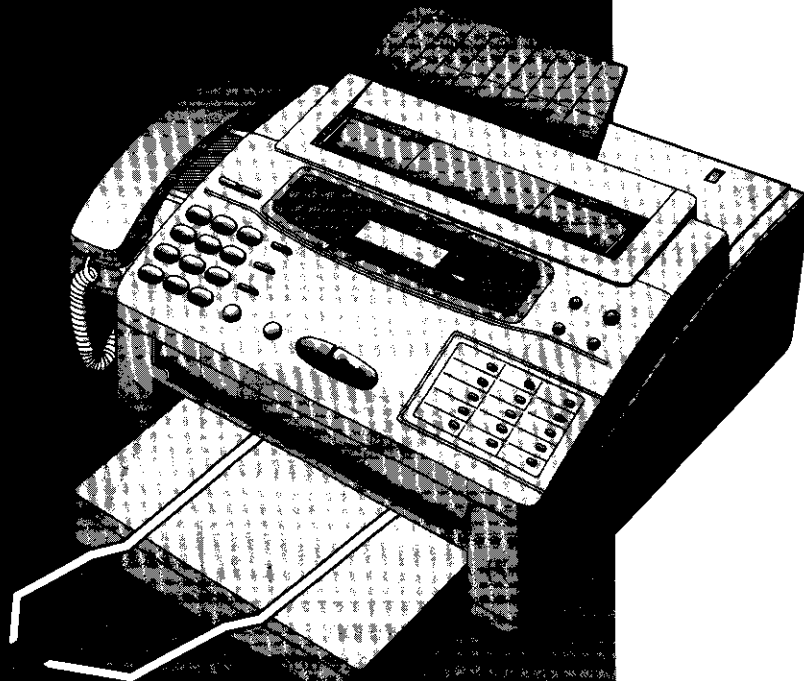

Please read these Operating Instructions before
unit and save for future reference.

Contents

- Chapt 1. Installation and Connection*
- Chapt 2. Initial Preparation*
- Chapt 3. Making and Answering Voice Calls*
- Chapt 4. Transmitting and Receiving Fax Calls*
- Chapt 5. Copier Function*
- Chapt 6. Automatic Dialing*
- Chapt 7. Advanced Operations*

Thank you for purchasing the Panasonic Plain Paper Facsimile.

For your future reference

Date of purchase _____

Serial No. _____

(found on the rear of the unit)

Dealer's name and address _____

Dealer's telephone number _____







Warning:

- When a failure occurs which results in the internal parts becoming accessible, disconnect the power supply cord immediately and return this unit to an authorized service center.
- Disconnect the Telecom connection before disconnecting power connection prior to relocating the equipment, and reconnect the power first.

Caution:

- Note that the images of copied or received documents will remain on the used film. When disposing of the used film, use discretion.
- Do not rub the printed side or use an eraser on the printed side, as it may smear.
- The used film is not reusable. You can order a new film for replacement through the nearest Panasonic dealer.

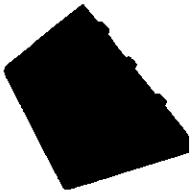
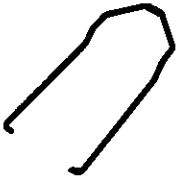
Included accessories

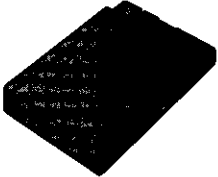
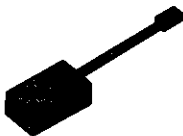
Power cord ... 1 pc.  (p. 7)	Telephone line cord 1 pc.  (p. 7)	Handset 1 pc.  (p. 7)	Handset cord 1 pc.  (p. 7)	Document feeder tray 1 pc.  (p. 6)
Document stacker 1 pc.  (p. 6)	Film cartridge 1 pc.  (pp. 4, 57) —The included film is 30 meters.	Paper cassette 1 pc.  (p. 5)	Extension telephone adaptor 1 pc.  (p. 21)	

- If any items are missing, check with place of purchase.
- Save the original carton and packaging.

© 1996 Kyushu Matsushita Electric Co., Ltd. All Rights Reserved.

Table of Contents

Installing the film cartridge	4
Installing the paper cassette	5
Installing the document stacker	6
Installing the document feeder tray	6
Connections	7
Location of controls	8

2 Initial Preparation

Setting the date and time	10
Setting your logo	10
How to enter characters and symbols	11
Setting your facsimile telephone number	12
Adjusting volumes	12
Selecting the receive mode	13

3 Making and Answering Voice Calls

Making voice calls	14
Answering voice calls	14

4 Transmitting and Receiving Documents

Transmitting documents	15
Manual reception	17
Automatic reception	18

5 Copy Function

Making a copy	24
---------------------	----

6 Storing and Dialing Telephone Numbers

Storing Tel/Fax numbers	25
Making voice calls using automatic dialing ..	26
Transmitting documents using automatic dialing	26
Electronic telephone directory	27

Facsimile

Voice contact	28
Polling	29
Delayed transmission	30
Reserving transmission during a fax reception	31
Printing a cover page	31
Remote fax receiving using an extension	32
Junk mail prohibitor	33
Receiving with distinctive ring service	34

Special settings

Logo print position	35
Overseas transmission mode	35
Copy reduction mode	36
Receiving reduction mode	37
Film/Paper save reception	38
Extension copy	39
Pager alert for fax reception	40
Display contrast	41
Resetting the advanced features	41

Others

TONE, RECALL and PAUSE buttons	42
Printing reports and lists	43
Summary of user programmable features ...	46

Error messages on the display	47
Before requesting help	48
Clearing a recording paper jam	50
Clearing a document jam	52
Cleaning the unit	53
Replacing the film or film cartridge	54

Important safety instructions	56
Accessory order information	57
Specifications	57
Fax Correspondence	59
Speed dialer list	61
Index	63

1

2

3

4

5

6

7

8

9

Installing the film cartridge

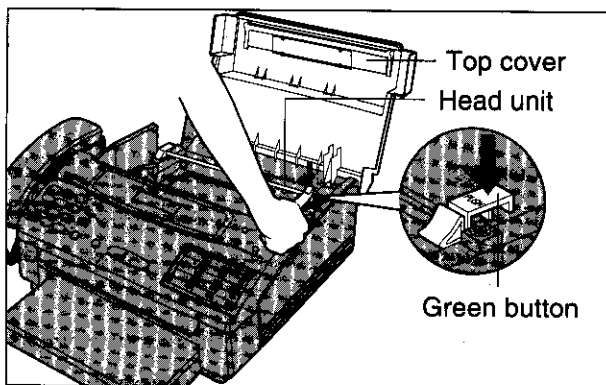

- 1 Open the top cover.
- 2 Press the green button on the right marked "PUSH" and lift up the head unit.

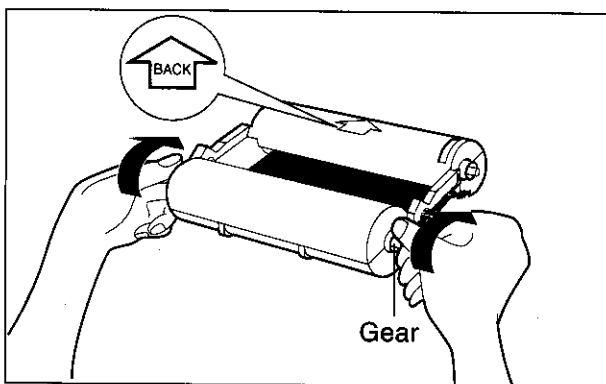

- 3 Place the cartridge with the "BACK" indicator facing up and tighten the film by winding the gears if there is slack.

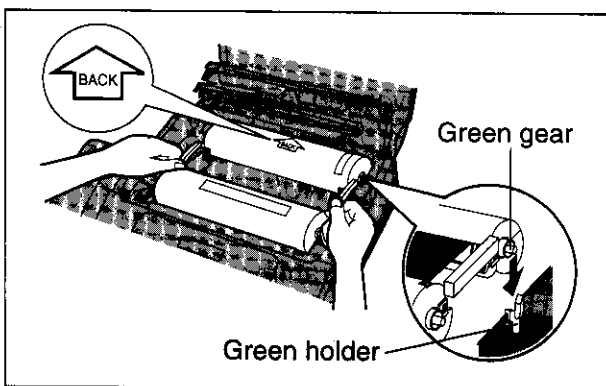
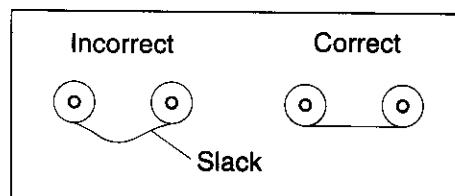

- 4 Place the "BACK" side of the cartridge into the unit, by inserting the pins on the sides of the green gears into the green holders. Then lower the front of the cartridge into place.

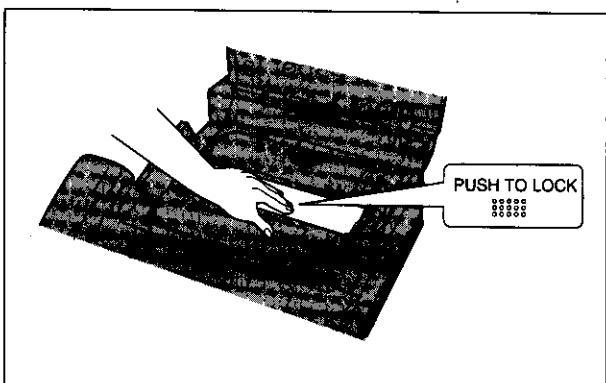

- 5 Press the head unit down firmly to lock in place.
- 6 Close the top cover securely by pushing down on both sides.

Note:

Because the length of the included film is 30 meters, it is recommended to purchase 200 meter length film for replacement soon. See page 57.

Installing the paper cassette

1

You can use A4 size paper. The paper cassette can hold up to 250 sheets of 75 g/m² (20 lb.) paper. Use 60 to 90 g/m² (16 to 24 lb.) paper.

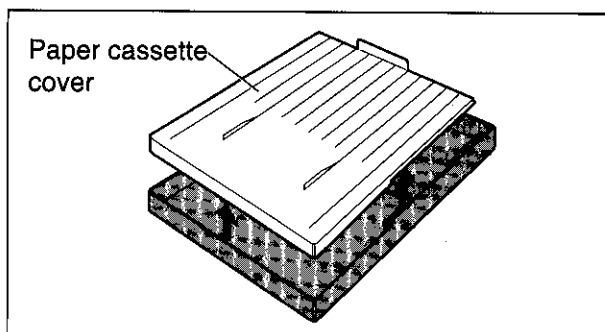

- 1 Open the paper cassette cover.
 - When removing the paper cassette from the unit, lift it up slightly (A) and pull it towards you (B).

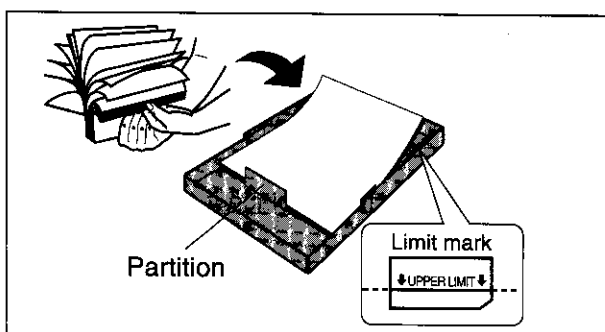
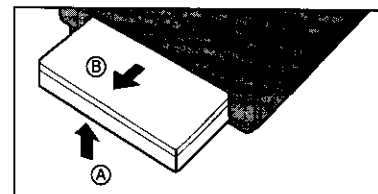

- 2 Fan the stack of paper to avoid a paper jam.
- 3 Insert the paper by aligning the paper edges with the partition.

- Most paper has instructions recommending the side to print on. Insert the paper with the print side down.
- The height of the paper should not exceed the limit mark on the paper cassette or it may cause a paper jam.

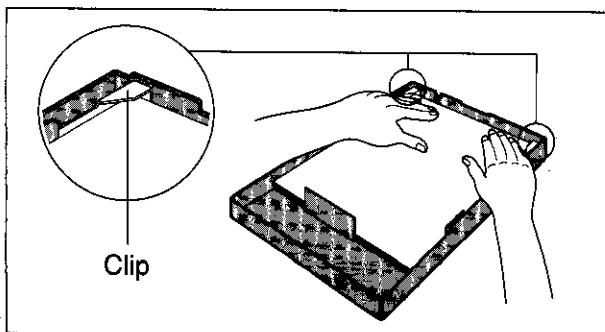

- 4 Push down the opposite edges so they are secured under the clips.

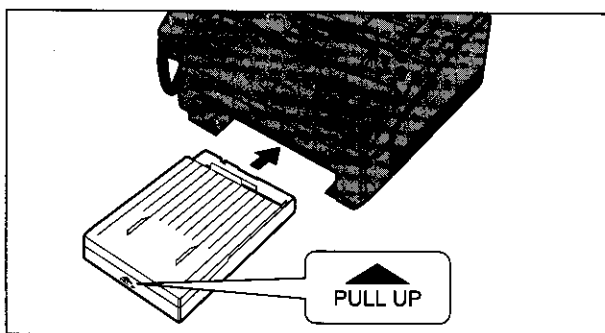
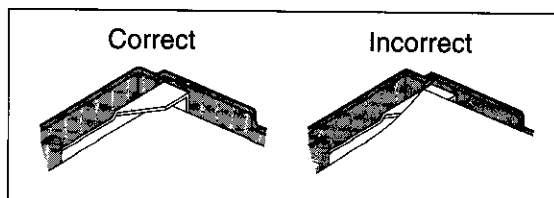

- 5 Close the paper cassette cover and insert the paper cassette into the unit until it clicks into place.

Note:

- Do not insert paper of different thickness into the cassette at same time. This may cause a paper jam.
- Avoid extremely smooth or shiny paper that is highly textured. Also avoid paper that is coated, damaged or wrinkled paper with a cotton and/or fiber content that is over 20 %.
- Avoid used paper for double-sided printing.
- Do not use paper printed with this unit for double-sided printing with other copiers or printers, or a paper jam may occur.

5

Installing the document stacker

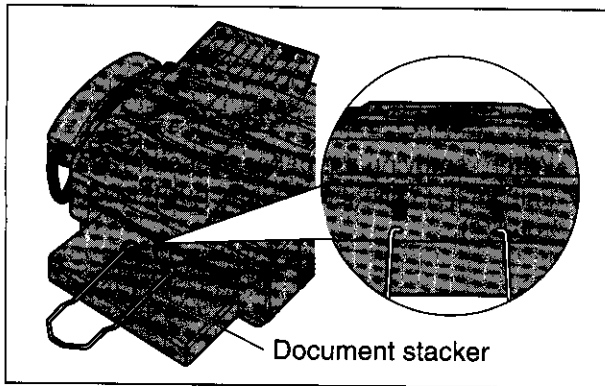

Referring to the illustration to the left, insert the document stacker with the bent side facing up until it clicks into place.

Helpful hint:

To extend the document stacker, pull it towards you until it clicks into place.

To save space, slide the document stacker into the unit until it clicks into place.

Installing the document feeder tray

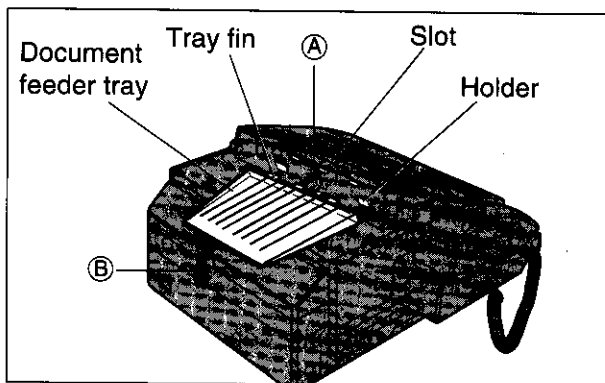

- 1 Insert the three tray fins into the slots of the unit (A).
- 2 Press down the tray to place it on the two holders (B).

Connections

1

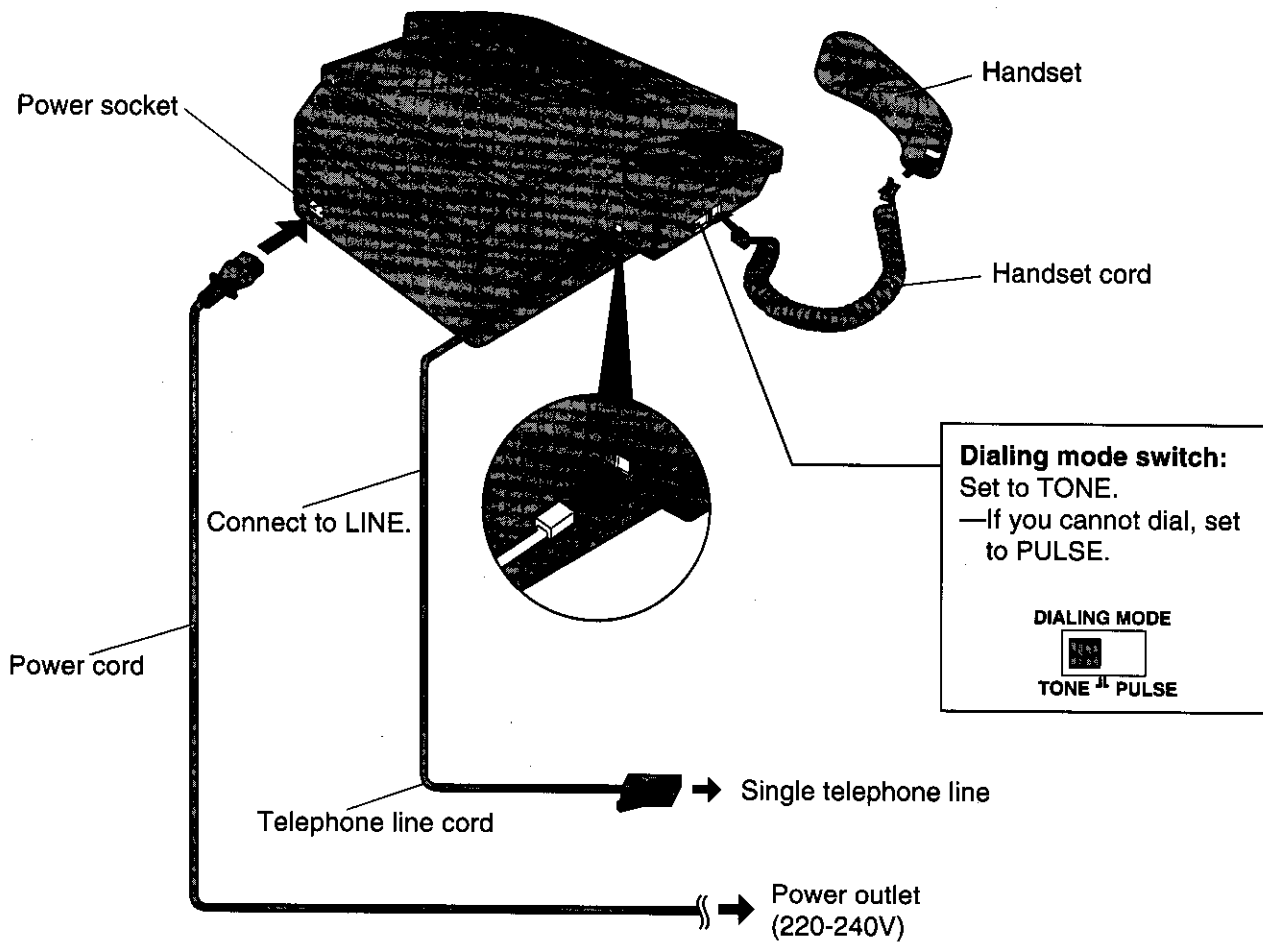

Note:

- When you operate this product, the power outlet should be near the product and easily accessible.
- The unit will not function during a power failure.
- You can connect an extension phone or a telephone answering machine to the unit after peeling off the tape on the external telephone jack (EXT.). See page 21.
- When you connect another telephone on the same line and if the decadic (pulse) signalling option is used, bell tinkle may occur during dialing. If this occurs, the matter should be discussed with the telephone supplier and should NOT be referred to Telecom Faults Service.
- Not all standard telephones will respond to incoming ringing when connected to the same line or the external telephone jack (EXT.).

Helpful hint:

If assistance is needed, press **HELP**. The unit will print a quick reference.

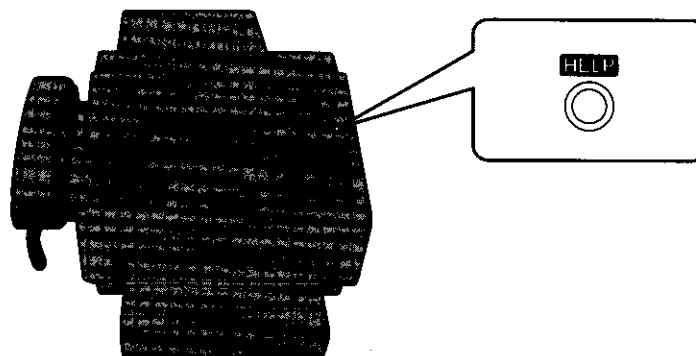

Location of controls

Front view

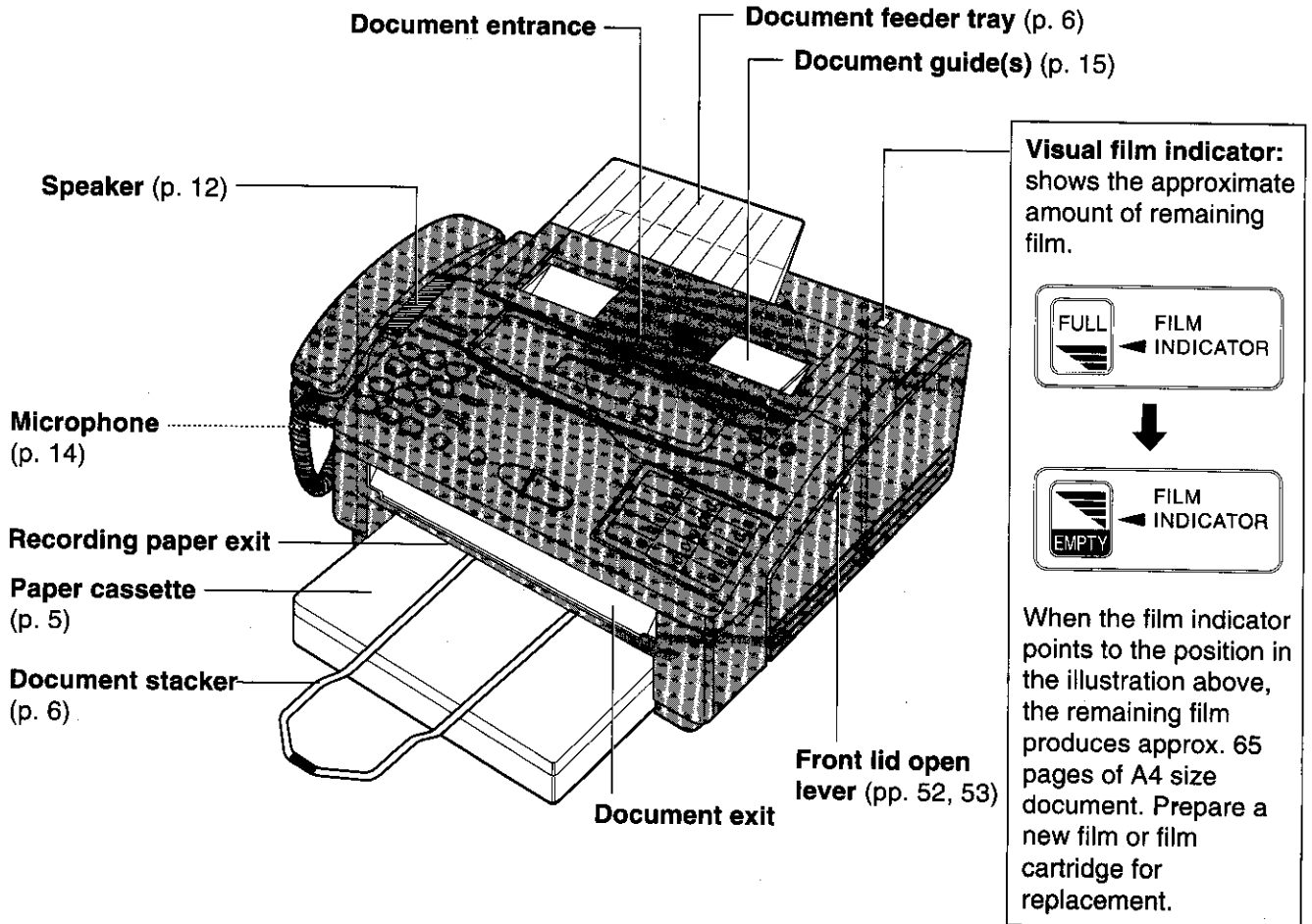

Note:

The visual film indicator will show "FULL" when a new 200 meter film is installed. When the included film cartridge (30 meter roll film) is installed, the indicator will not show "FULL".

Control panel

1

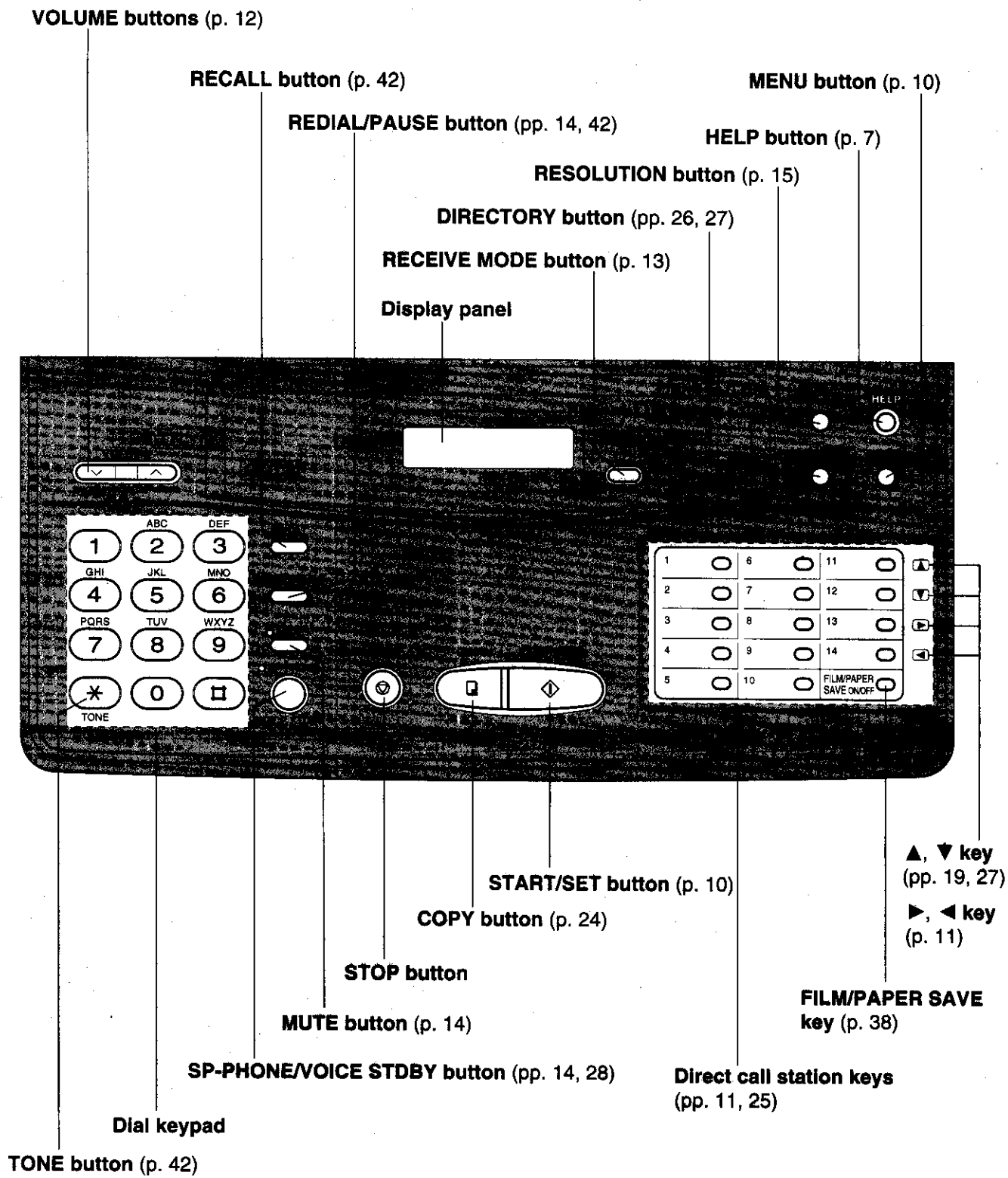

Before using your unit, program the following:

- Current date and time
- Your logo
- Your facsimile telephone number

This information will be printed on the top of each page transmitted from your unit.

Setting the date and time

1 Press **MENU**.
SYSTEM SET UP

2 Press **#**, then **01**.
SET DATE & TIME

3 Press **START/SET**.

4 Enter the correct month/day/year/hour/
minute by selecting each 2 digits.
Then press ***** for AM or press **#** for PM.

Example: Aug. 10 1996, 3:00PM

Press **08 10 96 03 00**,
then press **#** for PM.

5 Press **START/SET**.

6 Press **MENU**.

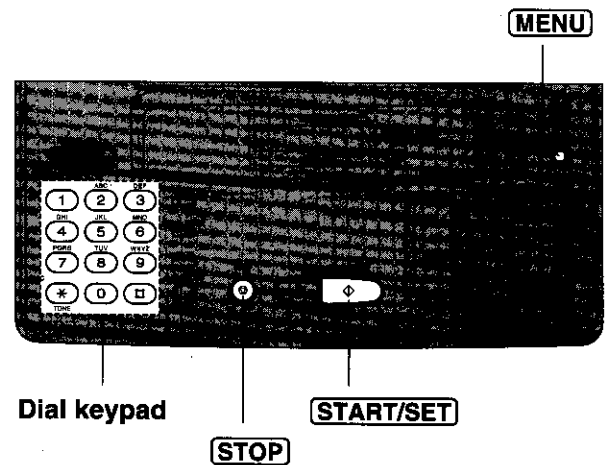

Note:

- When you make a mistake while programming, press **STOP** then make the corrections.
- The accuracy of the clock will be approximately ± 60 seconds a month.

Setting your logo

Usually the logo is a company, division or personal name in an abbreviated form.

1 Press **MENU**.
SYSTEM SET UP

2 Press **#**, then **02**.
YOUR LOGO

3 Press **START/SET**.
LOGO=

4 Enter your logo up to 30 characters.
(The preset logo will be cleared.)
•Refer to the instructions on page 11.

5 Press **START/SET**.

6 Press **MENU**.

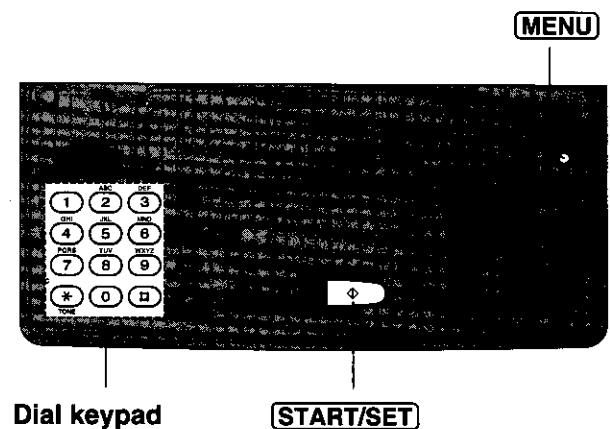

How to enter characters and symbols

The dial keypad and the direct call stations can be used as character input keys and command keys. Pressing 0-9 and direct call station 1 will alternately select a character as shown below.

Keys	Number of times												
	1	2	3	4	5	6	7	8	9	10	11	12	13
1	1	[]	{	}	+	-	/	=	,	.	_	'
2	A	B	C	a	b	c	2						
3	D	E	F	d	e	f	3						
4	G	H	I	g	h	i	4						
5	J	K	L	j	k	l	5						
6	M	N	O	m	n	o	6						
7	P	Q	R	S	p	q	r	s	7				
8	T	U	V	t	u	v	8						
9	W	X	Y	Z	w	x	y	z	9				
0	0	()	<	>	!	"	#	\$	%	&	¥	
1	:	;	?		*	@	^	'	→				
2	INSERT key (Used to insert one character or one space.)												
6	SPACE key (Used to replace one character with a space.)												
7	DELETE key (Used to delete one character.)												
13	▶ key (Used to move the cursor to the right.)												
14	◀ key (Used to move the cursor to the left.)												

For example, when entering "Mike" as your logo:

1 Press **6**, then press direct call station **13**.

LOGO=M

2 Press **4** six times, then press direct call station **13**.

LOGO=Mi

3 Press **5** five times, then press direct call station **13**.

LOGO=Mik

4 Press **3** five times.



LOGO=Mike

Note:

- If you make a mistake while programming, use direct call stations **13** and **14** to move the cursor to the incorrect character, then make the correction.
- The layout of the direct call station keys is printed on the reverse side of the directory card. Remove the directory card cover with a pencil or similar object and turn the directory card over.

2

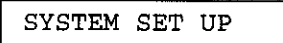
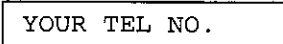
Setting your facsimile telephone number

- 1 Press **MENU**.

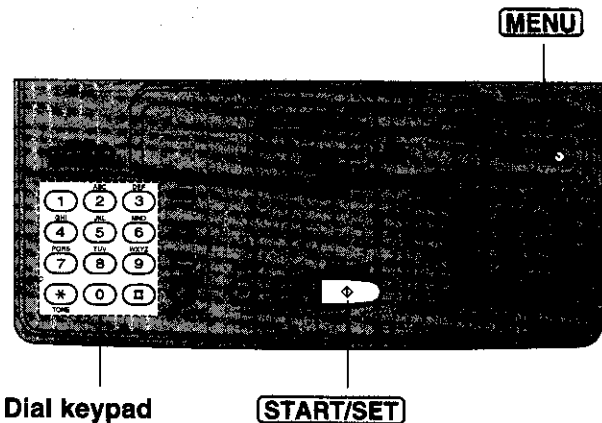
- 2 Press **#**, then **0** **3**.

- 3 Press **START/SET**.

- 4 Enter your facsimile telephone number up to 20 digits.
 - **#** button inserts a space and ***** button a "+".
- 5 Press **START/SET**.
- 6 Press **MENU**.



Note:
Logo, telephone number, date, time and page number will be printed outside of the document you send. To change the print position, see page 35.

Note for users in New Zealand:
Example: +64 9 1234567

Adjusting volumes

- **Ringer volume:** 3 levels (high/low/off) are available.
Press **VOLUME** (v/∧) while the unit is in an idle status.

To turn the ringer off:

1. Press **v** repeatedly.
 - The following messages will be shown alternately.

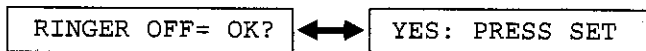

2. Press **START/SET**.

While the ringer volume is set to off:

The display will show the following message and the unit will not ring when receiving a call.

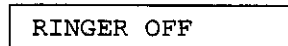

- **Handset volume:** 3 levels (high/middle/low) are available.
Press **VOLUME** (v/∧) when using the handset.
- **Speaker volume:** 8 levels (high to low) are available.
Press **VOLUME** (v/∧) when using the speakerphone.

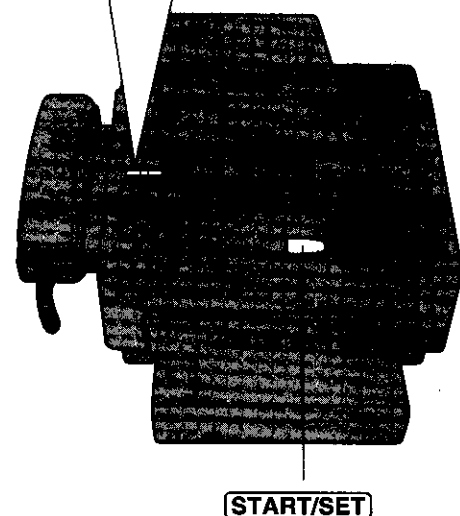
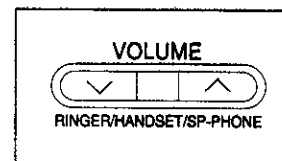

Selecting the receive mode

This unit combines the functions of facsimile and telephone. In addition, this unit provides a TAM (Telephone Answering Machine) interface. To perform these functions, this unit has four types of receive modes; TEL/FAX, FAX, TEL and EXT. TAM.

Regardless of the mode that you select, you can always place calls and send faxes. The descriptions below will help you understand how the unit can work for you.

TEL/FAX mode:

This mode can be used when you are near the unit and do not want to hear the unit ring when faxes are received but wish to answer voice calls. The unit will automatically receive fax documents without ringing when fax calls are received. You will not be disturbed by incoming faxes. The unit will generate a double ring when voice calls are received. If you do not answer by the last ring, the unit will switch to the fax mode to prevent missing any fax documents. For further details, see page 18.

FAX mode:

We recommend that you select this mode when you will be using the unit solely as a fax machine. The unit will automatically answer all calls and generate fax tones to the callers. Callers will hear fax tones and will only be able to transmit faxes. For further details, see page 20.

TEL mode:

This mode can be used when you wish to answer all calls manually. The unit will not automatically answer fax and voice calls. If you wish to answer a fax call, you can start reception by pressing the START/SET button. If no one answers an incoming call by 15 rings, the receive mode will switch to the TEL/FAX mode automatically.

EXT. TAM mode:

This mode can be used when you wish to connect a telephone answering machine (TAM) to the external telephone jack on your facsimile unit. When a call is received, the answering machine will play a greeting message. If a voice call is detected, the answering machine will begin recording, then caller can leave a voice message. If a fax call is detected, the facsimile unit will disconnect the answering machine and receive the fax documents. For further details, see page 21. If your external telephone does not have an answering/recording feature, do not select this mode. We recommend that you select the TEL/FAX or the TEL mode.

Select the desired mode by pressing **RECEIVE MODE** repeatedly. The arrow mark in the display shows your selection.

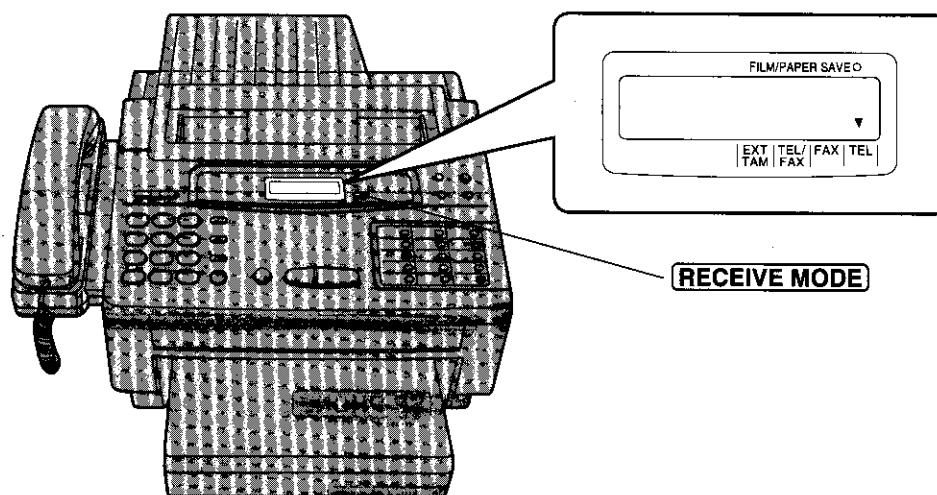

Making voice calls

- 1 Press **SP-PHONE** or lift the handset.
- 2 Dial a phone number.
 - If you misdial, hang up and dial again.
- 3 When the other party answers, speak into the microphone or handset.
- 4 When finished, press **SP-PHONE** again or replace the handset.

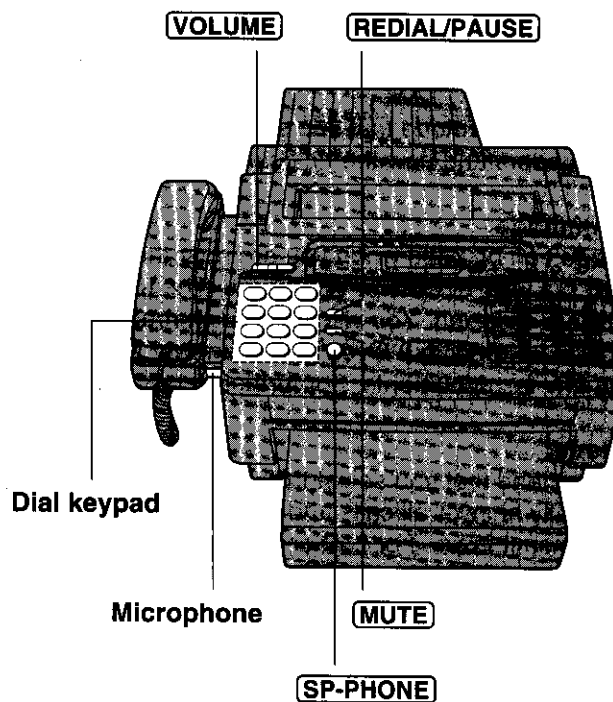

To redial the last number dialed

1. Press **SP-PHONE** or lift the handset.
2. Press **REDIAL/PAUSE**.
 - If the line is busy when using the speakerphone, the unit will automatically redial the number up to 2 times.

Voice muting

Using this feature, you can hear the voice of the other party, but the other party cannot hear your voice.

1. Press **MUTE** during a telephone conversation.
 - The MUTE indicator light goes on.
2. To resume the conversation, press **MUTE** again.

Hints for speakerphone operation

- Use the speakerphone in a quiet room for best performance.
- If the other party has difficulty hearing you, adjust the volume using **VOLUME**.
- If you and the other party speak at the same time, parts of your conversation will be lost.
- If you wish to switch to the handset from the speakerphone, lift the handset. To switch to the speakerphone, press **SP-PHONE**.

Answering voice calls

- 1 When the unit rings, lift the handset or press **SP-PHONE**.
- 2 To hang up, replace the handset or press **SP-PHONE**.

Transmitting documents

Loading documents

- 1 Insert the documents **FACE DOWN** until a beep tone is heard.
 - The unit can accept up to 15 sheets of paper at a time.
- 2 Adjust the document guides to the width of the documents.
- 3 Press **RESOLUTION** repeatedly to the desired setting.
 - The selected resolution will be shown on the display.

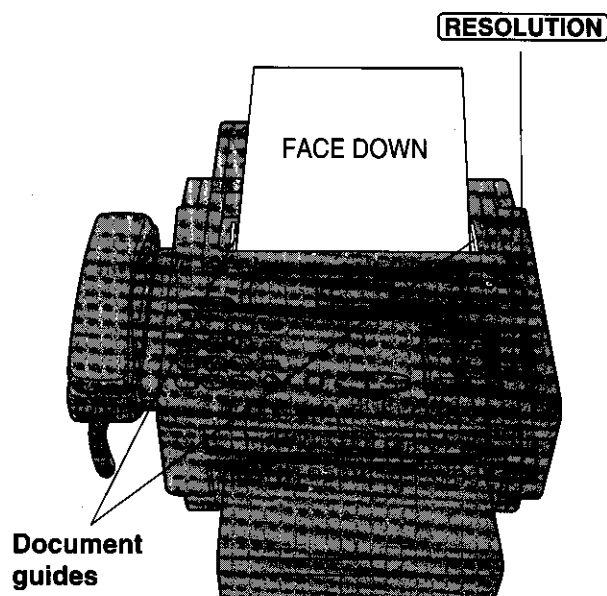

3

4

Selecting the resolution

STANDARD: Suitable for printed or typewritten originals with normal-sized characters.

FINE: Suitable for originals with small printing.

HALF TONE: Useful for originals containing photographs, shaded drawings, etc.

- Note that using the FINE or HALF TONE setting will increase transmission time.
- If the setting is changed during page feeding, it will be effective from the next sheet.

Transmitting documents manually

- 1 Insert the documents **FACE DOWN**.
- 2 Press **SP-PHONE** or lift the handset.
- 3 Dial a phone number.
 - If you misdial, hang up and dial again.
- 4 When a fax tone is heard, press **START/SET**.
- 5 Replace the handset if using it.

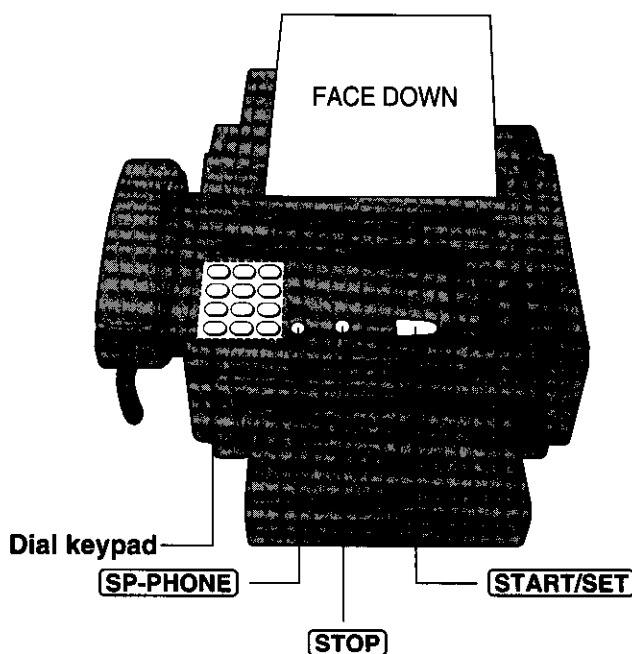

To stop transmission halfway

Press **STOP**.

Transmitting documents with fewer procedure

- 1 Insert the documents FACE DOWN.
- 2 Dial a phone number.
 - If you misdial, press **STOP** and dial again.
- 3 Press **START/SET**.
 - The unit will start to dial and transmit the documents.

Note:

If there is no answer or the line is busy, the unit will automatically redial the number up to 2 times.
To cancel redialing, press **STOP**.

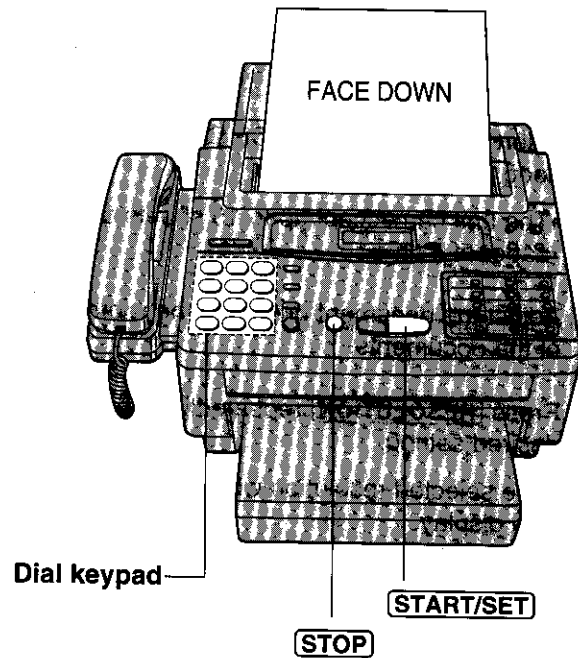

To send 16 or more sheets at a time

Insert the first 15 sheets of the documents. Add the extra sheets (up to 15) before the last sheet is fed into the unit.

Documents you can send

Minimum size

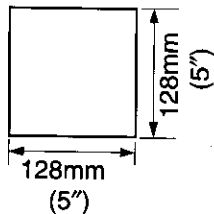

Maximum size

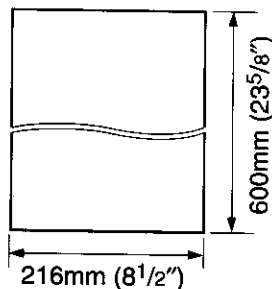

Effective scanning area

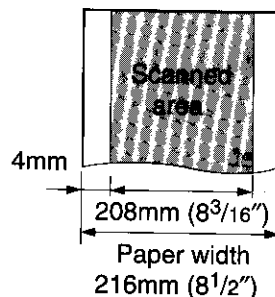

Document weight

Single sheet:
45 to 90 g/m² (12 to 24 lb.)
Multiple sheets:
60 to 75 g/m² (16 to 20 lb.)

Note:

- Remove clips, staples or other similar fastening objects from a document.
- Check that ink, paste or correction fluid on the documents have completely dried.
- Do not feed the following types of documents into the unit. Make copies of these documents by using a copier then use these copies for fax transmission.
 - Paper with a chemically treated surface such as carbon paper or carbonless duplicating paper
 - Electrostatically charged paper
 - Heavily curled, creased or torn paper
 - Paper with a coated surface
 - Paper with faint contrast between the printing and the background
 - Paper with printing on the reverse side that can be seen through the front (e.g. newspaper)

Manual reception

- 1 When the unit rings, press **SP-PHONE** or lift the handset to answer the call.
- 2 When:
 - document reception is required,
 - a slow beep is heard, or
 - no sound is heard,press **START/SET**.
- 3 Replace the handset if using it.
 - The unit will start reception.

To stop reception halfway

Press **STOP**.

Note:

- When receiving an over-sized document, the unit will divide it into two or more pages when printing out.
- If an appropriate reduction rate (page 37) is set, the unit can print an over-sized document on one page.

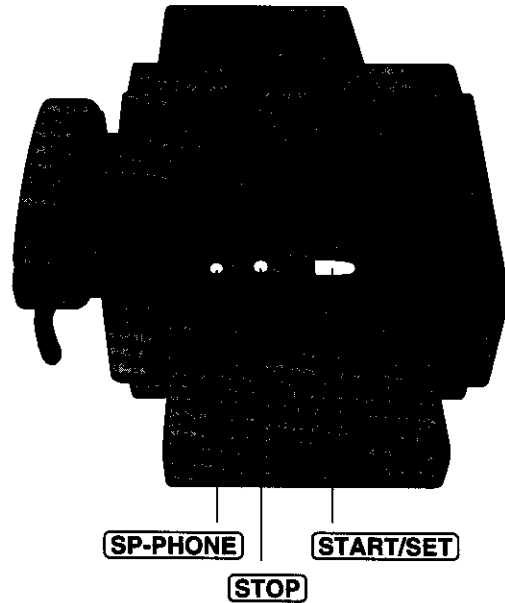

4

Automatic reception

Set to the TEL/FAX, FAX, or EXT. TAM mode by pressing **RECEIVE MODE**.

When a fax call is received, the unit will automatically activate the fax function to receive documents.

Caution:

Do not let more than 100 sheets of 75 g/m² (20 lb.) paper accumulate at one time on the paper cassette. This may cause a paper jam.

Receiving in the TEL/FAX mode

When a call is received, the unit will work as follows.

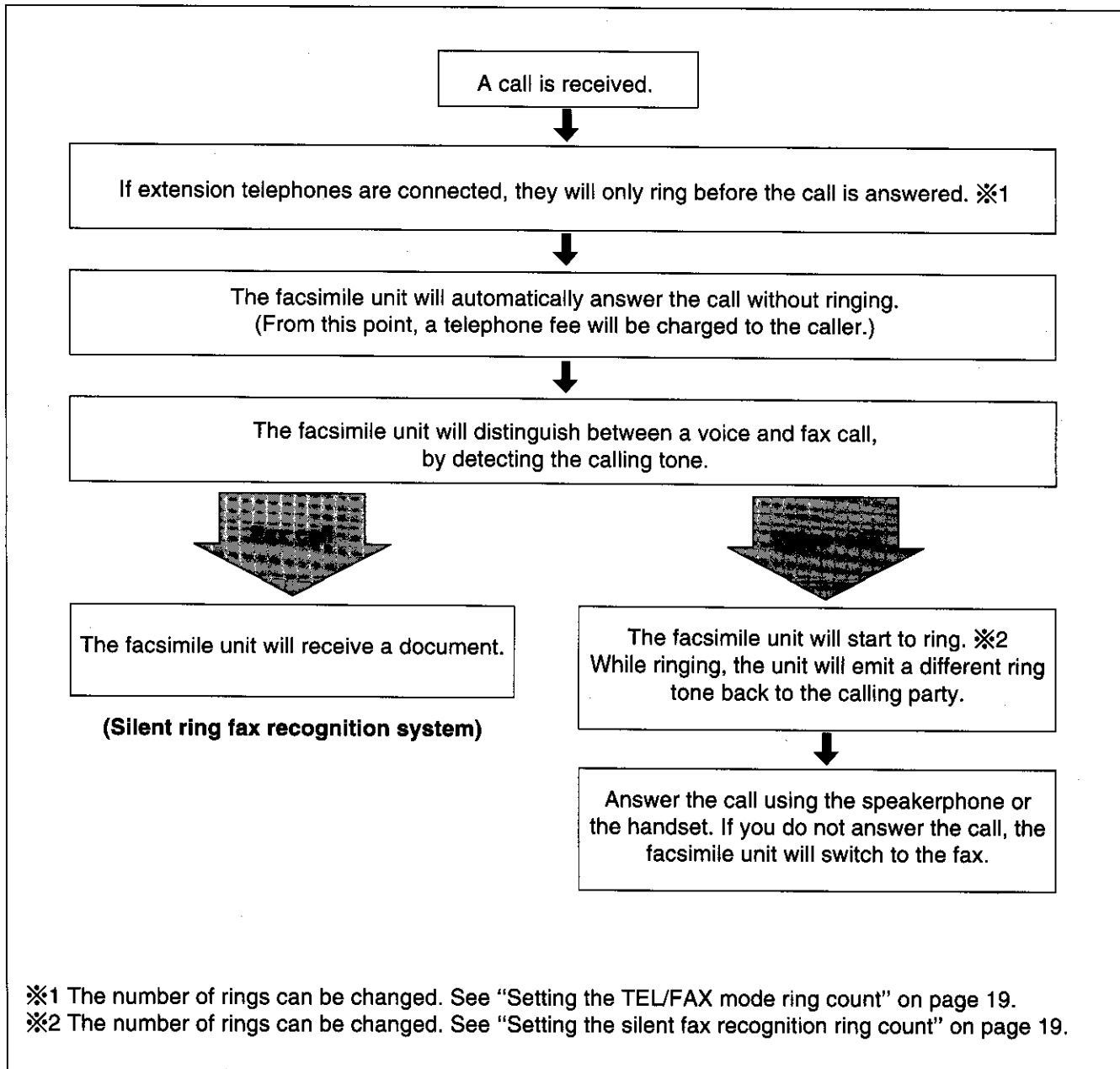

※1 The number of rings can be changed. See "Setting the TEL/FAX mode ring count" on page 19.

※2 The number of rings can be changed. See "Setting the silent fax recognition ring count" on page 19.

Note:

Some fax messages which are transmitted manually may not be sent using a calling tone. These calls must be received manually.

Setting the TEL/FAX mode ring count

You can choose from 2 to 9 toll rings.

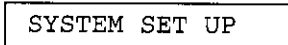
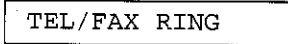
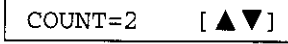
- 1 Press **MENU**.

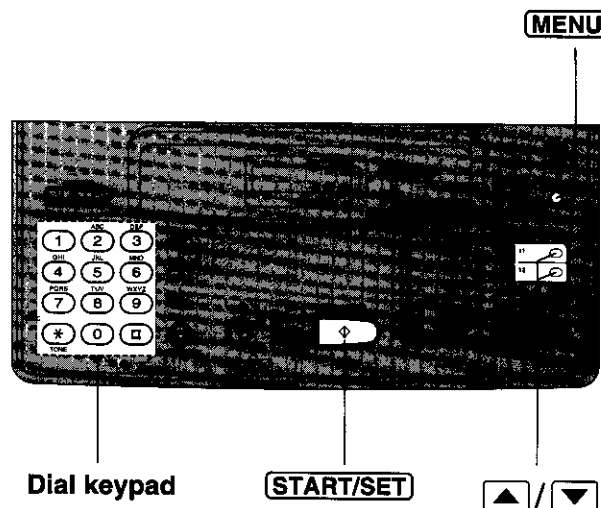
- 2 Press **#**, then press **06**.

- 3 Press **START/SET**.

- 4 Press **▲** or **▼** to select the desired number of rings.
- 5 Press **START/SET**.
- 6 Press **MENU**.



Note:

- If you find difficulty in receiving faxes from machines that have an automatic transmission feature, decrease the number of rings.

Setting the silent fax recognition ring count

When a fax call is received in the TEL/FAX mode, the unit will automatically activate the fax function without ringing. If the unit detects a voice call, it will ring. The number of rings can be set from 3 to 6.

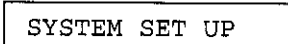
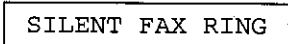
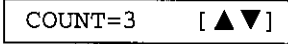
- 1 Press **MENU**.

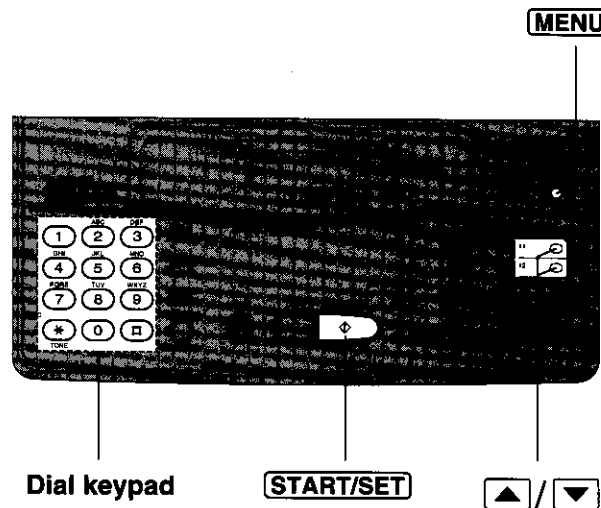
- 2 Press **#**, then press **30**.

- 3 Press **START/SET**.

- 4 Press **▲** or **▼** to select the desired number of rings.
- 5 Press **START/SET**.
- 6 Press **MENU**.





Receiving in the FAX mode

When a call is received, the unit will ring and activate the fax function.

Setting the FAX mode ring count

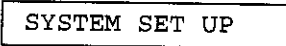
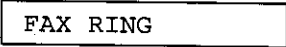
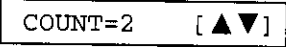
You can choose from 2 to 9 rings.

- 1 Press **MENU**.

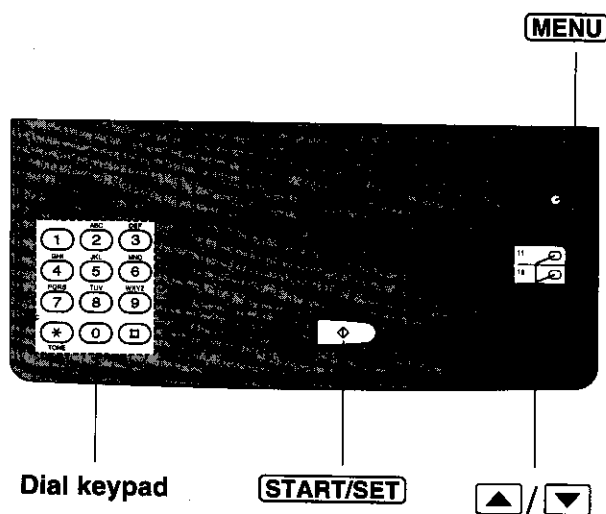
- 2 Press **#**, then press **07**.

- 3 Press **START/SET**.

- 4 Press  or  to select the desired number of rings.
- 5 Press **START/SET**.
- 6 Press **MENU**.



Note:

- If you wish to be able to answer a call before the unit does, increase the number of rings.
- If you find difficulty in receiving faxes from machines that have an automatic transmission feature, decrease the number of rings.

Receiving in the EXT. TAM mode

This mode is used only when an EXTERNAL Telephone Answering Machine (EXT. TAM) has been connected to the facsimile unit.

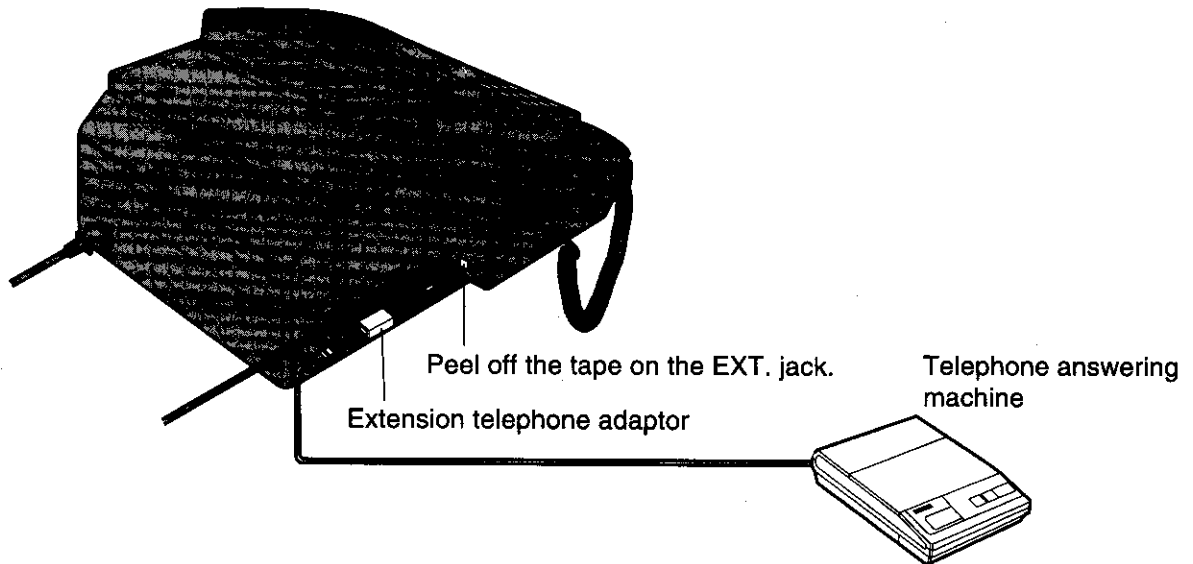

4

When a call is received, the incoming voice message will be recorded on the answering machine, and a fax message will be received on the facsimile unit.

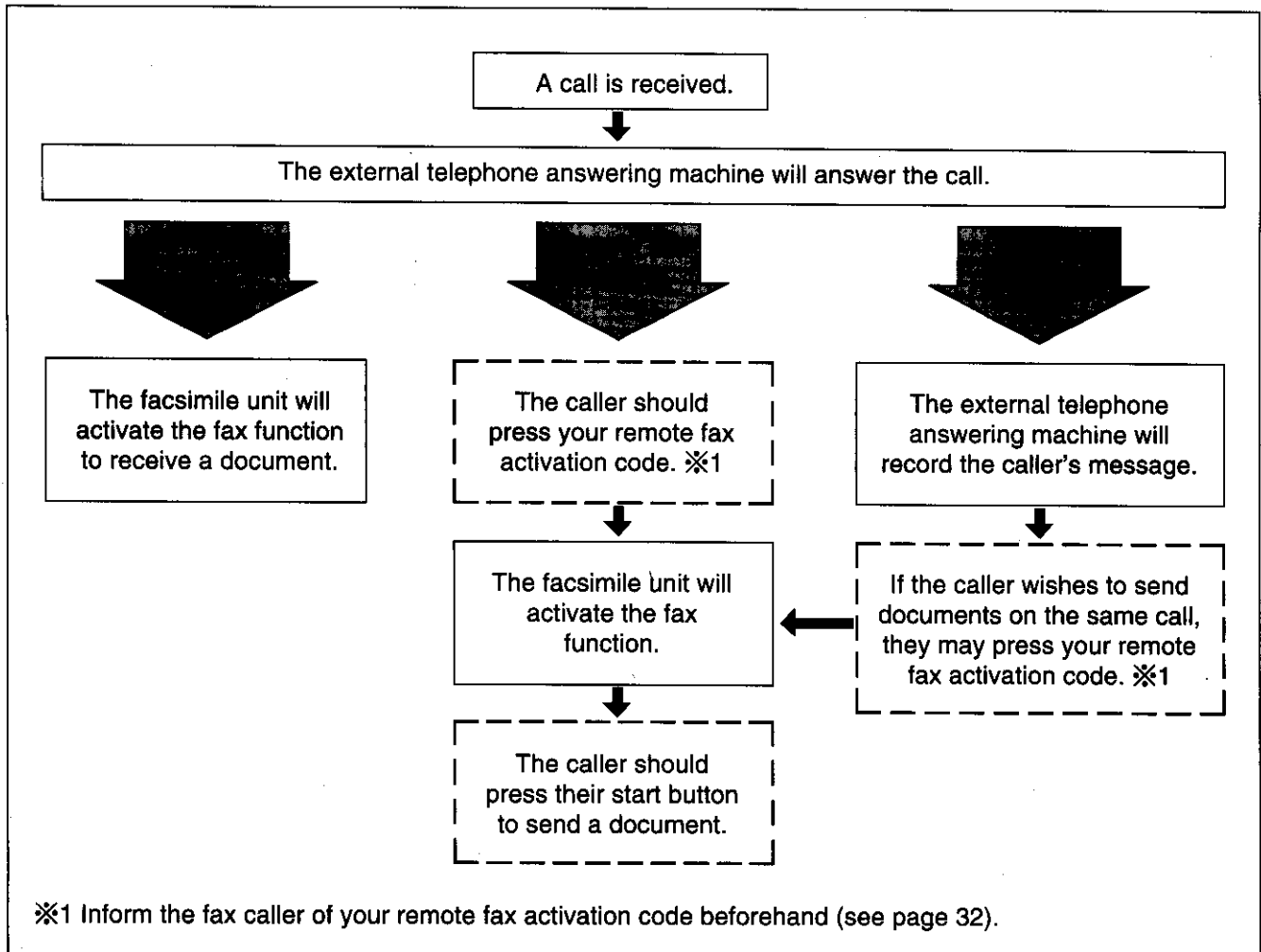

Setting up the answering machine

1. Set the desired number of rings (1 to 4) on the telephone answering machine.
2. Record a greeting message referring to the example below.
"This is (your name, business and/or telephone number). We are unable to answer the phone right now. Please leave a message after the long beep. To send a fax, dial my remote fax activation code and start transmission. Thank you."
 - Do not pause for more than 4 seconds in the message.
 - Your message can be 8 to 16 seconds long. We recommend you to keep it around 10 seconds in length.
 - Inform the fax caller of your remote fax activation code beforehand (see page 32).
3. If your answering machine is equipped with a remote operation feature, you must set the same access code (remote TAM activation ID) as stored on the answering machine in the unit's memory. See below.

Helpful hint:

Transmit the leaflet on page 59 to several of your associates. This way, you can tell them the procedure for transmitting documents and/or recording voice-messages.

Setting the remote TAM activation ID

Set the same ID code on the facsimile unit as programmed on your answering machine.

Important:

Note that this code should be different from the remote fax activation code (see page 32) and the junk mail prohibitor ID (see page 33).

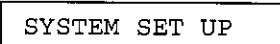
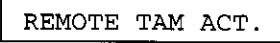
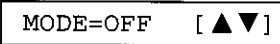
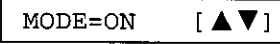
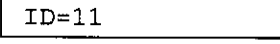
- 1 Press **MENU**.

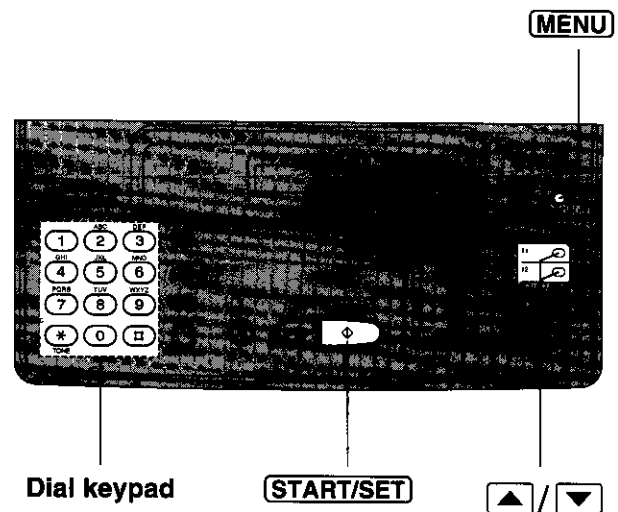
- 2 Press **#**, then press **11**.

- 3 Press **START/SET**.

- 4 Press **▲** or **▼** to select "ON".

- 5 Press **START/SET**.

 - The display shows the current ID pre-selected.
- 6 Enter the new ID number.
- 7 Press **START/SET**.
- 8 Press **MENU**.



Setting the silent detection

This feature allows the facsimile unit to activate the fax function automatically when a silent pause longer than 4 seconds is detected in the EXT. TAM mode.

Helpful hints:

- If you wish to receive documents from stations that do not send a calling tone after dialing, activate this feature.
- If you use a single cassette tape to give a greeting message and to record incoming messages, deactivate this feature.

- 1 Press **MENU**.
SYSTEM SET UP
- 2 Press **#**, then press **38**.
SILENT DETECT.
- 3 Press **START/SET**.
MODE=ON [▲▼]
- 4 Press **▲** or **▼** to select the desired mode.
- 5 Press **START/SET**.
- 6 Press **MENU**.

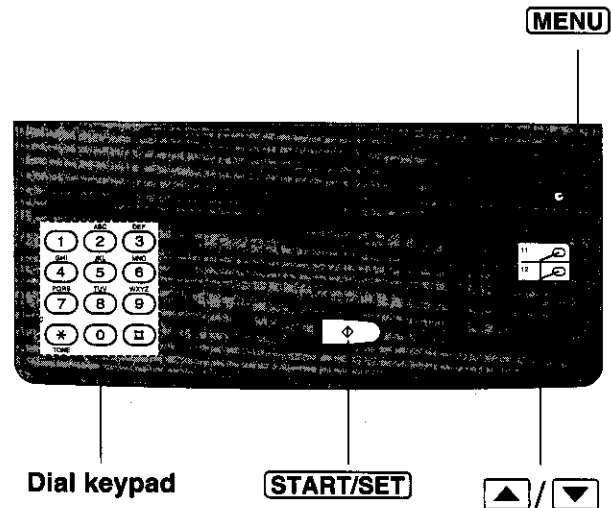

Notice when using with an answering machine

- Every time the facsimile unit receives a document, a silent pause or a fax tone may be recorded on the tape.
- Advise callers that they should not pause for over 4 seconds while recording their voice messages. Otherwise, the facsimile unit may switch to the fax function.
- When your answering machine runs out of recording tape, your facsimile unit may not be able to receive a document. Rewind the tape and prepare for recording.
- When you set the answering machine to give only a greeting message, fax reception may not be available. We recommend to set your answering machine to record messages.
- If you answer a call with the answering machine and pause for over 4 seconds, the facsimile unit may switch to the fax function and you may not be able to talk with the other party. To continue the conversation, press **STOP** on the facsimile unit.
- When the answering machine does not answer a call after 6 rings, the facsimile unit will activate the fax function.
- Set the receive mode of the facsimile unit to the TEL mode under the following conditions:
 - when you wish to set the number of rings on the answering machine to more than 6, or
 - when you wish to use auto transfer functions (transfer, pager alert, etc.) on the answering machine.Note that automatic fax sending can not be received automatically in the TEL mode.

Making a copy

- 1 Insert the documents FACE DOWN.
 - The unit can make a copy of up to 15 sheets of paper at a time.
- 2 Press **COPY**.
 - The unit will start copying.

To stop copying halfway

- Press **STOP**.
- The unit will stop copying and eject the documents.

Note:

- Any transmittable document can be copied (see page 16).
- When copying, the unit will automatically select FINE resolution.
- To change the resolution, press **RESOLUTION**.
- You can make or receive a voice call while making a copy.

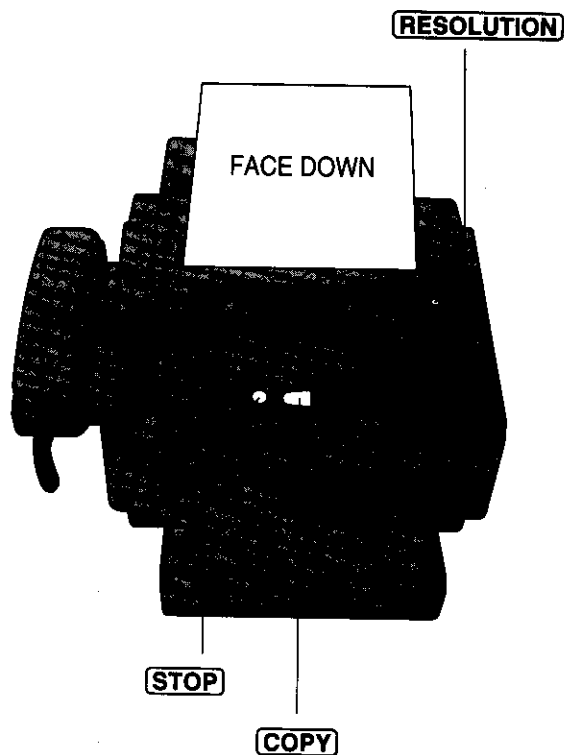

The unit's memory allows you to use both one-touch dialing and speed dialing for rapid access to your most frequently dialed numbers.

One-touch dialing: The unit is equipped with 14 direct call station keys.

Speed dialing: The unit is equipped with 60 additional dialing stations. These stations are assigned to 2-digit numbers (00-59).

Storing Tel/Fax numbers

1 Press **MENU** until the following message is displayed.

STORE TEL NO.

2 **For one-touch dialing:**
Press one of the direct call station keys.

For speed dialing:

Press **#**, then press the desired 2-digit number (00-59).

3 Enter the phone number up to 30 digits in length.

•To enter a hyphen in a phone number, press **HYPHEN** (direct call station 8).

4 Press **START/SET** to store the number.

NAME=

5 Enter the station name, up to 10 characters, by following the instructions on page 11.

6 Press **START/SET** to store the station name.

•To program other stations, repeat from step 2.

7 Press **STOP** to end the program.

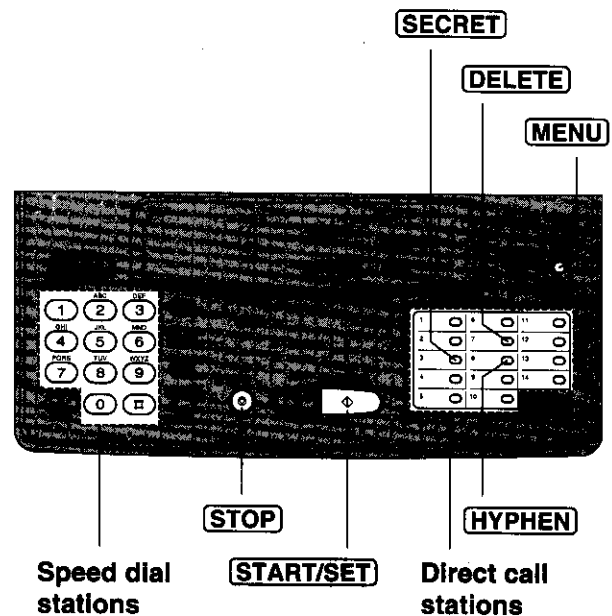

Helpful hint:

To confirm stored phone numbers and station names, print a telephone number list (see page 43).

To keep a whole or a portion of the phone number secret

Press **SECRET** (direct call station 3) before and after the number you wish to keep secret.

- The phone number will not appear on the display and on the telephone number list.
- Pressing the **SECRET** key once counts as two digits.

To erase a stored number and station name

Press **STOP** in step 3 to clear the phone number.

Press **DELETE** (direct call station 7) repeatedly in step 5 until all the characters are erased.

Making voice calls using automatic dialing

- 1 Press **SP-PHONE** or lift the handset.
- 2 **Using one-touch dialing:**
Press the desired direct call station key.

Using speed dialing:

Press **DIRECTORY**, then press **#** and the desired 2-digit number (00-59).

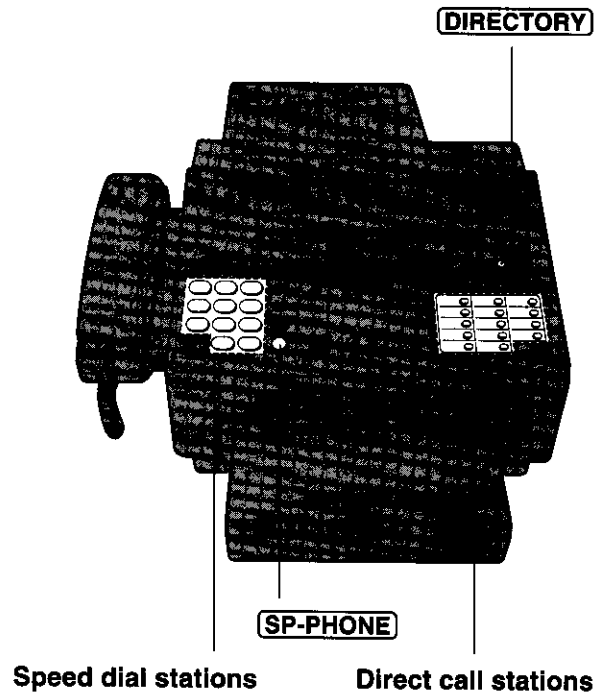

Transmitting documents using automatic dialing

- 1 Insert the documents FACE DOWN.
- 2 **Using one-touch dialing:**
Press the desired direct call station key.

Using speed dialing:

Press **DIRECTORY**, then press **#** and the desired 2-digit number (00-59).

Automatic redialing

If there is no answer or the line is busy, the unit will automatically redial the number up to 2 times.

To cancel the redialing, press **STOP**.

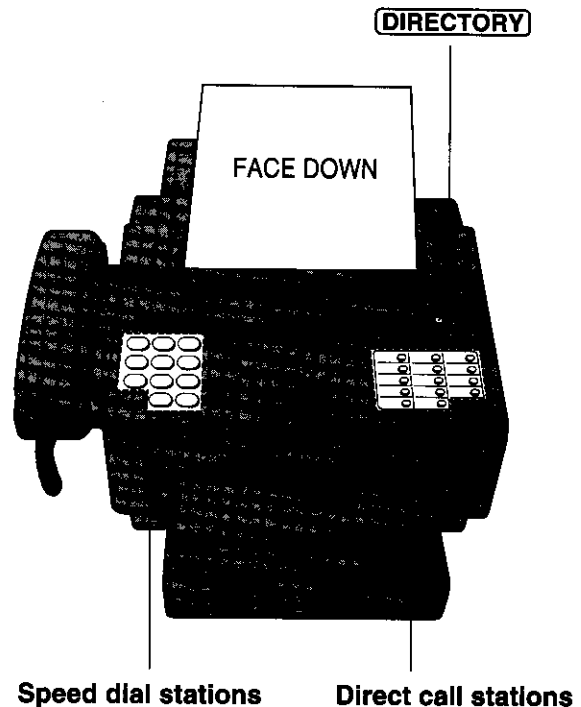

Electronic telephone directory

The station names stored in memory will be automatically registered into the electronic telephone directory in alphabetical order. You can make a fax or voice call by selecting the desired station name on the display.

If you wish to send a fax, insert the documents into the document feeder first.

1 Press **DIRECTORY**.

SELECT INDEX

2 Press the dial key in which the first initial of a station name is assigned (see index table below).

Example: To search a name with initial "N":
Press **6** repeatedly until the first station name with initial "N" is displayed. Press **▼** until the desired name is displayed.

or

Press **▲** or **▼** repeatedly until the desired name is displayed.

3 Press **START/SET**.

- The unit will start dialing.
- If a document is fed into the unit, the unit will start transmission.

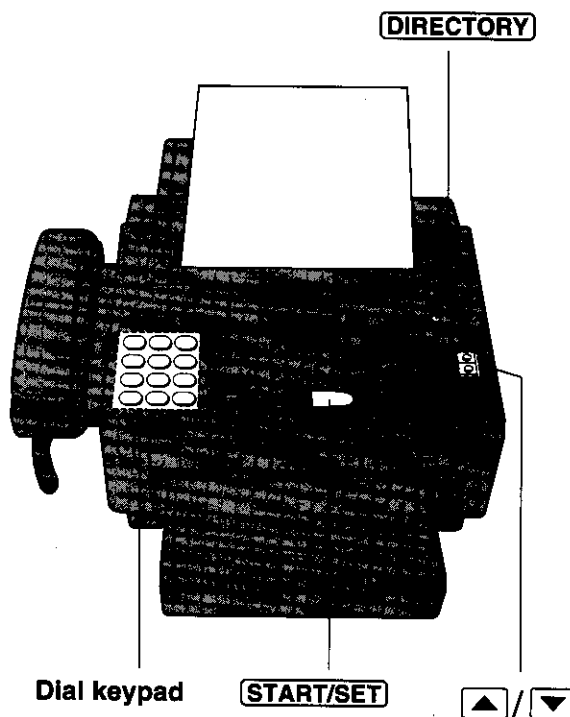

6

Dial key	Index	Dial key	Index
1	1	7	P, Q, R, S, 7
2	A, B, C, 2	8	T, U, V, 8
3	D, E, F, 3	9	W, X, Y, Z, 9
4	G, H, I, 4	0	0
5	J, K, L, 5	*	Other symbols
6	M, N, O, 6	#	(Used for speed dialing)

Voice contact

Initiating voice contact

You can have a voice conversation with the same call after the fax message is completed. This will save the extra expense and time of making another call.

Important:

This feature works only when the other party's unit is equipped with a voice contact feature.

- 1 Press **SP-PHONE/VOICE STDBY** while transmitting or receiving documents.

VOICE STANDBY

- Your unit will call the other party with a distinctive ring.

- 2 When the other party answers, the unit will emit a distinctive ring. Press **SP-PHONE/VOICE STDBY** or lift the handset to start speaking.

- If you initiate voice contact during transmission, you can speak after all the documents have been transmitted.
- If you initiate voice contact during reception, you can speak after the current page of the document is received.

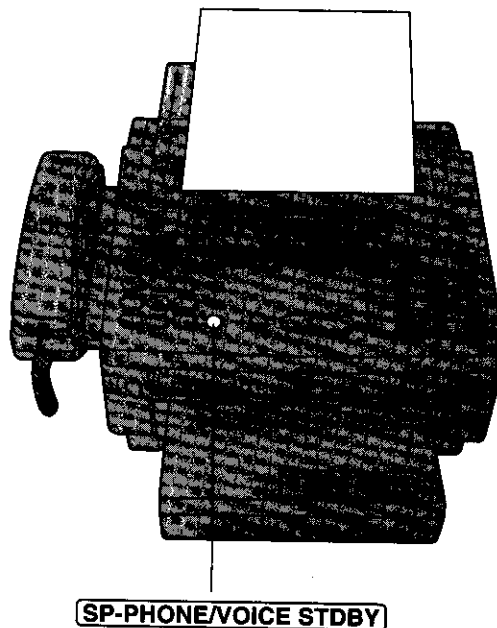

Receiving a request for voice contact

If the other party initiates voice contact, your unit will emit a distinctive ring after transmission or reception is completed.

When the distinctive ring is heard, press **SP-PHONE/VOICE STDBY** or lift the handset, then start speaking.

Note:

If you do not answer within 10 seconds of hearing the distinctive ring, the line will be automatically disconnected.

Polling

The polling feature allows you to receive a document from another compatible machine where you pay for the call as opposed to the document being sent to you, thereby saving the other party call charges. This unit can perform both receive and transmit polling.

Receive polling

To place a call and recover a document from another machine, follow the steps below. Make sure that no documents have been fed into your unit and that the other party's machine is ready for your call.

- 1 Press **MENU** until the following is displayed.

POLLING
- 2 Press **START/SET**.

NO. =
- 3 Enter the phone number by using one-touch dialing, speed dialing, full number dialing or electronic telephone directory.
- 4 Press **START/SET**.

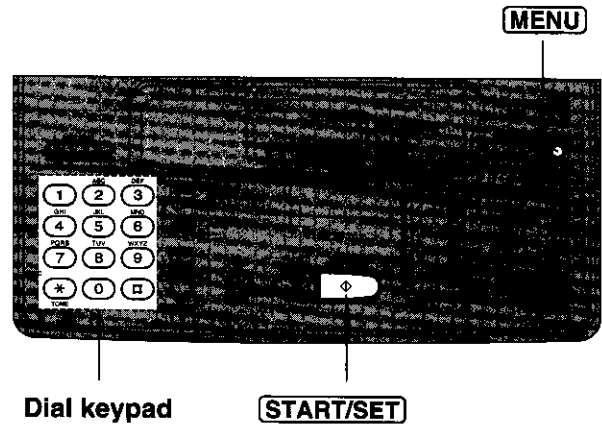

Note:

- If there is no answer or the line is busy, the unit will automatically redial the number up to 2 times.
- The receiving unit incurs any telephone charges.

Transmit polling

A document stored in your unit can be recovered by another party's machine. To let other machines retrieve documents loaded on your unit, proceed as follows.

- 1 Press **RECEIVE MODE** to select the EXT. TAM, TEL/FAX or FAX mode.
- 2 Insert the documents FACE DOWN.
- 3 Press **MENU** until the following is displayed.

POLLED
- 4 Press **START/SET**.

MODE=OFF [▲▼]
- 5 Press **▲** or **▼** to select "ON".

MODE=ON [▲▼]

• If this feature is not required, select "OFF".
- 6 Press **START/SET**.

POLLED ON

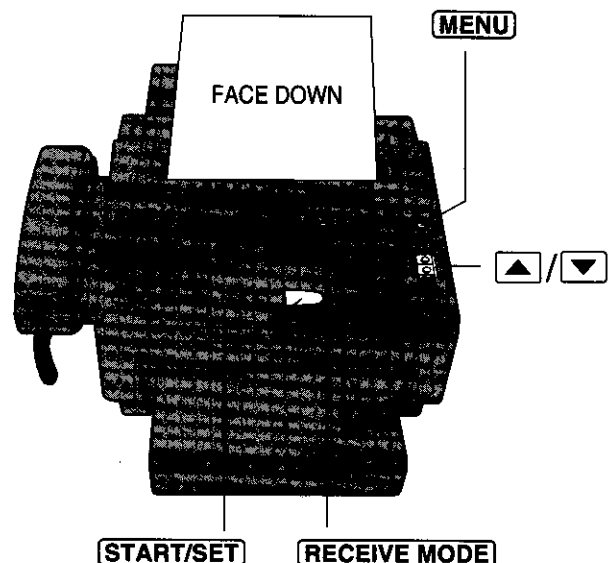

Note:

- When delayed transmission (page 30) is set to ON, this feature is not available.

Delayed transmission

The unit can send fax documents automatically at a specific time. This allows you to take advantage of low-cost calling hours offered by your telephone company. Delayed transmission can be programmed up to 24 hours in advance.

1 Insert the documents FACE DOWN.

2 Press **MENU**.

SYSTEM SET UP

3 Press **#**, then press **2** **5**.

DELAYED XMT

4 Press **START/SET**.

MODE=OFF [▲▼]

5 Press **▲** or **▼** to select "ON".

MODE=ON [▲▼]

•If this feature is not required, select "OFF".

6 Press **START/SET**.

NO. =

7 Enter the phone number by using one-touch dialing, speed dialing, full number dialing or electronic telephone directory.

8 Press **START/SET**.

TIME=12:00AM

9 Enter the transmission start time.

Example: 11:00PM

Press **1100**, then
press **#** to select PM.
To select AM, press *****.

10 Press **START/SET**.

11 Press **MENU**.

•When the programmed time has come, the unit will automatically start transmission.

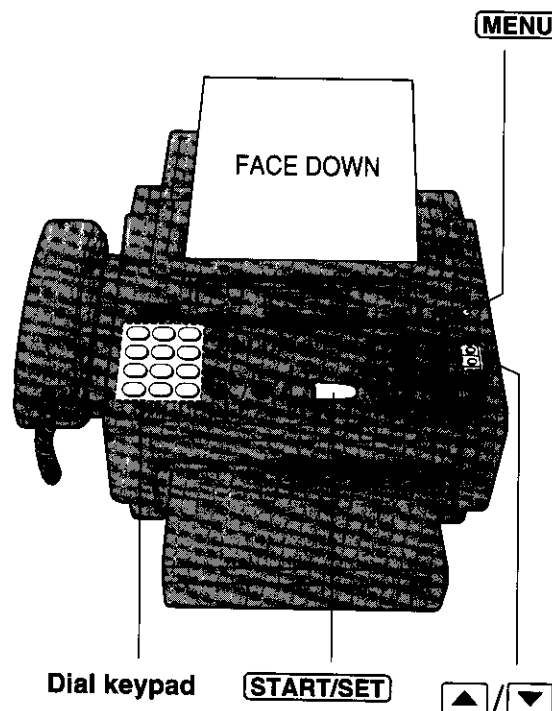

Note:

- If there is no answer or the line is busy, the unit will automatically redial the number up to 2 times.
- You can receive, transmit and copy documents while delayed transmission is set.
- If the programmed start time has passed during a power failure, delayed transmission will be attempted soon after power is restored.
- When transmit polling (see page 29) is set to ON, delayed transmission is not available.

Reserving transmission during a fax reception

While the unit is receiving documents, you can reserve your fax transmission to another station. The unit will automatically transmit documents after fax reception is complete.

- 1 Insert the documents **FACE DOWN** during fax reception.
- 2 Enter the phone number by using one-touch dialing, speed dialing, full number dialing or electronic telephone directory.

•When using full number dialing, press **START/SET**.

XMT RSV. ON

To cancel the reservation

Remove the documents from the document feeder tray.

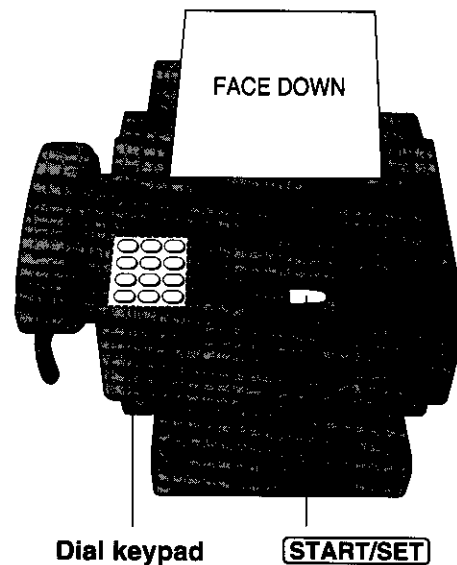

Printing a cover page

The unit can print a cover page to attach to documents you send.

Sample of a cover page

[FAX COVER PAGE]

TO : NAME : _____ DATE : _____
 FAX NO. : _____

FROM : NAME : _____
 FAX NO. : _____

Number of pages : _____ (including cover page)

Subject / Notes : _____

To print a cover page, proceed as follows:

- 1 Press **MENU** until the following is displayed.

PRINT LIST

- 2 Press **#**, then **7**.

FAX COVER PAGE

- 3 Press **START/SET** to start printing.

PRINTING

- 4 Press **MENU**.

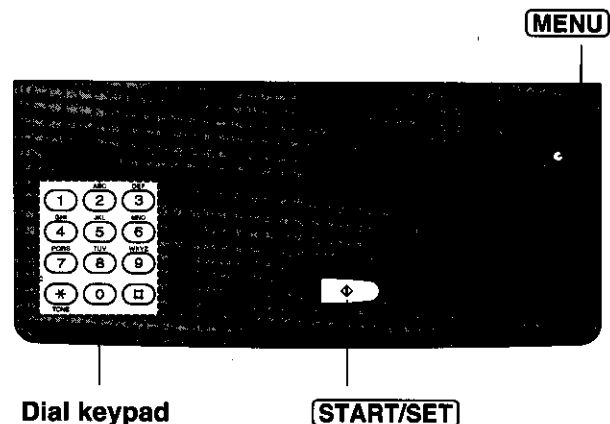

Remote fax receiving using an extension

If you have an extension phone connected to your facsimile unit or on the same line, it is possible to receive a fax message to your facsimile unit. Using the extension phone, dial the remote fax activation code. This saves you from going to the facsimile unit and pressing **START/SET**.

Important:

- To activate this feature, use a touch tone telephone as the extension phone.
- The remote fax activation code is set to "*9" as a preselected setting.

Using an extension

- 1 When a call is received, lift the handset of the extension phone.
- 2 When:
 - document reception is required,
 - a slow beep is heard, or
 - no sound is heard,press *9 (remote fax activation code).
- 3 Replace the handset.
 - The facsimile unit will activate the fax function to receive documents.

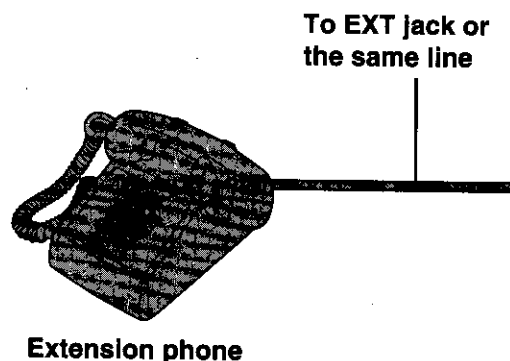

Changing the remote fax activation code

This code can be from 2 to 4 digits in length using the numbers 0 through 9 and the character *. This code should not be set to "0000".

- 1 Press **MENU**.
SYSTEM SET UP
- 2 Press **#**, then **4****1**.
REMOTE FAX ACT.
- 3 Press **START/SET**.
CODE= *9
- 4 Enter the new code number.
- 5 Press **START/SET**.
- 6 Press **MENU**.

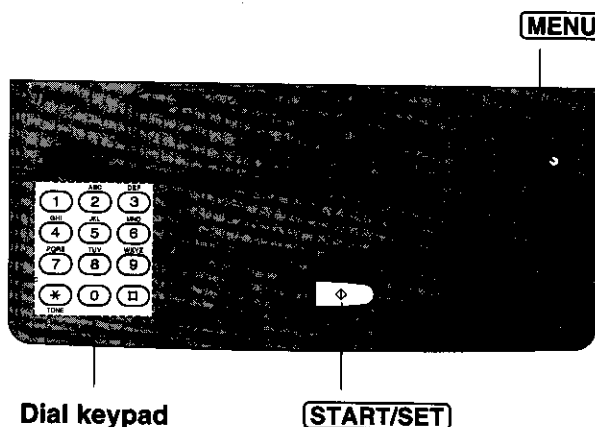

Note:

Some special telephone company services will require you to press a service access code. If you subscribe to such services, the whole or part of the remote fax activation code must be different from the service access code.



Junk mail prohibitor

This feature prevents reception from facsimile machines whose phone numbers are not stored in automatic dialing.

Important:

- This feature is available when the unit is in the EXT. TAM, TEL/FAX or FAX mode.
- This feature does not work under the following conditions:
 - when manual reception is performed, or
 - the other party does not program their facsimile ID number correctly.
- If you wish to receive documents from unauthorized machines, inform your junk mail prohibitor ID to callers, and ask them to transmit documents manually.
- The junk mail prohibitor ID must be different from the first 2 digits of the remote TAM activation ID (page 22). e.g. if the remote TAM activation ID is "321", do not use "32" as a junk mail prohibitor ID.

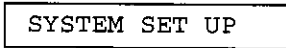
Setting the junk mail prohibitor

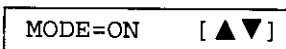
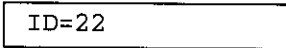
- 1 Press **MENU**.

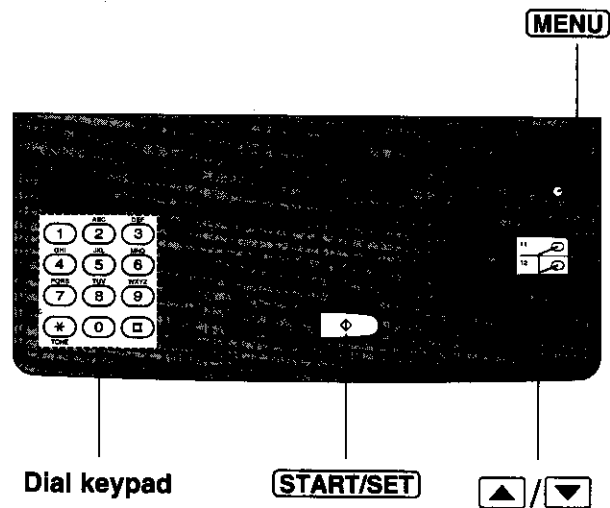
- 2 Press **#**, then **24**.

- 3 Press **START/SET**.

- 4 Press **▲** or **▼** to select "ON".

 - If this feature is not required, select "OFF".
- 5 Press **START/SET**.

- 6 To change the junk mail prohibitor ID, enter the desired 2-digit number.
 - 0, # and * cannot be used.
- 7 Press **START/SET**.
- 8 Press **MENU**.



7

Transmitting documents to your unit with the prohibitor ID

Even if the junk mail prohibitor feature is activated, a designated caller will be able to transmit documents. Give your junk mail prohibitor ID to all your designated callers, and advise them of the following steps. This operation is available only when your unit is in the TEL/FAX or EXT. TAM mode.

1. Call your unit from a touch tone telephone.
2. Listen for the different ring tone or greeting message.
3. Dial the prohibitor ID.
4. Listen for the fax tone, and start transmission.

Receiving with distinctive ring service

Note for users in New Zealand: This service is called FaxAbility.

This feature is only for use if you subscribe to a distinctive ring pattern service from your telephone company. For more information on the availability of this service, please contact your telephone company before setting this feature on your unit.

The distinctive ring service gives you an additional phone number on a single telephone line, with a different ringing pattern.

When you wish to use the additional phone number as a facsimile telephone number, set the ringing pattern detection feature to ON. When the unit detects a call with the distinctive ringing pattern, the unit will automatically activate the fax function to receive documents.

To use this feature properly, set the unit to the TEL/FAX or EXT. TAM mode (if an answering machine is used.)

In the TEL/FAX mode, when a distinctive ringing pattern is detected, the unit will automatically answer the line and activate the fax function to receive documents. If a standard ring pattern is received, the unit will ring until you pick up the phone.

In the EXT. TAM mode, when a distinctive ringing pattern is detected, the unit will automatically answer the line and activate the fax function to receive documents. If a standard ring pattern is received, the unit and the answering machine will activate depending on the call.

Note:

- The unit automatically answers a distinctive ring call after the second ring. To change the number of rings, change the FAX mode ring count (see page 20) after setting the ring detection feature.
- When in the TEL mode, you have to answer all calls manually.
- When in the FAX mode, the unit will automatically answer all calls and activate the fax function.

Setting the ring pattern detection

1 Press **MENU**.

SYSTEM SET UP

2 Press **#**, then **31**.

RING DETECTION

3 Press **START/SET**.

MODE=OFF [▲▼]

4 Press **▲** or **▼** to select "ON".

MODE=ON

•If this feature is not required, select "OFF".

5 Press **START/SET**.

6 Press **MENU**.

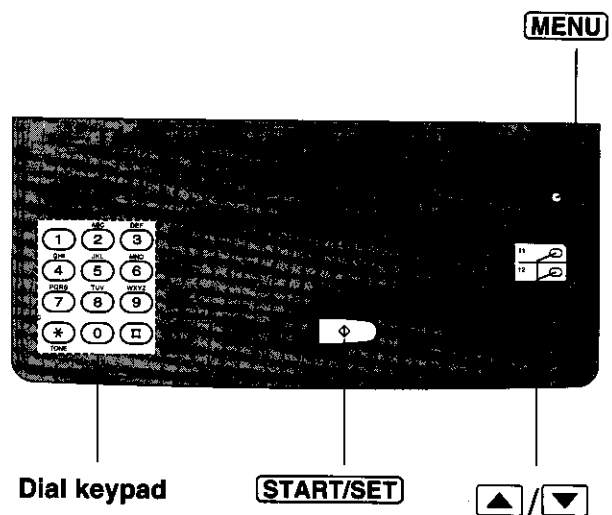

Logo print position

Logo, telephone number, date, time and page number will be printed on the transmitted document from your unit in the following manner.

OUT: Outside of the transmitted document's paper size (pre-selected setting)

IN: Inside of the transmitted document's paper size

OFF: Not printed

To change the setting, proceed as follows.

- 1 Press **MENU**.
SYSTEM SET UP
- 2 Press **#**, then **21**.
LOGO POSITION
- 3 Press **START/SET**.
MODE=OUT [▲▼]
- 4 Press **▲** or **▼** to select the desired setting.
- 5 Press **START/SET**.
- 6 Press **MENU**.

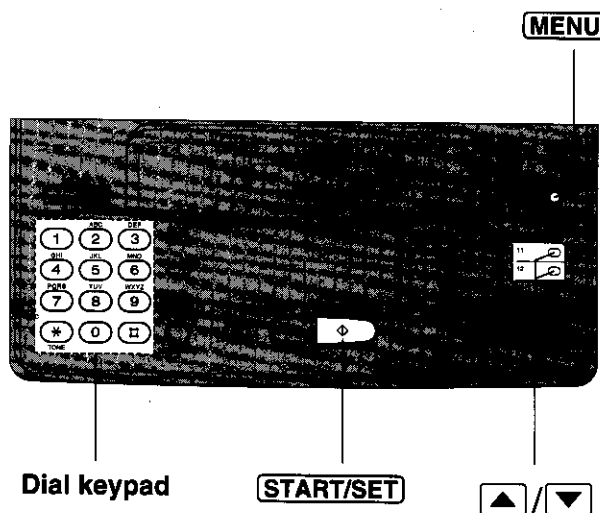

Overseas transmission mode

You may experience difficulty in transmitting documents overseas.

This feature will make sending documents easier as the transmission speed is slowed down.

- 1 Press **MENU**.
SYSTEM SET UP
- 2 Press **#**, then **23**.
OVERSEAS MODE
- 3 Press **START/SET**.
MODE=OFF [▲▼]
- 4 Press **▲** or **▼** to select "ON".
MODE=ON [▲▼]

•If this feature is not required, select "OFF".

- 5 Press **START/SET**.
- 6 Press **MENU**.
•Then start transmission procedure (see pages 15 and 16).

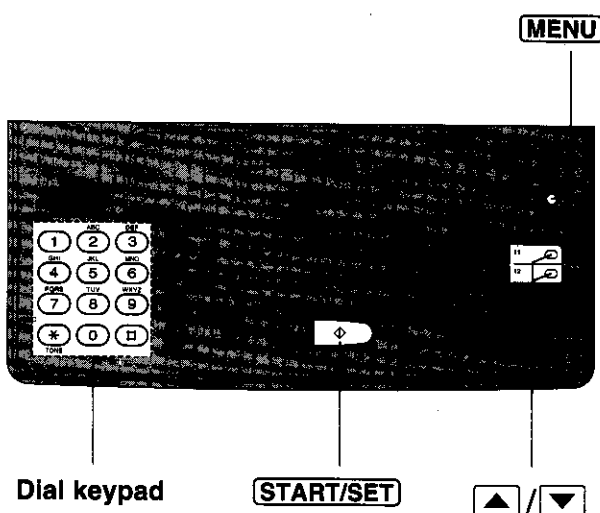

Note:

- After the transmission has completed, this feature will be turned off automatically.
- When using this feature, transmission time will increase.

Copy reduction mode

When you copy documents that are longer than the recording paper, the unit can reduce the original document and print it out on one page by programming a suitable reduction rate below. The reduction rate is determined by a combination of the size of recording paper and original document.

■ Recommended reduction rate:



Mode	Size of recording paper	Size of original document
OFF (pre-selected)	A4	A4, Letter
72%	A4	Legal

A4 =210 × 297mm (8¹/₄" × 11¹¹/₁₆")

Letter=216 × 279 mm (8¹/₂" × 11")

Legal=216 × 356 mm (8¹/₂" × 14")

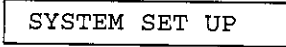
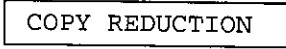
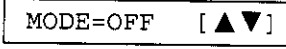
To program a reduction rate, proceed as follows.

- 1 Press **MENU**.

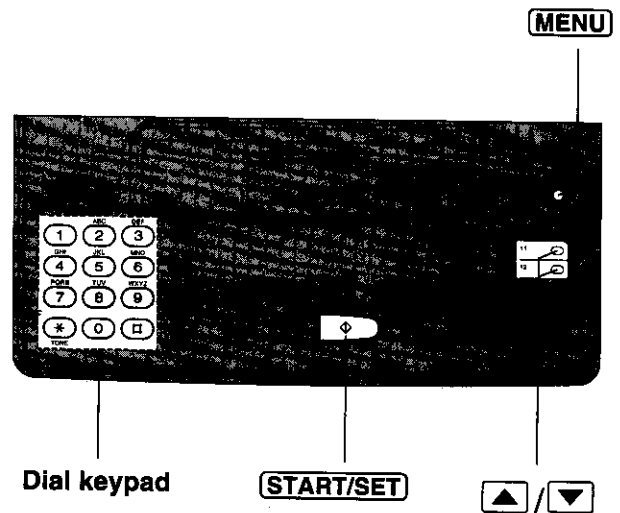
- 2 Press **#**, then **3****5**.

- 3 Press **START/SET**.

- 4 Press  or  to select the desired mode.
- 5 Press **START/SET**.
- 6 Press **MENU**.



Note:

If the appropriate reduction rate is not programmed the document may be divided and the top of the second sheet will be deleted.

Receiving reduction mode

When the size of the documents sent by the other party is as large as, or larger than the recording paper, the unit can reduce each page of the document and print it out on the recording paper at a suitable reduction rate below.

The reduction rate is determined by a combination of the size of the recording paper and received document.

■ Recommended reduction rate:

Mode	Size of recording paper	Size of received document
OFF	A4	Letter
92% (pre-selected)	A4	A4
72%	A4	Legal

A4 =210 × 297mm (8¹/₄" × 11¹¹/₁₆")

Letter=216 × 279 mm (8¹/₂" × 11")

Legal=216 × 356 mm (8¹/₂" × 14")

To program a reduction rate, proceed as follows.

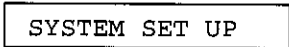
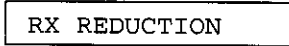
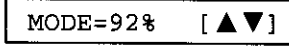
- 1 Press **MENU**.

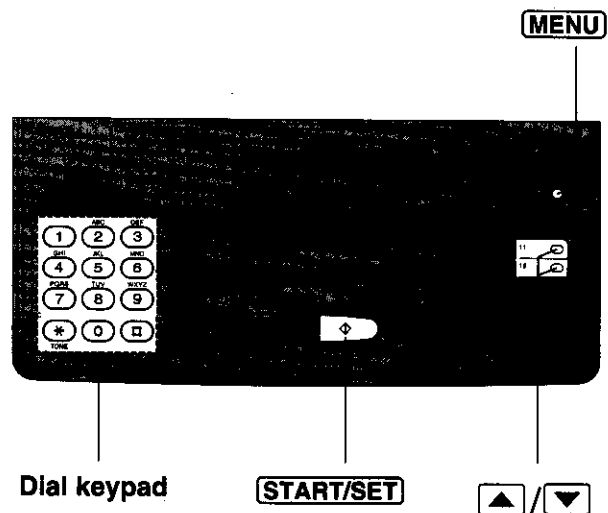
- 2 Press **#**, then **36**.

- 3 Press **START/SET**.

- 4 Press **▲** or **▼** to select the desired mode.
- 5 Press **START/SET**.
- 6 Press **MENU**.



Note:

- This feature is not available when the film/paper save reception feature is set to ON (page 38).
- Documents received by facsimile frequently have a heading on the top of each page which contains the sender's name/phone number. This increases the length of each page. Therefore, it is recommended to use the reduction mode.
- If the appropriate reduction rate is not programmed, the over-sized document will be divided.

Film/Paper save reception

Use this feature if you wish to save film and recording paper when receiving two or more faxed pages. When this feature is set, the unit will reduce documents to half their length and print out two pages of documents on one page. A boundary will be printed out between the documents.

Important:

This feature will not work when the other party sends a document in fine resolution or other nonstandard resolutions.

Sample of paper save print:

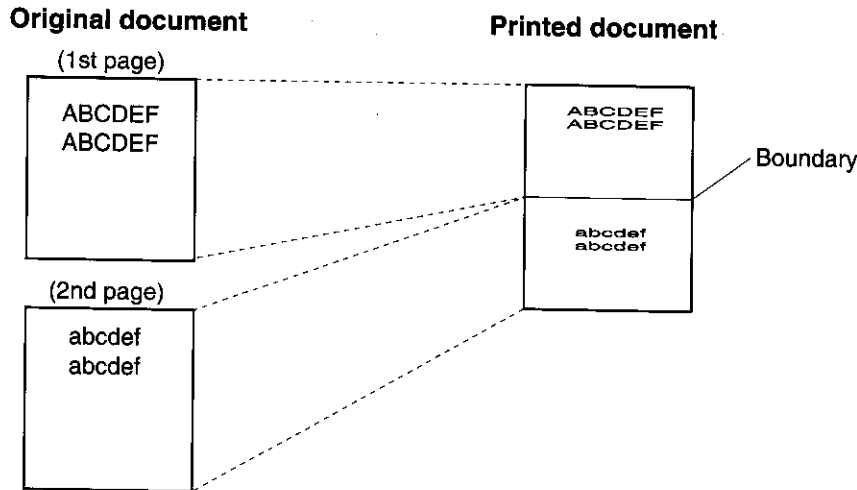

To activate this feature

- 1 Press **FILM/PAPER SAVE**.
 - The following messages will be alternately displayed.

PAPER SAVE=ON?

YES: PRESS SET

- 2 Press **START/SET**.

FILM/PAPER SAVE

- The arrow mark will be displayed.

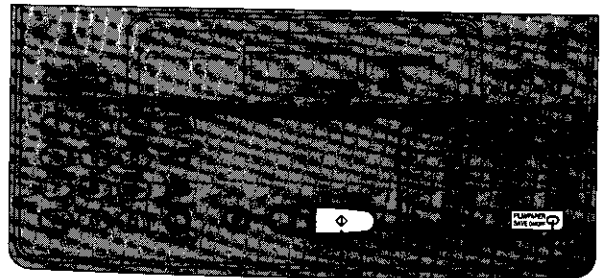

START/SET

FILM/PAPER SAVE

To deactivate this feature

- 1 Press **FILM/PAPER SAVE**.
 - The following messages will be alternately displayed.

PAPER SAVE=OFF?

YES: PRESS SET

- 2 Press **START/SET**.

Note:

- When a reduced document is longer than the recording paper, it will be printed on two pages. The continuation will be printed on next page and there may be wasted space. In this case, paper and film will not be saved for the wasted space.
- When documents are longer than legal size (356mm in length), the unit will not print the next page of the document on the same page.
- Paper and film will not be saved for one page document and the last page of odd numbered documents.

Extension copy

Use this feature to enlarge a document to twice the length of the paper that is correctly being used in the paper cassette. This feature is used to reverse the film/paper save function (see page 38).

Sample of extension copy:

When you wish to enlarge the top half of the document:

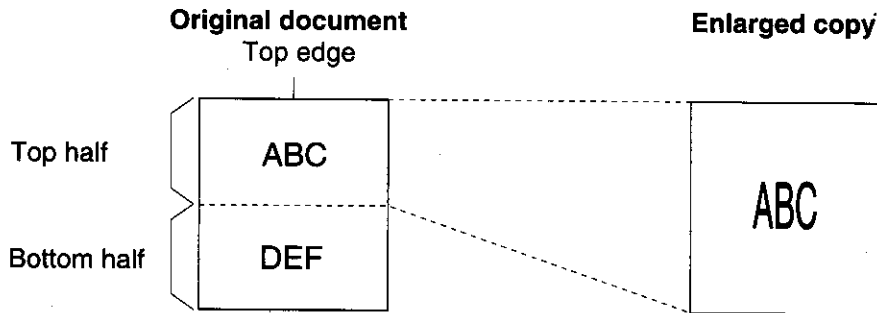

Insert a document into the unit from the top edge side FACE DOWN.

To activate this feature, proceed as follows:

1 Insert the documents FACE DOWN.

2 Press **MENU**.

SYSTEM SET UP

3 Press **#**, then **3****4**.

EXTENSION COPY

4 Press **COPY**.

COPYING

•The unit will start printing.

5 After printing, press **MENU**.

Note:

- You cannot select FINE or HALF TONE resolution for this feature.
- To make an enlarged copy of the whole page whose length is as long as, or shorter than your installed paper:
First insert the top half of the original document into the feeder tray and copy. Then turn the original around and insert the bottom half of the document into the feeder tray and copy.

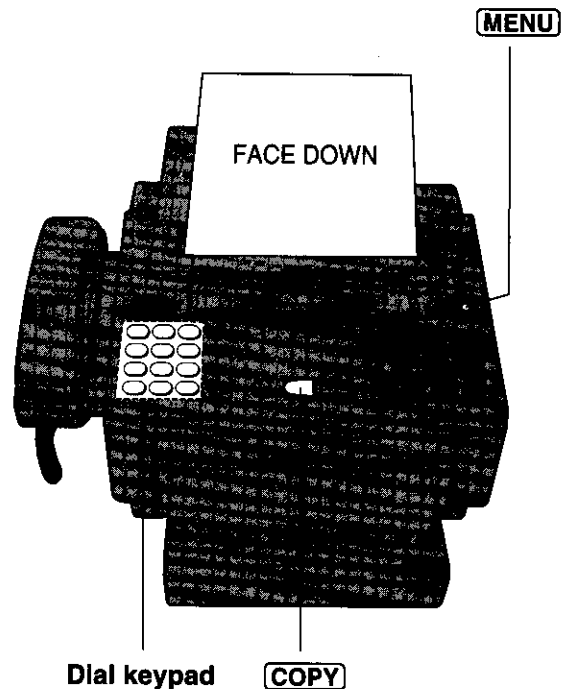

Pager alert for fax reception

This feature allows your unit to call your pager automatically each time your unit receives a fax message. This feature will be only effective for automatic pager.

1 Press **MENU**.
SYSTEM SET UP

2 Press **#**, then **70**.
FAX PAGER

3 Press **START/SET**.
MODE=OFF [▲▼]

4 Press **▲** or **▼** to select "ON".
MODE=ON [▲▼]

•If this feature is not required, select "OFF".

5 Press **START/SET**.
NO. =

6 Enter your pager phone number.
If necessary, press **PAUSE** twice.
Contact your pager company regarding the proper pause time.

7 If your pager has the ability to display phone numbers, enter the number that you wish to appear in the display.
Press **#** if required by your pager company.

8 Press **START/SET**.

9 Press **MENU**.

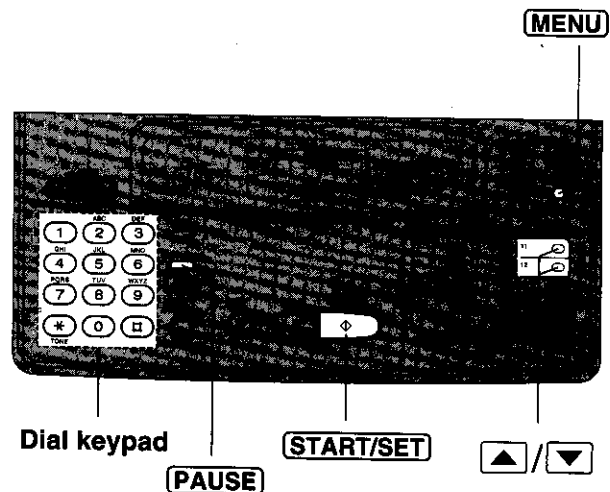

Note:

You may enter a total of 30 digits and/or pauses in steps 6 and 7.

Display contrast

Use this feature to adjust the brightness of the display.
The following choices are available.

NORMAL: (Pre-selected setting)

LIGHT: Used when the display contrast is dark.

DARKER: Used when the display contrast is light.

- 1 Press **MENU**.
SYSTEM SET UP
- 2 Press **#**, then **39**.
LCD CONTRAST
- 3 Press **START/SET**.
MODE=NORMAL [▲▼]
- 4 Press **▲** or **▼** to select the desired mode.
- 5 Press **START/SET**.
- 6 Press **MENU**.

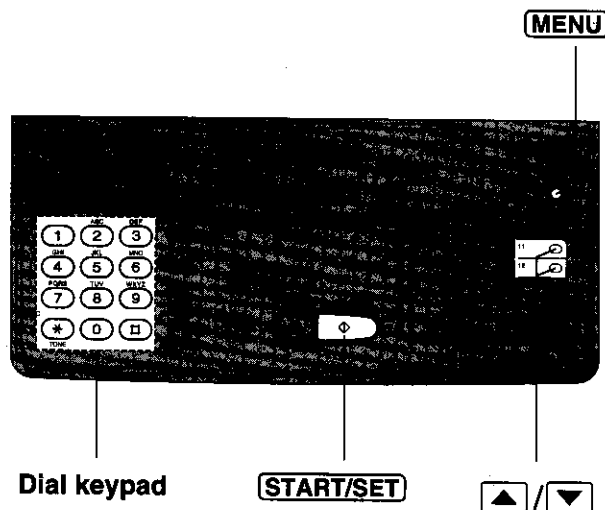

Resetting the advanced features

Use this feature to return the advanced features (see page 46) to their initial settings.

- 1 Press **MENU**.
SYSTEM SET UP
- 2 Press **#**, then **80**.
SET DEFAULT
- 3 Press **START/SET**.
RESET=NO [▲▼]
- 4 Press **▲** or **▼** to select "YES".
RESET=YES [▲▼]
- 5 Press **START/SET**.
RESET OK?
•If this feature is not required, press **STOP**.
- 6 Press **START/SET** again for confirmation.
RESET COMPLETED
- 7 Press **MENU**.

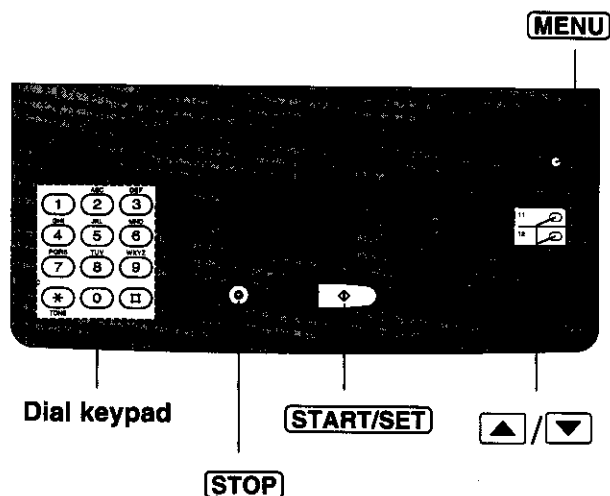

7

TONE, RECALL and PAUSE buttons

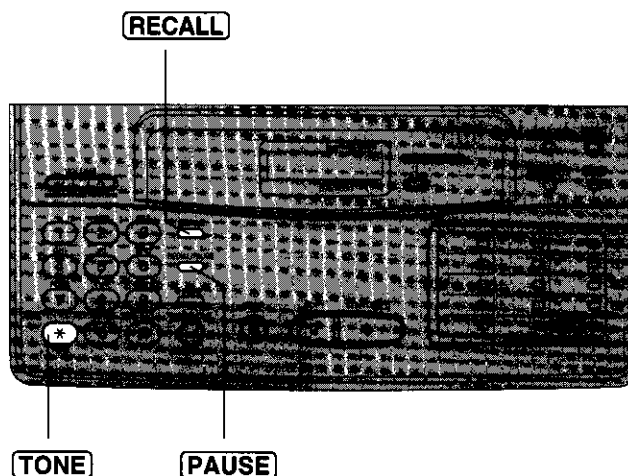

TONE button

The TONE (*) button is used when your line has a rotary pulse dial service. Pressing the button allows you to change temporarily from pulse to tone mode during a dialing operation. When you hang up, the unit will automatically return to pulse mode.

RECALL button

The RECALL button allows you to use special features of the host exchange (if connected) or local telephone company services such as call waiting. For further details, contact the supplier of your local telephone company.

PAUSE button

Pressing the REDIAL/PAUSE button causes a dialing delay in the dialing sequence.

Example-1: When your unit is connected to a host exchange, insert a pause as follows to get an outside line.

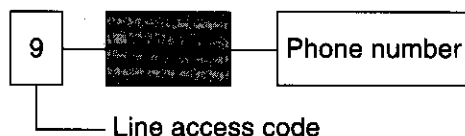

Example-2: If a transmission error occurs frequently when making an overseas transmission, add two pauses at the end of the phone number.

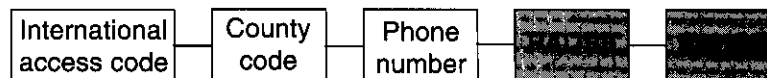

Note:

TONE, RECALL and PAUSE can be stored into a phone number for automatic dialing.

Printing reports and lists

You can print out the following reports/lists from your unit.

Feature List—provides you with the current settings of the basic and advanced programming features (see page 46).

Telephone number list—provides you with phone numbers and their station names which are stored in automatic dialing.

(Code in each phone number)

P: A pause has been entered.

F: A recall has been entered.

[]: A secret phone number has been entered.
(The telephone number is not printed.)

Journal report—is useful for keeping records of fax transmissions and receptions. This report will be printed automatically after every 35 fax communications, but can be printed manually as shown below. You can change the setting of the journal auto print feature (see page 44).

Print Test List—allows you to check the print quality of your unit. If the test print has a dirty pattern, or blurred points or lines, clean the thermal head (see page 53).

Transmission report—provides you a printed record of the fax transmission result. For further details, see page 44.

How to print each report/list

- 1 Press **MENU** until the following is displayed.

PRINT LIST

- 2 For the feature, press **#**, then **1**.

SETUP LIST

For the telephone number list, press **#**, then **3**.

TEL NO. LIST

For the journal report, press **#**, then **4**.

JOURNAL REPORT

For the printer test list, press **#**, then **5**.

PRINTER TEST

- 3 Press **START/SET** to start printing.

PRINTING

•To interrupt printing, press **STOP**.

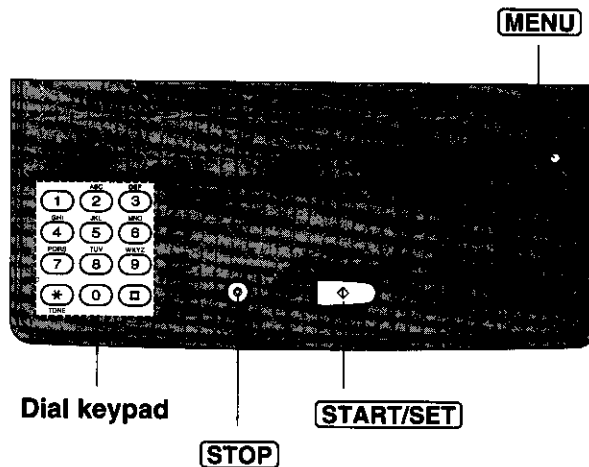

- 4 After printing, press **MENU**.



Setting the transmission report printing

One of the following choices is available.

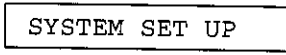
- ERROR:** The transmission report will print out only when the fax transmission fails.
ON: The report will always print out, indicating whether fax transmission is successful or not.
OFF: The report will not print (pre-selected setting).

- 1 Press **MENU**.

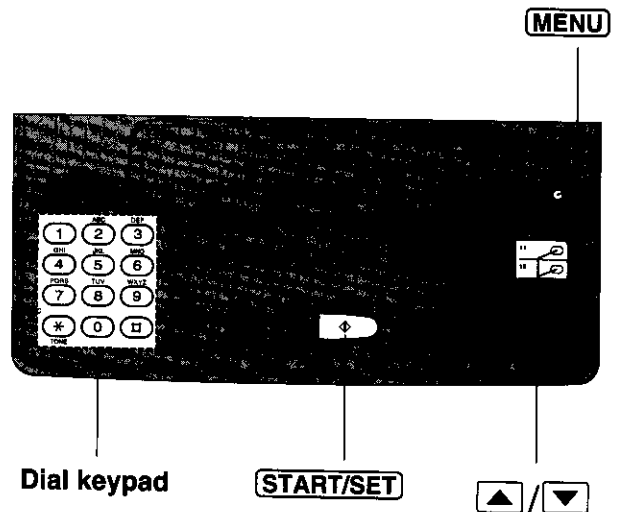
- 2 Press **#**, then **04**.

- 3 Press **START/SET**.

- 4 Press **▲** or **▼** to select the desired mode.
- 5 Press **START/SET**.
- 6 Press **MENU**.

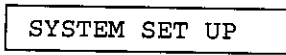
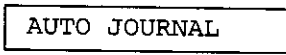
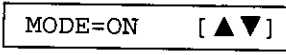

Setting journal auto print

The unit will automatically print a journal report after every 35 fax communications. After printing, the journal memory will be erased and only subsequent activity will be recorded.

When this feature is deactivated, the unit will store the records of the last 35 fax communications, but the unit will not print the journal report automatically.

- 1 Press **MENU**.

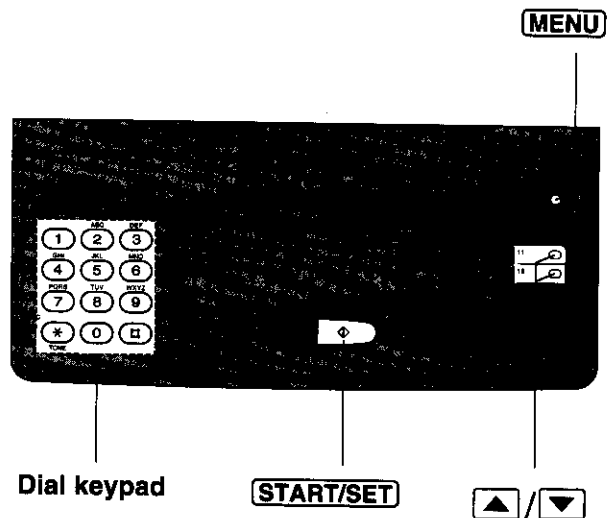
- 2 Press **#**, then **22**.

- 3 Press **START/SET**.

- 4 Press **▲** or **▼** to select the desired mode.
- 5 Press **START/SET**.
- 6 Press **MENU**.



Sample of journal report

							Jan. 25 1996 05:22PM	
NO.	OTHER FACSIMILE	START TIME	USAGE TIME	MODE	PAGES	RESULT	*CODE	
01	1234567	Jan. 21 02:14PM	00'25	TX	01	OK		
02	9998765	Jan. 21 02:17PM	00'38	TX	02	OK		
03	22334455	Jan. 21 02:18PM	00'28	RX	01	OK		
04	555556677	Jan. 22 10:35AM	00'58	TX	03	COMMUNICATION ERROR	(43)	
05	+987 123		01'50	RX	05	OK		
06					01	OK		

Communication result (see below)

Error code (for service personnel use only)

Sample of transmission report

							Jan. 20 1996 01:19PM	
NO.	OTHER FACSIMILE	START TIME	USAGE TIME	MODE	PAGES	RESULT	*CODE	
01	COMPANY ABC	Jan. 20 01:18PM	00'51	TX	00	COMMUNICATION ERROR	(43)	

Communication result on the report

When a problem has occurred, one of the following messages will be printed on the transmission report and the journal report.

COMMUNICATION ERROR	A transmission or reception error occurred. Try again or check the other party.
DOCUMENT JAMMED	A document was jammed. Remove the jammed document (see page 52).
FILM EMPTY	Film is empty. Replace the film or film cartridge with a new one (see page 54).
JUNKMAIL PROH. REJECT	The junk mail prohibitor of your unit rejected fax reception (see page 33).
NO DOCUMENT	The document was not fed into the unit properly. Try again.
NO RESPONSE	The receiving unit was busy or ran out of recording paper. Try again.
PAPER JAMMED	The recording paper was jammed. Clear the jammed paper (see page 50).
PAPER OUT	Your unit ran out of recording paper. Install paper (see page 5).
PRESSED THE STOP KEY	The STOP button was pressed and fax communication was cancelled.
PRINTER OVERHEATED	Printer was overheated. Leave the unit to cool down.
THE COVER WAS OPENED	The top cover was open. Close it and try again.

7

Summary of user programmable features

Basic features

Code	Feature	Selection	Initial setting	Page
#01	SET DATE & TIME	mm/dd/yy hh:mm	(Jan./01/96 12:00 AM)	10
#02	YOUR LOGO		(Panasonic FAX SYSTEM)	10
#03	YOUR TELEPHONE NUMBER			12
#04	PRINT TRANSMISSION REPORT	ERROR/ON/OFF	OFF	44
#06	TEL/FAX RING COUNT	2-9 rings	2 rings	19
#07	FAX RING COUNT	2-9 rings	2 rings	20
#11	REMOTE TAM ACTIVATION	ON/OFF	OFF/ID=11	22

Advanced features

Code	Feature	Selection	Initial setting	Page
#21	LOGO POSITION	OUT/IN/OFF	OUT	35
#22	JOURNAL AUTO PRINT	ON/OFF	ON	44
#23	OVERSEAS MODE	ON/OFF	OFF	35
#24	JUNK MAIL PROHIBITOR	ON/OFF	OFF/ID=22	33
#25	DELAYED TRANSMISSION	ON/OFF	OFF	30
#30	SILENT FAX RECOGNITION RING	3/4/5/6/ rings	3 rings	19
#31	RING DETECTION	ON/OFF	OFF	34
#34	EXTENSION COPY			39
#35	COPY REDUCTION	72%/OFF	OFF	36
#36	RX REDUCTION	92%/72%/OFF	92%	37
#38	SILENT DETECTION	ON/OFF	ON	23
#39	LCD CONTRAST	NORMAL/LIGHT/DARKER	NORMAL	41
#41	REMOTE FAX ACTIVATION CODE		*9	32
#70	FAX PAGER	ON/OFF	OFF	40
#80	SET DEFAULT	YES/NO	NO	41

Error messages on the display

If the unit detects a problem, one of the following messages will appear on the display.

CHECK CASSETTE	<ul style="list-style-type: none"> The recording paper is jammed near the paper cassette. Clear the jammed paper (see page 51).
CHECK COVER	<ul style="list-style-type: none"> The top cover is open. Close it.
CHECK DOCUMENT	<ul style="list-style-type: none"> The document is not fed into the unit properly. Reinsert the document and try again. If misfeeding occurs frequently, clean the feeder rollers (see page 53). If the problem remains, adjust the feeder pressure (see page 52).
CHECK FILM	<ul style="list-style-type: none"> The film is not inserted in the cartridge correctly. Reinsert it correctly by referring to step 8 on page 55.
CHECK MEMORY	<ul style="list-style-type: none"> Memory (phone numbers, parameters, etc.) has been erased. Re-program.
FILM EMPTY	<ul style="list-style-type: none"> Film is empty. Replace the film or film cartridge with a new one (see page 54).
LOADING FILM	<ul style="list-style-type: none"> The blue leader of the film was not wound completely or the unit was out of film. Wait for a while.
NO RESPONSE	<ul style="list-style-type: none"> The receiving unit was busy or ran out of recording paper. Try again.
OUT OF PAPER	<ul style="list-style-type: none"> The unit is out of recording paper. Install paper (see page 5).
PAPER JAMMED	<ul style="list-style-type: none"> The recording paper is jammed near the head unit. Clear the jammed paper (see page 50).
POLLING ERROR	<ul style="list-style-type: none"> The other fax machine does not provide the polling function. Check the other party.
REMOVE DOCUMENT	<ul style="list-style-type: none"> The document is jammed. Remove the jammed document (see page 52). Attempted to transmit a document longer than 600 mm (23⁵/₈"). Press the STOP button and remove the document (see page 52). Divide it into two or more sheets and try again.
TRANSMIT ERROR	<ul style="list-style-type: none"> Transmission error occurred. Try again.
UNIT OVERHEATED	<ul style="list-style-type: none"> The unit is overheated. Leave it to cool down.

Before requesting help

General

I cannot make and receive calls.	<ul style="list-style-type: none">•The power cord or telephone line cord is not connected. Confirm the connection (see page 7).
I cannot make calls.	<ul style="list-style-type: none">•The setting of the dialing mode is wrong. Check the selector (see page 7).
The unit does not work.	<ul style="list-style-type: none">•Disconnect the unit from the telephone line and connect to a known working phone. If the known working phone operates properly, call your service personnel to have the unit repaired. If the known working phone does not operate properly, consult your telephone company.
The unit does not ring.	<ul style="list-style-type: none">•The ringer volume is set to OFF. Raise it to a suitable level (see page 12).
The REDIAL/PAUSE button does not function properly.	<ul style="list-style-type: none">•If this button is pressed during dialing, a pause will be inserted. If this button is pressed immediately after the dial tone is obtained, the last number dialed will be redialed.
While programming, I cannot enter the activation code or the prohibitor ID.	<ul style="list-style-type: none">•The whole or part of the number is same as the other code or ID. Change the number (see pages 22, 32 and 33).

Fax Transmission & Reception

The other party complains that letters on their received document are distorted.	<ul style="list-style-type: none">•If your line has special telephone services such as call waiting, the service may have been activated during the fax transmission. Connect the unit to a line that does not have such services.•Another telephone connected to the same line is off the hook. Hang up and try again.
The other party complains that a dirty pattern or a black line appears on their received documents.	<ul style="list-style-type: none">•The glass or rollers are dirty. Clean them (see page 53).
I cannot make an international fax call.	<ul style="list-style-type: none">•Use the overseas transmission mode (see page 35).•Add two pauses at the end of the phone number (see page 42).
I cannot receive documents automatically.	<ul style="list-style-type: none">•The receive mode is set to TEL. Set the receive mode to TEL/FAX or FAX (or EXT. TAM).•The time to answer the call may be too long. Decrease the number of rings (see pages 19 and 20).•The junk mail prohibitor is set to ON (see page 33).

Recording image is faint.	<ul style="list-style-type: none"> •The sender transmitted a faint document. Request them to transmit a clearer copy of the document. •The thermal head is dirty. Clean it (see page 53).
A blank sheet is ejected after the received documents are printed out.	<ul style="list-style-type: none"> •The receiving reduction rate is not programmed correctly. Program the proper reduction rate (see page 37).

Operation in EXT. TAM mode

PROBLEM	CAUSE & REMEDY
I cannot receive documents automatically.	<ul style="list-style-type: none"> •Your greeting message on the answering machine is too long. Shorten the message (up to 10 seconds). •There are too many rings on the answering machine. Set to 1 or 2 rings. •The silent detection feature is deactivated. Activate this feature (see page 23).
I cannot receive voice messages.	<ul style="list-style-type: none"> •Check that the answering machine is turned on and connected to the facsimile unit properly (see page 21). •Set the number of rings on the answering machine to 1 or 2.
I cannot retrieve voice messages recorded on the answering machine from a remote location.	<ul style="list-style-type: none"> •The remote access code on your answering machine is the same as your remote fax activation code or junk mail prohibitor ID. Set a different number for each code/ID. •You did not program your remote TAM activation code in your facsimile unit correctly. Program the same code that is programmed on the answering machine (see page 22).
The greeting message on your answering machine is interrupted halfway and the caller cannot leave a voice message.	<ul style="list-style-type: none"> •The greeting message has a silent pause longer than 4 seconds. Shorten the silent pause in the greeting message.
I pressed the remote access code to access the answering machine remotely, but the line was disconnected.	<ul style="list-style-type: none"> •The code may include “#” which is used for certain features provided by the telephone company. Change the code on the answering machine to another number which does not include “#”, then program the same code into the facsimile unit (see page 22).

Copying

PROBLEM	CAUSE & REMEDY
A dirty pattern or black line appears on the copied documents.	<ul style="list-style-type: none"> •The glass or rollers are dirty. Clean them (see page 53).
Copied image is distorted.	<ul style="list-style-type: none"> •The thermal head is dirty. Clean it (see page 53).
The document is not copied properly.	<ul style="list-style-type: none"> •The film is not inserted correctly. Insert it correctly (see page 54).
A paper jam occurs during copying.	<ul style="list-style-type: none"> •The film is not inserted correctly. Insert it correctly (see page 54).

Clearing a recording paper jam

If a recording paper jams, the display will show one of two messages below. Remove the jammed recording paper following either message.

PAPER JAMMED

A recording paper jammed near the head unit.

CHECK CASSETTE

A recording paper jammed near the paper cassette.

Removing a jammed recording paper near the head unit

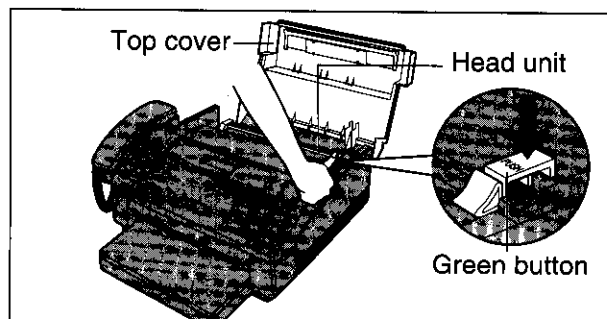

- 1 Open the top cover.
- 2 Press the green button on the right marked "PUSH" and lift up the head unit.

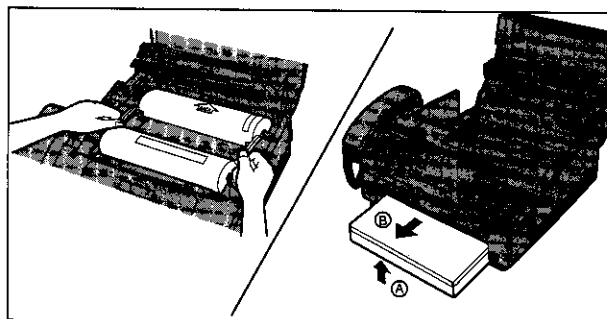

- 3 Remove the film cartridge.
- 4 Lift up the paper cassette slightly (A) and pull it towards you to remove it (B).

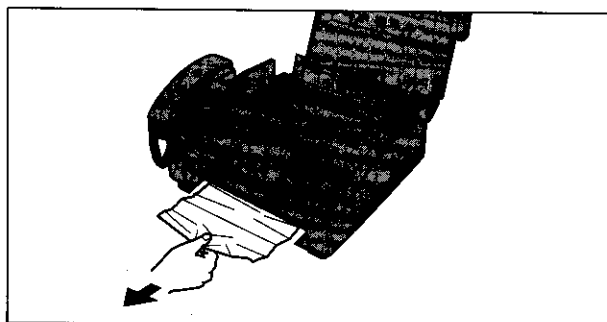

- 5 Remove the jammed recording paper.
 - If the jammed paper cannot be removed by the way of the illustration to the left, then remove it as below:

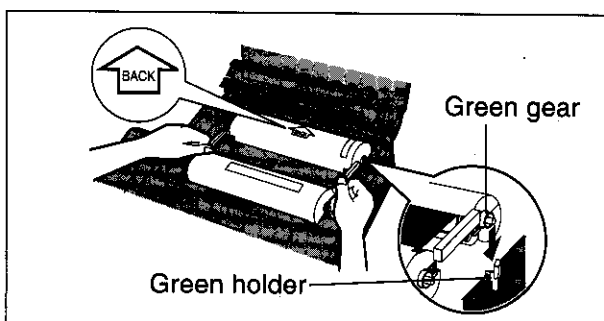
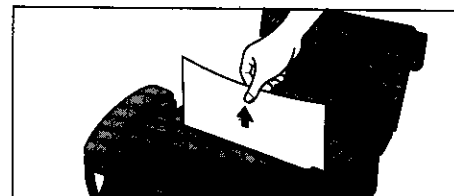

- 6 Place the "BACK" side of the cartridge into the unit, by inserting the pins on the sides of the green gears into the green holders. Then lower the front of the cartridge into place.
 - If the film is slack, tighten it by winding the gears.

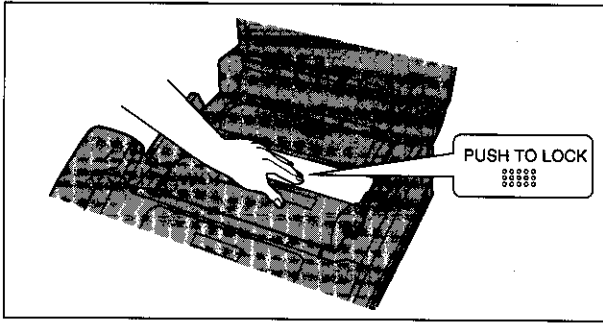

7 Press the head unit down firmly until it clicks into place.

8 Close the top cover securely by pushing down on both sides.

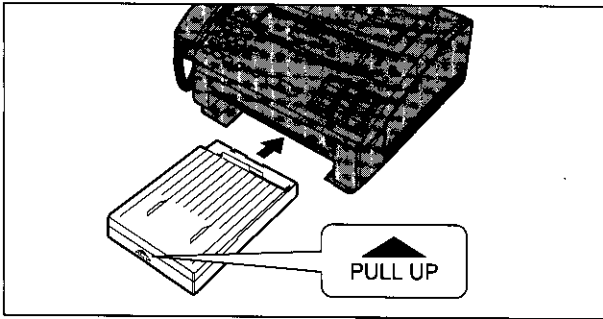

9 Insert the paper cassette into the unit until it clicks into place.

Removing a jammed recording paper near the paper cassette _____

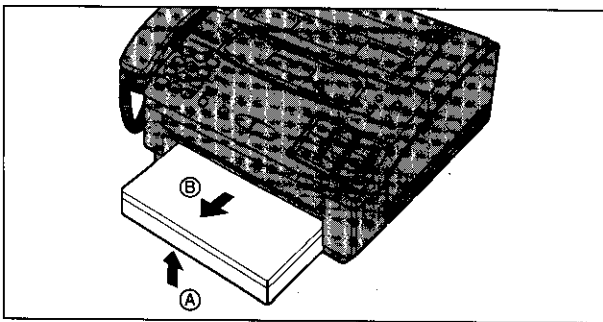

1 Lift up the paper cassette slightly (A) and pull it towards you to remove it (B).

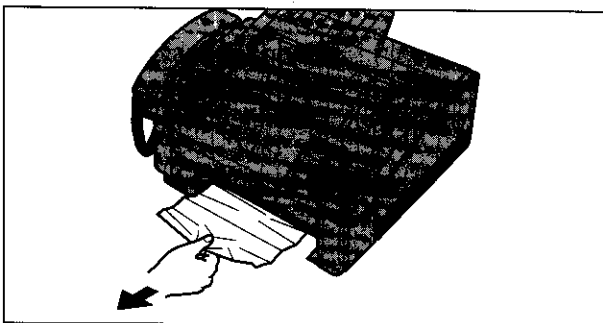

2 Reach into the paper cassette opening and remove the jammed recording paper.

•When the jammed paper cannot be removed easily, open the top cover and head unit, and remove the jammed paper. Do not pull the jammed paper forcibly, or torn pieces of paper may remain in the unit.

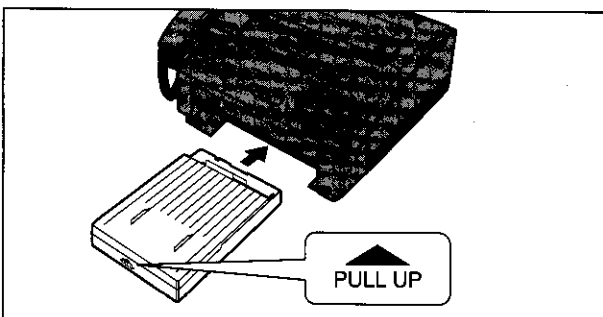

3 Insert the paper cassette into the unit until it clicks into place.

Clearing a document jam

If the unit does not release an original document during feeding, remove it as shown below.

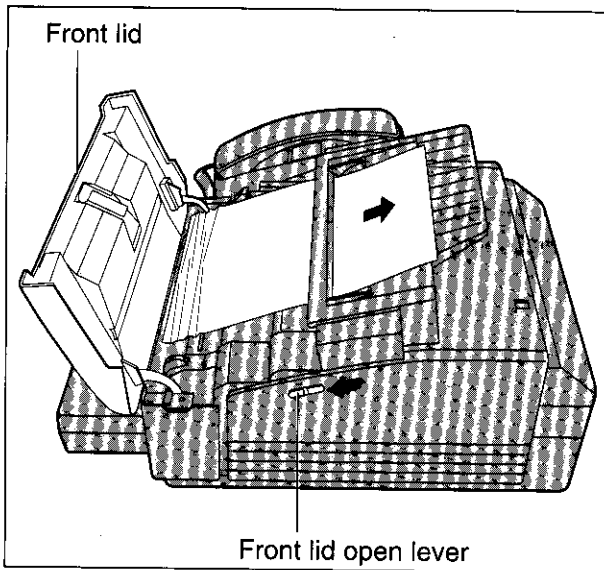

- 1 Slide the front lid open lever towards you to open the front lid.
- 2 Remove the jammed document carefully.
- 3 Close the lid securely by pushing down on both sides.

Adjusting the feeder pressure

If misfeeding of documents occurs frequently, adjust the feeder pressure.

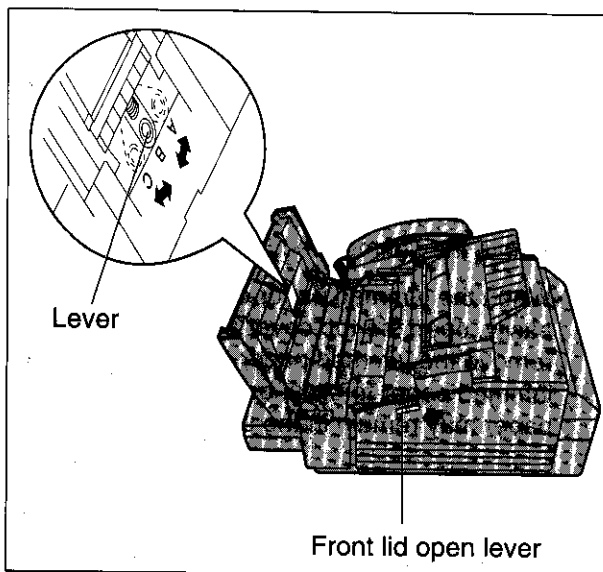

- 1 Slide the front lid open lever towards you to open the front lid.
- 2 Shift the position of the lever to a desired position by using an instrument with a pointed end, like a clip or ball-point pen.

Position B: Standard position
Set to Position A: If no feeding occurs.
Set to Position C: If multifeeding occurs.
- 3 Close the lid securely by pushing down on both sides.

Cleaning the unit

Cleaning the document feeder unit

If misfeeding occurs frequently or dirty patterns or black bands appear on a copied or transmitted document, clean the feeder rollers, sub roller, rubber flap, white plate and glass.

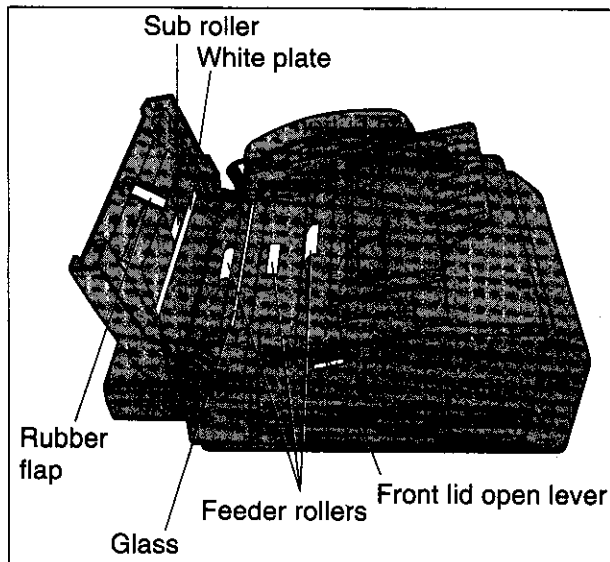

- 1 Disconnect the power cord and the telephone line cord.
- 2 Slide the front lid open lever towards you to open the front lid.
- 3 Clean the feeder rollers, sub roller and rubber flap with a cloth moistened with isopropyl rubbing alcohol, and let dry thoroughly.
- 4 Clean the white plate and the glass with a dry soft cloth.
- 5 Close the lid securely by pushing down on both sides.
- 6 Connect the power cord and telephone line cord.

Cleaning the thermal head

If dirty patterns or black bands appear on a copied or received document, clean the thermal head.

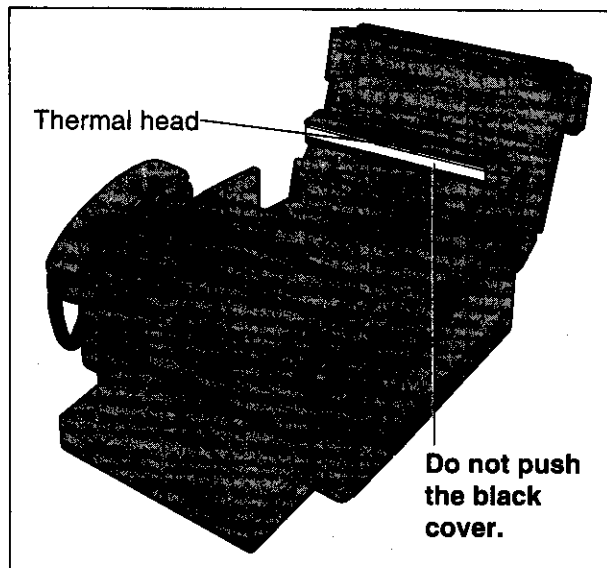

Caution:

To prevent a malfunction due to static electricity, do not use a dry cloth and do not touch the thermal head directly with your finger.

- 1 Disconnect the power cord and the telephone line cord.
- 2 Open the top cover.
- 3 Press the green button on the right marked "PUSH" and lift up the head unit.
- 4 Clean the thermal head with a cloth moistened with isopropyl rubbing alcohol, and let dry thoroughly.
- 5 Press the head unit down firmly until it clicks into place.
- 6 Close the top cover securely by pushing down on both sides.
- 7 Connect the power cord and telephone line cord.

Replacing the film or film cartridge

When the unit detects the end of the film, the following message will be displayed.

FILM EMPTY

Replace the film or filmcartridge with a new one. To order a replacement part, see page 57.

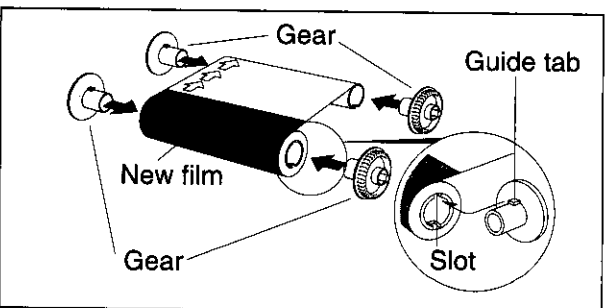
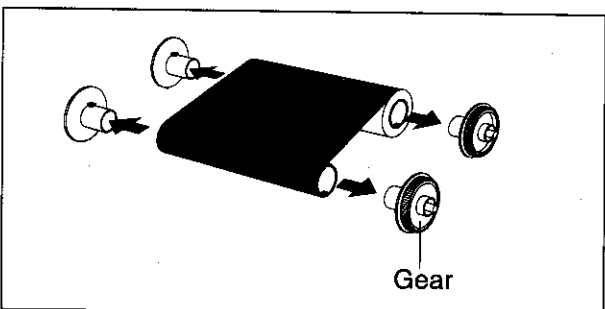
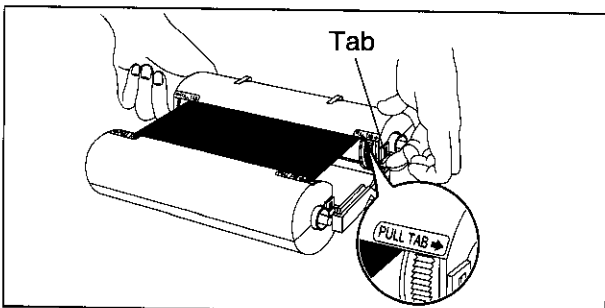
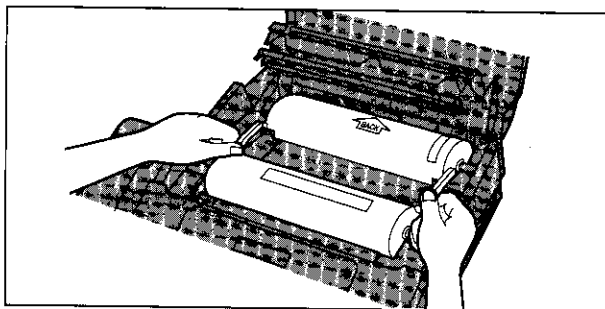
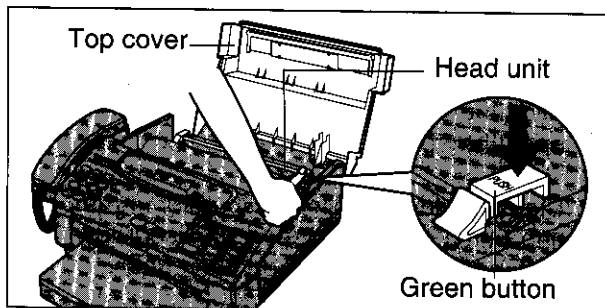

- 1 Open the top cover.
- 2 Press the green button on the right marked "PUSH" and lift up the head unit.
- 3 Take out the film cartridge.
 - If you purchased a film cartridge (Model no. KX-FA132) for replacement, skip to step 11.
 - To replace only the film, go to step 4.
- 4 Turn over the cartridge so that the "PULL TAB" mark is facing up.
- 5 Unlock the four tabs of the cartridge, open the cover of the cartridge and take out the used film.
- 6 Pull out the four gears from the used film cores.
- 7 Insert the four gears into the new film cores so that the guide tabs of each gear fits into the slots of the film core.

Caution:

The film is not reusable. You can order a new film for replacement through the nearest Panasonic dealer.

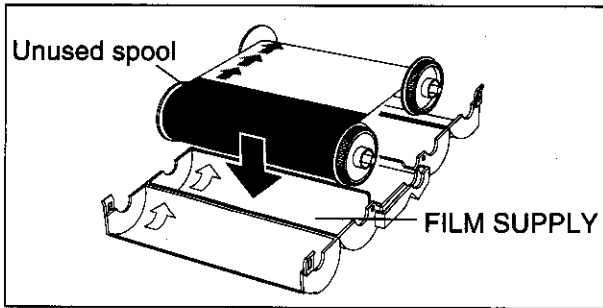

8 Insert the film into the cartridge so that the arrow on the open cartridge points in the same direction as the arrows on the film.

- If you insert a film which was used halfway, insert the unused spool of the film on the "FILM SUPPLY" mark of the cartridge.

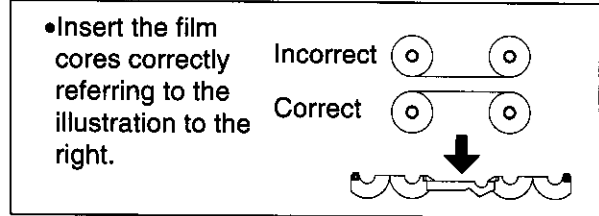

9 Roll the blue leader of the film by winding the gears of the core until the leader is no longer visible.

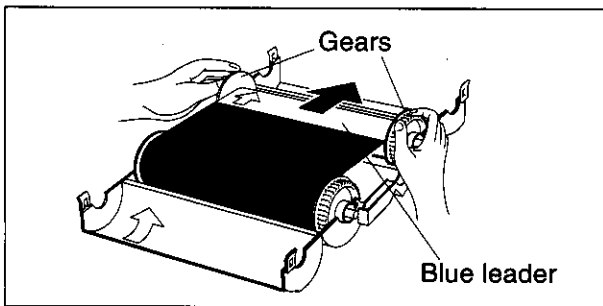

10 Close the covers of the cartridge by locking the four tabs.

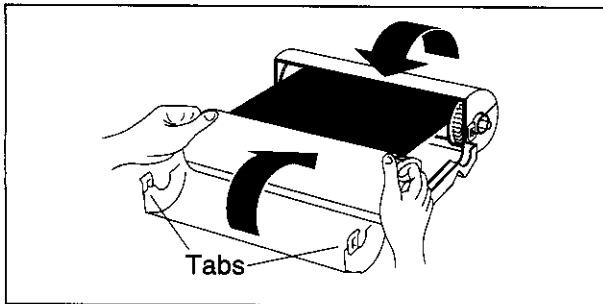

11 Turn over the cartridge and referring to the illustration on the left, place the "BACK" side of the cartridge into the unit, by inserting the pins on the sides of the green gears into the green holders. Then lower the front of the cartridge into place.

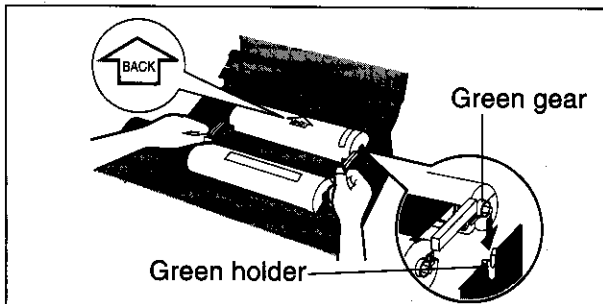

12 Press the head unit down firmly until it clicks into place.

13 Close the top cover securely by pushing down on both sides.

- If the blue leader of the film is not wound completely, the unit will automatically advance it and the following message will be displayed.

LOADING FILM

- If the following message is displayed, the film is not inserted in the cartridge correctly.

CHECK FILM

Reinsert it correctly by referring to step 8 on this page.

Important safety instructions

When using this product, basic safety precautions should always be followed to reduce the risk of fire, electric shock, and injury to persons, including the following:

1. Read and understand all instructions.
2. Follow all warnings and instructions marked on this product.
3. Unplug this product from wall outlets before cleaning. Do not use liquid or aerosol cleaners. Use a damp cloth for cleaning.
4. Do not use this product near water, for example, near a bath tub, wash bowl, kitchen sink, or laundry tub, in a wet basement, or near a swimming pool.
5. Do not place this product on an unstable cart, stand or table. The product may fall, causing serious damage to the product.
6. Slots and openings in the cabinet and the back or bottom are provided for ventilation, to protect it from overheating, these openings must not be blocked or covered. The openings should never be blocked by placing the product on the bed, sofa rug, or other similar surface. This product should never be placed near or over a radiator or heat register. This product should not be placed in a built-in installation unless proper ventilation is provided.
7. This product should be operated only from the type of power source indicated on the marking label. If you are not sure of the type of power supply to your home, consult your dealer or local power company.
8. This product is equipped with a three wire grounding type plug, a plug having a third (grounding) pin. This plug will only fit into a grounding type power outlet. This is a safety feature. If you are unable to insert the plug into the outlet, contact your electrician to replace your obsolete outlet. Do not defeat the safety purpose of the grounding type plug.
9. Do not allow anything to rest on the power cord. Do not locate this product where the cord will be abused by people walking on it.
10. Do not overload wall outlets and extension cords as this can result in the risk of fire or electric shock.
11. Never push objects of any kind into this product through cabinet slots as they may touch dangerous voltage points or short out parts that could result in a risk of fire or electric shock. Never spill liquid of any kind on the product.
12. To reduce the risk of electric shock, do not disassemble this product, but take it to a qualified serviceman when some service or repair work is required. Opening or removing covers may expose you to dangerous voltage or other risks.

Incorrect reassembly can cause electric shock when the appliance is subsequently used.

13. Unplug this product from the wall outlet and refer servicing to qualified service personnel under the following conditions:
 - A. When the power supply cord or plug is damaged or frayed.
 - B. If liquid has been spilled into the product.
 - C. If the product has been exposed to rain or water.
 - D. If the product does not work normally by following the operating instructions. Adjust only those controls, that are covered by the operating instructions because improper adjustment of other controls may result in damage and will often require extensive work by a qualified technician to restore the product to normal operation.
 - E. If the product has been dropped or the cabinet has been damaged.
 - F. If the product exhibits a distinct change in performance.
14. Avoid using a telephone (other than a cordless type) during an electrical storm. There may be a remote risk of electric shock from lightning.
15. Do not use the telephone to report a gas leak in the vicinity of the leak.

SAVE THESE INSTRUCTIONS

INSTALLATION:

1. Never install telephone wiring during a lightning storm.
2. Never install telephone jacks in wet locations unless the jack is specifically designed for wet locations.
3. Never touch uninsulated telephone wires or terminals unless the telephone line has been disconnected at the network interface.
4. Use caution when installing or modifying telephone lines.

WARNING:

To prevent the risk of fire or electrical shock, do not expose this product to rain or any type of moisture.

OTHER INFORMATION

- Keep the unit away from electrical noise-generating devices, such as fluorescent lamps and motors.
- The unit should be kept free from dust, moisture, high temperature, and vibration.
- The unit should not be exposed to direct sunlight.
- Do not place heavy objects on top of this unit.
- Do not damage the power cord.
- Do not touch the plug with wet hands.
- Do not use benzine, thinner, or any abrasive powder, to clean the cabinet. Wipe it with a soft cloth.

Accessory order information

Use the following for replacement. Problems will occur if other brands of films are used.

Model No.	Description	Comment
KX-FA132	Film cartridge	1 cartridge & 1 film: 216 mm × 200 m (8½" × 656') roll
KX-FA133	Replacement film (1 set)	216 mm × 200 m (8½" × 656') roll
KX-FA134	Replacement film (2 sets)	216 mm × 200 m (8½" × 656') roll

Specifications

1. **Applicable Lines:** Public Switched Telephone Network
2. **Document Size:** Max. 216 mm (8½") in width
Max. 600 mm (23⁵/₈") in length
3. **Effective Scanning Width:** 208 mm (8³/₁₆")
4. **Recording Paper Size:** A4: 210 × 297 mm (8¼" × 11¹¹/₁₆")
5. **Effective Printing Width:** 202 mm (7¹⁵/₁₆")
6. **Transmission Time*:** Approx. 15 sec./page (Original mode)
Approx. 30 sec./page (G3 Normal mode)
7. **Fax Auto Redial:** Up to 2 times
8. **Telephone Auto Redial:** Up to 2 times
9. **Scanning Density:** Horizontal: 8 pels/mm (203 pels/inch)
Vertical: 3.85 lines/mm (98 lines/inch) — Standard
7.7 lines/mm (196 lines/inch) — Fine/Halftone
10. **Halftone Level:** 64-level
11. **Scanner Type:** CCD Image Sensor
12. **Printer Type:** Thermal Transfer
13. **Data Compression System:** Modified Huffman (MH), Modified READ (MR)
14. **Modem Speed:** 9600/7200/4800/2400 bps; Automatic Fallback
15. **Operating Environment:** 5 – 35 °C (41 – 95 °F), 20 – 80 % RH
16. **Dimensions (H×W×D):** 237 × 420 × 389 mm (9⁵/₁₆" × 16⁹/₁₆" × 15⁵/₁₆")
17. **Mass (Weight):** Approx. 9.0 kg (19.8 lb.)
18. **Power Consumption:** Transmission: Approx. 17 W / Reception: Approx. 40 W
Copy: Approx. 50 W / Standby: Approx. 5 W
Maximum: Approx. 150 W
19. **Power Supply:** 220-240 V AC, 50/60 Hz

*Transmission Time: Transmission times apply to text data using the ITU-T (CCITT) test chart, between the same machine models at maximum modem speed. The transmission time does not include call setup, ringing, handshaking and sign off. Transmission times may vary.

Note:

- Any details given in these instructions are subject to change without notice.
- The picture and illustrations in these instructions may vary slightly from the actual product.



Fax Correspondence

To: _____ Date: _____

From: _____ Our fax/phone no. : _____

We have a Panasonic plain paper facsimile with a telephone answering machine connected. You can leave a voice message and transmit a fax document during the same call.

Leaving a voice message and transmitting a document

1. Dial our phone number.
 - Our telephone answering machine will play the greeting message.
2. Leave your message after the long beep.
3. Press your “*9” to activate the fax.
 - A fax tone will sound.
4. Start transmission to send a fax.

Transmitting a document only

1. Dial our phone number.
 - Our telephone answering machine will play the greeting message.
2. Press your “*9” while the greeting message is being played.
 - A fax tone will sound.
3. Start transmission to send a fax.

Transmitting a document from a rotary (pulse) phone

1. Dial our phone number.
 - Our telephone answering machine will play the greeting message.
2. Start transmission to send a fax.

..... Detach here and transmit this sheet FACE DOWN.

Note for the customer of this unit:

- Connect a telephone answering machine to your facsimile unit and activate the answering function.
- Set your unit to the EXT. TAM mode.
- “Pressing *9” is the remote fax activation code, and it can be changed (see page 32). If you change it, inform the new code to callers.



Speed dialer list

Station No.	Name/Phone No.	Station No.	Name/Phone No.
00		30	
01		31	
02		32	
03		33	
04		34	
05		35	
06		36	
07		37	
08		38	
09		39	
10		40	
11		41	
12		42	
13		43	
14		44	
15		45	
16		46	
17		47	
18		48	
19		49	
20		50	
21		51	
22		52	
23		53	
24		54	
25		55	
26		56	
27		57	
28		58	
29		59	

Speed dialer list

Station No.	Name/Phone No.	Station No.	Name/Phone No.
00		30	
01		31	
02		32	
03		33	
04		34	
05		35	
06		36	
07		37	
08		38	
09		39	
10		40	
11		41	
12		42	
13		43	
14		44	
15		45	
16		46	
17		47	
18		48	
19		49	
20		50	
21		51	
22		52	
23		53	
24		54	
25		55	
26		56	
27		57	
28		58	
29		59	

Index

- A** Automatic dialing 25, 26
- C** Cleaning 53
COPY button 24
Copy reduction mode 36
- D** Date and time 10
Delayed transmission 30
DELETE key 11
Dialing mode 7
Direct call station keys 11, 25, 26
DIRECTORY button 26, 27
Display contrast 41
- E** Electronic telephone directory 27
Error messages 47
Extension copy 39
EXT. TAM mode 13, 21
- F** FAX mode 13, 20
FAX ring count 20
Feeder pressure 52
FILM/PAPER SAVE key 38
- H** Handset volume 12
HELP button 7
- I** INSERT key 11
- J** Journal auto print 44
Journal report 44, 45
Junk mail prohibitor 33
- L** Logo position 35
- M** MENU button 10, 25, 29, 43
MUTE button 14
- O** One-touch dialing 25, 26
Overseas transmission mode 35
- P** Pager alert 40
PAUSE button 42
Polling 29
- R** RECALL button 42
RECEIVE MODE button 13
Receiving reduction mode 37
REDIAL/PAUSE button 14
Remote fax activation code 32
Remote TAM activation ID 22
RESOLUTION button 15
Ring pattern detection 34
Ringer volume 12
- S** SECRET key 25
Set default 41
Silent detection 23
Silent fax recognition ring 19
SPACE key 11
Speaker volume 12
Speed dialing 25, 26
SP-PHONE button 14, 15
START/SET button 10, 15
STOP button 15
- T** TEL mode 13
Telephone number list 43
TEL/FAX mode 13, 18
TEL/FAX ring 19
TONE button 42
Transmission report 43, 45
- V** Visual film indicator 8
Voice contact 28
VOICE STDBY button 28
VOLUME button 12
- Y** Your facsimile telephone number 12
Your logo 10

Matsushita Electric Industrial Co., Ltd.
Central P.O. Box 288, Osaka 530-91, Japan

Printed in Hong Kong

PFQX1025ZA-CA S0796M0

Free Manuals Download Website

<http://myh66.com>

<http://usermanuals.us>

<http://www.somanuals.com>

<http://www.4manuals.cc>

<http://www.manual-lib.com>

<http://www.404manual.com>

<http://www.luxmanual.com>

<http://aubethermostatmanual.com>

Golf course search by state

<http://golfingnear.com>

Email search by domain

<http://emailbydomain.com>

Auto manuals search

<http://auto.somanuals.com>

TV manuals search

<http://tv.somanuals.com>