

Panasonic

900MHz Cordless FAX

Model No. **KX-F900**

OPERATING INSTRUCTIONS

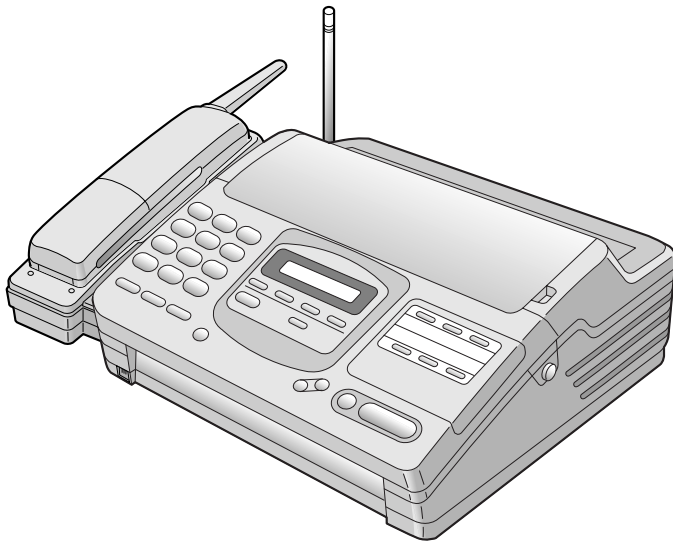

Please read these Operating Instructions before using the unit and save for future reference.

**FOR OPERATION ASSISTANCE,
CALL 1-800-HELP-FAX (1-800-435-7329)**

- This product is designed for use in the United States of America, and may not operate in other countries. (See page 68 for more details.)
- Este producto ha sido diseñado para su uso en los Estados Unidos de América, y puede no funcionar correctamente en otros países. (Consulte la página 68 para tener más detalles.)

Contents

Installation and Connection	p. 8
Initial Preparation	p. 14
Basic Operations	p. 20
Advanced Operations	p. 29
Troubleshooting and Routine Care	p. 55
General Information	p. 64

Thank you for purchasing the Panasonic 900MHz Cordless FAX.

Things you should keep records of

Attach your sales receipt here

For your future reference

Date of purchase _____ Serial No. _____
(found on the bottom of the unit)

Dealer's name and address _____

Dealer's telephone number _____

Caution:

The Telephone Protection Act of 1991 requires the following information to be clearly stated either at the top or bottom margin of the first message page when transmitting messages via telephone facsimile;

- Date and time of transmission,
- Identification of the business, entity or person(s) sending the facsimile, and
- Telephone number of the business, entity or person(s).



To program this information into your facsimile machine, complete all the instructions on pages 14 through 16.

Copyright:

This manual is copyrighted by Kyushu Matsushita Electric Co., Ltd. (KME) and its licensee. Under the copyright laws, this manual may not be reproduced in any form, in whole or part, without the prior written consent of KME and its licensee.

© Kyushu Matsushita Electric Co., Ltd. 1996

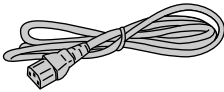
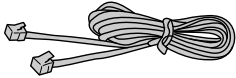
Included accessories (To order, call toll free 1-800-332-5368.)

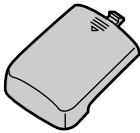
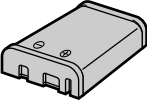
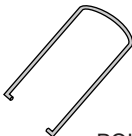
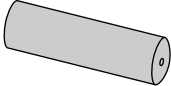
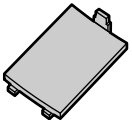
Power cord 1 pc. (p. 12)  PQJA200Z	Telephone line cord 1 pc. (p. 12)  PQJA59V	Cordless handset 1 pc. (p. 11)  	Battery cover 1 pc. (p. 11)  PQKK10066Z1
Battery 1 pc. (p. 11, 61)  KX-A92	Paper stacker 1 pc. (p. 11)  PQUS10136Z	Recording paper . . 1 pc. (p. 10)  • See page 67 for replacement of the recording paper.	Spare battery cover 1 pc. (p. 11)  PQKK10065Z1

- If any items are missing, check with place of purchase.
- The part numbers listed above are subject to change without notice.
- Save the original carton and packaging.

For best performance

Battery charge

To power the handset, install the battery (p. 11) and charge it for about **15 hours** before initial use (p. 13).

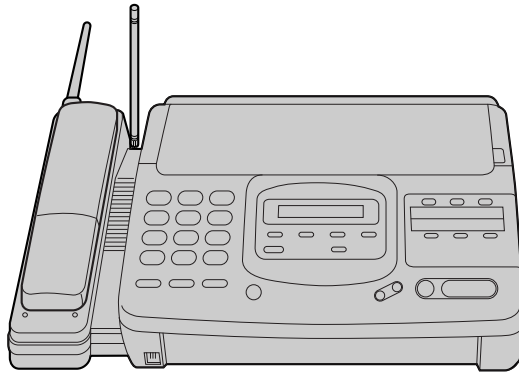

Operating distance/noise

Calls are transmitted between the main unit and the handset using wireless radio waves. **For maximum distance and noise free operation**, the recommended main unit location is:

Away from electrical appliances such as a TV, radio, or personal computer.

In a HIGH and CENTRAL location with no obstructions such as walls.

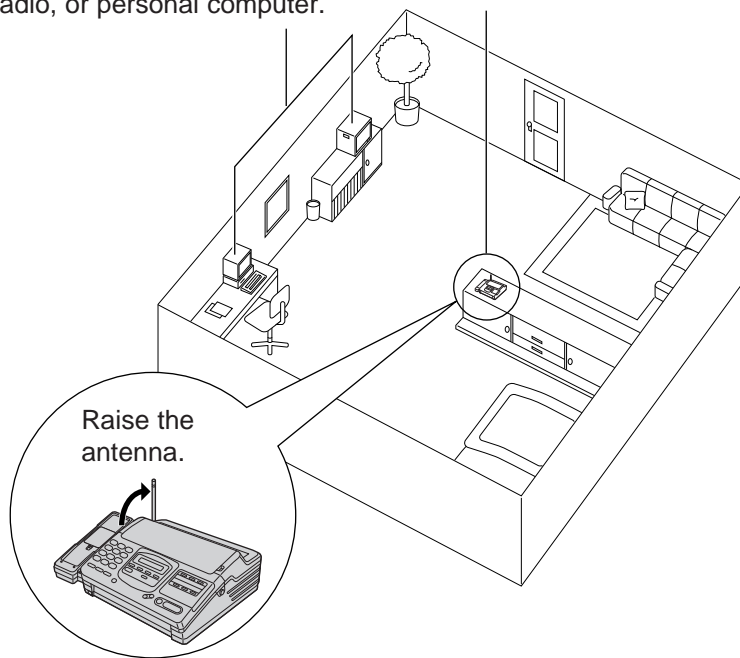

Important safety instructions

When using this unit, basic safety precautions should always be followed to reduce the risk of fire, electric shock, or personal injury.

1. Read and understand all instructions.
2. Follow all warnings and instructions marked on this unit.
3. Unplug this unit from AC outlets before cleaning. Do not use liquid or aerosol cleaners. Use a damp cloth for cleaning.
4. Do not use this unit near water, for example, near a bath tub, wash bowl, kitchen sink, or the like.
5. Place this unit securely on a stable surface. Serious damage and/or injury may result if the unit falls.
6. Do not cover slots and openings on the unit. They are provided for ventilation and protection against overheating. Never place the unit near radiators, or in a place where proper ventilation is not provided.
7. Use only the power source marked on the unit. If you are not sure of the type of power supplied to your home, consult your dealer or local power company.
8. For Safety purposes this product is equipped with a three prong grounded plug. If you do not have this type of outlet, please have one installed. Do not use any type of adaptor plug to defeat this safety feature.
9. Do not place objects on the power cord. Install the unit where no one can step or trip on the cord.
10. Do not overload wall outlets and extension cords. This can result in the risk of fire or electric shock.
11. Never push any objects through slots in this unit. This may result in the risk of fire or electric shock. Never spill any liquid on the unit.
12. To reduce the risk of electric shock, do not disassemble this unit. Take the unit to an authorized servicer when service is required. Opening or removing covers may expose you to dangerous voltages or other risks. Incorrect reassembly can cause electric shock when the unit is subsequently used.
13. Unplug this unit from the wall outlet and refer servicing to an authorized servicer when the following conditions occur:
 - A. When the power supply cord or plug is damaged or frayed.
 - B. If liquid has been spilled into the unit.
 - C. If the unit has been exposed to rain or water.
 - D. If the unit does not work normally by

following the operating instructions. Adjust only controls covered by the operating instructions. Improper adjustment may require extensive work by an authorized servicer.

- E. If the unit has been dropped or physically damaged.
 - F. If the unit exhibits a distinct change in performance.
14. During thunderstorms, avoid using telephones except cordless types. There may be a remote risk of an electric shock from lightning.
 15. Do not use this unit to report a gas leak, when in the vicinity of the leak.

SAVE THESE INSTRUCTIONS

CAUTION:

To reduce the risk of fire or injury to persons, read and follow these instructions.

1. Use only the battery(ies) specified.
2. Do not dispose of the battery(ies) in a fire. They may explode. Check with local waste management codes for special disposal instructions.
3. Do not open or mutilate the battery(ies). Released electrolyte is corrosive and may cause burns or injury to the eyes or skin. The electrolyte may be toxic if swallowed.
4. Exercise care in handling batteries in order not to short the battery to conductive materials such as rings, bracelets, and keys. The battery and/or conductor may overheat and cause burns.
5. Charge the battery(ies) provided with or identified for use with this product only in accordance with the instructions and limitations specified in this manual.

INSTALLATION:

1. Never install telephone wiring during a lightning storm.
2. Never install telephone jacks in wet locations unless the jack is specifically designed for wet locations.
3. Never touch uninsulated telephone wires or terminals unless the telephone line has been disconnected at the network interface.
4. Use caution when installing or modifying telephone lines.

WARNING:

To prevent the risk of fire or electrical shock, do not expose this product to rain or any type of moisture.

OTHER INFORMATION

- Keep the unit away from electrical noise-generating devices, such as fluorescent lamps and motors.
- The unit should be kept free from dust, high temperature, and vibration.
- The unit should not be exposed to direct sunlight.
- Do not place heavy objects on top of this unit.
- Do not touch the plug with wet hands.

Automatic security code setting

Whenever you place the handset on the main unit, the unit automatically selects one of a million security codes. These codes help to avoid unauthorized use of your telephone line by another cordless telephone.

Table of Contents

Installation and Connection

Location of controls	8
Installing your unit	10
Connections	12
Battery charge	13

Initial Preparation

Setting the date, time, logo and facsimile telephone number	14
Adjusting volumes	17
Selecting the receive mode	18

Basic Operations

Making/answering voice calls	20
Making calls with the handset	20
Answering calls with the handset	20
Making calls with the main unit	21
Answering calls with the main unit	21
Transmitting documents	22
Receiving documents	24
Making a copy	28

Advanced Operations

Automatic dialing

Storing phone numbers for automatic dialing	29
Storing phone numbers in the main unit	29
Storing phone numbers in the handset	30
Making voice calls using automatic dialing	31
Dialing with the handset	31
Dialing with the main unit	31
Transmitting documents using automatic dialing	32
Electronic telephone directory	33

Telephone

Intercom between the handset and the main unit	34
Transferring a call using intercom	35
Voice contact (talking to the caller during or after fax reception or transmission) ..	36
TONE, FLASH and PAUSE buttons	37

Facsimile transmission

Polling (retrieving fax documents)	38
Delayed transmission (sending a fax at a later time)	39
Sending documents overseas	40
Changing the logo print position	40

Facsimile reception

Remote fax receiving (using an extension to receive a fax message)	41
Junk mail prohibitor (preventing the reception of unwanted fax documents)	42
Receiving with distinctive ring service	43
Signaling your pager that you have received a fax document	44
Setting the friendly reception	45

Others

Using an external telephone answering machine	46
Changing the display contrast	50
Resetting the advanced features	50
Summary of user programmable features	51
Printing reports and lists	52

Troubleshooting and Routine Care

Error messages on the display	55
Before requesting help	56
Clearing a recording paper jam	59
Clearing a document jam	60
Adjusting the feeder pressure	60
Optional spare battery	61
Cleaning the unit	63

General Information

FCC information	64
Limited warranty	65
Service center directory	66
Information for users	67
Accessory order information	67
Specifications	68
Speed dialer list for the main unit	69
Memory station list for the handset	69
Index	71

Location of controls

Handset

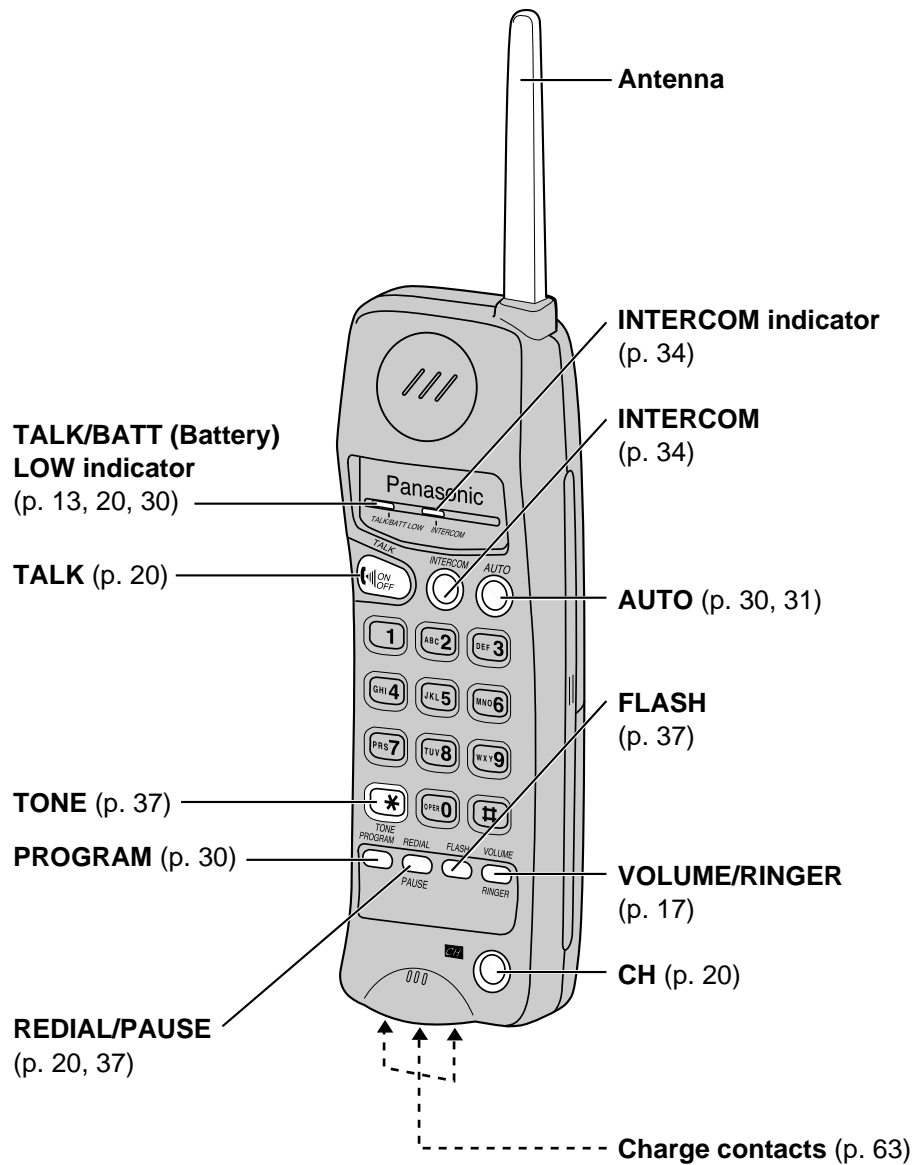

Main unit

Front view

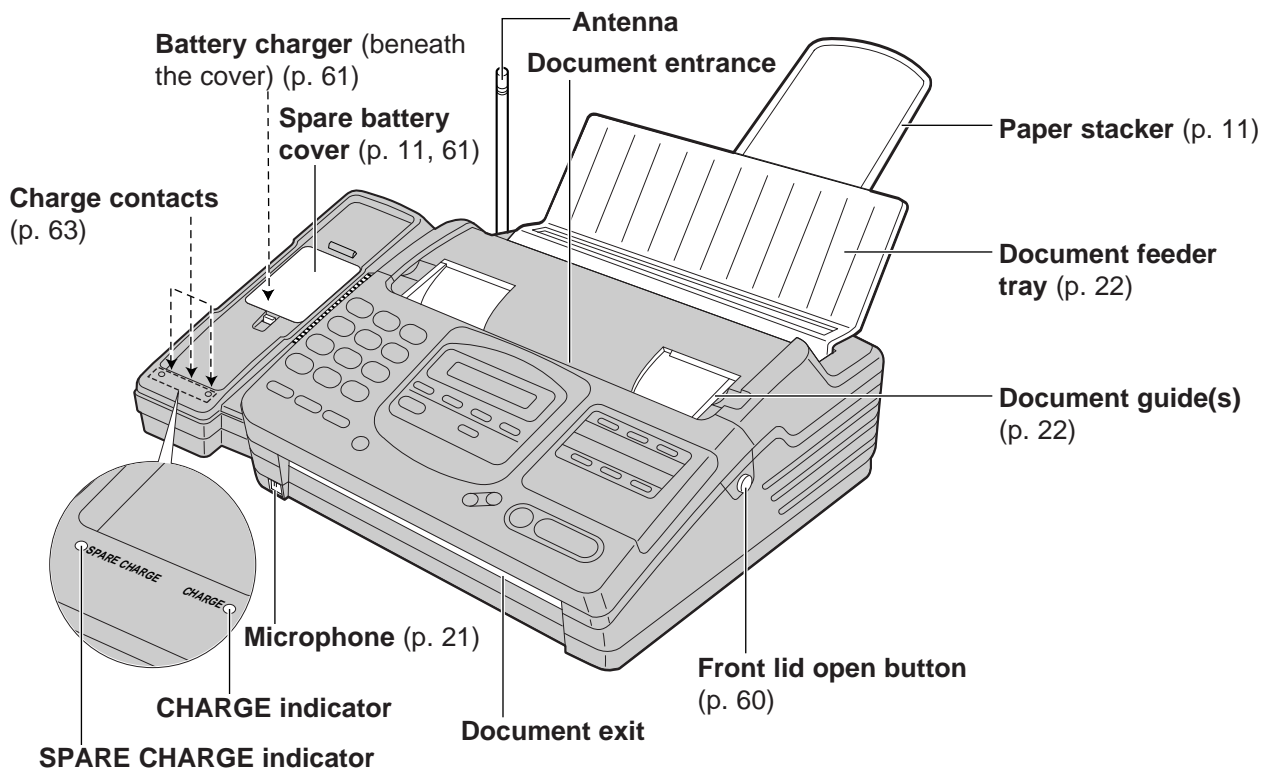

Control panel

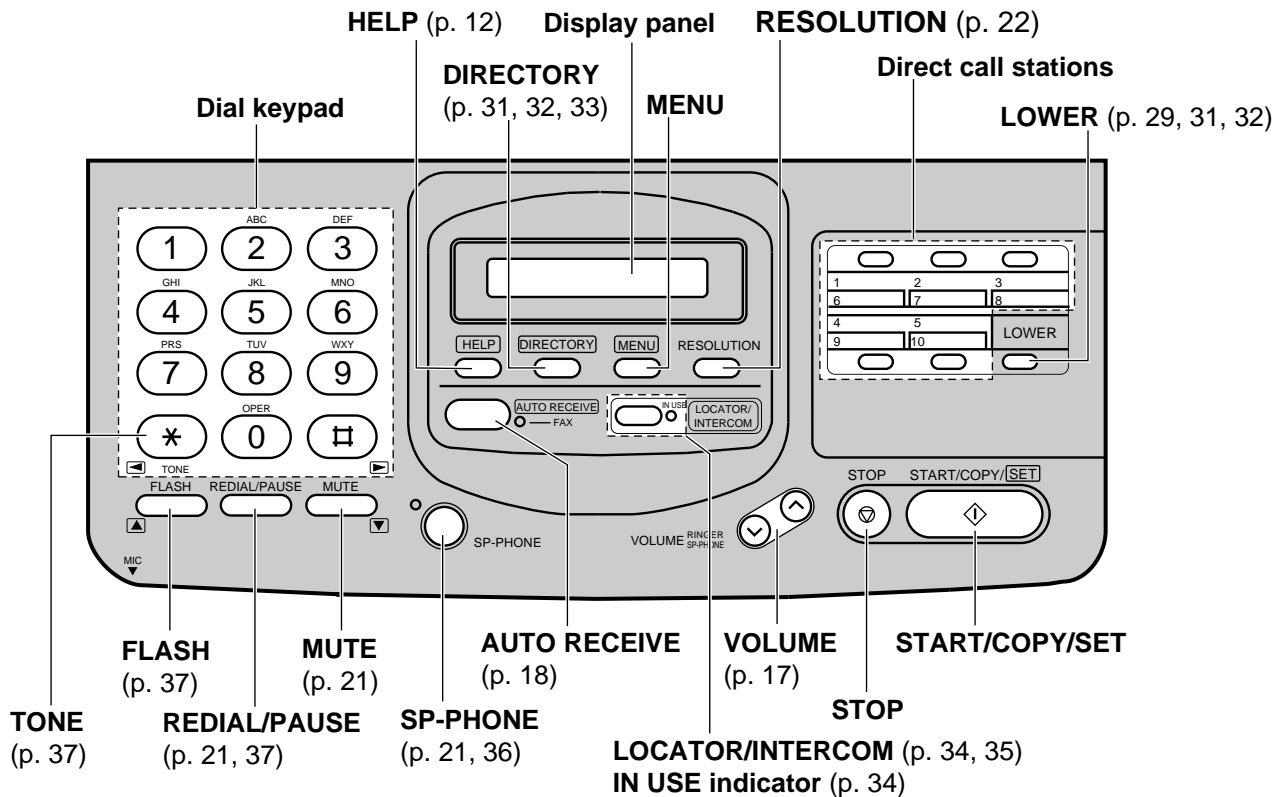

Installing your unit

Installing the recording paper

- 1
 - (A) Open the back lid by lifting up the tabs located on both sides.
 - (B) Install a recording paper roll in the main unit.
 - Make sure that the shiny side of the paper is facing down and there is no slack, tape, or glue residue on the paper roll.

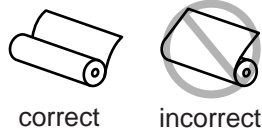

- 2 Insert the leading edge of the recording paper between the recording paper roller and the silver plate.

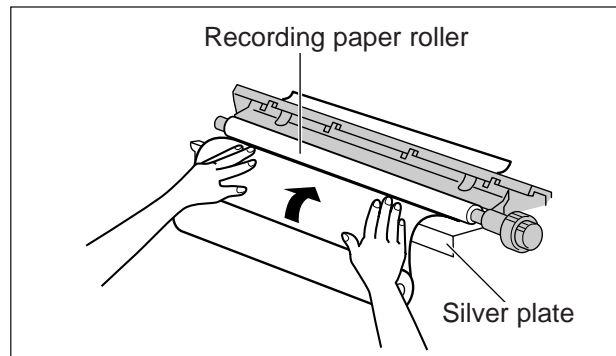
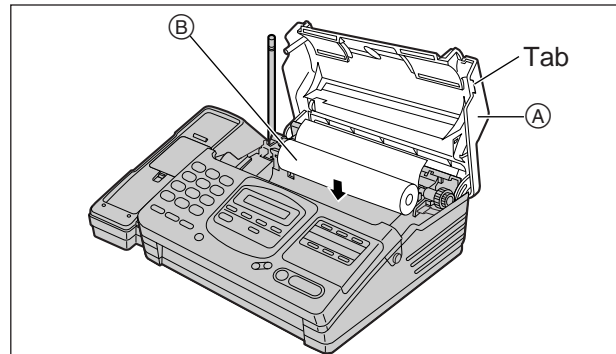

- 3 Close the back lid by gently pressing down on both ends.

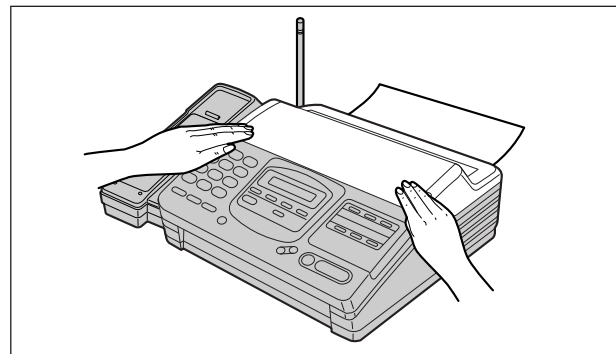

Note:

- Only use the included roll of paper or specified recording paper, or else the print quality may be affected and/or excessive thermal head wear may occur.
- The beginning of some recording paper rolls are secured with glue or tape.
Cut approximately 150 mm (6 inches) from the new roll of paper prior to installation.
- To order recording paper, see page 67.

Installing the paper stacker

Install the paper stacker.

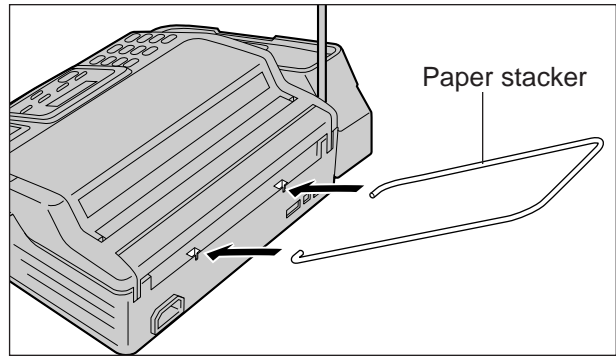

Installing the spare battery cover on the main unit

Close the spare battery cover.

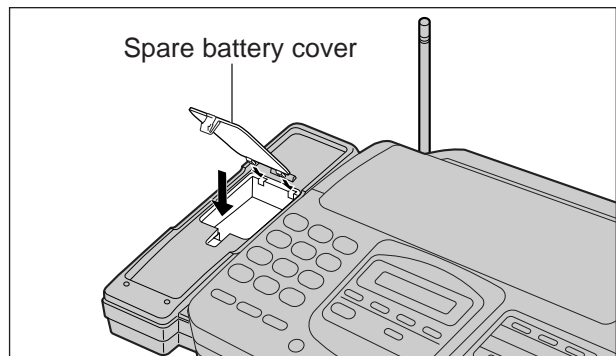

Installing the battery in the handset

1 Install the battery as shown observing the proper polarity.

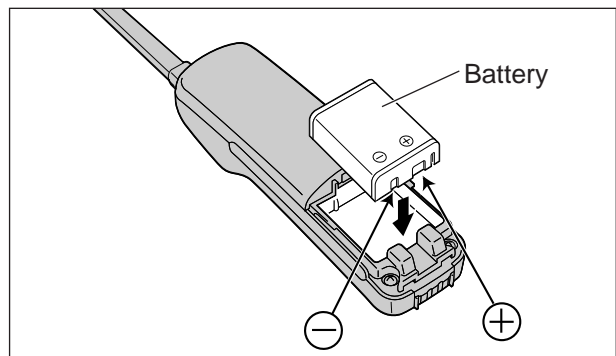

2 Install the battery cover.

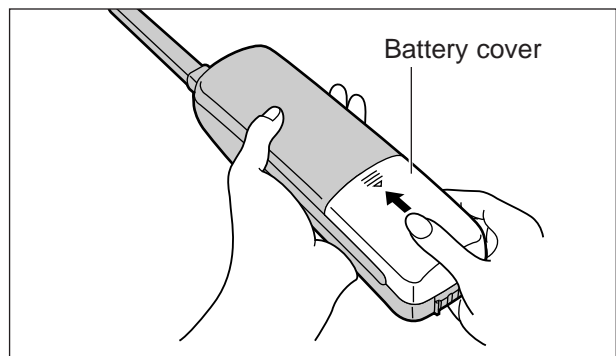

Connections

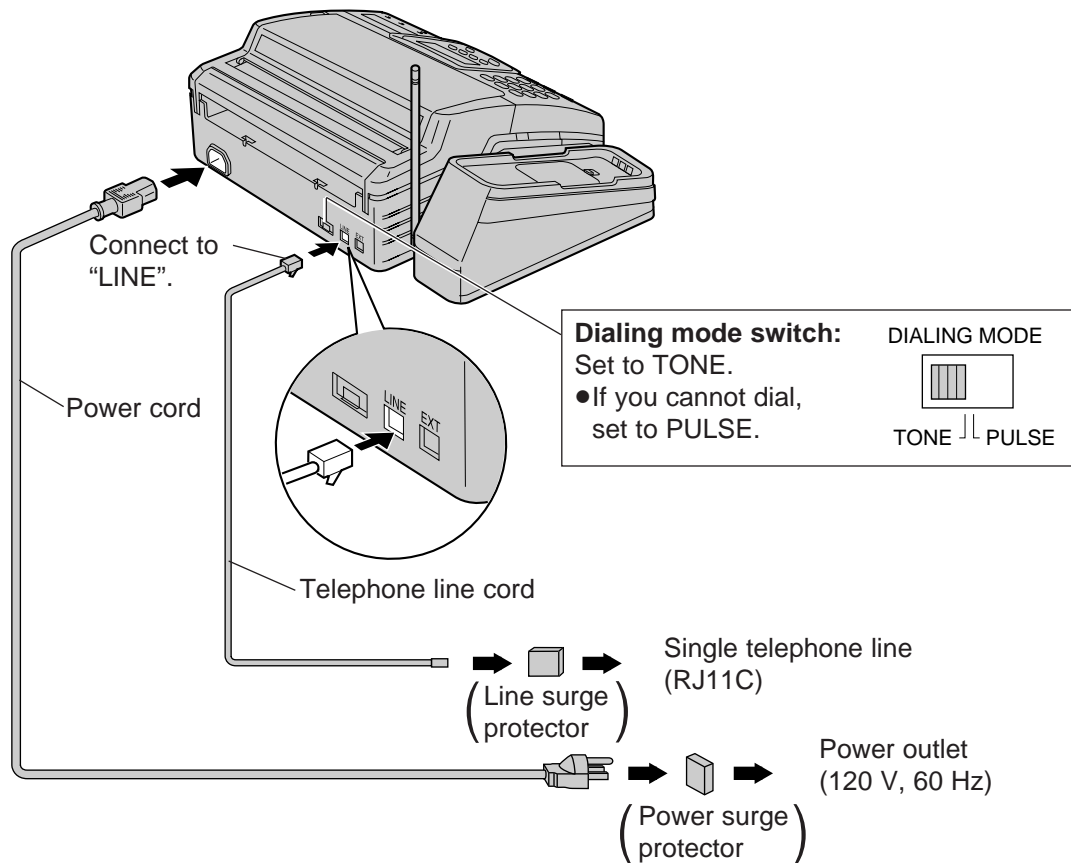

Note:

- For additional equipment protection, we recommend the use of a surge protector. The following types are available; TELESPIKE BLOK MODEL TSB (TRIPPE MFG. CO.), SPIKE BLOK MODEL SK6-0 (TRIPPE MFG. CO.), SUPER MAX (PANAMAX) or MP1 (ITW LINX).
- You can connect an extension phone or a telephone answering machine to the unit after removing the tab on the external telephone jack (EXT). See page 46.
- When you operate this product, the power outlet should be near the product and easily accessible.

Helpful hint:

- If assistance is needed, press **HELP**. The unit will print a quick reference.

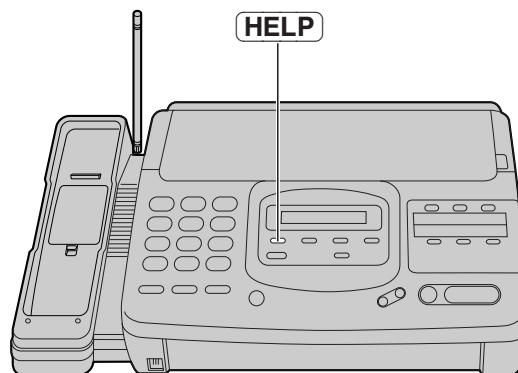

Battery charge

Place the handset on the main unit for about **15 hours**.

- The CHARGE indicator lights.

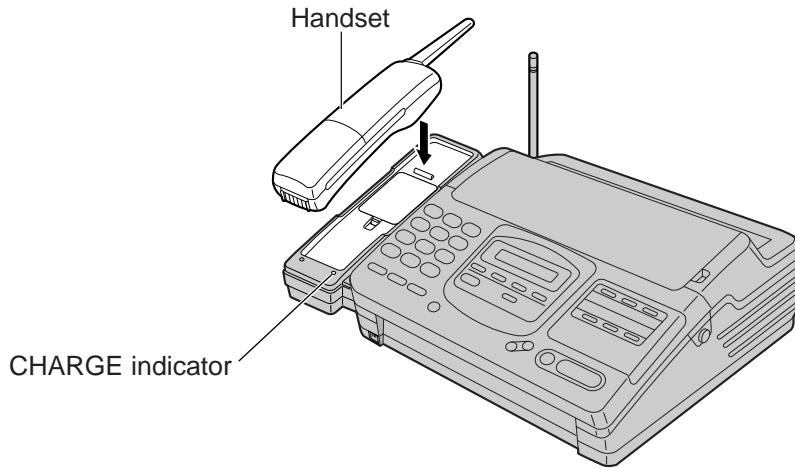

Recharge

When the TALK/BATT LOW indicator flashes slowly or the unit beeps intermittently, recharge the battery.

If you do not want to wait until the battery is fully recharged, we recommend you purchase an optional spare battery (page 61).

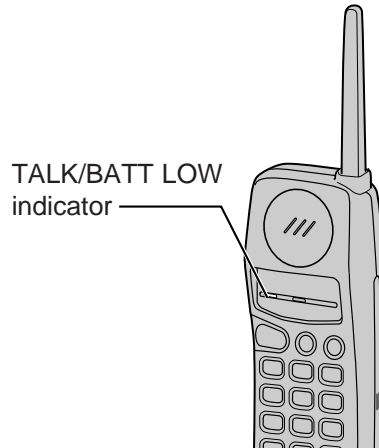

Standard battery life

If your Panasonic battery is fully charged;

While in use (TALK)	Up to about 4.5 hours
While not in use (Stand-By)	Up to about 14 days



- Battery life may vary depending on usage conditions and ambient temperature.
- Clean the handset and the main unit charge contacts with a dry soft cloth once a month**, or the battery may not charge properly (see page 63).
- Once the battery is fully charged, you do not have to place the handset on the main unit until the TALK/BATT LOW indicator flashes slowly.
- The battery cannot be overcharged.

Setting the date, time, logo and facsimile telephone number

Before using your unit, program the correct date and time, your logo and your facsimile telephone number.

This information will be printed on the top of each page transmitted from your unit.
To change the print position, see page 40.

Setting the date and time

- 1 Press **MENU**.

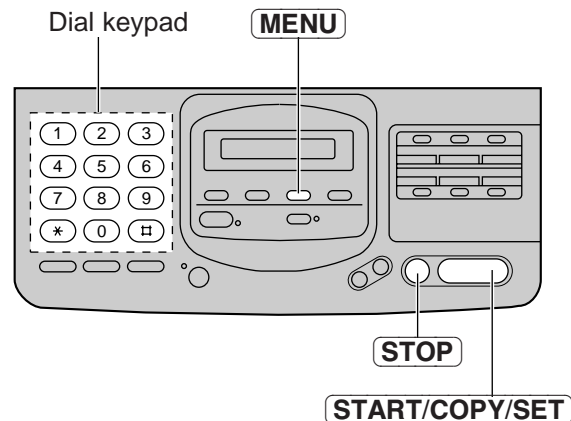
- 2 Press **#**, then **0 1**.

- 3 Press **START/COPY/SET**.
- 4 Enter the correct month/day/year/hour/minute by selecting each 2 digits.
Then press ***** for AM or **#** for PM.
Example: Aug. 10 1996, 3:00PM
Press **0 8 1 0 9 6 0 3**
0 0, then press **#** for PM.
- 5 Press **START/COPY/SET**.
- 6 Press **MENU**.





Note:

- If you make a mistake while programming, press **STOP** then make corrections.
- The accuracy of the clock will be approximately ± 60 seconds a month.

Setting your logo

Usually the logo is a company, division or personal name in an abbreviated form.

- 1 Press **MENU**.

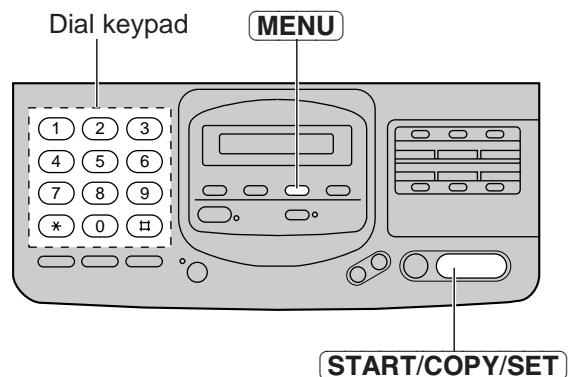
- 2 Press **#**, then **0 2**.

- 3 Press **START/COPY/SET**.

- 4 Enter your logo up to 30 characters.
• Refer to the instructions on page 15.
- 5 Press **START/COPY/SET**.
- 6 Press **MENU**.



How to enter characters and symbols

The dial keypad and the direct call stations can be used as character input keys and command keys. Pressing 0–9 and direct call station 1 will alternately select a character as shown below.

Keys	Number of times												
	1	2	3	4	5	6	7	8	9	10	11	12	13
1	1	[]	{	}	+	-	/	=	,	.	_	'
2	A	B	C	a	b	c	2						
3	D	E	F	d	e	f	3						
4	G	H	I	g	h	i	4						
5	J	K	L	j	k	l	5						
6	M	N	O	m	n	o	6						
7	P	Q	R	S	p	q	r	s	7				
8	T	U	V	t	u	v	8						
9	W	X	Y	Z	w	x	y	z	9				
0	0	()	<	>	!	"	#	\$	%	&	¥	
	:	;	?		*	@	^	'	→				
	INSERT key (Used to insert one character or one space.)												
	SPACE key (Used to replace one character with a space.)												
	DELETE key (Used to delete one character.)												
	▶ key (Used to move the cursor to the right.)												
	◀ key (Used to move the cursor to the left.)												

For example, when entering "Mike" as your logo:

1 Press **6**.

LOGO=M

2 Press **4** six times.

LOGO=Mi

3 Press **5** five times.

LOGO=Mik

4 Press **3** five times.

LOGO=Mike

Note:

- If you use the same number key continuously to enter the next character, press **#** to move the cursor.

To correct a mistake while programming

Use **#** and ***** to move the cursor to the incorrect character, then make the correction.

or

Press **STOP** to delete the character to the left of the cursor.

To see the layout of the direct call station keys

Remove the directory card cover with a pencil or similar object and turn the directory card over.

Setting your facsimile telephone number

1 Press **MENU**.

SYSTEM SET UP

2 Press **#**, then **0** **3**.

YOUR TEL NO.

3 Press **START/COPY/SET**.

NO. =

4 Enter your facsimile telephone number up to 20 digits.

- The **#** button inserts a space and the ***** button a “+”.
- If you make a mistake, press **STOP** to delete the wrong number to the left of the cursor.

5 Press **START/COPY/SET**.

6 Press **MENU**.

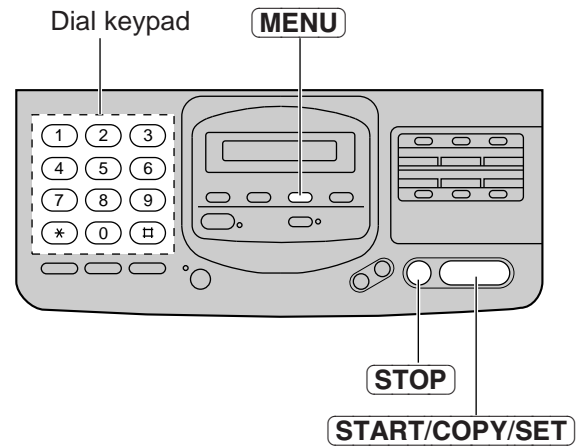

Adjusting volumes

Main unit

■ Ringer volume

3 levels (high/low/off) are available.
Press **VOLUME** (v/^) while the unit is idle.

To turn the ringer off:

1. Press **VOLUME** (v) repeatedly.
 - The following message will be shown.

RINGER OFF=OK?

2. Press **START/COPY/SET**.

While the ringer volume is set to off:

The display will show the following message and the unit will not ring when receiving a call.

RINGER OFF

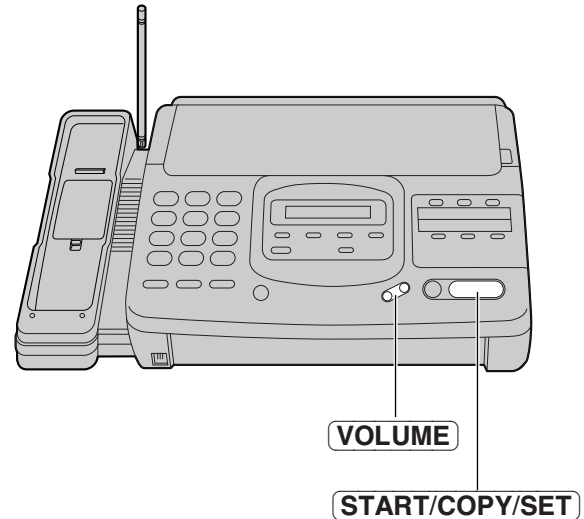

■ Speaker volume

8 levels (high to low) are available.
Press **VOLUME** (v/^) while using the speakerphone.

Handset

■ Ringer volume

3 levels (high/low/off) are available.
Be sure the TALK/BATT LOW indicator light is off.

To set to high or low:

Press **VOLUME/RINGER**.

To turn the ringer off:

While pressing **VOLUME/RINGER**, press **0** until 2 beeps sound.

To turn the ringer on:

Press **VOLUME/RINGER**.

- The ringer sounds at the high level.

■ Handset volume

2 levels (high/normal) are available.
Press **VOLUME/RINGER** while talking.

■ Selecting the ringer tone (2 types)

When the TALK/BATT LOW indicator light is off, press **VOLUME/RINGER**, then press ***** within 5 seconds. The selected ringer tone sounds.

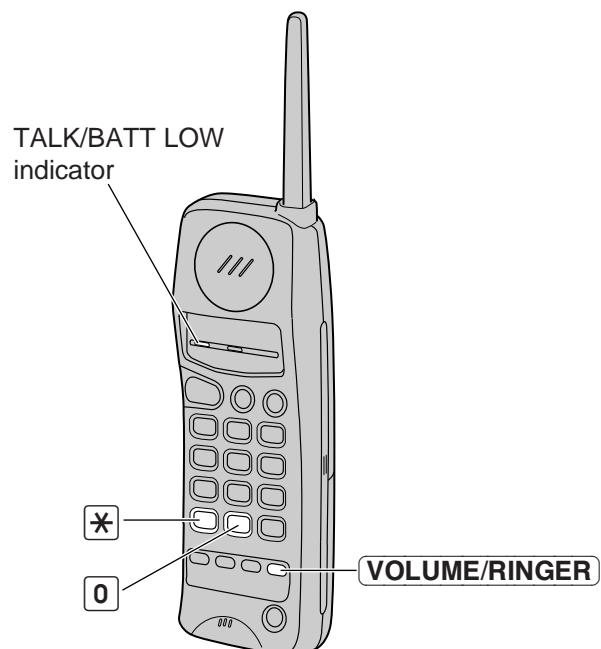

Selecting the receive mode

This unit has two types of receive modes; AUTO RECEIVE and MANUAL RECEIVE.

—When you are unable to answer, set the AUTO RECEIVE mode.

—When you are available, set the MANUAL RECEIVE mode.

Press **AUTO RECEIVE** to switch to the desired mode.

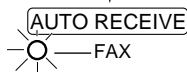
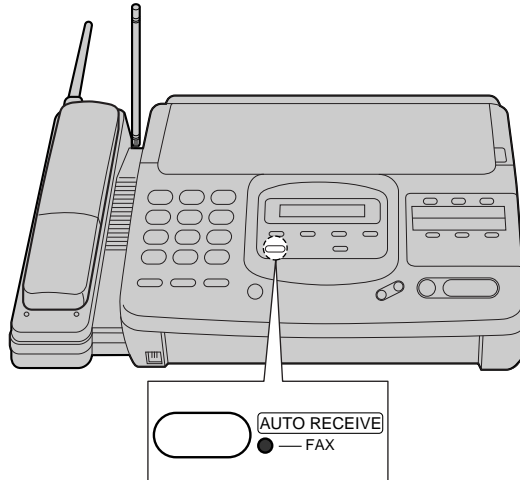

■ AUTO RECEIVE mode

The FAX indicator light goes on.

FAX mode: (pre-selected setting)
Select this mode when you use the unit solely as a fax machine (see page 25).

Display: FAX MODE



- You can select the EXT.TAM mode instead of the FAX mode as an AUTO RECEIVE mode (page 19).

EXT.TAM mode:
Select this mode when you connect a telephone answering machine to the external telephone (EXT) jack and leave the home or office (see page 46).

Display: EXT.TAM MODE

- If your external telephone does not have an answering/recording feature, do not select this mode. We recommend that you select the TEL mode.

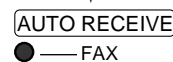

■ MANUAL RECEIVE mode

The FAX indicator light goes off.

TEL mode: (pre-selected setting)
Select this mode when you wish to answer all calls manually.

Display: TEL MODE

- When no one answers an incoming call by 15 rings, the unit will temporarily activate the fax function to receive documents.



- You can select the TEL/FAX mode instead of the TEL mode as a MANUAL RECEIVE mode (page 19).

TEL/FAX mode:
Select this mode when you are near the unit and do not want to hear the unit ring when faxes are received but wish to answer voice calls (see pages 26, 27 and 28).



Display: TEL/FAX MODE

Note:

- Regardless of the mode you select, you can always place calls and send faxes.

Changing the setting of the AUTO RECEIVE mode

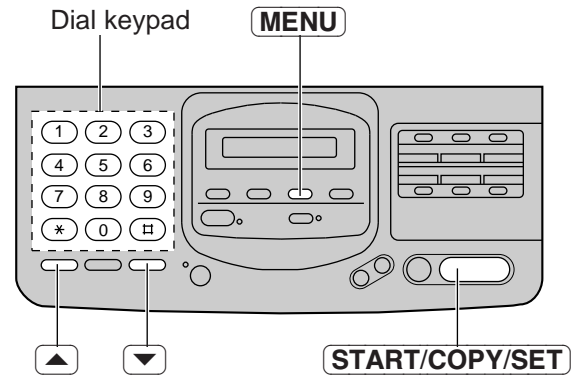

You can select either FAX mode (pre-selected setting) or EXT.TAM mode in the AUTO RECEIVE mode. If you want to change the setting, follow the steps below.

- 1 Press **MENU**.

- 2 Press **#**, then **0** **5**.

- 3 Press **START/COPY/SET**.

- 4 Press **▲** or **▼** to select the desired setting.
- 5 Press **START/COPY/SET**.
- 6 Press **MENU**.

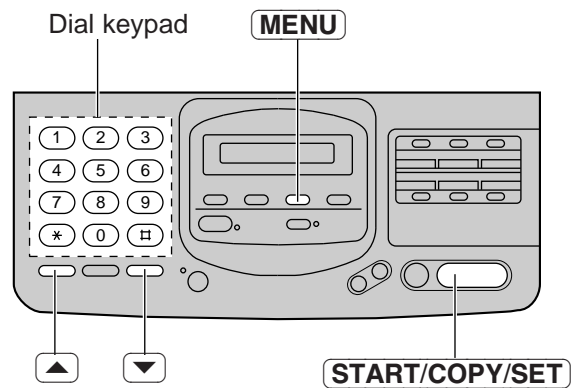

Changing the setting of the MANUAL RECEIVE mode

You can select either TEL mode (pre-selected setting) or TEL/FAX mode in the MANUAL RECEIVE mode. If you want to change the setting, follow the steps below.

- 1 Press **MENU**.

- 2 Press **#**, then **0** **8**.

- 3 Press **START/COPY/SET**.

- 4 Press **▲** or **▼** to select the desired setting.
- 5 Press **START/COPY/SET**.
- 6 Press **MENU**.

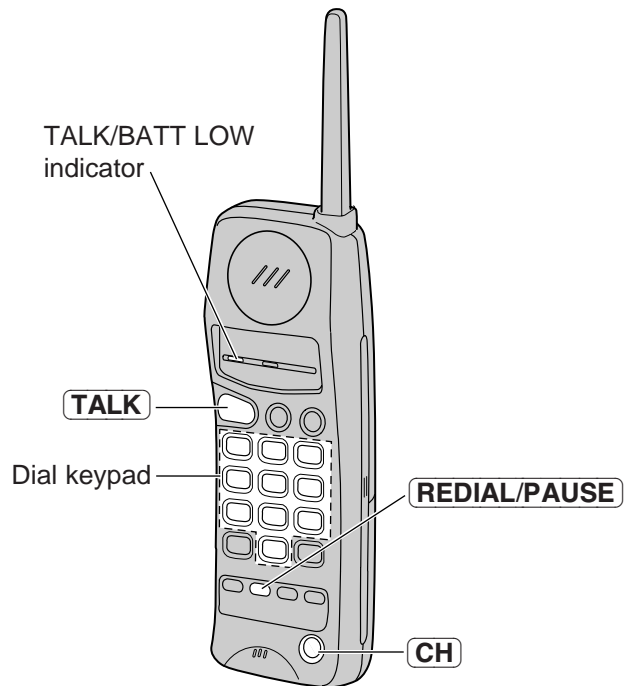

Making/answering voice calls

Making calls with the handset

- 1 Press **TALK**.
 - The TALK/BATT LOW indicator lights.
- 2 Dial a phone number.
 - If you misdial, hang up and dial again.
- 3 To hang up, press **TALK** or place the handset on the main unit.
 - The indicator light goes out.



To redial the last number

Press **TALK**, then press **REDIAL/PAUSE**.

Note:

- If an alarm tone sounds in step 1, move towards the main unit or place the handset on the main unit. Then try again.

Answering calls with the handset

- 1 If the handset is off the main unit, press **TALK**.
 - You can also answer a call by pressing any dialing button 0 to 9, *, or # (—Any key talk).

OR

If on the main unit, just lift it.

- 2 To hang up, press **TALK** or place the handset on the main unit.

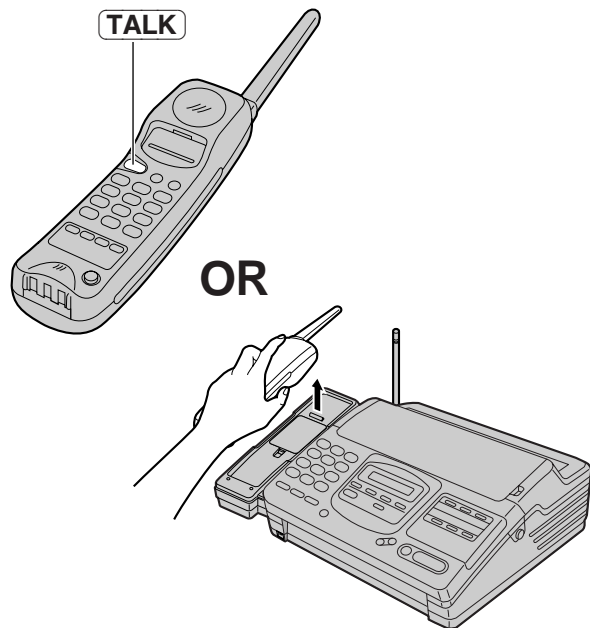

If noise interferes with the conversation

Press **CH** to select a clear channel or move closer to the main unit.

Lighted keypad

The dialing buttons will light while dialing and flash when a call is received. The lights will go out about 10 seconds after dialing or answering the call.

Making calls with the main unit

- 1 Press **SP-PHONE**.
 - The SP-PHONE indicator lights.
- 2 Dial a phone number.
 - If you misdial, hang up and dial again.
- 3 When the other party answers, speak into the microphone.
- 4 To hang up, press **SP-PHONE**.
 - The indicator light goes out.

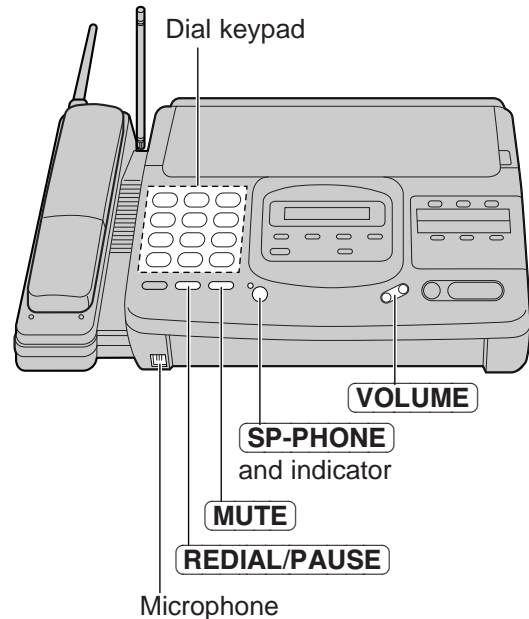

To redial the last number

- Press **SP-PHONE**, then press **REDIAL/PAUSE**.
- If the line is busy, the unit will automatically redial the number up to 14 times.

Answering calls with the main unit

- 1 When the unit rings, press **SP-PHONE**.
- 2 Speak into the microphone.
- 3 To hang up, press **SP-PHONE**.

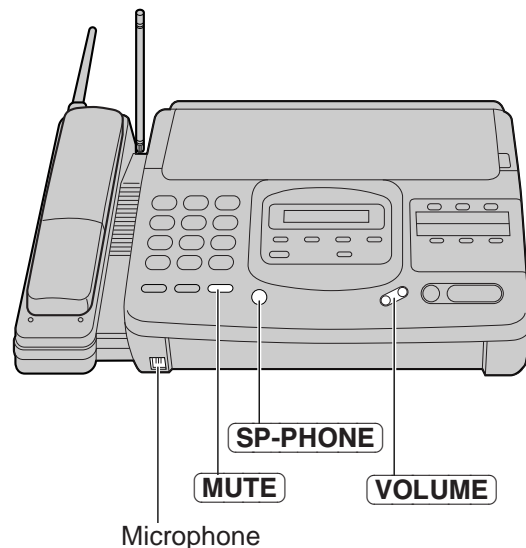

Voice muting

Using this feature, the other party cannot hear you but you can hear them.

1. Press **MUTE** during a telephone conversation.

<MUTE>

2. To resume the conversation, press **MUTE** again.

Hints for speakerphone operation

- Use the speakerphone in a quiet room.
- If the other party has difficulty hearing you, adjust the volume using **VOLUME**.
- If you and the other party speak at the same time, parts of your conversation will be lost.
- While using the speakerphone, if the handset is on the main unit, you may switch to the handset by lifting it up.

Transmitting documents

Documents you can send

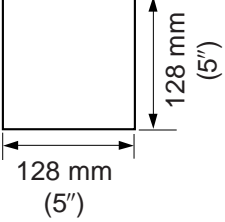
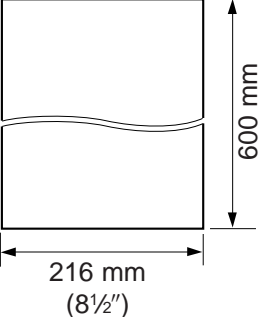
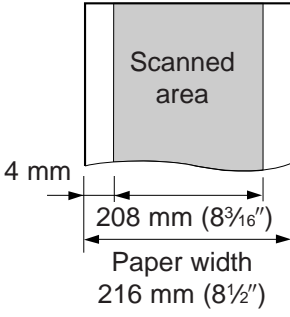
Minimum size	Maximum size	Effective scanning area	Document weight
			Single sheet: 45 to 90 g/m ² (12 to 24 lb.) Multiple sheets: 60 to 75 g/m ² (16 to 20 lb.)

Note:

- Remove clips, staples or other similar fastening objects.
- Check that ink, paste or correction fluid has dried.
- Do not send the following types of documents. Use copies for fax transmission.
 - Chemically treated paper such as carbon or carbonless duplicating paper
 - Electrostatically charged paper
 - Heavily curled, creased or torn paper
 - Paper with a coated surface
 - Paper with a faint image
 - Paper with printing on the opposite side that can be seen through the front (e.g. newspaper)

Loading documents

- 1 Open the document feeder tray.
- 2 Insert the documents **FACE DOWN** until a beep tone is heard.
 - The unit can accept up to 15 sheets of paper at a time.
- 3 Adjust the document guides to the width of the document.
- 4 Press **RESOLUTION** repeatedly to the desired setting.

STANDARD	For printed or typewritten originals with normal-sized characters.
FINE	For originals with small printing.
SUPER FINE	For originals with minute printing.
HALF TONE	For originals containing photographs, shaded drawings, etc.

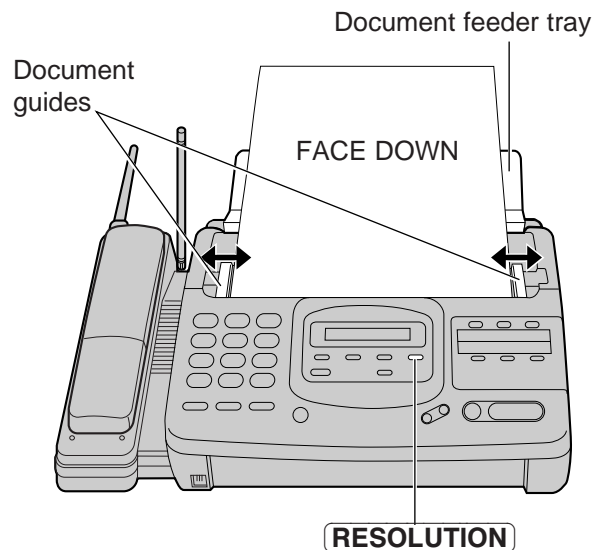

Note:

- Using the fine, super fine or half tone setting will increase transmission time.
- If the resolution setting is changed during feeding, it will be effective from the next sheet.
- The super fine resolution only works with other compatible machines.

Transmitting documents manually

- 1 Insert the documents **FACE DOWN** until a beep tone is heard.
- 2 Press **SP-PHONE**, then dial a phone number.
 - If you misdial, hang up and dial again.

OR

Press **TALK** on the handset, then dial a phone number.

 - If you misdial, hang up and dial again.
- 3 When a fax tone is heard, press **START/COPY/SET** on the main unit.

Note:

- If the other party answers your call, ask them to start receiving a fax, then press your **START/COPY/SET**.
- The unit will automatically end the transmission after the last sheet is transmitted.

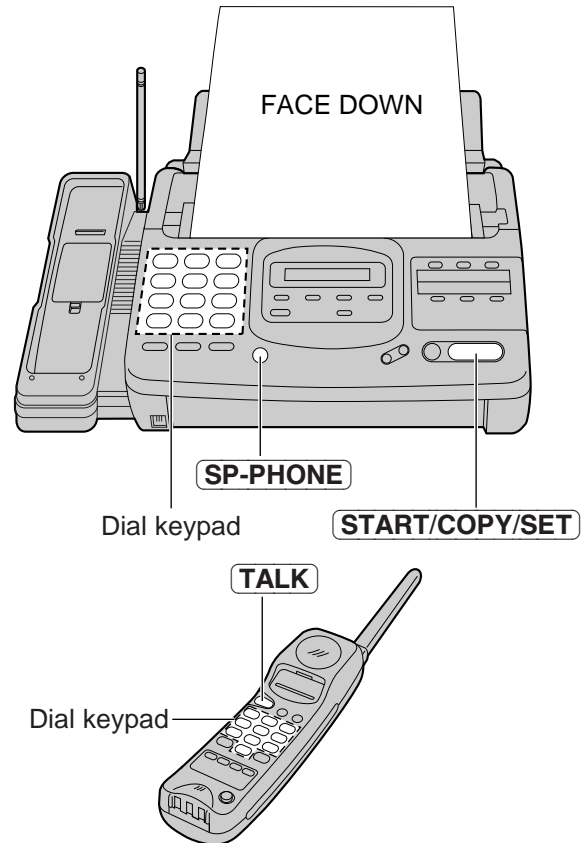

Transmitting documents with fewer procedures

- 1 Insert the documents **FACE DOWN** until a beep tone is heard.
- 2 Dial a phone number.
 - If you misdial, press **STOP** and dial again.
- 3 Press **START/COPY/SET**.
 - The unit will start to dial and transmit the documents.

Fax auto redial

- If there is no answer or the line is busy, the unit will automatically redial the number up to 5 times. This feature is available when you transmit documents with fewer procedures, automatic dialing (p. 32), delayed transmission (p. 39) and receive polling (p. 38). To cancel redialing, press **STOP**.

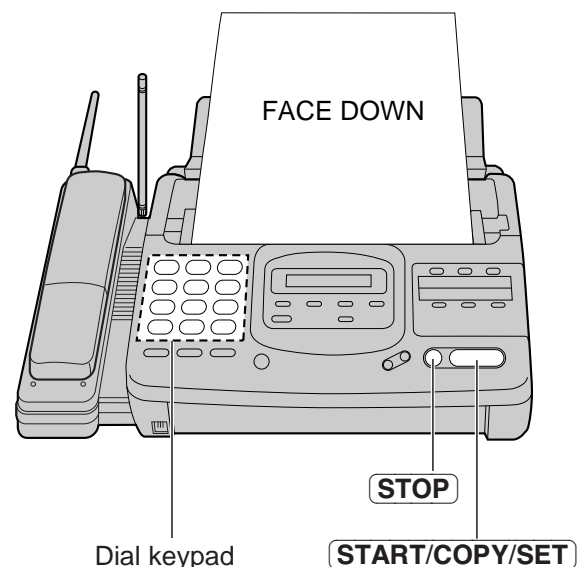

To send 16 or more sheets at a time

Insert the first 15 sheets of the document. Add the extra sheets (up to 15) before the last sheet is fed into the unit.

To stop transmission

- Press **STOP**.
- To eject the document, press **STOP** again.

Receiving documents

Receiving fax documents manually

Answering with the main unit

1 Press **SP-PHONE** to answer the call.

2 When:
—document reception is required,
—a slow beep is heard, or
—no sound is heard,
press **START/COPY/SET**.

- The recording paper will print out face side down.

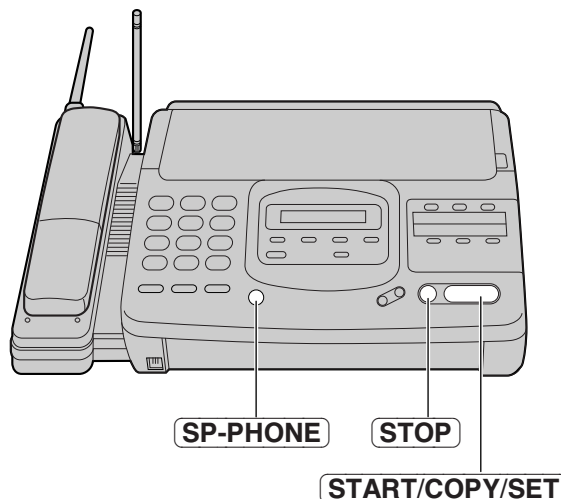

Answering with the handset

1 Press **TALK** to answer the call.

2 When:
—document reception is required,
—a slow beep is heard, or
—no sound is heard,
press *** *#**.

- If your line has a rotary pulse dial service, press *** *#** 3 times.

OR

Press **START/COPY/SET** on the main unit.

- You can stop the reception from the handset by pressing **#** within 3 seconds after hearing 3 beeps.

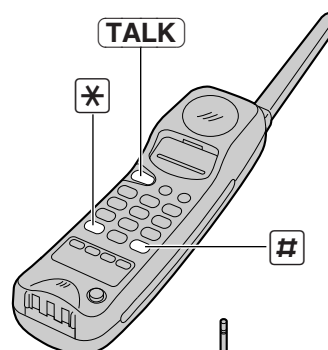

Friendly reception

When you answer the call and hear a slow beep, the unit will automatically start reception even if you do not press **START/COPY/SET** or the ***** button on the handset.

- If this feature is not required, set to OFF (see page 45).

To stop reception

On the main unit:

Press **STOP**.

From the handset:

Press **#** within 3 seconds after pressing ***** twice or after pressing **START/COPY/SET** on the main unit.

Receiving fax documents only (FAX mode)

When you turn on the AUTO RECEIVE mode that is set to FAX, the unit will work only as a facsimile machine. The main unit will automatically answer all calls and generate fax tones to the callers. Callers will hear fax tones and will only be able to transmit faxes.

Setting up the unit for fax reception

- 1 Set the AUTO RECEIVE mode to FAX (see page 19).
- 2 Turn on the AUTO RECEIVE mode by pressing **AUTO RECEIVE** until the FAX indicator light goes on.
 - The display shows the following message.

FAX MODE

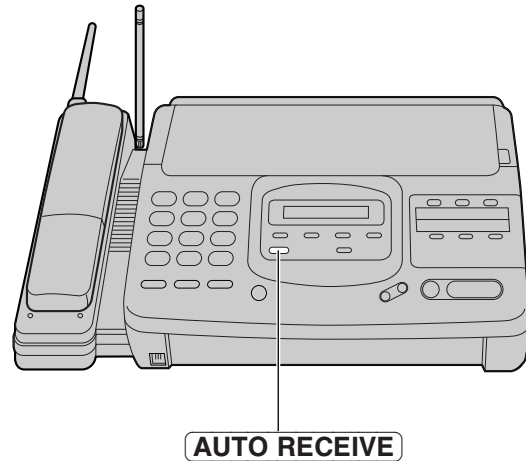

Setting the FAX mode ring count

This feature determines the number of rings after which the unit answers a call in the FAX mode. You can choose from 1 to 4 rings.

Helpful hints:

- To answer a call before the unit does, increase the number of rings.
- If you find receiving faxes from machines with an automatic transmission feature difficult, decrease the number of rings.

- 1 Press **MENU**.
SYSTEM SET UP
- 2 Press **#**, then **0** **7**.
FAX RING
- 3 Press **START/COPY/SET**.
RING=1 [▲▼]
- 4 Press **▲** or **▼** to select the desired number.
- 5 Press **START/COPY/SET**.
- 6 Press **MENU**.

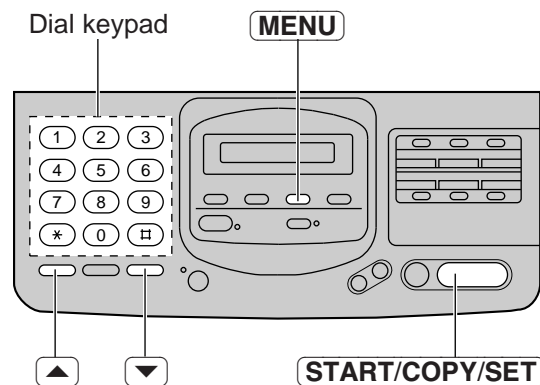

Note:

- If an extension telephone with a caller ID or call display feature is connected to the same line, set the number of rings to more than 2.

Receiving both voice and fax calls (TEL/FAX mode)

Use this mode when you wish to receive voice calls with ring but do not want to hear the unit ring when faxes are received.

When a call is received, the unit will work as follows.

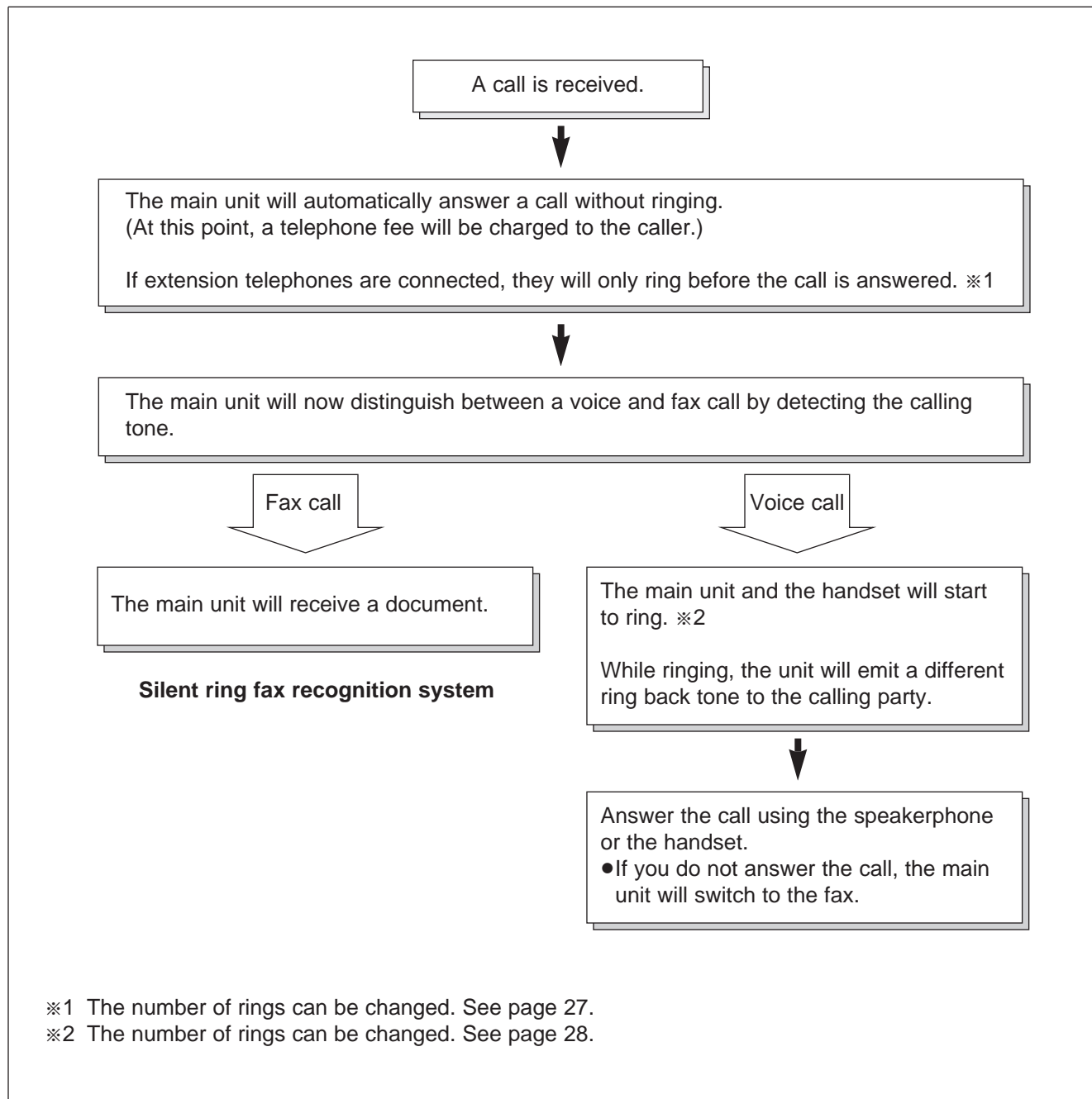

Note:

- Some fax messages that are transmitted manually may not send a calling tone. These calls must be manually received.

Setting up the unit

- 1 Set the MANUAL RECEIVE mode to TEL/FAX (see page 19).
- 2 Make sure that the AUTO RECEIVE mode is turned off.
 - If the FAX indicator light is on, press **AUTO RECEIVE** to turn off the AUTO RECEIVE mode.

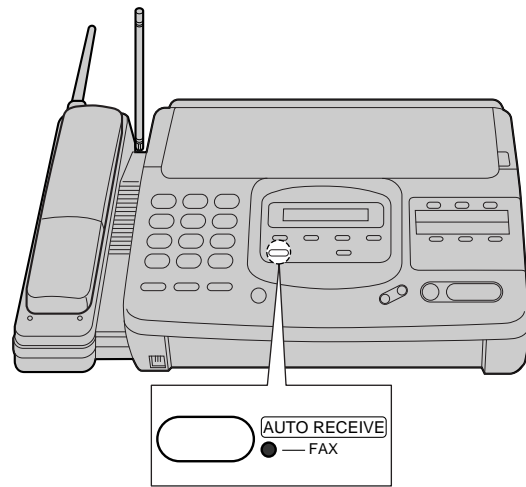

Setting the TEL/FAX mode ring count

This feature determines the number of rings after which the unit automatically answers a call in the TEL/FAX mode.

You can choose from 1 to 4 rings.

- 1 Press **MENU**.
SYSTEM SET UP
- 2 Press **#**, then **0** **9**.
TEL/FAX RING
- 3 Press **START/COPY/SET**.
RING=1 [▲▼]
- 4 Press **▲** or **▼** to select the desired number.
- 5 Press **START/COPY/SET**.
- 6 Press **MENU**.

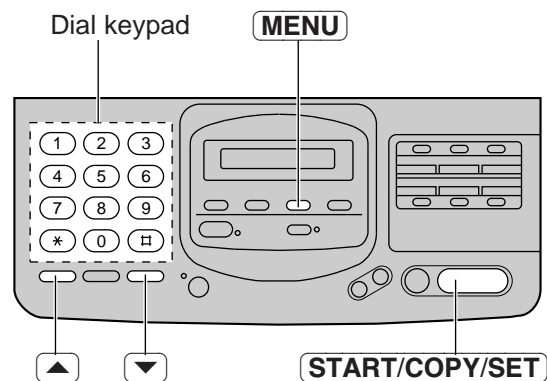



Note:

- If an extension telephone with a caller ID or call display feature is connected to the same line, set the number of rings to more than 2.

Setting the silent fax recognition ring count

When a fax call is received in the TEL/FAX mode, the unit will automatically activate the fax function without ringing. If the unit detects a voice call, it will ring. You can choose from 3 to 6 rings.

- 1 Press **MENU**.

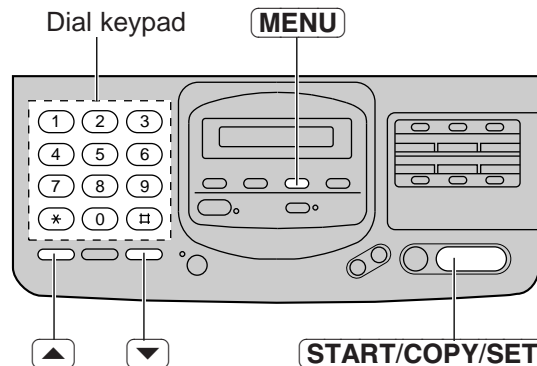
- 2 Press **#**, then **3** **0**.

- 3 Press **START/COPY/SET**.

- 4 Press **▲** or **▼** to select the desired number.
- 5 Press **START/COPY/SET**.
- 6 Press **MENU**.



Making a copy

Any transmittable document can be copied (see page 22).

- 1 Insert the documents (up to 15 sheets) **FACE DOWN** until a beep tone is heard.
- 2 Press **START/COPY/SET**.

Note:

- When copying, the unit will automatically select FINE resolution. To change the resolution, press **RESOLUTION**.
- You can make or receive a voice call while making a copy.



To stop copying

Press **STOP**.

Storing phone numbers for automatic dialing

Storing phone numbers in the main unit

The unit's memory allows you to use both one-touch dialing and speed dialing for rapid access to your most frequently dialed numbers.

One-touch dialing: The main unit is equipped with 5 direct call station keys, each of which is divided into an upper station and a lower station.

Speed dialing: The main unit is equipped with 50 additional dialing stations. These stations are assigned to 2-digit numbers (00–49).

1 Press **MENU** until the following message is displayed.

STORE TEL NO.

**2 a: Programming for one-touch dialing:
For upper stations (1–5)**
Press one of the direct call station keys.

For lower stations (6–10)

Press **LOWER**, then press one of the direct call station keys.

b: Programming for speed dialing:

Press **#**, then press the desired 2-digit number (00–49).

3 Enter the phone number up to 30 digits in length.

- To enter a hyphen in a phone number, press **LOWER**.

4 Press **START/COPY/SET**.

NAME=

5 Enter the station name, up to 10 characters, by following the instructions on page 15.

6 Press **START/COPY/SET**.

- To program other stations, repeat steps 2 to 6.

7 Press **STOP**.

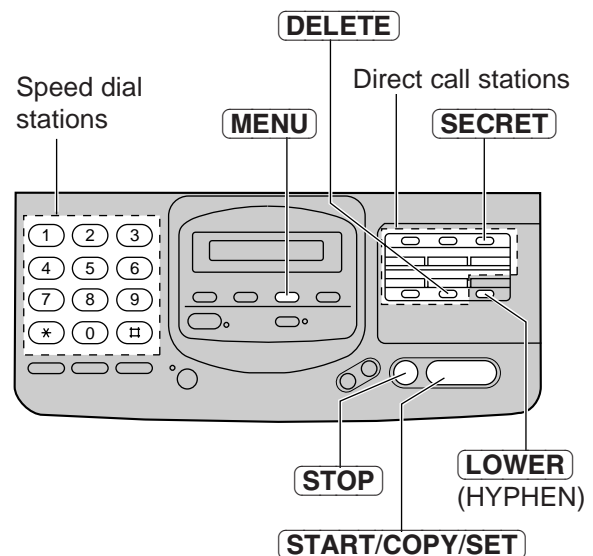

Helpful hint:

- To confirm stored phone numbers and station names, print a telephone number list (see page 52).

To keep whole or part of the phone number secret

Press **SECRET** (direct call station 3) before and after the number you wish to keep secret.

- The phone number will not appear on the display and on the telephone number list.
- Pressing **SECRET** once counts as two digits.

To erase a stored number and station name

Press **STOP** in step 3 to clear the phone number. Press **DELETE** (direct call station 5) repeatedly in step 5 until all of the characters are erased. Then, press **START/COPY/SET**.

Storing phone numbers in the handset

You can store up to 10 phone numbers in the handset. The dialing buttons (0 to 9) function as memory stations. The TALK/BATT LOW indicator light must be off.

- 1** Press **PROGRAM**.
 - The TALK/BATT LOW indicator flashes.
- 2** Enter a phone number up to 16 digits.
 - If you misdial, press **PROGRAM** to end storing, then repeat from step 1.
- 3** Press **AUTO**.
- 4** Press a memory station number (0 to 9).
 - A confirmation tone sounds (see below).
 - To store other numbers, repeat steps 1 through 4.

Note:

- Numbers stored in the handset can only be dialed by the handset.

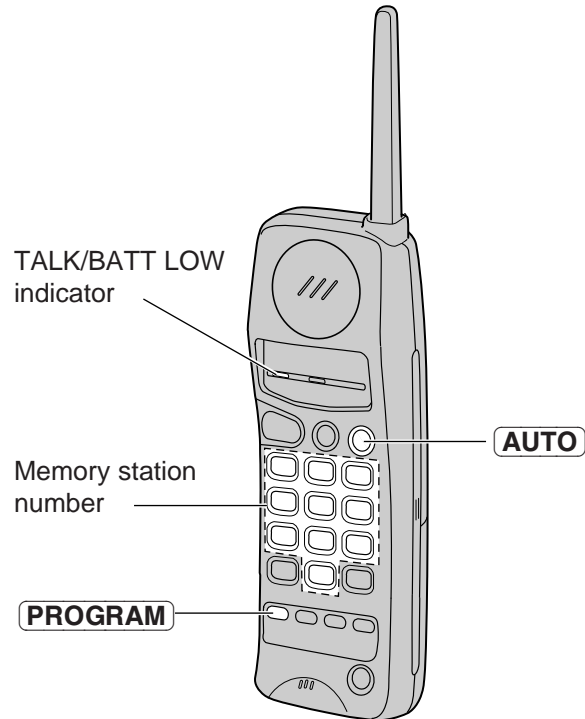

What the confirmation tone means

- 1 beep:** The new number is stored.
2 beeps: The number is the same as a previously stored one.

To erase a stored number

1. Press **PROGRAM**.
2. Press **AUTO** and the memory station number (for the phone number to be erased).

Making voice calls using automatic dialing

Dialing with the handset

- 1 Press **TALK**.
- 2 Press **AUTO**.
- 3 Press the memory station number (0 to 9).
 - The stored number is dialed.

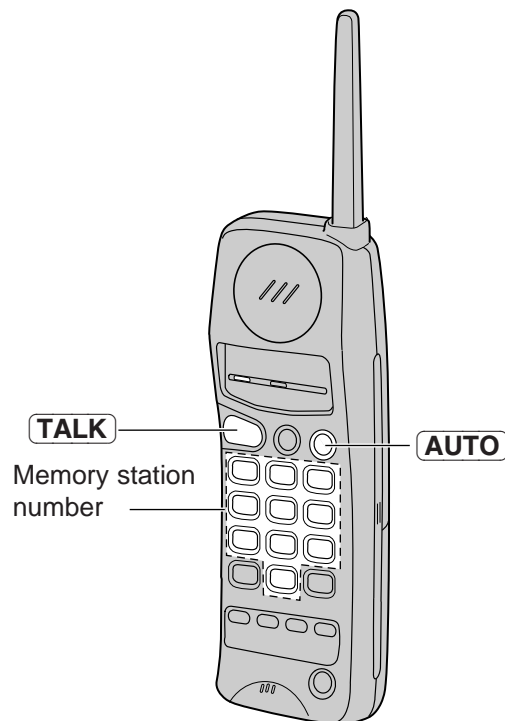

Dialing with the main unit

- 1 Press **SP-PHONE**.
- 2 a: **Using one-touch dialing:**
 - For upper stations (1–5)**
Press the desired direct call station key.
 - For lower stations (6–10)**
Press **LOWER**, then press the desired direct call station key.b: **Using speed dialing:**
Press **DIRECTORY**, then press **#** and the desired 2-digit number (00–49).

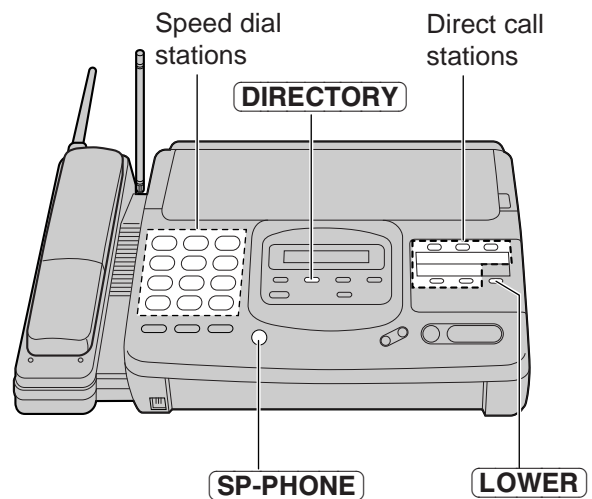

Transmitting documents using automatic dialing

- 1** Insert the documents FACE DOWN.
- 2**
 - a: Using one-touch dialing:**
 - For upper stations (1–5)**
Press the desired direct call station key.
 - For lower stations (6–10)**
Press **LOWER**, then press the desired direct call station key.
 - b: Using speed dialing:**
Press **DIRECTORY**, then press **#** and the desired 2-digit number (00–49).

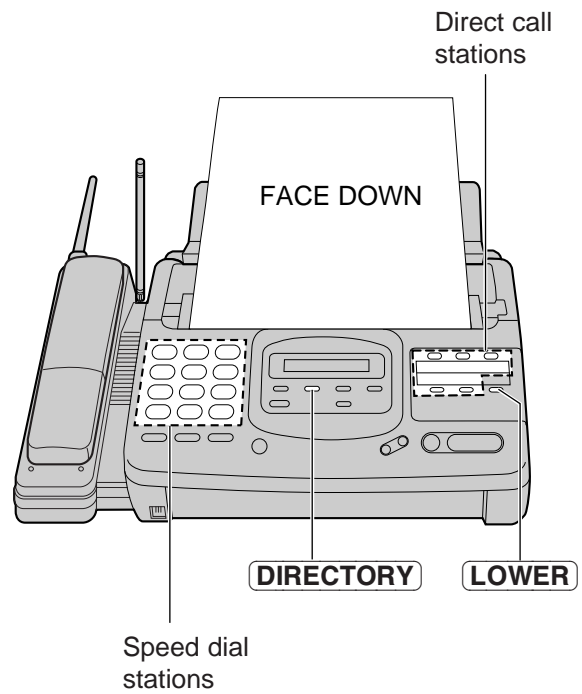

Electronic telephone directory

The station names stored in the main unit's memory are automatically registered into the electronic telephone directory in alphabetical order. You can make a fax or voice call by selecting the desired station name on the display.

If you wish to send a fax, insert the documents into the document tray first.

1 Press **DIRECTORY**.

SELECT INDEX

2 Press the dial key in which the first initial of the station name is assigned (see the index table below).

Example: To search a name with initial "N":
Press **6** repeatedly until the first station name with initial "N" is displayed. Press **▼** until the desired name is displayed.

OR

Press **▲** or **▼** repeatedly until the desired name is displayed.

3 Press **START/COPY/SET**.

- The unit will start dialing.
- If a document is fed into the unit, the unit will start transmission.

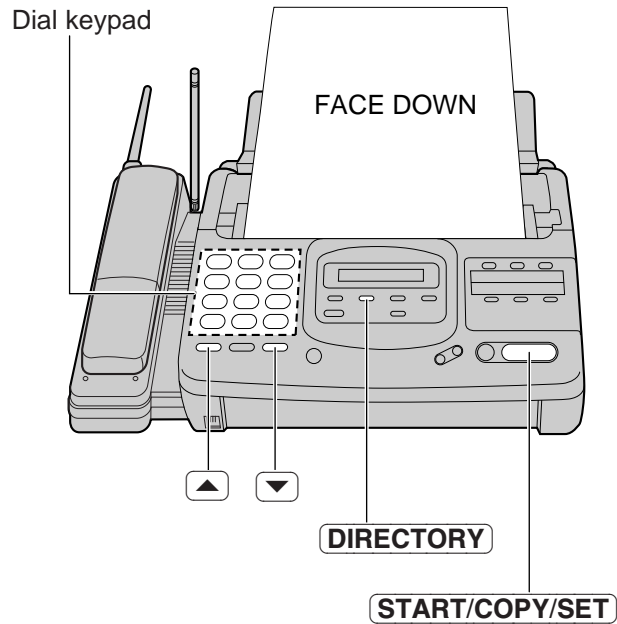

Dial key	Index	Dial key	Index
1	1	7	P, Q, R, S, 7
2	A, B, C, 2	8	T, U, V, 8
3	D, E, F, 3	9	W, X, Y, Z, 9
4	G, H, I, 4	0	0
5	J, K, L, 5	*	Other symbols
6	M, N, O, 6	#	(Used for speed dialing)

Intercom between the handset and the main unit

A 2-way intercom is available between the handset and the main unit.

Paging the main unit from the handset

- 1 Handset:**
Press **INTERCOM**, then talk.
 - The INTERCOM indicator lights.
- 2 Main unit:**
When the other party's voice is heard, answer through the microphone.
 - During the intercom, the main unit's display shows;

INTERCOM CALL

- 3 Handset:**
To end the intercom, press **INTERCOM**.

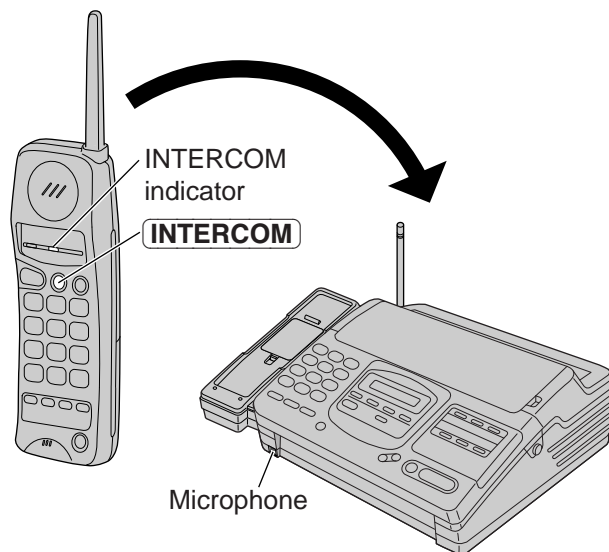

Paging the handset from the main unit (handset locator)

Using this feature, you can locate the handset if misplaced.

- 1 Main unit:**
Press **LOCATOR/INTERCOM**.
 - The IN USE indicator lights.
 - The handset beeps for 1 minute.
 - To stop paging, press **LOCATOR/INTERCOM** again.

- 2 Handset:**
Press **INTERCOM** to answer.

- 3 Main unit:**
Speak into the microphone.
 - During the intercom, the main unit's display shows;

INTERCOM CALL

- 4 Handset:**
To end the intercom, press **INTERCOM**.

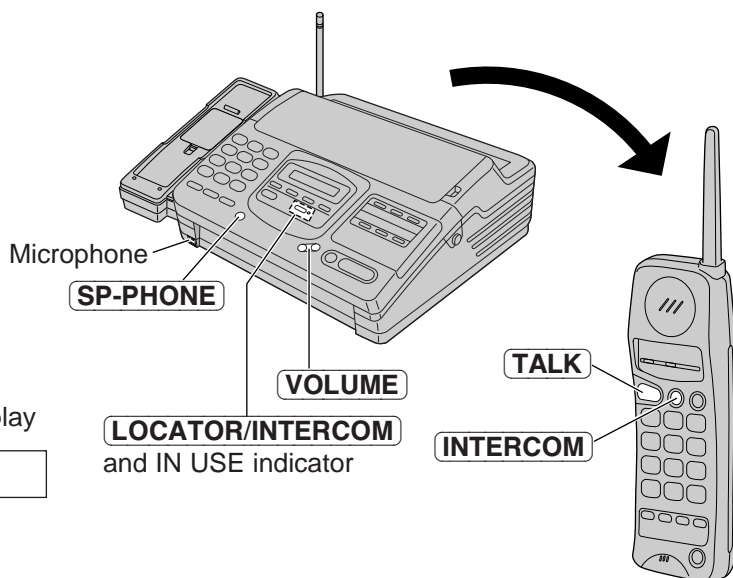

During the intercom

- Intercom calls can only be ended by the handset.
- If the handset user has difficulty hearing the main unit user, decrease the speaker volume by pressing **VOLUME** (v).
- If two tones sound, an incoming call has been received. To answer, press **TALK** on the handset or **SP-PHONE** on the main unit. The intercom is ended.

Transferring a call using intercom

The intercom can be used during a call. This feature enables you to transfer the call between the handset and the main unit.

From the handset to the main unit

- 1 Handset:**
During a call, press **INTERCOM**, then talk.
 - The call is put on hold.
- 2 Main unit:**
When the paging party's voice is heard, answer through the microphone.
- 3 Main unit:**
To answer the call, press **SP-PHONE**.
 - The transfer is completed.
 - The handset user can join the conversation by pressing **TALK**.

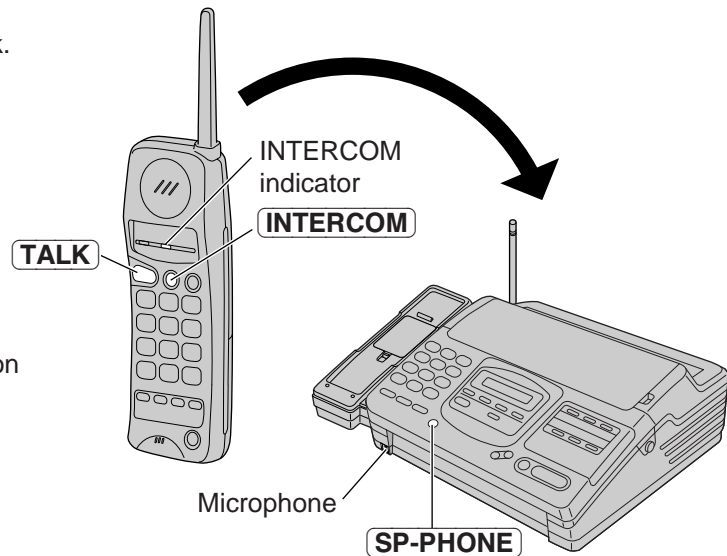

From the main unit to the handset

- 1 Main unit:**
During a call, press **LOCATOR/INTERCOM**.
 - The call is put on hold.
- 2 Handset:**
Press **INTERCOM** to answer the page.
- 3 Handset:**
To answer the call, press **TALK**.
 - The transfer is completed.
 - The main unit user can join the conversation by pressing **SP-PHONE**.

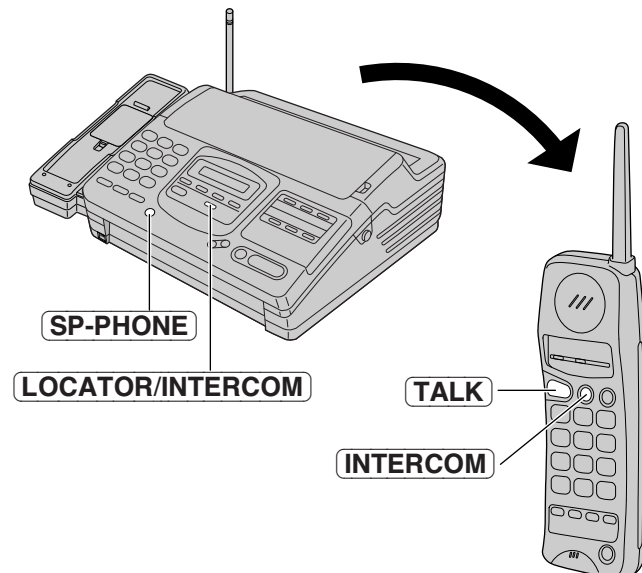

Voice contact

(talking to the caller during or after fax reception or transmission)

You can have a voice conversation with the same call after the fax message is completed. This will save the extra expense and time of making another call.

This feature works only when the other party's unit is equipped with a voice contact feature.

Initiating voice contact

- 1 Press **SP-PHONE** while transmitting or receiving documents.

VOICE STANDBY

- Your unit will call the other party with a distinctive ring.

- 2 When the other party answers, the unit will emit a distinctive ring. Press **SP-PHONE**.

OR

Press **TALK** on the handset to start talking.

- If you initiate voice contact during transmission, you can talk after all the documents have been transmitted.
- If you initiate voice contact during reception, you can talk after the current page of the document is received.
- If the other party does not answer, the line will be disconnected.

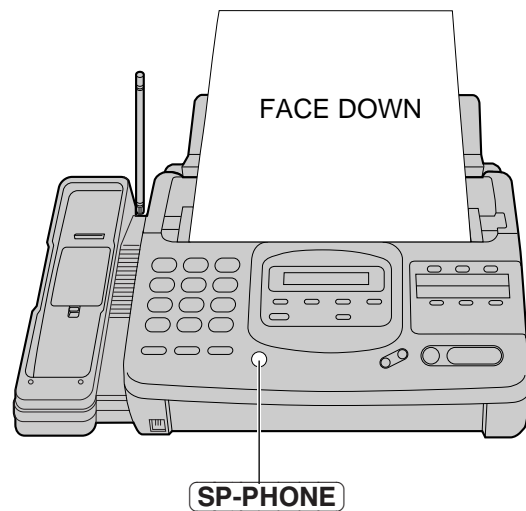

Receiving a request for voice contact

If the other party initiates voice contact, your unit will emit a distinctive ring after transmission or reception is completed.

When the distinctive ring is heard, press **SP-PHONE** on the main unit or press **TALK** on the handset, then start speaking.

Note:

- If you do not answer within 10 seconds of hearing the distinctive ring, the line will be disconnected.

TONE, FLASH and PAUSE buttons

TONE button

The TONE (*) button is used for rotary pulse dial services and allows you to temporarily change from pulse to tone mode during a dialing operation. When you hang up, the unit will automatically return to pulse mode.

FLASH button

The FLASH button functions as the hookswitch on a regular phone. If you misdial or dial another phone number, press the FLASH button firmly.

The FLASH button also allows you to use special features of a host exchange (if connected) or local telephone company services such as call waiting. For further details, contact your local telephone company.

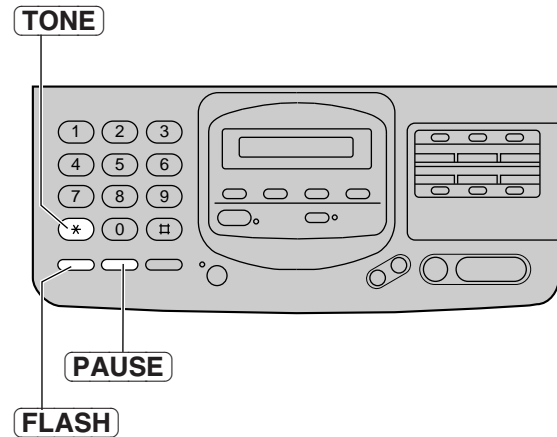

Entering pauses

If the REDIAL/PAUSE button is pressed during dialing, a pause will be inserted.

Example-1: When your unit is connected to a host exchange, insert a pause to get an outside line.

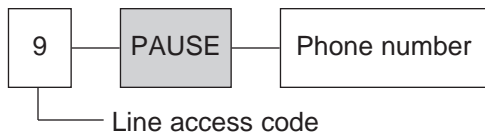

Example-2: If transmission errors occur when making an overseas transmission, add two pauses at the end of the phone number.

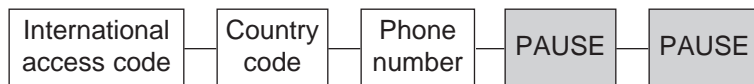

Note:

- TONE, FLASH and PAUSE can be stored into a phone number for automatic dialing.

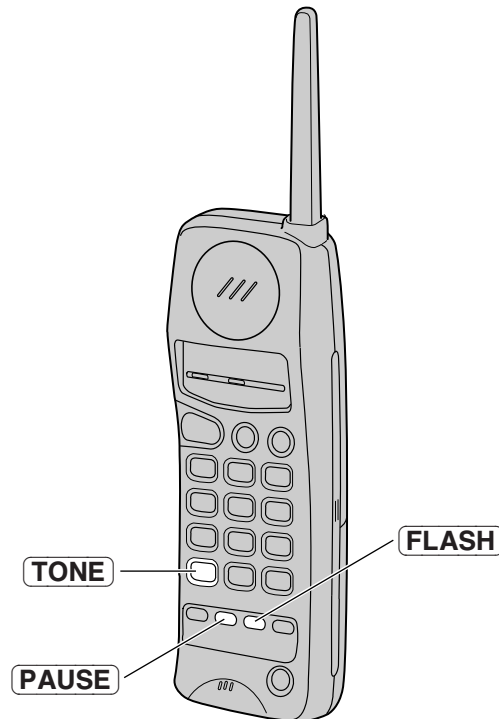

Polling

(retrieving fax documents)

The polling feature allows you to receive a document from another compatible machine where you pay for the call as opposed to the document being sent to you, thereby saving the other party call charges.

Receive polling

To place a call and recover a document from another machine, follow the steps below. Make sure that no documents have been fed into your unit and that the other party's machine is ready for your call.

- 1 Press **MENU** until the following is displayed.

POLLING

- 2 Press **START/COPY/SET**.

NO. =

- 3 Enter the phone number by using one-touch dialing, speed dialing, full number dialing or the electronic telephone directory (see page 33).

- 4 Press **START/COPY/SET**.

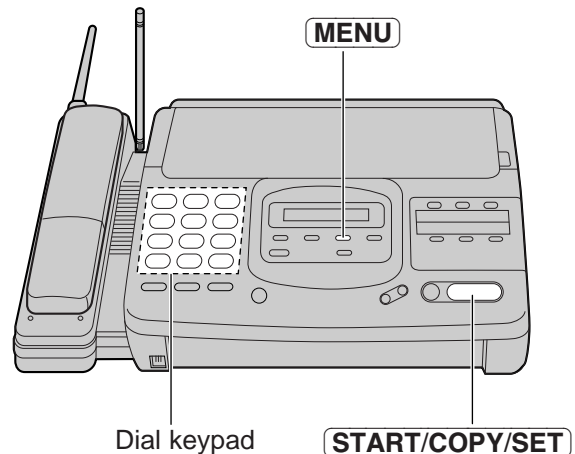

Transmit polling

A document stored in your unit can be recovered by another party's machine. To let other machines retrieve documents loaded on your unit, proceed as follows.

- 1 Insert the documents FACE DOWN.

- 2 Press **MENU** until the following is displayed.

POLLED

- 3 Press **START/COPY/SET**.

MODE=OFF [▲▼]

- 4 Press ▲ or ▼ to select "ON".

MODE=ON [▲▼]

- If this feature is not required, select "OFF".

- 5 Press **START/COPY/SET**.

POLLED ON

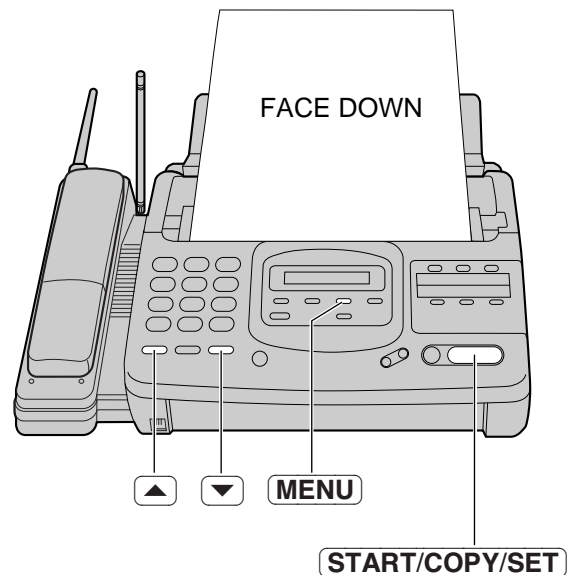

Note:

- When delayed transmission (page 39) is set to ON, transmit polling is not available.

Delayed transmission

(sending a fax at a later time)

Using a built-in clock, this unit can send documents automatically at a specific time. This allows you to take advantage of low-cost calling hours offered by your telephone company. The delayed transmission can be reserved to take place up to 24 hours in advance.

1 Insert the documents FACE DOWN.

2 Press **MENU**.

SYSTEM SET UP

3 Press **#**, then press **2** **5**.

DELAYED XMT

4 Press **START/COPY/SET**.

MODE=OFF [▲▼]

5 Press **▲** or **▼** to select "ON".

MODE=ON [▲▼]

- If this feature is not required, select "OFF".

6 Press **START/COPY/SET**.

NO. =

7 Enter the phone number by using one-touch dialing, speed dialing, full number dialing or the electronic telephone directory.

8 Press **START/COPY/SET**.

TIME=12:00AM

9 Enter the transmission start time.

Example: 11:00PM

Press **1** **1** **0** **0**, then press **#** to select PM.

To select AM, press *****.

10 Press **START/COPY/SET**.

11 Press **MENU**.

- When the programmed time has come, the unit will automatically start transmission.

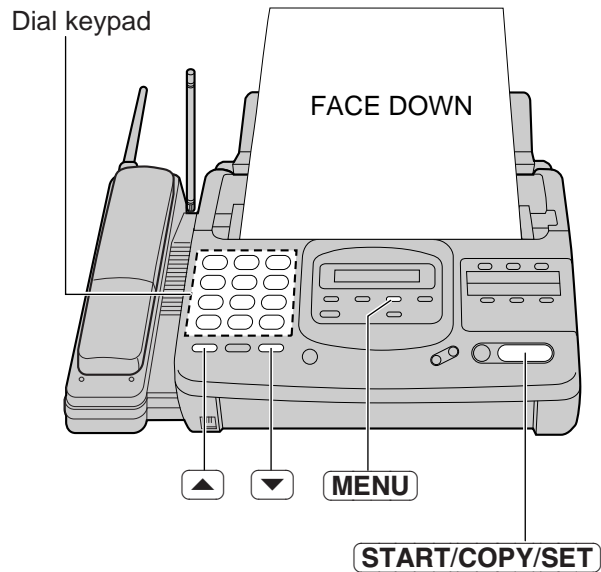

Note:

- You can receive, transmit and copy documents while delayed transmission is set.
- When transmit polling (see page 38) is ON, delayed transmission is not available.

Sending documents overseas

You may experience difficulty in transmitting documents overseas. This feature will make sending documents easier as the transmission speed is slowed down. Before starting the transmission procedure, follow the steps below.

1 Press **MENU**.
SYSTEM SET UP

2 Press **#**, then **2** **3**.
OVERSEAS MODE

3 Press **START/COPY/SET**.
MODE=OFF [▲▼]

4 Press ▲ or ▼ to select "ON".
MODE=ON [▲▼]

•If this feature is not required, select "OFF".

5 Press **START/COPY/SET**.

6 Press **MENU**.

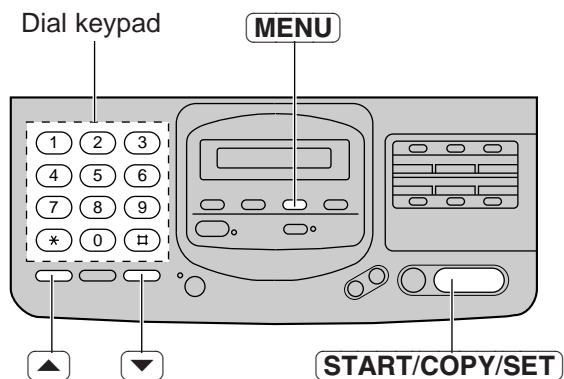

Note:

•After transmission, this feature will be turned off automatically.

Changing the logo print position

The logo, telephone number, date, time and page number will be printed on the transmitted document from your unit in the following manner.

OUT: Outside of the transmitted document's paper size (pre-selected setting).

IN: Inside of the transmitted document's paper size.

1 Press **MENU**.
SYSTEM SET UP

2 Press **#**, then **2** **1**.
LOGO POSITION

3 Press **START/COPY/SET**.
MODE=OUT [▲▼]

4 Press ▲ or ▼ to select the desired setting.

5 Press **START/COPY/SET**.

6 Press **MENU**.

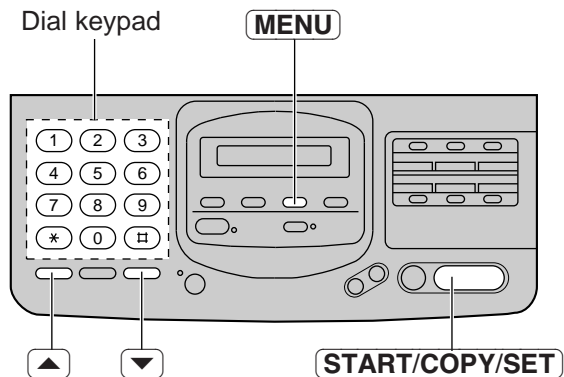

Remote fax receiving

(using an extension to receive a fax message)

If you have an extension phone connected to the main unit or on the same line, it is possible to receive a fax message by operating the extension phone. Using the extension phone, dial the remote fax activation code. This saves you from going to the main unit and pressing **START/COPY/SET**.

Important:

- To activate this feature, use a touch tone telephone as the extension phone and enter the remote fax activation code **FIRMLY**.
- The remote fax activation code is set to ** as a pre-selected setting.
- If your line has a rotary pulse service, press ***** before pressing the remote fax activation code.

Receiving using an extension

- 1 When a call is received, lift the handset of the extension phone.
- 2 When:
 - document reception is required,
 - a slow beep is heard, or
 - no sound is heard,enter ***** ***** (pre-selected remote fax activation code) **FIRMLY**.
- 3 Hang up the handset.
 - The main unit is activated for reception.

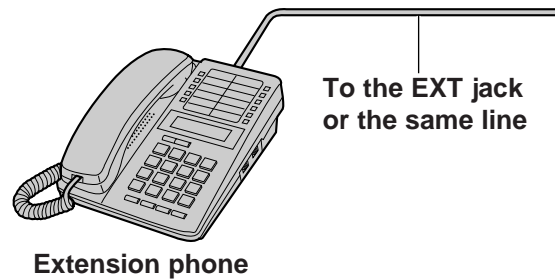

Changing the remote fax activation code

This code can be from 2 to 4 digits in length using numbers 0 through 9 and the character *.

- 1 Press **MENU**.
SYSTEM SET UP
- 2 Press **#**, then **4** **1**.
REMOTE FAX ACT.
- 3 Press **START/COPY/SET**.
MODE=ON [▲▼]
- 4 Press **▲** or **▼** to select the desired setting.
 - If this feature is not required, select "OFF".
- 5 Press **START/COPY/SET**.
CODE=**
- 6 Enter the new code number.
- 7 Press **START/COPY/SET**.
- 8 Press **MENU**.

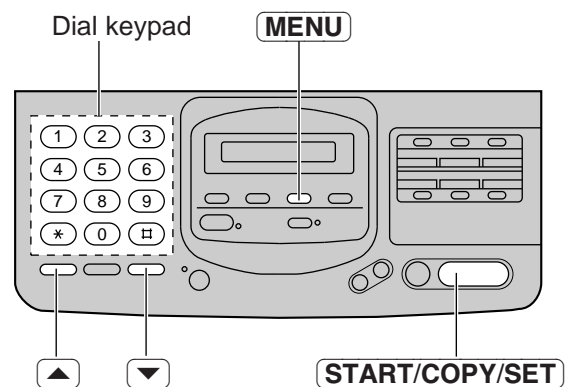

Note:

- Some special telephone company services will require you to press a service access code. If you subscribe to such services, whole or part of the remote fax activation code must be different from the service access code.
- If the remote fax activation code is set to "0000", the unit does not work properly.

Junk mail prohibitor

(preventing the reception of unwanted fax documents)

This feature prevents reception from facsimile machines whose phone numbers are not stored in automatic dialing.

Important:

- This feature does not work when:
 - the unit is set to the TEL mode,
 - manual reception is performed, or
 - the other party does not program their facsimile telephone number correctly.
- The junk mail prohibitor ID must be different from the first 2 digits of the remote TAM activation ID (page 48).
E.g. if the remote TAM activation ID is “321”, do not use “32” as a junk mail prohibitor ID.

Setting the junk mail prohibitor and the ID

- 1 Press **MENU**.
SYSTEM SET UP
- 2 Press **#**, then **2** **4**.
JUNK MAIL PROH.
- 3 Press **START/COPY/SET**.
MODE=OFF [▲▼]
- 4 Press **▲** or **▼** to select “ON”.
MODE=ON [▲▼]
 - If this feature is not required, select “OFF”.
- 5 Press **START/COPY/SET**.
ID=22
- 6 To change the junk mail prohibitor ID, enter the desired 2-digit number.
 - 0, #, and * cannot be used.
- 7 Press **START/COPY/SET**.
- 8 Press **MENU**.

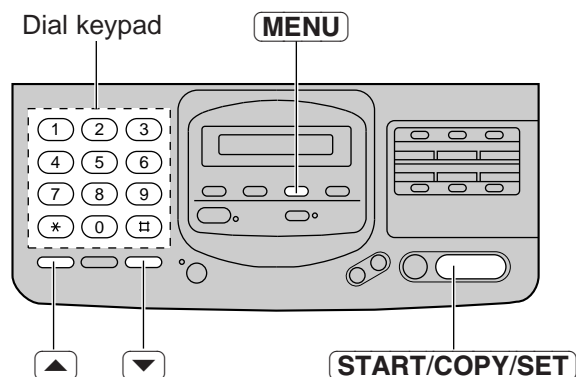

Transmitting documents to your unit with the prohibitor ID

Even if the junk mail prohibitor feature is activated, a designated caller will be able to transmit documents. Give your junk mail prohibitor ID to all of your designated callers, and advise them of the following steps. This operation is available in the AUTO RECEIVE mode (EXT.TAM only) or the MANUAL RECEIVE mode (TEL/FAX only).

1. Call your unit from a touch tone telephone.
2. Dial the prohibitor ID while the greeting message is playing or a different ring back tone is heard.
3. Listen for a fax tone, and start transmission.

Receiving with distinctive ring service

This feature can only be used by those who subscribe to a distinctive ring pattern service from their telephone company. For more information on the availability of this service, please contact your telephone company before setting this feature to ON.

The distinctive ring service gives you up to 3 phone numbers on a single telephone line, each having a different ringing pattern.

When you use one of the phone numbers as a facsimile number, program the ringing pattern assigned for fax into your unit. When the unit detects a call matching the selected distinctive ringing pattern, the unit will activate depending on the receive mode setting.

Setting the distinctive ringing pattern

Program the ring pattern assigned for fax. Ringing patterns that can be programmed are;

- A: Standard ring (one long ring)
- B: Double ring (two short rings)
- C: Triple ring (short-long-short rings)
- D: Other triple ring (short-short-long rings)
- OFF: Turns off the ring pattern detection feature (pre-selected setting)

1 Press **MENU**.

SYSTEM SET UP

2 Press **#**, then **3** **1**.

RING DETECTION

3 Press **START/COPY/SET**.

MODE=OFF [▲▼]

4 Press **▲** or **▼** to select the desired mode.

5 Press **START/COPY/SET**.

6 Press **MENU**.

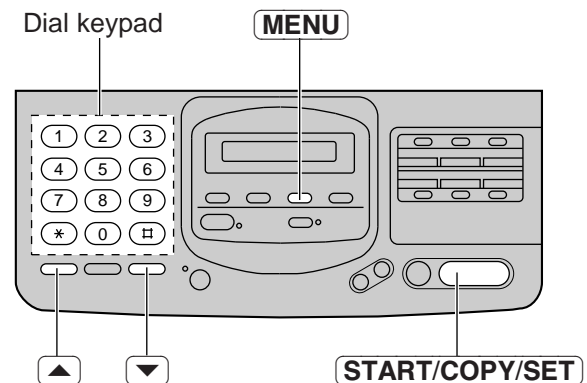

How the unit will answer in each receive mode

- **EXT.TAM mode:** When a distinctive ringing pattern that matches your selection is detected, the unit will automatically answer the line and activate the fax function to receive documents. If other ringing patterns are received, the unit and the answering machine will activate depending on the call.
- **TEL/FAX mode:** When a distinctive ringing pattern that matches your selection is detected, the unit will automatically answer the line and activate the fax function to receive documents. If other ringing patterns are received, the unit will ring until you pick up.
- **TEL mode:** In this mode, you have to answer all calls manually.
- **FAX mode:** In this mode, the unit will answer all calls and activate the fax function.

Note:

- The unit automatically answers a distinctive ring call after the second ring. To change the number of rings, change the FAX mode ring count (page 25) after setting the ringing pattern.

Signaling your pager that you have received a fax document

This feature allows your unit to call your pager automatically each time your unit receives a fax message.

1 Press **MENU**.

SYSTEM SET UP

2 Press **#**, then **7** **0**.

FAX PAGER

3 Press **START/COPY/SET**.

MODE=OFF [▲▼]

4 Press **▲** or **▼** to select "ON".

MODE=ON [▲▼]

•If this feature is not required, select "OFF".

5 Press **START/COPY/SET**.

NO. =

6 Enter your pager phone number.
If necessary, press **REDIAL/PAUSE** twice.
Contact your pager company regarding the proper pause time.

If your pager has the ability to display phone numbers, enter the number that you wish to appear on the display.

Press **#** if required by your pager company.

•You may enter a total of 46 digits and/or pauses.

7 Press **START/COPY/SET**.

8 Press **MENU**.

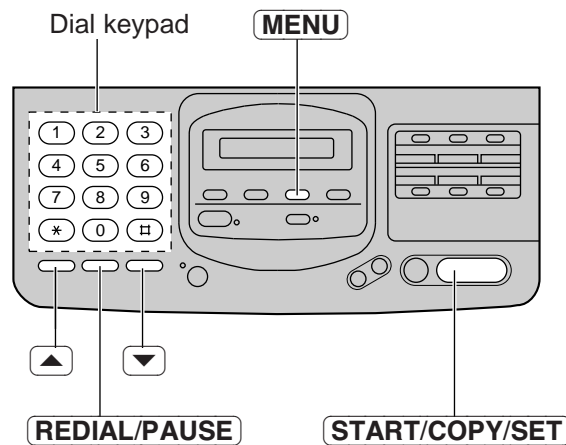

Setting the friendly reception

The friendly reception feature allows you to receive fax documents automatically without pressing **START/COPY/SET** or the ***** button twice if using the handset. See page 24 for further details. If you set this feature to OFF, you will have to press **START/COPY/SET** or the ***** button twice (if using the handset) to receive fax documents each time you answer a call.

- 1 Press **MENU**.
SYSTEM SET UP
- 2 Press **#**, then **4** **6**.
FRIENDLY RCV
- 3 Press **START/COPY/SET**.
MODE=ON [▲▼]
- 4 Press ▲ or ▼ to select the desired setting.
- 5 Press **START/COPY/SET**.
- 6 Press **MENU**.

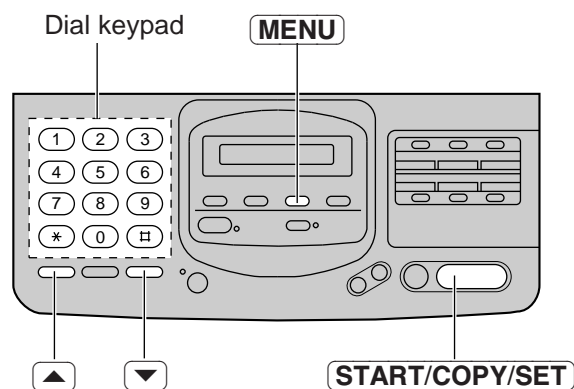

Using an external telephone answering machine

This unit can be connected to an external telephone answering machine (TAM). When the EXT.TAM mode is selected, incoming voice messages will be recorded on the telephone answering machine and fax messages will be received by the main unit.

Setting up the answering machine

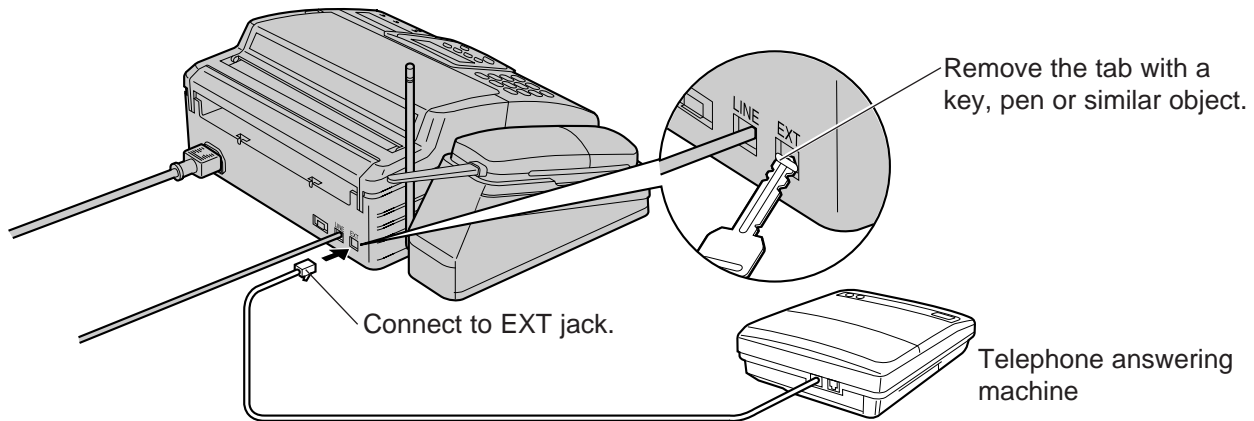

1. Connect the telephone answering machine to the EXT jack.
2. Set the number of rings on the telephone answering machine to less than 4.
3. Record a greeting message referring to the example below.
"This is (your name, business and/or telephone number). We are unable to answer the phone right now. Please leave a message after the long beep. To send a fax, dial my remote fax activation code and start transmission. Thank you."

Notice for recording a greeting message:

- Do not pause for more than 4 seconds in the message.
- Your message can be 8 to 16 seconds long. We recommend you to keep it around 10 seconds in length.
- Inform the fax caller of your remote fax activation code beforehand (see page 41).

Receiving voice and fax messages

To set the main unit and telephone answering machine to allow callers to leave a voice message and send a fax message, proceed as follows.

- 1 Turn on the answering machine.
- 2 Set the AUTO RECEIVE mode to EXT.TAM (see page 19).
- 3 Turn on the AUTO RECEIVE mode by pressing **AUTO RECEIVE** until the FAX indicator light goes on.
 - The display shows the following message.

EXT . TAM MODE

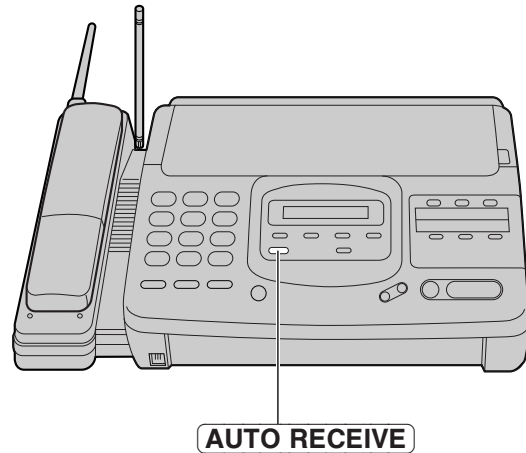

How to receive incoming calls in the EXT. TAM mode

When a call is received, the main unit and external telephone answering machine will work as follows.

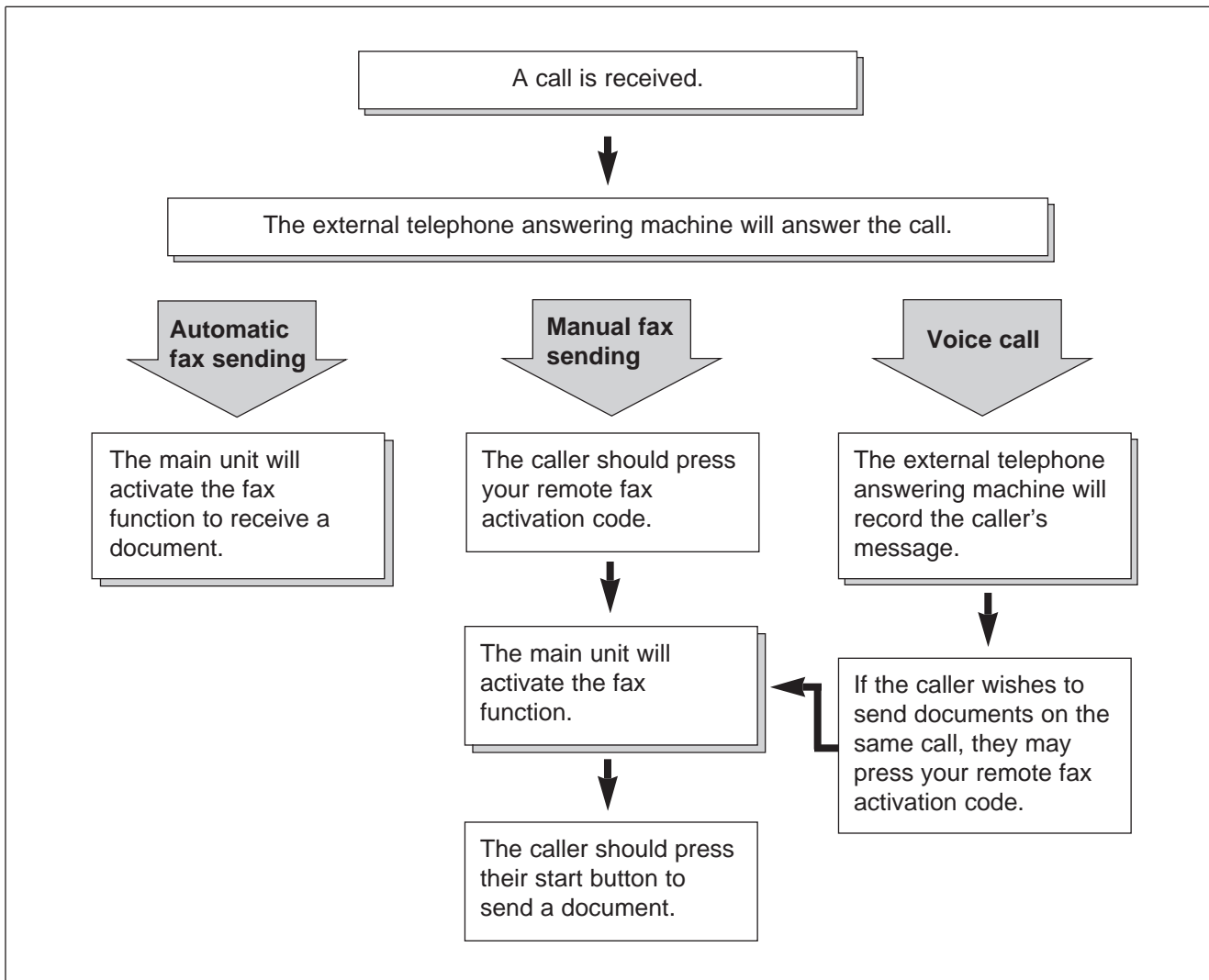

Setting the remote TAM activation ID

If your answering machine is equipped with a remote operation feature, set the same access code on the facsimile unit as programmed on the answering machine. This feature prevents the main unit from activating the fax function when you operate the answering machine from a remote location. This code can be from 1 to 5 digits in length.

Important:

- This code should be different from the remote fax activation code (see page 41) and the junk mail prohibitor ID (see page 42).

- 1 Press **MENU**.
SYSTEM SET UP
- 2 Press **#**, then press **1** **2**.
REMOTE TAM ACT.
- 3 Press **START/COPY/SET**.
MODE=OFF [▲▼]
- 4 Press **▲** or **▼** to select "ON".
MODE=ON [▲▼]
- 5 Press **START/COPY/SET**.
ID=11

- The display will show the pre-selected ID.

- 6 Enter the new ID number using the dial keypad.
- 7 Press **START/COPY/SET**.
- 8 Press **MENU**.

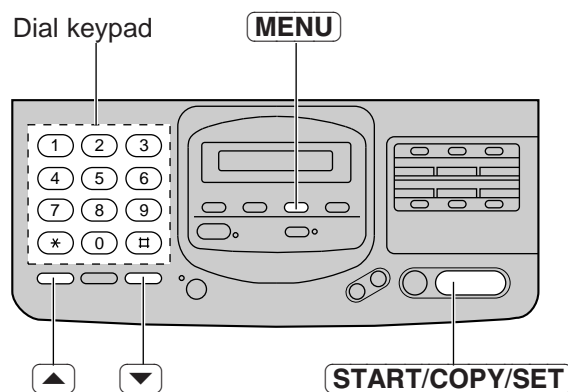

Setting the silent detection

This feature allows the main unit to activate the fax function automatically when a silent pause longer than 4 seconds is detected in the EXT.TAM mode.

Helpful hints:

- If you wish to receive documents from stations that do not send a calling tone after dialing, activate this feature.
- If you use a single cassette tape to give a greeting message and to record incoming messages, deactivate this feature.

- 1 Press **MENU**.
SYSTEM SET UP
- 2 Press **#**, then press **4** **0**.
SILENT DETECT.
- 3 Press **START/COPY/SET**.
MODE=ON [▲▼]
- 4 Press **▲** or **▼** to select the desired mode.
- 5 Press **START/COPY/SET**.
- 6 Press **MENU**.

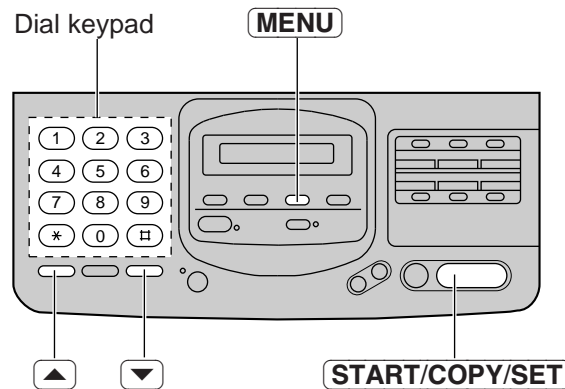

Notice when using with an answering machine

- When the main unit receives a document, a silent pause or a fax tone may be recorded on the answering machine.
- Advise callers that they should not pause for over 4 seconds while recording their voice messages. Otherwise, the unit may switch to the fax mode.
- When your answering machine runs out of recording tape, the unit may not be able to receive a document. Rewind the tape to record messages.
- When you set the answering machine to give only a greeting message, fax reception may not be available.
- If you answer a call with the answering machine and pause for over 4 seconds, the unit may switch to the fax mode and you may not be able to talk with the other party. To resume the conversation, press **STOP** on the main unit.
- When the answering machine does not answer a call after 5 rings, the fax function will be activated.
- Set the receive mode of the main unit to the TEL mode under the following conditions:
 - when you wish to set the number of rings on the answering machine to more than 5, or
 - when you wish to use the auto transfer functions (transfer, pager alert, etc.) on the answering machine.Note that automatic fax sending can not be received automatically in the TEL mode.

Changing the display contrast

Use this feature to adjust the brightness of the display.

NORMAL: (Pre-selected setting)

DARKER: Used when the display contrast is too light.

- 1 Press **MENU**.
SYSTEM SET UP
- 2 Press **#**, then **3** **9**.
LCD CONTRAST
- 3 Press **START/COPY/SET**.
MODE=NORMAL [▲▼]
- 4 Press ▲ or ▼ to select the desired setting.
- 5 Press **START/COPY/SET**.
- 6 Press **MENU**.

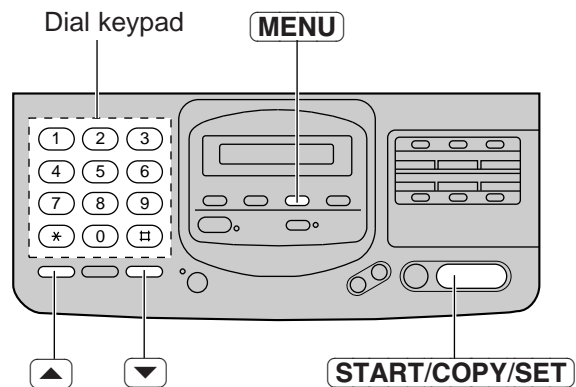

Resetting the advanced features

Use this feature to return the advanced features (see page 51) to their pre-selected settings.

- 1 Press **MENU**.
SYSTEM SET UP
- 2 Press **#**, then **8** **0**.
SET DEFAULT
- 3 Press **START/COPY/SET**.
RESET=NO [▲▼]
- 4 Press ▲ or ▼ to select "YES".
RESET=YES [▲▼]
- 5 Press **START/COPY/SET**.
RESET OK?
- If this feature is not required, press **STOP**.
- 6 Press **START/COPY/SET** again for confirmation.
RESET COMPLETED
- 7 Press **MENU**.

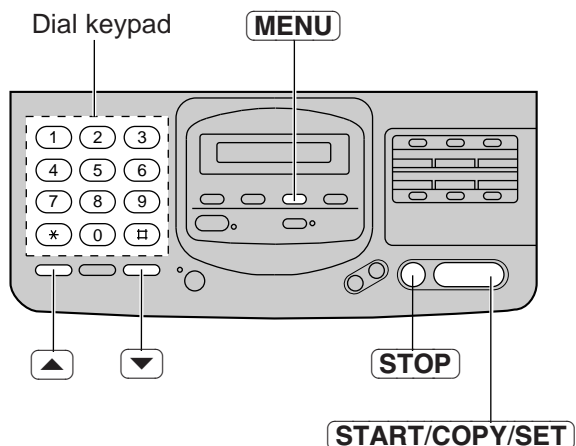

Summary of user programmable features =====

Basic features

Code	Feature	Selection	Initial setting	Page
#01	SET DATE & TIME	mm/dd/yy hh:mm		14
#02	YOUR LOGO			14
#03	YOUR TELEPHONE NUMBER			16
#04	PRINT TRANSMISSION REPORT	ERROR, ON, OFF	ERROR	53
#05	AUTO RECEIVE MODE	FAX, EXT. TAM	FAX	19
#07	FAX RING COUNT	1–4 rings	1 ring	25
#08	MANUAL RECEIVE MODE	TEL, TEL/FAX	TEL	19
#09	TEL/FAX DELAYED RING	1–4 rings	1 ring	27
#12	REMOTE TAM ACTIVATION	ON, OFF	OFF/ID=11	48

Advanced features

Code	Feature	Selection	Initial setting	Page
#21	LOGO POSITION	OUT, IN	OUT	40
#22	JOURNAL AUTO PRINT	ON, OFF	ON	53
#23	OVERSEAS MODE	ON, OFF	OFF	40
#24	JUNK MAIL PROHIBITOR	ON, OFF	OFF/ID=22	42
#25	DELAYED TRANSMISSION	ON, OFF	OFF	39
#30	SILENT FAX RECOGNITION RING	3–6 rings	3 rings	28
#31	RING DETECTION	OFF, A, B, C, D	OFF	43
#39	LCD CONTRAST	NORMAL, DARKER	NORMAL	50
#40	SILENT DETECTION	ON, OFF	ON	49
#41	REMOTE FAX ACTIVATION CODE	ON, OFF	ON/ID=**	41
#46	FRIENDLY RECEPTION	ON, OFF	ON	45
#70	FAX PAGER	ON, OFF	OFF	44
#80	SET DEFAULT	YES, NO	NO	50

Printing reports and lists

You can print out the following reports and lists from your unit.

Basic feature list—provides you with the current settings of the basic features (see page 51).

Advanced feature list—provides you with the current settings of the advanced features (see page 51).

Telephone number list—provides you with phone numbers and their station names which are stored in automatic dialing. Codes in the phone number show;

P: A pause has been entered.

F: A flash has been entered.

[]: A secret phone number has been entered. (The telephone number is not printed.)

Journal report—keeps records of fax transmissions and receptions. This report will be printed automatically after every 35 fax communications, but can be printed manually. You can change the setting of the journal auto print feature (see page 53).

Transmission report—provides you with a printed record of the fax transmission result (see pages 53 and 54).

How to print reports and lists

1 Press **MENU** until the following is displayed.

PRINT LIST

2 For the **basic feature list**, press **#**, then **1**.

BASIC LIST

For the **advanced list**, press **#**, then **2**.

ADVANCED LIST

For the **telephone number list**, press **#**, then **3**.

TEL NO. LIST

For the **journal report**, press **#**, then **4**.

JOURNAL REPORT

3 Press **START/COPY/SET** to start printing.

•To interrupt printing, press **STOP**.

4 After printing, press **MENU**.

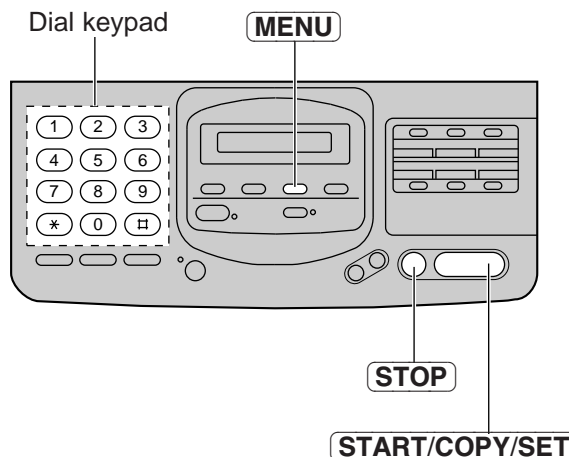



Setting the transmission report printing

One of the following choices is available.

ERROR: The transmission report will print out only when fax transmission fails (pre-selected setting).

ON: The report will always print out, indicating whether fax transmission is successful or not.

OFF: The report will not print.

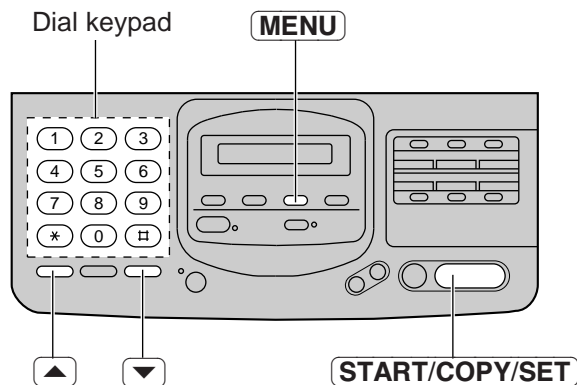

- 1 Press **MENU**.

- 2 Press **#**, then **0** **4**.

- 3 Press **START/COPY/SET**.

- 4 Press **▲** or **▼** to select the desired setting.
- 5 Press **START/COPY/SET**.
- 6 Press **MENU**.



Setting journal auto print

This unit will automatically print a journal report after every 35 fax communications. After printing, the journal memory will be erased and only subsequent activity will be recorded.

When this feature is OFF, the unit will store the records of the last 35 fax communications, but the unit will not print the journal report automatically.

- 1 Press **MENU**.

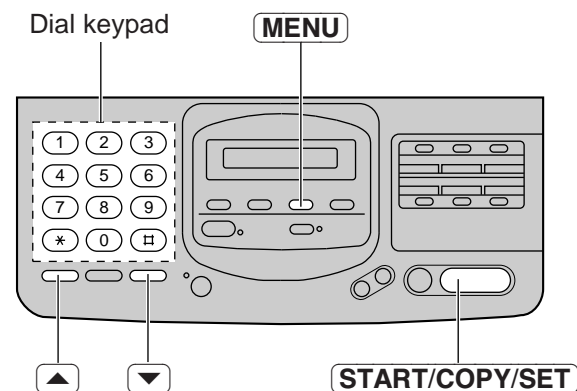
- 2 Press **#**, then **2** **2**.

- 3 Press **START/COPY/SET**.

- 4 Press **▲** or **▼** to select the desired setting.
- 5 Press **START/COPY/SET**.
- 6 Press **MENU**.



Sample of journal report

y JOURNAL z		JAN. 25 1996 05:22PM					
NO.	OTHER FACSIMILE	START TIME	USAGE TIME	MODE	PAGES	RESULT	*CODE
01	1234567	JAN. 21 02:14PM	00'25	TX	01	OK	
02	9998765	JAN. 21 02:17PM	00'38	TX	02	OK	
03	2121444	JAN. 21 02:18PM	00'28	RX	01	OK	
04	555556677	JAN. 22 10:35AM	00'58	TX	03	COMMUNICATION ERROR	(43)
05			01'50	TX	05	OK	
				RX	03	OK	

Sample of transmission report

y XMT REPORT z		JAN. 20 1996 01:19PM					
NO.	OTHER FACSIMILE	START TIME	USAGE TIME	MODE	PAGES	RESULT	*CODE
01	COMPANY ABC	JAN. 20 01:18PM	00'51	TX	00	COMMUNICATION ERROR	(43)

Communication result (see below.)

Error code (for service personnel use only)

Communication result on the report

When a problem has occurred, one of the following messages will be printed on the transmission and journal reports.

PRINTED MESSAGE	CODE	MEANING
COMMUNICATION ERROR	41-47 FF	A transmission or reception error occurred. Try again or check with the other party.
DOCUMENT JAMMED	—	The document is jammed. Remove the jammed document (see page 60).
JUNKMAIL PROH. REJECT	—	The junk mail prohibitor of your unit rejected fax reception (see page 42).
NO DOCUMENT	—	The document was not fed into the unit properly. Try again.
NO RESPONSE	—	The receiving unit was busy or ran out of recording paper. Try again.
PAPER JAMMED	—	The recording paper is jammed. Clear the jammed paper (see page 59).
PAPER OUT	—	The unit ran out of recording paper. Install a recording paper (see page 10).
PRESSED THE STOP KEY	—	The STOP button was pressed, and fax communication was canceled.
PRINTER OVERHEATED	—	Printer was overheated. Let the unit cool down.
THE COVER WAS OPENED	—	The back lid was open. Close it and try again.
OK	—	Fax communication was successful.

Error messages on the display

If the unit detects a problem, the following messages will appear on the display.

DISPLAY MESSAGE	CAUSE AND REMEDY
CALL SERVICE	<ul style="list-style-type: none"> There is something wrong with the unit. Contact our service personnel (see page 66).
CHECK COVER	<ul style="list-style-type: none"> The back lid is open. Close it.
CHECK DOCUMENT	<ul style="list-style-type: none"> The document is not fed into the unit properly. Reinsert the document. If the misfeeding occurs frequently, clean the document feeder rollers inside the unit (see page 63). If the problem remains, adjust the feeder pressure (see page 60).
CHECK MEMORY	<ul style="list-style-type: none"> Memory (phone numbers, parameters, etc.) has been erased. Re-program.
NO RESPONSE	<ul style="list-style-type: none"> The receiving unit is busy or ran out of recording paper. Try again.
OUT OF PAPER	<ul style="list-style-type: none"> The unit ran out of recording paper. Install a new recording paper (see page 10).
PAPER JAMMED	<ul style="list-style-type: none"> A recording paper jam occurred. Clear the jammed paper (see page 59).
POLLING ERROR	<ul style="list-style-type: none"> The other fax machine does not provide the polling function. Check with the other party.
REDIAL TIME OUT	<ul style="list-style-type: none"> The receiving unit is busy or ran out of recording paper. Try again.
REMOVE DOCUMENT	<ul style="list-style-type: none"> The document is jammed. Remove the jammed document (see page 60). Attempted to transmit a document longer than 600 mm (23⁵/₈"). Press the STOP button and remove the document (see page 60). Divide the document into two or more sheets and try again.
TRANSMIT ERROR	<ul style="list-style-type: none"> A transmission error occurred. Try again.
UNIT OVERHEATED	<ul style="list-style-type: none"> The unit is too hot. Let the unit cool down.

Before requesting help

General

PROBLEM	CAUSE & REMEDY
I cannot make and receive calls.	<ul style="list-style-type: none"> •The power cord or telephone line cord is not connected. Check the connections (see page 12).
I cannot make calls.	<ul style="list-style-type: none"> •The dialing mode setting is wrong. Check the selector (see page 12).
The main unit does not work.	<ul style="list-style-type: none"> •Disconnect the unit from the telephone line and connect to a known working phone. If the working phone operates properly, call your service center to have the unit repaired. If the working phone does not operate properly, contact your telephone company.
The handset does not work.	<ul style="list-style-type: none"> •Check the setting (see pages 11 and 13). •Charge the battery fully (see page 13). •Clean the charge contacts and charge again (see page 63).
The main unit does not ring.	<ul style="list-style-type: none"> •The ringer volume is set to OFF. Press VOLUME (^) when the main unit is idle.
The handset does not ring.	<ul style="list-style-type: none"> •The ringer volume is set to OFF. Press VOLUME/RINGER when the TALK/BATT LOW indicator light is off.
The REDIAL/PAUSE button does not function properly.	<ul style="list-style-type: none"> •If this button is pressed during dialing, a pause will be inserted. If this button is pressed immediately after obtaining a dial tone, the last number dialed will be redialed.
During programming, I cannot enter the activation code or the prohibitor ID.	<ul style="list-style-type: none"> •Whole or part of the number is the same as another code or ID. Change the number (see pages 41, 42 and 48).
An alarm tone sounds when you press TALK or INTERCOM .	<ul style="list-style-type: none"> •You are too far from the main unit. Move closer and try again. •Place the handset on the main unit and try again. •The power cord is disconnected. Plug in the power cord.
An alarm tone sounds continuously while using the handset.	<ul style="list-style-type: none"> •Move closer to the main unit quickly, or the call will be terminated within 60 seconds. •The power cord is disconnected. Plug in the power cord.
Static, sound cuts in/out, fades. Interference from other electrical units.	<ul style="list-style-type: none"> •Set the handset and the main unit away from electrical appliances. •Move closer to the main unit. •Raise the main unit antenna. •Press CH to change the channel.
The unit stops working during operation.	<ul style="list-style-type: none"> •Place the handset on the main unit and disconnect the power cord to reset. Connect the power cord, then try again.
You cannot store a phone number in memory.	<ul style="list-style-type: none"> •You cannot store a number while the unit is in the talk, speakerphone or intercom mode. •Do not pause for over 30 seconds while storing.
While storing a phone number, the unit starts to ring.	<ul style="list-style-type: none"> •To answer a call, press TALK or SP-PHONE. The program will be canceled; store the number again.

PROBLEM	CAUSE & REMEDY
LOCATOR/INTERCOM does not function.	<ul style="list-style-type: none"> ●The handset is too far from the main unit or is engaged in an outside call.
The TALK/BATT LOW indicator flashes slowly or the unit beeps intermittently.	<ul style="list-style-type: none"> ●Charge the battery fully or replace with a fully charged optional spare battery (p. 13, 62).
You charged the battery fully, but the TALK/BATT LOW indicator flashes slowly.	<ul style="list-style-type: none"> ●Clean the charge contacts and charge again. ●It is time to replace the battery. Please purchase a new battery (p. 61).
The CHARGE indicator and/or the SPARE CHARGE indicator light never goes out while charging.	<ul style="list-style-type: none"> ●This is normal.

Fax Transmission

PROBLEM	CAUSE & REMEDY
The other party complains that letters on their received document are distorted.	<ul style="list-style-type: none"> ●If your line has special telephone services such as call waiting, the service may have been activated during fax transmission. Connect the unit to a line that does not have such services. ●An extension telephone on the same line is off the hook. Hang up and try again.
The other party complains that dirty patterns or black lines appear on their received documents.	<ul style="list-style-type: none"> ●The glass or rollers are dirty. Clean them (see page 63).
I cannot make an international fax call.	<ul style="list-style-type: none"> ●Use the overseas transmission mode (see page 40). ●Add two pauses at the end of the phone number (see page 37).

Fax Reception

PROBLEM	CAUSE & REMEDY
I cannot receive documents automatically.	<ul style="list-style-type: none"> ●The receive mode is set to the TEL mode. Set to the EXT. TAM, TEL/FAX or FAX mode. ●The time to answer the call may be too long. Decrease the number of rings (see pages 25 and 27). ●The junk mail prohibitor is set to on (see page 42).
The recording image is faint.	<ul style="list-style-type: none"> ●The sender transmitted a faint document. Request them to transmit a clearer copy of the document.
The received document is blank.	<ul style="list-style-type: none"> ●The recording paper roll is installed incorrectly. Make sure that the shiny side of the paper is facing down and re-install the paper (see page 10).

Operation in EXT. TAM mode

PROBLEM	CAUSE & REMEDY
I cannot receive documents automatically.	<ul style="list-style-type: none"> •Your greeting message is too long. Shorten it (up to 10 seconds). •There are too many rings on the answering machine. Set the number of rings to less than 4. •The silent detection feature is deactivated. Activate this feature (see page 49).
I cannot receive voice messages.	<ul style="list-style-type: none"> •Check that the answering machine is turned on and connected to the facsimile unit properly (see page 46). •Set the number of rings on the answering machine to less than 4.
I cannot retrieve voice messages on the answering machine from a remote location.	<ul style="list-style-type: none"> •The remote access code on your answering machine is the same as the remote fax activation code or the junk mail prohibitor ID on the facsimile unit. Set a different number for each code/ID. •Your remote TAM activation code is not programmed correctly. Program the same code as on the answering machine (see page 48).
The greeting message on your answering machine is interrupted halfway and the caller cannot leave a voice message.	<ul style="list-style-type: none"> •Silent pause in the greeting message is too long. Shorten it to less than 4 seconds.
I pressed the remote access code to access the answering machine remotely, but the line was disconnected.	<ul style="list-style-type: none"> •The code may include “#” which is used for certain features provided by the telephone company. Change the code on the answering machine not to include “#”. Then program the same code into the facsimile unit (see page 48).

Copying

PROBLEM	CAUSE & REMEDY
A dirty pattern or a black line appears on the copied documents.	<ul style="list-style-type: none"> •The glass or rollers are dirty. Clean them (see page 63).
The copied document is blank.	<ul style="list-style-type: none"> •The recording paper roll is installed incorrectly. Make sure that the shiny side of the paper is facing down and re-install the paper (see page 10).

If a power failure occurs

- This unit does not function during a power failure.
- The memory contents will not be erased.
- If the programmed start time has passed during a power failure, delayed transmission will be attempted after power is restored.

Clearing a recording paper jam

If the unit does not eject any recording paper during reception or copying, the recording paper has jammed. Remove the jammed paper as shown below.

- 1**
 - Open the back lid by lifting up the tabs located on both sides.
 - Press the green lever to release the paper cutter.

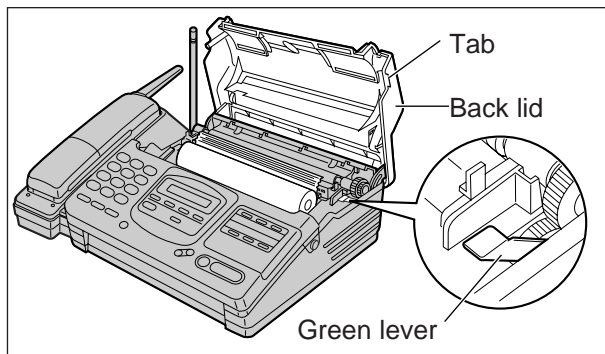

- 2** Pull up the transparent guide and remove the piece of paper.
 - If the transparent guide is not pulled up, press the green lever again.

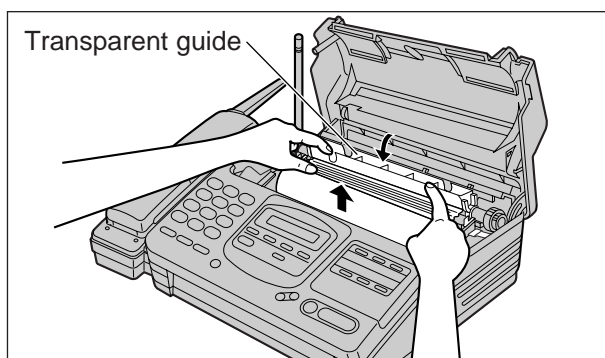

- 3** Replace the transparent guide and recording paper roll in the proper direction, and insert the leading edge of the paper between the recording paper roller and the silver plate.
 - Make sure that there is no slack in the paper roll.

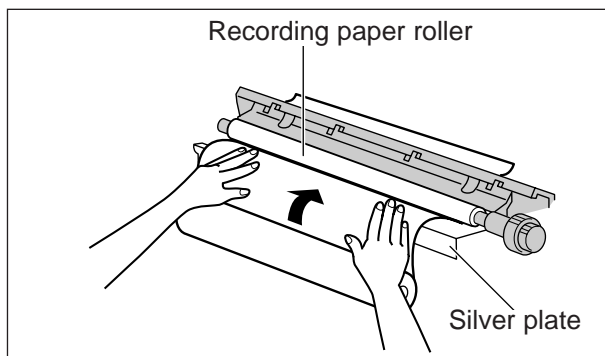

- 4** Close the back lid by gently pressing down on both ends.

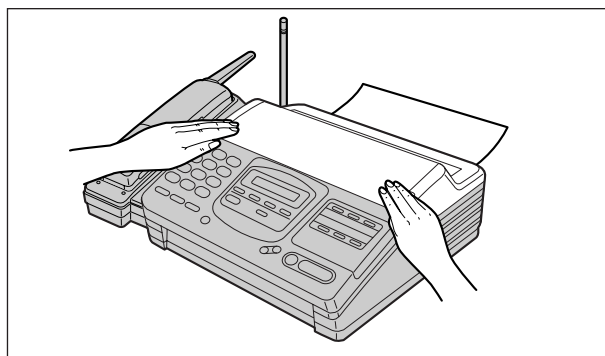

Clearing a document jam

If the unit does not release an original document during feeding, remove it as shown below.

- 1** Open the front lid by pressing the front lid open button.
- 2** Remove the jammed document.
- 3** Close the front lid by gently pressing down on both ends.

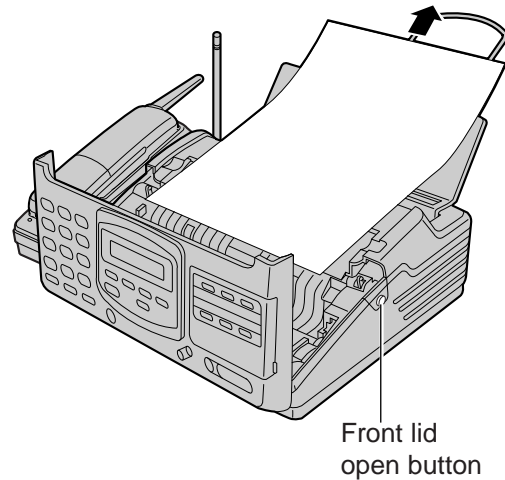

Adjusting the feeder pressure

When no feeding or multiple feeding of documents occurs frequently, adjust the feeder pressure.

- 1** Open the front lid by pressing the front lid open button.
- 2** Shift the position of the lever by using an instrument with a pointed end, like a clip or ball-point pen.

Position A: Select this when documents do not feed.
Position B: Standard position (pre-selected)
Position C: Select this when documents multiple feed.
- 3** Close the front lid by gently pressing down on both ends.

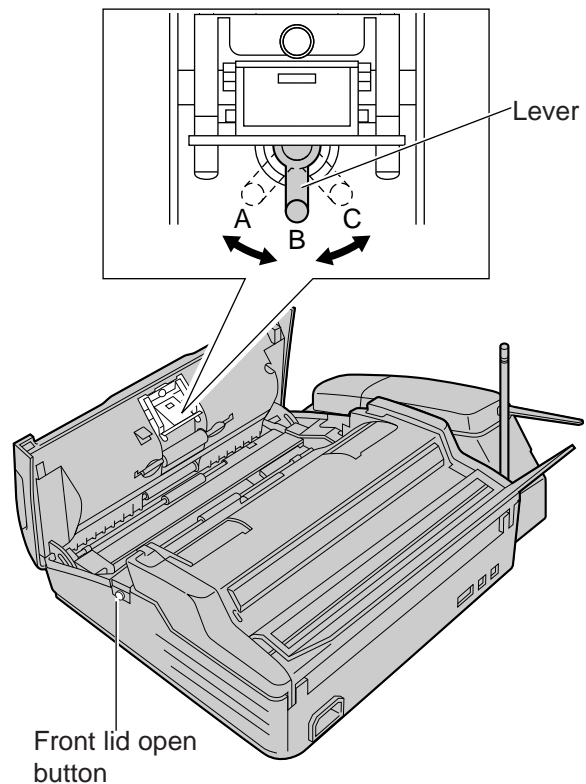

Optional spare battery

When the handset battery needs charging, replace it with a fully charged optional spare battery. This eliminates having to wait for the handset battery to recharge. Please purchase a Panasonic P-P592 (KX-A92) battery and install it in the main unit to charge. To order, call toll free 1-800-332-5368.

Installing the spare battery in the main unit

- 1 Open the spare battery cover by pushing the tab and lifting the cover.

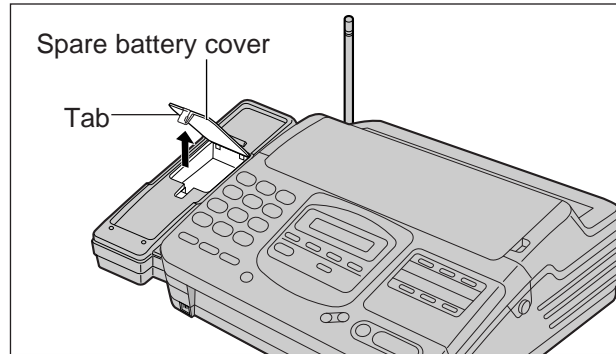

- 2 Install the spare battery as shown observing the proper polarity, then close the spare battery cover.
 - The SPARE CHARGE indicator lights.

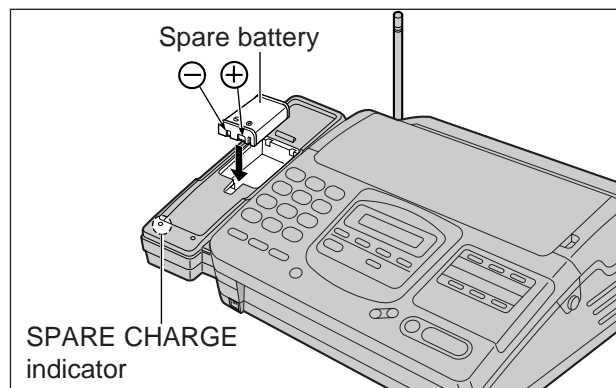

The spare battery is always being charged in the main unit while the power cord is connected. The battery cannot be overcharged.

Attention:

The product you have purchased is powered by a nickel cadmium battery which is recyclable. At the end of its useful life, under various state and local laws, it is illegal to dispose of this battery into your municipal waste stream. Please call 1-800-8-BATTERY for information on how to recycle this battery.



Replacing the handset battery with the spare battery

To prevent memory loss, replace within 5 minutes.

- 1 Remove the battery cover.

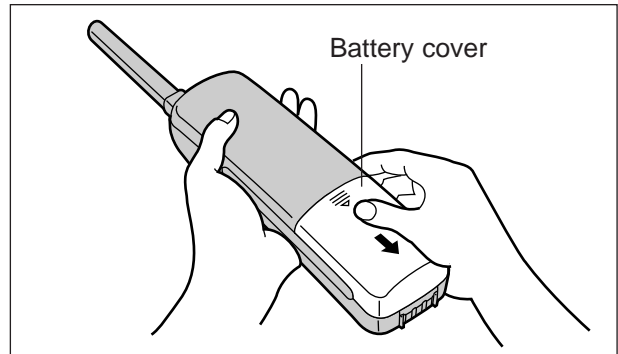

- 2 Remove the battery.

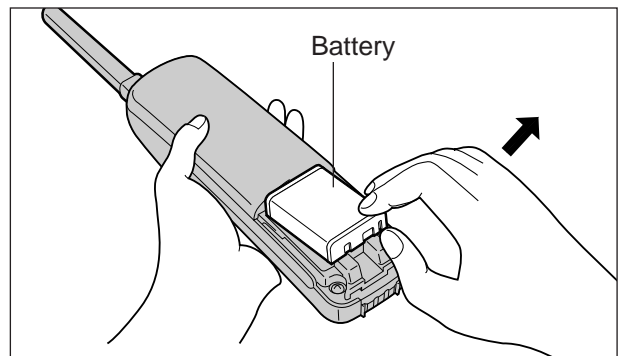

- 3 Replace the handset battery with the spare battery in the main unit.
 - A Remove the spare battery.
 - B Insert the handset battery in the main unit observing the proper polarity.

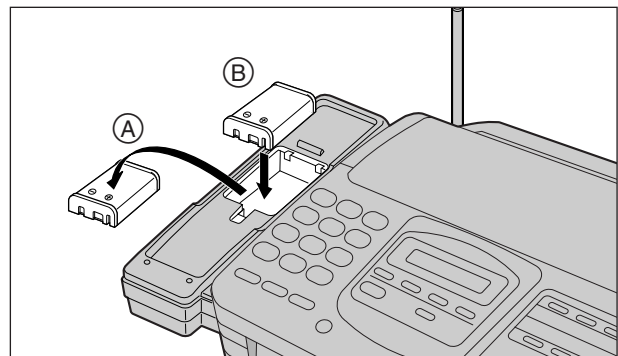

- 4 Install the spare battery in the handset observing the proper polarity. When finished, replace the battery cover.

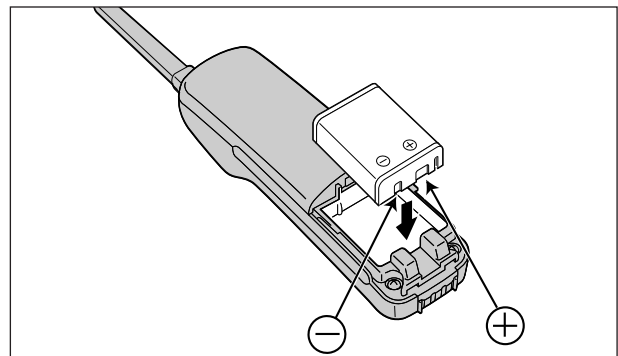

Note:

- If the TALK/BATT LOW indicator flashes slowly even when the handset battery has been fully charged, it is time to replace the battery with a new one. Remember to fully charge the new battery after battery replacement.
- Please use only a Panasonic P-P592 (KX-A92) battery. To order, call toll free 1-800-332-5368.

Cleaning the unit

Cleaning the inside of the unit

If misfeeding occurs frequently, or dirty patterns or black bands appear on a copied or transmitted document, clean the document feeder rollers, sub roller, rubber flap, white plate and glass.

- 1** Disconnect the power cord and the telephone line cord.
- 2** Open the front lid by pressing the front lid open button.
- 3** Clean the document feeder rollers and sub roller with a cloth moistened with isopropyl rubbing alcohol, and let dry thoroughly.
- 4** Clean the rubber flap with a cotton swab moistened with isopropyl rubbing alcohol, and let dry thoroughly.
- 5** Clean the white plate and glass with a soft dry cloth.
- 6** Close the front lid by gently pressing down on both ends.
- 7** Connect the power cord and the telephone line cord.

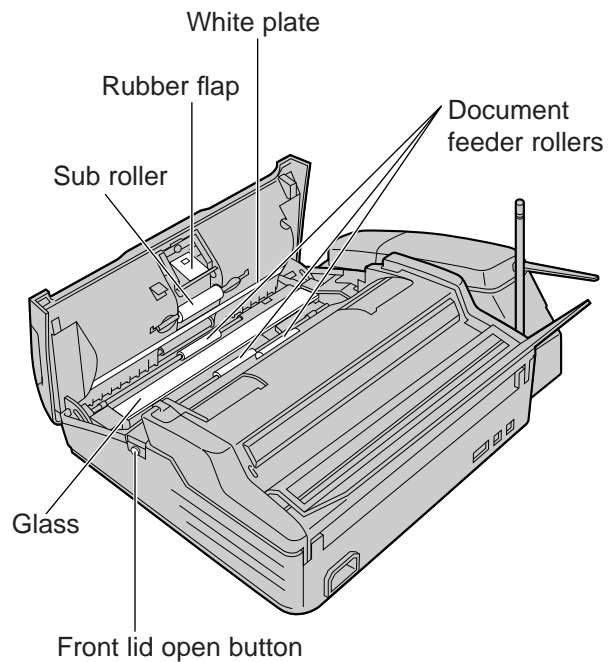

Caution:

- Do not use paper products (such as paper towels or tissues) to clean the inside of the unit.

Cleaning the charge contacts

Clean the main unit and the handset charge contacts with a dry soft cloth once a month, or the battery may not charge properly.

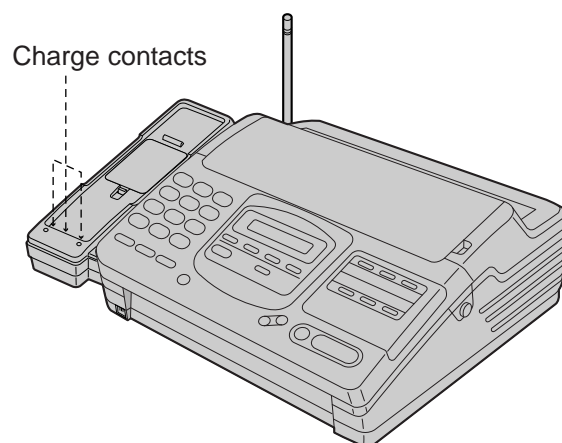
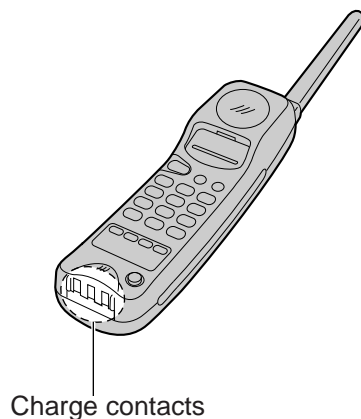

FCC information

If required by the telephone company, inform them of the following.

- FCC Registration No.:
(found on the bottom of the unit)
- Ringer Equivalence No.:
(found on the bottom of the unit)
- The particular telephone line to which the equipment is connected.

This unit must not be connected to a coin operated line. If you are on a party line, check with your local telephone company.

Ringer Equivalence Number (REN):

This REN is useful in determining the quantity of devices you may connect to your telephone line and still have all of those devices ring when your telephone number is called. In most but not all areas, the sum of the REN's of all devices connected to one line should not exceed five (5.0). To be certain of the number of devices you may connect to your line, as determined by the REN, you should contact your local telephone company to determine the maximum REN for your calling area.

In the event that terminal equipment causes harm to the telephone network, the telephone company should notify the customer, if possible, that service may be stopped. However, where prior notice is impractical, the company may temporarily cease service providing that they:

- a) Promptly notify the customer.
- b) Give the customer an opportunity to correct the problem with their equipment.
- c) Inform the customer of the right to bring a complaint to the Federal Communication Commission pursuant to procedures set out in FCC Rules and Regulations Subpart E of Part 68.

The Telephone Company may make changes in its communications facilities, equipment operations, or procedures where such action is reasonably required in the operation of its business and is not inconsistent with the rules and regulations in FCC Part 68. If such changes can be reasonably expected to render any customer terminal equipment incompatible with telephone company communications facilities, or require modification or

alteration of such terminal equipment, or otherwise materially affect its use or performance, the customer shall be given adequate notice in writing, to allow the customer an opportunity to maintain uninterrupted service.

CAUTION:

Any changes or modifications not expressly approved by the party responsible for compliance could void the user's authority to operate this device.

When programming emergency numbers and/or making test calls to emergency numbers:

1. Remain on the line and briefly explain to the dispatcher the reason for the call before hanging up.
2. Perform such activities in the off-peak hours; such as early morning or late evenings.

This telephone provides magnetic coupling to hearing aids.

NOTE:

This equipment has been tested and found to comply with the limits for a Class B digital device, pursuant to Part 15 of the FCC Rules. These limits are designed to provide reasonable protection against harmful interference in a residential installation. This equipment generates, uses, and can radiate radio frequency energy and, if not installed and used in accordance with the instructions, may cause harmful interference to radio communications. However, there is no guarantee that interference will not occur in a particular installation. If this equipment does cause harmful interference to radio or television reception, which can be determined by turning the equipment off and on, the user is encouraged to try to correct the interference by one or more of the following measures:

- Reorient or relocate the receiving antenna.
- Increase the separation between the equipment and receiver.
- Connect the equipment into an outlet on a circuit different from that to which the receiver is connected.
- Consult the dealer or an experienced radio/TV technician for help.

Matsushita Consumer Electronics Company,
Division of Matsushita Electric Corporation of America
One Panasonic Way, Secaucus,
New Jersey 07094

Panasonic Sales Company
Division of Matsushita Electric of
Puerto Rico, Inc.
Ave. 65 de Infantería, Km. 9.5, San Gabriel
Industrial Park, Carolina, Puerto Rico 00985

PANASONIC

Facsimile Products

Limited Warranty

Matsushita Consumer Electronics Company or Panasonic Sales Company (collectively referred to as "the warrantor"), will repair this product with new or refurbished parts, free of charge, in the USA or Puerto Rico for one (1) year from the date of original purchase in the event of a defect in materials or workmanship.

This Limited Warranty Excludes both Labor and Parts for: batteries, antennas, and cosmetic parts (cabinet).

Carry-in or mail-in service in the USA or Puerto Rico can be obtained during the warranty period by contacting a Matsushita Services Company (MSC) Factory Servicenter listed in the Servicenter Directory. Or call, toll free, 1-800-HELP FAX (1-800-435-7329) to locate a MSC Factory Servicenter. Carry-in or mail-in service in Puerto Rico can be obtained during the warranty period by calling the Panasonic Sales Company telephone number listed in the Servicenter Directory.

This warranty is extended only to the original purchaser. A purchase receipt or other proof of date of original purchase will be required before warranty service is rendered.

This warranty only covers failures due to defects in material and workmanship which occur during normal use and (when applicable) does not cover the print and ink cartridge, the toner cartridge and drum unit or the film cartridge. The warranty does not cover damages which occurred in shipment, or failures which are caused by products not supplied by the warrantor, or failures which result from accident, misuse, abuse, neglect, mishandling, faulty installation, misapplication, set-up adjustments, improper operation or maintenance, alteration, modification, line power surge, improper voltage supply, lightning damage, signal reception problems, commercial use such as hotel, office, restaurant, or other business or rental use of the product, or serviced by anyone other than a MSC Factory Servicenter or a MSC authorized Servicenter, or damage that is attributable to acts of God.

LIMITS AND EXCLUSIONS

There are no express warranties except as listed above.

THE WARRANTOR SHALL NOT BE LIABLE FOR INCIDENTAL OR CONSEQUENTIAL DAMAGES RESULTING FROM THE USE OF THIS PRODUCT, OR ARISING OUT OF ANY BREACH OF THIS WARRANTY. ALL EXPRESS AND IMPLIED WARRANTIES, INCLUDING THE WARRANTIES OF MERCHANTABILITY, ARE LIMITED TO THE APPLICABLE WARRANTY PERIOD SET FORTH ABOVE.

Some states do not allow the exclusion or limitation of incidental or consequential damages, or limitations on how long an implied warranty lasts, so the above exclusions or limitations may not apply to you.

This warranty gives you specific legal rights and you may also have other rights which vary from state to state. If a problem with this product develops during or after the warranty period, you may contact your dealer or Servicenter. If the problem is not handled to your satisfaction, then write to the Customer Satisfaction Center at the company address indicated above.

Service center directory

OPERATION ASSISTANCE • FAX ADVANTAGE PROGRAM

DIAL TOLL FREE: 1-800-HELP-FAX (1-800-435-7329) (9:00am–8:00pm Monday–Friday, EST)

PRODUCT INFORMATION • LITERATURE REQUESTS • DEALER LOCATIONS

Customer Satisfaction Center 2F-3, One Panasonic Way, Secaucus, NJ 07094 (Headquarters)
201-348-9090 (9:00am–8:00pm Monday–Friday, EST)

ACCESSORY PURCHASES

1-800-332-5368 (Consumer orders only)

Matsushita Services Company Accessory Order Office, 20421-84th Avenue South Kent, WA 98032
(6:00am–6:00pm Monday–Friday, 6:00am–10:30am Saturday, PST)
(Visa, Mastercard, Discover card, American Express, Check)

AUTHORIZED SERVICENTERS

CALIFORNIA

6550 Katella Avenue
Cypress, CA 90630
Phone (714) 373-7425
Fax (714) 894-8534

800 Dubuque Avenue
S. San Francisco,
CA 94080
Phone (415) 871-6373
Fax (415) 871-6840

20201 Sherman Way
Suite 102
Canoga Park, CA 91306
Phone (818) 709-1775
Fax (818) 709-2165

3878 Ruffin Road
Suite A
San Diego, CA 92123
Phone (619) 560-9200
Fax (619) 560-1831

COLORADO

1640 South Abilene Suite D
Aurora, CO 80012
Phone (303) 752-2024
Fax (303) 752-0610

FLORIDA

3700 North 29th Avenue
Suite 102
Hollywood, FL 33020
Phone (954) 925-2880
Fax (954) 925-5224

4710 Eisenhower
Boulevard Suite A1
Tampa, FL 33634
Phone (813) 884-4746
Fax (813) 886-4564

GEORGIA

8655 Rosewell Road
Suite 100
Atlanta, GA 30350
Phone (770) 518-6301
Fax (770) 518-6306

HAWAII

99-859 Iwaiwa Street
Aiea, Hawaii 96701
Phone (808) 488-1996
Fax (808) 486-4369

ILLINOIS

*1703 North Randall Road
Elgin, IL 60123
"12:30 to 4:30, Mon-Fri"
Phone (847) 468-5464
Fax (847) 468-5465

9060 Golf Road
Niles, IL 60714
Phone (847) 608-1010
Fax (847) 299-1710

MARYLAND

Sulphur Springs
Business Park
1638 Sulphur Springs Road
Baltimore, MD 21227
Phone (410) 242-2607
Fax (410) 247-3047

MASSACHUSETTS

60 Glacier Drive, Suite G
Westwood, MA 02090
Phone (617) 329-4280
Fax (617) 329-0586

*pick-up/drop-off only

MICHIGAN

37048 Van Dyke Avenue
Sterling Heights, MI 48312
Phone (810) 939-2060
Fax (810) 939-2638

MINNESOTA

7850-12th Avenue South
Airport Business Center
Bloomington, MN 55425
Phone (612) 854-8624
Fax (612) 854-2089

OHIO

2236 Waycross Road
Cincinnati, OH 45240
Phone (513) 851-4180
Fax (513) 851-8443

PENNSYLVANIA

2221 Cabot Boulevard West
Suite B
Langhorne, PA 19047
Phone (215) 741-0661
Fax (215) 741-0521

Chartiers Valley
Shopping Center
1025 Washington Pike
Bridgeville, PA 15017
Phone (412) 257-4522
Fax (412) 257-4650

TENNESSEE

919-8th Avenue South
Nashville, TN 37203
Phone (615) 244-4434
Fax (615) 244-6713

TEXAS

7482 Harwin Drive
Houston, TX 77036
Phone (713) 781-1528
Fax (713) 781-0643

13615 Welch Road Suite 101
Farmers Branch, TX 75244
Phone (214) 385-1975
Fax (214) 960-7626

WASHINGTON

20425-84th Avenue South
Kent, WA 98032
Phone (206) 872-7922
Fax (206) 872-0918

Service in Puerto Rico

**Matsushita Electric
of Puerto Rico, Inc.
Panasonic Sales Company/
Factory Servicenter**

Ave. 65 de Infantería, Km. 9.5
San Gabriel Industrial Park
Carolina, Puerto Rico 00985
Phone (809) 750-4300
Fax (809) 768-2910

REPAIR INQUIRIES

Regional Customer Care Department

EAST (PCE)

2221 Cabot Boulevard West
Suite A
Langhorne, PA 19047
Phone (215) 741-0676
Fax (215) 750-6492

Covers:

CT, DE, ME, MD, MA, NH, NJ,
NY, PA, RI, VT, VA, DC, WV

EAST (PCE)

1225 Northbrook Parkway
Suite 2-390
Suwannee, GA 30174
Phone (404) 338-6860
Fax (404) 338-6548

Covers:

AL, FL, GA, MS, NC, SC, TN

CENTRAL (PCC)

1707 North Randall Road
Elgin, IL 60123
Phone (847) 468-5530
Fax (847) 468-5528

Covers:

AR, IL, IN, IA, KS, KY, LA, MI,
MN, MO, NE, ND, OK, SD, TX,
WI, OH

WEST (PCW)

6550 Katella Avenue
Cypress, CA 90630
Phone (714) 373-7440
Fax (714) 373-7447

Covers:

AK, AZ, CA, CO, ID, MT, NV,
NM, OR, UT, WA, WY, HI

PARTS DISTRIBUTION LOCATIONS

To locate parts distributors in your area (within the USA)
DIAL TOLL FREE 1-800-545-2672 (24 hours a day, 7 days a week)

(960607)

Information for users

For product service

- Service centers are listed on page 66.
- Call toll free 1-800-545-2672 for the location of an authorized service center.

When you ship the product

- Carefully pack your unit, preferably in the original carton.
- Attach a letter, detailing the symptom or problem, to the outside of the carton.
- Send the unit to an authorized service center, prepaid and adequately insured.
- Do not send your unit to the Matsushita Consumer Electronics Company or to any executive or regional sales offices. These locations do not repair consumer products.

Accessory order information

Use the following types of recording paper for replacement. For accessory order, call toll free 1-800-332-5368.

Model No.	Description	Comment
KX-A106	Standard Thermal Recording Paper	216 mm×30 m (8½"×98') roll, with 25 mm (1") core
KX-A116	Standard Thermal Recording Paper	216 mm×50 m (8½"×164') roll, with 25 mm (1") core
KX-A125	Super Thermal Recording Paper (Like plain paper)	216 mm×30 m (8½"×98') roll, with 25 mm (1") core

Specifications

■ Main unit

- 1. Applicable Lines:** Public Switched Telephone Network
- 2. Document Size:** Max. 216 mm (8½") in width
Max. 600 mm (23⅝") in length
- 3. Effective Scanning Width:** 208 mm (8⅜")
- 4. Printing Paper Size:** 216 mm × max. 50 m (8½" × 164') roll
- 5. Effective Printing Width:** 208 mm (8⅜")
- 6. Transmission Time*:** Approx. 15 s/page (Original mode)
Approx. 30 s/page (G3 Normal mode)
- 7. Scanning Density:** Horizontal: 8 pels/mm (203 pels/inch)
Vertical: 3.85 lines/mm (98 lines/inch)—Standard mode
7.7 lines/mm (196 lines/inch)—Fine/Halftone mode
15.4 lines/mm (392 lines/inch)—Superfine mode
- 8. Halftone Level:** 64-level
- 9. Scanner Type:** CCD image sensor
- 10. Printer Type:** Thermal printing
- 11. Data Compression System:** Modified Huffman (MH), Modified READ (MR)
- 12. Modem Speed:** 9600/7200/4800/2400 bps; Automatic Fallback
- 13. Operating Environment:** 5–35 °C (41–95 °F), 45–85 % RH (Relative Humidity)
- 14. Dimensions (H×W×D):** Approx. 118×366×265 mm (4²¹/₃₂" × 14³/₈" × 10⁷/₁₆"
- 15. Mass (Weight):** Approx. 3.4 kg (7.5 lb.)
- 16. Power Consumption:** Standby: Approx. 5 W
Transmission: Approx. 15 W
Reception: Approx. 35 W
Copy: Approx. 40 W
Maximum: Approx. 100 W
- 17. Power Supply:** 120 V AC, 60 Hz (This unit will not function at 50 Hz.)

■ Handset

- 1. Operating Environment:** 5–35 °C (41–95 °F), 45–85 % RH (Relative Humidity)
- 2. Dimensions (H×W×D):** Approx. 39×55×271 mm (1¹⁷/₃₂" × 2³/₃₂" × 10¹¹/₁₆"
- 3. Weight:** Approx. 200 g (0.4 lb.)
- 4. Power Supply:** Ni-Cd battery (3.6 V, 600 mAh)
- 5. Frequency:** 902–904 MHz, 926–928 MHz (30 channels)
- 6. Security Codes:** 1,000,000

*Transmission speed depends upon the contents of the pages, resolution, telephone line conditions and capability of receiving unit. 15 second speed based upon CCITT No.1 Test Chart.

Note:

- Any details given in these instructions are subject to change without notice.
- The pictures and illustrations in these instructions may vary slightly from the actual product.

CCITT No. 1 Test Chart

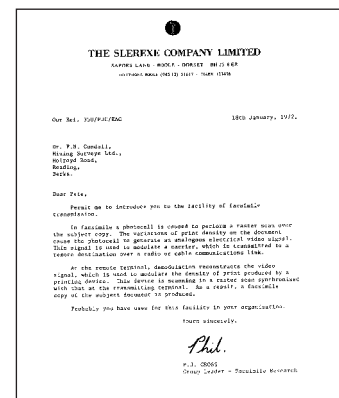

Speed dialer list for the main unit

Station No.	Name/Phone No.	Station No.	Name/Phone No.
00		25	
01		26	
02		27	
03		28	
04		29	
05		30	
06		31	
07		32	
08		33	
09		34	
10		35	
11		36	
12		37	
13		38	
14		39	
15		40	
16		41	
17		42	
18		43	
19		44	
20		45	
21		46	
22		47	
23		48	
24		49	

Memory station list for the handset

Station No.	Name/Phone No.	Station No.	Name/Phone No.
0		5	
1		6	
2		7	
3		8	
4		9	

Speed dialer list for the main unit

Station No.	Name/Phone No.	Station No.	Name/Phone No.
00		25	
01		26	
02		27	
03		28	
04		29	
05		30	
06		31	
07		32	
08		33	
09		34	
10		35	
11		36	
12		37	
13		38	
14		39	
15		40	
16		41	
17		42	
18		43	
19		44	
20		45	
21		46	
22		47	
23		48	
24		49	

Memory station list for the handset

Station No.	Name/Phone No.	Station No.	Name/Phone No.
0		5	
1		6	
2		7	
3		8	
4		9	

Index

A	AUTO button	30, 31	L	LOCATOR/INTERCOM button	34
	AUTO RECEIVE button	18		Logo	14
	AUTO RECEIVE mode	18		Logo print position	40
	Automatic dialing	29, 30, 31, 32		LOWER key	29, 31, 32
C	CH button	20	M	MANUAL RECEIVE mode	18
	Cleaning	63		MUTE button	21
	COPY button	28	O	Overseas transmission mode	40
D	Date and time	14	P	PAUSE button	37
	Delayed transmission	39		Polling	38
	DELETE key	15		PROGRAM button	30
	Dialing mode	12	R	REDIAL button	20, 21
	DIRECTORY button	31, 32, 33		Remote fax activation code	41
	Display contrast	50		Remote TAM activation ID	48
E	Electronic telephone directory	33		RESOLUTION button	22
	Error message	55		Ring pattern detection	43
	EXT.TAM mode	18, 46	S	SECRET key	29
F	Facsimile telephone number	16		Set default	50
	Fax auto redial	23		Silent detection	49
	FAX mode	18, 19, 25		Silent fax recognition ring	28
	Fax pager	44		SPACE key	15
	FAX ring count	25	T	TALK button	20
	Feeder pressure	60		TEL mode	18
	FLASH button	37		TEL/FAX mode	18, 19, 26
	Friendly reception	24, 45		TEL/FAX ring count	27
H	HELP button	12		Telephone number list	52
I	INSERT key	15		TONE button	37
	INTERCOM button	34		Transmission report	53
J	Journal auto print	53	V	Voice contact	36
	Journal report	52, 53, 54		VOLUME button	17
	Junk mail prohibitor	42		VOLUME/RINGER button	17

Panasonic FAX ADVANTAGE PROGRAM

We are proud to present the Panasonic Fax Advantage Program. It's an incredible service program that's full of exciting advantages!

Customer Satisfaction

In support of our one-year limited warranty* (parts and labor) on our current fax product line, Panasonic is proud to offer you the following service options during the limited warranty period:

- 1 If you mail-in or carry-in your fax unit to one of our Regional Servicenters, the product will be repaired and returned to you, or...
- 2 If you call our 1-800-HELPFAX (1-800-435-7329) toll-free number, you will receive a refurbished replacement product overnight or on the second business day (delivery depending on the time of your call.)

Support After The Sale

If you have a problem with your fax, just call our 1-800-HELPFAX (1-800-435-7329) toll-free number for friendly support and assistance. We have a highly-qualified team of experts who can diagnose, and most likely solve, your problem over the phone. Approximately 90% of our customers' problems are resolved with just a simple phone call.

The Fax Advantage Program covers the first year of purchase and works like this:

- 1 If you have a problem with your fax, call toll-free 1-800-HELPFAX (1-800-435-7329).
- 2 Talk to one of our experienced technical experts to diagnose (and most likely solve) your problem over the phone.
- 3 Providing that you may be entitled to Panasonic's service under the terms and conditions of the limited warranty**, we will arrange for a reconditioned replacement unit to be shipped to you overnight or second business day delivery, depending on the time of your call. The replacement unit will be completely refurbished, quality-tested by Panasonic technicians, and individually hand-inspected before it is shipped to you. You will keep the replacement unit and send your original unit to us, along with a copy of your receipt.
- 4 This receipt must be shipped back with your original unit to Panasonic Company (as per instructions enclosed in your

replacement unit's box).

Any unit that is replaced by Panasonic and not backed up by a proof of purchase by you will be subject to a minimum \$100.00 charge. Any unit that is replaced, but does not meet the terms and conditions of the limited warranty will be subject to additional charges, as per the program guidelines.

5 Once you receive your replacement unit, pack up your problem unit in the replacement unit's box. UPS will make 3 attempts within 10 days to pick-up your defective unit at no charge to you (should you be entitled to warranty service. If warranty conditions do not apply, you will be charged for all applicable shipping charges). The product must be properly packaged in the same manner as the replacement unit, utilizing the packing materials provided. You must make your unit available for UPS pick-up. If your unit is not available for UPS, you will be responsible for shipping unit back at your expense. Damage due to improper or inadequate packing will be charged back to your charge card as an out-of-warranty cost, as per the warranty stipulations.

Requirements:

6 You must give our technicians a valid credit card number. They will change your card account to cover any charges that are incurred by failure to send the problem product to Panasonic Company. If your problem unit is not eligible for warranty, you will be charged for the repair of the unit and for any shipping charges associated with this program. If you do not wish to pay out-of-warranty repair costs, you will be responsible for returning the replacement unit to Panasonic and for paying all shipping charges associated with this program including the overnight delivery of replacement product to you, shipment of problem unit to Panasonic, the replacement unit back to Panasonic and the return of your original unit back to you.

Acceptable credit cards:

Discover VISA
Master Card American Express (Optima)

Product that is not returned to Panasonic by 10 business days after shipment of the replacement product, will be charged to your account at Panasonic's Suggested Retail Price (see dealer for details).

Credit status will be verified prior to sending the replacement product.

Proof of Purchase must be included with the returned unit to verify warranty status.

Any parts and labor that are not covered by the limited warranty* will be charged as a non-warranty repair and billed at Panasonic's current rate for parts and labor.

*See the warranty stipulations in these instructions.

**Replacement program excludes Puerto Rico and is subject to termination at any time without advance notice.



Matsushita Consumer Electronics Company, Division of Matsushita Electric Corporation of America
One Panasonic Way, Secaucus,
New Jersey 07094

Panasonic Sales Company, Division of Matsushita Electric of Puerto Rico, Inc. ("PSC")
Ave. 65 de Infantería, Km. 9.5
San Gabriel Industrial Park, Carolina,
Puerto Rico 00985

Free Manuals Download Website

<http://myh66.com>

<http://usermanuals.us>

<http://www.somanuals.com>

<http://www.4manuals.cc>

<http://www.manual-lib.com>

<http://www.404manual.com>

<http://www.luxmanual.com>

<http://aubethermostatmanual.com>

Golf course search by state

<http://golfingnear.com>

Email search by domain

<http://emailbydomain.com>

Auto manuals search

<http://auto.somanuals.com>

TV manuals search

<http://tv.somanuals.com>