

Panasonic

Compact Plain Paper Fax with DECT Operating Instructions

Model No. **KX-FC241AL**

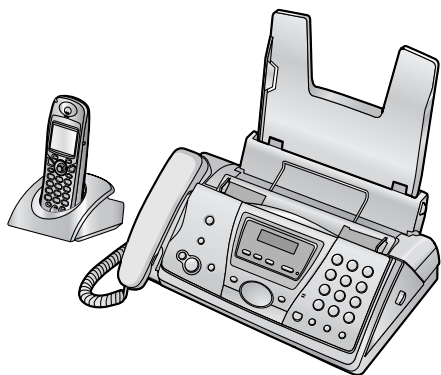

Please read these operating instructions before using the unit and save for future reference.

This unit is compatible with Caller ID. To use this feature, you must subscribe to the appropriate service of your service provider.

Be sure to use the telephone line cord included in this unit.

This model is designed to be used in Australia and New Zealand. To use in New Zealand, change the location setting (feature #74 on page 69).

How to use the operating instructions

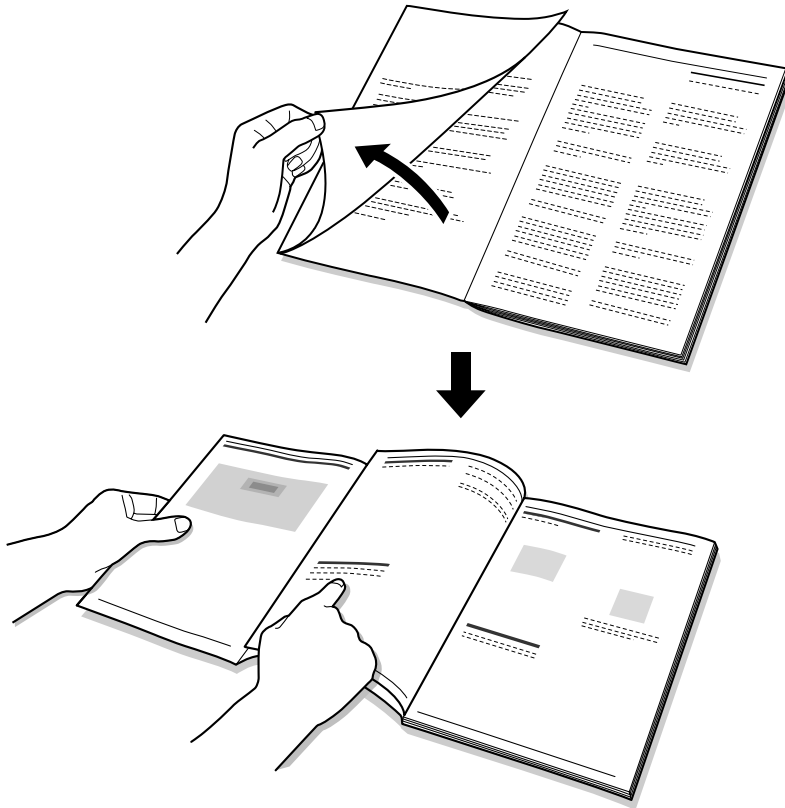

When following operating instructions, always keep the front cover page (next page) open for easy reference to the buttons.

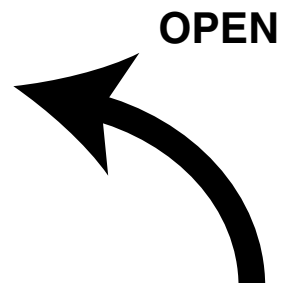

Location of Controls

Please keep this page open when following operating instructions.
For a description of each button, see page 12, 13.

Base unit

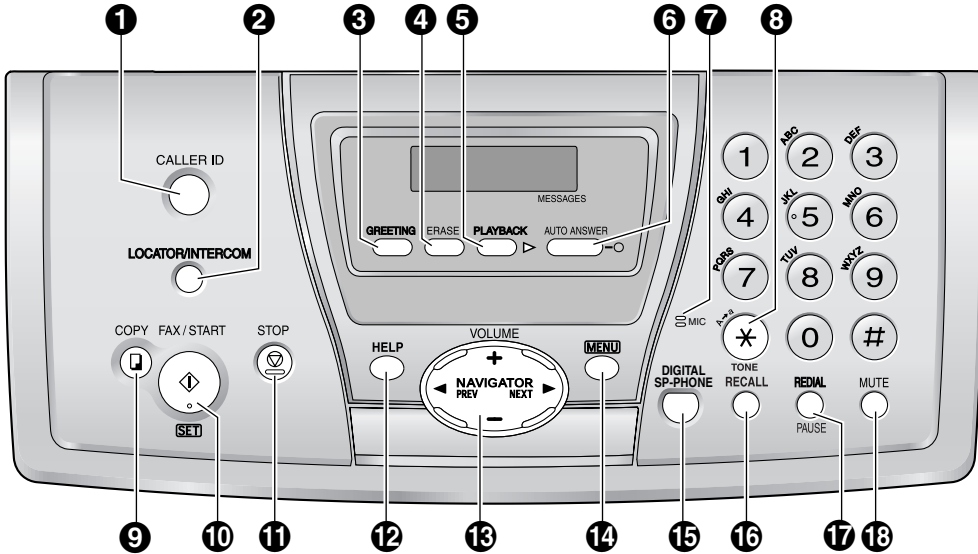

Buttons (Listed in alphabetical order)

- | | | |
|---------------------|--------------------|-----------|
| AUTO ANSWER 6 | LOCATOR/INTERCOM 2 | REDIAL 17 |
| CALLER ID 1 | MENU 14 | SET 10 |
| COPY 9 | MIC (Microphone) 7 | START 10 |
| DIGITAL SP-PHONE 15 | MUTE 18 | STOP 11 |
| ERASE 4 | NAVIGATOR 13 | TONE 8 |
| FAX/START 10 | PAUSE 17 | VOLUME 13 |
| GREETING 3 | PLAYBACK 5 | |
| HELP 12 | RECALL 16 | |

Cordless handset

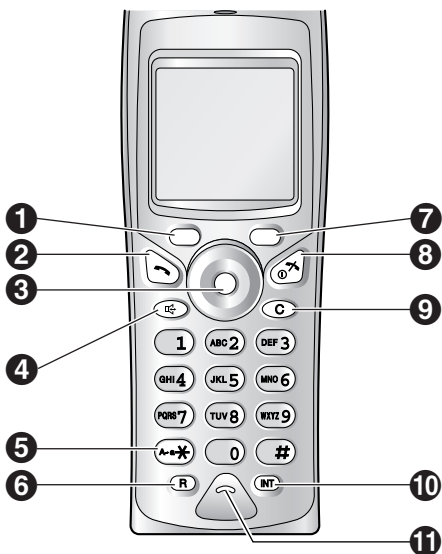

Buttons

- Left soft key 1
- (Talk) 2
- Joystick 3
- (Speakerphone) 4
- (Tone) 5
- R (Recall) 6
- Right soft key 7
- (Off/Power) 8
- C (Clear) 9
- INT (Intercom) 10
- Microphone 11

Dear purchaser,

Thank you for purchasing a Panasonic fax machine.

You have acquired a product made in compliance with the Digital Enhanced Cordless Telecommunications (DECT) standard. DECT technology is characterized by high-security protection against interceptions as well as high-quality digital transmission. This telephone was designed for a wide range of applications.

For your future reference

Date of purchase

Serial number (found on the rear of the unit)

Dealer's name and address

Dealer's telephone number

Attach your sales receipt here.

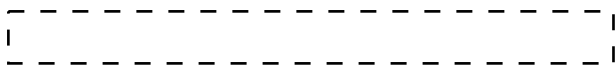

This model is designed to be used in Australia and New Zealand according to the location setting feature.

The default setting is Australia. To use in New Zealand, change the setting (feature #74 on page 69).

Caution:

- Note that the images of copied or received documents will remain on the used ink film. Use discretion when disposing of the used ink film.
- Do not rub or use an eraser on the printed side of recording paper, as the print may smear.
- In the event of problems, you should contact your equipment supplier in the first instance.
- This equipment is designed for use on the Australia and New Zealand network.

For Australian users

Warning:

- Please ensure that a separate telephone, not dependent on local power, is available for emergency use.
- This equipment will be inoperable when mains power fails.
- When a failure occurs which results in the internal parts becoming accessible, disconnect the power supply cord immediately and return this unit to an authorised service centre.
- Disconnect the telephone connection before disconnecting power connection prior to relocating the equipment, and reconnect the power first.
- To minimize the possibility of lightning damage, when you know that a thunderstorm is coming, we recommend that you:
 - A. Unplug the telephone line cord from the phone jack.
 - B. Unplug the power supply cord from the AC power outlet.
- No "000" or other calls can be made from this device during a mains power failure.
- The earcap on the handset is magnetised and may retain metallic objects.

For New Zealand users

Warning:

- WHEN A FAILURE OCCURS WHICH RESULTS IN THE INTERNAL PARTS BECOMING ACCESSIBLE, DISCONNECT THE POWER SUPPLY CORD IMMEDIATELY AND RETURN THIS UNIT TO AN AUTHORISED SERVICE CENTRE.
- DISCONNECT THE TELECOM CONNECTION BEFORE DISCONNECTING THE POWER CONNECTION PRIOR TO RELOCATING THE EQUIPMENT, AND RECONNECT THE POWER FIRST.
- NO "111" OR OTHER CALLS CAN BE MADE FROM THIS DEVICE DURING A MAINS POWER FAILURE.

IMPORTANT NOTICE

Under power failure conditions, this telephone may not operate. Please ensure that a separate telephone, not dependent on local power, is available for emergency use.

Notice:

- The grant of a Telepermit for any item of terminal equipment indicates only that Telecom has accepted that the item complies with minimum conditions for connection to its network. It indicates no endorsement of the product by Telecom, nor does it provide any sort of warranty. Above all, it provides no assurance that any item will work correctly in all respects with another item of Telepermitted equipment of a different make or model, nor does it imply that any product is compatible with all of Telecom's network services.
- This equipment shall not be set to make automatic calls to the Telecom "111" Emergency Service.
- This equipment should not be used under any circumstances which may constitute a nuisance to other Telecom customers.
- Not all telephones will respond to incoming ringing when connected to the extension socket.
- This equipment may not provide for the effective hand-over of a call to another device connected to the same line.

Important information

Instructions to customer

Installation

Attached to this apparatus is an approval label. This label is evidence that it is a "Permitted Attachment" which has been authorised to be connected to your telephone service.

Conditions relating to connection and operation of this Permitted Attachment are contained in Telecommunications General By-Law 220 (5).

You are authorised to install this Permitted Attachment yourself by plugging it into the line socket of any regular telephone. You may connect it in place of your existing telephone or to any spare telephone socket installed in your premises.

To disconnect your existing telephone you must first remove its plug from the line socket. You can then insert the plug of your Permitted Attachment into the socket and use your equipment.

If the plug of your existing telephone cannot be readily removed, you will have to remove the screw securing it. To do this proceed as follows:

1. Loosen screw "A" sufficiently to remove the socket cover. (See Fig. 1.)
2. Remove screw "B" and withdraw the plug. (See Fig. 2.)
3. Replace screw "B". (See Fig. 3.) Ensure that it screws completely into the socket recess. (If the screw is too long, increase the hole depth or replace the screw with one 5 mm shorter.)
4. Replace socket cover and tighten screw "A". (See Fig. 4.)

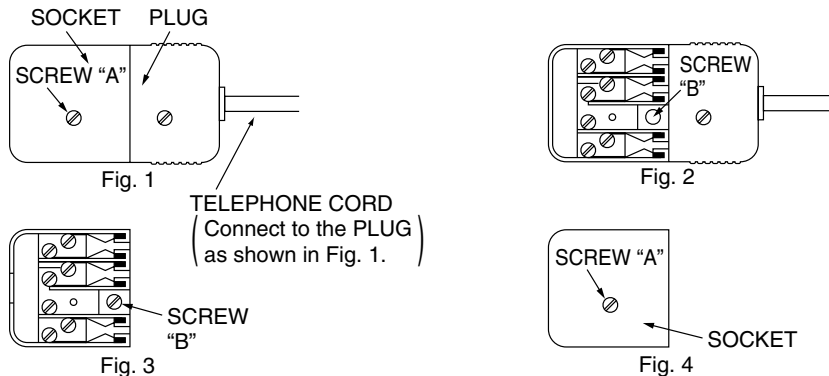

If you are satisfied with the operation of your telephone service after plugging in your Permitted Attachment, your installation is completed.

You will be unable to connect this Permitted Attachment if your telephone service consists only of a wall phone or an old style telephone which is not connected by means of a modern plug and socket. In such cases a new socket will need to be installed.

Should the Permitted Attachment not operate when plugged into a socket, it is either faulty or unsuitable for operation with your telephone service. It should be returned to the store where purchased.

Service difficulties

If at any time a fault occurs on your telephone service carry out the following checks before you call for service:

- Disconnect the Permitted Attachment and try using the service with the normal telephone.
- If the telephone service then operates satisfactorily, the fault is in your Permitted Attachment. Leave the Permitted Attachment disconnected and report the fault to its supplier or agent to arrange for repair.
- If when using the telephone the service is still faulty, report the fault to "Service Difficulties and Faults" for attention.

You are required to keep this Permitted Attachment in good working order while it is connected to your telephone service. Its construction or internal circuit must not be modified in any way without permission.

WARNING

This cordless telephone system does not incorporate provision for secrecy of conversations. Appropriately tuned radio equipment and other cordless telephone systems in close proximity may be used by a third party to monitor and possibly interrupt conversations in progress when this system is on radio operation.

Important safety instructions

When using this unit, basic safety precautions should always be followed to reduce the risk of fire, electric shock, or personal injury.

1. Read and understand all instructions.
2. Follow all warnings and instructions marked on this unit.
3. Unplug this unit from power outlets before cleaning. Do not use liquid or aerosol cleaners. Use a damp cloth for cleaning.
4. Do not use this unit near water, for example near a bathtub, wash bowl, kitchen sink, etc.
5. Place the unit securely on a stable surface. Serious damage and/or injury may result if the unit falls.
6. Do not cover slots and openings on the unit. They are provided for ventilation and protection against overheating. Never place the unit near radiators, or in a place where proper ventilation is not provided.
7. Use only the power source marked on the unit. If you are not sure of the type of power supplied to your home, consult your dealer or local power company.
8. For safety purposes this unit is equipped with a grounded plug. If you do not have this type of outlet, please have one installed. Do not defeat this safety feature by tampering with the plug.
9. Do not place objects on the power cord. Install the unit where no one can step or trip on the cord.
10. Do not overload power outlets and extension cords. This can result in the risk of fire or electric shock.
11. Never push any objects through slots in this unit. This may result in the risk of fire or electric shock. Never spill any liquid on the unit.
12. To reduce the risk of electric shock, do not disassemble this unit. Take the unit to an authorised service centre when service is required. Opening or removing covers may expose you to dangerous voltage or other risks. Incorrect reassembly can cause electric shock when the unit is subsequently used.
13. Unplug this unit from power outlets and refer servicing to an authorised service centre when the following conditions occur:
 - A. When the power cord is damaged or frayed.
 - B. If liquid has been spilled into the unit.
 - C. If the unit has been exposed to rain or water.
 - D. If the unit does not work normally by following the operating instructions. Adjust only controls covered by the operating instructions. Improper adjustment may require extensive work by an authorised service centre.
 - E. If the unit has been dropped or physically damaged.
 - F. If the unit exhibits a distinct change in performance.
14. During thunderstorms, avoid using telephones except cordless types. There may be a remote risk of an electric shock from lightning.
15. Do not use this unit to report a gas leak, when in the vicinity of the leak.
16. It is advised not to use the equipment at a refuelling point. Users are reminded to observe restrictions on the use of radio equipment in fuel depots, chemical plants or where blasting operations are in progress.

SAVE THESE INSTRUCTIONS

CAUTION:

Installation

- Never install telephone wiring during a lightning storm.
- Never install telephone jacks in wet locations unless the jack is specifically designed for wet locations.
- Never touch uninsulated telephone wires or terminals unless the telephone line has been disconnected at the network interface.
- Use caution when installing or modifying telephone lines.
- Do not touch the plug with wet hands.
- This unit should not be used near emergency/intensive care medical equipment and should not be used by people with pacemakers.

Battery

To reduce the risk of fire or injury to persons, read and follow these instructions.

- Use only the battery(ies) specified.
- Do not dispose of the battery(ies) in a fire. They may explode. Check with local waste management codes for special disposal instructions.
- Do not open or mutilate the battery(ies). Released electrolyte is corrosive and may cause burns or injury to the eyes or skin. The electrolyte may be toxic if swallowed.
- Exercise care when handling the battery(ies). Do not allow conductive materials such as rings, bracelets or keys to touch the battery(ies), otherwise a short circuit may cause the battery(ies) and/or the conductive material to overheat and cause burns.
- Charge the battery(ies) provided with or identified for use with this product only in accordance with the instructions and limitations specified in these operating instructions.
- Only use the included charger to charge the battery(ies). Do not tamper with the charger. Failure to follow these instructions may cause the battery(ies) to swell or explode.

WARNING:

- To prevent the risk of fire or electrical shock, do not expose this product to rain or any type of moisture.
- The cordless handset is magnetised and may retain small metallic objects.

For best performance

Battery charge

- Place the cordless handset on the charger for about **7 hours** before initial use.
- For details, see page 23.

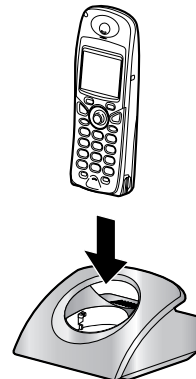

Operating distance and noise

- The base unit and cordless handset use radio waves to communicate with each other. **For maximum distance and noise-free operation**, we recommend the following:

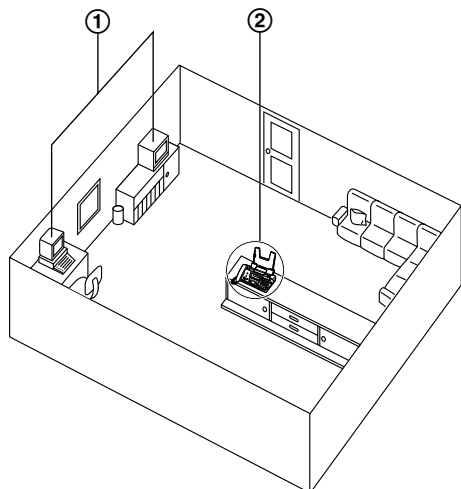

- ① Placing your base unit away from electrical appliances such as TVs, radios, personal computers or other phones.
- ② Placing the base unit in a HIGH and CENTRAL location with no obstructions such as walls.

Environment

- Keep the unit away from electrical noise generating devices, such as fluorescent lamps and motors.
- The unit should be kept free from dust, high temperature and vibration.
- The unit should not be exposed to direct sunlight.
- Do not place heavy objects on top of the unit.
- The unit should be kept away from heat sources such as heaters, kitchen stoves, etc. It should not be placed in rooms where the temperature is less than 5 °C or greater than 35 °C (base unit) / 40 °C (cordless handset, charger unit). Damp basements should also be avoided.

Routine care

- Wipe the outer surface of the unit with a soft cloth. Do not use benzine, thinner, or any abrasive powder.

Recording paper

- Store unused paper in the original packaging, in a cool and dry place. Not doing so may affect print quality.

1. Introduction

Accessories

- 1.1 Included accessories 10
- 1.2 Accessory information 11

Finding the Controls

- 1.3 Button descriptions of the base unit . 12
- 1.4 Button descriptions of the cordless handset..... 13
- 1.5 Display descriptions of the cordless handset..... 14
- 1.6 Overview 16

2. Installation

Base Unit

- 2.1 Ink film installation / replacement 17
- 2.2 Handset cord 19
- 2.3 Paper tray 19
- 2.4 Recording paper..... 20

Cordless Handset

- 2.5 Battery installation / replacement 21

3. Preparation

Connections and Set up

- 3.1 Connections 22
- 3.2 Battery charge 23
- 3.3 Turning the cordless handset power ON/OFF 24

Help Button

- 3.4 Base unit help function 24

Volume

- 3.5 Adjusting cordless handset volume.. 25
- 3.6 Adjusting base unit volume..... 25

Initial Programming

- 3.7 Date and time 26
- 3.8 Your logo..... 28
- 3.9 Your fax number 29

4. Telephone

Making and Answering Calls

- 4.1 Making phone calls..... 31
- 4.2 Answering phone calls..... 33

Recording

- 4.3 Recording a telephone conversation (Cordless handset only) 33

Automatic Dialling

- 4.4 Cordless handset phonebook..... 34
- 4.5 Base unit phonebook..... 36

Caller ID

- 4.6 Caller ID service 38
- 4.7 Viewing and calling back using caller information..... 39
- 4.8 Editing a caller's telephone number

- before calling back / storing..... 40
- 4.9 Erasing caller information 40
- 4.10 Storing caller information into the phonebook..... 41

5. Fax

Sending Faxes

- 5.1 Sending a fax manually 43
- 5.2 Documents you can send..... 44
- 5.3 Sending a fax using the base unit phonebook..... 45
- 5.4 Broadcast transmission 45

Receiving Faxes

- 5.5 Selecting the way to use your fax machine..... 47
- 5.6 Receiving a fax manually – Auto answer OFF 49
- 5.7 Receiving a fax automatically – Auto answer ON..... 50
- 5.8 Receive polling (retrieving a fax placed on another fax machine)..... 52
- 5.9 Junk fax prohibitor (preventing fax reception from undesired callers) 53

6. Distinctive Ring

Distinctive Ring

- 6.1 Using with the ring detection feature 54

7. Copy

Copying

- 7.1 Making a copy 55

8. Answering Machine

Greeting

- 8.1 Recording your greeting message.... 57

Incoming Messages

- 8.2 Listening to recorded messages 58

Memo Message

- 8.3 Leaving a message for others or yourself 59

Remote Operation

- 8.4 Using the answering machine with the cordless handset 59
- 8.5 Operating from a remote location..... 63

9. Programmable Features

Base Unit

- 9.1 Base unit programming 65
- 9.2 Basic features..... 66
- 9.3 Advanced features..... 67
- 9.4 Direct commands for programming features..... 70

Cordless Handset

- 9.5 Cordless handset programming **73**
- 9.6 Cordless handset programming using the base unit PIN **78**

10. Multi-unit Operation

Additional Units

- 10.1 Operating additional units **81**
- 10.2 Registering a cordless handset to a base unit **81**
- 10.3 Intercom **82**
- 10.4 Transferring calls / Conference calls. **83**
- 10.5 Copying cordless handset phonebook items **84**
- 10.6 Walkie-Talkie **85**

11. Useful Information

Useful Information

- 11.1 Using the belt clip **86**
- 11.2 Using an optional headset **86**
- 11.3 Wall mounting the charger **87**
- 11.4 Available character entries for the cordless handset **88**

12. Help

Error Messages

- 12.1 Error messages – Reports **90**
- 12.2 Error messages – Base unit display. **90**

Troubleshooting

- 12.3 When a function does not work, check here **93**

Jams

- 12.4 Recording paper jams **100**
- 12.5 Document jams – sending **102**

Cleaning

- 12.6 Recording paper feeder cleaning ... **103**
- 12.7 Document feeder / scanner glass cleaning **104**
- 12.8 Thermal head cleaning **105**

13. General Information

Printed Reports

- 13.1 Reference lists and reports (Base unit only) **106**

Specifications

- 13.2 Specifications **107**

14. Index

- 14.1 Index **109**

1.1 Included accessories

No.	Item	Quantity	Notes
①	Power cord	1	-----
②	Telephone line cord	1	For Australian users (Modular type plug)
		1	For New Zealand users (New Zealand BT type plug)
③	Handset	1	-----
④	Handset cord	1	-----
⑤	Paper tray	1	-----
⑥	Starter ink film (10 metres long)	1	prints about 30 A4-sized pages.*1
⑦	Cordless handset	1	-----
⑧	Rechargeable batteries	2	AAA size
⑨	Battery cover	1	-----
⑩	AC adaptor	1	-----
⑪	Belt clip	1	-----
⑫	Charger	1	-----
⑬	Operating instructions	1	-----
⑭	Quick installation guide	1	-----

*1 For replacement film, see page 11.

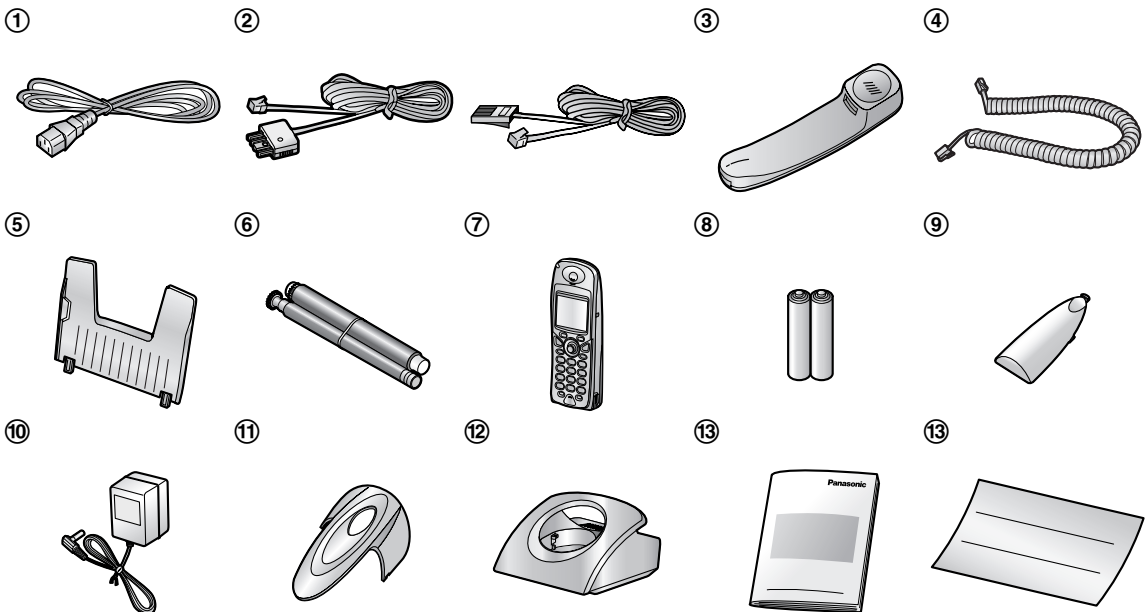

Note:

- If any items are missing or damaged, contact the place of purchase.
- Save the original carton and packing materials for future shipping and transportation of the unit.

1.2 Accessory information

1.2.1 Available accessories

Model No.	Item	Specifications/Usage
KX-FA54E	Replacement film ^{*1}	35 m × 2 rolls (Each roll will print about 105 A4-sized pages.)
P03P	Rechargeable batteries	Nickel metal hydride (Ni-MH) batteries
P03H	Rechargeable batteries	Nickel cadmium (Ni-Cd) batteries
KX-TCA151AZ	Additional cordless handset	-----
KX-TCA89AL	Headset	-----

*1 We recommend that you buy a full-size replacement film for continuous use of your unit. Please use genuine Panasonic replacement film. **The ink film is not reusable. Do not rewind and use the ink film again.**

1.3 Button descriptions of the base unit

- Keep the front cover page open for button locations.
- 1 [CALLER ID]**
 - To use Caller ID features (page 39, 41).
- 2 [LOCATOR/INTERCOM]**
 - To page or locate a cordless handset (page 82).
- 3 [GREETING]**
 - To record a greeting message (page 57).
- 4 [ERASE]**
 - To erase messages (page 57, 58).
- 5 [PLAYBACK]**
 - To play messages (page 58).
- 6 [AUTO ANSWER]**
 - To turn the auto answer setting ON/OFF (page 47).
- 7 [MIC] (Microphone)**
 - The built-in microphone.
- 8 [COPY]**
 - To copy a document (page 55).
- 9 [FAX/START][SET]**
 - To start sending or receiving a fax.
 - To store a setting during programming.
- 10 [STOP]**
 - To stop an operation or programming session.
 - To erase a character/number (page 29). Press and hold to erase all characters/numbers.
- 11 [HELP]**
 - To print helpful information for quick reference (page 24).
- 12 [NAVIGATOR][VOLUME]**
 - To adjust volume (page 25).
 - To search for a stored item (page 37, 45).
 - To select features or feature settings during programming (page 65).
 - To navigate to the next operation.
- 13 [MENU]**
 - To initiate or exit programming.
- 14 [DIGITAL SP-PHONE]**
 - For speakerphone operation (page 32).
- 15 [RECALL]**
 - To access special telephone services or for transferring extension calls.
- 16 [REDIAL][PAUSE]**
 - To redial the last number dialled from the base unit.
For New Zealand users only
If the line is busy when you make a phone call using the **[DIGITAL SP-PHONE]** button, the unit will automatically redial the number up to 2 times.
 - To insert a pause during dialling.
- 17 [MUTE]**
 - To mute your voice to the other party during a conversation. Press again to resume the conversation.

1.4 Button descriptions of the cordless handset

- Keep the front cover page open for button locations.

1 Left soft key

- To select the item shown above this key (page 15).

2 [↶] (Talk)

- To make/answer calls (page 31, 33).

3 Joystick

- To adjust volume (page 25).
- To search for a stored item (page 34).
- To select the item shown on the display (page 13).
- To select features or feature settings during programming.
- To navigate to the next operation.

4 [☎] (Speakerphone)

- For speakerphone operation (page 31).

5 [*] (Tone)

- To change from pulse to tone temporarily during dialling when your line has rotary pulse services.

6 [R] (Recall)

- To access special telephone services or for transferring extension calls.

7 Right soft key

- To select the item shown above this key (page 15).

8 [⏻] (Off/Power)

- To turn power ON/OFF (page 24).
- To hang up (page 31, 33).
- To stop an operation or programming session.
- To exit programming.

9 [C] (Clear)

- To erase a character/number (page 34). Press and hold to erase all characters/numbers.

10 [INT] (Intercom)

- To page or locate the base unit or another cordless handset (page 82).

11 Microphone

- The built-in microphone.

Using the joystick

The cordless handset joystick can be used to navigate through menus and to select items shown on the display, by pushing it up, down, left, or right.

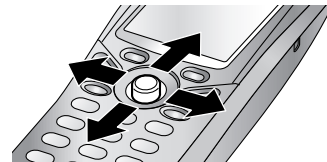

It can also be used to select the centre soft key icon (page 15), by pressing down on the centre of the joystick.

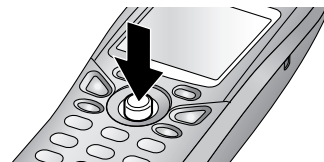

Note:

- Up to 5 menu items can be displayed at a time. To select a menu item not shown on the current page, scroll up or down by pushing the joystick up or down, respectively.

1.5 Display descriptions of the cordless handset

Display icons

Various icons appear on the cordless handset display to indicate the current status of the unit.

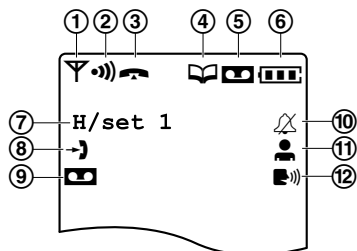

No.	Display icon	Meaning
①		Within range of a base unit <ul style="list-style-type: none"> When flashing: No base unit (out of range of base unit, cordless handset is not registered to base unit, no power on base unit)
②		Cordless handset is accessing base unit (intercom, paging, etc.)
③		Cordless handset is on an outside call
		Call bar is ON (page 76)
④		Phonebook is being accessed (page 34)
⑤		Auto answer setting is ON (page 47)
⑥		Battery strength (page 23)
⑦	"H/set 1"	Cordless handset number or name (page 76)
		Line is being used by another unit

No.	Display icon	Meaning
⑧		New call (Caller ID service users only, page 39)
⑨		New messages have been recorded (page 60)
⑩		Ringer volume is OFF (page 25)
⑪		Direct call is ON (page 76)
⑫		New voice message (call minder users only; page 42) (For New Zealand users only)

Menu icons

When in standby mode, pressing the joystick reveals the cordless handset's main menu. From here you can access various features and settings.

Menu icon	Menu/feature
	"Caller ID"
	"TAM Operation"
	"Ringer Option"
	"Setting Handset"
	"Setting Base"
	"Walkie-Talkie"

Soft keys

The cordless handset features two soft keys and a joystick. By pressing a soft key, or by pressing the centre of the joystick, you can select the feature or operation indicated by the soft key icon shown directly above it.

- Pressing the left or right soft key selects the leftmost or rightmost soft key icon respectively.
- Pressing the centre of the joystick selects the centre soft key icon.
- The icons shown will vary depending on how you are using the unit.

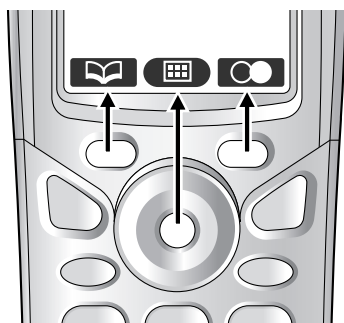

Soft key icons

Soft key icon	Action
	Returns to the previous screen.
	Displays the main menu.
	Displays the appropriate sub-menu.
	Accepts the current selection.
	Displays a previously dialled telephone number.
	Opens a phonebook.
	Creates a new phonebook item.
	Displays the phonebook search menu.
	Turns the key lock feature OFF (page 31).
	Switches between AM, PM, and 24-hour time entry.
	Stops recording or playback.
	Displayed when alphabet character entry is selected. Press to select another entry mode.

Soft key icon	Action
	Displayed when numeric character entry is selected. Press to select another entry mode.
	Displayed when Greek character entry is selected. Press to select another entry mode.
	Displayed when extended 1 character entry is selected. Press to select another entry mode.
	Displayed when extended 2 character entry is selected. Press to select another entry mode.
	Displayed when Cyrillic character entry is selected. Press to select another entry mode.
	Places a check mark next to the menu item.
	Inserts a pause during dialling.
	Turns the mute feature ON/OFF during a conversation.
	Erases the selected item.
	Displayed when the soft key has no function.

1.6 Overview

1.6.1 Base unit

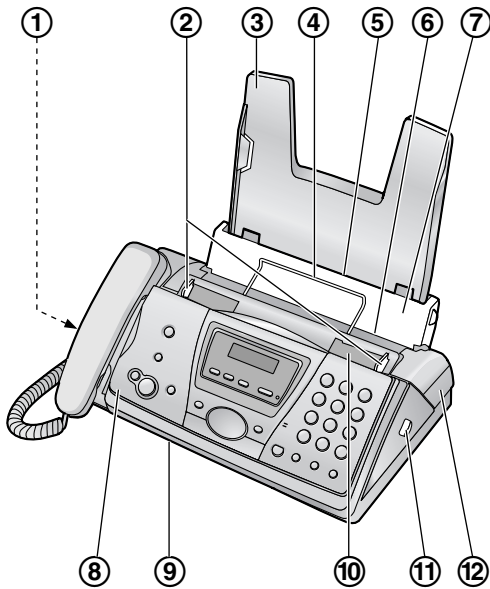

- ① Speaker
- ② Document guides
- ③ Paper tray
- ④ Recording paper support
- ⑤ Recording paper entrance
- ⑥ Recording paper exit
- ⑦ Tension plate
- ⑧ Front cover
- ⑨ Document exit
- ⑩ Document entrance
- ⑪ Green button (Back cover release button)
- ⑫ Back cover

1.6.2 Cordless handset



- ① Ringer indicator / Charge indicator
- ② Speaker
- ③ Headset jack
- ④ Receiver

2.1 Ink film installation / replacement

Important:

- Remove all blue shipping tape from the unit before installation.

2.1.1 Installing the ink film

The included film roll is a starter ink film.

- 1 Open the front cover by pulling up the centre part.

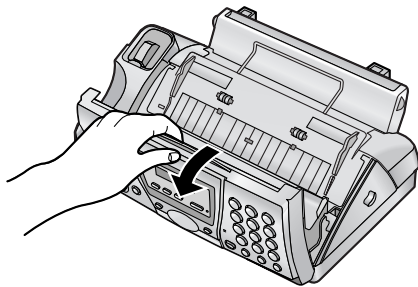

- 2 Release the back cover by pushing the green button (1).

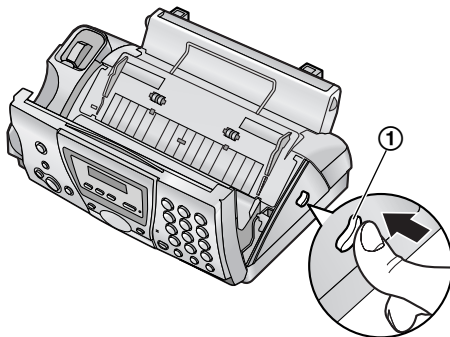

- 3 Open the back cover.

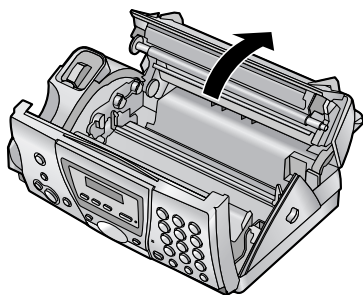

- 4 Insert the front ink film roll by inserting its blue gear into the left slot of the unit (1). Insert the rear ink film roll by inserting its white gear into the left slot of the unit (2).

- The ink film is safe to touch and will not rub off on your hands like carbon paper.
- Make sure the blue gear (1) and white gear (2) are installed as shown.

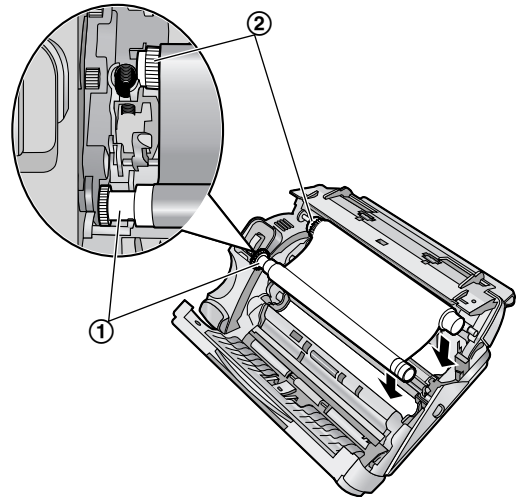

- 5 Turn the blue gear (1) in the direction of the arrow until the ink film is tight (2).

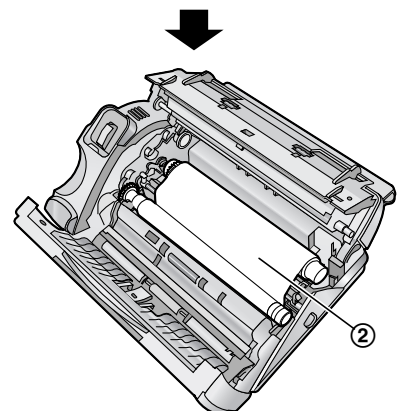
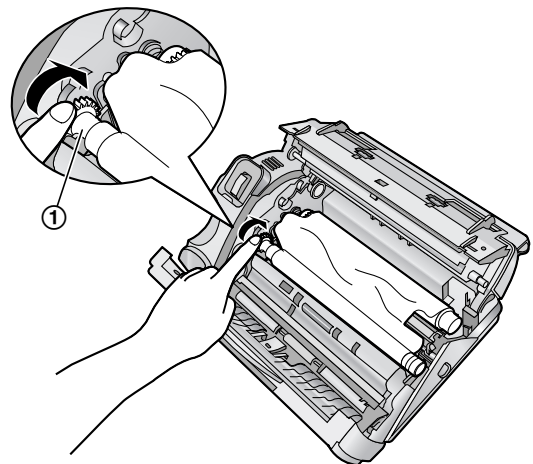

2. Installation

Correct

- The ink film is wrapped around the blue core (③) at least once.

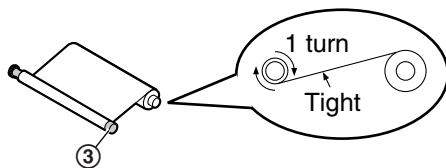

Incorrect

- The ink film is not wrapped around the blue core (④).

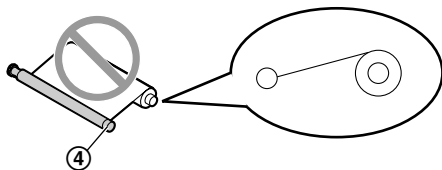

- The ink film is reversed.

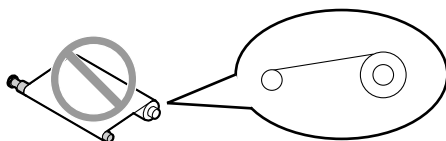

- The ink film is slack or creased.



- 6 Close the back cover securely by pushing down on the notched area at both ends (①).

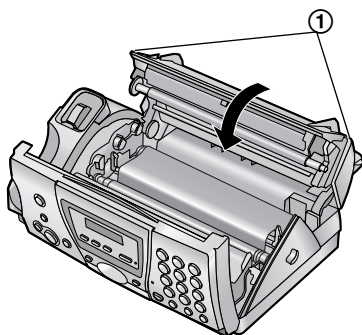

- 7 Close the front cover securely.

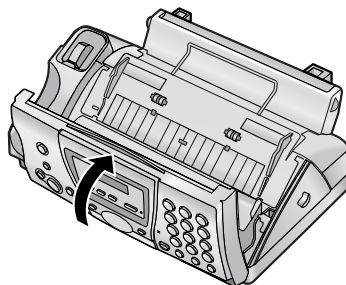

2.1.2 Replacing the ink film

To ensure that the unit operates properly, we recommend the use of Panasonic replacement film. See page 11 for accessory information.

- We cannot be responsible for any damage to the unit or degradation of print quality which may occur from the use of non-Panasonic replacement film.

Important:

- **Remove the recording paper and the paper tray beforehand, or the paper may misfeed or jam.**

- 1 Open the covers (see steps 1 to 3 on page 17).
- 2 Remove the used core (①) and used ink film (②).

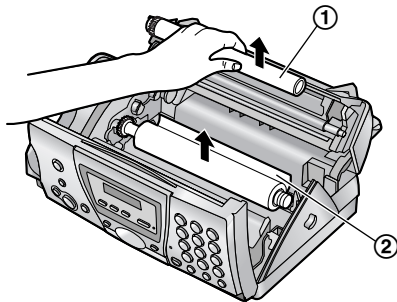

- 3 Remove the stoppers (①) and tags (②) from the new ink film (③).

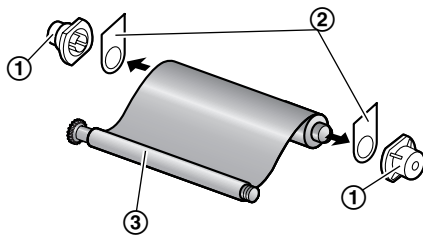

- 4 Insert the ink film and close the covers (see steps 4 to 7 on page 17).
- 5 Install the paper tray (page 19), then insert the recording paper (page 20).

2.2 Handset cord

Connect the handset cord (①).

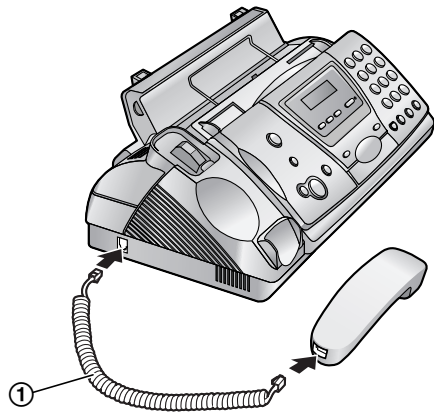

2.3 Paper tray

Insert the tabs on the paper tray (①) into the slots on the back of the unit (②).

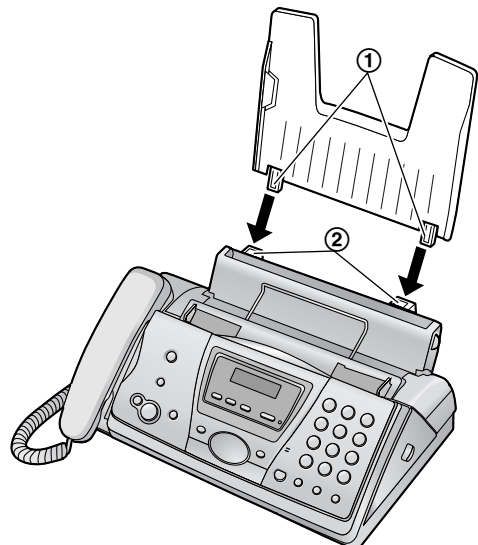

2.4 Recording paper

The unit can hold up to 30 sheets of 80 g/m² paper.

Please refer to page 107 for information on recording paper.

- 1 Pull the tension plate forward (①).



- 2 Fan the paper to prevent paper jams.

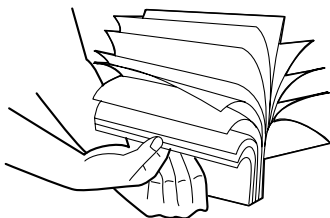

- 3 Insert the paper, print-side down.
 - The paper should not be over the tab (①).



- 4 Push the tension plate back (①).

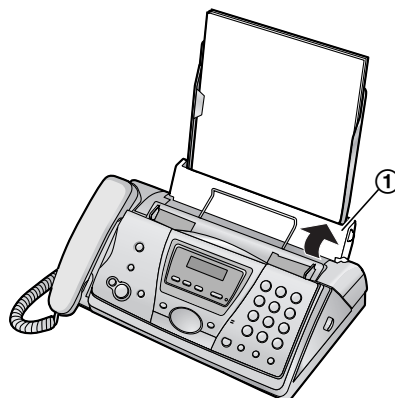

- If the paper is not inserted correctly, readjust the paper, or the paper may jam.

Correct

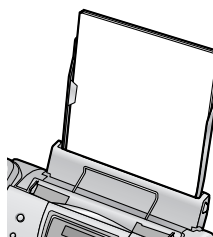

Incorrect

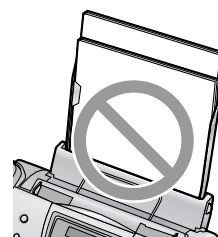

2.5 Battery installation / replacement

2.5.1 Installing the batteries

- 1 Insert the batteries negative (-) terminal first.

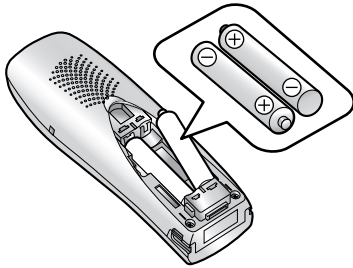

- 2 Close the battery cover.

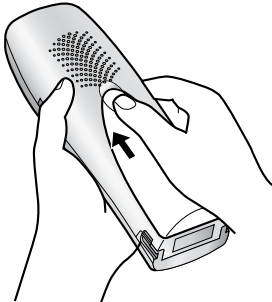

2.5.2 Replacing the batteries

If  flashes even when the batteries have been fully charged, both batteries must be replaced. **Please use only Panasonic batteries.** See page 11 for accessory information.

Important:

- Charge the new batteries for about 7 hours before initial use.
- When replacing the batteries, ensure that the correct battery type is selected (page 77) even if you install the same type of batteries.
- Use only rechargeable batteries. If you install non-rechargeable batteries and start charging, the batteries may leak electrolyte.
- Do not mix old and new batteries.

- 1 Press the notch on the cover firmly and slide it in the direction of the arrow.

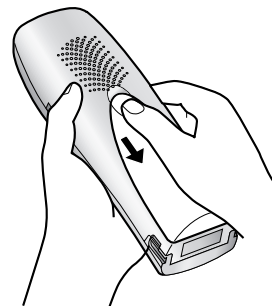

- 2 Remove the batteries positive (+) terminal first. Replace both batteries. See the battery installation procedure.

3. Preparation

3.1 Connections

Important:

- The unit will not function when there is a power failure. To make calls in emergency situations, you should connect a telephone that can function during a power failure to the telephone line.

3.1.1 Base unit

- ① Power cord
 - Connect to the power outlet (220 V – 240 V, 50/60 Hz).
- ② Telephone line cord
 - Connect to a single telephone line jack.

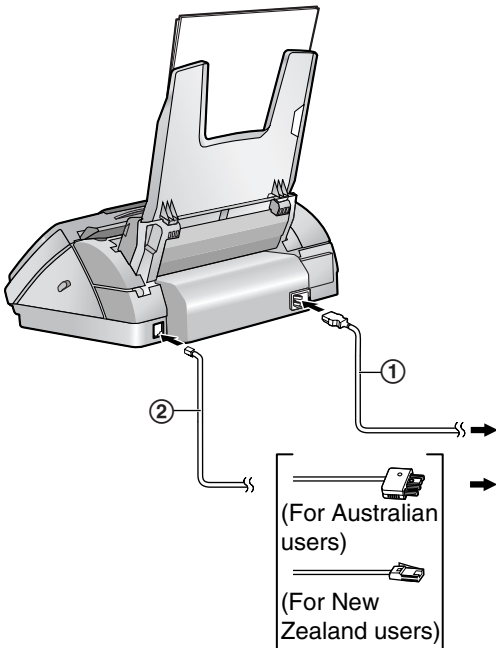

This model is designed to be used in Australia and New Zealand. **TO USE IN NEW ZEALAND, CHANGE THE LOCATION SETTING** (feature #74 on page 69).

Caution:

- When you operate this product, the power outlet should be near the product and easily accessible.
- Be sure to use the telephone line cord included in this unit.
- Do not extend the telephone line cord.

Note:

- If any other device is connected to the same telephone line, this unit may disturb the network condition of the device.

- If you use the unit with a computer and your internet provider instructs you to install a filter (③), please connect the telephone line cord as follows.

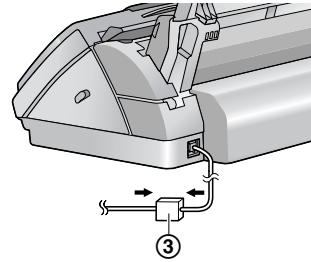

3.1.2 Charger unit

- ① AC adaptor
 - Connect to the power outlet (220 V – 240 V, 50/60 Hz).
- ② Hooks
 - Fasten the AC adaptor cord to prevent it from being disconnected.

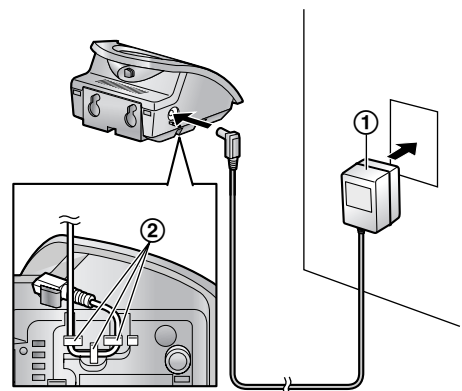

Caution:

- If the cordless handset is not charged, you cannot make or answer calls.
- **USE ONLY WITH the included Panasonic AC adaptor.**
- The AC adaptor must remain connected at all times. (It is normal for the adaptor to feel warm during use.)
- The AC adaptor should be connected to a vertically oriented or floor-mounted AC outlet. Do not connect the AC adaptor to a ceiling-mounted AC outlet, as the weight of the adaptor may cause it to become disconnected.

3.2 Battery charge

Place the cordless handset on the charger for about 7 hours before initial use.

The charge indicator (①) turns red while the batteries are charging, and turns green when the batteries are fully charged.

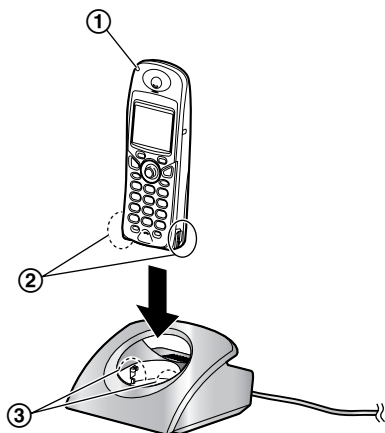

Note:

- Clean the cordless handset charge contacts (②) and the charger charge contacts (③) with a soft, dry cloth once a month, otherwise the batteries may not charge properly. Clean more often if the unit is exposed to grease, dust or high humidity.

Battery strength

You can confirm the battery strength on the cordless handset display.

Battery icons	Battery strength
	High
	Medium
	Low <ul style="list-style-type: none"> • When flashing: Needs to be charged

Note:

- If the cordless handset is turned OFF, it will be turned ON automatically when it is placed on the charger.
- The cordless handset will not operate while it is on the charger.
- If flashes when you lift the cordless handset off the charger, charge the batteries at least 15 minutes.

Battery life

After your Panasonic batteries are fully charged, you can expect the following performance:

Ni-MH Batteries (typical 700 mAh)

Operation	Operating Time
While in use (talking)	10 hours approx.
While not in use (standby)	180 hours approx.

Ni-Cd Batteries (typical 250 mAh)

Operation	Operating Time
While in use (talking)	4 hours approx.
While not in use (standby)	60 hours approx.

Note:

- Times indicated are for peak performance.
- Battery operating time may be shortened depending on usage conditions and ambient temperature.
- Battery power is consumed whenever the cordless handset is off the charger, even when the cordless handset is not in use. The longer you leave the cordless handset off the charger, the less time you can actually talk on the cordless handset.
- The batteries cannot be overcharged unless they are repeatedly removed and replaced.
- For maximum battery life, it is recommended that the cordless handset is not recharged until flashes.

3.3 Turning the cordless handset power ON/OFF

3.3.1 Power ON

Press [**✕**⓪] for about 1 second.

- The display will change to the standby mode.

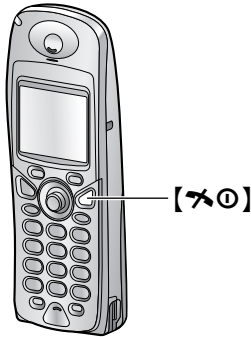

3.3.2 Power OFF

Press [**✕**⓪] for about 2 seconds.

- The display will go blank.

3.4 Base unit help function

The unit contains helpful information which can be printed for quick reference.

Basic settings:

How to set the date, time, your logo and fax number.

Feature list:

How to program the features.

Phonebook:

How to store names and numbers in the base unit phonebook and how to dial them.

Telephone answering machine operation:

How to use the telephone answering machine.

Fax receiving:

How to set the base unit to receive faxes.

Copier:

How to use the copier function.

Reports:

List of available reports.

Caller ID:

How to use the Caller ID features.

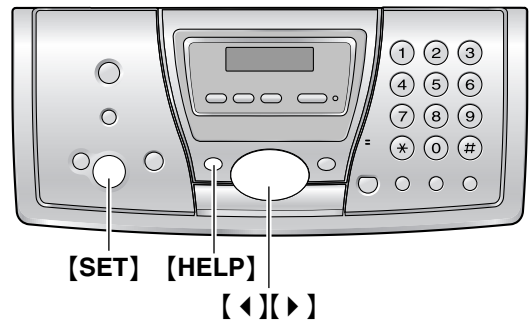

- 1 Press [**HELP**].
- 2 Press [**◀**] or [**▶**] repeatedly to display the desired item.
- 3 Press [**SET**].
 - The selected item will be printed.

3.5 Adjusting cordless handset volume

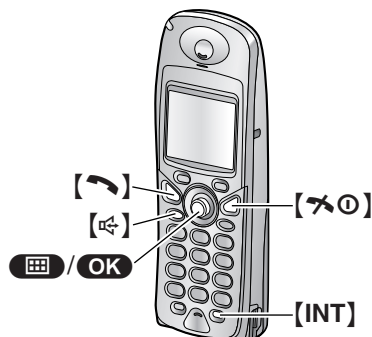

Ringer volume

7 levels (high to off) are available.

1. Press **OK** (centre of joystick).
2. Use the joystick to select **OK** "Ringer Option".
3. Press **OK**.
4. Push the joystick up or down repeatedly to select "Ringer Volume".
5. Press **OK**.
6. Push the joystick up or down repeatedly to select the desired volume.
7. Press **OK**.
8. Press **INT**.

Note:

- When the ringer volume is set to OFF, ∞ is displayed.
- When the ringer volume is set to OFF, the cordless handset will not ring for outside calls. The cordless handset will ring at the lowest level for intercom calls and when paged.

Ringer type

- You can select one of 15 ringer types for outside calls, intercom calls and paging. Caller ID service users can also use a different ringer for each category (page 74).

Receiver volume

3 levels (high/medium/low) are available.

While using **INT** or **INT**, push the joystick up or down.

Speaker volume

6 levels (high to low) are available.

While using **INT**, push the joystick up or down.

3.6 Adjusting base unit volume

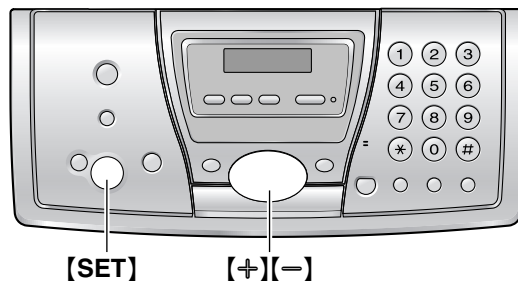

Ringer volume

4 levels (high/medium/low/off) are available.

While the unit is idle, press **+** or **-**.

- If any documents are in the document entrance, you cannot adjust the volume. Confirm that there are no documents in the entrance.

To turn the ringer OFF

1. Press **-** repeatedly to display "RINGER OFF= OK?".
2. Press **SET**.
 - When a call is received, the base unit will not ring for outside calls and will display "INCOMING CALL". The base unit will ring at the low level for intercom calls.
 - To turn the ringer back ON, press **+**.

Ringer type

- You can select the ringer types from one of 6 types for outside calls (feature #17 on page 67).

Handset receiver volume

3 levels (high/medium/low) are available.

While using the handset, press **+** or **-**.

Speaker volume

8 levels (high to low) are available.

While using the speakerphone, press **+** or **-**.

Answering machine volume

9 levels (high to off) are available.

While listening to messages, press **+** or **-**.

3.7 Date and time

The date and time can be set using either the cordless handset or the base unit.

- The other party's fax machine will print the date and time on each page you send according to your unit's date and time setting.
- The accuracy of the clock is approximately ± 60 seconds a month.

3.7.1 With the cordless handset

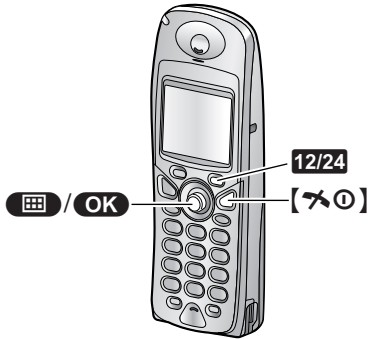

Important:

- Confirm that the power cord of the base unit is connected.
- Ensure that ∇ is not flashing.

- 1 Press **OK** (centre of joystick).
- 2 Use the joystick to select **Setting Handset**.
- 3 Press **OK**.
- 4 Push the joystick up or down repeatedly to select **Set Date/Time**.
- 5 Press **OK**.
 - The cursor (∇) will appear on the display.

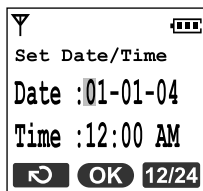

- 6 Enter the current date/month/year by selecting 2 digits for each.

Example: 10 August, 2004

Press **[1][0][0][8][0][4]**.

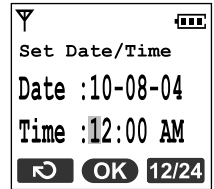

- 7 Enter the current hour/minute by selecting 2 digits for each. Press **12/24** repeatedly to select **AM**, **PM**, or 24-hour time entry.
 - When neither **AM** nor **PM** are displayed, 24-hour time entry is selected.

Example: 3:15 PM (12-hour time entry)

1. Press **[0][3][1][5]**.

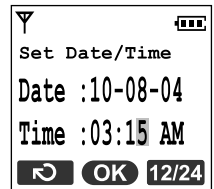

2. Press **12/24** repeatedly to display **PM**.

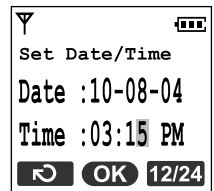

- 8 Press **OK**.
- 9 Press **[12/24]**.

To correct a mistake

- Use the joystick to move the cursor to the incorrect number, and make the correction.

3.7.2 With the base unit

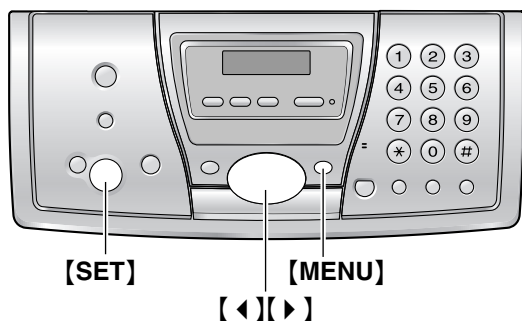

- 1 Press [MENU].

```
SYSTEM SETUP
PRESS NAVI. [◀ ▶]
```

- 2 Press [◀] or [▶] repeatedly to display the following.

```
SET DATE & TIME
PRESS SET
```

- 3 Press [SET].
 - The cursor (■) will appear on the display.

```
D: 01/M: 01/Y: 04
TIME: 12:00AM
```

- 4 Enter the current date/month/year by selecting 2 digits for each.

Example: 10 August, 2004

Press [1][0][0][8][0][4].

```
D: 10/M: 08/Y: 04
TIME: 12:00AM
```

- 5 Enter the current hour/minute by selecting 2 digits for each. Press [✱] repeatedly to select "AM", "PM", or 24-hour time entry.
 - When neither "AM" nor "PM" are displayed, 24-hour time entry is selected.

Example: 3:15PM (12-hour time entry)

1. Press [0][3][1][5].

```
D: 10/M: 08/Y: 04
TIME: 03:15AM
```

2. Press [✱] repeatedly to display "PM".

```
D: 10/M: 08/Y: 04
TIME: 03:15PM
```

- 6 Press [SET].
 - The next feature will be displayed.

- 7 Press [MENU].

To correct a mistake

Press [◀] or [▶] to move the cursor to the incorrect number, and make the correction.

If you have subscribed to a Caller ID service

The date and time will be automatically set according to the received caller information.

- If the time has not previously been set, Caller ID will not adjust the clock.

3.8 Your logo

Your logo will be printed on the top of each page sent from your unit.

The logo can be your name or the name of your company.

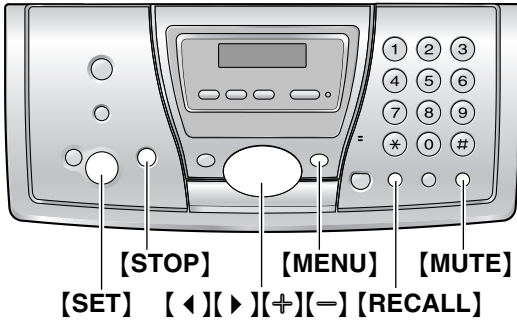

1 Press **[MENU]**.

SYSTEM SETUP
PRESS NAVI. [◀ ▶]

2 Press **[◀]** or **[▶]** repeatedly to display the following.

YOUR LOGO
PRESS SET

3 Press **[SET]**.

- The cursor (█) will appear on the display.

LOGO=█

4 Enter your logo, up to 30 characters. See the following character table for details.

5 Press **[SET]**.

- The next feature will be displayed.

6 Press **[MENU]**.

To select characters with the base unit dial keypad

Keypad	Characters
[1]	Space # & ' () * , - . / 1
[2]	A B C 2 a b c 2
[3]	D E F 3 d e f 3

Keypad	Characters
[4]	G H I 4 g h i 4
[5]	J K L 5 j k l 5
[6]	M N O 6 m n o 6
[7]	P Q R S 7 p q r s 7
[8]	T U V 8 t u v 8
[9]	W X Y Z 9 w x y z 9
[0]	Space 0
[*]	To change uppercase or lowercase letter.
[RECALL]	To enter a hyphen.
[MUTE]	To insert a space.
[STOP]	To delete a digit.

Note:

- To enter another character that is located on the same dial key, press **[▶]** to move the cursor to the next space.

To enter your logo

Example: "BILL"

1. Press **[2]** 3 times.

LOGO=B

2. Press **[4]** 3 times.

LOGO=BI

3. Press **[5]** 3 times.

LOGO=BIL

4. Press **[▶]** to move the cursor to the next space and press **[5]** 3 times.

LOGO=BILL

To change uppercase or lowercase letters

Pressing the **[*]** button will change to uppercase or lowercase letters alternately.

1. Press **[2]** 3 times.

LOGO=B

2. Press **[4]** 3 times.

LOGO=BI

3. Press **[*]**.

LOGO=Bi

4. Press **[5]** 3 times.

LOGO=Bi1

To correct a mistake

1. Press **[◀]** or **[▶]** to move the cursor to the incorrect character.
2. Press **[STOP]**.
 - To erase all characters, press and hold **[STOP]**.
3. Enter the correct character.

To select characters using **[+]** or **[-]**

Instead of pressing the dial keys, you can select characters using **[+]** or **[-]**.

1. Press **[-]** repeatedly to display the desired character. Characters will be displayed in the following order:
 - ① Uppercase letters
 - ② Number
 - ③ Symbol
 - ④ Lowercase letters
 - If you press **[+]**, the order will be reversed.
2. Press **[▶]** to insert the character.
3. Return to step 1 to enter the next character.

3.9 Your fax number

Your fax number will be printed on the top of each page sent from your unit.

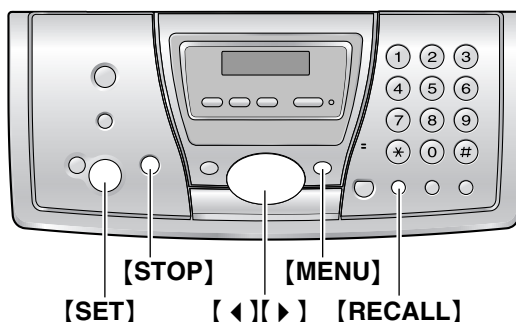

- 1 Press **[MENU]**.

SYSTEM SETUP
PRESS NAVI. [◀ ▶]

- 2 Press **[◀]** or **[▶]** repeatedly to display the following.

YOUR FAX NO.
PRESS SET

- 3 Press **[SET]**.
 - The cursor (■) will appear on the display.

NO.=■

- 4 Enter your fax number, up to 20 digits.

Example: NO.=1234567■

- 5 Press **[SET]**.
 - The next feature will be displayed.
- 6 Press **[MENU]**.

Note:

- The **[*]** button enters a “+” and the **[#]** button enters a space.
Example: +64 9 1234567
 Press **[*][6][4][#][9][#][1][2][3][4][5][6][7]**.
- To enter a hyphen in a telephone number, press **[RECALL]**.

To correct a mistake

1. Press **[◀]** or **[▶]** to move the cursor to the incorrect number.
2. Press **[STOP]**.
 - To erase all numbers, press and hold **[STOP]**.

3. Preparation

3. Enter the correct number.

4.1 Making phone calls

4.1.1 With the cordless handset

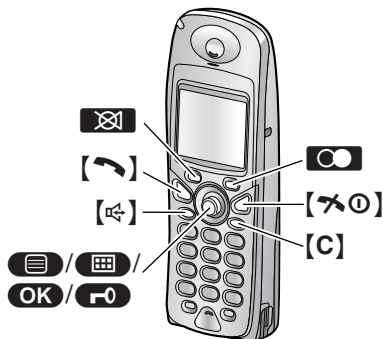

- 1 Lift the cordless handset and press [call icon] or [speakerphone icon].
- 2 Dial the telephone number.
- 3 When finished talking, press [call icon] or place the cordless handset on the charger.

Speakerphone operation

- For best performance, please note the following:
 - Use the speakerphone in a quiet environment.
 - Speak alternately with the caller.
 - If you or the other party have difficulty hearing each other, push the joystick up or down repeatedly to adjust the speaker volume as necessary.

To redial the last number dialed from the cordless handset

Press [call icon] or [speakerphone icon], then press [soft key].

To redial automatically

Press [speakerphone icon], then press [soft key].

- If the line is busy, the unit will automatically redial the number up to 9 times. While the cordless handset is redialling, mute is automatically turned ON.

Note:

- If mute does not turn OFF after the line is connected, press [mute icon].

To make a call using the redial list

The last 10 telephone numbers dialed from the cordless handset are stored in the redial list.

1. Press [soft key].
 - The last number dialed will be displayed.

2. Push the joystick up or down repeatedly to select the desired number.
 - To exit the list, press [call icon].
3. Press [call icon] or [speakerphone icon].

To edit a number in the redial list before calling it

1. Press [soft key].
2. Push the joystick up or down repeatedly to select the desired number, then press [call log icon].
3. Select "Edit for Call", then press [OK].
4. Use the joystick to move the cursor, then edit the number.
 - Place the cursor on the number you wish to erase, then press [C].
 - Place the cursor to the right of where you want to insert a number, then make the correction.
5. Press [call icon], [speakerphone icon], or [OK] to call.

To erase numbers in the redial list

1. Press [soft key].
2. Push the joystick up or down repeatedly to select the desired number, then press [call log icon].
3. Select "Delete", then press [OK].
 - If you want to erase all numbers in the list, select "Delete All", then press [OK].
4. Select "Yes", then press [OK].
5. Press [call icon].

To store a number from the redial list into the cordless handset phonebook

1. Press [soft key].
2. Push the joystick up or down repeatedly to select the desired number, then press [call log icon].
3. Select "Save Phonebook", then press [OK].
4. Enter a name, up to 16 characters (see page 88 for character entry), then press [OK].
5. Edit the telephone number if necessary, then press [OK].
6. Select the desired category (page 38), then press [OK] 2 times.
7. Press [call icon].

Key lock

The cordless handset can be locked so that no calls or settings can be made. Incoming calls can be answered, but all other functions are disabled while key lock is ON. Emergency calls (page 79) cannot be made until key lock is turned OFF.

4. Telephone

To turn key lock ON, press  (centre of joystick) for about 2 seconds.

-  will be displayed.

To turn key lock OFF, press  for about 2 seconds.

Note:

- Key lock is turned OFF when the cordless handset is turned OFF.

4.1.2 With the base unit

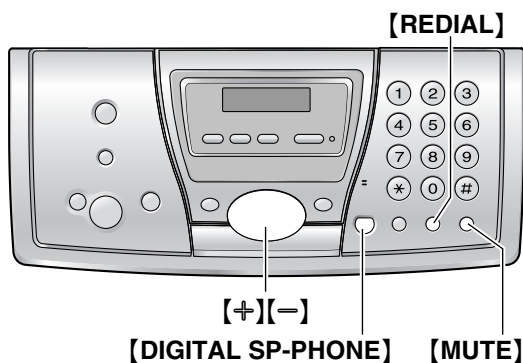

- 1 Lift the handset or press **[DIGITAL SP-PHONE]**.
- 2 Dial the telephone number.
- 3 When finished talking, replace the handset or press **[DIGITAL SP-PHONE]**.

Speakerphone operation

- For best performance, please note the following:
 - Use the speakerphone in a quiet environment.
 - Speak alternately with the caller.
 - If you or the other party have difficulty hearing each other, press **[+]** or **[-]** repeatedly to adjust the speaker volume as necessary.

To redial the last number dialed from the base unit

Lift the handset or press **[DIGITAL SP-PHONE]**, then press **[REDIAL]**.

To redial automatically

Press **[DIGITAL SP-PHONE]**, then press **[REDIAL]**.

- If the line is busy, the unit will automatically redial the number up to 9 times. While the base unit is redialling, mute is automatically turned ON.

Note:

- If mute does not turn OFF after the line is connected, press **[MUTE]**.

4.2 Answering phone calls

4.2.1 With the cordless handset

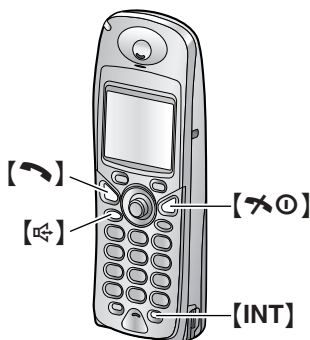

- 1 Lift the cordless handset and press [**hook**] or [**hook with arrow**].
 - You can also answer a call by pressing any dial key from [0] to [9], [*], [#] or [INT]. (Any key answer feature)
- 2 When finished talking, press [**X O**] or place the cordless handset on the charger.

Auto talk feature

You can answer calls simply by lifting the cordless handset off the charger. You do not need to press [**hook**]. To turn this feature ON, see page 76.

4.2.2 With the base unit

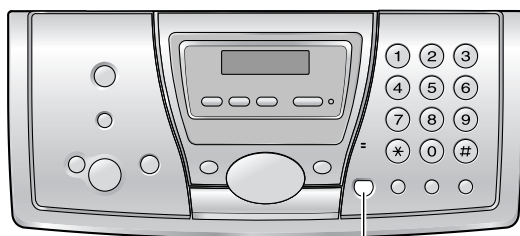

[DIGITAL SP-PHONE]

- 1 Lift the handset or press [**DIGITAL SP-PHONE**].
- 2 When finished talking, replace the handset or press [**DIGITAL SP-PHONE**].

4.3 Recording a telephone conversation (Cordless handset only)

You can record a telephone conversation using the cordless handset. Recorded conversations are treated as new messages. To listen to the recorded conversation, see page 58, 60.

- Keep the front cover page open for button locations.
- 1 Press **[hook]** (centre of joystick) during a conversation.
 - 2 Press **[OK]**.
 - A beep is heard and recording starts.
 - A beep sounds every 15 seconds and can be heard by the other party, but is not recorded.
 - 3 To stop recording, press **[hook]**.

Note:

- There may be legal restrictions on recording two-way telephone conversations. Inform the other party that the conversation is being recorded.

For Australian users:

- All persons using this device for recording telephone conversations shall comply with Australian law.

For New Zealand users:

- All persons using this device for recording telephone conversations shall comply with New Zealand law. This requires that at least one party to the conversation is to be aware that it is being recorded. In addition, the Principles enumerated in the Privacy Act 1993 shall be complied with in respect to the nature of the personal information collected, the purpose for its collection, how it is used and what is disclosed to any other party.

4.4 Cordless handset phonebook

The cordless handset phonebook allows you to make calls without having to dial manually. You can store 200 names and telephone numbers to the phonebook and search for phonebook items by name or category.

When the system has additional cordless handsets (page 81), each cordless handset can have its own phonebook. You can copy phonebook items between two cordless handsets (page 84).

- The base unit has its own individual phonebook (page 36).

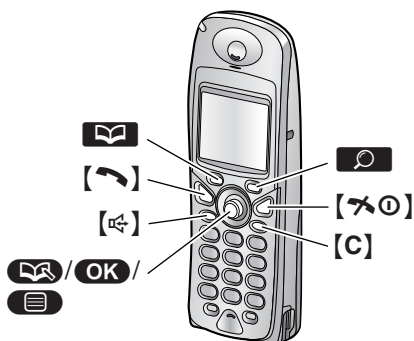

4.4.1 Storing phonebook items

- 1 Press (soft key).
- 2 Press .
 - The display shows the number of available items in the phonebook briefly.
- 3 Enter the name, up to 16 characters (see page 88 for character entry).
- 4 Press **OK**.
- 5 Enter the telephone number, up to 24 digits.
- 6 Press **OK**.
- 7 Select a category for the item, or select "OFF".
 - Caller ID service users can use additional private category features (page 38).
 - You can search for cordless handset phonebook items by category (page 35).
 - You can change the category names (page 75).
- 8 Press **OK** 2 times.
 - To program other items, repeat steps 3 to 8.

- 9 Press .

Note:

- If there is no space to store new items, "Memory Full" will be displayed. Erase unnecessary items (page 35).

To correct a mistake

1. Use the joystick to move the cursor to the incorrect character/number.
2. Press **[C]**.
 - To erase all characters/numbers, press and hold **[C]**.
3. Enter the correct character/number.

4.4.2 Making a phone call using the phonebook

Before using this feature, store the desired names and telephone numbers in the cordless handset phonebook (page 34).

- 1 Press (soft key).
- 2 Push the joystick up or down repeatedly to display the desired item.
 - You can also find an item using one of the search methods on page 34.
- 3 Press or .
 - The cordless handset will start dialling automatically.

To search for a name by initial

1. Press (soft key).
2. Press the dial key (**[0]** to **[9]**) which corresponds to the letter you are searching for (page 88).
 - Press the same dial key repeatedly to display the first item corresponding to each letter located on that dial key.
 - If there is no item corresponding to the letter you selected, the next item will be displayed.
3. Push the joystick up or down repeatedly to display the desired item.

To search for a name by first character (index search)

This method is useful when you are searching for an item which does not start with a letter of the alphabet.

1. Press (soft key).
2. Press .
3. Select "Index Search", then press **OK**.

4. Press the right soft key repeatedly to select the character entry mode that contains the character you are searching for (**ABC**, **ABГ** or **АБВ**).
5. Press the dial key (**[0]** to **[9]**) which contains the character you are searching for.
 - Press the same dial key repeatedly to select the character you are searching for.
6. Press **OK**.
 - The first item beginning with the character you selected is displayed. If there is no such item, the next item will be displayed.
7. Push the joystick down repeatedly to display the desired item.

To search for a name by category

1. Press **☰** (soft key).
2. Press **☰**.
3. Select “**Category**”, then press **OK**.
4. Select the category you want to search, then press **OK**.
 - The first item in that category is displayed.
 - If “**Memory Empty**” is displayed, the category you selected has no items.
5. Push the joystick down repeatedly to display the desired item.

4.4.3 Editing a stored item

- 1 Press **☰** (soft key).
- 2 Push the joystick up or down repeatedly to display the desired item.
 - You can also find an item using one of the search methods on page 34.
- 3 Press **☰**.
- 4 Select “**Edit**”, then press **OK**.
 - If you do not need to edit the name, skip to step 6.
- 5 Edit the name. For further details, see the storing procedure on page 34.
- 6 Press **OK**.
 - If you do not need to edit the telephone number, skip to step 8.
- 7 Edit the telephone number. For further details, see the storing procedure on page 34.
- 8 Press **OK**.
- 9 Select the category, or select “**off**”.
- 10 Press **OK** 2 times.
 - To edit other items, repeat steps 2 to 10.

- 11 Press **[*0]**.

4.4.4 Erasing a stored item

- 1 Press **☰** (soft key).
- 2 Push the joystick up or down repeatedly to display the desired item.
 - You can also find an item using one of the search methods on page 34.
- 3 Press **☰**.
- 4 Select “**Delete**”, then press **OK**.
- 5 Select “**Yes**”.
 - To cancel erasing, press **[*0]**.
- 6 Press **OK**.
- 7 Press **[*0]**.

4.4.5 Hot key

Cordless handset dial keys **[1]** to **[9]** can each be used as a hot key, allowing you to dial a number from the cordless handset phonebook by simply pressing a dial key.

Assigning an item to a hot key

1. Press **☰** (soft key).
2. Push the joystick up or down repeatedly to select the desired item.
 - You can also find an item using one of the search methods on page 34.
3. Press **☰**.
4. Select “**Reg. to Hot Key**”, then press **OK**.
5. Push the joystick up or down repeatedly to select a desired dialling button.
 - Dial keys which have been registered as a hot key already will have a **✓** next to them. You can overwrite previous hot keys if desired.
6. Press **OK** 2 times.
7. Press **[*0]**.



Note:

- If there are no items stored in the cordless handset phonebook when searching for the desired item, the display shows “**Memory Empty**”.

Making a call using a hot key

1. Press and hold the desired hot key (**[1]** to **[9]**).
 - You can view other hot key registrations by pushing the joystick up or down.
2. Press **[☎]** or **[☎]**.

Erasing a hot key

1. Press and hold the desired hot key ([1] to [9]) to display the telephone number.
2. Press  (centre of joystick).
3. Press .
4. Select "Yes", then press .

Note:

- The number erased from a hot key will not be deleted from the phonebook. To erase from the phonebook, see page 35.

4.5 Base unit phonebook

The base unit phonebook allows you to make calls without having to dial manually. You can store 100 names and telephone numbers to the phonebook.

- You can also send faxes using the base unit phonebook (page 45).
- The cordless handset has its own individual phonebook (page 34).

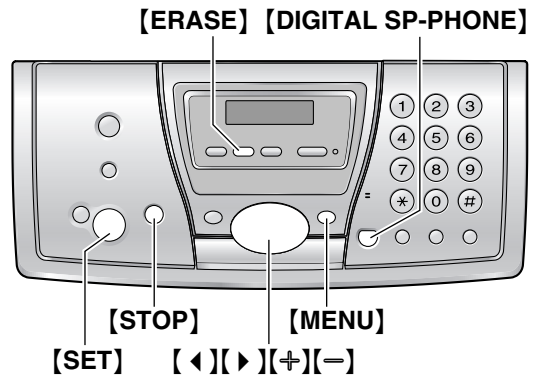

4.5.1 Storing phonebook items

- 1 Press **[MENU]** repeatedly to display "PHONEBOOK SET".
- 2 Press **[*]**.
 - The display shows the number of available items in the phonebook briefly.
- 3 Enter the name, up to 16 characters (see page 28 for instructions).
- 4 Press **[SET]**.
- 5 Enter the telephone number, up to 24 digits.
- 6 Press **[SET]**.
 - To program other items, repeat steps 3 to 6.
- 7 Press **[MENU]**.

Helpful hints:

- You can confirm the stored items by printing the telephone number list (page 106).

To correct a mistake

1. Press **[◀]** or **[▶]** to move the cursor to the incorrect character/number.
2. Press **[STOP]**.
 - To erase all characters/numbers, press and hold **[STOP]**.
3. Enter the correct character/number.

4.5.2 Making a phone call using the phonebook

Before using this feature, store the desired names and telephone numbers in the base unit phonebook (page 36).

- 1 Press [**▶**].
- 2 Press [**+**] or [**-**] repeatedly to display the desired item.
- 3 Lift the handset or press [**DIGITAL SP-PHONE**].
 - The base unit will start dialling automatically.

To search for a name by initial

Example: "LISA"

1. Press [**▶**].
2. Press [**+**] or [**-**] to initiate the phonebook.
3. Press [**5**] repeatedly to display any name with the initial "L" (see the character table, page 28).
 - To search for symbols (not letters or numbers), press [**1**].
4. Press [**-**] repeatedly to display "LISA".
 - To stop the search, press [**STOP**].
 - To dial the displayed party, lift the handset or press [**DIGITAL SP-PHONE**].

4.5.3 Editing a stored item

- 1 Press [**▶**].
- 2 Press [**+**] or [**-**] repeatedly to display the desired item.
- 3 Press [**MENU**].
- 4 Press [*****].
 - If you do not need to edit the name, skip to step 6.
- 5 Edit the name. For further details, see the storing procedure on page 36.
- 6 Press [**SET**].
 - If you do not need to edit the telephone number, skip to step 8.
- 7 Edit the telephone number. For further details, see the storing procedure on page 36.
- 8 Press [**SET**].

4.5.4 Erasing a stored item

- 1 Press [**▶**].

- 2 Press [**+**] or [**-**] repeatedly to display the desired item.
- 3 Press [**MENU**].
- 4 Press [**⇄**].
 - To cancel erasing, press [**STOP**].
- 5 Press [**SET**].

Another method to erase a stored item

1. Press [**▶**].
2. Press [**+**] or [**-**] repeatedly to display the desired item.
3. Press [**ERASE**].
4. Press [**SET**].

4.6 Caller ID service

This unit is compatible with Caller ID service offered by your local telephone company. To use this feature, you must subscribe to Caller ID service.

4.6.1 How Caller ID is displayed

When an outside call is received, the calling party's telephone number or name will be displayed. You then have the option of whether or not to answer the call.

The unit will automatically store caller information (telephone number, name, date and time of the call) of the last 50 different callers. Caller information is stored by the most recent to the oldest call. When the 51st call is received, the oldest call is deleted.

Caller information can be viewed on the display one item at a time (page 39) or confirmed by printing the Caller ID list (page 106).

Note:

- When caller information is received and it matches a telephone number stored in the unit's phonebook:
 - The stored name will be displayed.
 - The cordless handset will use the ringer indicator colour and type assigned to the caller's category.
- If the unit is connected to a PBX (Private Branch Exchange) system, caller information may not be received properly. Consult your PBX supplier.
- If the unit cannot receive caller information, the following will be displayed:
 - “**OUT OF AREA**”/“**Out of Area**”: The caller dialed from an area which does not provide Caller ID service.
 - “**PRIVATE CALLER**”/“**Private Caller**”: The caller requested not to send caller information.

Note for Australian users:

- Although Telstra and Optus do not currently send caller name information, the caller's name will be displayed as stored in the directory, when a call from that caller is received.
- The area code will need to be stored with the 8-digit telephone number.

Note for New Zealand users:

- Although Telecom New Zealand and TelstraClear do not currently send caller name information, the caller's name will be

displayed as stored in the directory, when a call from that caller is received.

- Your telephone service provider may charge you for a local call when it is dialled with an area code prefix. If the charge for local call is unacceptable, only the 7-digits of the local number should be dialled from your telephone. Do not dial the “0” prefix or the area code digit.

To confirm caller information by printing the Caller ID list

- To print manually, see page 106.
- To print automatically after every 50 new calls, activate feature #26 (page 68).

Private category

Private categories can help you identify who is calling by using different ringer indicator colours and ringer types for different categories of callers.

You can assign items in the cordless handset phonebook to a category (page 34), change the category names (Friends, Family, etc., page 75), and search for phonebook items by category (page 35). When a call is received from a caller assigned to a category, the ringer indicator colour (page 75) and ringer type (page 74) you select is used.

Call Waiting Caller ID

This is a service of your service provider and will only operate if you have subscribed to this service. When you hear a call waiting tone during a conversation, the display will show the second caller's information. You can answer the second call, keeping the first call on hold. Please consult your service provider for details of this service.

Note:

- The second caller's information will not be displayed when:
 - the answering machine is recording an incoming message,
 - another telephone on the same line is in use, or
 - you are sending or receiving a fax document.

4.7 Viewing and calling back using caller information

You can easily view caller information and call back.

Important:

- Calling back will not be possible if the caller information does not include a telephone number.

Note:

- Telstra, Optus, Telecom New Zealand and TelstraClear do not currently send caller name information.

4.7.1 With the cordless handset

The display will show → and the number of new calls in standby mode.

Example:

```
H/set 1
→ 10 Calls
17.8 10:59
```

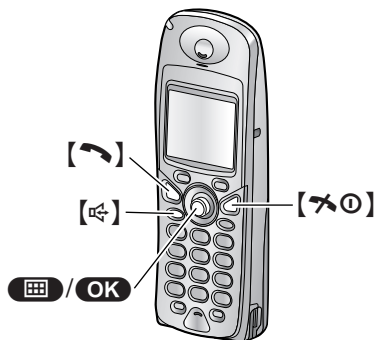

- 1 Press **[OK]** (centre of joystick).
- 2 Select **[→]**, then press **[OK]**.
 - The most recent call is displayed.
- 3 Push the joystick down repeatedly to search from the most recently received caller information.
 - If you push the joystick up repeatedly, the display order will be reversed.
 - A ✓ is displayed next to items which have already been viewed or answered, even if they were viewed or answered using the base unit or another cordless handset.
- 4 Press **[hook]** or **[hook]** to return the call.

- The cordless handset will start dialling automatically.

Display while viewing

- When no calls have been received, the display will show "Memory Empty".

To stop viewing

Press **[hook]** after step 3.

4.7.2 With the base unit

The display will show the number of new calls in standby mode.

Example:

10 NEW CALLS 10:59

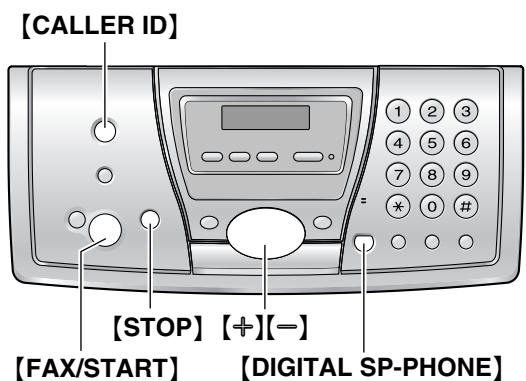

- 1 Press **[CALLER ID]**.
 - The most recent call is displayed.
- 2 Press **[−]** to search from the most recently received caller information.
 - If you press **[+]**, the display order will be reversed.
- 3 Lift the handset or press **[DIGITAL SP-PHONE]** to return the call.
 - The unit will start dialling automatically.
 - To send a fax, insert the document FACE DOWN and press **[FAX/START]**.

To change the way caller information is displayed

Press **[CALLER ID]** repeatedly after step 2.

Example:

3456789012 20 Jul.11:20 ✓
↑↓
SAM LEE 20 Jul.11:20 ✓

- A ✓ on the display means the item has already been viewed or answered, even if it was viewed or answered using a cordless handset.

4. Telephone

Display while viewing

- When the unit could not receive a name, the display will show “**NO NAME RCVD**”.
- When no calls have been received, the display will show “**MEMORY EMPTY**”.

To stop viewing

Press [**STOP**] after step 2.









4.8 Editing a caller's telephone number before calling back / storing

- Keep the front cover page open for button locations.

Note:

- Telstra, Optus, Telecom New Zealand and TelstraClear do not currently send caller name information.

4.8.1 With the cordless handset

- 1 Press  (centre of joystick).
- 2 Select , then press .
- 3 Push the joystick up or down repeatedly to display the desired item, then press .
- 4 Select “**Edit for Call**”, then press .
- 5 Use the joystick to move the cursor, then edit the number.
 - Place the cursor on the number you wish to erase, then press [**C**].
 - Place the cursor to the right of where you want to insert a number, then make a correction.
- 6 Press [, , or  to call back the edited number.

Note:

- The edited telephone number will not be saved as caller information. To store it into the cordless handset phonebook, see page 41.

4.8.2 With the base unit

- 1 Press [**CALLER ID**].
- 2 Press [**+**] or [**-**] repeatedly to display the desired item.
- 3 Press [**CALLER ID**] repeatedly to display the telephone number.

- 4 To insert a number in front of the telephone number, press the desired dial key ([**0**] to [**9**]).
 - You can also initiate the editing mode by pressing [*****].
- 5 Lift the handset or press [**DIGITAL SP-PHONE**] to call back the edited number.
 - The unit will start dialling automatically.
 - To send a fax, insert the document **FACE DOWN** and press [**FAX/START**].

Note:

- The edited telephone number will not be saved as caller information. To store it into the base unit phonebook, see page 41.

To correct a mistake

1. Press [**◀**] or [**▶**] to move the cursor to the incorrect number.
2. Press [**STOP**] to delete the number.
3. Enter the correct number.

To delete a number

Press [**◀**] or [**▶**] to move the cursor to the number you want to delete and press [**STOP**].

To insert a number

1. Press [**◀**] or [**▶**] to move the cursor to the position to the right of where you want to insert the number.
2. Enter the number.







4.9 Erasing caller information

- Keep the front cover page open for button locations.

Note:

- Telstra, Optus, Telecom New Zealand and TelstraClear do not currently send caller name information.

4.9.1 With the cordless handset

- 1 Press  (centre of joystick).
- 2 Select , then press .
- 3 Push the joystick up or down repeatedly to display the desired item, then press .
- 4 To erase the selected item, select “**Delete**”, then press . To erase all items, select “**Delete All**”, then press .
- 5 Select “**Yes**”, then press .

6 Press [**✕**].

4.9.2 With the base unit

Erasing all caller information

1. Press [**MENU**] repeatedly to display "CALLER SETUP".
2. Press [**SET**].
 - "CALL LIST ERASE" will be displayed.
3. Press [**SET**].
 - To cancel erasing, press [**STOP**] 3 times.
4. Press [**SET**].
5. Press [**STOP**].

Erasing specific caller information

1. Press [**CALLER ID**].
2. Press [**+**] or [**-**] repeatedly to display the desired item.
3. Press [**◀**].
 - To cancel erasing, press [**STOP**] 2 times.
4. Press [**SET**].
 - To erase other items, repeat steps 2 to 4.
5. Press [**STOP**].

Another method to erase a specific caller information

1. Press [**CALLER ID**].
2. Press [**+**] or [**-**] repeatedly to display the desired item.
3. Press [**ERASE**].
 - To erase other items repeat steps 2 to 3.
4. Press [**STOP**].

4.10 Storing caller information into the phonebook

- Keep the front cover page open for button locations.



Important:

- This feature is not available if the caller information does not include a telephone number.

Note:

- Telstra, Optus, Telecom New Zealand and TelstraClear do not currently send caller name information.

4.10.1 Into the cordless handset phonebook

- 1 Press  (centre of joystick).
- 2 Select , then press **OK**.
- 3 Push the joystick up or down repeatedly to display the desired item.
- 4 Press .
- 5 Select "Save Phonebook", then press **OK**.
- 6 If a name is required, enter up to 16 characters for the name (page 88).
- 7 Press **OK** 2 times.
- 8 Select the category, or select "off".
- 9 Press **OK** 2 times.
- 10 Press [**✕**].

Note:

- To edit a name and number, see page 35.
- If there is no space to store new items, "Memory Full" will be displayed. Erase unnecessary items (page 35).

4.10.2 Into the base unit phonebook

- 1 Press [**CALLER ID**].
- 2 Press [**+**] or [**-**] repeatedly to display the desired item.
- 3 Press [**MENU**].
- 4 If a name is required, enter up to 16 characters for the name (page 28).

4. Telephone

5 Press [SET].

6 Press [SET].

Note:

- You can confirm the stored items in the base unit phonebook by printing the telephone number list (page 106).
- To edit a name and number, see page 37.

4.10.3 Call minder (for New Zealand users only)

Call minder is an automatic answering service offered by your service provider. If you subscribe to this service, your service provider's call minder system can answer calls for you when you are unavailable to answer the phone or when your line is busy.

Messages are recorded by the service provider, not your telephone.

When you have new messages,  will be displayed on the handset.

Please consult your service provider for detail of this service.

Note:

- If  still remains on the display even after you have listened to new messages, turn it off by pushing and holding the joystick left for 2 seconds.

5.1 Sending a fax manually

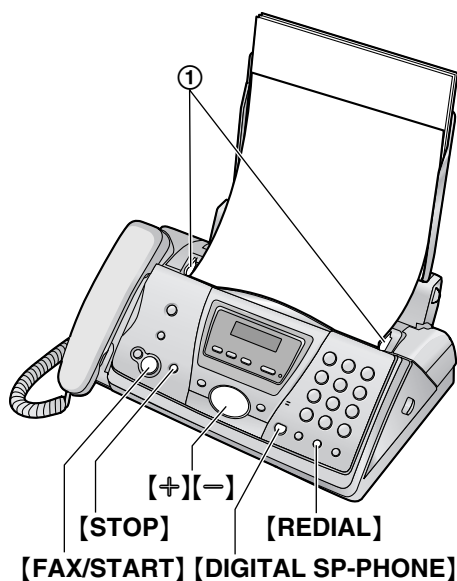

- 1 Adjust the width of the document guides (①) to fit the actual size of the document.
- 2 Insert the document (up to 10 pages) FACE DOWN until a single beep is heard and the unit grasps the document.
 - If the document guides are not adjusted to fit the document, re-adjust them.
- 3 If necessary, press **[+]** or **[-]** repeatedly to select the desired resolution.
- 4 Lift the handset or press **[DIGITAL SP-PHONE]**.
- 5 Dial the fax number.
- 6 **When a fax tone is heard:**
Press **[FAX/START]**.

When the other party answers your call:

Ask them to press their start button. When the fax tone is heard, press **[FAX/START]**.

Note:

- After pressing **[FAX/START]**, you can replace the handset.

To select the resolution

Select the desired resolution according to the type of document.

- **“STANDARD”**: For printed or typewritten documents with normal-sized characters.
- **“FINE”**: For documents with small print.

- **“SUPER FINE”**: For documents with very small print. This setting is effective only when the other party has a compatible fax machine.
- **“PHOTO”**: For documents containing photographs, shaded drawings, etc.
 - Using the **“FINE”**, **“SUPER FINE”** and **“PHOTO”** settings will increase transmission time.
 - If the resolution setting is changed during feeding, it will be effective from the next page.

To redial the last number

1. Press **[REDIAL]**.
2. Press **[FAX/START]**.
 - If the line is busy, the unit will automatically redial the number up to 2 times.
 - To cancel redialling, press **[STOP]**.

To send more than 10 pages at a time

Insert the first 10 pages of the document. Add the other pages (up to 10 at a time) on top of the previously inserted pages before the last page feeds into the unit.

To predial a fax number

You can dial the fax number first before inserting the document. This is convenient if you need to refer to the document for the other party's fax number.

1. Enter the fax number.
2. Insert the document.
3. Press **[FAX/START]**.

To send from memory (Quick scan feature)

You can scan the document into memory before sending. To use this feature, activate feature #34 (page 68) beforehand.

1. Insert the document.
2. Enter the fax number.
3. Press **[FAX/START]**.
 - The document will be fed into the unit and scanned into memory. The unit will then transmit the data. If the document exceeds the memory capacity, sending will be cancelled and this feature will be turned OFF automatically. You must send the entire document manually.
 - This feature cannot be used if the handset is in use, or **[DIGITAL SP-PHONE]** on the base unit, **[↶]** or **[↷]** on the cordless handset is pressed.

5. Fax

To stop transmission

Press **[STOP]**.

Printing a sending report

A sending report provides you with a printed record of transmission results. To print sending reports, make sure feature #04 is activated (page 66). For an explanation of error messages, see page 90.

Printing a journal report

A journal report provides you with a printed record of the 30 most recent faxes. To print manually, see page 106. To print automatically after every 30 new fax transmissions and receptions, make sure feature #22 is activated (page 67). For an explanation of error messages, see page 90.

5.2 Documents you can send

Minimum document size

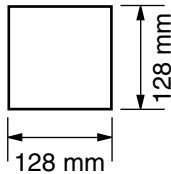

Maximum document size

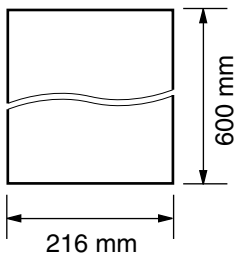

Effective scanning area

- Shaded area will be scanned.

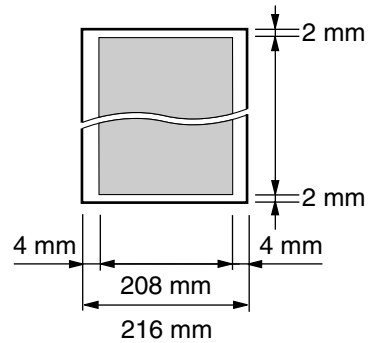

Document weight

- Single sheet: 45 g/m² to 90 g/m²
- Multiple sheets: 60 g/m² to 80 g/m²

Note:

- Remove clips, staples or other fasteners.
- Do not send documents that are on the following types of paper: (Make a copy of the document and send the copy.)
 - Chemically treated paper such as carbon or carbonless duplicating paper
 - Electrostatically charged paper
 - Badly curled, creased or torn paper
 - Paper with a coated surface
 - Paper with a faint image
 - Paper with printing on the opposite side that can be seen through the other side, such as newsprint.
- Check that ink, paste or correction fluid has dried completely.
- To send a document with a width of less than 210 mm, we recommend using a copy machine to copy the original document onto A4 or letter-sized paper, then sending the copied document.

5.3 Sending a fax using the base unit phonebook

Before using this feature, store the desired names and telephone numbers into the base unit phonebook (page 36).

- Keep the front cover page open for button locations.
- 1 Adjust the width of the document guides to fit the actual size of the document.
 - 2 Insert the document (up to 10 pages) FACE DOWN until a single beep is heard and the unit grasps the document.
 - If the document guides are not adjusted to fit the document, re-adjust them.
 - 3 If necessary, press **[+]** or **[-]** repeatedly to select the desired resolution (page 43).
 - 4 Press **[▶]**.
 - 5 Press **[+]** or **[-]** repeatedly to display the desired item and press **[FAX/START]**.

Fax auto redial

If the line is busy or if there is no answer, the unit will automatically redial the number up to 2 times.

- To cancel redialling, press **[STOP]**.

If your unit does not send a fax

- Confirm that you have entered the number correctly, and that the number is a fax number.
- Confirm that the other party's fax machine is answering by turning ON the connecting tone feature (feature #76 on page 69).

5.4 Broadcast transmission

By storing base unit phonebook items (page 36) into the broadcast memory, you can send the same document to multiple parties (up to 20). Your programmed items will remain in the broadcast memory, allowing frequent re-use.

- Keep the front cover page open for button locations.

5.4.1 Programming items into the broadcast memory

- 1 Press **[MENU]** repeatedly to display "PHONEBOOK SET".
- 2 Press **[#]**.
 - The number in brackets indicates the number of registered items.
- 3 Press **[+]** or **[-]** repeatedly to display the desired item.
- 4 Press **[SET]**.
 - To program other items, repeat steps 3 and 4 (up to 20 items).
- 5 Press **[SET]**.

Note:

- If you program the wrong item, press **[STOP]** after step 4 to erase the item.
- Confirm the stored items by printing a broadcast programming list (page 106).

5.4.2 Adding a new item into the broadcast memory

After initial programming, you can add new items (up to a combined total of 20).

- 1 Press **[▶]**.
- 2 Press **[+]** or **[-]** repeatedly to display "<BROADCAST>".
- 3 Press **[MENU]**.
- 4 Press **[*]**.
- 5 Press **[+]** or **[-]** repeatedly to display the desired item you want to add.
- 6 Press **[SET]**.
 - To add other items, repeat steps 5 and 6 (up to 20 items).
- 7 Press **[STOP]**.

5.4.3 Erasing a stored item from the broadcast memory

- 1 Press [▶].
- 2 Press [⊕] or [⊖] repeatedly to display "<BROADCAST>".
- 3 Press [MENU].
- 4 Press [⊞].
- 5 Press [⊕] or [⊖] repeatedly to display the desired item you want to erase.
 - To cancel erasing, press [STOP].
- 6 Press [SET].
- 7 Press [SET].
 - To erase other items, repeat steps 5 to 7.
- 8 Press [STOP].

5.4.4 Sending the same document to pre-programmed parties

- 1 Insert the document FACE DOWN.
- 2 If necessary, press [⊕] or [⊖] repeatedly to select the desired resolution (page 43).
- 3 Press [▶].
- 4 Press [⊕] or [⊖] repeatedly to display "<BROADCAST>".
- 5 Press [FAX/START].
 - The document will be fed into the unit and scanned into memory. The unit will then send the data to each party, calling each number sequentially.
 - After transmission, the stored document will be erased from memory automatically, and the unit will automatically print a report (**Broadcast sending report**).

Note:

- If you select "FINE", "SUPER FINE" or "PHOTO" resolution, the number of pages that the unit can send will decrease.
- If the document exceeds the memory capacity, sending will be cancelled.
- If a party is busy or does not answer, it will be skipped and redialled later up to 2 times.

To send the same document to a one-time group of parties

You can also select a one-time group of parties to send the same document to. After transmission, this group will be deleted.

1. Insert the document.
2. Press [▶].
3. Press [⊕] or [⊖] repeatedly to display "<ONE TIME BROAD>".
4. Press [SET] to start programming the parties you want to send the document to.
5. Press [⊕] or [⊖] repeatedly to display the desired party.
6. Press [SET].
 - To program other parties, repeat steps 5 and 6 (up to 20 items).
7. Press [FAX/START] to start transmission to the programmed parties.

To cancel broadcast transmission

1. Press [STOP] while "BROADCASTING" is displayed.
 - The display will show "SEND CANCELLED?".
2. Press [SET].

5.5 Selecting the way to use your fax machine

Depending on your situation, select the way you prefer to use your fax machine.

- Use as a telephone answering machine and/or fax (TAM/FAX mode)
- Use only as a fax (FAX ONLY mode)
- Use mostly as a telephone (TEL mode)

5.5.1 Use as a telephone answering machine and/or fax (TAM/FAX mode)

Your situation

You want to answer phone calls using the telephone answering machine and receive faxes automatically.

Setup

Set the fax machine to TAM/FAX mode (page 50) by pressing **[AUTO ANSWER]** repeatedly.

- The **[AUTO ANSWER]** indicator on the base unit turns ON and  (next to the battery icon) appears on the cordless handset display.

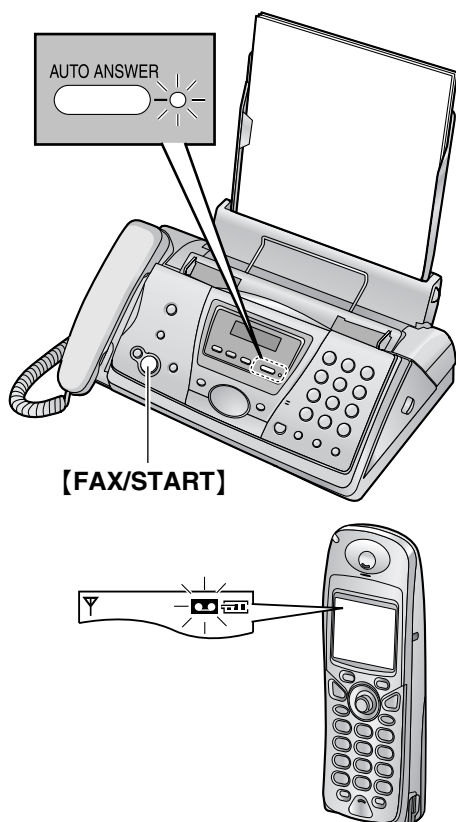

Note:

- Make sure feature #77 is set to “**TAM/FAX**” beforehand (page 70).
- Do not connect an answering machine to the same telephone line. If connected, set the automatic answer feature to OFF by pressing **[AUTO ANSWER]** repeatedly.

How phone calls and faxes are received

If the call is a phone call, the fax machine will record the caller's message automatically.

If a fax calling tone is detected, the fax machine will receive the fax automatically.

5.5.2 Use only as a fax (FAX ONLY mode)

Your situation

You have a separate telephone line just for faxes.

Setup

Set the fax machine to FAX ONLY mode (page 52) by pressing **[AUTO ANSWER]** repeatedly.

- The **[AUTO ANSWER]** indicator on the base unit turns ON and  (next to the battery icon) appears on the cordless handset display.

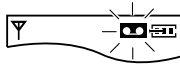
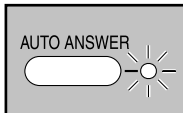

Note:

- Make sure feature #77 is set to "FAX ONLY" beforehand (page 70).

How faxes are received

All incoming calls will be answered as faxes.

5.5.3 Use mostly as a telephone (TEL mode)

Your situation

You want to answer calls by yourself. If a fax call is received, you must receive the fax manually.

Setup

Set the fax machine to TEL mode (page 49) by pressing **[AUTO ANSWER]** repeatedly.

- The **[AUTO ANSWER]** indicator on the base unit turns OFF and  (next to the battery icon) disappears from the cordless handset display.

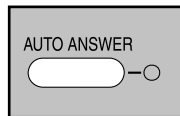

How to receive phone calls and faxes

You have to answer all calls manually.

To receive a fax, press **[FAX/START]**.

5.6 Receiving a fax manually – Auto answer OFF

5.6.1 Activating TEL mode

Set the fax machine to TEL mode by pressing **[AUTO ANSWER]** repeatedly to display the following.

TEL MODE



- The **[AUTO ANSWER]** indicator on the base unit turns OFF and  (next to the battery icon) disappears from the cordless handset display.

Note:

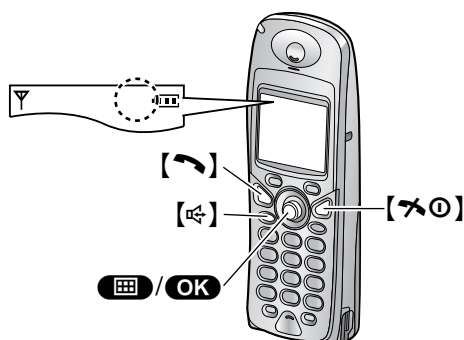
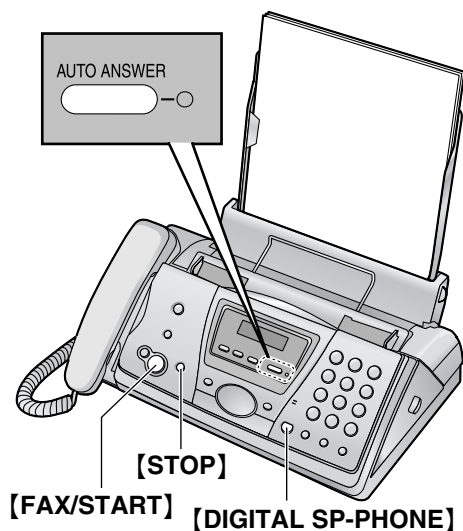
- By default, the unit reduces the size of the received document to 92% when printing (See feature #36 on page 68 for details).



Activating TEL mode with the cordless handset

1. Press  (centre of joystick).
2. Select , then press **[OK]**.
3. Select "Answer Off", then press **[OK]**.
4. Press **[*0]**.



How to receive phone calls and faxes with the base unit

1. Lift the handset or press **[DIGITAL SP-PHONE]** to answer the call.
2. When:
 - document reception is required,
 - a fax calling tone (slow beep) is heard, or
 - no sound is heard,
 press **[FAX/START]**.

CONNECTING

- The unit will start fax reception.
3. Replace the handset if using it.

How to receive phone calls and faxes with the cordless handset

1. Lift the cordless handset and press  or  to answer the call.
2. When:
 - document reception is required,
 - a fax calling tone (slow beep) is heard, or
 - no sound is heard,
 press **[*][#][9]** (default fax activation code) **firmly**.
 - You can also press **[FAX/START]** on the base unit.

Note:

- To receive fax documents using the cordless handset, make sure remote fax activation is turned ON beforehand (feature #41 on page 69). The default setting is ON.

How to receive phone calls and faxes with an extension telephone

If you have another telephone connected to the same line (extension telephone), you can use the extension telephone to receive faxes.

1. When the extension telephone rings, lift the handset of the extension telephone.
2. When:
 - document reception is required,
 - a fax calling tone (slow beep) is heard, or
 - no sound is heard,

5. Fax

press **[*][#][9]** (default fax activation code) **firmly**.

- The fax machine will start fax reception.

3. Replace the handset.

Note:

- To receive fax documents using the extension telephone, make sure remote fax activation is turned ON beforehand (feature #41 on page 69). The default setting is ON.

To stop receiving

Press **[STOP]**.

5.7 Receiving a fax automatically – Auto answer ON

5.7.1 Activating TAM/FAX mode

- 1 Make sure feature #77 is set to **“TAM/FAX”** beforehand (page 70).
- 2 Press **[AUTO ANSWER]** repeatedly to display the following.

TAM/FAX MODE



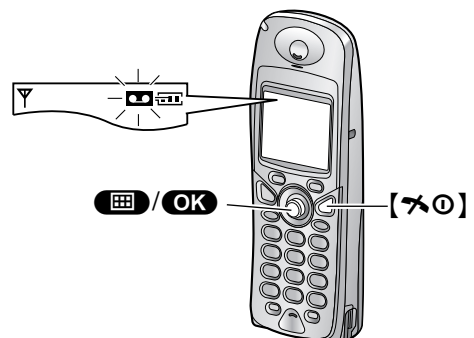
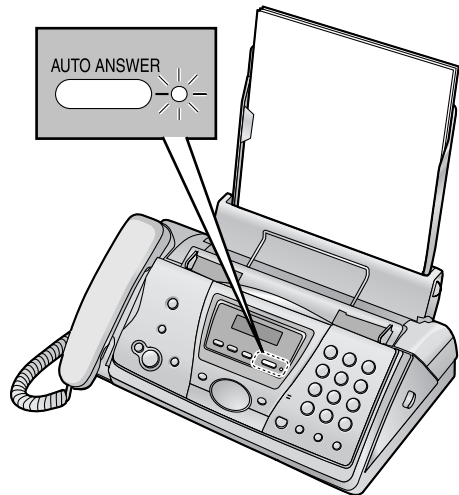

- The **[AUTO ANSWER]** indicator on the base unit turns ON and  (next to the battery icon) appears on the cordless handset display.
- The remaining time for recording incoming messages will be displayed.
- The unit will announce the remaining recording time if it is less than 5 minutes.



Note:

- The maximum recording time for incoming message can be changed (page 61, or feature #10 on page 66).
- While an incoming call is being recorded, you can monitor it through the speaker.
- If the unit announces the memory is full, erase unnecessary messages (page 58, 60).

Activating TAM/FAX mode with the cordless handset

1. Press  (centre of joystick).
2. Select , then press **OK**.
3. Select “Answer On”, then press **OK**.
4. Press [][].

Note:

- Make sure feature #77 is set to “TAM/FAX” beforehand (page 70).

How phone calls and faxes are received

When receiving calls, the unit works as an answering machine and/or fax.

- If the call is a phone call, the unit will record the caller's message automatically.
- If a fax calling tone is detected, the unit will receive the fax automatically.

Note:

- By default, the unit reduces the size of the received document to 92% when printing (See feature #36 on page 68 for details).

Receiving a voice message and fax document in one call

The caller can leave a voice message and send a fax document during the same call. Inform the caller of the following procedure beforehand.

1. The caller calls your unit.
 - The answering machine will answer the call.
2. The caller can leave a message after the greeting message.
3. The caller presses [][**9**].
 - The unit will activate the fax function.
4. The caller presses the start button to send a fax.

Ring setting in TAM/FAX mode

You can change the number of rings before the unit answers calls. You can choose from “2” (default), “3”, “4”, “5”, “6”, “7” and “AUTO”. This setting can be changed by feature #06 on page 66.

“AUTO”: The unit answers after 2 or 3 rings when new messages have been recorded, and after 5 or 6 rings when there are no new messages. If you call your unit from outside to listen to new messages (page 63), you will know that there are no messages when the unit rings for the 4th time. You can then hang up without being charged for the call.

Note:

- You can also program this feature with the cordless handset (page 61).

5.7.2 Activating FAX ONLY mode



- 1 Make sure feature #77 is set to “**FAX ONLY**” beforehand (page 70).
- 2 Press **[AUTO ANSWER]** repeatedly to display the following.

FAX ONLY MODE

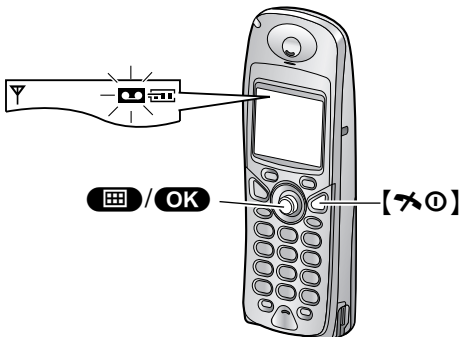
- The **[AUTO ANSWER]** indicator on the base unit turns ON and  (next to the battery icon) appears on the cordless handset display.



Activating FAX ONLY mode with the cordless handset

1. Press  (centre of joystick).
2. Select , then press **OK**.
3. Select “**Answer On**”, then press **OK**.
4. Press **[*0]**.

Note:

- Make sure feature #77 is set to “**FAX ONLY**” beforehand (page 70).

How faxes are received

When receiving calls, the unit will automatically answer all calls and only receive fax documents.

Note:

- The number of rings before a call is answered in FAX ONLY mode can be changed (feature #06 on page 66).
- By default, the unit reduces the size of the received document to 92% when printing (See feature #36 on page 68 for details).

5.8 Receive polling (retrieving a fax placed on another fax machine)

This feature allows you to retrieve a document from another compatible fax machine. Therefore you pay for the call.

Make sure that no documents are fed into your unit and that the other party's machine is ready for your call.

- Keep the front cover page open for button locations.

- 1 Press **[MENU]** repeatedly to display “**POLLING**”.
- 2 Press **[SET]**.
- 3 Dial the fax number.
- 4 Press **[SET]**.
 - The unit will start fax reception.

5.9 Junk fax prohibitor (preventing fax reception from undesired callers)

If you subscribe to Caller ID service, this feature prevents fax reception from calls that do not show caller information.

Additionally, you can store undesirable phone numbers in the junk fax prohibitor list; faxes sent from these phone numbers will not be received by your fax machine.

- Keep the front cover page open for button locations.

Important:

- This feature does not work when:
 - the unit is set to the TEL mode, or
 - manual reception is performed.

5.9.1 Activating the junk fax prohibitor

- 1 Press **[MENU]** repeatedly to display “**JUNK FAX PROH.**”.
- 2 Press **[▶]**.
- 3 Press **[+]** or **[=]** repeatedly to select “**ON**”.
- 4 Press **[SET]**.
- 5 Press **[MENU]**.
 - While the junk fax prohibitor is activated, “**JUNK FAX ON**” is displayed.

5.9.2 Storing undesired callers

You can register up to 10 undesired numbers from the Caller ID list (page 38) if you do not wish to receive faxes from them.

- 1 Press **[MENU]** repeatedly to display “**JUNK FAX PROH.**”.
- 2 Press **[▶]** repeatedly to display “**JUNK LIST SET**”.
- 3 Press **[SET]**.
- 4 Press **[+]** or **[=]** repeatedly to display the party you wish to prevent fax reception from.
- 5 Press **[SET]**.
 - To program other parties, repeat steps 4 to 5.
- 6 Press **[STOP]** to exit the program.

Note:

- If there is no space to store new items, “**LIST FULL**” is displayed in step 3 or step 5. Erase unnecessary items.

To display the junk fax prohibitor list

1. Press **[MENU]** repeatedly to display “**JUNK FAX PROH.**”.
2. Press **[▶]** repeatedly to display “**JUNK LIST DISP.**”.
3. Press **[SET]**.
4. Press **[+]** or **[=]** repeatedly to display the items on the list.
5. Press **[MENU]** to exit the program.

To print the junk fax prohibitor list

1. Press **[MENU]** repeatedly to display “**JUNK FAX PROH.**”.
2. Press **[▶]** repeatedly to display “**JUNK LIST PRINT**”.
3. Press **[SET]**.
4. Press **[MENU]** to exit the list.

To erase an item from the junk fax prohibitor list

1. Press **[MENU]** repeatedly to display “**JUNK FAX PROH.**”.
2. Press **[▶]** repeatedly to display “**JUNK LIST DISP.**”.
3. Press **[SET]**.
4. Press **[+]** or **[=]** repeatedly to display the desired item.
5. Press **[◀]**.
 - To cancel erasing, press **[STOP]**, then press **[MENU]**.
6. Press **[SET]**.
 - The item is erased.
 - To erase other items, repeat steps 4 to 6.
7. Press **[MENU]** to exit the list.

6.1 Using with the ring detection feature

This feature is only for use if you subscribe to a Distinctive Ring pattern service from your telephone company. For more information on the availability of this service in your area, please contact your telephone company before setting this feature on your unit.

In Australia, this service is called “Fax Stream Duet”.

In New Zealand, this service is called “FaxAbility”.

The Distinctive Ring service gives you an additional phone number on a single telephone line, with a different ringing pattern.

When you wish to use the additional phone number as a facsimile telephone number, set the ring pattern detection feature to ON. When the unit detects a call matching the Distinctive Ring pattern, it will receive a fax automatically.

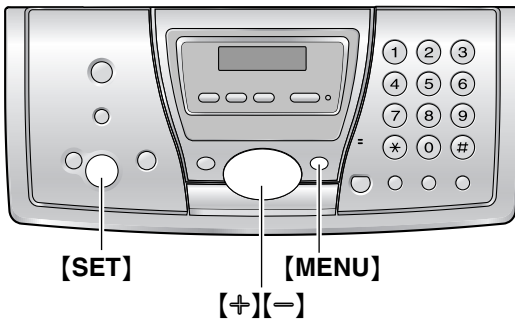

- 1 Press **[MENU]**.
- 2 Press **[#]**, then **[3][1]**.
- 3 Press **[+]** or **[-]** to select “ON”.
 - If this feature is not required, select “OFF”.
- 4 Press **[SET]**.
- 5 Press **[MENU]**.

7.1 Making a copy

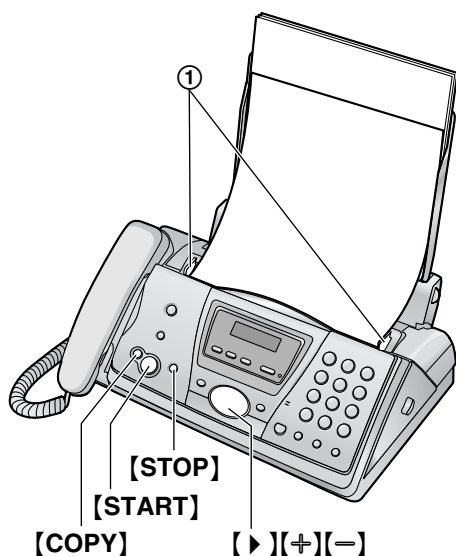

- 1 Adjust the width of the document guides (①) to fit the actual size of the document.
- 2 Insert the document (up to 10 pages) FACE DOWN until a single beep is heard and the unit grasps the document.
 - If the document guides are not adjusted to fit the document, re-adjust them.
- 3 If necessary, press **[+]** or **[−]** repeatedly to select the desired resolution.
- 4 Press **[COPY]**.
 - If necessary, enter the number of copies (up to 30).
- 5 Press **[START]**, or wait for 15 seconds.
 - The unit will start copying.

Note:

- Any document which can be sent as a fax can also be copied (page 44).

To select the resolution

Select the desired resolution according to the type of document.

- “**FINE**”: For printed or typewritten documents with small print.
- “**SUPER FINE**”: For documents with very small print.
- “**PHOTO**”: For documents containing photographs, shaded drawings, etc.
- If you select “**STANDARD**”, copying will be done using “**FINE**” mode.

Quick scan feature

This feature is helpful when you want to copy the document, then remove it for other uses. To use this feature, activate feature #34 (page 68) beforehand. The default setting is OFF.

- The document will be fed into the unit and scanned into memory. The unit will then print the data.
- If the document exceeds the memory capacity, copying of the exceeded document will be cancelled and this feature will be turned OFF automatically.

To stop copying

Press **[STOP]**.

7.1.1 More copying features

To enlarge a document

1. Insert the document, then press **[COPY]**.
2. Press **[▶]**.
3. Press **[+]** repeatedly to select “150%” or “200%”, then press **[START]**.
 - The unit will only enlarge the centre of the upper part of the document. To make an enlarged copy of the bottom of the document, turn the document around, and then make a copy.

Example: 150% enlarged copy

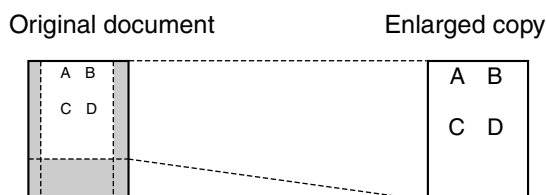

To reduce a document

1. Insert the document, then press **[COPY]**.
2. Press **[▶]**.
3. Press **[−]** repeatedly to select “92%”, “86%” or “72%”, then press **[START]**.

Setting	Recording paper size	Original document size
“100%” (default)	A4	A4, Letter
“92%”	A4	A4
“86%”	A4	A4
“72%”	A4	Legal

7. Copy

A4 = 210 mm × 297 mm

Legal = 216 mm × 356 mm

Letter = 216 mm × 279 mm

Note:

- If the appropriate reduction rate is not selected, the document may be divided and the top of the second sheet will be deleted.
- If the image at the bottom of the document is not copied when you copy a document that is the same length as the recording paper, try 92% or 86%.

To collate multiple copies

The unit can collate multiple copies in the same order as the original document pages.

1. Insert the document, then press **[COPY]**.
2. Enter the number of copies (up to 30).
3. Press **[▶]** 2 times to display “**COLLATE OFF**”.
4. Press **[+]** or **[-]** repeatedly to display “**COLLATE ON**”.
5. Press **[START]**.

Example: Making 2 copies of a 4-page original document

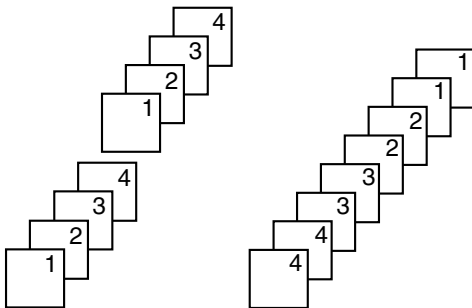

Collated pages

Uncollated pages

Note:

- The unit will store the documents into memory while collating the copies. If memory becomes full while storing, the unit will only print out the stored pages.
- After copying, the collating feature will turn OFF automatically.
- If the unit has run out of recording paper, the unit will scan the document but will not print, and the data will not be stored in the memory. Insert more paper, press **[START]**, then try copying again.

8.1 Recording your greeting message

You can record your own greeting message for TAM/FAX mode, for a maximum of 16 (default) or 60 seconds in length. We recommend you record a message of less than 12 seconds to make it easier to receive faxes.

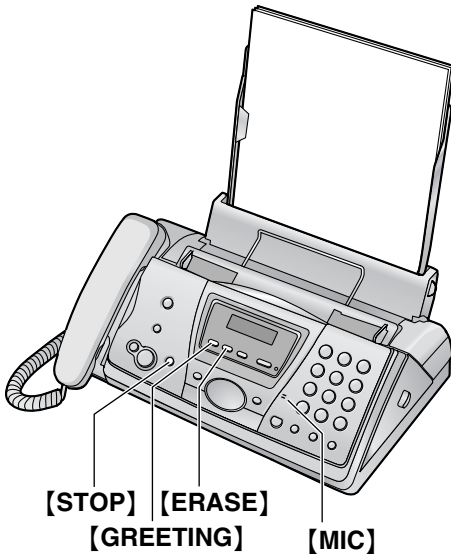

- 1 Press and hold **[GREETING]** until the unit announces you to start recording.
 - A long beep will sound.
- 2 Speak clearly about 20 cm away from **[MIC]**.
 - The display will count up the recording time.
- 3 To stop recording, press **[GREETING]**.
 - The unit will repeat your message.
 - You can also stop recording by pressing **[STOP]**.

Note:

- You can change the maximum TAM/FAX greeting message recording time to 60 seconds (feature #54 on page 69).
 - If you change the setting to 60 seconds, we recommend that you tell the caller in your TAM/FAX greeting message to press **[*][9]** before starting fax transmission.
 - If you change the setting from 60 seconds to 16 seconds, your greeting message will be deleted. The pre-recorded greeting message will be played when a call is received.

To check the greeting message

Press **[GREETING]**.

- The unit will play the greeting message.

8.1.1 Erasing your recorded greeting message

Press **[GREETING]**, and then press **[ERASE]** while your greeting message is played.

Note:

- If you erase your TAM/FAX greeting message, the pre-recorded greeting message will be played when a call is received.

8.1.2 Pre-recorded greeting message

If you do not record a greeting message, one of two pre-recorded messages will be played when a call is received, depending on the caller's recording time (page 61, or feature #10 on page 66).

To check the pre-recorded greeting, press **[GREETING]**.

- When the recording time is set to “1 MINUTE”/“1 Minute” or “NO LIMIT”/“No Limit”, the unit will play a greeting message asking callers to send faxes or leave messages.
- When the recording time is set to “GREETING ONLY”/“Greeting Only”, the unit will play a greeting message asking callers to call again.

8.2 Listening to recorded messages

When the unit has recorded new voice messages:

- The **[AUTO ANSWER]** indicator will flash when the auto answer setting is turned ON.
- The total number of recorded messages will flash on the base unit display.

Example:

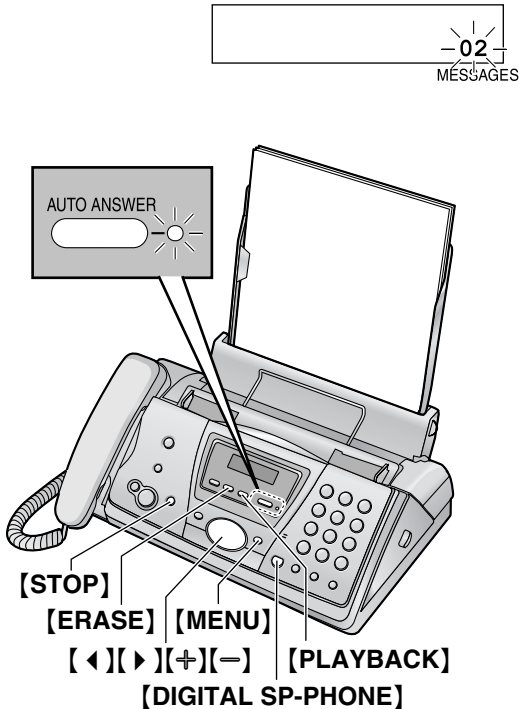

Press **[PLAYBACK]**.

- Only new messages will be played.
- Adjust the speaker volume using **[+]** or **[-]**.
- After playing back all of the new messages;
 - the **[AUTO ANSWER]** indicator will stop flashing but will remain lit up when the auto answer setting is turned ON.
 - the total number of recorded messages will stop flashing and remain displayed. If you press **[PLAYBACK]** at this time, all recorded messages will be played.
- At the end of the last message, the unit will announce the remaining recording time if it is less than 5 minutes.
- If the unit announces that the memory is full after playback, erase unnecessary messages (page 58, 60).

Note:

- The total recording time of all messages (greeting, incoming and memo) is **about 30 minutes**. A maximum of 64 messages (incoming and memo) can be recorded. If messages are recorded in noisy environment, the actual recording time may be less.

To repeat a message

Press **[◀]** while listening to the message.

- If you press **[◀]** within 5 seconds of the beginning of the message, the previous message will be played.
- To play back a specific message, press **[◀]** or **[▶]** and search for the message you want to listen to.

To skip a message

Press **[▶]** to play the next message.

To stop playback temporarily

Press **[STOP]**.

- If you press **[PLAYBACK]** within 1 minute, the unit will resume playing the rest of the messages.

Voice time/day stamp

During playback, the unit will announce the day of the week and time that each message was recorded.

If you subscribe to Caller ID service

During playback, the display shows the name and/or number of the caller whose message is being played.

You can call back the displayed number using the base unit.

1. Press **[MENU]** during playback.
 - The base unit stops playback.
 - If you do not need to edit the telephone number, skip to step 3.
2. Edit the telephone number (page 40).
3. Lift the handset or press **[DIGITAL SP-PHONE]**.
 - The base unit automatically dials the telephone number.

8.2.1 Erasing recorded messages

To erase a specific message

Press **[ERASE]** while listening to the message you want to erase.

To erase all messages

- 1 Press **[ERASE]**.
- 2 Press **[ERASE]**.
 - To cancel erasing, press **[STOP]**.

8.3 Leaving a message for others or yourself

To leave a private message for yourself or someone else, you can record a voice memo. Recorded messages are treated as new messages. To listen to the recorded messages, see page 58, 60.

- Keep the front cover page open for button locations.
- 1 Press **[MENU]** repeatedly to display "RECORD MEMO".
 - 2 Press **[SET]**.
 - A long beep will sound.
 - 3 Speak clearly about 20 cm away from **[MIC]**.
 - 4 To stop recording, press **[STOP]**.

8.4 Using the answering machine with the cordless handset

Helpful hints:

- To activate TAM/FAX mode with the cordless handset, see page 51.

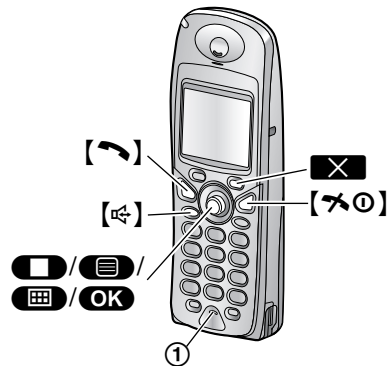

8.4.1 Recording your greeting message

- 1 Press **[]** (centre of joystick).
- 2 Select **[]**, then press **[OK]**.
- 3 Select "Record", then press **[OK]**.
- 4 Select "Record OGM", then press **[OK]**.
- 5 Hold the cordless handset about 20 cm away and speak clearly into the microphone (①).
- 6 To stop recording, press **[]**.
 - The greeting message is played back.
- 7 Press **[]**.

To check the greeting message

1. Press **[]** (centre of joystick).
2. Select **[]**, then press **[OK]**.
3. Select "Play OGM", then press **[OK]**.
 - The greeting message is played back.
4. Press **[]**.

To erase your recorded greeting message

1. Press **[]** (centre of joystick).
2. Select **[]**, then press **[OK]**.
3. Select "Delete Message", then press **[OK]**.
4. Select "Delete OGM", then press **[OK]**.

8. Answering Machine

5. Select “Yes”, then press **OK**.
6. Press [**↶**].

8.4.2 Listening to recorded messages

When you have new messages, the number of new messages is displayed next to **MSG**.

Example:

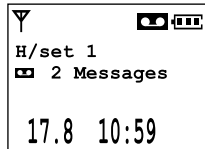

- 1 Press **OK** (centre of joystick).
- 2 Select **MSG**, then press **OK**.
- 3 Select “Play New Msg.”, then press **OK**.
 - The new messages will be played back.
 - To play all messages, select “Play All Msg.”, then press **OK**.
 - Adjust the speaker or receiver volume pushing the joystick up or down repeatedly.

Note:

- While listening to messages, you can switch between the receiver and speaker by pressing [**↶**] or [**↷**].
- If there is no memory available to record voice messages, “Full” will be displayed. Erase unnecessary messages (page 58, 60).

To repeat a message

Push the joystick left while listening to the message.

- If you push the joystick left within 5 seconds of the beginning of the message, the previous message will be played.

To skip a message

Push the joystick right to play the next message.

To stop playback

Press **OK** (soft key).

To erase a specific message

1. Press **X** (soft key) while listening to the message you want to erase.
2. Select “Yes”, then press **OK**.

To erase all the messages

1. Press **OK** (centre of joystick).
2. Select **MSG**, then press **OK**.

3. Select “Delete Message”, then press **OK**.
4. Select “Delete All”, then press **OK**.
5. Select “Yes”, then press **OK**.
6. Press [**↶**].

8.4.3 Leaving a message for others or yourself

- 1 Press **OK** (centre of joystick).
- 2 Select **MSG**, then press **OK**.
- 3 Select “Record”, then press **OK**.
- 4 Select “Record Memo”, then press **OK**.
- 5 Hold the cordless handset about 20 cm away and speak clearly into the microphone (1).
- 6 To stop recording, press **OK**.
- 7 Press [**↶**].

Note:

- Voice memos are treated as new messages. To listen to memo messages, see page 58, 60.
- If there is no memory available to record voice messages, “Full” will be displayed. Erase unnecessary messages (page 58, 60).

8.4.4 Operation using the direct commands

You can operate the answering machine by pressing dial keys as direct commands. To use the following commands, press **OK** (centre of joystick), select **MSG**, then press **OK**.

Key	Direct commands
[1]	Repeats a message (during playback)* ¹
[2]	Skips message (during playback)
[3]	Enters the “Setting TAM” menu (page 61)
[4]	Plays new messages
[5]	Plays all messages
[6]	Plays greeting message
[7][4]	Records memo message
[7][6]	Records greeting message
[8]	Turns auto answer setting ON* ²
[9]	Stops the operation (recording, playback)

Key	Direct commands
[0]	Turns auto answer setting OFF
[*][4]	Erases a specific message (during playback)
[*][5]	Erases all messages
[*][6]	Erases greeting message

*1 If pressed within the first 5 seconds of the beginning of the message, the previous message will be played.

*2 The receiving mode will be set to TAM/FAX or FAX ONLY mode, depending on the setting of feature #77 (page 70).

If you have subscribed to a Caller ID service

During playback, the display shows the number and/or name of the caller whose message is being played.



You can call back the displayed number using the cordless handset.

1. Press  (centre of joystick) during playback.
2. Select "Call Back", then press **OK**.
 - The cordless handset stops playback and automatically dials the telephone number.
 - If you need to edit the telephone number to return the call, select "Edit for Call" in step 2, then press **OK**. Edit the number (page 40), then press **OK** to call back.

8.4.5 Programming for answering machine

To set the remote operation ID

A 3-digit remote operation ID must be entered when operating the answering system remotely (page 63). This ID prevents unauthorised parties from listening to your messages remotely. After you store your remote operation ID, remote operation is possible.

1. Press  (centre of joystick).
2. Select , then press **OK**.
3. Select "Setting TAM", then press **OK**.
4. Select "Remote Code", then press **OK**.
5. To activate the remote operation feature, enter a 3-digit remote operation ID.
 - To deactivate the remote operation feature, press [*].
6. Press **OK**.



7. Press [].

Note:

- You can also program this feature with the base unit (feature #11 on page 66).

To change the ring setting in TAM/FAX mode

To change the number of rings before the unit answers a call in TAM/FAX mode. You can select "Auto", "2 Rings" (default), "3 Rings", "4 Rings", "5 Rings", "6 Rings" or "7 Rings". See page 51 for details.

1. Press  (centre of joystick).
2. Select , then press **OK**.
3. Select "Setting TAM", then press **OK**.
4. Select "Number of Rings", then press **OK**.
5. Select the desired setting, then press **OK**.
6. Press [].

Note:



- You can also program this feature with the base unit (feature #06 on page 66).

To change the maximum recording time for incoming messages

"1 Minute": Up to 1 minute.

"No Limit" (default): Unlimited within the voice memory capacity (page 107).

"Greeting Only": The unit plays the greeting message but does not record caller messages.



1. Press  (centre of joystick).
2. Select , then press **OK**.
3. Select "Setting TAM", then press **OK**.
4. Select "Msg Rec Time", then press **OK**.
5. Select the desired setting, then press **OK**.
6. Press [].

Note:

- You can also program this feature with the base unit (feature #10 on page 66).

To set the greeting message monitor

To select whether the greeting message is heard through the unit's speaker when the unit answers a call.

1. Press  (centre of joystick).
2. Select , then press **OK**.
3. Select "Setting TAM", then press **OK**.
4. Select "Greet Monitor", then press **OK**.
5. Select "On" or "Off", then press **OK**.
6. Press [].

8. Answering Machine

Note:

- You can also program this feature with the base unit (feature #67 on page 69).

8.5 Operating from a remote location

You can call your unit from a remote location and access the answering machine.

Important:

- Activate the remote operation feature by setting the remote operation ID beforehand (page 61, or feature #11 on page 66).
- Set the unit to TAM/FAX mode before going out (page 50).
- Use a touch tone telephone for remote operations.

Helpful hints:

- When you press a key, press firmly.
- Please make a copy of the following table, and carry it with you when you go out.

Answering machine remote operation			
1. Call your unit.		[5]	Plays all messages
2. Enter the remote operation ID during or after the TAM/FAX greeting message.		[6]	Plays greeting message
3. Follow the voice menu or enter a remote command within 10 seconds.		[7]	Records greeting message
		[9]	Repeats the voice guidance (playback or recording is stopped)
Key	Remote command	[*][4]	Erases a specific message
[0]	Turns OFF the answering machine	[*][5]	Erases all messages
[1]	Repeats a message	[*][6]	Erases greeting message (during greeting message playback)
[2]	Skips a message	[*][#]	Ends remote operation
[4]	Plays new messages	[#]	Skips the greeting message

8.5.1 Summary of remote operation

- 1 Call your unit.
- 2 During or after the TAM/FAX greeting message, enter the remote operation ID.
- 3 **When there are new recorded messages**
 - The unit will announce the number of new messages.

When there are no new messages

- The unit will announce there are no new messages.

When voice memory is full

- The unit will announce the memory is full. Erase any unnecessary messages.

- 4 After 3 seconds, the voice menu will start (page 64). Follow the menu or enter a remote command (page 64).
- 5 To end remote operation, hang up.

Note:

- The unit will announce the remaining recording time after playback if it is less than 5 minutes.
- The messages are saved.
- You can ignore the voice guidance and control the unit using remote commands (page 64).

8. Answering Machine

8.5.2 Remote operations following voice menu

During remote operation, the unit will provide voice prompts in the following order.

① "Press 1 to play back all messages. Press 2 for other functions."

[1]: All recorded messages will be played back.

[2]: Voice prompt ② is announced.

② "Press 1 to play back new messages. Press 2 for other functions."

[1]: Only new messages will be played back.

[2]: Voice prompt ③ is announced.

③ "Press 1 to record your message. Press 2 for other functions."

[1]: The unit will announce to leave your message and you can leave your own voice message. When you finish recording, hang up.

[2]: Voice prompt ④ is announced.

④ "Press 1 to erase all messages. Press 2 for other functions."

[1]: All recorded messages will be erased and the unit will announce there are no messages.

[2]: Voice prompt ⑤ is announced.

⑤ "Press 1 to record your greeting. Press 2 for other functions."

[1]: The unit will announce to record your greeting.

Press [7] to start recording and speak after the long beep. Press [9] to stop the operation.

[2]: Voice prompt ① is announced.

8.5.3 Remote operation using remote commands

[1] Repeat (During playback)

- The current message is repeated.
- If pressed within 5 seconds of playback, the previous message will be played.

[2] Skip (During playback)

- The current message is skipped. The next message is played.

[4] New message playback

- New messages are played back.

[5] All message playback

- All messages are played back.

[6] Play greeting message

- The unit will playback the greeting message.

[7] Record greeting message

- Speak after the long beep and press [9] to stop the operation.

[9] Stop

- Operation is stopped.

[0] Turn OFF the answering machine

- The unit hangs up and will switch to TEL mode.

[*][4] Erase a specific message (During playback)

- The current message is erased.
- A short beep will sound and the next message will be played.

[*][5] Erase all messages

- All recorded messages are erased.
- A long beep will sound and the unit will announce there are no messages.

[*][6] Erase greeting message (during greeting message playback)

- Your greeting message will be erased. The unit will answer a call with a pre-recorded greeting message.

[*][#] End of remote operation

- You can also hang up to end the remote operation at any time.

To turn the auto answer setting ON

1. Call your unit and wait for 10 rings.
 - A beep will sound.
2. Enter the remote operation ID (page 66, or feature #11 on page 71) within 8 seconds.
 - The unit will play the greeting message, and the auto answer setting will be turned ON. The receiving mode will be set to TAM/FAX or FAX ONLY mode, depending on the setting of feature #77 (page 70).
3. Hang up the handset.

9.1 Base unit programming

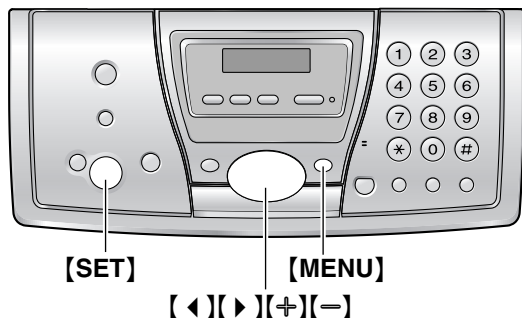

9.1.1 Programming basic features

- 1 Press **[MENU]**.
- 2 Select the feature you wish to program. Press **[◀]** or **[▶]** repeatedly to display the desired feature.
 - The current setting of the feature will be displayed.
- 3 Press **[⊞]** or **[⊟]** repeatedly to display the desired setting.
 - This step may be slightly different depending on the feature.
- 4 Press **[SET]**.
 - The setting you selected is set, and the next feature will be displayed.
- 5 To exit programming, press **[MENU]**.

9.1.2 Programming advanced features

- 1 Press **[MENU]**.
- 2 Press **[◀]** or **[▶]** repeatedly to display "ADVANCE SETTINGS".
- 3 Press **[SET]**.
- 4 Select the feature you wish to program. Press **[◀]** or **[▶]** repeatedly to display the desired feature.
 - The current setting of the feature will be displayed.
- 5 Press **[⊞]** or **[⊟]** repeatedly to display the desired setting.
 - This step may be slightly different depending on the feature.
- 6 Press **[SET]**.

- The setting you selected is set, and the next feature will be displayed.

- 7 To exit programming, press **[MENU]** at any time.

To program by entering the program code number directly

You can select a feature by directly entering its program code (# and a 2-digit number) instead of using **[◀]** or **[▶]**.

1. Press **[MENU]**.
2. Press **[⊞]** and the 2-digit code (page 66 to page 70).
3. Press **[⊞]** or **[⊟]** repeatedly to display the desired setting.
 - This step may be slightly different depending on the feature.
4. Press **[SET]**.
5. To exit programming, press **[MENU]**.

To cancel programming

Press **[MENU]** to exit.

9.2 Basic features

Code #01: Setting the date and time

```
SET DATE & TIME
PRESS SET
```

See page 27 for details.

Code #02: Setting your logo

```
YOUR LOGO
PRESS SET
```

See page 28 for details.

Code #03: Setting your fax number

```
YOUR FAX NO.
PRESS SET
```

See page 29 for details.

Code #04: Printing a sending report

```
SENDING REPORT
=ERROR [±]
```

To print a sending report for fax transmission results (page 44).

“**ERROR**” (default): A sending report will be printed only when fax transmission fails.

“**ON**”: A sending report will be printed after every transmission.

“**OFF**”: Sending reports will not be printed.

Code #06: Changing the ring setting in FAX ONLY mode

```
FAX RING COUNT
RINGS=2 [±]
```

To change the number of rings before the unit answers a call in FAX ONLY mode.

You can select “2” (default), “3”, “4”, “5”, “6”, “7”, “8” or “9”.

Note:

- Set feature #77 to “**FAX ONLY**” (page 70) beforehand.

Code #06: Changing the ring setting in TAM/FAX mode

```
TAM RING COUNT
RINGS=2 [±]
```

To change the number of rings before the unit answers a call in TAM/FAX mode. You can select “2” (default), “3”, “4”, “5”, “6”, “7” or “**AUTO**”.

See page 51 for details.

Note:

- Set feature #77 to “**TAM/FAX**” (page 70) beforehand.

- You can also program this feature with the cordless handset (page 61).

Code #10: Changing the maximum recording time for incoming messages

```
RECORDING TIME
=NO LIMIT [±]
```

“**1 MINUTE**”: Up to 1 minute.

“**NO LIMIT**” (default): Unlimited within the voice memory capacity (page 107).

“**GREETING ONLY**”: The unit plays the greeting message but does not record caller messages.

Note:

- You can also program this feature with the cordless handset (page 61).

Code #11: Setting the remote operation ID

```
REMOTE TAM ID
ID=
```

A 3-digit remote operation ID must be entered when operating the answering system remotely. This ID prevents unauthorised parties from listening to your messages remotely. After you store your remote operation ID, remote operation is possible.

1. Press [**MENU**].
2. Press [**⏏**], then [**1**][**1**].
3. To activate the remote operation feature, enter a 3-digit remote operation ID.
 - To deactivate the remote operation feature, press [*****].
4. Press [**SET**].
5. Press [**MENU**].

Note:

- You can also program this feature with the cordless handset (page 61).

Code #13: Setting the dialling mode (For Australian users only)

```
DIALLING MODE
=TONE [±]
```

If you cannot dial, change this setting depending on your telephone line service.

“**TONE**” (default): For tone dial service.

“**PULSE**”: For rotary pulse dial service.

Note:

- You can also program this feature with the cordless handset (page 79).

Code #17: Setting the ringer type for outside calls

EXT RINGER TYPE =RINGER 1 [±]

To set the base unit ringer type from one of 6 types for outside calls. You can select “RINGER 1” (default), “RINGER 2”, “RINGER 3”, “RINGER 4”, “RINGER 5” or “RINGER 6”.

Note:

- To set the cordless handset ringer type, see page 74.

9.3 Advanced features**Code #22: Setting the journal report to print automatically**

AUTO JOURNAL =ON [±]

“ON” (default): The unit will print a journal report automatically after every 30 new fax transmissions and receptions (page 44).

“OFF”: The unit will not print a journal report, but will keep a record of the last 30 fax transmissions and receptions.

Code #23: Sending documents overseas

OVERSEAS MODE =ERROR [±]

If you cannot send a fax overseas even if the number is correct and the line is connected, activate this feature before sending the fax. This feature improves the reliability by reducing the transmission speed.

“ERROR” (default): When the previous fax transmission fails and you wish to re-send the document.

“NEXT FAX”: This setting is effective only for the next attempted fax transmission. After transmission, the unit will return to the previous setting.

“OFF”: Deactivates this feature.

Note:

- This feature is not available for broadcast transmission.
- Calling charges may be higher than usual.

Code #25: Sending a fax at a specific time

DELAYED SEND =OFF [±]

This feature allows you to take advantage of low-cost calling hours offered by your telephone company. This feature can be set up to 24 hours in advance of the desired time.

To send a document:

1. Insert the document.
2. If necessary, press **[+]** or **[-]** repeatedly to select the desired resolution (page 43).
3. Press **[MENU]**.
4. Press **[⇄]** then **[2][5]**.
5. Press **[+]** or **[-]** repeatedly to select “ON”.
6. Press **[SET]**.
7. Enter the fax number.

9. Programmable Features

8. Press **[SET]**.
9. Enter the transmission start time.
 - If you select 12-hour time entry when you set the date and time (page 26), press **[*]** repeatedly to select “AM” or “PM”.
 - If you selected 24-hour time entry when you set the date and time (page 26), the time is set using 24-hour time entry.

10. Press **[SET]**.

11. Press **[MENU]**.

Note:

- To cancel after programming, press **[STOP]** then **[SET]**.

Code #26: Setting the Caller ID list to print automatically

AUTO CALL. LIST
=OFF [±]

“ON”: The Caller ID list will be printed automatically each time the unit logs 50 different callers (page 38).

“OFF” (default): The Caller ID list will not be printed, but the unit will keep a record of the information for the last 50 different callers.

Code #28: Setting call bar

CALL BAR
PRESS SET

This feature prohibits making outside calls with the base unit. When call bar is turned ON, only intercom calls and emergency calls can be made. To store emergency numbers, see page 79.

1. Press **[MENU]**.
2. Press **[#]**, then **[2][8]**.
3. Press **[SET]**.
4. Enter “0000” (default base unit PIN).
 - If you changed the PIN, enter it (page 80).
5. Press **[+]** or **[-]** repeatedly to select “ON”.
6. Press **[SET]**.
7. Press **[MENU]**.

Note:

- When call bar is turned ON,  is displayed on the base unit.
- To prohibit making outside calls with the cordless handset, see page 76.

Code #31: Activating the Distinctive Ring feature

DISTINCTIVE RING
=OFF [±]

See page 54 for details.

Code #34: Setting the quick scan

QUICK SCAN
=OFF [±]

This feature is helpful when you want to remove the document for other uses, because the unit will release the document before sending or copying.

“ON”: The unit will scan the document and store it into memory first, then the unit will start sending or copying.

“OFF” (default): Deactivates this feature.

Note:

- If the document exceeds the memory capacity, sending of the whole document or copying of the exceeded document will be cancelled and this feature will be turned OFF automatically.

Code #36: Receiving oversized documents

RCV REDUCTION
=92% [±]

If the size of the document sent by the other party is as large as, or larger than the recording paper, the unit can reduce the document and print it. Select the desired reduction rate.

Setting	Recording paper size	Original document size
“100%”	A4	Letter
“92%” (default)	A4	A4
“86%”	A4	A4
“72%”	A4	Legal

Note:

- The information of the sending party is printed on the top of each page. Therefore, even if the original document is the same size as the recording paper, the document will be divided into 2 sheets when printed at “100%”. Select “92%” to print on 1 sheet.

Code #39: Changing the display contrast

LCD CONTRAST
=NORMAL [±]

“NORMAL” (default): For normal contrast.

“DARKER”: Used when the display contrast is too light.

Code #41: Changing the fax activation code

FAX ACTIVATION
=ON [±]

If you wish to use the cordless handset (page 49) or an extension telephone (page 49) to receive faxes, activate this feature and program the activation code.

1. Press **[MENU]**.
2. Press **[⇐]**, then **[4][1]**.
3. Press **[+]** or **[-]** repeatedly to select "ON".
4. Press **[SET]**.
5. Enter your code (2 to 4 digits) using the dial keys **[0]–[9]**, **[*]** and **[⇐]**.
 - The default code is "*#9".
 - Do not enter "0000".
6. Press **[SET]**.
7. Press **[MENU]**.

Code #44: Setting the memory reception alert

RECEIVE ALERT
=ON [±]

To alert you with a beeping sound when a received fax document is stored into memory due to some existing problem.

The slow beeps will continue until you clear the printing problem and make sure the unit is supplied with enough paper to print the stored document.

"ON" (default): You will be alerted to a reception problem by a beeping sound.

"OFF": Deactivates this feature.

Code #46: Setting friendly reception

FRIENDLY RCV
=ON [±]

To receive a fax automatically when you answer a call and hear a fax calling tone (slow beep).

"ON" (default): You do not have to press **[FAX/START]** for fax reception.

"OFF": You have to press **[FAX/START]** for fax reception.

Code #54: Changing the recording time for your TAM/FAX greeting message

GREETING TIME
=16s [±]

"16s" (default): Maximum recording time is 16 seconds.

"60s": Maximum recording time is 60 seconds. See page 57 for details.

Code #58: Setting the scan contrast

SCAN CONTRAST
=NORMAL [±]

To send or copy a document with faint or dark writing, set this feature before transmission or copying.

"NORMAL" (default): Used for normal writing.

"LIGHT": Used for faint writing.

"DARKER": Used for dark writing.

Code #67: Setting the greeting message monitor

GREET MONITOR
=ON [±]

To select whether the greeting message is heard through the unit's speaker when the unit answers a call.

"ON" (default): You can monitor the greeting message.

"OFF": Only the caller message will be heard through the speaker.

Note:

- You can also program this feature with the cordless handset (page 61).

Code #68: Setting the Error Correction Mode (ECM)

ECM SELECTION
=ON [±]

This feature is available when the transmitting/receiving fax machines are ECM compatible.

"ON" (default): To send a fax even if there is static interference on the telephone line.

"OFF": Deactivates this feature.

Note:

- You cannot change the setting when received documents are in memory.

Code #74: Setting the location where you use this unit

LOCATION
=AUSTRALIA [±]

This setting must match your location.

"AUSTRALIA" (default): To use in Australia.

"NEWZEALAND": To use in New Zealand.

Code #76: Setting the connecting tone

CONNECTING TONE
=ON [±]

If you often have trouble when sending faxes, this feature allows you to hear connecting tones: fax tone, ring back tone and busy tone. You can

9. Programmable Features

use these tones to confirm the status of the other party's machine.

“ON” (default): You will hear connecting tones.

“OFF”: Deactivates this feature.

Note:

- If the ring back tone continues, the other party's machine may not be a fax machine or may have run out of paper. Check with the other party.
- The connecting tone volume cannot be adjusted.

Code #77: Changing the receiving mode in the auto answer setting

AUTO ANSWER =TAM/FAX [±]

“TAM/FAX” (default): Telephone Answering Machine/Fax mode (page 50)

“FAX ONLY”: Fax only mode (page 52)

Code #80: Resetting advanced features to their default settings

SET DEFAULT RESET=NO [±]

To reset the advanced features:

1. Press **[MENU]**.
2. Press **[⇐]**, then **[8][0]**.
3. Press **[+]** or **[-]** repeatedly to select “YES”.
4. Press **[SET]**.
5. Press **[SET]** again.
6. Press **[MENU]**.

Note:

- The ECM setting (feature #68 on page 69) will not be reset.
- You can also reset advanced features with the cordless handset (page 80).

9.4 Direct commands for programming features

You can also select the desired setting by directly entering the program code (# and a 2-digit number) and direct command.

For more details on the features, see page 66 to page 70.

- 1 Press **[MENU]**.
- 2 Press **[⇐]** and the 2-digit code number.
- 3 Press the desired direct command to display the desired setting.
 - This step may be slightly different depending on the feature.
- 4 Press **[SET]**.
- 5 To exit programming, press **[MENU]**.

9.4.1 Program code and direct command button

[⇐][0][1] Date and time

- Enter the date and time using the dial keypad. See page 27 for details.

[⇐][0][2] Your logo

- Enter your logo using the dial keypad. See page 28 for details.

[⇐][0][3] Your fax number

- Enter your fax number using the dial keypad. See page 29 for details.

[⇐][0][4] Sending report

- **[1]**: “ON”
- **[2]**: “OFF”
- **[3]**: “ERROR” (default)

[⇐][0][6] FAX ring count

- **[2]**: “2” (default)
- **[3]**: “3”
- **[4]**: “4”
- **[5]**: “5”
- **[6]**: “6”
- **[7]**: “7”
- **[8]**: “8”
- **[9]**: “9”

[⇐][0][6] TAM ring count

- **[0]**: “AUTO”
- **[2]**: “2” (default)
- **[3]**: “3”
- **[4]**: “4”

- [5]: "5"
- [6]: "6"
- [7]: "7"

[*][1][0] Message recording time

- [1]: "1 MINUTE"
- [2]: "GREETING ONLY"
- [3]: "NO LIMIT" (default)

[*][1][1] Remote operation ID

- Enter a 3-digit number to activate the remote operation feature. To deactivate the remote operation feature, press [*].

[*][1][3] Dialling mode

- [1]: "PULSE"
- [2]: "TONE" (default)

[*][1][7] External ringer type

- [1]: "RINGER 1" (default)
- [2]: "RINGER 2"
- [3]: "RINGER 3"
- [4]: "RINGER 4"
- [5]: "RINGER 5"
- [6]: "RINGER 6"

[*][2][2] Automatic journal report

- [1]: "ON" (default)
- [2]: "OFF"

[*][2][3] Overseas mode

- [1]: "NEXT FAX"
- [2]: "OFF"
- [3]: "ERROR" (default)

[*][2][5] Delayed transmission

- [1]: "ON"
- [2]: "OFF" (default)
- If you select "ON", next enter the fax number and transmission time using the dial keypad (see feature #25 on page 67 for details).

[*][2][6] Automatic Caller ID list

- [1]: "ON"
- [2]: "OFF" (default)

[*][2][8] Call bar

- [1]: "ON"
- [2]: "OFF" (default)
- The base unit PIN is required to turn call bar ON/OFF.

[*][3][1] Distinctive Ring

- [1]: "ON"
- [2]: "OFF" (default)

[*][3][4] Quick scan

- [1]: "ON"
- [2]: "OFF" (default)

[*][3][6] Receiving reduction

- [1]: "72%"
- [2]: "86%"
- [3]: "92%" (default)
- [4]: "100%"

[*][3][9] Display contrast

- [1]: "NORMAL" (default)
- [2]: "DARKER"

[*][4][1] Fax activation code

- [1]: "ON" (default)
- [2]: "OFF"
- If you select "ON", next enter your 2 to 4 digit code using [0]–[9], [*] and [#].

[*][4][4] Memory reception alert

- [1]: "ON" (default)
- [2]: "OFF"

[*][4][6] Friendly reception

- [1]: "ON" (default)
- [2]: "OFF"

[*][5][4] Greeting recording time

- [1]: "16s" (default)
- [2]: "60s"

[*][5][8] Scan contrast

- [1]: "NORMAL" (default)
- [2]: "LIGHT"
- [3]: "DARKER"

[*][6][7] Greeting monitor

- [1]: "ON" (default)
- [2]: "OFF"

[*][6][8] ECM selection

- [1]: "ON" (default)
- [2]: "OFF"

[*][7][4] Location

- [1]: "AUSTRALIA" (default)
- [2]: "NEWZEALAND"

[*][7][6] Connecting tone

- [1]: "ON" (default)
- [2]: "OFF"

[*][7][7] Auto answer

- [1]: "TAM/FAX" (default)
- [2]: "FAX ONLY"

9. Programmable Features

[F4][8][0] Set default

- [1]: "YES"
- [2]: "NO" (default)
- If you select "YES", press **[SET]** 2 times, then press **[MENU]** to exit programming.

9.5 Cordless handset programming

For your reference, a chart of all items which can be customised for the cordless handset is printed below. Details of each item can be found on the corresponding pages.

- When customising the cordless handset, the current item or setting is indicated by ▶.

Cordless handset settings menu	Sub-menu	Default setting	Page
“Set Date/Time”	-----	-----	page 26
“Memo Alarm”	“Alarm 1”	“Off”	page 74
	“Alarm 2”	“Off”	page 74
	“Alarm 3”	“Off”	page 74
“Ringer Option”	“Ringer Volume”	Maximum	page 25
	“EXT Ringer Type”	“Ringer 1”	page 74
	“INT Ringer Type”	“Ringer 1”	page 74
	“Paging Tone”	“Ringer 1”	page 74
	“Private Ring”	“Ringer 1” ^{*1}	page 74
“Tone Option”	“Key Tone”	“On”	page 75
“Display Option”	“Standby Display”	“Handset Name”	page 75
	“Talk Display”	“Talk Time”	page 75
	“Select Language”	“English”	page 75
	“Private Colour”	“Green” ^{*1}	page 75
	“Category Name”	Category (No.) ^{*1}	page 75
“Call Option”	“Call Bar”	“Off”	page 76
	“Direct Call No.”	-----	page 76
	“Direct On/Off”	“Off”	page 76
“Registration”	“Register H/set”	-----	page 81
	“Cancel Base”	-----	page 82
“Select Base”	-----	“Auto”	page 81
“Other Option”	“Change H/S PIN”	“0000”	page 76
	“Change H/S Name”	Handset (No.)	page 76
	“Auto Talk”	“Off”	page 76
	“Battery Type”	“Ni-MH”	page 77
	“Reset Handset”	-----	page 77

*1 Each category (1-9) has its own setting.

Note:

- Up to 5 menu items can be displayed at a time. To select a menu item not shown on the current page, scroll up or down by pushing the joystick up or down, respectively.

9.5.1 Programmable functions

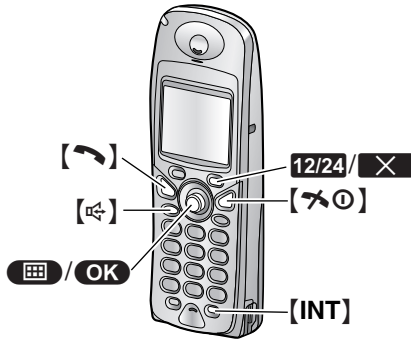

Helpful hints:

- To exit programming, press [cancel] at any time.

9.5.2 Memo alarm

Setting memo alarm

An alarm will sound for 3 minutes at the set time once or daily. 3 different alarms can be set. A text memo can also be displayed. Set the date and time beforehand (page 26).

1. Press [OK] (centre of joystick).
2. Select [memo], then press [OK].
3. Select "Memo Alarm", then press [OK].
4. Push the joystick up or down repeatedly to select an alarm (1 to 3).
 - Times and memos for previously set alarms will be displayed. To delete the previous setting, press [X], select "Yes", then press [OK].
5. Press [OK].
6. Select an alarm mode, then press [OK].
 - "Off" (default): Turns the alarm OFF.
 - If you select "Off" skip to step 13.
 - "Once": The alarm will sound once at the set time. Enter the desired date and month by selecting 2 digits for each.
 - "Daily": An alarm will sound daily at the set time.
7. Enter the desired hour and minute by selecting 2 digits for each.
8. Press [12/24] repeatedly to select "AM", "PM", or 24-hour time entry, then press [OK].
 - If you do not need to enter a text memo, skip to step 10.
9. Enter a text memo, up to 32 characters (see page 88 for instructions).
10. Press [OK].
11. Select the ringer that will sound at the set time.

12. Press [OK].
13. Press [OK].
14. Press [cancel].

Note:

- To stop the alarm, press [hook], [cancel], [speaker], [0] to [9], [*], [#] or [INT].
- When the cordless handset is in talk or intercom mode, the alarm will not sound until the call has ended.
- Memo alarm volume depends on cordless handset ringer volume (page 25).
- The alarm will sound at the set time even when the ringer is turned OFF.
- If you select "Once", the setting will be changed to "Off" after the alarm sounds.

9.5.3 Ringer options

Changing ringer types

You can select the ringer type for the cordless handset from one of 15 types.

"EXT Ringer Type": Selects the ringer heard for outside calls.

"INT Ringer Type": Selects the ringer heard for intercom calls.

"Paging Tone": Selects the ringer heard when all cordless handsets are paged.

"Private Ring": Allows you to set a different ringer for each private category (for Caller ID service users only, page 38).

1. Press [OK] (centre of joystick).
2. Select [ringer], then press [OK].
3. Select the desired item, then press [OK].
 - The ringer sounds using the current ringer type.
 - If you select "Private Ring" choose the desired category, then press [OK].
4. Select the desired ringer type, then press [OK].
5. Press [cancel].

Note:

- If you select one of the melody ringer types, the ringer will continue to sound for 10 seconds if the caller hangs up before you answer. You may hear a dial tone or no one on the line when you answer a call.
- The preset melodies in this product are used with permission of M-ZoNE Co., Ltd.
- To set the base unit ringer type, see feature #17 on page 67.

9.5.4 Tone options

Setting key tone

You can select whether or not key tones are heard when keys are pressed. Includes confirmation tones and error tones.

1. Press (centre of joystick).
2. Select , then press **OK**.
3. Select “**Tone Option**”, then press **OK**.
4. Select “**Key Tone**”, then press **OK**.
5. Select “**On**” (default) or “**Off**”, then press **OK**.
6. Press [**⏏**].

9.5.5 Display options

Selecting the standby mode display

“**Base Number**”: The current base unit number is displayed.

“**Handset Name**” (default): The name of the cordless handset is displayed.

“**off**”: Only the current date and time are displayed.

1. Press (centre of joystick).
2. Select , then press **OK**.
3. Select “**Display Option**”, then press **OK**.
4. Select “**Standby Display**”, then press **OK**.
5. Select the desired setting, then press **OK**.
6. Press [**⏏**].

Selecting the talk mode display

You can change what is shown on the display when you make a call.

“**Talk Time**” (default): The length of the current call will be displayed.

“**Phone Number**”: The telephone number you dialled will be displayed.

1. Press (centre of joystick).
2. Select , then press **OK**.
3. Select “**Display Option**”, then press **OK**.
4. Select “**Talk Display**”, then press **OK**.
5. Select the desired setting, then press **OK**.
6. Press [**⏏**].

Note:

- Even if you select “**Phone Number**”, the length of the call will appear on your display when you receive calls.

Changing the display language

1. Press (centre of joystick).
2. Select , then press **OK**.
3. Select “**Display Option**”, then press **OK**.
4. Select “**Select Language**”, then press **OK**.
5. Select the desired language, then press **OK**.
6. Press [**⏏**].

Note:

- If you select a language you cannot read, press [**⏏**], press , push joystick down, press **OK**, push joystick down 4 times, press **OK**, push joystick down 2 times, press **OK**, select the desired language, then press **OK**.

Changing category private colours

You can select the ringer indicator colour used when calls are received from parties assigned to a category in the cordless handset phonebook. (for Caller ID service users only)

1. Press (centre of joystick).
2. Select , then press **OK**.
3. Select “**Display Option**”, then press **OK**.
4. Select “**Private Colour**”, then press **OK**.
5. Select a category, then press **OK**.
6. Select a ringer indicator colour from “**Green**” (default), “**Red**” or “**Orange**”.
 - The ringer indicator flashes using the selected colour as a reference.
7. Press **OK**.
8. Press [**⏏**].

Changing category names

You can change the names of categories (Family, Friends, etc.) for the cordless handset phonebook.

1. Press (centre of joystick).
2. Select , then press **OK**.
3. Select “**Display Option**”, then press **OK**.
4. Select “**Category Name**”, then press **OK**.
5. Select a category, then press **OK**.
6. Edit the name, up to 10 characters (see page 88 for instructions).
7. Press **OK**.

8. Press [**⏏**].

9.5.6 Call options

Setting call bar

This feature prohibits making outside calls with the cordless handset. When call bar is turned ON, only intercom calls and emergency calls can be made. To store emergency numbers, see page 79.

1. Press [**⏏**] (centre of joystick).
2. Select [**⏏**], then press [**OK**].
3. Select "Call Option", then press [**OK**].
4. Select "Call Bar", then press [**OK**].
5. Enter "0000" (default cordless handset PIN).
 - If you changed the PIN, enter it (page 76).
6. Select "On" or "Off" (default), then press [**OK**].
7. Press [**⏏**].

Note:

- When call bar is turned ON, **⏏** is displayed on the cordless handset.
- To prohibit making outside calls with the base unit, see feature #28 on page 68.

Storing the direct call number

This feature prohibits making outside calls except to the telephone number you store here. The number will be dialled automatically when [**⏏**] or [**⏏**] is pressed.

1. Press [**⏏**] (centre of joystick).
2. Select [**⏏**], then press [**OK**].
3. Select "Call Option", then press [**OK**].
4. Select "Direct Call No.", then press [**OK**].
5. Enter the telephone number, up to 24 digits.
6. Press [**OK**] 2 times.
7. Turn this feature ON or OFF by selecting "On" or "Off" (default), then press [**OK**].
8. Press [**⏏**].

Note:

- When direct call is turned ON, **⏏** is displayed in standby mode.

Turning direct call ON/OFF

1. Press [**⏏**] (centre of joystick).
2. Select [**⏏**], then press [**OK**].
3. Select "Call Option", then press [**OK**].
4. Select "Direct On/Off", then press [**OK**].
5. Select "On" or "Off" (default), then press [**OK**].

6. Press [**⏏**].

Note:

- If there is no direct call number stored when you turn direct call ON, you will be prompted to enter a telephone number.

9.5.7 Other options

Changing the cordless handset PIN (personal identification number)

For security, the cordless handset PIN must be entered when changing certain settings. The default PIN is "0000".

Important:

- **If you change the PIN, please make note of your new PIN. The unit will not reveal the PIN to you. If you forget your PIN, consult your nearest Panasonic service centre.**

1. Press [**⏏**] (centre of joystick).
2. Select [**⏏**], then press [**OK**].
3. Select "Other Option", then press [**OK**].
4. Select "Change H/S PIN", then press [**OK**].
5. Enter the current 4-digit cordless handset PIN.
6. Enter the new 4-digit cordless handset PIN.
7. Enter the new 4-digit cordless handset PIN again.
8. Press [**⏏**].

Changing the cordless handset name

The cordless handset can be given a customised name. This feature is useful when you have multiple cordless handsets.

1. Press [**⏏**] (centre of joystick).
2. Select [**⏏**], then press [**OK**].
3. Select "Other Option", then press [**OK**].
4. Select "Change H/S Name", then press [**OK**].
5. Edit the name, up to 10 characters (see page 88 for instructions).
6. Press [**OK**].
7. Press [**⏏**].

Setting auto talk

When this feature is turned ON, you can answer calls simply by lifting the cordless handset off the charger. You do not need to press any buttons.

1. Press [**⏏**] (centre of joystick).
2. Select [**⏏**], then press [**OK**].
3. Select "Other Option", then press [**OK**].

4. Select “Auto Talk”, then press **OK**.
5. Select “On” or “Off” (default), then press **OK**.
6. Press [**↶**].

Setting the battery type

“Ni-Cd” : Nickel cadmium batteries are used.
“Ni-MH” (default) : Nickel metal hydride batteries are used.

1. Press **⏏** (centre of joystick).
2. Select **⏏**, then press **OK**.
3. Select “Other Option”, then press **OK**.
4. Select “Battery Type”, then press **OK**.
5. Select the desired setting, then press **OK**.
6. Press [**↶**].

Resetting the cordless handset to its default settings

1. Press **⏏** (centre of joystick).
2. Select **⏏**, then press **OK**.
3. Select “Other Option”, then press **OK**.
4. Select “Reset Handset”, then press **OK**.
5. Enter “0000” (default cordless handset PIN).
 - If you changed the PIN, enter it (page 76).
6. Select “Yes”, then press **OK**.
7. Press [**↶**].

Note:

- The following items will be deleted or reset to their default settings:
 - Settings listed on page 73
 - Redial list
 - Walkie-Talkie mode, group ID and group cordless handset no. (page 85)
- The following items will be retained:
 - Cordless handset phonebook items
 - Date and time
 - Cordless handset name
 - Category names

9.6 Cordless handset programming using the base unit PIN

For your reference, a chart of all items which can be customised for the unit using the base unit PIN is printed below. Details of each item can be found on the corresponding pages.

- Keep the front cover page open for button locations.
- When customising the unit, the current setting is indicated by ▶.

Base unit settings menu	Sub-menu	Sub-menu 2	Default setting	Page
"Call Option"	"Dial Mode"		"Tone"	page 79
	"Recall"		"Type 2"	page 79
	"Pause Time"		"Short"	page 79
	"Emergency Call"		"000", "111"*1 and "911", "999"	page 79
	"Set ARS"	"Set Area Code"	-----	page 80
	"Call Restricted"		-----	page 79
	"Cancel Handset"-----		-----	page 81
"Other Option"	"Change Base PIN"		"0000"	page 80
	"Reset Base"		-----	page 80

*1 If you set the location setting to "New Zealand" (feature #74 on page 69), the default setting will be "111", "911" and "999".

Note:

- Up to 5 menu items can be displayed at a time. To select a menu item not shown on the current page, scroll up or down by pushing the joystick up or down, respectively.

9.6.1 Call Options

Setting dialling mode (tone/pulse)

For Australian users only

“**Tone**” (default): Select when you have a touch tone service.

“**Pulse**”: Select when you have rotary or pulse service.

1. Press (centre of joystick).
2. Select , then press **OK**.
3. Enter “0000” (default base unit PIN).
 - If you changed the PIN, enter it (page 80).
4. Select “**Call Option**”, then press **OK**.
5. Select “**Dial Mode**”, then press **OK**.
6. Select the desired setting, then press **OK**.
7. Press [**↶** **0**].

Note:

- You can also program this feature with the base unit (feature #13 on page 66).

Changing the recall length

Change the recall length of the cordless handset, if necessary, depending on the requirements of your service provider or PBX.

■ For Australian users

“**Type 1**”: 700 msec

“**Type 2**”: 100 msec (default)

“**Type 3**”: 200 msec

■ For New Zealand users

“**Type 1**”: 100 msec

“**Type 2**”: 600 msec (default)

“**Type 3**”: 200 msec

1. Press (centre of joystick).
2. Select , then press **OK**.
3. Enter “0000” (default base unit PIN).
 - If you changed the PIN, enter it (page 80).
4. Select “**Call Option**”, then press **OK**.
5. Select “**Recall**”, then press **OK**.
6. Select the desired setting, then press **OK**.
7. Press [**↶** **0**].

Setting pause length

Change the pause length of the cordless handset, if necessary, depending on the requirements of your service provider or PBX.

“**Short**” (default): 3 sec.

“**Long**”: 5 sec.

1. Press (centre of joystick).
2. Select , then press **OK**.
3. Enter “0000” (default base unit PIN).

- If you changed the PIN, enter it (page 80).
4. Select “**Call Option**”, then press **OK**.
 5. Select “**Pause Time**”, then press **OK**.
 6. Select the desired setting, then press **OK**.
 7. Press [**↶** **0**].

Storing/changing emergency numbers

These settings determine which telephone numbers can be dialled while the call bar feature is ON (feature #28 on page 68, or page 76).

1. Press (centre of joystick).
2. Select , then press **OK**.
3. Enter “0000” (default base unit PIN).
 - If you changed the PIN, enter it (page 80).
4. Select “**Call Option**”, then press **OK**.
5. Select “**Emergency Call**”, then press **OK**.
6. Select a memory location, then press **OK**.
 - If the memory location already contains an emergency number, the number is displayed.
7. Enter/edit the number, up to 24 digits, then press **OK**.
8. Press [**↶** **0**].

Setting call restriction

You can restrict selected cordless handsets/base unit from dialling certain numbers. You can assign up to 6 telephone numbers to be restricted, and select which cordless handsets/base unit will be restricted. Storing area codes here will prevent the restricted cordless handsets/base unit from dialling any telephone number in that area code. If a restricted number is dialled, the call will not be connected.

1. Press (centre of joystick).
2. Select , then press **OK**.
3. Enter “0000” (default base unit PIN).
 - If you changed the PIN, enter it (page 80).
4. Select “**Call Option**”, then press **OK**.
5. Select “**Call Restricted**”, then press **OK**.
6. Select the cordless handsets/base unit to be restricted, then press .
 - Restricted cordless handsets/base unit have a next to them.
 - To turn call restriction OFF for a cordless handset/base unit, select it, then press .
7. Press **OK**.

9. Programmable Features

8. Select a memory location, then press **OK**.
 - Previously stored telephone numbers are displayed.
9. Enter the telephone number or area code to be restricted (up to 8 digits), then press **OK**.
 - To erase a restricted number, press **[C]**.
10. Press **[*0]**.

Note:

- If you put a first digit in step 9, the previously stored number will be all cleared. We recommend you to write down the previously stored number.

Selecting area codes to be deleted automatically

In some situations, phone numbers stored automatically in the Caller ID list (page 40) will include area codes. If you do not want to dial the area codes when making calls from the Caller ID list, you can store the area codes which you want the unit to delete automatically.

Example: You have stored the area code "123". If you make a call from the Caller ID list to the phone number "123-456-7890", the unit dials "456-7890".

1. Press **[*]** (centre of joystick).
2. Select **[*]**, then press **OK**.
3. Enter "0000" (default base unit PIN).
 - If you changed the PIN, enter it (page 80).
4. Select "Call Option", then press **OK**.
5. Select "Set ARS", then press **OK**.
6. Select "Set Area Code", then press **OK**.
7. Select an area code location (1-25), then press **OK**.
 - If the location already contains an area code, the code is displayed.
8. Enter an area code (5 digits max.), then press **OK**.
9. Press **[*0]**.

Note:

- The use of this feature can prevent a National Call from being dialled. E.g., in the case of the South Island, the "03" will be omitted and will therefore prevent a National Call to other areas of the South Island. (for New Zealand users only)

9.6.2 Other options

Changing the base unit PIN (personal identification number)

For security, the base unit PIN must be entered when changing certain settings. The default PIN is "0000".

Important:

- **If you change the PIN, please make note of your new PIN. The unit will not reveal the PIN to you. If you forget your PIN, consult your nearest Panasonic service centre.**
1. Press **[*]** (centre of joystick).
 2. Select **[*]**, then press **OK**.
 3. Enter "0000" (default base unit PIN).
 - If you changed the PIN, enter it.
 4. Select "Other Option", then press **OK**.
 5. Select "Change Base PIN", then press **OK**.
 6. Enter the new 4-digit base unit PIN.
 7. Enter the new 4-digit base unit PIN again.
 8. Press **[*0]**.

Resetting the base unit advanced features to their default settings

The base unit advanced features (page 67 to page 70) can be reset with the cordless handset.

1. Press **[*]** (centre of joystick).
2. Select **[*]**, then press **OK**.
3. Enter "0000" (default base unit PIN).
 - If you changed the PIN, enter it (page 80).
4. Select "Other Option", then press **OK**.
5. Select "Reset Base", then press **OK**.
6. Select "Yes", then press **OK**.
7. Press **[*0]**.

Note:

- The ECM setting (feature #68 on page 69) will not be reset.
- You can also reset the base unit advanced features with the base unit (feature #80 on page 70).

10.1 Operating additional units

10.1.1 Additional cordless handsets

Up to 6 cordless handsets can be registered to a single base unit. Additional cordless handsets, for example, will allow you to have an intercom call with another cordless handset while a third cordless handset is on an outside call. See page 11 for accessory information.

10.1.2 Additional base units



Cordless handsets can be registered to up to 4 base units, allowing you to add additional base units and extend the area in which your cordless handset(s) can be used. If a cordless handset moves out of range of its base unit when "Auto" is selected on base unit selection (page 81), it will look for another base unit to make or receive calls. Each base unit forms 1 radio cell.

Note:

- Calls will be disconnected when the cordless handset moves from one radio cell to another.
- Intercom calls and call transfers are only possible between cordless handsets in the same radio cell.

10.2 Registering a cordless handset to a base unit

The cordless handset supplied with the base unit is already registered. If an optional cordless handset is purchased, it must be registered using the following method.

- Keep the front cover page open for button locations.
- 1 Press  (centre of joystick).
 - 2 Select , then press **OK**.
 - 3 Select "Registration", then press **OK**.
 - 4 Select "Register H/set", then press **OK**.
 - 5 Press and hold **[LOCATOR/INTERCOM]** on the base unit for about 3 seconds, until the registration tone sounds.
 - After pressing **[LOCATOR/INTERCOM]**, the rest of

this procedure must be completed within 1 minute.



- 6 Select a base number, then press **OK**.
- 7 Wait until "Enter Base PIN" is displayed, then enter "0000" (default base unit PIN).
 - If you changed the PIN, enter it (page 80).
- 8 Press **OK**.

Note:

- When the cordless handset has been registered successfully, a confirmation tone will be heard and  will stop flashing.



10.2.1 Selecting a base unit

When "Auto" is selected, the cordless handset will automatically use any available base unit it is registered to. When a specific base unit is selected, the cordless handset will make and receive calls using that base unit only. If the cordless handset is out of range of that base unit, no calls can be made or received.

- 1 Press  (centre of joystick).
- 2 Select , then press **OK**.
- 3 Select "Select Base", then press **OK**.
- 4 Select the desired base unit number, or "Auto", then press **OK**.
 - The cordless handset starts searching for the base unit.





10.2.2 Cancelling a cordless handset

A cordless handset can cancel its own registration (or the registration of another cordless handset) that is stored in the base unit. This will allow the base unit to forget the cordless handset.

- 1 Press  (centre of joystick).
- 2 Select , then press **OK**.
- 3 Enter "0000" (default base unit PIN).
 - If you changed the PIN, enter it (page 80).
- 4 Select "Cancel Handset", then press **OK**.
 - The names of all cordless handsets registered to the base unit are displayed.
- 5 Select the cordless handset(s) you want to cancel, then press .
- 6 Press **OK**.

10.2.3 Cancelling a base unit

A cordless handset can cancel a base unit that it is registered to. This allows the cordless handset to forget the base unit.

- 1 Press  (centre of joystick).
- 2 Select , then press **OK**.
- 3 Select "Registration", then press **OK**.
- 4 Select "Cancel Base", then press **OK**.
- 5 Enter "0000" (default cordless handset PIN).
 - If you changed the PIN, enter it (page 76).
- 6 Select the base unit(s) you want to cancel, then press .
- 7 Press **OK**.
- 8 Select "Yes", then press **OK**.
- 9 Press .

Note:

- To register the cordless handset to another base unit or to the same base unit again, see page 81.



10.3 Intercom

Intercom calls can be made between cordless handsets/base unit in the same radio cell, but not in different radio cells.

- Keep the front cover page open for button locations.

10.3.1 Between cordless handsets

Example: When cordless handset 1 calls cordless handset 2



1. **Cordless handset 1:**
Press **[INT]** and **[2]** (desired cordless handset number).
 - The cordless handset 2 will ring.
2. **Cordless handset 2:**
Press  or  to answer.
3. When finished talking, press .

10.3.2 Between a cordless handset and the base unit

Example: When cordless handset 1 calls the base unit

1. **Cordless handset 1:**
Press **[INT]**, then press **[0]**.
 - The base unit will ring.
2. **Base unit:**
Press **[LOCATOR/INTERCOM]**, **[DIGITAL SP-PHONE]** or lift the handset to answer.
3. **Cordless handset 1:**
When finished talking, press  or place the cordless handset on the charger.
Base unit:
When finished talking, press **[DIGITAL SP-PHONE]**, **[LOCATOR/INTERCOM]** or replace the handset.

Example: When the base unit calls cordless handset 1

1. **Base unit:**
Press **[LOCATOR/INTERCOM]**, then press **[1]** (desired cordless handset number).
 - The cordless handset 1 will ring.
 - To page all cordless handsets, press **[0]**.
You can talk with the cordless handset user who answers first.
 - To stop paging, press **[LOCATOR/INTERCOM]** again.
2. **Cordless handset 1:**
Press **[INT]**,  or  to answer.
3. **Base unit:**

When finished talking, press **[DIGITAL SP-PHONE]**, **[LOCATOR/INTERCOM]** or replace the handset.

Cordless handset 1:

When finished talking, press **[*0]** or place the cordless handset on the charger.

Note:

- If the cordless handset user has difficulty hearing the base unit user, ask the base unit user to decrease the speaker volume by pressing **[=]**.

Cordless handset locator

Using this feature, you can locate a cordless handset if it has been misplaced.

10.4 Transferring calls / Conference calls

Outside calls can be transferred to the base unit or to a cordless handset.

2 people can have a conference call with an outside party.

- Keep the front cover page open for button locations.

10.4.1 From a cordless handset to the base unit

Example: When cordless handset 1 transfers a call to the base unit

1. Cordless handset 1:

During an outside call, press **[INT]** and **[0]** to page the base unit.

- The outside call will be put on hold.
- If there is no answer, press **[INT]** to return to the outside call.

2. Base unit:

Press **[LOCATOR/INTERCOM]**, **[DIGITAL SP-PHONE]** or lift the handset to answer the page.

- The base unit user can talk with cordless handset 1 user.

3. Cordless handset 1:

To complete the call transfer, press **[*0]**. To establish a conference call, press **[3]**.

To transfer a call without speaking to the base unit user

After step 1, press **[*0]** on the cordless handset 1.

If the transferred call is not answered within 60 seconds, the cordless handset 1 will ring again. Press **[INT]** to return to the outside call.

10.4.2 From the base unit to a cordless handset

Example: When the base unit transfers a call to cordless handset 1

1. Base unit:

During an outside call, press **[LOCATOR/INTERCOM]** and **[1]** (desired cordless handset number) to page the cordless handset.

- The outside call will be put on hold.
- If there is no answer, press **[LOCATOR/INTERCOM]** to return to the outside call.

2. Cordless handset 1:

10. Multi-unit Operation

Press [INT], [↶] or [↷] to answer the page.

3. Base unit:

To complete the call transfer, press [DIGITAL SP-PHONE] or replace the handset.

To establish a conference call, press [3].

To transfer a call without speaking to the cordless handset 1 user

After step 1, press [DIGITAL SP-PHONE] or replace the handset.

If the transferred call is not answered within 60 seconds, the base unit will ring again. Press [LOCATOR/INTERCOM] to return to the outside call.

10.4.3 Between cordless handsets

Example: When cordless handset 1 transfers a call to cordless handset 2

1. Cordless handset 1:

During an outside call, press [INT] and [2] (desired cordless handset number).

- The outside call will be put on hold.
- If there is no answer, press [INT] to return to the outside call.

2. Cordless handset 2:

Press [INT], [↶] or [↷] to answer.

- Cordless handset 2 can talk with cordless handset 1.

3. Cordless handset 1:

To complete the call transfer, press [↵].
To establish a conference call, press [3].

To transfer a call without speaking to the cordless handset 2 user

After step 1, press [↵] on the cordless handset 1.

If the transferred call is not answered within 60 seconds, the cordless handset 1 will ring again. Press [INT] to return to the outside call.

10.5 Copying cordless handset phonebook items

Phonebook items (page 34) can be copied from the cordless handset to the phonebook of another cordless handset.

- Keep the front cover page open for button locations.

Example: When cordless handset 1 is sending phonebook items to cordless handset 2.

1. Establish an intercom call (page 82).

2. Cordless handset 2:

Press [☰] (centre of joystick), select "Recv Phonebook", then press [OK].

3. Cordless handset 1:

Press [☰], select "Send Phonebook", then press [OK].

- If you copy all items, skip to step 5.

4. Cordless handset 1:

Push the joystick up or down repeatedly to select the desired item.

5. Press [OK].

6. Cordless handset 1:

Select "Copy One Item" or "Copy All Items", then press [OK].

- When copying is completed, a beep sounds and "Copy Complete" is displayed. After a few seconds, the cordless handset will return to the intercom call.

Note:

- If cordless handset 2 (the receiver) did not prepare for copying, "Copy Failure" will be displayed on cordless handset 1 (the sender).
- If phonebook memory is full on cordless handset 2 (the receiver), "Copy Incomplete" will be displayed on handset 1 (the sender).

10.6 Walkie-Talkie

This feature allows cordless handsets to communicate with each other directly when they are in range of the same base unit (common base station mode, group mode) and even when outside the range of the base unit (group mode only).

- Keep the front cover page open for button locations.

Important:

- **The maximum distance possible between 2 cordless handsets using Walkie-Talkie is 300 metres outdoors. Actual performance will vary depending on usage conditions.**
- **When using Walkie-Talkie, talk time is about 6 hours; standby time is about 15 hours. Actual performance will vary depending on usage conditions. To improve battery performance, turn OFF the cordless handsets when not talking.**
- **Outside calls cannot be received while in Walkie-Talkie mode.**

10.6.1 Changing the Walkie-Talkie mode

There are two Walkie-Talkie modes, common base station and group.



Common base station mode: Communication is possible between cordless handsets registered to a common base unit. If the cordless handsets are registered to more than one base unit, the same base unit must be selected.

Group mode: Communication is possible between cordless handsets that are both set to Walkie-Talkie mode and have the same 3-digit group ID. This allows cordless handsets to communicate in Walkie-Talkie mode regardless of which base unit they are registered to.

The default setting is group.

Important:

- **When in common base station mode, the cordless handsets cannot have Walkie-Talkie conversations if the base unit selection is set to "Auto" (page 81). Either select a base unit number, or change the Walkie-Talkie mode to "Group".**



- 1 Press  (centre of joystick).
- 2 Select , then press **OK**.
- 3 Select "Setting", then press **OK**.
- 4 Select the desired mode, then press **OK**.

- If "Common" is selected, skip to step 7.
- 5 If "Group" is selected, enter a 3-digit group ID, then press **OK**.
 - The default ID is "000".
 - 6 Assign a cordless handset number (1–9) to be used during Walkie-Talkie conversations, then press **OK** 2 times.
 - This number is displayed on the cordless handset only when using Walkie-Talkie. It does not affect other operations.
 - 7 Press .

Note:

- To set the Walkie-Talkie mode to common base station mode, the cordless handset must be within range of a base unit.

10.6.2 Turning Walkie-Talkie ON

- 1 Press  (centre of joystick).
- 2 Select , then press **OK**.
- 3 Select "On", then press **OK**.
 - The display changes to the Walkie-Talkie display, and the cordless handset's Walkie-Talkie number is displayed.

Note:





- If a cordless handset is outside the range of a base unit and the Walkie-Talkie mode is set to common mode, Walkie-Talkie cannot be turned ON.
- This feature is turned OFF when the cordless handset is turned OFF.

Turning Walkie-Talkie OFF

1. Press  (centre of joystick).
2. Select "Off", then press **OK**.

10.6.3 Starting Walkie-Talkie conversations

Be sure to turn Walkie-Talkie ON beforehand on both cordless handsets.

- 1 Press , , or **[INT]**, then the other cordless handset's Walkie-Talkie number.
 - The other cordless handset will ring if it is within range.
- 2 The other cordless handset user can answer the call by pressing , , or **[INT]**.
- 3 When finished talking, press .

11.1 Using the belt clip

You can hang the cordless handset on your belt or pocket using the included belt clip.

To attach the belt clip

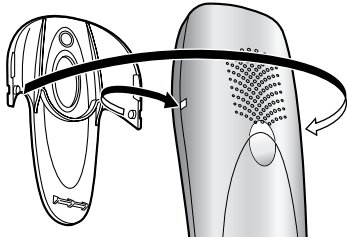

To remove the belt clip



11.2 Using an optional headset

Connecting an optional headset to the cordless handset allows hands-free phone conversations. Please use only the Panasonic headset noted on page 11.

The speakerphone is not available while a headset is plugged into the cordless handset. To switch to speakerphone, disconnect the headset.

To connect an optional headset

Open the headset jack cover and plug the optional headset into the headset jack as shown.

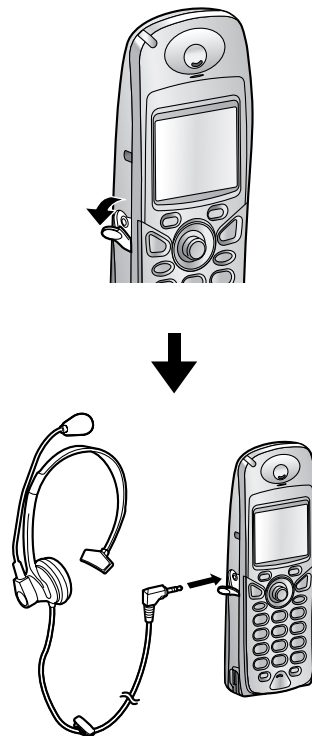

Note:

- Insert the connector plug into the headset jack firmly.

11.3 Wall mounting the charger

- 1 Connect the AC adaptor.
- 2 Drive the screws (①) into the wall using the wall template as a guide, then mount the charger securely on the screws.
 - Fasten the AC adaptor cord around the hooks (②) to prevent it from being disconnected.

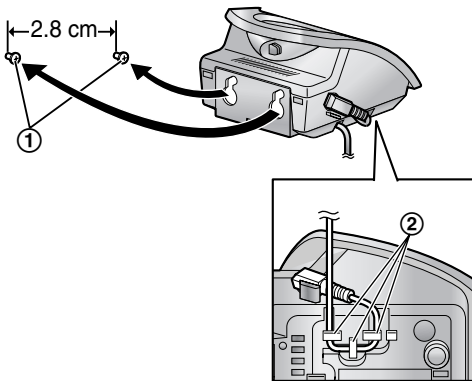

Note:

- Make sure the screws are securely fastened to the wall.

Wall template for charger

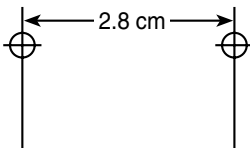

11.4 Available character entries for the cordless handset

The cordless handset dial keys are used to enter characters and numbers. Each dial key has multiple characters assigned to it. The available character entry modes are; **ABC** (Alphabet), **0-9** (Numeric), **ABΓ** (Greek), **AAA** (Extended 1), **SSS** (Extended 2), and **AБB** (Cyrillic). When in **ABC**, **ABΓ**, **AAA**, **SSS**, or **AБB** character entry modes, you can select which character is entered by pressing a dial key repeatedly.

- Move the joystick to move the cursor.
- Press dial keys to enter characters and numbers.
- Press **[C]** to erase the character or number highlighted by the cursor. Press and hold **[C]** to erase all characters or numbers.
- Press **[*]** to switch between uppercase and lowercase.
- To enter another character located on the same dial key, push the joystick right to move the cursor to the next space, then press the appropriate dial key. (This is not necessary when entering text in LetterWise mode.)

11.4.1 Character entry modes

Press the right soft key repeatedly to select the desired character entry mode.

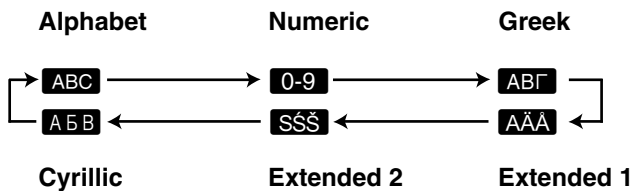

ABC Alphabet character table

0	1	ABC 2	DEF 3	GHI 4	JKL 5	MNO 6	PQRS 7	TUV 8	WXYZ 9
Space 0	Space # & ' () * , - . / 1	A B C 2 a b c 2	D E F 3 d e f 3	G H I 4 g h i 4	J K L 5 j k l 5	M N O 6 m n o 6	P Q R S 7 p q r s 7	T U V 8 t u v 8	W X Y Z 9 w x y z 9

0-9 Numeric entry table

0	1	ABC 2	DEF 3	GHI 4	JKL 5	MNO 6	PQRS 7	TUV 8	WXYZ 9
0	1	2	3	4	5	6	7	8	9

ABΓ Greek character table

0	1	ABC 2	DEF 3	GHI 4	JKL 5	MNO 6	PQRS 7	TUV 8	WXYZ 9
Space 0	Space # & ' () * , - . / 1	A B Γ 2 Α Β Γ 2	Δ E Z 3 Δ E Z 3	H Θ I 4 H Θ I 4	K Λ M 5 K Λ M 5	N Ξ O 6 N Ξ O 6	Π P Σ 7 Π P Σ 7	T Y Φ 8 T Y Φ 8	X Ψ Ω Ξ 9 X Ψ Ω Ξ 9

AAA Extended 1 character table

0	1	ABC 2	DEF 3	GHI 4	JKL 5	MNO 6	PQRS 7	TUV 8	WXYZ 9
Space 0	Space # & ' () * , - . / 1	A À Á Â Ã Ä Å Æ B C Ç 2	D E È É Ê Ë Ë F 3	G Ğ H I Ì Í Î Ï 4	J K L 5	M N Ñ O Ò Ó Ô Ö Ø ø 6	P Q R S Ş ß 7	T U Ù Ú Û Ü Û V 8	W Ŵ X Y ŷ Z 9
		a à á â ã ä å æ b c ç 2	d e è é ê ë ë f 3	g ğ h i ì í î ï 4	j k l 5	m n ñ o ò ó ô õ ö ø 6	p q r s ş ß 7	t u ù ú û ü ü v 8	w ŵ x y ŷ z 9

- The following are used for both uppercase and lowercase:

ø Ş Ŵ ŷ

SSŠ Extended 2 character table

0	1	ABC 2	DEF 3	GHI 4	JKL 5	MNO 6	PQRS 7	TUV 8	WXYZ 9
Space 0	Space # & ' () * , - . / 1	A Á Ä Å B C Ć Č 2	D Ď E É Ě ě F 3	G H I Í 4	J K L Ł Ł Ł 5	M N Ń Ń O Ó Ö Ő 6	P Q R Ŕ Ŕ S Š Š 7	T Ť U Ú Ů ů ú v 8	W X Y ŷ Ý Z Ž Ž Ž 9
		a á ä Å b c Ć Č 2	d ě e é Ě ě f 3	g h i í 4	j k l ł Ł Ł 5	m n Ń Ń o ó ö ő 6	p q r ŕ ŕ s š š 7	t ŧ u ú ű ű ű ú v 8	w x y ŷ ý z ž ž ž 9

- The following are used for both uppercase and lowercase:

Å Ć Č Ě Ł Ł Ł Ń Ŕ Š Š ů ŷ Ž Ž Ž

AБB Cyrillic character table

0	1	ABC 2	DEF 3	GHI 4	JKL 5	MNO 6	PQRS 7	TUV 8	WXYZ 9
Space 0	Space # & ' () * , - . / 1	A Б В Г 2	Д Е Ж З 3	И Ы К Л 4	М Н О П 5	Р С Т У 6	Ф Х Ц Ч 7	Ш Щ Ъ Ы 8	Ь Э Ю Я 9

12.1 Error messages – Reports

If a problem occurs during fax transmission or reception, one of the following messages will be printed on the sending and journal reports (page 44).

COMMUNICATION ERROR

(Code: 40-42, 46-72, FF)

- A transmission or reception error occurred. Try again or check with the other party.

COMMUNICATION ERROR

(Code: 43, 44)

- A line problem occurred. Connect the telephone line cord to a different jack and try again.
- An overseas transmission error occurred. Try using the overseas mode (feature #23 on page 67).

DOCUMENT JAMMED

- The document is jammed. Remove the jammed document (page 102).

ERROR-NOT YOUR UNIT

(Code: 54, 59, 70)

- A transmission or reception error occurred because of a problem with the other party's fax machine. Check with the other party.

JUNK FAX PROH. REJECT

- The fax was rejected by the junk fax prohibitor feature (page 53).

MEMORY FULL

- The memory is full of received documents due to a lack of recording paper or a recording paper jam. Install paper (page 20) or clear the jammed paper (page 100).

NO DOCUMENT

- The document was not fed into the unit properly. Re-insert it and try again.

OTHER FAX NOT RESPONDING

- The other party's fax machine is busy or has run out of recording paper. Try again.
- The other party's fax machine rings too many times. Send the fax manually (page 43).
- The other party's machine is not a fax machine. Check with the other party.
- The number you dialled is not in service.

PRESSED THE STOP KEY

- **[STOP]** was pressed, and fax transmission or reception was cancelled.

OK

- Fax transmission or reception was successful.

12.2 Error messages – Base unit display

If the unit detects a problem, one or more of the following messages will appear on the display.

BUSY

- The cordless handset you tried to call is in use.
- The cordless handset you are calling is too far from the base unit.

CALL SERVICE

CALL SERVICE 2

- There is something wrong with the unit. Contact our service personnel.

CHECK DOCUMENT

- The document was not fed into the unit properly. Re-insert the document. If misfeeding occurs frequently, clean the document feeder rollers (page 104) and try again.
- Attempted to send a document longer than 600 mm. Press **[STOP]** to remove the document. Divide the document into two or more sheets and try again.

CHECK FILM

- The ink film is empty. Replace the ink film with a new one (page 19).
- The ink film is not installed. Install it (page 17).
- The ink film is slack or creased. Tighten it (see step 5 on page 17).

CHECK MEMORY

- Memory (telephone numbers, parameters, etc.) has been erased. Re-program.

CHECK PAPER

- Recording paper is not installed or the unit has run out of paper. Install paper and press **[START]** to clear the message.
- The recording paper was not fed into the unit properly (page 102). Reinstall paper (page 20) and press **[START]** to clear the message.
- The recording paper has jammed near the recording paper entrance. Clear the jammed paper (page 100) and press **[START]** to clear the message.

CLOSE TENSION PLATE

- The tension plate is open. Close it (page 20).

COVER OPEN

- The back cover is open. Close it.

FAX IN MEMORY

- The unit has a document in memory. See the other displayed message instructions to print out the document. For fax memory capacity, see page 107.

FAX MEMORY FULL

- The memory is full of received documents due to a lack of recording paper or a recording paper jam. Install paper (page 20) or clear the jammed paper (page 100).
- When performing memory transmission, the document being stored exceeded the memory capacity of the unit. Send the entire document manually.

FILM EMPTY

- The ink film is empty. Replace the ink film with a new one (page 19).
- The ink film is slack. Tighten it (see step 5 on page 17) and install again.
- The fax machine is positioned near appliances such as TVs or speakers which generate an intense magnetic field.

FILM NEAR EMPTY

- The remaining ink film is low. Prepare a new ink film (page 11).

MEMORY FULL

- There is no space to store new items in the base unit phonebook. Erase unnecessary items (page 37).
- When making a copy, the document being stored exceeded the memory capacity of the unit. Press **[STOP]** to clear the message. Divide the document into sections.

MESSAGE FULL

- There is no memory available to record voice messages. Erase unnecessary messages (page 58, 60).

MODEM ERROR

- There is something wrong with the unit's modem. Contact our service personnel.

NO FAX REPLY

- The other party's fax machine is busy or has run out of recording paper. Try again.

**OPEN CABINET
CHECK FILM SLACK****OPEN CABINET
CHECK FILM TYPE**

- Please use genuine Panasonic replacement film (page 11).
- The ink film is slack. Tighten it (see step 5 on page 17).
- The fax machine is positioned near appliances such as TVs or speakers which generate an intense magnetic field.

PAPER JAMMED

- A recording paper jam occurred. Clear the jammed paper (page 100).

PLEASE WAIT

12. Help

- The unit is checking that there is no slack or crease on the ink film. Wait for a moment while the check is completed.

POLLING ERROR

- The other party's fax machine does not support polling. Check with the other party.

RECORDING ERROR

- The greeting message or voice memo you recorded was under 1 second long. Record a longer message.

REDIAL TIME OUT

- The other party's fax machine is busy or has run out of recording paper. Try again.

REMOVE DOCUMENT

- The document is jammed. Remove the jammed document (page 102).
- Press **[STOP]** to eject the jammed document.

SERIAL ERROR

- There is something wrong with the unit and the base unit will not work. Contact our service personnel. To make or receive calls, use the cordless handset.

TRANSMIT ERROR

- A transmission error occurred. Try again.

UNIT OVERHEATED

- The unit is too hot. Stop using the unit for a while and let the unit cool down.

12.3 When a function does not work, check here

If you still have difficulties after following the instructions in this section, reset the unit. Disconnect the power cord and turn OFF the cordless handset. Reconnect the power cord and turn ON the cordless handset.

12.3.1 Initial settings

Problem	Cause & Solution
I cannot hear a dial tone.	<ul style="list-style-type: none"> • If you use a splitter to connect the unit, remove the splitter and connect the unit to the wall jack directly. If the unit operates properly, check the splitter. • Disconnect the unit from the telephone line and connect a known working telephone. If the working telephone operates properly, contact our service personnel to have the unit repaired. If the working telephone does not operate properly, contact your telephone company. • The power cord or telephone line cord is not connected. Check the connections. • If you connected the fax machine through a computer modem, connect the fax machine directly to a telephone line jack.
I cannot make calls.	<ul style="list-style-type: none"> • The call bar feature is set. Turn it OFF (feature #28 on page 68, or page 76). • The dialling mode setting may be wrong. Change the setting (feature #13 on page 66, or page 79).
The unit does not ring.	<ul style="list-style-type: none"> • The ringer volume is turned OFF. Adjust it (page 25).

12.3.2 General

Problem	Cause & Solution
The unit displays "CHECK PAPER" even though paper is inserted.	<ul style="list-style-type: none"> • The paper is inserted halfway. Insert it correctly (page 20) and press [START] to clear the message.
The other party complains they only hear a fax tone and cannot talk.	<ul style="list-style-type: none"> • FAX ONLY mode is set. Tell the other party the number is only used for faxes. • Change the receiving mode to TAM/FAX mode (page 50) or TEL mode (page 49).
The [REDIAL] [PAUSE] button does not function properly.	<ul style="list-style-type: none"> • If this button is pressed during dialling, a pause will be inserted. If pressed immediately after a dial tone is obtained, the last number dialled will be redialled.
The receiving mode does not function properly.	<ul style="list-style-type: none"> • The Distinctive Ring is set (feature #31 on page 68).
During programming, I cannot enter the code or ID number.	<ul style="list-style-type: none"> • All or part of the numbers are the same as another code or ID. Change the number: <ul style="list-style-type: none"> – remote operation ID: page 61, or feature #11 on page 66. – fax activation code: feature #41 on page 69.

Problem	Cause & Solution
The ink film runs out quickly.	<ul style="list-style-type: none"> • The help printing function, copy function, and reports also use ink film. • Even if there are only a few sentences, every page that comes out of the machine is considered a full page. • Turn OFF the following features: <ul style="list-style-type: none"> – sending report: feature #04 on page 66. – journal report: feature #22 on page 67. – Caller ID list: feature #26 on page 68.
The base unit beeps.	<ul style="list-style-type: none"> • Recording paper/ink film has run out. Press [STOP] to stop the beeps and install paper/ink film.
The speakerphone is not working.	<ul style="list-style-type: none"> • Use the speakerphone in a quiet room. • If you have difficulty hearing the other party, adjust the volume.
I cannot page a cordless handset or base unit.	<ul style="list-style-type: none"> • The called cordless handset is too far from the base unit. • The called unit is in use. Try again later.
Caller information is not displayed.	<ul style="list-style-type: none"> • You have not subscribed to Caller ID service. • The caller requested not to send his/her information.
While viewing caller information, the display returns to standby mode.	<ul style="list-style-type: none"> • Do not pause for over 1 minute on the cordless handset or 3 minutes on the base unit while searching.

12.3.3 Cordless handset

Problem	Cause & Solution
The cordless handset does not work.	<ul style="list-style-type: none"> • Make sure that the batteries are installed correctly (page 21). • Charge the batteries fully (page 23). • Clean the charge contacts and charge again (page 23). • Turn the cordless handset power OFF, then ON (page 24). • Check that the power cord is connected properly. • The cordless handset has not been registered to the base unit. Register the cordless handset (page 81). • Re-install the batteries (page 21) and charge them fully.
The cordless handset display is blank.	<ul style="list-style-type: none"> • The cordless handset is not turned ON. Turn the power ON (page 24).
The cordless handset will not turn ON.	<ul style="list-style-type: none"> • Make sure that the batteries are installed correctly (page 21). • Charge the batteries fully (page 23). • Clean the charge contacts and charge again (page 23).
Y is flashing.	<ul style="list-style-type: none"> • The cordless handset is not registered to the base unit. Register it (page 81). • The cordless handset is too far from the base unit. Move closer. • The power cord is not connected. Check the connections.
The batteries should be charging but the battery icon does not change.	<ul style="list-style-type: none"> • Clean the charge contacts and charge again (page 23). • The AC adaptor is disconnected. Plug in the AC adaptor.
A busy tone is heard when [] is pressed.	<ul style="list-style-type: none"> • The cordless handset is too far from the base unit. Move closer and try again. • The base unit or another cordless handset is on an outside call. Wait for the other user to complete the call.

Problem	Cause & Solution
Static, sound cuts in/out, fades. Interference from other electrical units.	<ul style="list-style-type: none"> ● Move the cordless handset and the base unit away from other electrical appliances. ● Move closer to the base unit.
The cordless handset stops working while being used.	<ul style="list-style-type: none"> ● Disconnect the power cord and turn OFF the cordless handset to reset the unit. Connect the power cord, turn ON the cordless handset and try again. ● You pressed a dialling button when the call bar feature was turned ON (page 76). ● You dialled a number registered for the call restriction feature (page 79).
While storing an item in the phonebook or assigning a hot key, the cordless handset starts to ring.	<ul style="list-style-type: none"> ● To answer a call, press [📞] or [📞]. Storing will be cancelled. Store the name and number again.
I cannot redial by pressing [📞].	<ul style="list-style-type: none"> ● If the redialled number was more than 24 digits long, the number will not be redialled. Redial the number manually.
[📞] flashes or the cordless handset beeps intermittently while it is in use.	<ul style="list-style-type: none"> ● Charge the batteries fully (page 23).
I charged the batteries fully, but [📞] still flashes.	<ul style="list-style-type: none"> ● Clean the charge contacts and charge again (page 23). ● It is time to replace the batteries (page 21).
I cannot receive documents by pressing [*][#][9] on the cordless handset.	<ul style="list-style-type: none"> ● You must set remote fax activation to ON (feature #41 on page 69) beforehand. ● Press [*][#][9] firmly. ● The memory is full of received documents due to a lack of recording paper or a recording paper jam. Install paper (page 20) or clear the jammed paper (page 100). ● The call bar feature was activated on the cordless handset. Deactivate this feature (page 76). ● The direct call feature (page 76) was activated on the cordless handset. Deactivate this feature.
I cannot make a call with the cordless handset.	<ul style="list-style-type: none"> ● The call bar feature is set. Turn it OFF (page 76). ● You dialled a call restricted number. Remove the number from the call restricted list (page 79). ● The key lock feature is turned ON. Turn it OFF (page 31).
I cannot register a cordless handset to a base unit.	<ul style="list-style-type: none"> ● The maximum number of base units are already registered to the cordless handset. Cancel unused base unit registrations from the cordless handset (page 82). ● The maximum number of cordless handsets are already registered to the base unit. Cancel unused cordless handset registrations from the base unit (page 81). ● You entered the wrong PIN. If you forget your PIN, consult your nearest Panasonic service centre. ● Locate the cordless handset and the base unit away from other electrical appliances.

12.3.4 Fax – sending

Problem	Cause & Solution
I cannot send documents.	<ul style="list-style-type: none"> • The other party's fax machine is busy or has run out of recording paper. Try again. • The other party does not have a fax machine. Check with the other party. • The other party's fax machine failed to answer the fax automatically. Send the fax manually (page 43).
I cannot send a fax overseas.	<ul style="list-style-type: none"> • Use the overseas transmission mode of feature #23 (page 67). • Add two pauses at the end of the telephone number or dial manually.
The other party complains that letters on their received document are distorted or not clear.	<ul style="list-style-type: none"> • If your line has special telephone services such as call waiting, the service may have been activated during fax transmission. Connect the unit to a line that does not have these services. • Another telephone on the same line is off the hook. Hang up the telephone and try again. • Try copying the document. If the copied image is clear, there may be something wrong with the other party's machine. • Adjust the scan contrast using feature #58 (page 69).
The other party complains that black lines, white lines or smudges appear on their received document.	<ul style="list-style-type: none"> • The scanner glass, white plate or rollers are dirty with correction fluid, etc. Clean them (page 104). Please do not insert a document before correction fluid has dried completely.



12.3.5 Fax – receiving

Problem	Cause & Solution
I cannot receive documents.	<ul style="list-style-type: none"> • The ink film is empty. Replace the ink film with a new one (page 19).
I cannot receive documents automatically.	<ul style="list-style-type: none"> • The receiving mode is set to TEL mode. Change the receiving mode to TAM/FAX mode (page 50) or FAX ONLY mode (page 52). • The time taken to answer the call is too long. Decrease the number of rings before the unit answers a call (page 61, or feature #06 on page 66). • The greeting message is too long. Record a shorter message (page 57, 59).
The display shows "CONNECTING. . . .", but faxes are not received.	<ul style="list-style-type: none"> • The receiving mode is set to FAX ONLY mode and the incoming call is not a fax. Change the receiving mode to TEL mode (page 49) or TAM/FAX mode (page 50).
A blank sheet is ejected.	<ul style="list-style-type: none"> • If a blank sheet is ejected after the received document is printed out, the size of the document sent by the other party is as large as, or larger than, the recording paper, or the receiving reduction rate is not programmed correctly. Program the proper rate in feature #36 (page 68). • The other party placed the document in their fax machine the wrong way. Check with the other party.

Problem	Cause & Solution
The printing quality is poor.	<p>Please do not reuse the ink film! Please use genuine Panasonic replacement film. Refer to page 11 for further details.</p> <ul style="list-style-type: none"> • The thermal head is dirty. Clean it (page 105). • Some paper has instructions recommending which side to print on. Try turning the paper over. • You may have used paper with a cotton and/or fibre content that is over 20%, such as letterhead or resume paper. • If documents can be copied properly, the unit is working normally. The other party may have sent a faint document or there may be something wrong with the other party's machine. Ask them to send a clearer copy of the document or to check their fax machine.
The other party complains that they cannot send a document.	<ul style="list-style-type: none"> • The receiving mode is set to TEL mode. Receive the document manually (page 49) or change the receiving mode to TAM/FAX mode (page 50) or FAX ONLY mode (page 52). • The memory is full of received documents due to a lack of recording paper or a recording paper jam. Install paper (page 20) or clear the jammed paper (page 100).
I cannot receive documents by pressing [*][#][9] on the cordless handset.	<ul style="list-style-type: none"> • You must set remote fax activation to ON (feature #41 on page 69) beforehand. • Press [*][#][9] firmly. • The memory is filled with received documents due to a lack of recording paper or a recording paper jam. Install paper (page 20) or clear the jammed paper (page 100). • The call bar feature was activated on the cordless handset. Deactivate this feature (page 76). • The direct call feature (page 76) was activated on the cordless handset. Deactivate this feature.
I cannot select the desired receiving mode.	<ul style="list-style-type: none"> • If you want to set TAM/FAX or FAX ONLY mode, set the desired mode using feature #77 (page 70), and press [AUTO ANSWER] repeatedly to select the desired mode. • If you want to set TEL mode, press [AUTO ANSWER] repeatedly to select TEL mode. • The Distinctive Ring is set (feature #31 on page 68).

12.3.6 Copying

Problem	Cause & Solution
The unit will not make a copy.	<ul style="list-style-type: none"> • The ink film is empty. Replace the ink film with a new one (page 19). • You cannot make a copy during programming. • You cannot make a copy during a telephone conversation.
A black line, a white line or smudge appears on the copied document.	<ul style="list-style-type: none"> • The scanner glass, white plate or rollers are dirty with correction fluid, etc. Clean them (page 104). Please do not insert a document before correction fluid has dried completely.
The copied image is distorted.	<ul style="list-style-type: none"> • Adjust the width of the document guides to fit the actual size of the document.

Problem	Cause & Solution
The printing quality is poor.	<p>Please do not reuse the ink film! Please use genuine Panasonic replacement film. Refer to page 11 for further details.</p> <div style="display: flex; justify-content: space-around; align-items: center;"> <div style="text-align: center;"> <p>Original</p>  </div> <div style="text-align: center;"> <p>Copy</p>  </div> </div> <ul style="list-style-type: none"> • Some paper has instructions recommending which side to print on. Try turning the paper over. • You may have used paper with a cotton and/or fibre content that is over 20%, such as letterhead or resume paper. • The thermal head is dirty. Clean it (page 105).

12.3.7 Answering machine

Problem	Cause & Solution
The answering machine is turned ON, but caller messages are not recorded.	<ul style="list-style-type: none"> • The recording time is set to “GREETING ONLY”. Select “1 MINUTE” or “NO LIMIT” (page 61, or feature #10 on page 66). • The message memory is full. Erase unnecessary messages (page 58, 60).
I cannot operate the answering machine with the cordless handset.	<ul style="list-style-type: none"> • Another user is using the answering machine, accessing the Caller ID list or on an outside call. Wait for the other user to finish. • Another cordless handset user is changing program using the base unit PIN (page 78). Wait for the other user to finish. • A caller is leaving a message. Wait for the caller to finish. • The cordless handset is too far from the base unit. Move closer.
I cannot retrieve recorded messages from a remote location.	<ul style="list-style-type: none"> • Activate the remote operation feature by setting the remote operation ID beforehand (page 61, or feature #11 on page 66). • Press the remote operation ID correctly and firmly (page 63). • The unit is not in TAM/FAX mode. Change to TAM/FAX mode (page 50).
The other party complains that they cannot leave a voice message.	<ul style="list-style-type: none"> • The memory is full. Erase unnecessary messages (page 58, 60). • The recording time is set to “GREETING ONLY”/“Greeting Only”. Select “1 MINUTE”/“1 Minute” or “NO LIMIT”/“No Limit” (page 61, or feature #10 on page 66).
While recording a greeting message or listening to messages, the unit rings and recording stops.	<ul style="list-style-type: none"> • A call is being received. Answer the call and try again later.

12.3.8 If a power failure occurs

- The unit will not function.
- The unit is not designed for making emergency telephone calls when the power fails. Alternative arrangements should be made for access to emergency services.
- Fax transmission and reception will be interrupted.
- If delayed transmission (feature #25 on page 67) is programmed and power failure prevents the document from being sent at the set time, the document will be sent after power is restored.
- If any fax documents are stored in the memory, they will be lost. When power is restored, a power down report will be printed stating which documents in memory have been erased.

Note for Australian users:

- Panasonic Australia operates a toll free Customer Care Centre. Please call 132600 for assistance or visit the website [www.panasonic <http://www.panasonic.com.au>](http://www.panasonic.com.au)

Note for New Zealand users:

- Panasonic New Zealand operates a toll free Customer Support Centre. Please call 0800-Panasonic (0800-726276) for assistance.

12.4 Recording paper jams

12.4.1 When the recording paper has jammed in the unit

The base unit display will show the following.

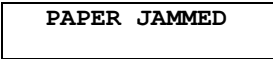

- 1 Pull the tension plate forward (①) to remove the installed paper (②).
 - Do not remove the jammed paper (③).

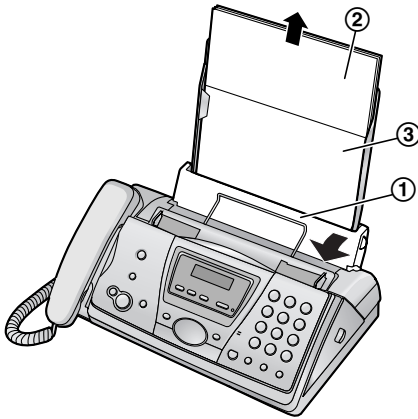

- 2 Remove the paper tray (①).

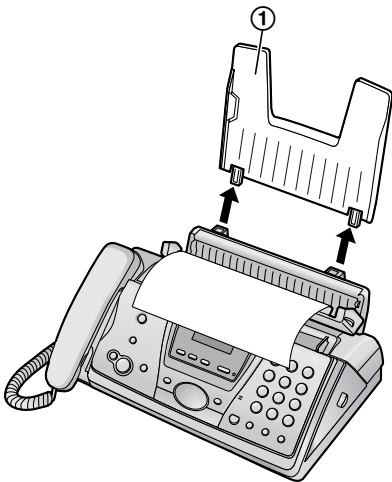

- 3 Open the front cover by pulling up the centre part.

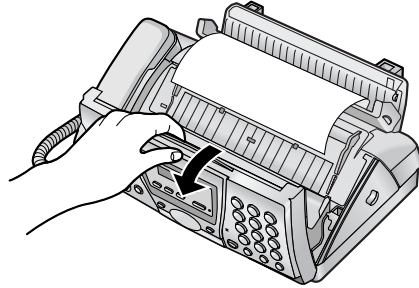

- 4 Release the back cover by pushing the green button (①).

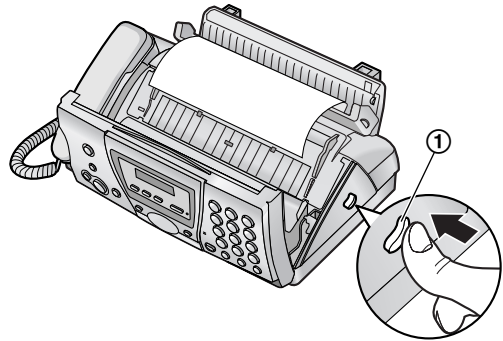

- 5 Open the back cover.

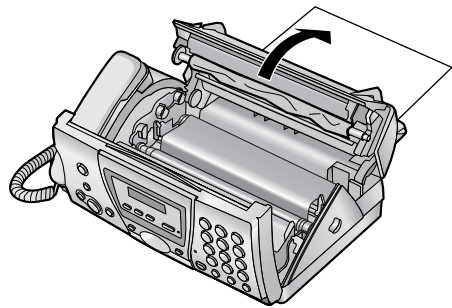

- 6 Remove the jammed recording paper (①).

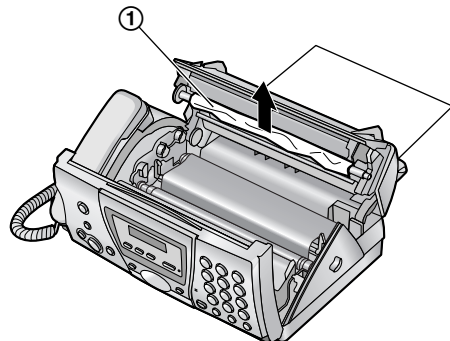

- 7 Turn the blue gear (①) in the direction of the arrow until the ink film is tight (②).

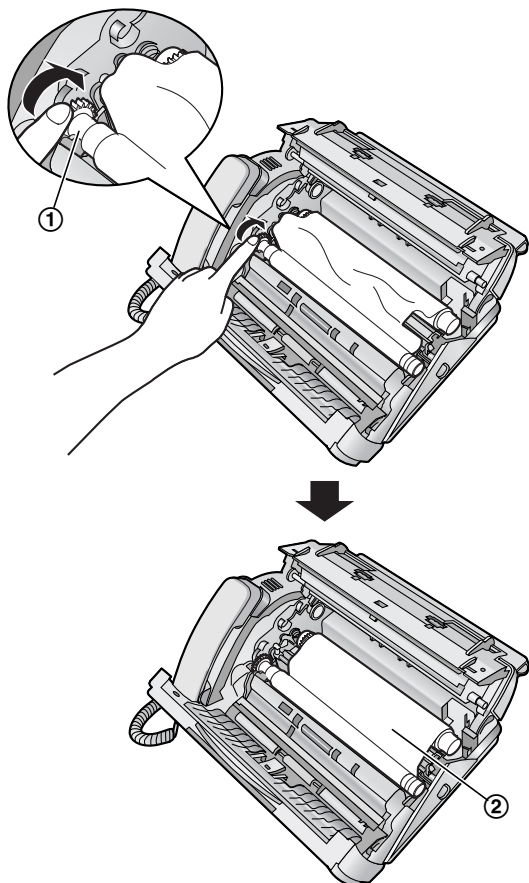

Correct

- The ink film is wrapped around the blue core (③) at least once.

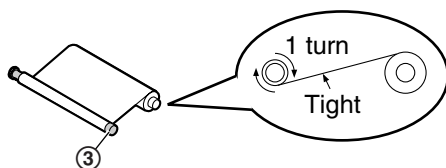

Incorrect

- The ink film is not wrapped around the blue core (④).

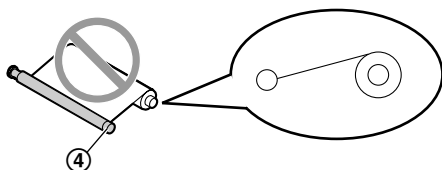

- The ink film is reversed.

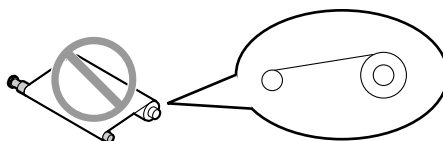

- The ink film is slack or creased.



- 8 Close the back cover securely by pushing down on the notched area at both ends (①).

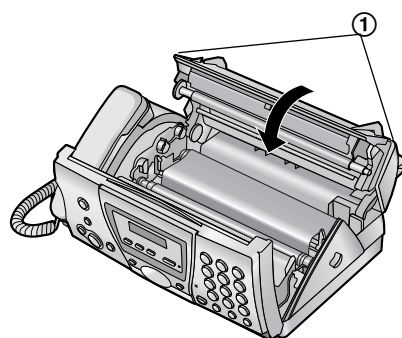

- 9 Close the front cover securely.

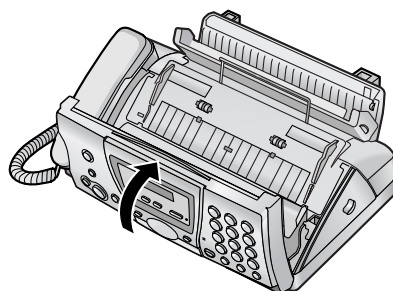

- 10 Install the paper tray (page 19), then insert the recording paper (page 20).

12.4.2 When the recording paper was not fed into the unit properly

The base unit display will show the following.

CHECK PAPER

- 1 Remove the recording paper and straighten.
- 2 Pull the tension plate forward (①) and insert the paper.

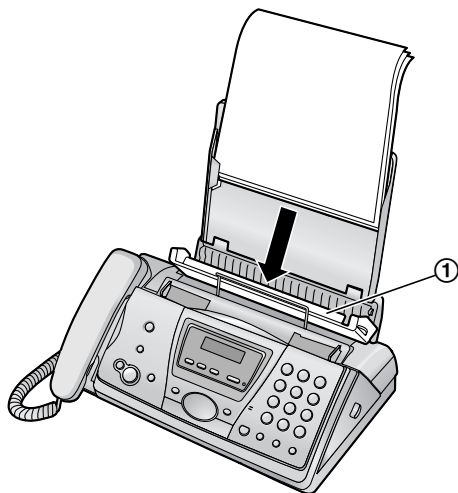

- 3 Push the tension plate back (①), then press **[START]** to clear the message.

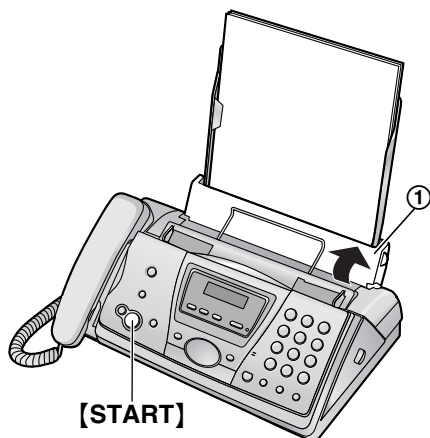

12.5 Document jams – sending

- 1 Open the front cover by pulling up the centre part. Remove the jammed document carefully (①).

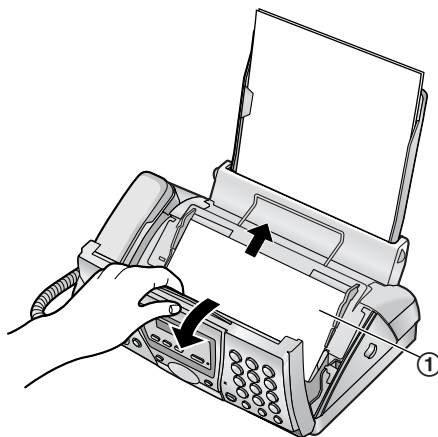

- 2 Close the front cover securely.

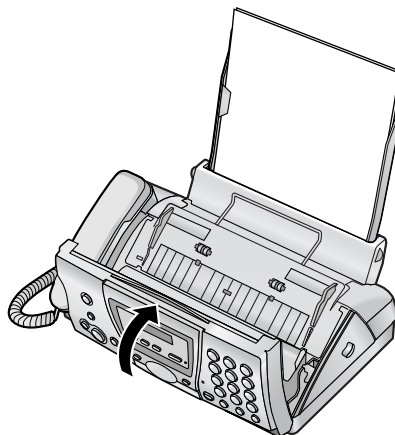

Note:

- Do not pull out the jammed paper forcibly before opening the front cover.



12.6 Recording paper feeder cleaning

Clean the recording paper feeder when the recording paper frequently misfeeds.

Important:

- Remove the recording paper and the paper tray beforehand, or the paper may misfeed or jam.

- 1 Disconnect the power cord and the telephone line cord.
- 2 Open the front cover by pulling up the centre part.

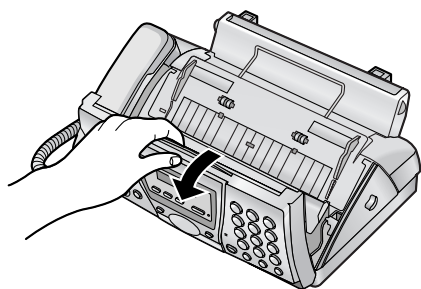

- 3 Release the back cover by pushing the green button (1).

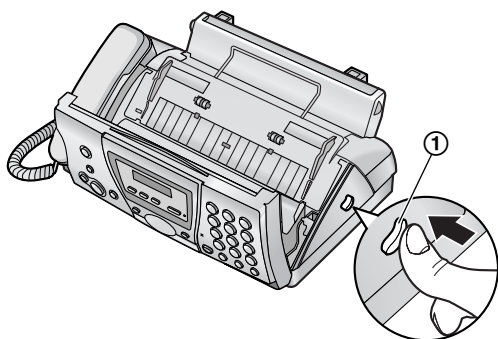

- 4 Open the back cover.

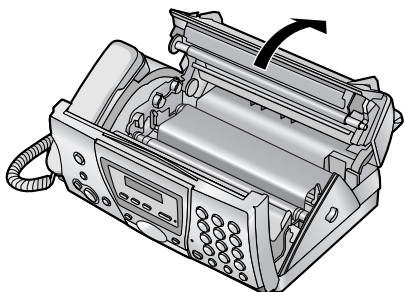

- 5 Open the recording paper feeder cover (1).

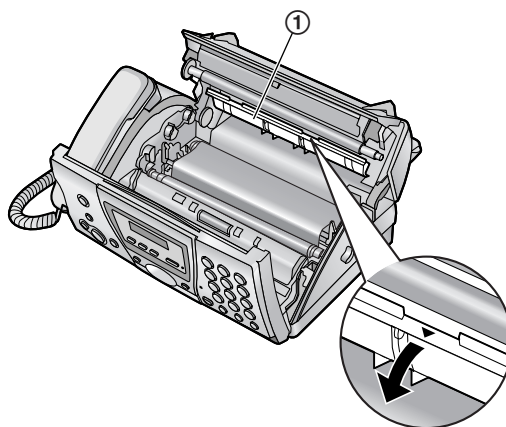

- 6 Clean the recording paper feeder roller (1) with a cloth moistened with isopropyl rubbing alcohol, and let all parts dry thoroughly.

Caution:

- Do not use paper products, such as paper towels or tissues.

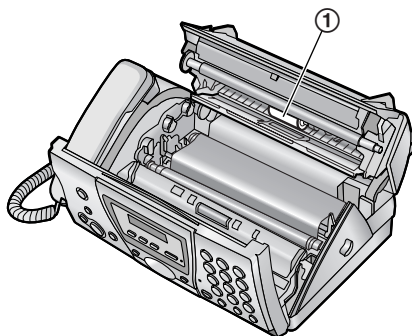

- 7 Close the covers (see steps 8 and 9 on page 101).

- 8 Install the paper tray (page 19), then insert the recording paper (page 20).

- 9 Connect the power cord and the telephone line cord.

12.7 Document feeder / scanner glass cleaning

Clean the document feeder/scanner glass when:

- Documents frequently misfeed.
- Smudges or black/white lines appear on the original document when sending or copying.

- 1 Disconnect the power cord and the telephone line cord.
- 2 Open the front cover by pulling up the centre part.

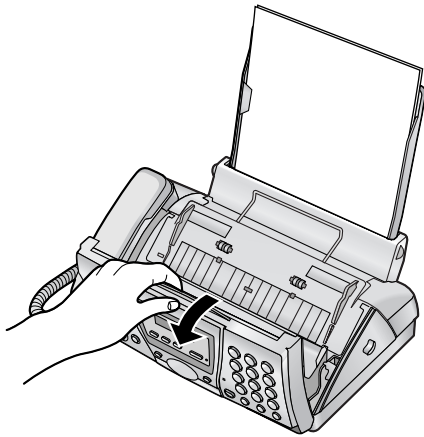

- 3 Clean the document feeder rollers (①) and rubber flap (②) with a cloth moistened with isopropyl rubbing alcohol, and let all parts dry thoroughly.
Clean the scanner glass (③) and white plate opposite the scanner glass (④) with a soft, dry cloth.

Caution:

- Do not use paper products, such as paper towels or tissues.

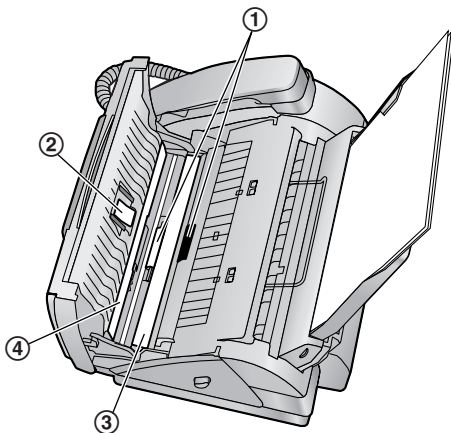

- 4 Close the front cover securely.

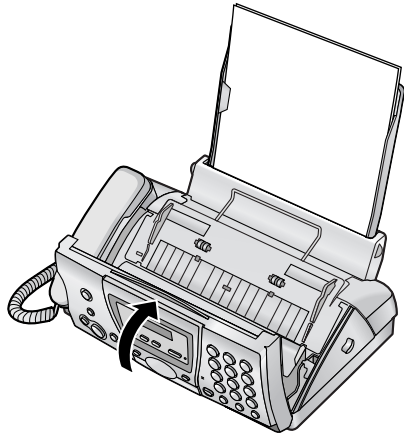

- 5 Connect the power cord and the telephone line cord.

12.8 Thermal head cleaning

If smudges or black/white lines appear on a copied/received document, check whether there is dust on the thermal head. Clean the thermal head to remove the dust.

Important:

- Remove the recording paper and the paper tray beforehand, or the paper may misfeed or jam.

- 1 Disconnect the power cord and the telephone line cord.
- 2 Open the front cover by pulling up the centre part.

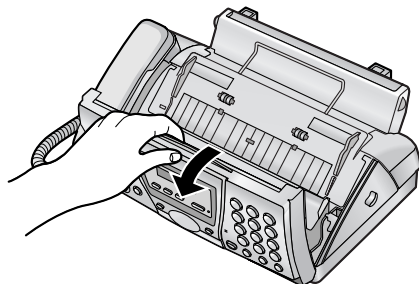

- 3 Release the back cover by pushing the green button (1).

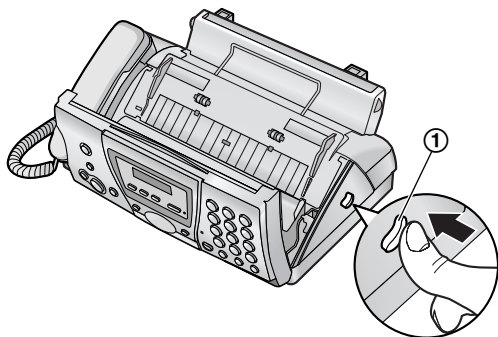

- 4 Open the back cover.

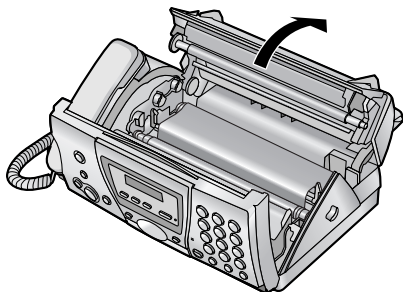

- 5 Remove the ink film (1).

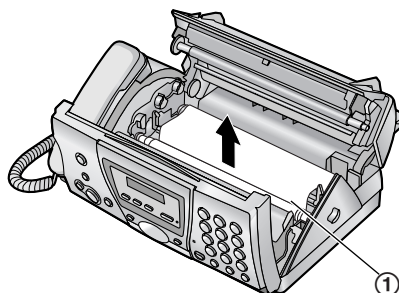

- 6 Clean the thermal head (1) with a cloth moistened with isopropyl rubbing alcohol, and let it dry thoroughly.

Caution:

- To prevent a malfunction due to static electricity, do not use a dry cloth and do not touch the thermal head directly.

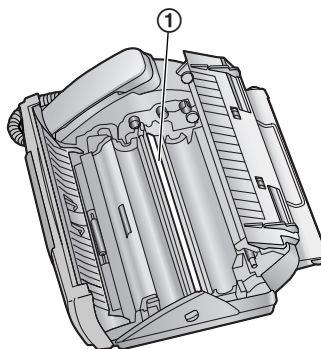

- 7 Reinstall the ink film and close the covers (see steps 4 to 7 on page 17).

- 8 Install the paper tray (page 19), then insert the recording paper (page 20).

- 9 Connect the power cord and the telephone line cord.

13.1 Reference lists and reports (Base unit only)

You can print out the following lists and reports for your reference.

Setup list:

provides you with the current settings of the base unit programming features (page 66 to page 70).

Telephone number list:

provides you with names and numbers which are stored in the base unit phonebook.

Journal report:

keeps records of fax transmission and reception. This report can be printed automatically after every 30 fax communications (feature #22 on page 67).

Printer test:

allows you to check the print quality of your unit. If the test print has a smudge, or blurred points or lines, clean the thermal head (page 105).

Broadcast programming list:

provides you with names and numbers which are stored in the broadcast memory (page 45).

Caller ID list:

keeps records of the last 50 different callers after subscribing to a Caller ID service. To print automatically after every 50 callers, activate feature #26 (page 68).

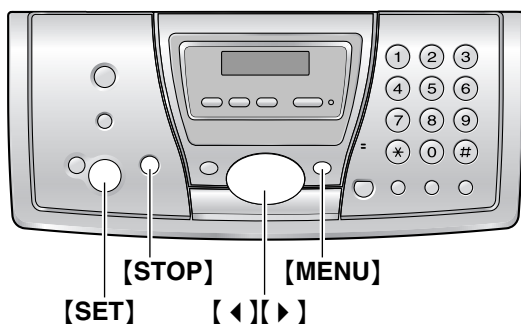

- 1 Press **[MENU]** repeatedly to display “**PRINT REPORT**”.
- 2 Press **[◀]** or **[▶]** repeatedly to display the desired item.
- 3 Press **[SET]** to start printing.
 - To stop printing, press **[STOP]** 2 times.
- 4 Press **[MENU]**.

13.2 Specifications

13.2.1 Base unit

■ Applicable lines:

Public Switched Telephone Network

■ Document size:

Max. 216 mm in width, Max. 600 mm in length

■ Effective scanning width:

208 mm

■ Effective printing width:

A4: 202 mm

■ Transmission time*1:

Approx. 8 s/page (ECM-MMR)*2

■ Scanning density:

Horizontal: 8 pels/mm

Vertical: 3.85 lines/mm – in standard resolution,

7.7 lines/mm – in fine/photo resolution,

15.4 lines/mm – in super fine resolution

■ Photo resolution:

64-level

■ Scanner type:

Contact Image Sensor

■ Printer type:

Thermal Transfer on plain paper

■ Data compression system:

Modified Huffman (MH), Modified READ (MR),

Modified Modified READ (MMR)

■ Modem speed:

14,400 / 12,000 / 9,600 / 7,200 / 4,800 / 2,400

bps; Automatic Fallback

■ Operating environment:

5 °C – 35 °C, 20 % – 80 % RH (Relative

Humidity)

■ Dimensions:

Approx. height 139 mm × width 331 mm × depth

238 mm

■ Mass (Weight):

Approx. 3.1 kg

■ Power consumption:

Standby: Approx. 4.5 W

Transmission: Approx. 15 W

Reception: Approx. 35 W (When receiving a 20 % black document)

Copy: Approx. 40 W (When copying a 20 % black document)

Maximum: Approx. 130 W (When copying a 100 % black document)

■ Power supply:

220 V – 240 V AC, 50/60 Hz

■ Fax memory capacity*3:

Approx. 25 pages of memory transmission

Approx. 30 pages of memory reception

(Based on the ITU-T No. 1 Test Chart in standard resolution, without using the Error Correction Mode.)

■ Voice memory capacity*4:

Approx. 28 minutes of recording time including greeting messages

- *1 Transmission speed depends upon the contents of the pages, resolution, telephone line conditions and capability of the other party's machine.
- *2 Transmission speed is based upon the ITU-T No. 1 Test Chart. If the capability of the other party's machine is inferior to your unit, the transmission time may be longer.
- *3 If an error occurs during fax reception, such as a paper jam or if the recording paper runs out, the fax and subsequent faxes will be retained in memory.
- *4 Recording time may be reduced by the calling party's background noise.

ITU-T No. 1 Test Chart

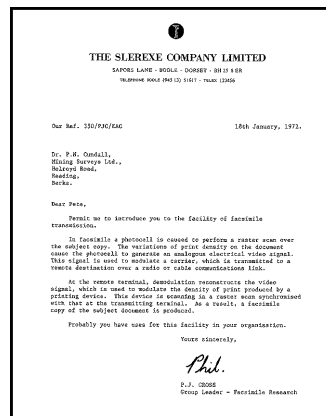

Recording paper specifications

Recording paper size: A4: 210 mm × 297 mm

Recording paper weight: 64 g/m² to 80 g/m²

Note for recording paper:

- Do not use the following types of paper:
 - Paper with a cotton and/or fibre content that is over 20 %, such as letterhead paper or paper used for resumes
 - Extremely smooth or shiny paper, or paper that is highly textured
 - Coated, damaged or wrinkled paper
 - Paper with foreign objects attached, such as tabs or staples
 - Paper which has dust, lint or oil stains

- Paper that will melt, vaporize, discolour, scorch or emit dangerous fumes near 200 °C, such as vellum paper. These materials may transfer onto the fusing roller and cause damage.
- Moist paper
- Some paper only accepts print on one side. Try using the other side of the paper if you are not happy with the print quality or if misfeeding occurs.
- For proper paper feeding and best print quality, we recommend using long-grained paper.
- Do not use paper of different types or thickness at the same time. This may cause a paper jam.
- Avoid double-sided printing.
- Do not use paper printed from this unit for double-sided printing with other copiers or printers. This may cause a paper jam.
- To avoid curling, do not open paper packs until you are ready to use the paper. Store unused paper in the original packaging, in a cool and dry location.

13.2.2 Cordless handset

■ **Standard:**

DECT (Digital Enhanced Cordless Telecommunications)
GAP (Generic Access Profile)

■ **Number of channels:**

120 Duplex Channels

■ **Frequency range:**

1.88 GHz to 1.9 GHz

■ **Duplex procedure:**

TDMA (Time Division Multiple Access)

■ **Channel spacing:**

1,728 kHz

■ **Bit rate:**

1,152 kbit/s

■ **Modulation:**

GFSK

■ **RF transmission power:**

Approx. 250 mW

■ **Voice coding:**

ADPCM 32 kbit/s

■ **Operating environment:**

5 °C – 40 °C, 20 % – 80 % RH (Relative Humidity)

■ **Dimensions:**

Approx. height 143 mm × width 48 mm × depth 32 mm

■ **Mass (Weight):**

Approx. 125 g

13.2.3 Charger unit

■ **Operating environment:**

5 °C – 40 °C, 20 % – 80 % RH (Relative Humidity)

■ **Dimensions:**

Approx. height 60 mm × width 86 mm × depth 84 mm

■ **Mass (Weight):**

Approx. 113 g

■ **Power consumption:**

Standby: Approx. 2.3 W

Maximum: Approx. 6.8 W

■ **Power supply:**

AC adaptor (220 V – 240 V AC, 50/60 Hz)

Note:

- Design and specifications are subject to change without notice.
- The pictures and illustrations in these instructions may vary slightly from the actual product.

14.1 Index

- # #01 Date and time: 27
- #02 Your logo: 28
- #03 Your fax number: 29
- #04 Sending report: 44, 66
- #06 FAX ring setting: 66
- #06 TAM ring setting: 51, 66
- #10 Message recording time: 66
- #11 Remote operation ID: 66
- #13 Dialling mode: 66
- #17 External ringer type: 67
- #22 Automatic journal report: 44, 67
- #23 Overseas mode: 67
- #25 Delayed transmission: 67
- #26 Automatic Caller ID list: 68
- #28 Call bar: 68
- #31 Distinctive Ring: 54
- #34 Quick scan: 43, 55, 68
- #36 Receiving reduction: 68
- #39 Display contrast: 68
- #41 Fax activation code: 69
- #44 Memory reception alert: 69
- #46 Friendly reception: 69
- #54 Greeting recording time: 57, 69
- #58 Scan contrast: 69
- #67 Greeting monitor: 69
- #68 ECM selection: 69
- #74 Location: 69
- #76 Connecting tone: 69
- #77 Auto answer: 70
- #80 Set default: 70
- A** Accessories: 10
 - Belt clip: 86
 - Paper tray: 19
 Additional base units: 81
 Additional cordless handsets: 81
 Advanced features: 67
 Auto answer setting: 70
 Auto talk feature: 33, 76
- B** Base unit
 - PIN: 80
 - Selecting: 81
 Base unit phonebook
 - Editing: 37
 - Erasing: 37
 - Making a phone call: 37
 - Sending faxes: 45
 - Storing: 36
 Basic features: 66
- Battery
 - Charge: 23
 - Installation: 21
 - Life: 23
 - Replacement: 21
 - Type: 77
 Broadcast transmission: 45
 Button description
 - Base unit: 12
 - Cordless handset: 13
- C** Call bar: 68, 76
 Caller ID: 38
 - Calling back: 39
 - Storing: 41
 Caller ID list: 38, 68, 106
 Call minder: 42
 Call restriction: 79
 Call waiting: 38
 Cancelling a base unit: 82
 Cancelling a cordless handset: 81
 Character entry
 - Base unit: 28
 - Cordless handset: 88
 Cleaning: 103, 104, 105
 Conference calls: 83
 Connecting tone: 69
 Connections: 22
 Copy: 55
 - Collation: 56
 - Enlarge: 55
 - Reduce: 55
 Cordless handset
 - Changing name: 76
 - Locator: 83
 - PIN: 76
 - Registration: 81
 Cordless handset phonebook
 - Copying: 84
 - Editing: 35
 - Erasing: 35
 - Making a phone call: 34
 - Storing: 34
- D** Date and time: 26
 Delayed transmission: 67
 Dialling mode: 66
 Direct call: 76
 Display (Base unit)
 - Contrast: 68
 - Error messages: 90
 Display (Cordless handset)
 - Description: 14

14. Index

- Language: 75
- Standby mode: 75
- Talk mode: 75
- Distinctive Ring: 54
- Document size: 44
- E** ECM selection: 69
- Emergency call: 79
- Error messages: 90
- Extension telephone: 49
- F** Fax Ability: 54
- Fax activation code: 69
- Fax number: 29
- Friendly reception: 69
- G** Greeting message: 57, 59
- Greeting message monitor: 61, 69
- H** Headset: 86
- Help: 24
- Hot key: 35
- I** Ink film
 - Installing: 17
 - Replacing: 19
- Intercom: 82
- J** Jams
 - Document: 102
 - Recording paper: 100
- Journal report: 44, 67
- Joystick: 13
- K** Key lock: 31
- Key tone: 75
- L** Listening to recorded messages: 58
 - From a remote location: 63
 - With the cordless handset: 60
- Location setting: 69
- Logo: 28
- M** Memo alarm: 74
- Memory reception alert: 69
- Message recording time: 61, 66
- N** Navigator: 29, 37, 45, 65
- O** Overseas mode: 67
- P** Pause length: 79
- Phonebook
 - Base unit: 36
 - Cordless handset: 34
- PIN
 - Base unit: 80
 - Cordless handset: 76
- Polling: 52
- Power failure: 98
- Power ON/OFF (Cordless handset): 24
- Private category: 38
- Programming
 - Base unit programming: 65
 - Cordless handset programming: 61, 73, 78
- Q** Quick scan: 43, 55, 68
- R** Recall: 79
- Receiving faxes
 - Automatically: 50
 - Manually: 49
- Receiving reduction: 68
- Recording
 - Greeting message: 57, 59
 - Memo message: 59, 60
 - Telephone conversation: 33
- Recording paper: 20, 107
- Recording time for TAM/FAX greeting message: 57, 69
- Redialling
 - Base unit: 32, 43, 45
 - Cordless handset: 31
- Redial list: 31
- Remote operation: 63
- Remote operation ID: 61, 66
- Reports
 - Broadcast programming: 106
 - Broadcast sending: 46
 - Caller ID list: 38, 68, 106
 - Journal: 44, 67, 106
 - Power down: 98
 - Printer test: 106
 - Sending: 44, 66
 - Setup: 106
 - Telephone number: 106
- Reset
 - Base unit: 70, 80
 - Cordless handset: 77
- Resolution: 43, 55
- Ringer type
 - Base unit: 67
 - Cordless handset: 74
- Ring setting
 - FAX ONLY: 66
 - TAM/FAX: 61, 66
- S** Scan contrast: 69
- Sending faxes
 - Base unit phonebook: 45
 - Broadcast: 46
 - From memory: 43
 - Manually: 43

Sending report: *44, 66*

Soft keys: *15*

Storing

Broadcast: *45*

Hot key: *35*

Phonebook: *34, 36*

T Transferring calls: *83*

V Voice time/day stamp: *58*

Volume

Base unit: *25*

Cordless handset: *25*

W Walkie Talkie: *85*

Wall mounting: *87*



Sales Department:

Panasonic Australia Pty. Limited

Austlink Corporate Park, 1 Garigal Road, Belrose, NSW 2085,
Australia

Panasonic New Zealand Limited

350 Te Irirangi Drive, East Tamaki, Private Bag 14911, Panmure,
Auckland, New Zealand

Manufacturer:

Panasonic Communications (Malaysia) Sdn. Bhd.

PLO No.1, Kawasan Perindustrian Senai, KB No. 104, 81400 Senai, Negeri Johor Darul Ta'zim, Malaysia

Global web site:

<http://www.panasonic.co.jp/global/>

Copyright:

- This material is copyrighted by Panasonic Communications Co., Ltd., and may be reproduced for internal use only. All other reproduction, in whole or in part, is prohibited without the written consent of Panasonic Communications Co., Ltd.

© 2004 Panasonic Communications Co., Ltd. All Rights Reserved.

Free Manuals Download Website

<http://myh66.com>

<http://usermanuals.us>

<http://www.somanuals.com>

<http://www.4manuals.cc>

<http://www.manual-lib.com>

<http://www.404manual.com>

<http://www.luxmanual.com>

<http://aubethermostatmanual.com>

Golf course search by state

<http://golfingnear.com>

Email search by domain

<http://emailbydomain.com>

Auto manuals search

<http://auto.somanuals.com>

TV manuals search

<http://tv.somanuals.com>