

# Panasonic

Compact Plain Paper FAX

Model No.

## KX-FP101NZ

### Quick Start



To get started,  
please read the  
Quick Start section  
(p. 4 – 9).

Initial Preparation

Telephone

Fax/Copy

Help

General Information

# OPERATING INSTRUCTIONS

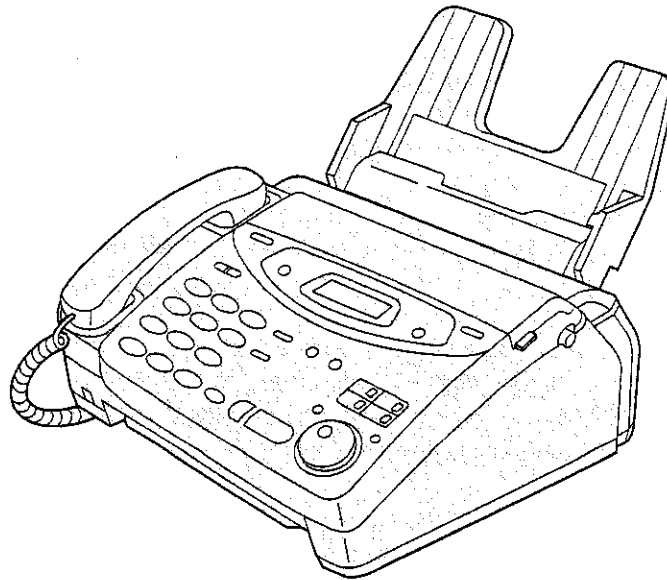

Please read these Operating Instructions  
before using the unit and save for future  
reference.

**Thank you for purchasing a Panasonic facsimile.**

## **Welcome to the world of Panasonic facsimiles.**

This product combines facsimile, telephone and copier features to provide you with more efficient office or home use. By utilizing these convenient features, you can maximize the effectiveness of this unit.

### **Warning:**

- WHEN A FAILURE OCCURS WHICH RESULTS IN THE INTERNAL PARTS BECOMING ACCESSIBLE, DISCONNECT THE POWER SUPPLY CORD IMMEDIATELY AND RETURN THIS UNIT TO AN AUTHORIZED SERVICE CENTER.
- DISCONNECT THE TELECOM CONNECTION BEFORE DISCONNECTING THE POWER CONNECTION PRIOR TO RELOCATING THE EQUIPMENT, AND RECONNECT THE POWER FIRST.
- NO "111" OR OTHER CALLS CAN BE MADE FROM THIS DEVICE DURING A MAINS POWER FAILURE.

### **Caution:**

- Note that the images of copied or received documents will remain on the used film. Use discretion when disposing of the used film cartridge.
- Do not rub or use an eraser on the printed side, as the print may smear.

### **Notice to New Zealand users:**

- The grant of a Telepermit for any item of terminal equipment indicates only that Telecom has accepted that the item complies with minimum conditions for connection to its network. It indicates no endorsement of the product by Telecom, nor does it provide any sort of warranty. Above all, it provides no assurance that any item will work correctly in all respects with another item of Telepermitted equipment of a different make or model, nor does it imply that any product is compatible with all of Telecom's network services.
- This device is equipped with pulse dialling while the Telecom standard is DTMF tone dialling. There is no guarantee that Telecom lines will always continue to support pulse dialling.
- Use of pulse dialling, when this equipment is connected to the same line as other equipment, may give rise to bell tinkle or noise and may also cause a false answer condition. Should such problems occur, that user should NOT contact Telecom Faults Service.
- This equipment shall not be set to make automatic calls to the Telecom "111" Emergency Service.
- This equipment should not be used under any circumstances which may constitute a nuisance to other Telecom customers.
- All persons using this device for recording telephone conversations shall comply with NZ law. This requires that at least one party to the conversation is to be aware that it is being recorded. In addition, the principles enumerated in the Privacy Act 1993 shall be complied with in respect to the nature of the personal information collected, the purpose of its collection, how it is to be used and what it disclosed to any other party.
- This unit will only work in conjunction with a tone signalling (DTMF) telephone, but some telephones are not compatible. Since noise or speech from the telephone can upset dialling from this unit, errors may result if the devices are used together in other than quiet conditions.
- Where it is necessary to dial prefix digits, such as a Caller Display override code ("0196" or "0197"), the unit will have to be used in conjunction with an associated tone signalling (DTMF) telephone. Note that some telephones are not compatible with this unit and dialling errors may result if the two devices are used together in other than quiet conditions. The Telecom Faults Service is not to be called should such problems arise. In such cases, it is recommended that the prefix and wanted number are dialled manually.

### **Copyright:**

This manual is copyrighted by Kyushu Matsushita Electric Co., Ltd. (KME) and its licensee. Under the copyright laws, this manual may not be reproduced in any form, in whole or part, without the prior written consent of KME and its licensee.

© Kyushu Matsushita Electric Co., Ltd. 1999

# Important safety instructions

When using this unit, basic safety precautions should always be followed to reduce the risk of fire, electric shock, or personal injury.

1. Read and understand all instructions.
2. Follow all warnings and instructions marked on this unit.
3. Unplug this unit from AC outlets before cleaning. Do not use liquid or aerosol cleaners. Use a damp cloth for cleaning.
4. Do not use this unit near water, for example near a bath tub, wash bowl, kitchen sink, or the like.
5. Place the unit securely on a stable surface. Serious damage and/or injury may result if the unit falls.
6. Do not cover slots and openings on the unit. They are provided for ventilation and protection against overheating. Never place the unit near radiators, or in a place where proper ventilation is not provided.
7. Use only the power source marked on the unit. If you are not sure of the type of power supplied to your home, consult your dealer or local power company.
8. For safety purposes this unit is equipped with a grounded plug. If you do not have this type of outlet, please have one installed. Do not use any type of adaptor plug to defeat this safety feature.
9. Do not place objects on the power cord. Install the unit where no one can step or trip on the cord.
10. Do not overload wall outlets and extension cords. This can result in the risk of fire or electric shock.
11. Never push any objects through slots in this unit. This may result in the risk of fire or electric shock. Never spill any liquid on the unit.
12. To reduce the risk of electric shock, do not disassemble this unit. Take the unit to an authorized servicer when service is required. Opening or removing covers may expose you to dangerous voltages or other risks. Incorrect reassembly can cause electric shock when the unit is subsequently used.
13. Unplug this unit from the wall outlet and refer servicing to an authorized servicer if any of the following occur:
  - A. If the power supply cord or plug is damaged or frayed.
  - B. If liquid has been spilled into the unit.

- C. If the unit has been exposed to rain or water.
  - D. If the unit does not work normally by following the operating instructions. Adjust only controls covered by the operating instructions. Improper adjustment may require extensive work by an authorized servicer.
  - E. If the unit has been dropped or physically damaged.
  - F. If the unit exhibits a distinct change in performance.
14. During thunderstorms, avoid using telephones, except cordless types. There may be a remote risk of an electric shock from lightning.
  15. Do not use this unit to report a gas leak when in the vicinity of the leak.

## SAVE THESE INSTRUCTIONS

### INSTALLATION

1. Never install telephone wiring during a lightning storm.
2. Never install telephone jacks in wet locations unless the jack is specifically designed for wet locations.
3. Never touch uninsulated telephone wires or terminals unless the telephone line has been disconnected at the network interface.
4. Use caution when installing or modifying telephone lines.

### WARNING

- To prevent the risk of fire or electrical shock, do not expose this product to rain or any type of moisture.

### OTHER INFORMATION

- Keep the unit away from electrical noise generating devices, such as fluorescent lamps and motors.
- The unit should be kept free from dust, high temperature and vibration.
- The unit should not be exposed to direct sunlight.
- Do not place heavy objects on top of this unit.
- Do not touch the plug with wet hands.

# Quick Start

## Installation

### Before installation (p. 17)

A. Remove the shipping tape.

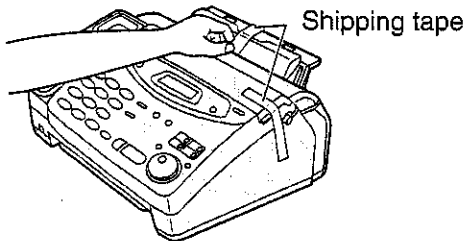

B. Open the cover, remove the leaflet under the film cartridge and close the cover.

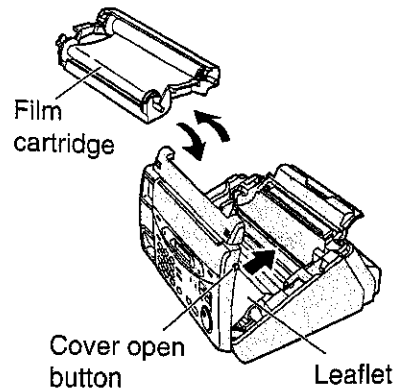

### 1 Paper tray (p. 18)

Insert the two tabs on the paper tray into the slots on the back of the unit.

### 2 A4 paper guides (p. 18)

Install the A4 paper guides.

### 3 Paper stacker (p. 19)

Remove the shipping tape and install paper stacker.

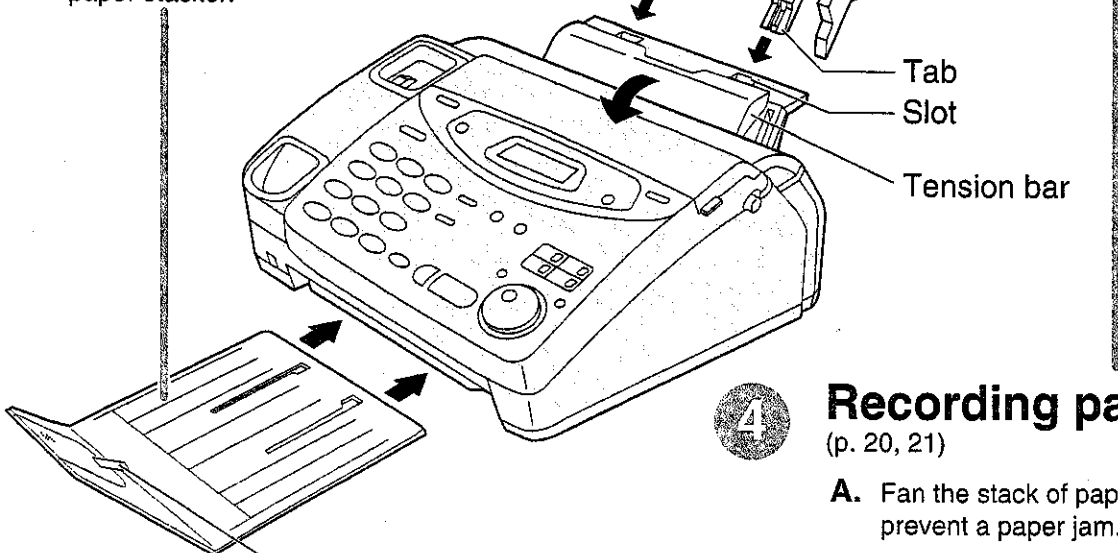

### 4 Recording paper (p. 20, 21)

A. Fan the stack of paper to prevent a paper jam.

B. Pull the tension bar forward and hold open while inserting the paper.

## Connections

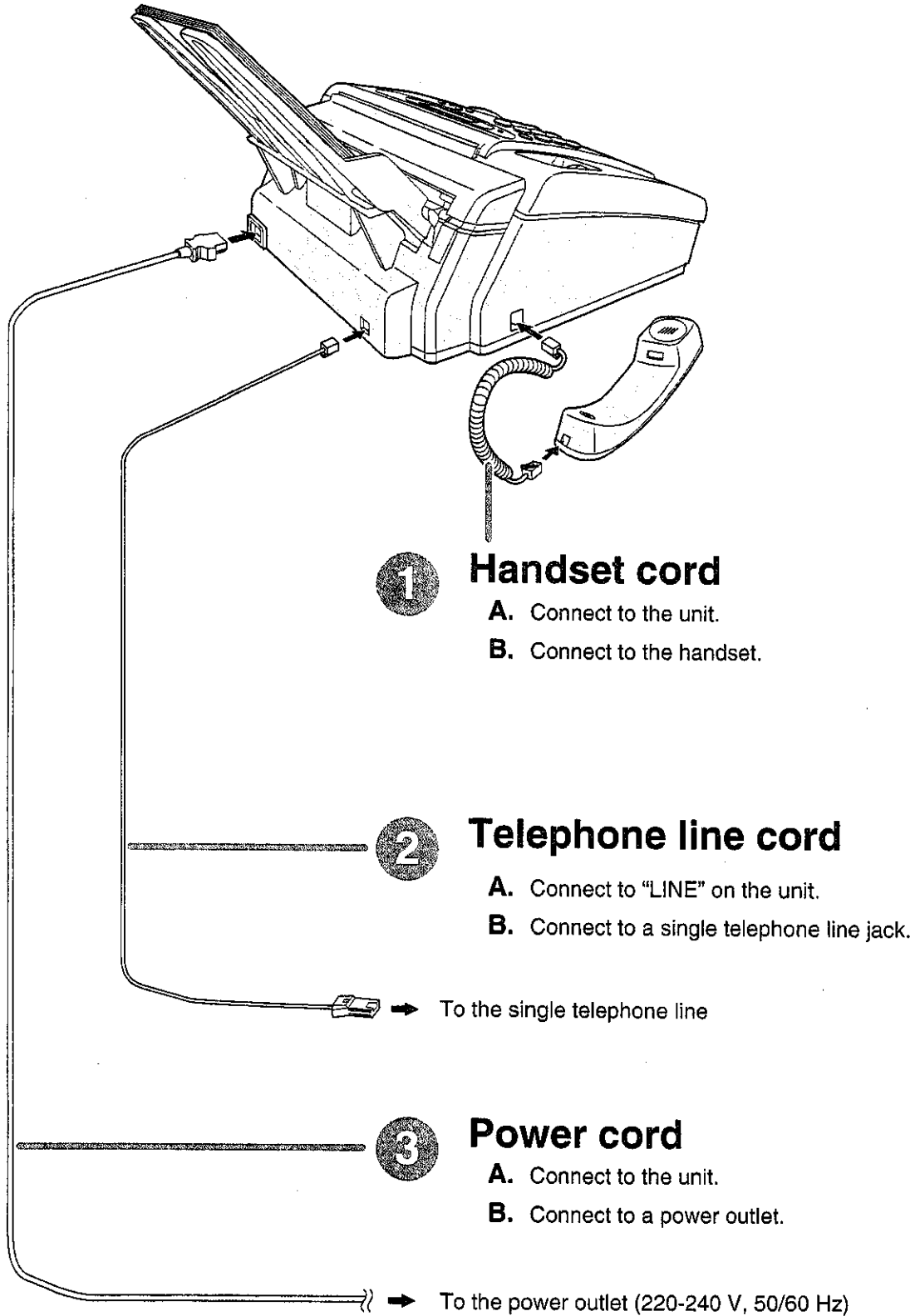

● For further details, see page 22.

# Quick Start

## Voice calls - making/answering

### Voice calls - making

1

Lift the handset.

2

Dial the number.

3

When finished talking,  
replace the handset.

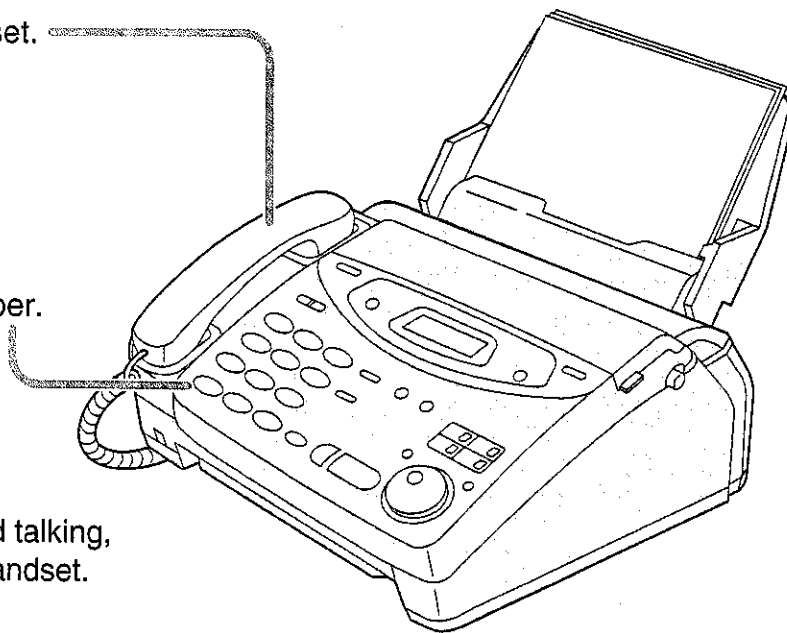

- For further details, see page 28.
- If you are having trouble, see pages 76 and 77.

### Voice calls - answering

1

When the unit rings,  
lift the handset.

2

When finished talking,  
replace the handset.

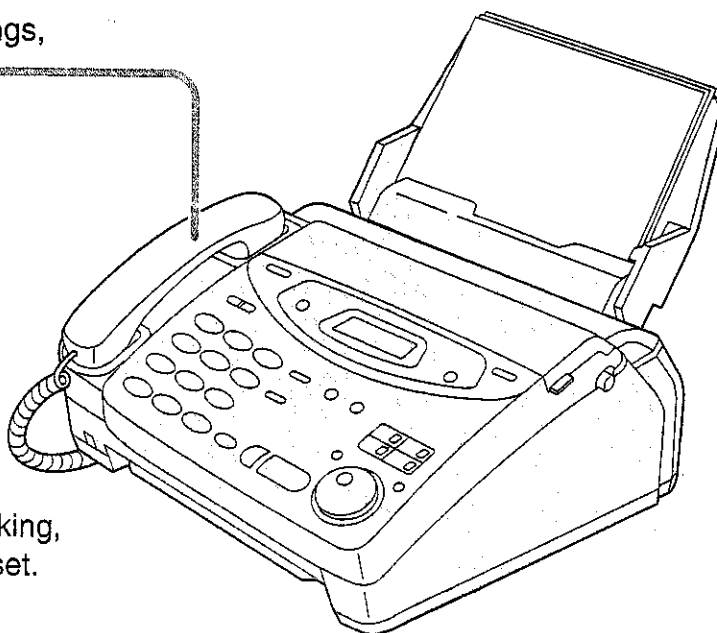

- For further details, see page 28.
- If you are having trouble, see pages 76 and 77.

## Faxes - sending/receiving

### Faxes - sending

- 1 Open the document feeder tray.

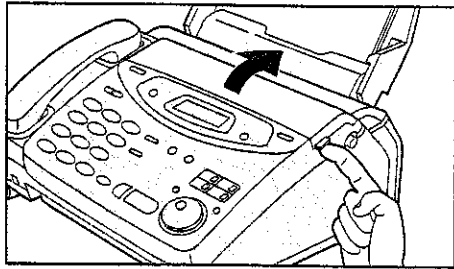

- 2 Adjust the width of the document guides to the size of the document.

- 3 Insert the document until a single beep is heard and the unit grabs the document.

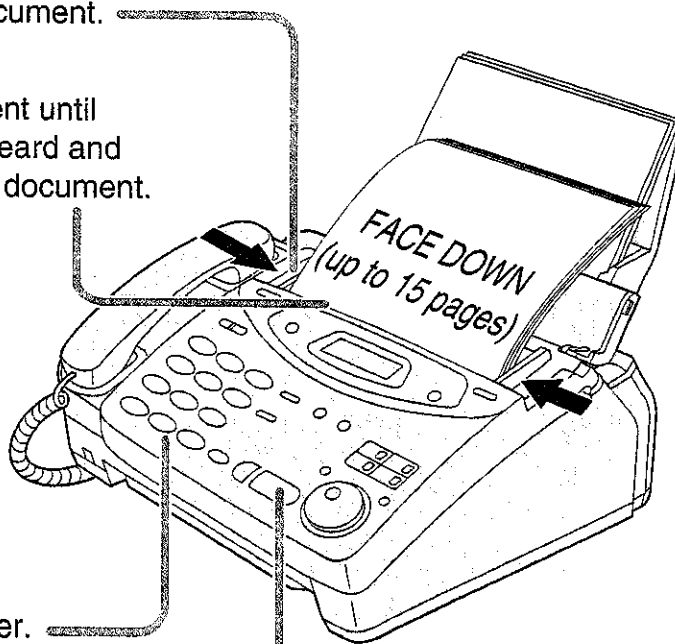

- 4 Dial the fax number.

- 5 Press **START/SET/COPY**.

- For further details, see page 42.
- If you are having trouble, see page 77.

# Quick Start

## Faxes - receiving

- 1 When the unit rings, lift the handset.

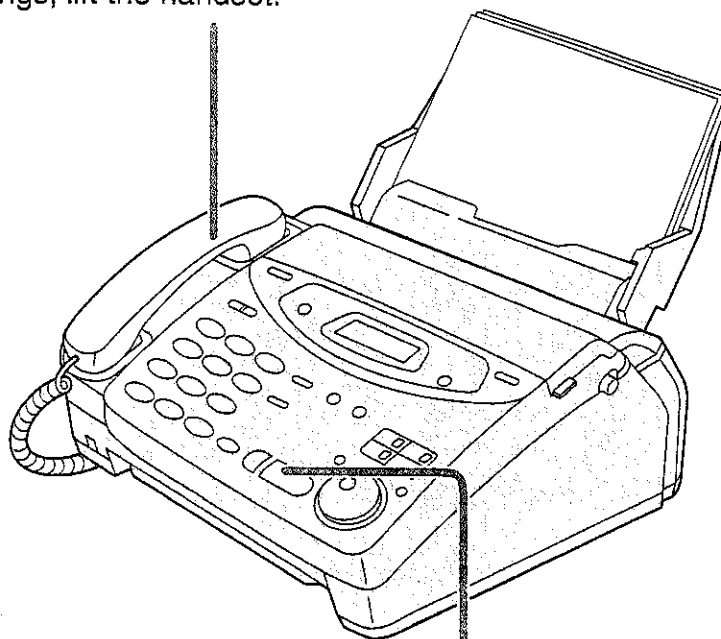

- 2 When:
  - document reception is required,
  - a fax calling tone (slow beep) is heard, or
  - no sound is heard,press **START/SET/COPY**.

- 3 Replace the handset.

- For further details, see page 58.
- **You can select the way to receive calls according to your needs (p. 56, 57).**
- If you are having trouble, see page 78.



## Copy - making

- 1 Open the document feeder tray.

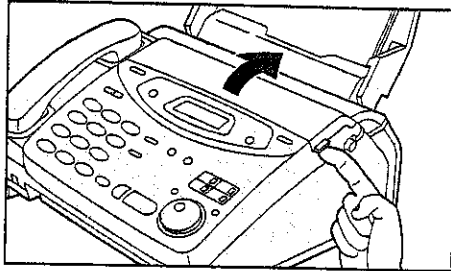

- 2 Adjust the width of the document guides to the size of the document.

- 3 Insert the document until a single beep is heard and the unit grabs the document.
  - Make sure the handset is on the cradle.

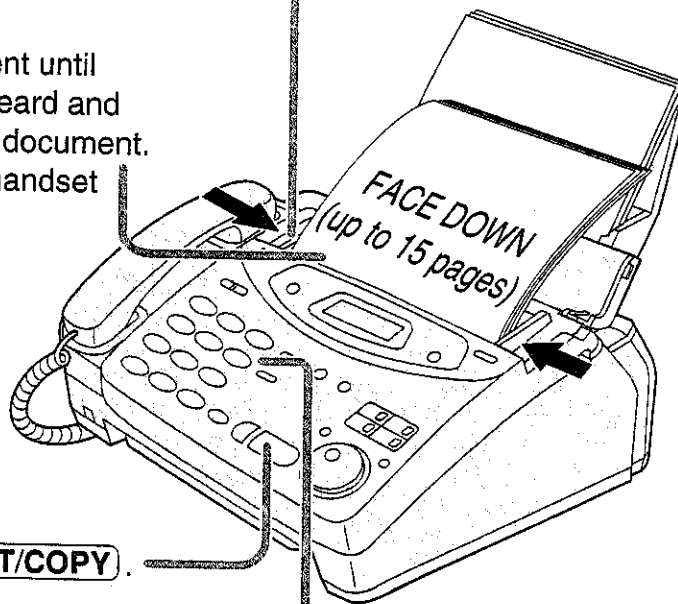

- 4 Press **START/SET/COPY**.

- 5 Enter the number of copies.

- 6 Press **START/SET/COPY**.

- For further details, see page 72.
- If you are having trouble, see pages 78 and 79.



# Table of Contents

<b>Initial Preparation</b>	<b>Accessories</b>	Included accessories . . . . .	12
		Accessory order information . . . . .	12
	<b>Help Button</b>	Help function . . . . .	13
	<b>Finding the Controls</b>	Location . . . . .	14
		Overview . . . . .	16
	<b>Setup</b>	Before installation . . . . .	17
		Paper tray . . . . .	18
A4 paper guides . . . . .		18	
Paper stacker . . . . .		19	
Recording paper . . . . .		20	
Connections . . . . .		22	
Date and time, your logo and facsimile telephone number . . . . .		23	
<b>Volumes</b>	Adjusting volumes . . . . .	27	
<b>Telephone</b>	<b>Making and Answering Calls</b>	Voice calls - making . . . . .	28
		Voice calls - answering . . . . .	28
		RECALL and PAUSE buttons . . . . .	29
	<b>One-Touch Dial</b>	Storing names and telephone numbers in the One-Touch Dial . . . . .	30
		Making a voice call using the One-Touch Dial . . . . .	31
	<b>EASY DIAL</b>	Storing names and telephone numbers in the EASY DIAL directory . . . . .	32
		Making a voice call using the EASY DIAL directory . . . . .	34
	<b>Caller ID</b>	Caller ID service from your phone company . . . . .	35
		Viewing the Caller ID list on the display . . . . .	36
		Calling back from the Caller ID list . . . . .	37
		Storing telephone numbers in the One-Touch Dial and EASY DIAL directory from the Caller ID list . . . . .	38
		Erasing all callers' information . . . . .	39
		Automatic Caller ID list . . . . .	40
	<b>Voice Contact</b>	Talking to the caller after fax transmission or reception . . . . .	41
	<b>Fax/Copy</b>	<b>Sending Faxes</b>	Sending a fax manually . . . . .
Sending a fax using the One-Touch Dial . . . . .			43
Sending a fax using the EASY DIAL directory . . . . .			44
Documents you can send . . . . .			45
Sending report for confirmation . . . . .			46
Automatic journal report . . . . .			47
Delayed transmission (sending a fax at a specified time) . . . . .			48
From memory . . . . .			49
Multiple stations . . . . .			50
Overseas mode . . . . .			53
Error correction mode setting . . . . .			54
Connecting tone . . . . .			55

<b>Fax/Copy</b>	<b>Receiving Faxes</b>	Setting the unit to receive calls . . . . .	56
		TEL mode (answering all calls manually) . . . . .	58
		FAX ONLY mode (all calls are received as faxes) . . . . .	59
		Distinctive ring service (FaxAbility) . . . . .	61
		TEL/FAX mode (receiving voice calls with rings and fax calls without rings when you are near the unit) . . . . .	62
		Extension telephone . . . . .	66
		Fax activation code . . . . .	66
		Other size documents . . . . .	67
		Memory reception alert . . . . .	68
		Friendly reception . . . . .	69
		Auto disconnection . . . . .	69
		Pager call - when your unit receives a fax . . . . .	70
		Film detection . . . . .	71
		Receive polling (retrieving a fax placed on another party's machine) . . . . .	71
<b>Copying</b>	Making a copy . . . . .	72	
<b>Help</b>	<b>Error Messages</b>	Reports . . . . .	74
		Display . . . . .	75
	<b>Operations</b>	When a function does not work, check here before requesting help . . . . .	76
		If a power failure occurs . . . . .	79
	<b>Jams</b>	Recording paper jams . . . . .	80
		Sending document jams . . . . .	82
		Sending document does not feed, or multi-feeds . . . . .	82
	<b>Ink Film</b>	How much film you have left . . . . .	83
		Replacing the film or film cartridge . . . . .	84
	<b>Cleaning</b>	Document feeder . . . . .	87
Thermal head and black bar . . . . .		87	
<b>General Information</b>	<b>Print Reports</b>	Printing the feature settings, telephone numbers, journal, printer test list, broadcast list and Caller ID list . . . . .	88
	<b>Original Mode</b>	Original mode . . . . .	89
	<b>Display Contrast</b>	Changing the display contrast . . . . .	90
	<b>Reset</b>	Resetting the advanced features . . . . .	90
	<b>Specifications</b>	Technical data about this product . . . . .	91
	<b>Index</b>	Index . . . . .	92
	<b>Features Summary</b>	Summary of user programmable features . . . . .	94

# Accessories

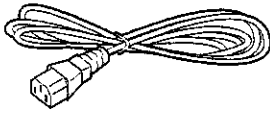
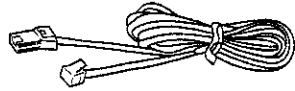
## Included accessories

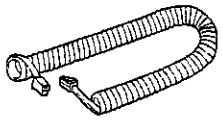
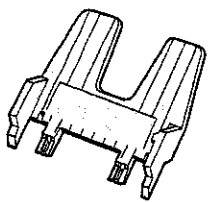
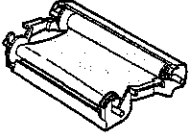
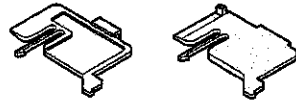
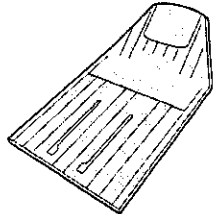
Power cord ..... 1 	Telephone line cord .. 1 	Handset ..... 1 	Handset cord ..... 1 
Paper tray ..... 1 	Film cartridge ..... 1 (with free starter film)  – The film cartridge is pre-installed.	A4 paper guides ..... 2  (Left) (Right)	Paper stacker ..... 1 

- If any items are missing or damaged, check with the place of purchase.
- Save the original carton and packing materials for future shipping and transportation of the unit.

## Accessory order information

The free starter film cartridge is only 20 meters long. We recommend that you buy regular film cartridge (100 m) for continuous use of your unit.  
For best results, use genuine Panasonic film cartridge Model No. KX-FA137A.

Model No.	Description	Specifications
KX-FA137A	Film cartridge	1 cartridge and 1 film (216 mm x 100 m roll) ● The film has already been installed in the cartridge. ● Replacement film (KX-FA136A) can be installed in the cartridge after initial usage.

### Note:

- The film is not reusable. Do not rewind and use the film again.

## Help function

You can print a quick reference for assistance as follows.

**1** Press **HELP**.

Display: **PRESS [▼▲] & [SET]**

**2** Press **▼** or **▲** until the desired item is displayed. The following items are available.

1. How to program your unit

**1. HOW TO SET UP**

2. How to store names in the EASY DIAL directory and how to dial them

**2. EASY DIAL**

3. Help with problems receiving faxes

**3. FAX RECEIVING**

4. How to use the copier function

**4. COPIER**

5. List of available reports

**5. REPORTS**

6. How to use the Caller ID service

**6. CALLER ID**

**3** Press **START/SET/COPY**.

**PRINTING**

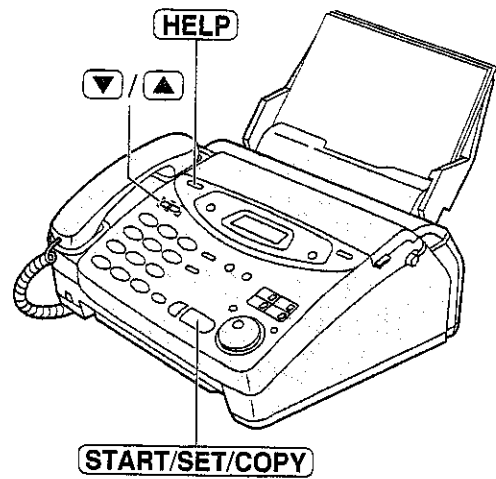

# Finding the Controls

## Location

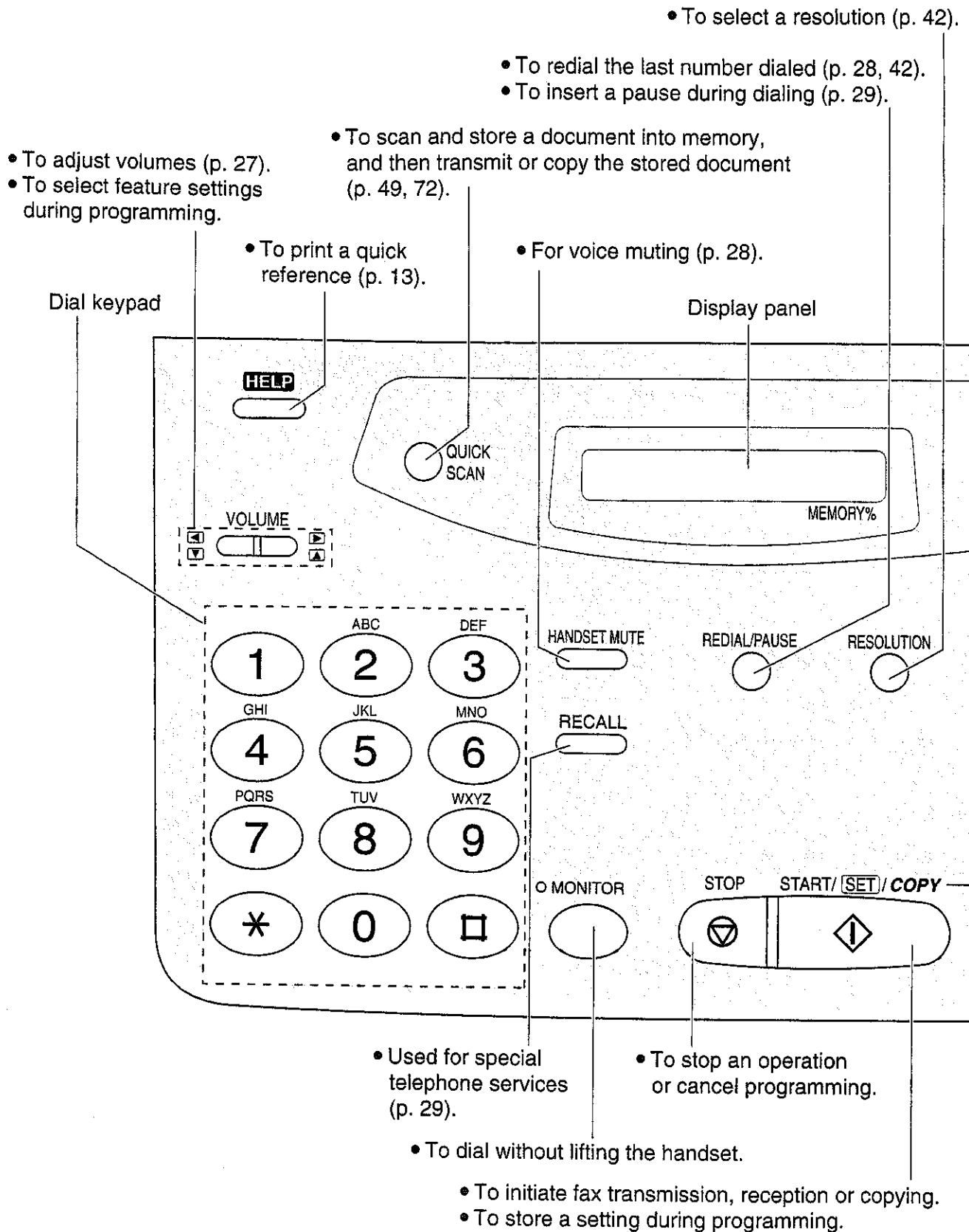

- For the Caller ID service (p. 35–40).

- For transmission to multiple stations (p. 50–52).
- For the One-Touch Dial (p. 30, 31, 43).
- Command keys (p. 25).

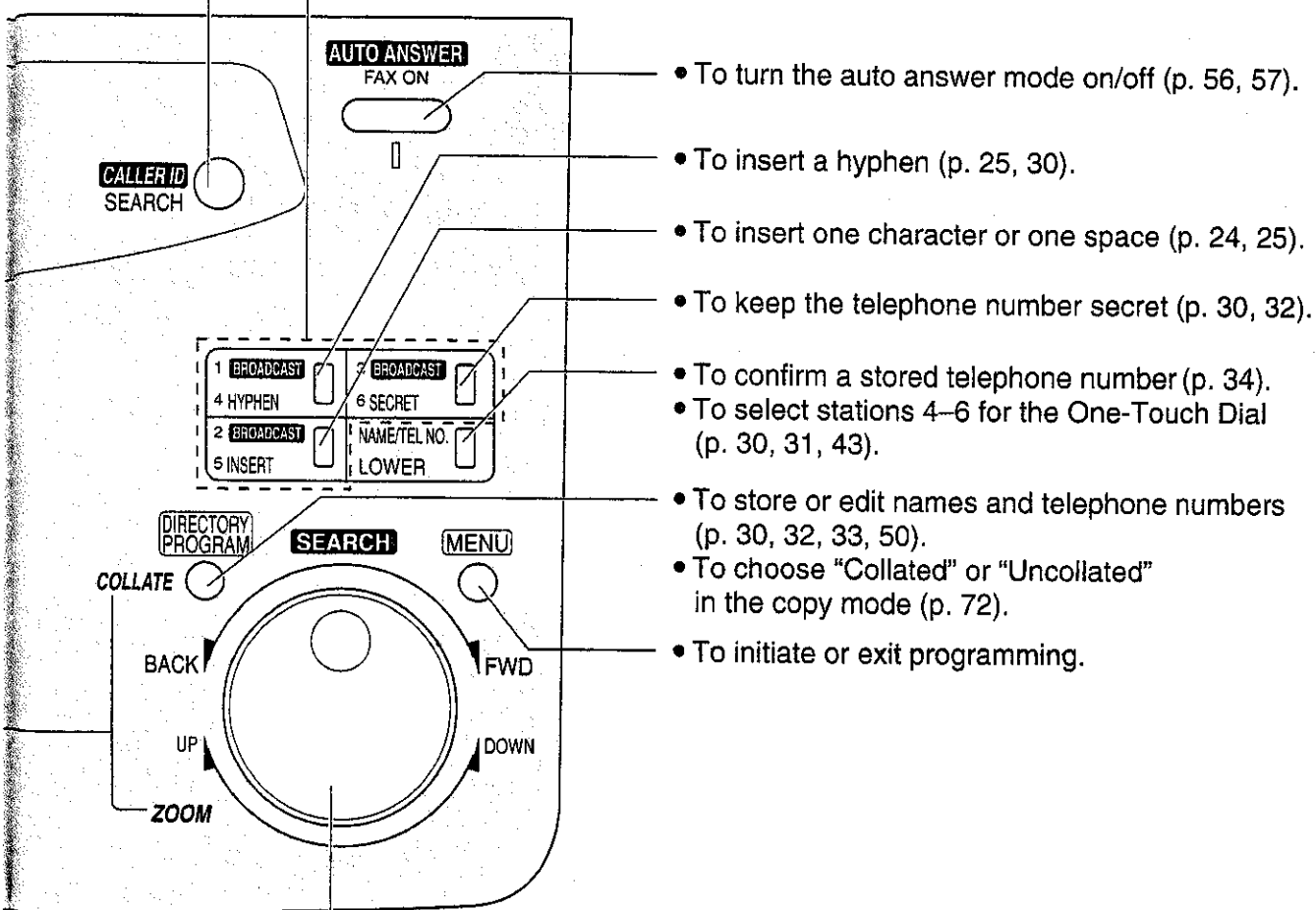

- To turn the auto answer mode on/off (p. 56, 57).
- To insert a hyphen (p. 25, 30).
- To insert one character or one space (p. 24, 25).
- To keep the telephone number secret (p. 30, 32).
- To confirm a stored telephone number (p. 34).
- To select stations 4–6 for the One-Touch Dial (p. 30, 31, 43).
- To store or edit names and telephone numbers (p. 30, 32, 33, 50).
- To choose "Collated" or "Uncollated" in the copy mode (p. 72).
- To initiate or exit programming.
- To search for a stored name (p. 34, 44).
- To select characters during programming (p. 23).
- To select the basic features during programming (p. 94).
- To select an enlargement/reduction rate in the copy mode (p. 72, 73).

# Finding the Controls

## Overview

---

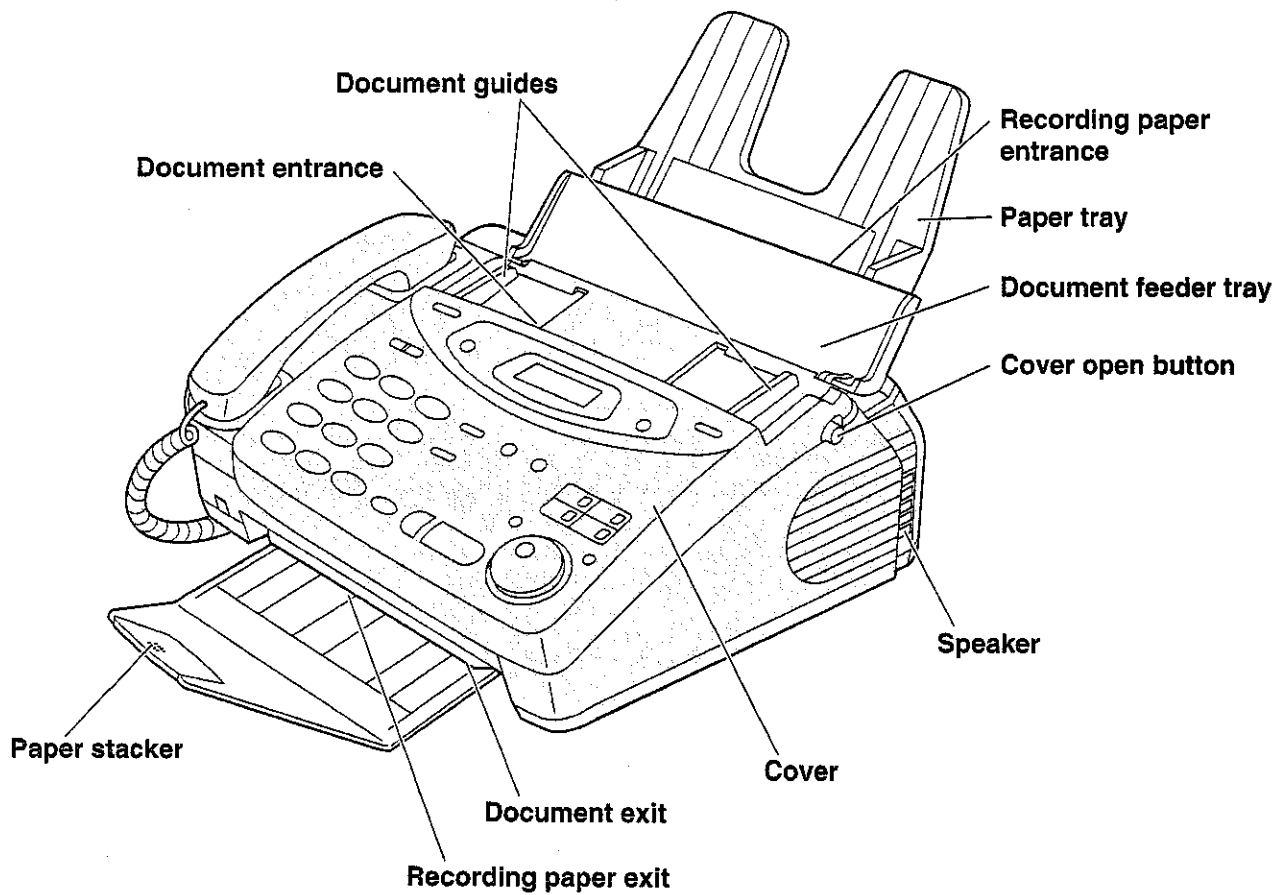

**Note:**

- The document and recording paper will be ejected from the front of the unit. Install the unit on a desk or floor with a smooth surface and do not place anything in front of the unit.



## Before installation

- 1** Remove the shipping tape.
- 2** Open the cover by pressing the cover open button.
- 3** Lift the film cartridge, remove the leaflet and replace the film cartridge.
- 4** Close the cover securely by pushing down on the dotted area at both ends.

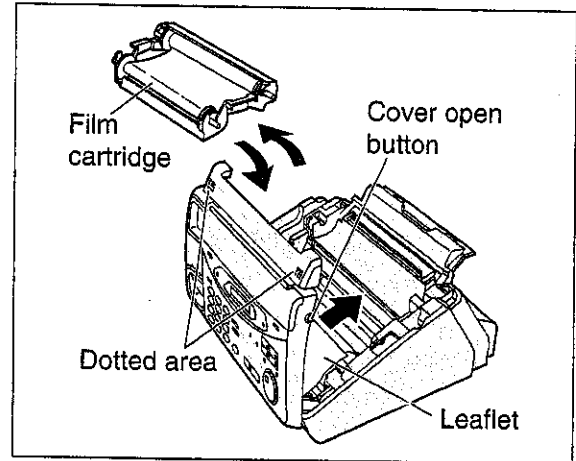
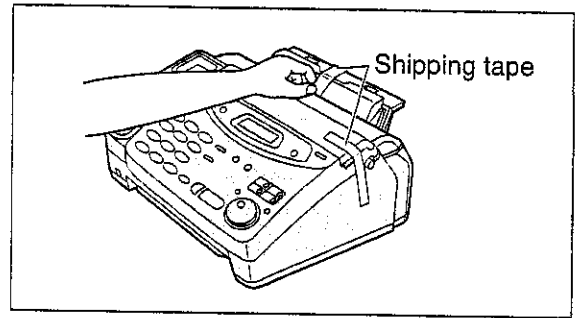

# Setup

## Paper tray

Insert the two tabs on the paper tray into the slots on the back of the unit.

- Do not place the unit in areas where the paper tray may be obstructed by a wall, etc.

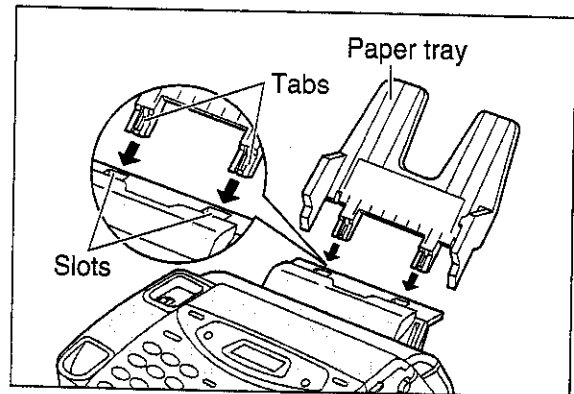

## A4 paper guides

Install the A4 paper guides before setting the A4 size recording paper.

- 1**
  - Insert the bottom tab on the A4 paper guide (left) into the lower slot.
  - Press the guide into the upper slot.
  - If the A4 paper guide cannot be installed, make sure the paper tray has been installed correctly.

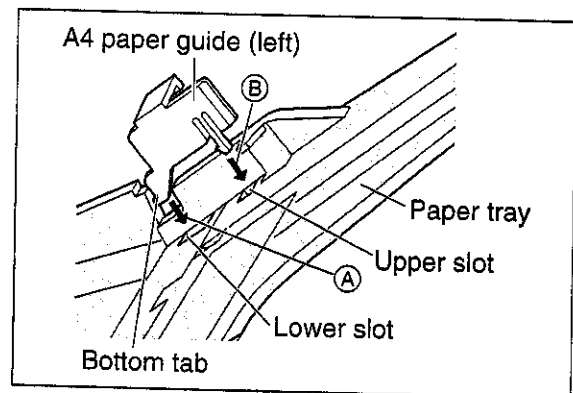

- 2**
  - Insert the bottom tab on the A4 paper guide (right) into the lower slot.
  - Press the guide into the upper slot.

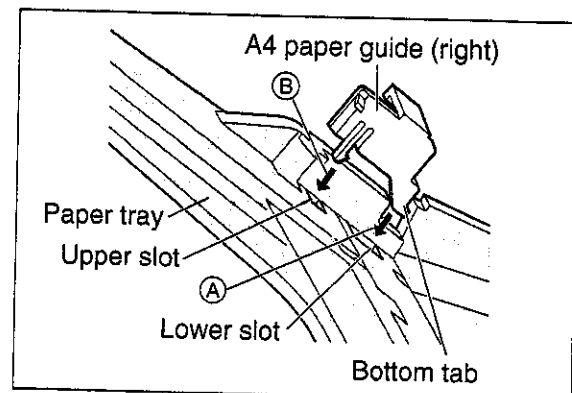

### Note:

- When you remove the paper tray, be sure to take off A4 paper guides first, in order not to damage them.

## Paper stacker

- 1** Remove the shipping tape from the paper stacker.
- 2** Lift the front of the unit and hold the aluminum sheet up to prevent it being bent by the paper stacker while inserting the paper stacker into the side slots.
- 3** Confirm that the paper stacker is locked into the center slots and slide back.
- 4** Slide the paper stacker forward until it stops.

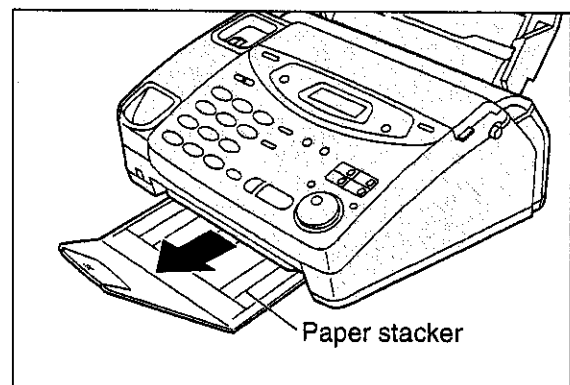
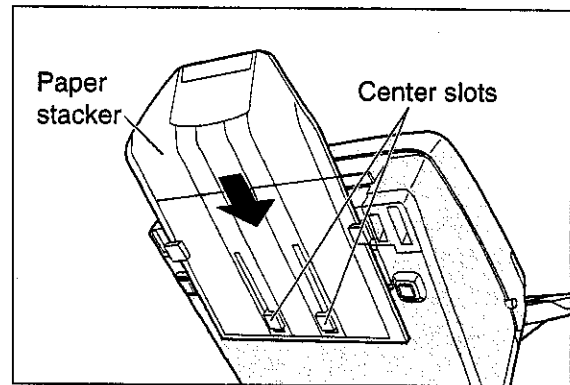
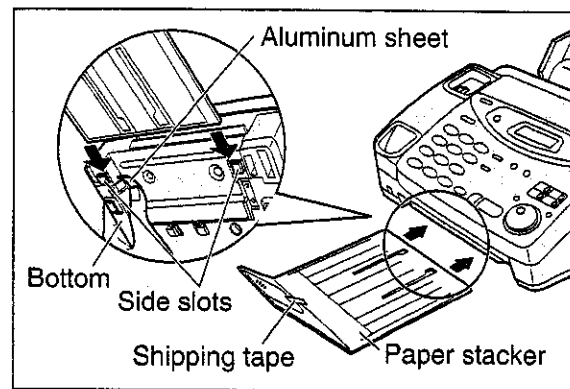

# Setup

## Recording paper

A4 size recording paper can be loaded. The paper tray can hold up to 150 sheets of 75 g/m<sup>2</sup> paper. You may use 60 g/m<sup>2</sup> to 90 g/m<sup>2</sup> paper.

- 1 Fan the stack of paper to prevent a paper jam.

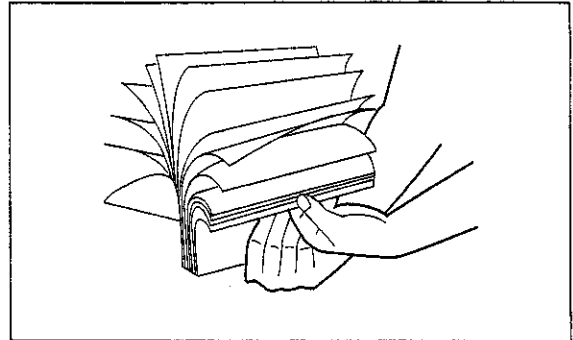

- 2 Pull the tension bar forward and hold open while inserting the paper.

- The height of the stack of the paper should not exceed the upper limit on the paper tray, otherwise the paper may jam or multi-feed.
- The paper should not be over the tab.
- If the paper is not inserted correctly, readjust the paper or the paper may jam.

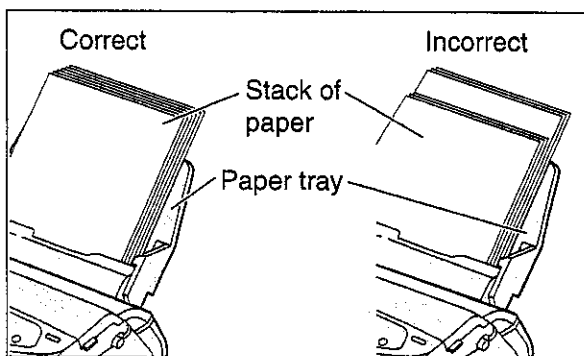
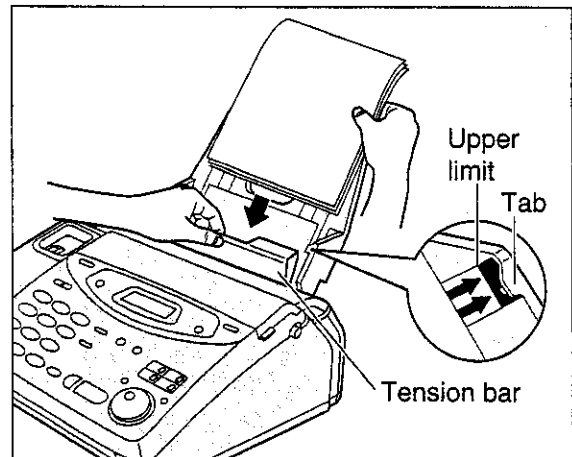

**Note:**

- Avoid paper with a cotton and/or fiber content that is over 20%, such as letterhead paper or paper used for resumes.
- Do not use different types or thicknesses of paper in the paper tray at the same time. This may cause a paper jam.
- Avoid extremely smooth or shiny paper that is highly textured. Also avoid paper that is coated, damaged or wrinkled.
- Avoid double-sided printing.
- Do not use paper printed from this unit for double-sided printing with other copiers or printers, or the paper may jam.
- Do not reinsert the ejected paper into the recording paper exit.
- Some paper only accepts print on one side. Try using the other side of paper if the print quality is unsatisfactory.

---

## Adding paper to the paper tray

1. Pull the tension bar forward and hold open while removing all of the installed paper.
2. Add paper to the paper stack and straighten.
3. Fan the stack of paper.
4. Pull the tension bar forward and hold open while inserting the paper.

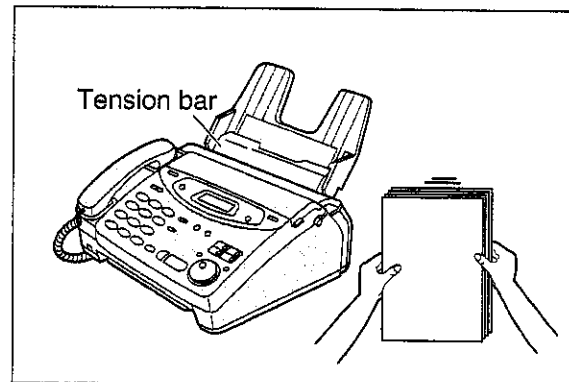

# Setup

## Connections

---

- 1** Connect the handset cord.
- 2** Connect the telephone line cord.
- 3** Connect the power cord.
  - When the power is turned on for the first time, the unit will print some basic information.

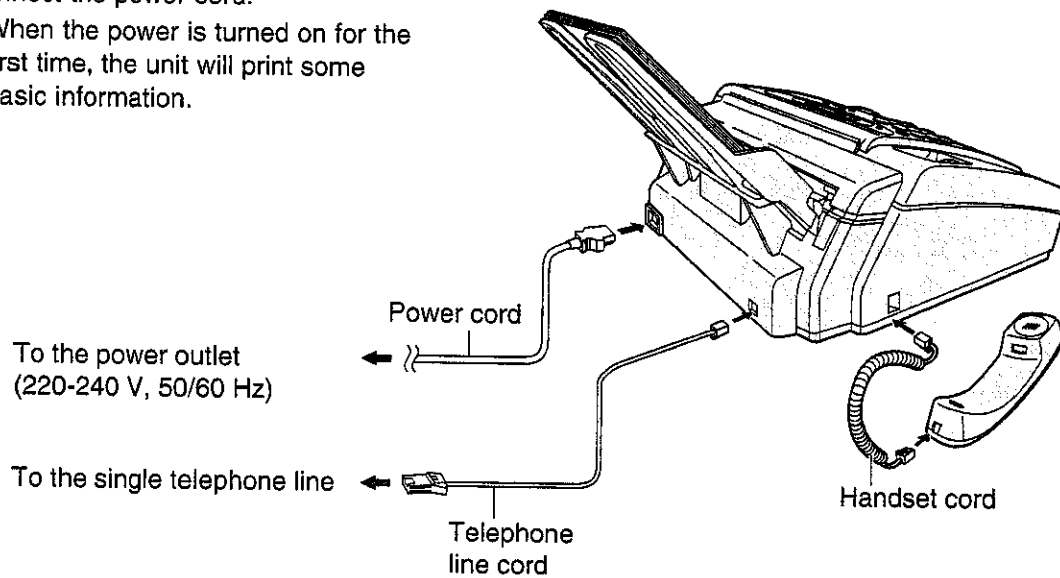

**Note:**

- When you operate this product, the power outlet should be near the product and easily accessible.

# Date and time, your logo and facsimile telephone number

You should program the date and time, your logo and facsimile telephone number. This information will be printed on each page transmitted from your unit.

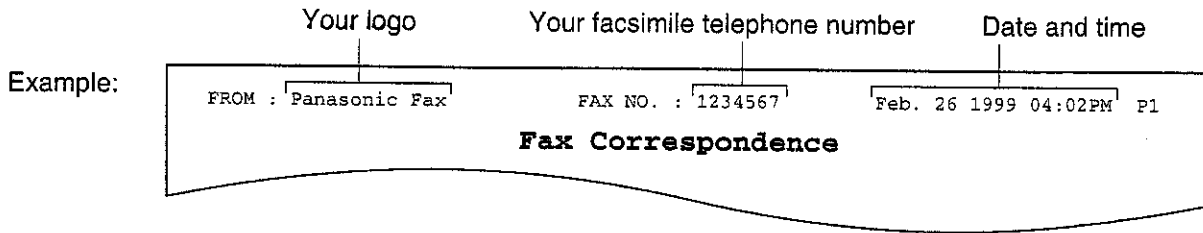

## Setting the date and time

**1** Press **MENU**.

Display: 1.SYSTEM SET UP

**2** Press **[ ]**, then **0 1**.

SET DATE & TIME

**3** Press **START/SET/COPY**.

M:01/D:01/Y:99  
Cursor

**4** Enter the correct month/day/year by selecting each 2 digits using the dial keypad.

**Example:** Aug. 10, 1999

Press **0 8 1 0 9 9**.

M:08/D:10/Y:99

**5** Press **START/SET/COPY**.

TIME: 12:00AM

**6** Enter the correct hour/minute by selecting each 2 digits using the dial keypad.

Press **[\*]** to select "AM" or "PM".

**Example:** 3:15PM

1. Press **0 3 1 5**.

TIME: 03:15AM

2. Press **[\*]** until "PM" is displayed.

TIME: 03:15PM

**7** Press **START/SET/COPY**.

SETUP ITEM [ ]

**8** Press **MENU**.

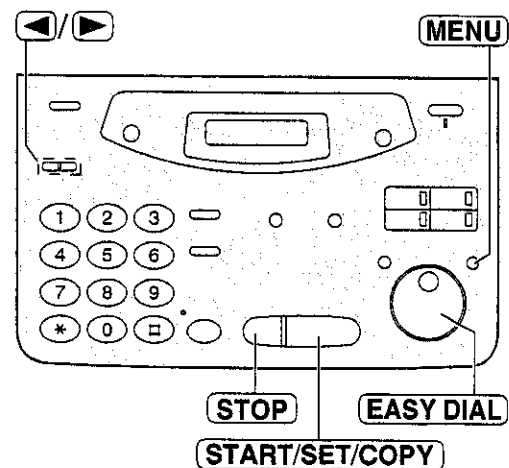

### Note:

- You can enter the number by rotating **EASY DIAL** in steps 4 and 6. In this case, press **[ ]** to move the cursor.
- The accuracy of the clock is approximately  $\pm 60$  seconds a month.

### To correct a mistake

- Press **[ ]** or **[ ]** to move the cursor to the incorrect number, then make the correction.
- If you press **STOP** while programming, the display will return to the previous one.

# Setup

## Setting your logo

The logo can be your company, division or name.

**1** Press **MENU**.  
Display: 1.SYSTEM SET UP

**2** Press **□**, then **0 2**.  
YOUR LOGO

**3** Press **START/SET/COPY**.  
LOGO=

**4** Enter your logo, up to 30 characters, by using the dial keypad. See next page for details.

**Example:** Bill

1. Press **2** twice.  
LOGO=B  
Cursor

2. Press **4** six times.  
LOGO=Bi

3. Press **5** six times.  
LOGO=Bi1

4. Press **▶** to move the cursor to the next space and press **5** six times.

LOGO=Bill

**5** Press **START/SET/COPY**.  
SETUP ITEM [ ]

**6** Press **MENU**.

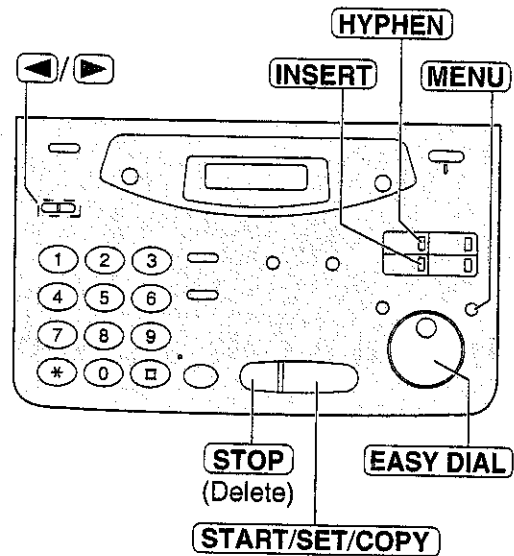

### Note:

- You can enter characters by rotating **EASY DIAL** (see next page).

## To correct a mistake

- Press **◀** or **▶** to move the cursor to the incorrect character, then make the correction.

## To delete a character

- Move the cursor to the character you want to delete and press **STOP**.





## To insert a character

- Press **◀** or **▶** to move the cursor to the position to the right of where you want to insert the character.
- Press **INSERT** (One-Touch Dial key 2) to insert a space and enter the character.



## To select characters with the dial keypad

Pressing the dial keys will select a character as shown below.

Keys	Characters
①	1 [ ] { } + - / = , . _ ' : ; ?
②	A B C a b c 2
③	D E F d e f 3
④	G H I g h i 4
⑤	J K L j k l 5
⑥	M N O m n o 6
⑦	P Q R S p q r s 7
⑧	T U V t u v 8
⑨	W X Y Z w x y z 9
⑩	0 ( ) < > ! " # \$ % & ¥ * @ ^ ' →
	<b>HYPHEN</b> key (To insert a hyphen.)
	<b>INSERT</b> key (To insert one character or one space.)
<b>STOP</b>	<b>Delete</b> key (To delete a character.)
	◀ key (To move the cursor to the left.)
	▶ key (To move the cursor to the right.) To enter another character using the same number key, move the cursor to the next space.

## To select characters using the EASY DIAL

Instead of pressing the dial keys, you can select characters using the EASY DIAL.

1. Rotate **EASY DIAL** until the desired character is displayed.
2. Press  to move the cursor to the next space.
  - The character displayed in step 1 is inserted.
3. Return to step 1 to enter the next character.

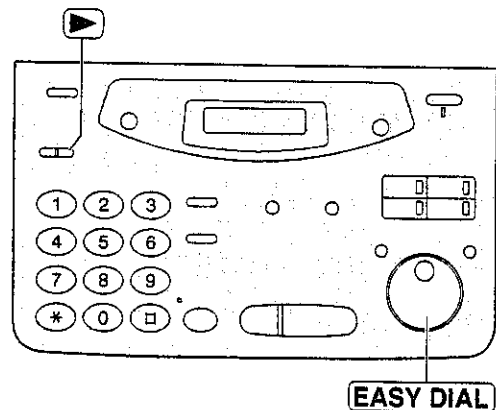

### Display order of characters

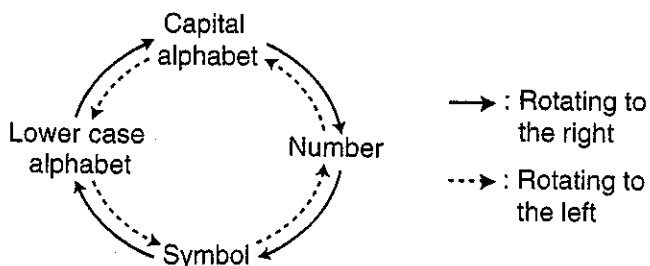

# Setup

## Setting your facsimile telephone number

- 1 Press **MENU**.  
Display: **1.SYSTEM SET UP**
- 2 Press **⏏**, then **0 3**.  
**YOUR FAX NO.**
- 3 Press **START/SET/COPY**.  
**NO.=**
- 4 Enter your facsimile telephone number up to 20 digits using the dial keypad.  
Example: **NO.=1234567**
- 5 Press **START/SET/COPY**.  
**SETUP ITEM [ ]**
- 6 Press **MENU**.

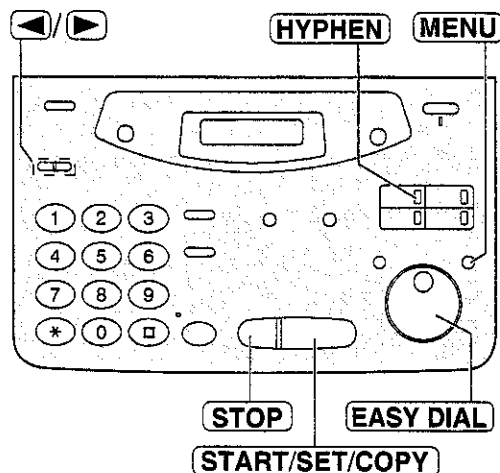

### Note:

- You can enter your facsimile telephone number by rotating **EASY DIAL**. If using **EASY DIAL**, press **▶** to move the cursor.
- The **\***  button replaces the digit with a "+" and the **⏏** button replaces it with a space.  
**Example** (using the dial keypad): +234 5678  
Press **\* 2 3 4 ⏏ 5 6 7 8**.
- To enter a hyphen in a telephone number, press **HYPHEN** (One-Touch Dial key 1).

### To correct a mistake

- Press **◀** or **▶** to move the cursor to the incorrect number, then make the correction.

### To delete a number

- Move the cursor to the number you want to delete and press **STOP**.

## Adjusting volumes

### Ringer volume

4 levels (high/middle/low/off) are available.

While the unit is idle, press ▼ or ▲.

#### ■ To turn the ringer off:

1. Press ▼ repeatedly until the following message is displayed.

Display: RINGER OFF= OK?  
 ↓  
YES: PRESS SET

2. Press **START/SET/COPY**.

- To turn the ringer back on, press ▲.

#### ■ While the ringer volume is set to off:

The display will show the following message.

RINGER OFF

When a call is received, the unit will not ring and will display the following.

INCOMING CALL

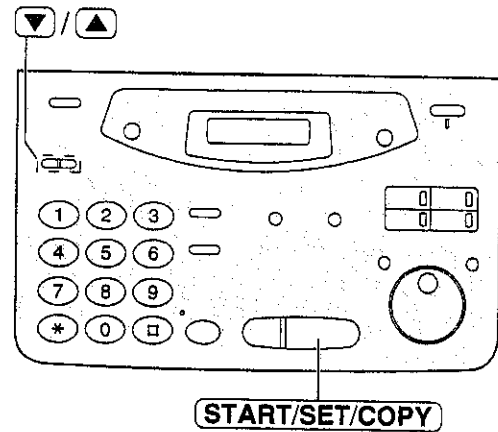

### Handset receiver volume

3 levels (high to low) are available.

While using the handset, press ▼ or ▲.

### Monitor volume

8 levels (high to low) are available.

While using the monitor, press ▼ or ▲.

# Making and Answering Calls

## Voice calls - making

- 1 Press **MONITOR** or lift the handset.  
Display:
- 2 Dial the telephone number.  
Example: 
  - If you misdial, hang up and dial again.
- 3 When the other party answers, speak with the handset.
- 4 When finished talking, replace the handset.

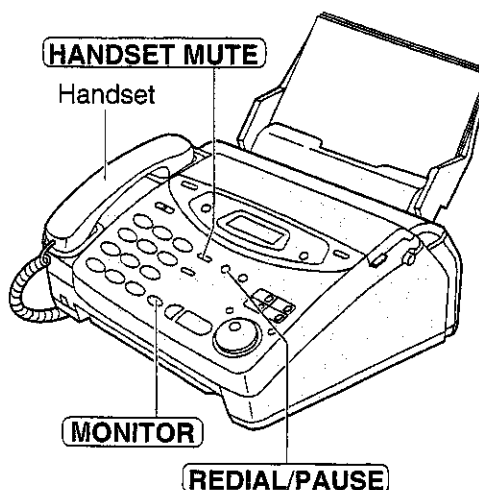

## Voice calls - answering

- 1 When the unit rings, lift the handset.
- 2 When finished talking, replace the handset.

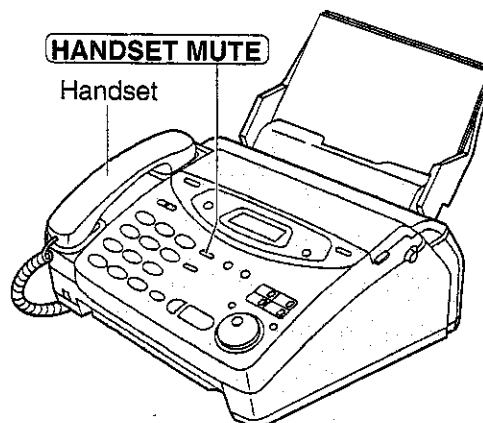

### To redial the last number

1. Press **MONITOR** or lift the handset.
2. Press **REDIAL/PAUSE**.
3. When the other party answers, speak with the handset.
  - If the line is busy when using the **MONITOR** button, the unit will automatically redial the number up to 2 times.
  - During redial, the following will be displayed.

Display:

### To mute your voice to the other party

1. Press **HANDSET MUTE** during a telephone conversation using the handset.

Display:

- The other party cannot hear you, but you can hear them.
2. To resume the conversation, press **HANDSET MUTE** again.

## RECALL and PAUSE buttons

### RECALL button

The **RECALL** button functions as the hookswitch on a regular telephone. If you misdial a telephone number, press the **RECALL** button firmly.

The **RECALL** button also allows you to use special features of a host exchange (if connected) or local telephone company services such as call waiting. For further details, contact your host exchange supplier or local telephone company.

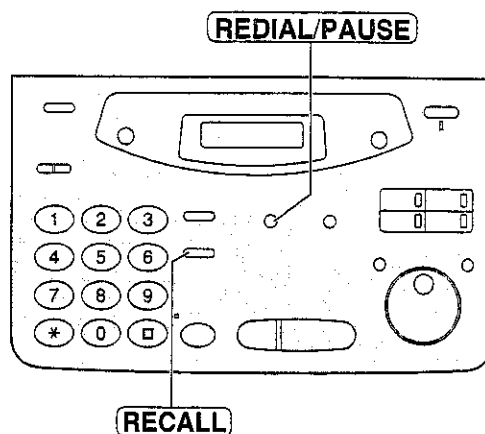

### Entering pauses

When the **REDIAL/PAUSE** button is pressed during dialling, a pause will be inserted. Pressing **REDIAL/PAUSE** once creates a 3 second pause.

#### Example 1:

If your unit is connected to a host exchange, insert a pause to get an outside line.

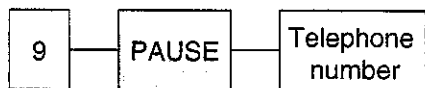

Line access code

#### Example 2:

If a transmission error occurs during an overseas transmission, add two pauses at the end of the telephone number.

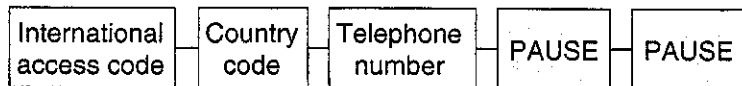

#### Note:

- RECALL and PAUSE can be stored into a telephone number in the One-Touch Dial and the EASY DIAL directory.

# One-Touch Dial

## Storing names and telephone numbers in the One-Touch Dial

The unit's memory allows you to use the One-Touch Dial for rapid access to your most frequently dialled numbers. 6 stations are available.

- One-Touch Dial keys 1, 2 or 3 can be used as One-Touch Dial keys (DIAL MODE) or as broadcast keys (BROADCAST). These functions cannot be used at the same time. For the broadcast function, see pages 50 to 52.

**1** Press **DIRECTORY PROGRAM**.

Display:   
↓

**2** For stations 1–3  
Press one of the One-Touch Dial keys.

▼▲

Press **START/SET/COPY** to go to the next prompt.

For stations 4–6

Press **LOWER**, then press one of the One-Touch Dial keys.

**3** Enter the station name, up to 10 characters, by following the instructions on page 25.

Example:

**4** Press **START/SET/COPY**.

Example:

**5** Enter the telephone number up to 30 digits.

Example:

- If you want to enter a hyphen, press **HYPHEN** (One-Touch Dial key 1).

**6** Press **START/SET/COPY**.

↓  
  
↓

- To program other stations, repeat steps 2 to 6.

**7** Press **DIRECTORY PROGRAM** to exit the program.

### Note:

- If "DIAL MODE" is not displayed when you select stations 1, 2 or 3 in step 2, the broadcast function has been set. To use the station as a One-Touch Dial key, press ▼ to select "DIAL MODE". The broadcast function will be cancelled.
- A hyphen entered in a telephone number is counted as two digits.

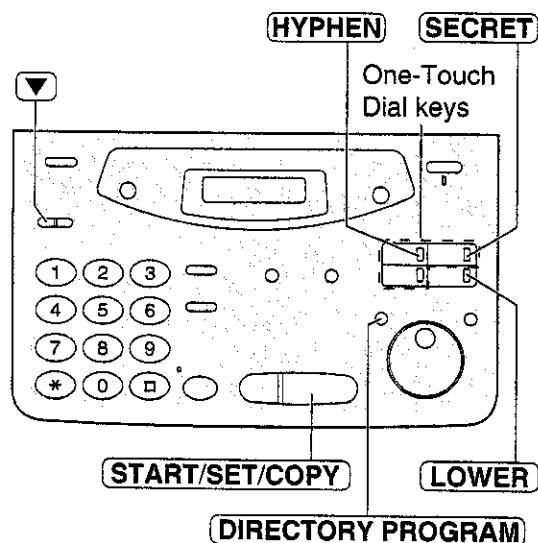

### Helpful hint:

- You can confirm the stored items on the display (p. 34) or on the telephone number list (p. 88).

## To keep the telephone number secret

Press **SECRET** (One-Touch Dial key 3) after entering the telephone number in step 5.

- A secret number cannot be viewed after this is set.
- The telephone number will not appear on the telephone number list.
- Pressing **SECRET** does not count as a digit.

## To edit a stored station name and number

Enter the desired name in step 3.

Enter the desired number in step 5.

To erase a stored station name and number, see page 33.

## Making a voice call using the One-Touch Dial

Before using this feature, program the desired names and telephone numbers into the One-Touch Dial (p. 30).

- 1** Press **MONITOR** or lift the handset.

Display:

- Confirm that there are no documents in the document feeder tray.

- 2** For stations 1–3  
Press the desired One-Touch Dial key.

For stations 4–6

Press **LOWER**, then press the desired One-Touch Dial key.

Example:

- 3** When the other party answers, speak with the handset.

- 4** When finished talking, replace the handset.

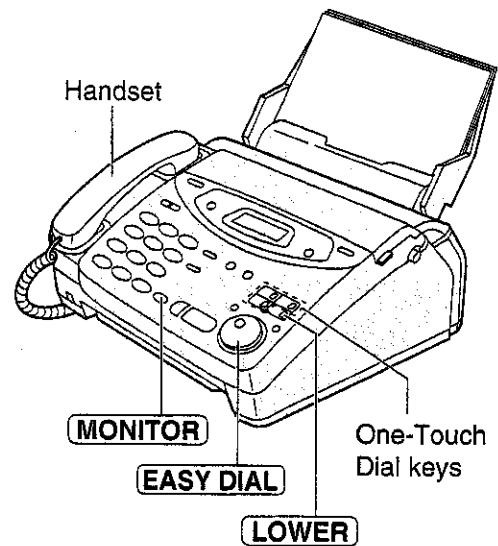

Telephone

### Helpful hints:

- You can confirm the stored items on the display (p. 34) or on the telephone number list (p. 88).
- You can use the EASY DIAL directory to select the station name instead of using the One-Touch Dial keys. Rotate **EASY DIAL** until the desired name is displayed, then press **MONITOR** or lift the handset.

# EASY DIAL

## Storing names and telephone numbers in the EASY DIAL directory

For rapid access to frequently dialled numbers, the unit also provides a EASY DIAL directory (100 stations) in addition to the One-Touch Dial.

**1** Press **DIRECTORY PROGRAM**.

Display:

↓

**2** Rotate **EASY DIAL** until the following is displayed.

**3** Enter the name, up to 10 characters, by following the instructions on page 25.

Example:

**4** Press **START/SET/COPY**.

**5** Enter the telephone number up to 30 digits.

Example:

- If you want to enter a hyphen, press **HYPHEN**.

**6** Press **START/SET/COPY**.

↓

- To program other items, repeat steps 3 to 6.

**7** Press **DIRECTORY PROGRAM** to exit the program.

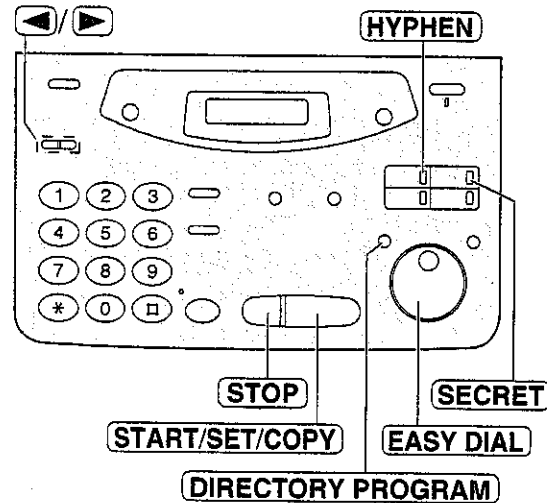

### Helpful hint:

- You can confirm the stored items on the display (p. 34) or on the telephone number list (p. 88).

### Note:

- You can store items during telephone conversation.
- When the following message is displayed in step 6, you can only store 5 items.

Display:

- If there is no space to store new stations, the following message is displayed in step 1.

Erase unnecessary stations (p. 33).

- A hyphen entered in a telephone number is counted as two digits.

### To correct a mistake

- Press **◀** or **▶** to move the cursor to the incorrect character, then make the correction.

### To delete a character or number

- Move the cursor to the character or number you want to delete and press **STOP**.

### To keep the telephone number secret

Press **SECRET** (One-Touch Dial key 3) after entering the telephone number in step 5.

- A secret number can not be viewed after this is set.
- The telephone number will not appear on the telephone number list.
- Pressing **SECRET** does not count as a digit.



## Editing a stored name and number

- 1** Rotate **EASY DIAL** until the desired name is displayed.

Example:

- 2** Press **DIRECTORY PROGRAM**.

- 3** Press **\*** to select "EDIT".

- If you do not need to edit the name, skip to step 5.

- 4** Edit the name by following the instructions on page 25.

- 5** Press **START/SET/COPY**.

Example:

- If you do not need to edit the telephone number, skip to step 7.

- 6** Edit the telephone number. For further details, see page 32.

- 7** Press **START/SET/COPY**.

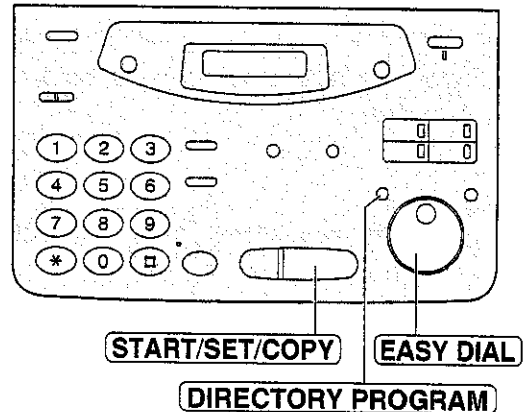

Telephone

## Erasing a stored name and number

You can erase a name and number stored in the EASY DIAL directory and One-Touch Dial.

- 1** Rotate **EASY DIAL** until the desired name is displayed.

Example:

- 2** Press **DIRECTORY PROGRAM**.

- 3** Press **#** to select "DELETE".



- If you do not want to erase the item, press **STOP**.

- 4** Press **START/SET/COPY**.

- The stored name and number are deleted.

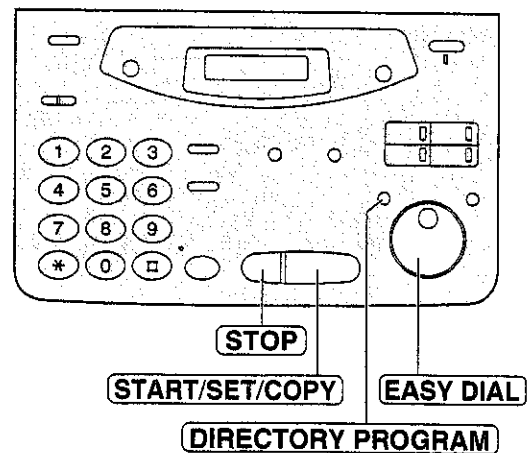

# EASY DIAL

## Making a voice call using the EASY DIAL directory

Before using this feature, program the desired names and telephone numbers into the directory (p. 32).

- 1 Rotate **EASY DIAL** until the desired name is displayed.

Example:

- 2 Press **MONITOR** or lift the handset.
  - The unit will start dialing automatically.

- 3 When the other party answers, speak with the handset.

- 4 When finished talking, replace the handset.

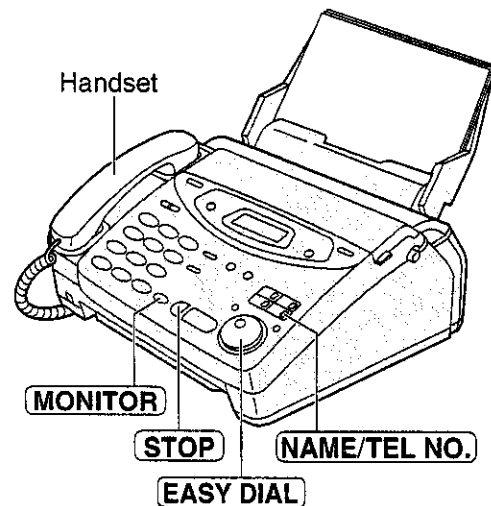

### Helpful hint:

- You can confirm the stored items on the display (see below) or on the telephone number list (p. 88).

### Note:

- If the desired name has not been stored, press **STOP** and dial the number manually.

## To confirm the stored items on the display

1. Rotate **EASY DIAL** until the desired name is displayed.

Example:

2. Press **NAME/TEL NO.**

- To stop the operation, press **STOP**.
3. Press **MONITOR** or lift the handset.
    - The unit will automatically dial the number.

## To search for a name by initial

**Example:** When you want to search for the name "Lisa"

1. Rotate **EASY DIAL** until any name is displayed.

Example:

2. Press **5** repeatedly until any name with the initial "L" is displayed (see the character table on page 25).

3. Rotate **EASY DIAL** to the right until "Lisa" is displayed.

- To stop the operation, press **STOP**.
4. Press **MONITOR** or lift the handset.
    - The unit will automatically dial the number.

### Note:

- When you want to search for symbols (not letters or numbers), press **\*** in step 2.

## Caller ID service from your phone company

This unit is compatible with a Caller ID service offered by your local telephone company. To use this feature, you must subscribe to a Caller ID service.

### Caller ID and its capabilities

Caller ID allows you to view the telephone number or name of the caller before you answer the call. The calling party information (telephone number has priority) will be displayed after the first ring. By using Caller ID, you have the option of whether or not to answer the call depending on the caller.

The unit also stores the caller's information and prints a list automatically after every 35 calls (p. 40).

- To print out the Caller ID list manually, see page 88.

#### Important:

- If a charge for local calls is unacceptable, the "Dial" button should NOT be used for local calls. Only the 7-digits of the local number should be dialed from your telephone. DO NOT dial the area code digit or the "0" prefix.

### How Caller ID is displayed

- 1 When a call is received, the display will show the caller's telephone number after the first ring.

Example:

- 2 You can display the caller's number and name respectively by pressing **NAME/TEL NO.**

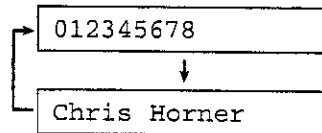

- 3 After hanging up, the caller's information (telephone number, the time of the call and name) will automatically be saved in the Caller ID list (p. 40).

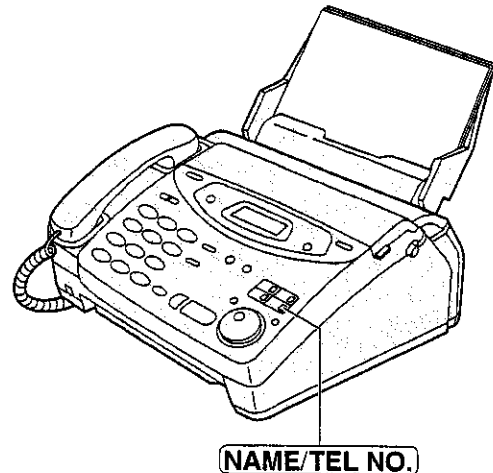

#### Note:

- If the unit is connected to a PBX system, you may not receive the caller's information. Consult your PBX supplier.
- The Caller ID service is currently provided in calling areas by caller identification technology. If the caller's information cannot be received, the display will show as follows.

Display:

The caller dialed from an area which does not provide the Caller ID service.

The caller has requested not to send their information.

- Telecom does not currently send a NAME for Caller ID.

# Caller ID

## Viewing the Caller ID list on the display

The unit stores the caller's information and makes a list of up to 35 callers in chronological order. When the memory is full and the unit receives a new call, the oldest data will automatically be erased.

With the Caller ID list, the following convenient features are available.

- Viewing who has called you on the display (See below.)
- Dialling a telephone number from the list (p. 37)
- Storing a telephone number for automatic dialling from the list (p. 38)
- Printing out a Caller ID list (p. 88)

**1** Press **CALLER ID SEARCH**.

Example: 2 NEW CALLS



Display: USE EASY DIAL

**2** Rotate **EASY DIAL** to search the Caller ID list (see below).

**3** If you want to know the caller's name and the date/time of the call, press **NAME/TEL NO.** repeatedly while the display is showing the desired phone number.

- The display will alternate the number, date/time and name by pressing **NAME/TEL NO.**

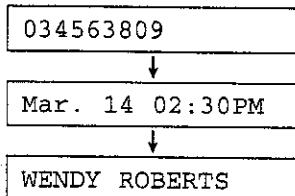

**4** Press **STOP** to exit the Caller ID list.

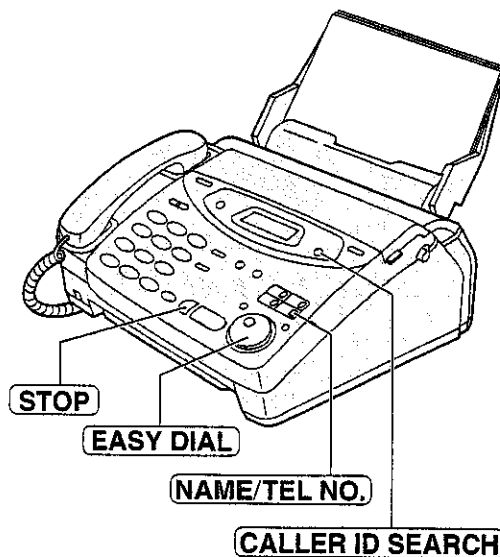

**Note:**

- If the caller's name cannot be received, the following message will be displayed.

Display: NO NAME RCVD

- The prefix "00" of an international phone number will not be displayed.

### Ex. When you search from the most recent call/oldest call

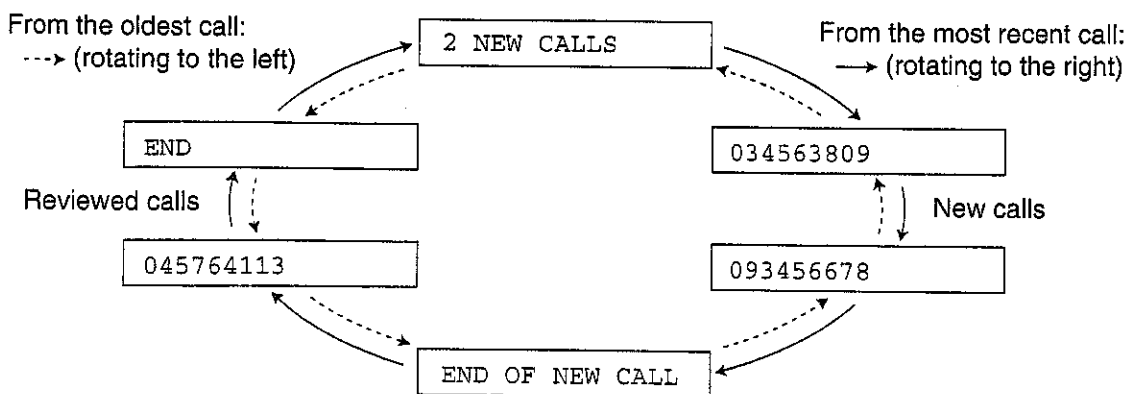

**Note:**

- To move between calls, rotate **EASY DIAL**.
- The display will show "END OF NEW CALL" after the last new call in the list.
- The display will show "END" after the last call in the list.
- If the display shows "NO CALLER DATA" and a beep sounds, the Caller ID list is empty.
- Telecom does not currently send a NAME for Caller ID.

## Calling back from the Caller ID list

You can easily call back a telephone number recorded in the Caller ID list.

If a charge for local calls is unacceptable, the "Dial" button should NOT be used for local calls. Only the 7-digits of the local number should be dialed from your telephone. DO NOT dial the area code digit or the "0" prefix.

### Important:

- This feature is not available in the following cases.
  - The telephone number includes data other than numbers (ie., \* or #).
  - The telephone number information was not received.

**1** Press **CALLER ID SEARCH**.

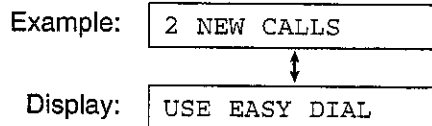

**2** Rotate **EASY DIAL** until the desired telephone number or name is displayed.

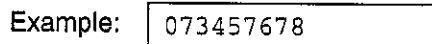

**3** Press **MONITOR** or lift the handset.

- The unit will automatically dial the number.

**4** When finished talking using the handset, replace it.

### Note:

- You can send a fax by pressing **START/SET/COPY** with a document on the document feeder tray after step 3.
- If a telephone number is not displayed when pressing **NAME/TEL NO.**, you cannot call back that caller.
- To call back an international number from the Caller ID list, first store the number in the EASY DIAL directory or One-Touch Dial keys (p. 38), and edit the number by adding the prefix "00" (p. 30, 33).
- Telecom does not currently send a NAME for Caller ID.

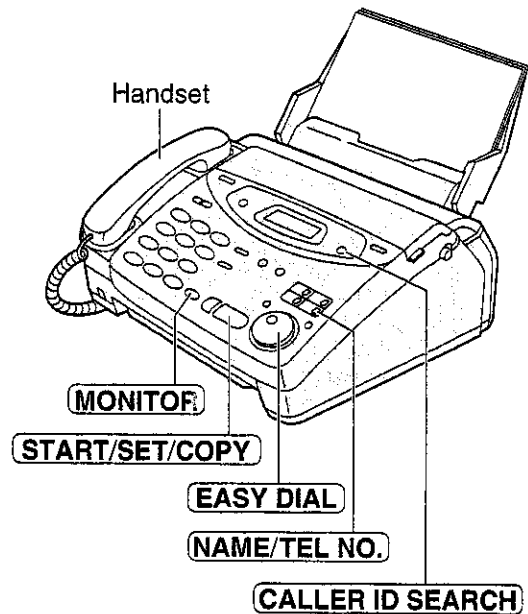

# Caller ID

## Storing telephone numbers in the One-Touch Dial and EASY DIAL directory from the Caller ID list

You can store names and telephone numbers in the One-Touch Dial and EASY DIAL directory from the Caller ID list. If a charge for local calls is unacceptable, the "Dial" button should NOT be used for local calls. Only the 7-digits of the local number should be dialed from your telephone. DO NOT dial the area code digit or the "0" prefix.

### Important:

- This feature is not available in the following cases.
  - The telephone number includes data other than numbers (ie., \* or #).
  - The telephone number information was not received.

**1** Press **CALLER ID SEARCH**.

Example:

Display:

**2** Rotate **EASY DIAL** until the telephone number you want to store is displayed.

Example:

**3** Press **DIRECTORY PROGRAM**.

↓

**4** a: To store in the One-Touch Dial memory:  
For stations 1–3, press one of the One-Touch Dial keys.

Press **START/SET/COPY**.

Example:

- To enter a name, see page 25.

Press **START/SET/COPY**.

For stations 4–6, press **LOWER**, then press one of the One-Touch Dial keys.

Example:

- To enter a name, see page 25.

Press **START/SET/COPY**.

- A new entry will overwrite any previous information.
- If you are using One-Touch Dial keys 1, 2 or 3 as BROADCAST keys (p. 50), One-Touch Dial keys cannot be used for this feature.
- You can only store a name up to 10 characters long. To edit the name and number, see the instructions on page 30.

b: To store in the EASY DIAL directory:  
Rotate **EASY DIAL**.

Example:

- To enter a name, see page 25.

Press **START/SET/COPY**.

- If the directory is full, a name and number cannot be stored.
- You can only store a name up to 10 characters long. To edit the name and number, see the instructions on page 33.

**5** Press **START/SET/COPY**.

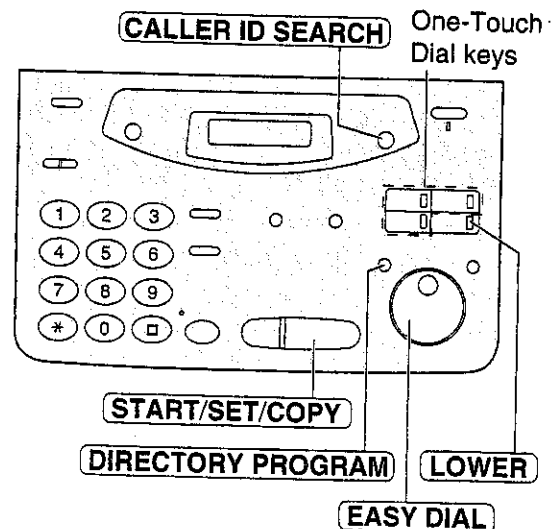

### Note:

- You cannot store caller information in the One-Touch Dial and EASY DIAL directory if a telephone number is not displayed.

## Erasing all callers' information

You can erase all of the entries in the Caller ID list.

- 1 Press **MENU** three times.  
 Display: **3.CALLER SET UP**
- 2 Press **START/SET/COPY**.  
**CALL LIST ERASE**
- 3 Press **START/SET/COPY**.  
**ALL ERASE OK?**
  - If you do not want to erase the information, press **STOP**.
- 4 Press **START/SET/COPY**.  
**ERASE COMPLETED**
- 5 Press **STOP** to exit the program.

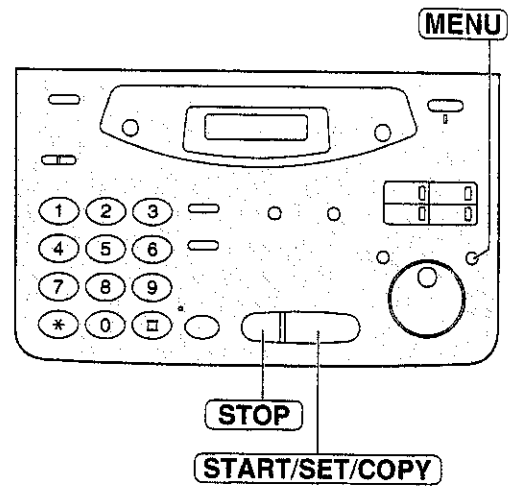

# Caller ID

## Automatic Caller ID list

This feature will print a Caller ID list automatically after every 35 new calls. After printing, only the oldest caller information will be erased when a new call is received. When this feature is turned off, the unit will store the records of caller information, but will not print the Caller ID list automatically.

**1** Press **MENU**.  
Display: 1.SYSTEM SET UP

**2** Press **2 6**, then **2 6**.  
AUTO CALL. LIST

**3** Press **START/SET/COPY**.  
MODE=ON

**4** Press **▼** or **▲** to select the desired setting.  
• If this feature is not required select "OFF".

**5** Press **START/SET/COPY**.  
SETUP ITEM [ ]

**6** Press **MENU**.

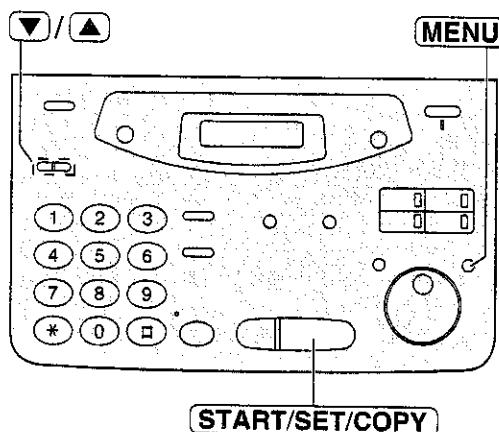

### Sample of a Caller ID list

CALLER ID LIST				
[ NEW ]				
Jan. 04 1999 04:37PM				
NO.	NAME	TELEPHONE NUMBER	TIME OF CALL	ANSWER
01	WENDY ROBERTS	1233453	Jan. 04 02:35PM	FAX
02	ALLAN STONE	4561032	Jan. 03 08:35AM	TEL
[ OLD ]				
NO.	NAME	TELEPHONE NUMBER	TIME OF CALL	ANSWER
01	MIKE TIMAR	7893451	Jan. 01 02:35PM	TEL

- The NAME/TELEPHONE NUMBER/TIME OF CALL information is received through a Caller ID service (p. 35).
- ANSWER: How the call was received by the unit.
  - FAX: Facsimile
  - TEL: TelephoneIf the unit did not respond to the call, the ANSWER column will be blank.
- You can also print a Caller ID list manually (p. 88).
- Telecom does not currently send a NAME for Caller ID.



# Talking to the caller after fax transmission or reception

You can have a conversation with the same call after a fax message is completed. This will save the added expense and time of making another call.

**This feature only works when the other party's fax machine is equipped with a voice contact feature.**

## Initiating voice contact

- 1 Press **MONITOR** while transmitting or receiving documents.

Display: **VOICE STANDBY**

- Your unit will call the other party with a distinctive ring.
- When the other party answers, your unit will emit a distinctive ring.

- 2 Lift the handset to start talking.

### Note:

- If you initiate voice contact during transmission, the unit will call you with a distinctive ring after all of the documents have been transmitted.
- If you initiate voice contact during reception, the unit will call you with a distinctive ring after the current page of the document is received.

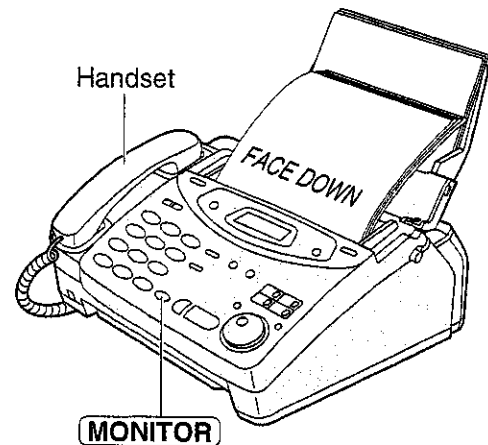

## Receiving a request for voice contact

- 1 If the other party initiates voice contact, your unit will sound a distinctive ring and the following will be displayed.

Display: **PLEASE PICK UP**

- 2 Lift the handset within 10 seconds of the distinctive ring to start talking.

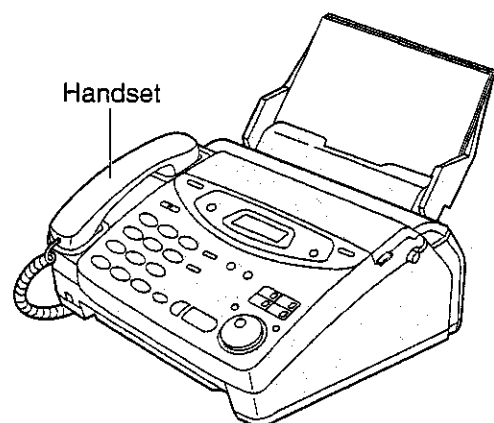

# Sending Faxes

## Sending a fax manually

- 1 Open the document feeder tray.
- 2 Adjust the width of the document guides to the size of the document.
- 3 Insert the document (up to 15 pages) **FACE DOWN** until a single beep is heard and the unit grabs the document.

Display:

- 4 If necessary, press **RESOLUTION** repeatedly to select the desired setting (see below).
- 5 Press **MONITOR** or lift the handset (This step is optional. See note.).

- 6 Dial the fax number.

Example:

- 7 **When a fax tone is heard:**  
Press **START/SET/COPY**, and replace the handset if using it.  
OR  
**When the other party answers your call:**  
Lift the handset if using the monitor and ask them to press their start button. When a fax tone is heard, press **START/SET/COPY** and replace the handset.

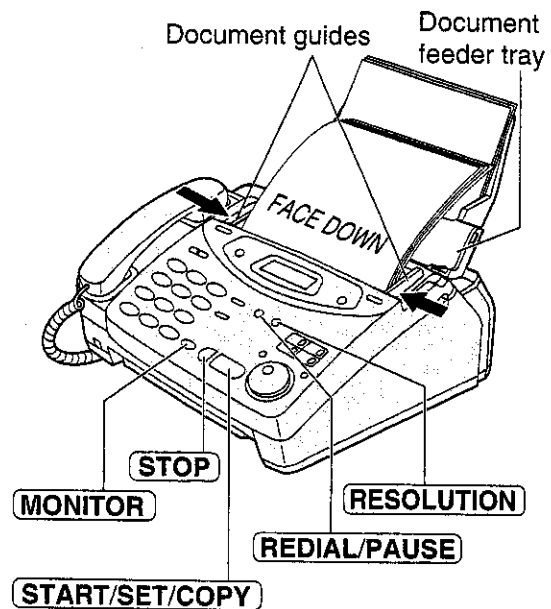

### Note:

- If you cannot send a fax, confirm the problem by printing a journal report (p. 88) and see page 74 to solve the problem.
- Performing step 5 allows you to identify any possible problems in sending a fax. For the parties with whom you have experienced no problems, you can skip step 5. Dial the fax number and press **START/SET/COPY**.

## To feed more than 15 pages at a time

Insert the first 15 pages of the document. Add the extra pages (up to 15) before the last page is fed into the unit.

## To redial the last number

Press **REDIAL/PAUSE**.

- If the line is busy, the unit will automatically redial the number up to 2 times.
- During redial, the following will be displayed.

Display:

- To cancel redialling, press **STOP**.

## To stop transmission

Press **STOP**.

To eject the document, press **STOP** again.

## To select the resolution

Select the desired resolution according to the type of document.

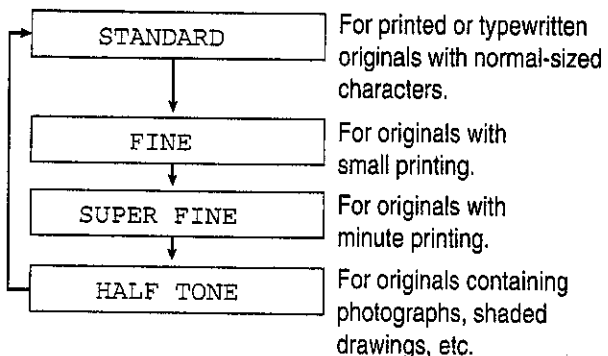

- Using the fine, super fine or half tone setting will increase the transmission time.
- If the resolution setting is changed during feeding, it will be effective from the next sheet.
- The super fine resolution only works with other compatible fax machines.

## Sending a fax using the One-Touch Dial

Before using this feature, program the desired names and telephone numbers into the One-Touch Dial (p. 30).

- 1** Open the document feeder tray.
- 2** Adjust the width of the document guides to the size of the document.
- 3** Insert the document (up to 15 pages) **FACE DOWN** until a single beep is heard and the unit grabs the document.

Display: STANDARD

- 4** If necessary, press **RESOLUTION** repeatedly to select the desired setting (p. 42).
- 5** **For stations 1-3**  
Press the desired One-Touch Dial key.  
**For stations 4-6**  
Press **LOWER**, then press the desired One-Touch Dial key.

Example: FAX=<John>  
↓  
CONNECTING . . . .

- The unit will start transmission.

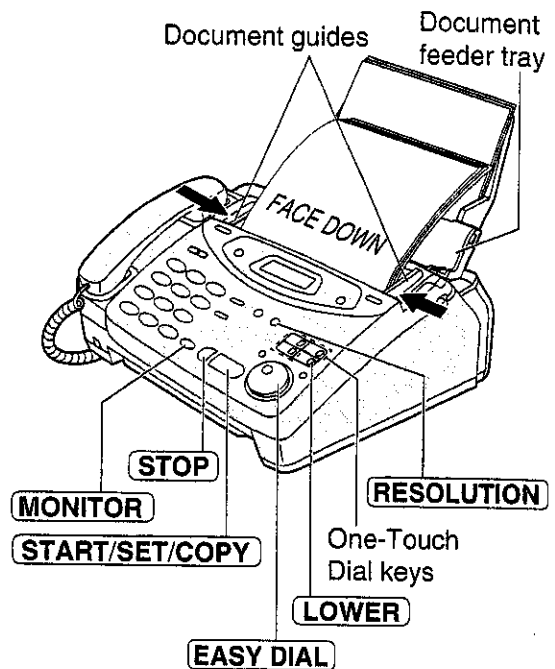

Fax/Copy

### Helpful hints:

- You can confirm the stored items on the display (p. 34) or on the telephone number list (p. 88).
- You can use the EASY DIAL directory to select the station name instead of using the One-Touch Dial keys. Rotate **EASY DIAL** until the desired name is displayed, then press **START/SET/COPY**.
- The connecting tone will be heard during dialling to tell you the status of the other party's machine (p. 55).

### If your unit does not send a fax

Verify that the number dialled is answered by the other party's machine.

- 1.** Press **MONITOR**.
- 2. For stations 1-3**  
Press the desired One-Touch Dial key.  
**For stations 4-6**  
Press **LOWER**, then press the desired One-Touch Dial key.

### Fax auto redial

If the line is busy or there is no answer, the unit will automatically redial the number up to 2 times.

- This feature is also available for;
  - sending a fax using the EASY DIAL directory (p. 44).
  - delayed transmission (p. 48).
- During redial, the following will be displayed.

Display: WAITING REDIAL

- To cancel redialling, press **STOP**.

# Sending Faxes

## Sending a fax using the EASY DIAL directory

Before using this feature, program the desired names and telephone numbers into the directory (p. 32).

- 1 Open the document feeder tray.
- 2 Adjust the width of the document guides to the size of the document.
- 3 Insert the document (up to 15 pages) FACE DOWN until a single beep is heard and the unit grabs the document.

Display:

- 4 If necessary, press **RESOLUTION** repeatedly to select the desired setting (p. 42).

- 5 Rotate **EASY DIAL** until the desired name is displayed.

Example:

- To confirm the number, press **NAME/TEL NO.**

- 6 Press **START/SET/COPY**.

↓

- The unit will start transmission.

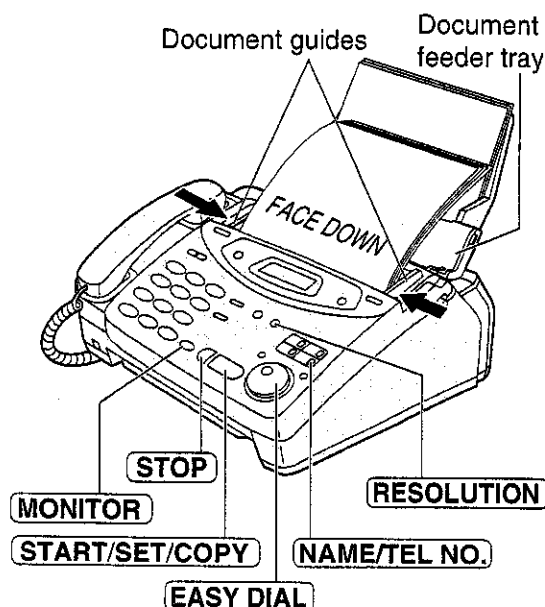

### Helpful hints:

- You can confirm the stored items on the display (p. 34) or on the telephone number list (p. 88).
- The connecting tone will be heard during dialling to tell you the status of the other party's machine (p. 55).

### Note:

- If the desired name has not been stored, press **STOP** and dial the number manually.
- For further details about using the EASY DIAL, see page 34.

### If your unit does not send a fax

Verify that the number dialled is answered by the other party's machine.

1. Rotate **EASY DIAL** until the desired name is displayed.
2. Press **MONITOR**.

## Documents you can send

### Minimum size

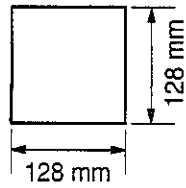

### Maximum size

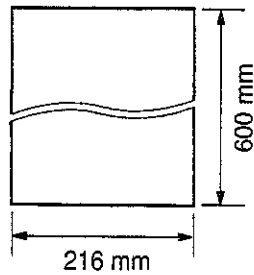

### Effective scanning area

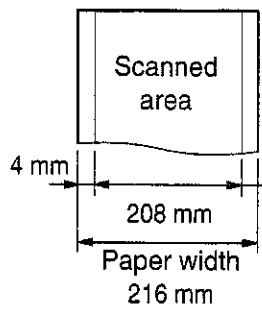

### Document weight

Single sheet:  
45 g/m<sup>2</sup> to 90 g/m<sup>2</sup>

Multiple sheets:  
60 g/m<sup>2</sup> to 75 g/m<sup>2</sup>

### Note:

- Remove clips, staples or other similar fastening objects.
- Check that ink, paste or correction fluid has dried.
- Do not send the following types of documents. Use copies for fax transmission.
  - Chemically treated paper such as carbon or carbonless duplicating paper
  - Electrostatically charged paper
  - Heavily curled, creased or torn paper
  - Paper with a coated surface
  - Paper with a faint image
  - Paper with printing on the opposite side that can be seen through the front (e.g. newspaper)

# Sending Faxes

## Sending report for confirmation

The sending report will provide you with a printed record of fax transmission results. One of the following choices is available.

- ERROR:** The sending report will print out only when fax transmission fails (pre-selected setting).
- ON:** The sending report will always print out, indicating whether fax transmission is successful or not.
- OFF:** The sending report will not print.

- 1 Press **MENU**.  
Display: 1.SYSTEM SET UP
- 2 Press **⏏**, then **0 4**.  
SENDING REPORT
- 3 Press **START/SET/COPY**.  
MODE=ERROR ▼▲
- 4 Press ▼ or ▲ to select the desired setting.
- 5 Press **START/SET/COPY**.  
SETUP ITEM [ ]
- 6 Press **MENU**.

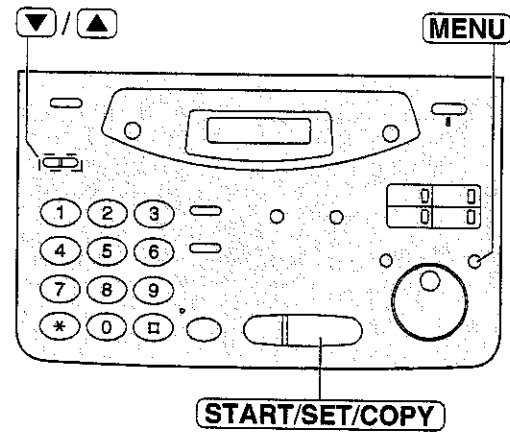

### Sample of a sending report

SENDING REPORT							
Jan. 20 1999 01:19PM							
NO.	OTHER FACSIMILE	START TIME	USAGE TIME	MODE	PAGES	RESULT	*CODE
01	2345678	Jan. 20 01:18PM	00'51	SND	00	COMMUNICATION ERROR	(43)

Communication message  
(p. 74)

Error code  
(for service personnel use only)

## Automatic journal report

This feature prints a journal report automatically after every 35 new fax communications. After printing, only the oldest communication result will be erased when a new communication occurs. When this feature is deactivated, the unit will store the records of the fax communications, but will not print the journal report automatically.

- 1 Press **MENU**.  
Display: 1.SYSTEM SET UP
- 2 Press **□**, then **2 2**.  
AUTO JOURNAL
- 3 Press **START/SET/COPY**.  
MODE=ON ▼▲
- 4 Press ▼ or ▲ to select the desired setting.  
● If this feature is not required, select "OFF".
- 5 Press **START/SET/COPY**.  
SETUP ITEM [ ]
- 6 Press **MENU**.

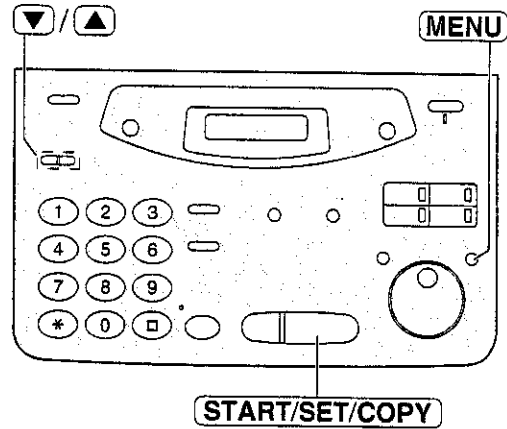

Fax/Copy

### Sample of a journal report

JOURNAL								
Jan. 25 1999 05:22PM								
NO.	OTHER FACSIMILE	START TIME	USAGE TIME	MODE	PAGES	RESULT	*CODE	
01	3332222	Jan. 21 02:14PM	00'45	SND	01	OK		
02	9998765	Jan. 21 03:17PM	00'58	SND	02	OK		
03	John	Jan. 21 05:18PM	00'48	RCV	01	OK		
04	555556677	Jan. 21 10:35AM	02'45	SND	03	COMMUNICATION ERROR	(43)	
05			00'50	SND	05	OK		
06				RCV	03	OK		

Communication message (p. 74)

Error code (for service personnel use only)

**Note:**

- You can also print a journal report manually (p. 88).

# Sending Faxes

## Delayed transmission (sending a fax at a specified time)

Using a built-in clock, this unit can send documents automatically at a specified time. This allows you to take advantage of low-cost calling hours offered by your telephone company. The delayed transmission can be reserved to take place up to 24 hours in advance.

- 1** Insert the document **FACE DOWN** until a single beep is heard and the unit grabs the document.

Display: STANDARD

- 2** Press **MENU**.

1. SYSTEM SET UP

- 3** Press **#**, then **2 5**.

DELAYED SEND

- 4** Press **START/SET/COPY**.

MODE=OFF ▼▲

- 5** Press ▼ or ▲ to select "ON".

MODE=ON ▼▲

- 6** Press **START/SET/COPY**.

FAX=

- 7** Enter the fax number using the dial keypad, One-Touch Dial or **EASY DIAL**.

- 8** Press **START/SET/COPY**.

TIME=12:00AM

- 9** Enter the transmission start time. Press **\*** to select "AM" or "PM".

**Example:** 11:30PM

Press **1 1 3 0**, then press **\*** until "PM" is displayed.

TIME=11:30PM

- 10** Press **START/SET/COPY**.

SETUP ITEM [ ]

- 11** Press **MENU**.

SEND AT 11:30PM

- At the programmed time, the unit will automatically start transmission.

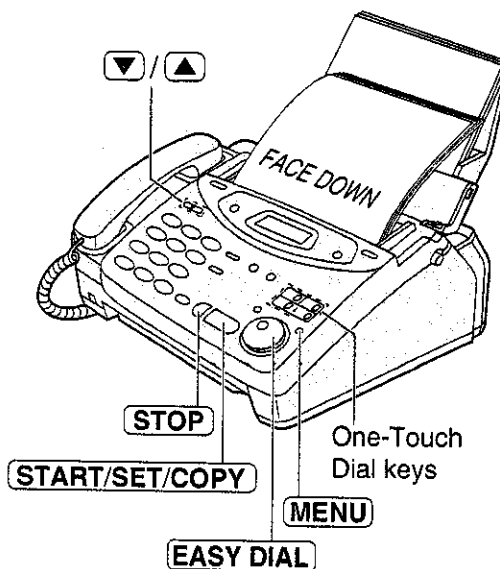

### Note:

- You can receive, transmit and copy documents while delayed transmission is set.

### To cancel the delayed transmission setting

- 1.** Press **STOP** while the unit is idle.

Display: SEND CANCELED?

↕  
YES: PRESS SET

- 2.** Press **START/SET/COPY**.



## From memory

The unit is able to scan and store documents into memory, and then transmit the stored document. The memory capacity is approx. 25 pages based on the CCITT No. 1 Test Chart in standard resolution. For the CCITT No. 1 Test Chart, see page 91.

### Transmitting documents from memory

- 1 Insert the document FACE DOWN.
- 2 Enter the fax number using the dial keypad.
- 3 Press **QUICK SCAN**.
  - The document will be fed into the unit and scanned into memory. After storing all of the pages, the unit will transmit the document.
  - The amount of memory used will be shown as a percentage on the display.

Display: PAGES=01 05  
Amount of memory used (%)

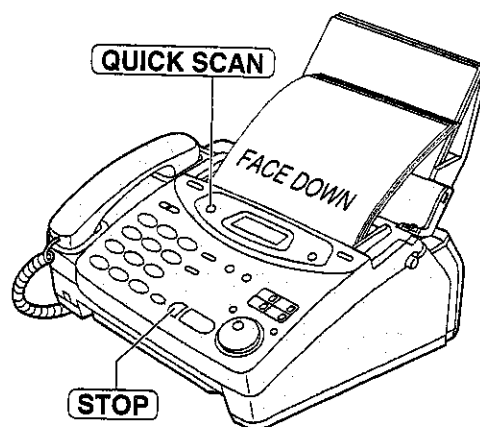

#### Note:

- The stored document will be automatically erased after transmission.
- To cancel the memory transmission, press **STOP** during or after scanning the document.
- If you select the fine, super fine or half tone resolution, the number of documents that can be sent will decrease.
- If the stored pages exceed the memory capacity, the transmission will be canceled.
- If the other party's fax number is written on the document, you can enter the number by referring to the document before inserting it.

# Sending Faxes

## Multiple stations

This feature is useful for sending the same document to selected parties whose telephone numbers are stored in the One-Touch Dial or EASY DIAL directory. You must program the desired parties into one of the BROADCAST keys (One-Touch Dial keys 1, 2 or 3).

### Important:

- Before programming, make sure that the desired telephone numbers have been stored into the One-Touch Dial or EASY DIAL directory.
- The BROADCAST keys can be used as One-Touch Dial keys 1, 2 or 3 or as broadcast keys. These functions cannot be used at the same time.

## Programming the BROADCAST keys with telephone numbers

- 1** Press **DIRECTORY PROGRAM**.

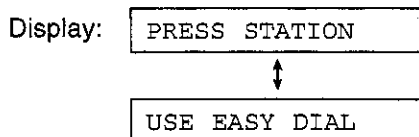

- 2** Press one of the **BROADCAST** keys.

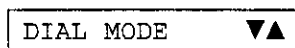

- 3** Press ▼ or ▲ to select "BROADCAST".



- 4** Press **START/SET/COPY**.

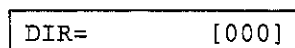

- 5** Enter the station.

**a: Using the One-Touch Dial:**

For stations 1–3 which are not used as **BROADCAST** keys, press the preset One-Touch Dial key.

For stations 4–6, press **LOWER**, then press the preset One-Touch Dial key.

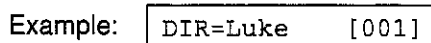

**b: Using the EASY DIAL directory:**

Rotate **EASY DIAL** until the desired name is displayed.

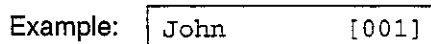

Press **START/SET/COPY**.

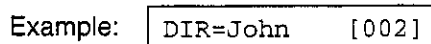

- To enter other stations, repeat this step (up to 20 stations).

- 6** Press **START/SET/COPY** after entering all of the desired stations.

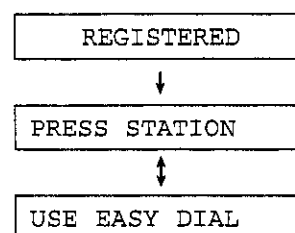

- To program another BROADCAST key, repeat steps 2 to 6.

- 7** Press **DIRECTORY PROGRAM** to exit the program.

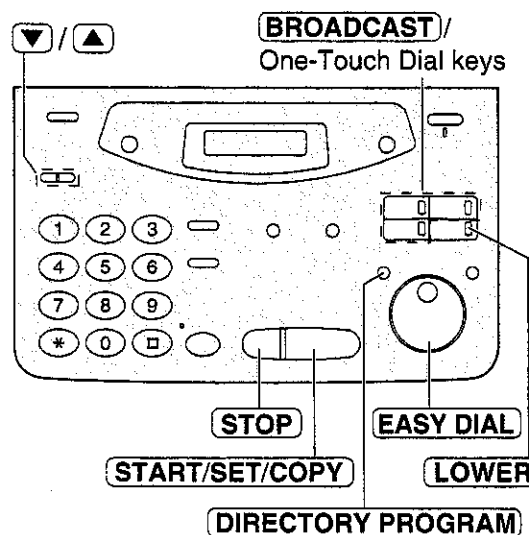

### Note:

- If you make a mistake while programming, press **STOP**, then make the correction.
- Confirm the stored numbers by printing a broadcast list (p. 88).

## Adding a new name and number

- 1 Rotate **EASY DIAL** until the desired BROADCAST key is displayed.  
Example: <BROADCAST1>
  - 2 Press **DIRECTORY PROGRAM**.  
ADD=\* DELETE=#
  - 3 Press **\*** to select "ADD".  
Example: Alex
  - 4 Rotate **EASY DIAL** until the desired name is displayed.  
Example: Jack
  - 5 Press **START/SET/COPY**.  
REGISTERED  
↓  
Example: Mike
- To add other stations, repeat steps 4 and 5 (up to 20 stations).

- 6 Press **DIRECTORY PROGRAM** to exit the program.

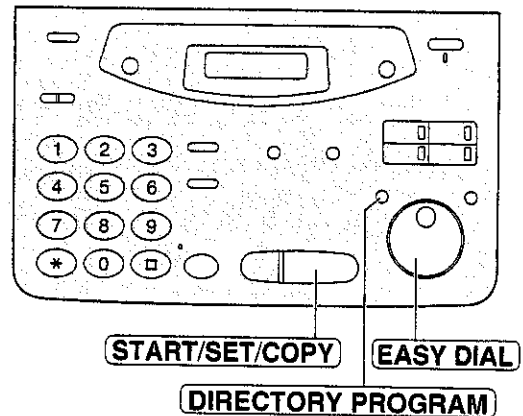

## Erasing a stored name and number

- 1 Rotate **EASY DIAL** until the desired BROADCAST key is displayed.  
Example: <BROADCAST1>
- 2 Press **DIRECTORY PROGRAM**.  
ADD=\* DELETE=#
- 3 Press **#** to select "DELETE".  
• The first name will be shown.  
Example: Bob
- 4 Rotate **EASY DIAL** until the desired name is displayed.  
Example: Dick  
• If you do not want to erase the item, press **STOP**.
- 5 Press **START/SET/COPY**.  
DELETE OK?  
↑  
YES: PRESS SET

- 6 Press **START/SET/COPY**.  
DELETED  
↓  
Example: Bob
- To delete other stations, repeat steps 4 to 6.

- 7 Press **DIRECTORY PROGRAM** to exit the program.

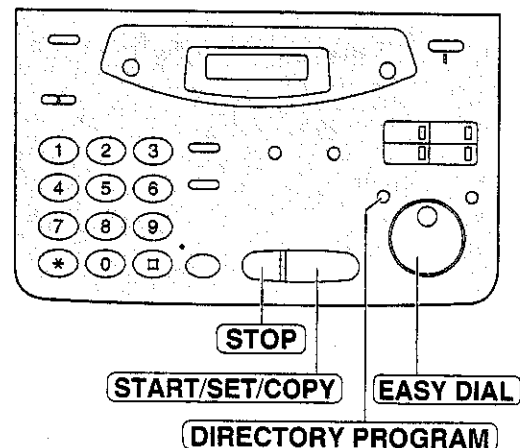

# Sending Faxes

## Using the BROADCAST keys

The document will be scanned and stored into memory when using the BROADCAST keys. After transmission, the stored document will be erased automatically.

The memory capacity is approx. 25 pages based on the CCITT No. 1 Test Chart in standard resolution. For the CCITT No. 1 Test Chart, see page 91.

- 1 Insert the document FACE DOWN.
- 2 Press the desired **BROADCAST** key.
  - The document will be fed into the unit and scanned into memory. The unit will then transmit the data to each station, calling each number sequentially.

### Note:

- If you select the fine, super fine or half tone resolution, the number of pages that the unit can transmit will decrease.
- If one of the stations is busy or does not answer, the station will be skipped. All skipped stations will be redialled up to 2 times after all of the other stations have been called.

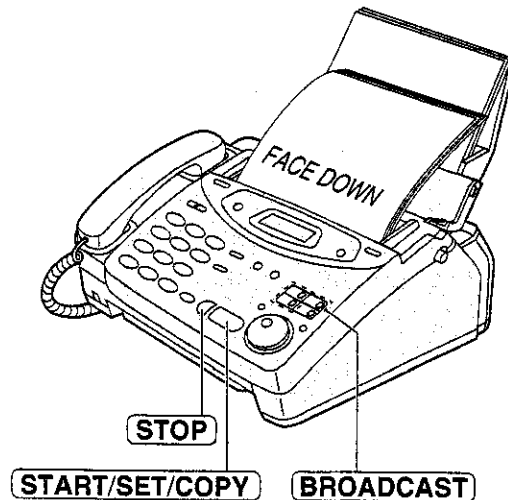

## To cancel the broadcast setting

1. Press **STOP** while the unit displays "BROADCASTING".

Display: 

SEND CANCELED?
----------------

  
↑  

YES: PRESS SET
----------------

2. Press **START/SET/COPY**.

## Broadcast report

After all of the transmissions have been completed, the unit will automatically print the following report.

### Sample of a broadcast report:

BROADCAST REPORT 1						Jan. 10 1999 03:36PM
NO.	OTHER FACSIMILE	START TIME	USAGE TIME	PAGES	RESULT	
01	Mike	Jan. 10 03:31PM	01'10	02	OK	
02	Peter	Jan. 10 03:33PM	01'08	02	OK	
03	Sam	Jan. 10 03:34PM	01'09	02	OK	
04	Kim	Jan. 10 03:35PM	01'10	02	OK	
TOTAL			004'37	008		

## Overseas mode

You may experience difficulty when transmitting documents overseas. This feature makes sending documents easier as the transmission speed is slowed down. Before starting transmission, follow the steps below.

- 1 Press **MENU**.  
 Display: 1. SYSTEM SET UP
- 2 Press **□**, then **2** **3**.  
 OVERSEAS MODE
- 3 Press **START/SET/COPY**.  
 MODE=OFF ▼▲
- 4 Press ▼ or ▲ to select "ON".  
 MODE=ON ▼▲
  - If this feature is not required, select "OFF".
- 5 Press **START/SET/COPY**.  
 SETUP ITEM [ ]
- 6 Press **MENU**.

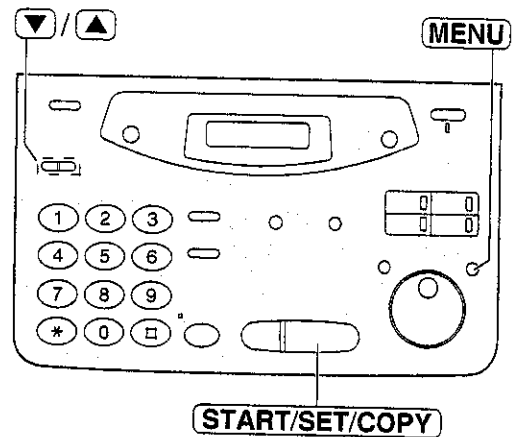

**Note:**

- After transmission, this feature will turn off automatically.
- A slower transmission speed will lengthen the call duration. Therefore the calling charge may be higher.
- This feature is not available for transmission using the BROADCAST keys.

Fax/Copy

# Sending Faxes

## Error correction mode setting

ECM stands for Error Correction Mode.

You can send documents even if there is static interference on the telephone line, provided both the transmitting and receiving stations are ECM compatible.

**ON:** The unit functions with ECM communication (pre-selected setting).

**OFF:** The unit does not function with ECM communication.

- 1 Press **MENU**.  
Display: 1.SYSTEM SET UP
- 2 Press **□**, then **6** **8**.  
ECM SELECTION
- 3 Press **START/SET/COPY**.  
MODE=ON ▼▲
- 4 Press ▼ or ▲ to select the desired setting.
- 5 Press **START/SET/COPY**.  
SETUP ITEM [ ]
- 6 Press **MENU**.

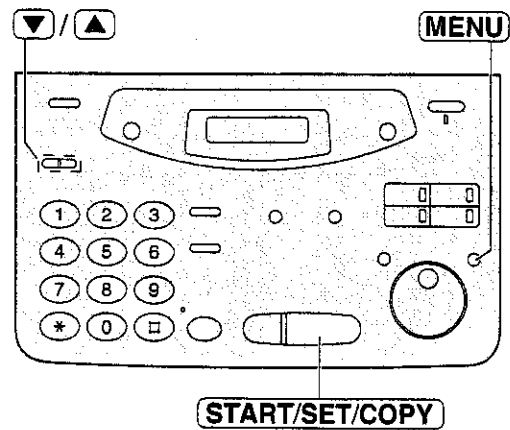

**Note:**

- You cannot change the setting of this feature if there are stored documents in memory. Clear the stored documents first.

## Connecting tone

This feature allows you to hear connecting tones, such as a fax tone, ring back tone or busy tone for several seconds when you send a fax using the One-Touch Dial or EASY DIAL directory. This will tell you the status of the other party's machine.

- Fax tone: The other party's machine is ready for reception.
- Ring back tone: If this tone continues, the other party's machine may not be a facsimile or may have run out of paper. Check with the other party.
- Busy tone: The other party's machine is busy. Let the unit continue redialling or press **STOP** and try again later.

This feature is set to "ON" as a pre-selected setting. If this feature is not required, you may turn it off.

- 1 Press **MENU**.  
Display: 1.SYSTEM SET UP
- 2 Press **□**, then **7 6**.  
CONNECTING TONE
- 3 Press **START/SET/COPY**.  
MODE=ON ▼▲
- 4 Press ▼ or ▲ to select the desired setting.  
● If this feature is not required, select "OFF".
- 5 Press **START/SET/COPY**.  
SETUP ITEM [ ]
- 6 Press **MENU**.

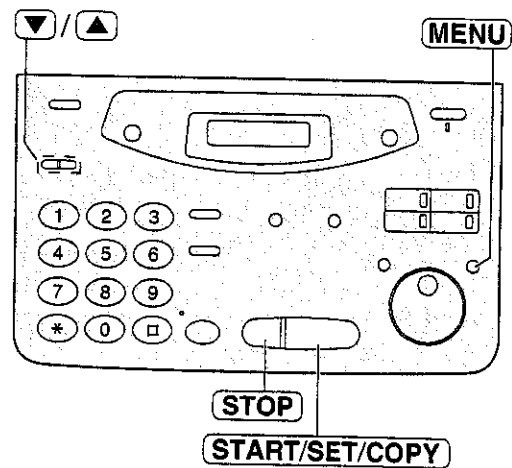

**Note:**

- The connecting tone volume cannot be adjusted.

# Receiving Faxes

## Setting the unit to receive calls

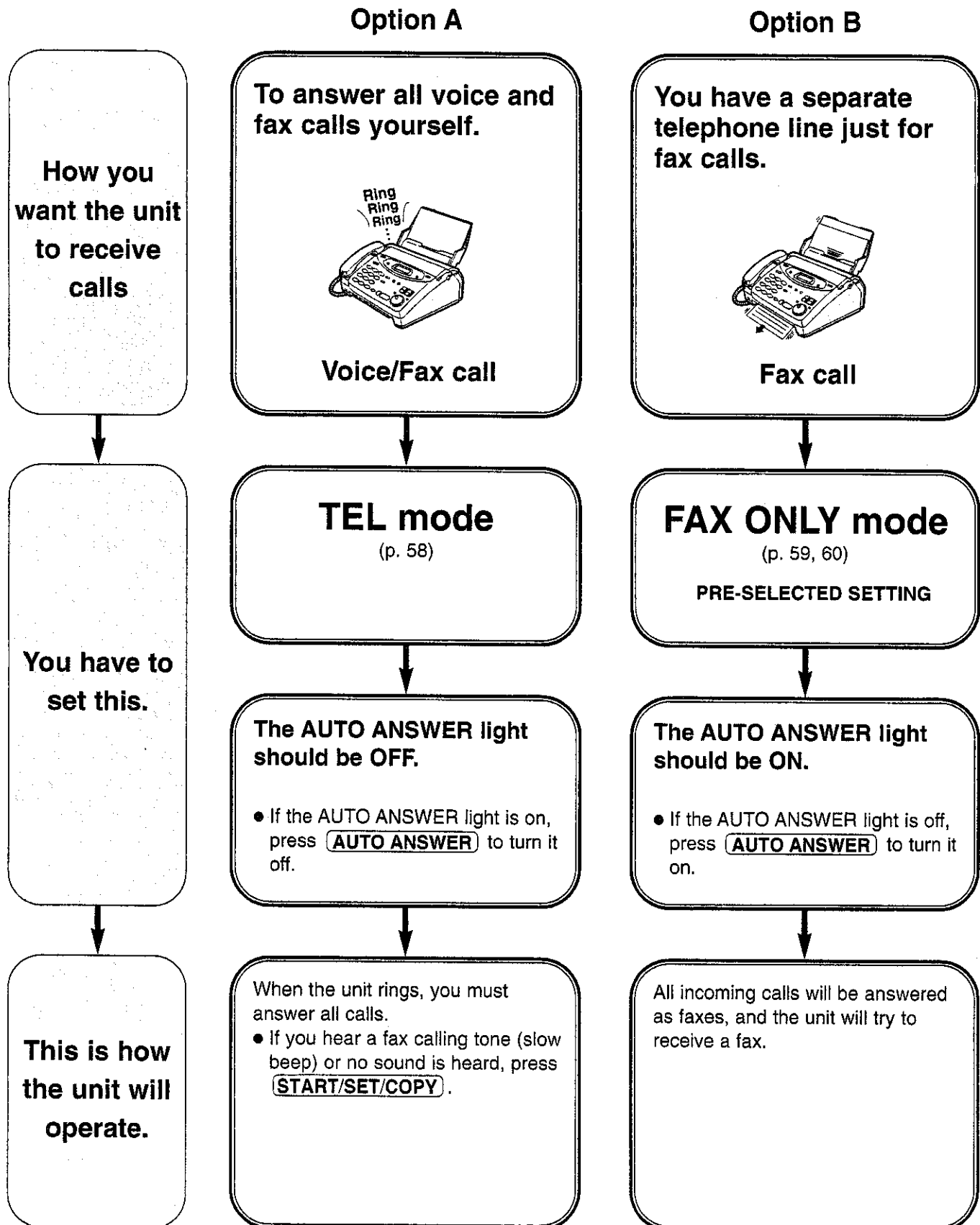



## Option C

### To receive fax calls without ringing.

(The unit will only ring for voice calls.)

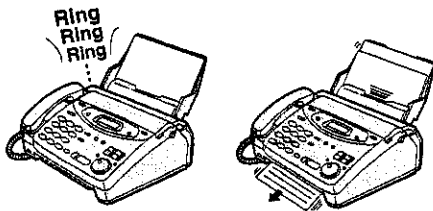

Voice call

Fax call

## TEL/FAX mode

(p. 62)

### The AUTO ANSWER light should be ON.

- If the AUTO ANSWER light is off, press **AUTO ANSWER** to turn it on.

#### When receiving voice calls:

The unit will ring.

#### When receiving fax calls:

The unit will receive fax documents without ringing.

## Other options

### Voice mail

If you have a voice mail service from your telephone company, you also need to subscribe to a Distinctive ring service (FaxAbility) (p. 61).

### Remote activation

If you answer a telephone in another room and hear the fax tone, you can activate the unit remotely by pressing \*9 (p. 66).

### Distinctive ring service (FaxAbility)

If you subscribe to a distinctive ring pattern service, you can have an additional number on the same telephone line, with a different ringing pattern (p. 61).

# Receiving Faxes

## TEL mode (answering all calls manually)

If the AUTO ANSWER light is on, turn it off by pressing **AUTO ANSWER**.

- The display will show the following.

Display: TEL MODE

**1** When the unit rings, lift the handset to answer the call.

**2** When:  
— document reception is required,  
— a fax calling tone (slow beep) is heard, or  
— no sound is heard,  
press **START/SET/COPY**.

CONNECTING.....

**3** Replace the handset.  
• The unit will start reception.

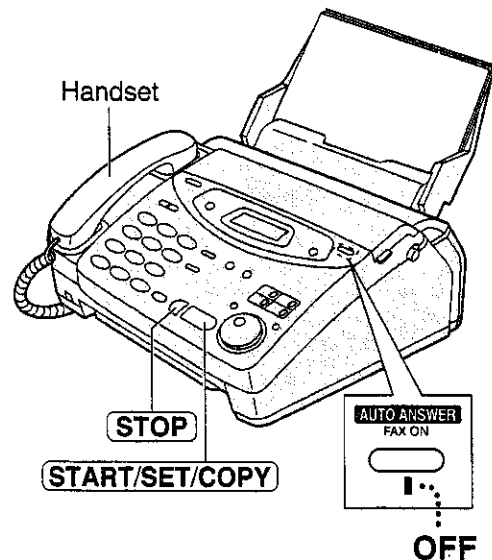

### Note:

- If you do not answer the call within 15 rings, the unit will temporarily switch to the fax and the caller can send document.

## To stop receiving the document

Press **STOP**.

## Friendly reception feature

When you answer a call and hear a fax calling tone (slow beep), the unit will automatically start receiving.

- If this feature is not required, set to "OFF" (p. 69).

## Memory reception

When a printing problem is detected, the unit will temporarily store the received document into memory.

While document is in memory, the unit will:

- display an error message and the following message alternately.

Display: FAX IN MEMORY

- alert you with slow beeps (memory reception alert).

- Follow the instructions on pages 75 and 76 to solve the problem and print the stored document.
- For memory capacity, see page 91.

## FAX ONLY mode

(all calls are received as faxes)

### Activating the FAX ONLY mode

If the AUTO ANSWER light is off, turn it on by pressing **AUTO ANSWER**.

- The display will show the following.

Display: FAX ONLY MODE

- The number of rings before a call is answered can be changed (p. 60).

#### Note:

- This mode should not be used with a telephone line which is used for both voice and fax calls. When the unit answers the call, fax communication is attempted with the other fax machine even if someone is trying to call you.

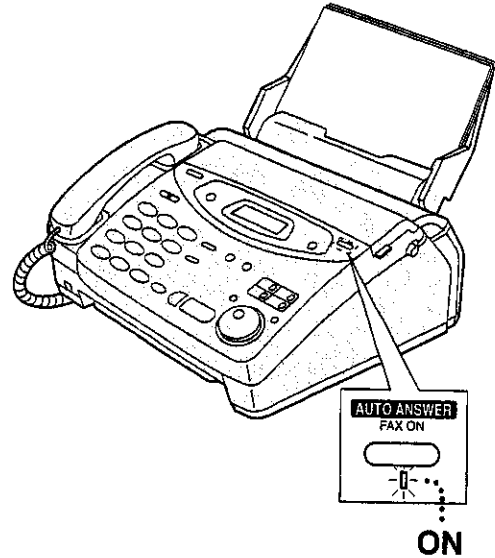

Fax/Copy

If you have a telephone line just for receiving faxes, we recommend the following setup.

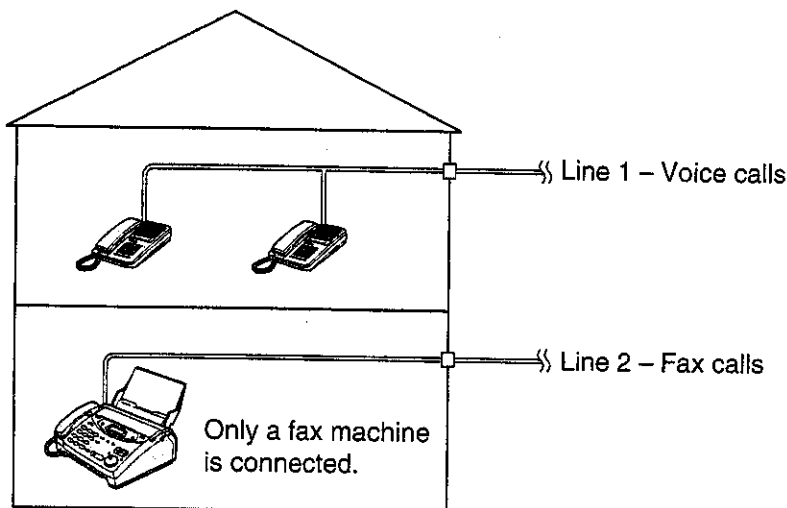

**Example:** One telephone line is used for voice calls and a separate telephone line for faxes. If someone sends a fax to Line 2, the fax machine will ring.

# Receiving Faxes

## FAX ONLY mode ring count

This setting determines the number of rings before the unit answers a call in the FAX ONLY mode. You can choose from 2 to 9 rings.

### Helpful hints:

- To answer a call before the unit does, increase the number of rings.
- If you have difficulty receiving faxes, the other parties may have tried to send faxes before confirming if your unit answered or not. Decrease the number of rings.

- 1 Press **MENU**.  
Display: 1.SYSTEM SET UP
- 2 Press **#**, then **0 6**.  
FAX RING COUNT
- 3 Press **START/SET/COPY**.  
RING=2 ▼▲
- 4 Press ▼ or ▲ to select the desired number, or enter the number using the dial keypad.
- 5 Press **START/SET/COPY**.  
SETUP ITEM [ ]
- 6 Press **MENU**.

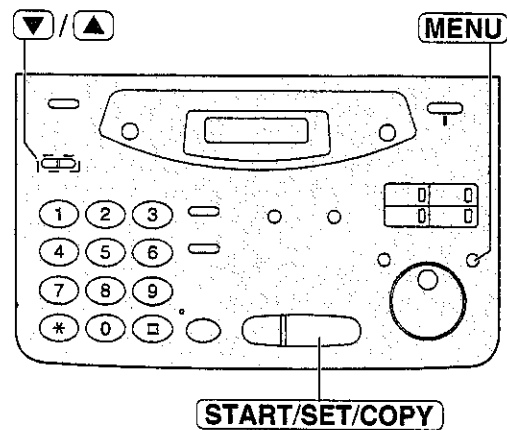

## Distinctive ring service (FaxAbility)

**Note for users in New Zealand:**

Telecom has called this service "FaxAbility".

This feature is only for use if you subscribe to a distinctive ring pattern service from their telephone company. For more information on the availability of this service in your area, please contact your telephone company before setting this feature on your unit.

The distinctive ring service gives you an additional phone number on a single telephone line, with a different ringing pattern.

When you wish to use the additional phone number as a facsimile telephone number, set the distinctive ring pattern feature to ON. When the unit detects a call matching the distinctive ring pattern, it will activate the fax function.

### Setting the distinctive ring pattern

**1** Press **MENU**.

Display: 1.SYSTEM SET UP

**2** Press **#**, then **3 1**.

RING DETECTION

**3** Press **START/SET/COPY**.

MODE=OFF ▼▲

**4** Press ▼ or ▲ to select "ON".

MODE=ON ▼▲

- If this feature is not required, select "OFF".

**5** Press **START/SET/COPY**.

SETUP ITEM [ ]

**6** Press **MENU**.

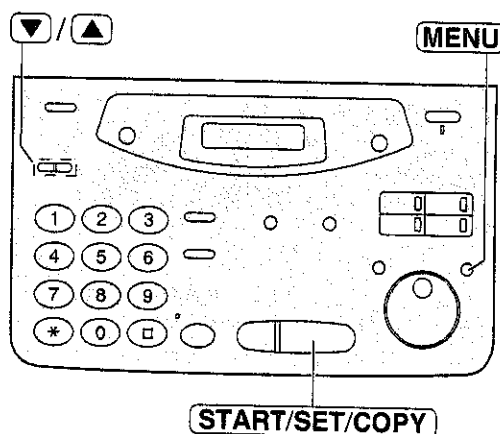

Fax/Copy

**Note:**

- The unit will automatically answer a distinctive ring call after the second ring regardless of the AUTO ANSWER, receive mode or ring count setting.

# Receiving Faxes

## TEL/FAX mode

(receiving voice calls with rings and fax calls without rings when you are near the unit)

Use this mode when you are always near the unit and want the fax machine to detect faxes without ringing. When a call is received, the unit will work as follows. If you have an extension telephone connected, see next page.

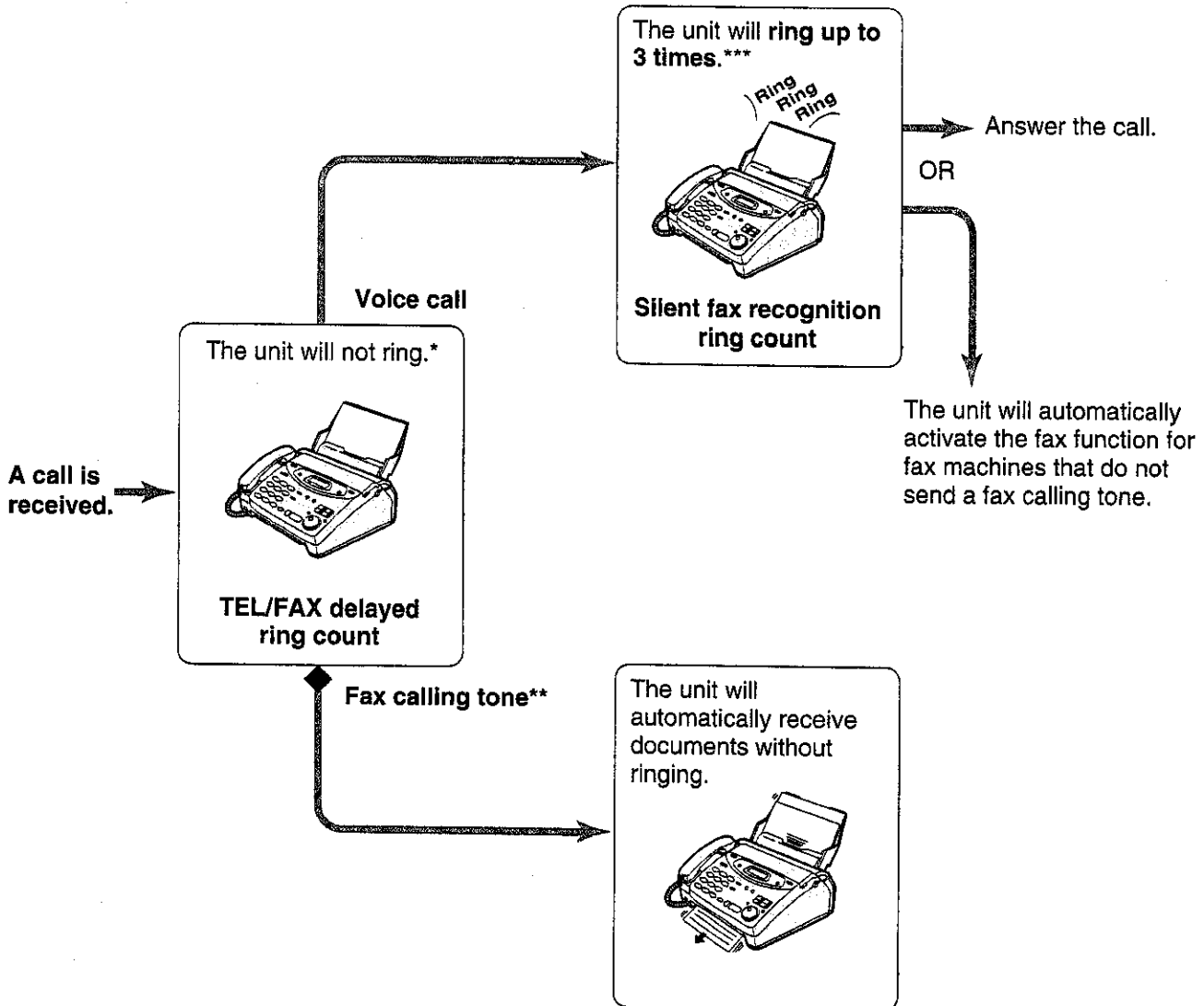

\* A telephone fee will be charged to the caller from this point.

\*\* A fax calling tone is automatically generated by the sending fax machine. Some fax machines do not have this capability.

\*\*\* While ringing, the unit will emit a different ring back tone to the calling party.

### Note:

- The unit will display the following when a call is received.

Display: INCOMING CALL

- The ringer should be on (p. 27).

## Ring pattern when an extension telephone is connected

If you absolutely must use another phone on the same phone line, you can disengage the TEL/FAX mode on a call by call basic by pressing \*0 before the fax machine begins communicating. Once the fax machine has activated, the only way to turn it off is by pressing the **STOP** button on the unit.

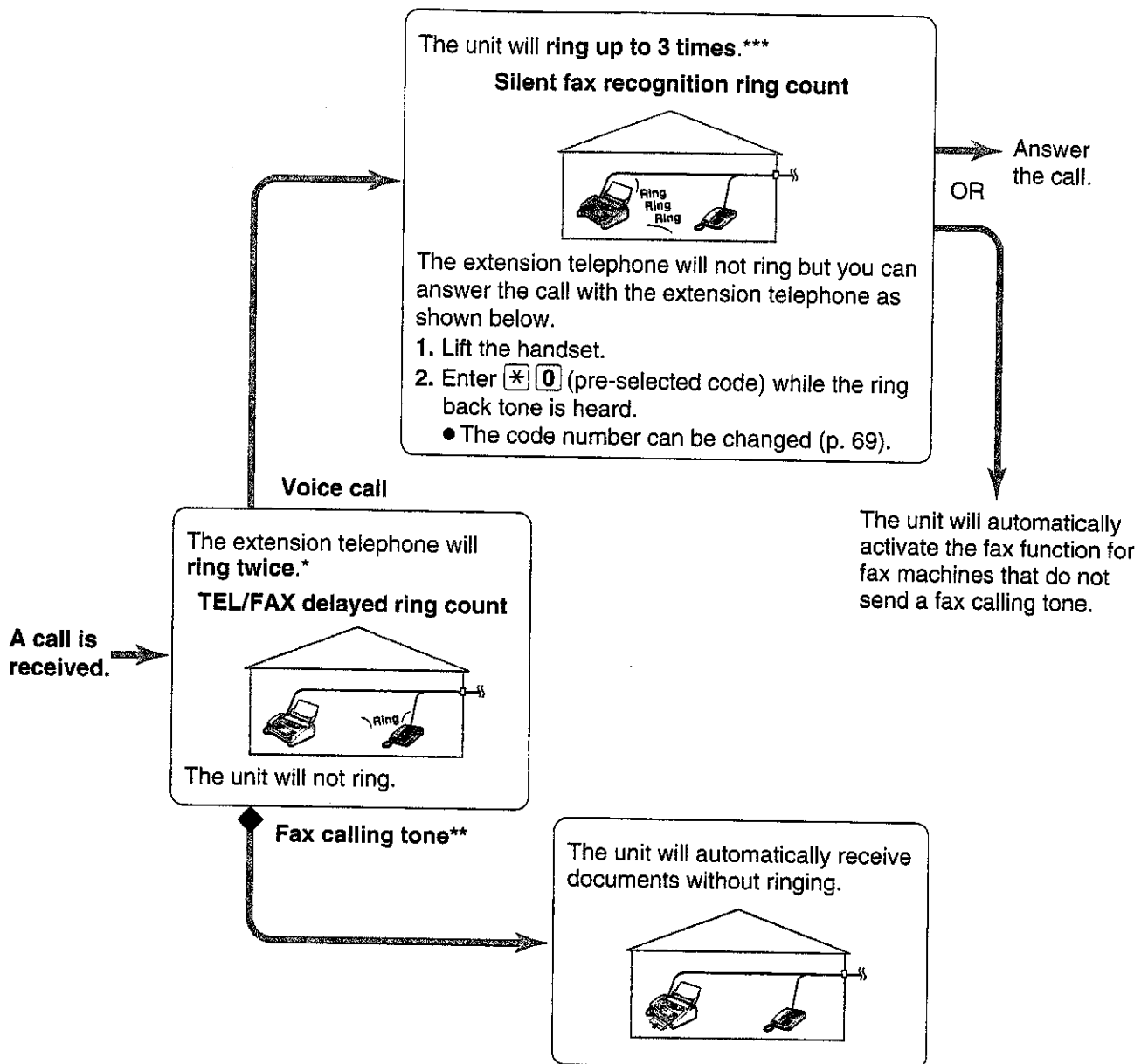

### TEL/FAX delayed ring count:

Up to 9 ring signals will be generated before the unit answers, depending on feature setting #78 on page 65. In the TEL/FAX mode, the unit will not generate an audible ring during this time.

### Silent fax recognition ring count:

The unit generates audible rings to indicate that it is receiving a voice call. 3 to 9 rings will be generated, depending on feature setting #30 on page 65. This signal will not ring at an extension telephone.

# Receiving Faxes

## Changing the AUTO ANSWER setting to the TEL/FAX mode

- 1 Press **MENU**.  
Display: 1.SYSTEM SET UP
- 2 Press **□**, then **7 7**.  
AUTO ANSWER
- 3 Press **START/SET/COPY**.  
MODE=FAX ONLY ▼▲
- 4 Press ▼ or ▲ to select "TEL/FAX".  
MODE=TEL/FAX ▼▲
- 5 Press **START/SET/COPY**.  
SETUP ITEM [ ]
- 6 Press **MENU**.
- 7 If the AUTO ANSWER light is off, turn it on by pressing **AUTO ANSWER**.  
TEL/FAX MODE

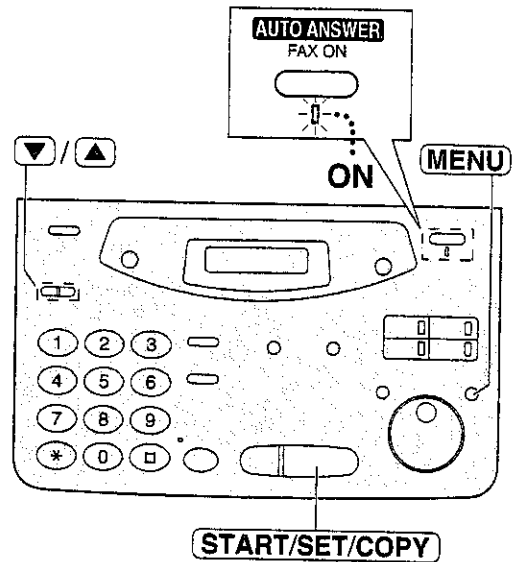

**Note:**

- To return to the FAX ONLY mode, select "FAX ONLY" in step 4.

## We recommend the following setup.

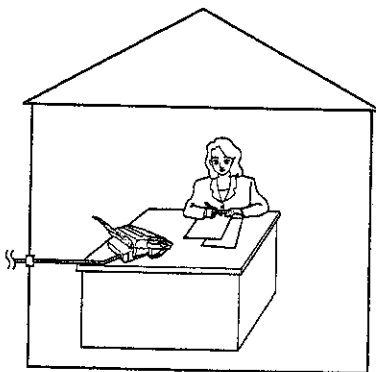

Only a fax machine is connected and you are always near the fax machine.



## TEL/FAX delayed ring count

This setting determines the number of times the extension telephone rings in the TEL/FAX mode. You can choose from 2 to 9 rings.

This setting does not need to be changed if an extension telephone is not connected.

- 1 Press **MENU**.  
Display: 1.SYSTEM SET UP
- 2 Press **□**, then **7 8**.  
TEL/FAX RING
- 3 Press **START/SET/COPY**.  
RING=2 ▼▲
- 4 Press ▼ or ▲ to select the desired number, or enter the number using the dial keypad.
- 5 Press **START/SET/COPY**.  
SETUP ITEM [ ]
- 6 Press **MENU**.

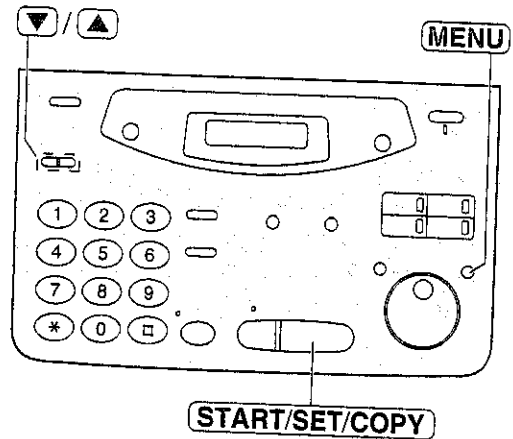

### Note:

- If the number of rings is increased, you may not be able to receive document from some older model fax machines which do not send a fax calling tone.

## Silent fax recognition ring count

When the unit detects a voice call in the TEL/FAX mode, it will ring up to 3 times. The number of rings can be changed up to 9.

- 1 Press **MENU**.  
Display: 1.SYSTEM SET UP
- 2 Press **□**, then **3 0**.  
SILENT FAX RING
- 3 Press **START/SET/COPY**.  
RING=3 ▼▲
- 4 Press ▼ or ▲ to select the desired number, or enter the number using the dial keypad.
- 5 Press **START/SET/COPY**.  
SETUP ITEM [ ]
- 6 Press **MENU**.

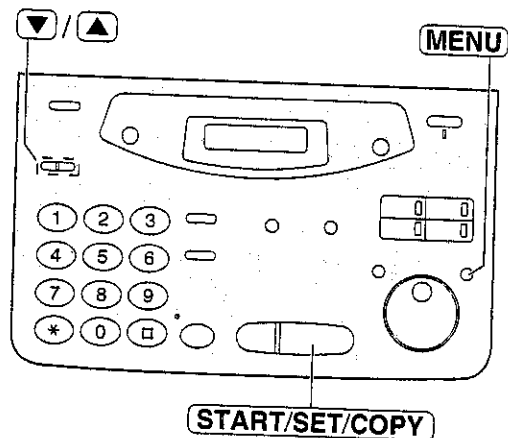

### Note:

- If the number of rings is increased, you may not be able to receive document from some older model fax machines which do not send a fax calling tone.

# Receiving Faxes

## Extension telephone

If you connect an extension telephone to the same line, you can receive fax documents using the extension telephone. You do not have to press **START/SET/COPY** on the unit.

**Important:**

- Use a touch tone telephone as the extension telephone and enter the fax activation code **firmly**.

- 1** When the extension telephone rings, lift the handset of the extension telephone.
- 2** When:
  - document reception is required,
  - a fax calling tone (slow beep) is heard, or
  - no sound is heard,press **\* 9** (pre-selected fax activation code) **firmly**.

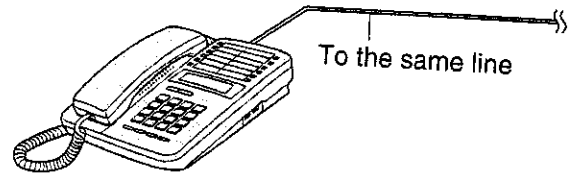

Extension telephone

**Note:**

- You can change the fax activation code (see below).

- 3** Hang up the handset.
  - The unit will start reception.

## Fax activation code

The fax activation code is used when receiving faxes using an extension telephone (see above). **Important:**

- This code should be different from auto disconnection code (p. 69).

- 1** Press **MENU**.

Display: 1.SYSTEM SET UP

- 2** Press **□**, then **4 1**.

FAX ACTIVATION

- 3** Press **START/SET/COPY**.

MODE=ON

- 4** Press **▼** or **▲** to select "ON".

- If this feature is not required, select "OFF".

- 5** Press **START/SET/COPY**.

CODE= \*9

- The display will show the pre-selected code.

- 6** Enter the new code.

- This code can be from 2 to 4 digits in length using 0 - 9, and \*.

- 7** Press **START/SET/COPY**.

SETUP ITEM [ ]

- 8** Press **MENU**.

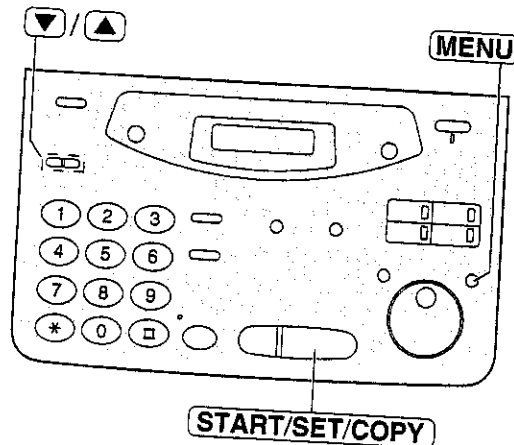

**Note:**

- If you subscribe to any special telephone company services which require a code, all or part of the fax activation code must be different from the service access code.
- The fax activation code should not be set to "0000".

## Other size documents

When the size of the document sent by the other party is as large as, or larger than the recording paper, the unit can reduce each page of the document and print it out on the recording paper by programming a suitable reduction rate.

The reduction rate is determined by a combination of the size of the recording paper and received document.

### Recommended reduction rates:

Mode	Size of recording paper	Size of original document
100%	A4	Letter
92% (pre-selected)	A4	A4
86%	A4	A4
72%	A4	Legal

A4 = 210 mm x 297 mm

Letter = 216 mm x 279 mm

Legal = 216 mm x 356 mm

**1** Press **MENU**.

Display: 1. SYSTEM SET UP

**2** Press **[ ]**, then **3 6**.

RCV REDUCTION

**3** Press **START/SET/COPY**.

MODE=92% ▼▲

**4** Press ▼ or ▲ to select the desired setting.  
 ● If this feature is not required, press ▲ to select "100%".

**5** Press **START/SET/COPY**.

SETUP ITEM [ ]

**6** Press **MENU**.

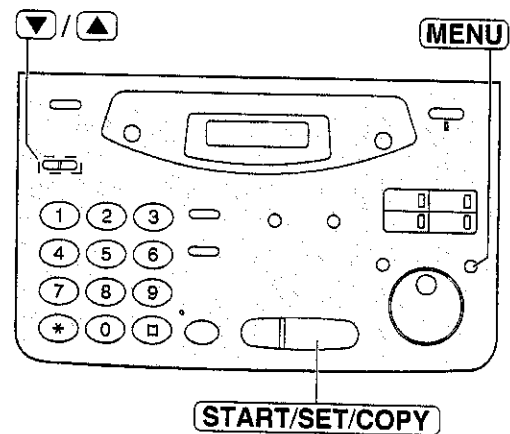

### Note:

- Document usually has a heading on the top of each page which contains the sender's name/telephone number. This increases the length of each page. Therefore using the reduction mode is recommended.
- If the appropriate reduction rate is not programmed, the document will be divided.
- If most of documents sent from the other party are as long as your recording paper and they have a long heading using a few lines, we recommend that selecting 86%.

# Receiving Faxes

## Memory reception alert

When received document is stored into memory due to a problem, the unit will alert you with beep tones. If you hear slow beeps, clear the printing problem or supply paper to print the stored document. The beep tones will stop.

- 1 Press **MENU**.  
Display: 1.SYSTEM SET UP
- 2 Press **#**, then **4** **4**.  
RECEIVE ALERT
- 3 Press **START/SET/COPY**.  
MODE=ON ▼▲
- 4 Press ▼ or ▲ to select the desired setting.  
• If this feature is not required, select "OFF".
- 5 Press **START/SET/COPY**.  
SETUP ITEM [ ]
- 6 Press **MENU**.

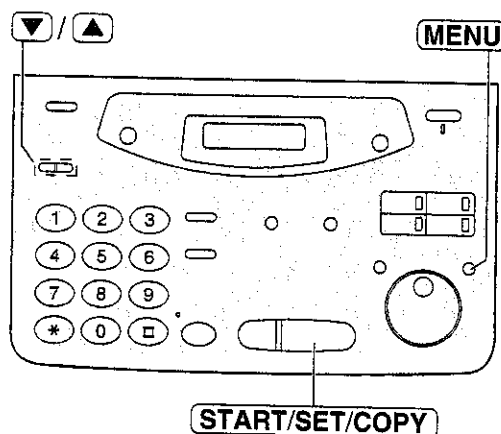

## Friendly reception

The friendly reception feature allows you to receive fax document automatically without pressing **START/SET/COPY** (p. 58).

When this feature is deactivated, you have to press **START/SET/COPY** to receive fax document each time you answer a fax call.

**1** Press **MENU**.

Display: 1.SYSTEM SET UP

**2** Press **□**, then **4 6**.

FRIENDLY RCV

**3** Press **START/SET/COPY**.

MODE=ON ▼▲

**4** Press ▼ or ▲ to select the desired setting.  
 • If this feature is not required, select "OFF".

**5** Press **START/SET/COPY**.

SETUP ITEM [ ]

**6** Press **MENU**.

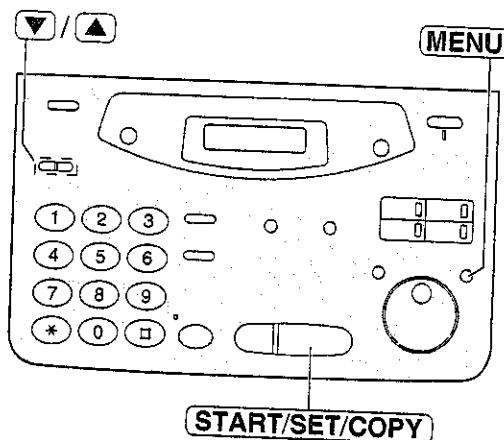

## Auto disconnection

This feature allows you to answer a call with the extension telephone during the silent fax recognition rings in the TEL/FAX mode (p. 63). When you lift the handset of the extension telephone and enter **\* 0** (pre-selected code) while the ring back tone is heard, the unit will be disconnected and you can talk with the other party.

**Important:**

• This code should be different from the fax activation code (p. 66).

**1** Press **MENU**.

Display: 1.SYSTEM SET UP

**2** Press **□**, then **4 9**.

AUTO DISCONNECT

**3** Press **START/SET/COPY**.

MODE=ON ▼▲

**4** Press ▼ or ▲ to select "ON".  
 • If this feature is not required, select "OFF".

**5** Press **START/SET/COPY**.

CODE=\* 0

• The display will show the pre-selected code.

**6** Enter the new code.

• This code can be from 2 to 4 digits in length using 0 - 9, and \*.

**7** Press **START/SET/COPY**.

SETUP ITEM [ ]

**8** Press **MENU**.

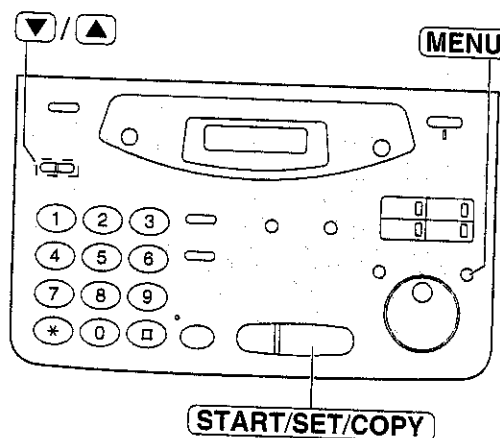

# Receiving Faxes

## Pager call - when your unit receives a fax

This feature allows your unit to call your pager when your unit receives a fax document.

- 1 Press **MENU**.  
Display: 1. SYSTEM SET UP
- 2 Press **□**, then **7 0**.  
FAX PAGER CALL
- 3 Press **START/SET/COPY**.  
MODE=OFF ▼▲
- 4 Press ▼ or ▲ to select "ON".  
MODE=ON ▼▲
- 5 Press **START/SET/COPY**.  
NO. =
- 6 Enter your pager number.  
• You can enter a total of 46 digits and/or pauses.
- 7 Press **START/SET/COPY**.  
• The unit will dial the stored number.
- 8 Check that your pager receives a pager test call.  
PAGER TEST
- 9 Press **MONITOR**.
- 10 If the AUTO ANSWER light is off, turn it on by pressing **AUTO ANSWER**.

• If this feature is not required, select "OFF".

- 5 Press **START/SET/COPY**.  
NO. =

- 6 Enter your pager number.  
• You can enter a total of 46 digits and/or pauses.

**Example:**

1 202 555 1234 PPP 12345678 PPP 5555#

Your pager number

Pauses

Your pager access code, if required.

Message you want displayed on your pager when your unit receives a fax.

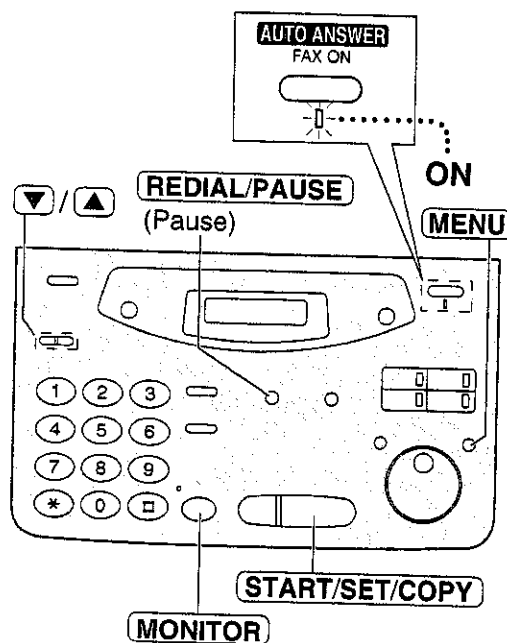

## How your unit and pager work

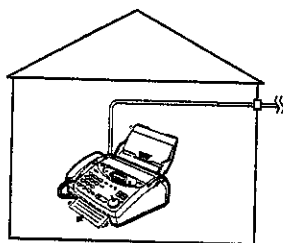

When your unit receives a fax document, it will call your pager company.

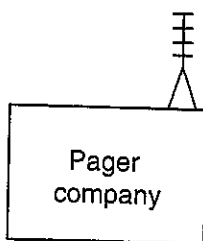

Your pager company will call your pager.

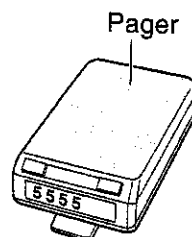

A few minutes later, your pager will display the same message you entered in step 6 above. (For example: 5555) If you subscribe to a Caller ID service and the Caller ID information (telephone number) is received, your pager will display the telephone number.

## Film detection

If this feature is activated, the display will show the following message when the remaining film will only print about 10 A4 size documents.

Display: **FILM NEAR EMPTY**

- If you are using regular film cartridge with 100 m roll (p. 12) when the above message is displayed, the unit will also print a report.

**1** Press **MENU**.

Display: **1.SYSTEM SET UP**

**2** Press **□**, then **7 9**.

**FILM DETECTION**

**3** Press **START/SET/COPY**.

**MODE=ON** ▼▲

**4** Press ▼ or ▲ to select the desired setting.

- If this feature is not required, select "OFF".

**5** Press **START/SET/COPY**.

**SETUP ITEM [ ]**

**6** Press **MENU**.

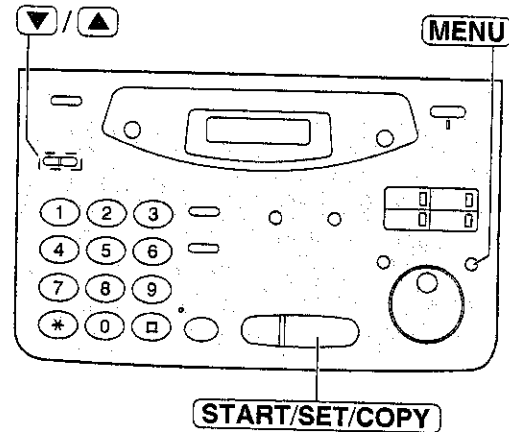

Fax/Copy

## Receive polling

### (retrieving a fax placed on another party's machine)

This feature allows you to retrieve a document from another compatible machine. Therefore, you pay for the call, saving the sending party the call charge.

Make sure that no documents are fed into your unit and that the other party's machine is ready for your call.

**1** Press **MENU** four times.

Display: **4.POLLING**

**2** Press **START/SET/COPY**.

**FAX=**

**3** Dial the fax number.

Example: **FAX=3331111**

**4** Press **START/SET/COPY**.

**CONNECTING.....**

- The unit will start reception.

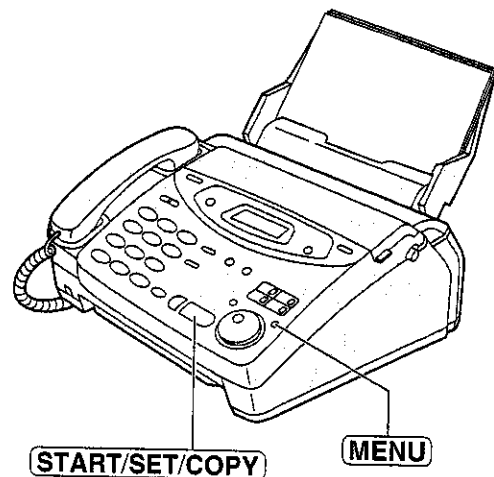

# Copying

## Making a copy

The unit can make single or multiple copies (up to 99). Any transmittable document (p. 45) can be copied.

- 1 Open the document feeder tray.
- 2 Adjust the width of the document guides to the size of the document.
- 3 Insert the document (up to 15 pages) **FACE DOWN** until a single beep is heard and the unit grabs the document.

Display: STANDARD

- Make sure the handset is on the cradle.

- 4 If necessary, press **RESOLUTION** repeatedly to select the desired setting (p. 42).
- 5 Press **START/SET/COPY**.  
NUMBER=1 [100%]
- 6 Enter the number of copies (up to 99).
- 7 If necessary, choose an enlargement/reduction rate by rotating **EASY DIAL**. See next page.

- 8 If you want to print collated copies, press **COLLATE** until the following is displayed (see below).

COLLATE=ON

- 9 Press **START/SET/COPY**.
  - The unit will start printing.OR  
Press **QUICK SCAN** if you want to remove the copy document for other uses.
  - The unit will feed the document and scan it into memory, then start printing.

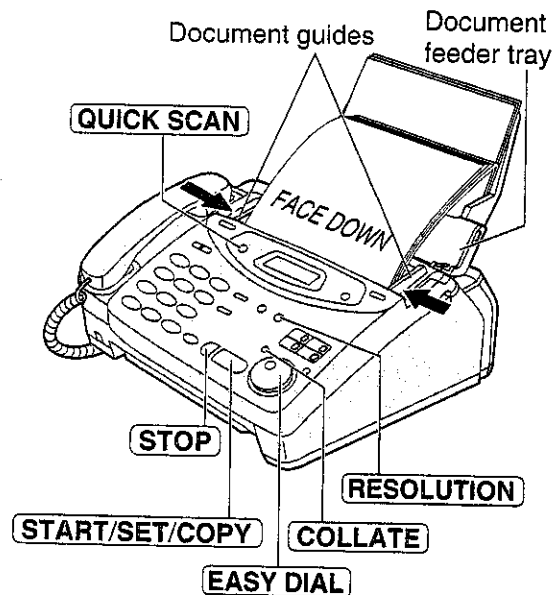

### Note:

- If a resolution is not selected, FINE resolution will be selected automatically.
- You can make or receive a voice call while making copies.
- After copying, the enlargement/reduction rate setting will return to "100%".

## To stop copying

Press **STOP**.

## Printing collated copies

The unit will print uncollated copies. You can also print collated copies. See the example below.

**Example:** Making two copies of a 4 page original document

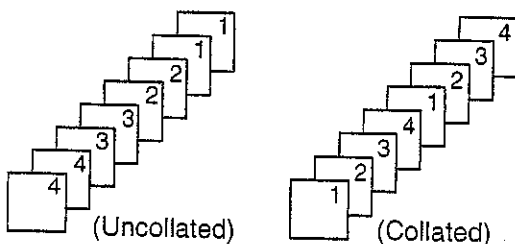

### Note:

- If you turn the collating feature on, the unit will store the document into memory and print it. If memory becomes full while storing, the unit will only print out the stored pages.
- After copying, the collating feature will turn off automatically.



## Choosing an enlargement/reduction rate

The unit can make enlarged or reduced copies of a document.

### ■ To enlarge a document:

Select "200%" or "150%" by rotating **EASY DIAL** to the right. The unit will only enlarge the center part of the document and print it on two pages. See the examples below.

#### Sample of an enlarged copy:

##### ● 200% example

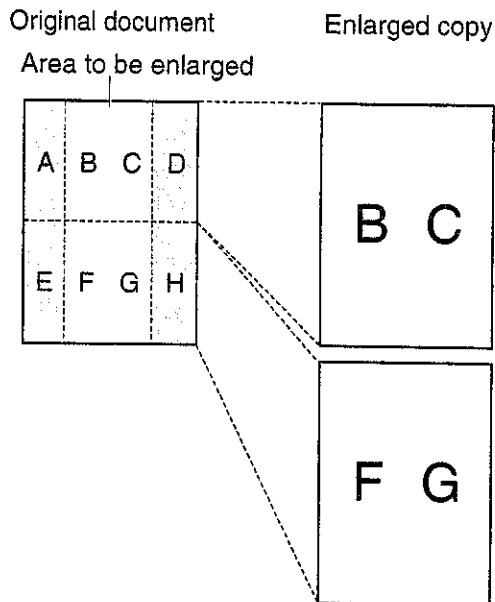

##### ● 150% example

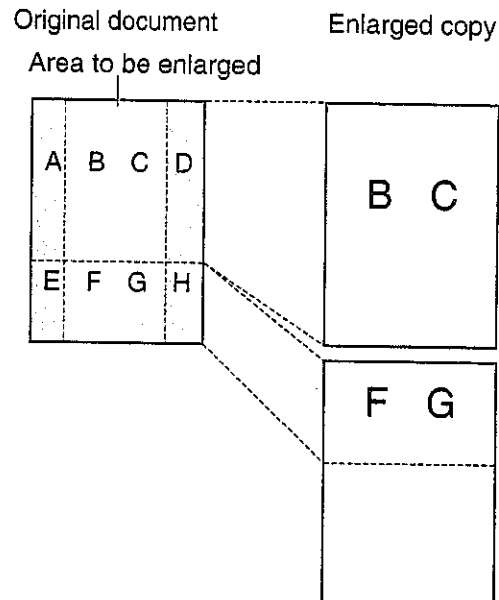

### ■ To reduce a document:

When you copy document that is longer than the recording paper, the unit can reduce the original document by programming a suitable reduction rate. The reduction rate is determined by the size of the recording paper and original document. Select from 92%, 86% and 72% by rotating **EASY DIAL** to the left.

#### Recommended reduction rates:

Mode	Size of recording paper	Size of original document
100% (pre-selected)	A4	A4, Letter
92%	A4	A4
86%	A4	A4
72%	A4	Legal

A4 = 210 mm x 297 mm

Letter = 216 mm x 279 mm

Legal = 216 mm x 356 mm

#### Note:

- If the appropriate reduction rate is not programmed, the document may be divided and the top of the second sheet will be deleted.
- If the image at the bottom of the document is not copied when you copy a document as long as the recording paper, try 92% or 86%.

# Error Messages

## Reports

If your unit cannot send a fax, check the following.

- The number you dialled is correct.
- The other party's machine is a facsimile.

If the problem remains, correct it by following the communication message printed on the sending and journal reports (p. 46, 47).

Communication message	Error code	Cause & Remedy
COMMUNICATION ERROR	41-72 FF	<ul style="list-style-type: none"><li>● A transmission or reception error occurred. Try again or check with the other party.</li></ul>
DOCUMENT JAMMED	—	<ul style="list-style-type: none"><li>● The document is jammed. Remove the jammed document (p. 82).</li></ul>
ERROR-NOT YOUR UNIT	54, 59 70	<ul style="list-style-type: none"><li>● A transmission or reception error occurred because of a problem with the other party's fax machine. Check with the other party.</li></ul>
MEMORY FULL	—	<ul style="list-style-type: none"><li>● The document was not received due to memory being full.</li></ul>
NO DOCUMENT	—	<ul style="list-style-type: none"><li>● The document was not fed into the unit properly. Reinsert the document and try again.</li></ul>
OTHER FAX NOT RESPOND	—	<ul style="list-style-type: none"><li>● The other party's fax machine was busy or ran out of recording paper. Try again.</li><li>● The document was not fed properly. Reinsert the document and try again.</li><li>● The other party's fax machine rings too many times. To send a fax manually, dial the number, confirm the fax tone, and press <b>START/SET/COPY</b>.</li><li>● The other party's machine is not a facsimile. Check with the other party.</li><li>● The number you dialled is not in service.</li></ul>
PRESSED THE STOP KEY	—	<ul style="list-style-type: none"><li>● <b>STOP</b> was pressed and fax communication was cancelled.</li></ul>
THE COVER WAS OPENED	—	<ul style="list-style-type: none"><li>● The cover was opened. Close it and try again.</li></ul>
OK	—	<ul style="list-style-type: none"><li>● Fax communication was successful.</li></ul>

## Display

If the unit detects a problem, one or more of the following messages will appear on the display.

Display message	Cause & Remedy
CALL SERVICE	<ul style="list-style-type: none"> <li>There is something wrong with the unit. Contact our service personnel.</li> </ul>
CHECK COVER	<ul style="list-style-type: none"> <li>The cover is open. Close it.</li> </ul>
CHECK DOCUMENT	<ul style="list-style-type: none"> <li>The document is not fed into the unit properly. Reinsert the document. If misfeeding occurs frequently, clean the document feeder rollers and try again (p. 87). If the problem remains, adjust the feeder pressure (p. 82).</li> </ul>
CHECK FILM	<ul style="list-style-type: none"> <li>The film or film cartridge is not inserted properly. Reinsert it correctly (p. 84–86).</li> </ul>
CHECK MEMORY	<ul style="list-style-type: none"> <li>Memory (telephone numbers, parameters, etc.) has been erased. Re-program.</li> </ul>
CHECK PAPER	<ul style="list-style-type: none"> <li>The recording paper is not installed or the unit has run out of paper. Install paper and press <b>START/SET/COPY</b> to clear the message.</li> <li>The recording paper is not fed into the unit properly or has jammed near the recording paper entrance. Clear the jammed paper and press <b>START/SET/COPY</b> to clear the message (see "When paper has jammed near the recording paper entrance" on page 81). Do not install folded or heavily curled paper in the paper tray.</li> </ul>
FAX IN MEMORY	<ul style="list-style-type: none"> <li>The unit has a document in memory. See the other displayed message instructions to print out the document.</li> </ul>
FAX MEMORY FULL	<ul style="list-style-type: none"> <li>Memory is full of received document due to a lack of recording paper or a recording paper jam etc. Install paper or clear the jammed paper.</li> <li>When performing memory transmission, the document being stored exceeds the memory capacity of the unit. Transmit the entire document using manual or automatic transmission.</li> </ul>
FILM EMPTY	<ul style="list-style-type: none"> <li>The film is empty. Replace the film or film cartridge (p. 84–86).</li> <li>The film is slack. Tighten it (see step 3 on page 84 and step 8 on page 86) and install again.</li> </ul>
FILM NEAR EMPTY	<ul style="list-style-type: none"> <li>The remaining film can print about 10 pages of A4 size document. Prepare a new film or film cartridge (p. 12).</li> </ul>
FREE FILM EMPTY	<ul style="list-style-type: none"> <li>The free starter film is empty. Replace the film or film cartridge (p. 84–86).</li> </ul>
EASY DIAL FULL	<ul style="list-style-type: none"> <li>There is no space to store new stations in the EASY DIAL directory. Edit or erase unnecessary stations (p. 33).</li> </ul>
MEMORY FULL	<ul style="list-style-type: none"> <li>When making copy, the document being stored exceeds the memory capacity of the unit. Press <b>STOP</b> to clear the message.</li> </ul>
MODEM ERROR	<ul style="list-style-type: none"> <li>There is something wrong with the modem circuit. Contact our service personnel.</li> </ul>

(continued)

# Error Messages/Operations

Display message	Cause & Remedy
NO FAX REPLY	<ul style="list-style-type: none"> <li>The other party's fax machine is busy or has run out of recording paper. Try again.</li> </ul>
PAPER JAMMED	<ul style="list-style-type: none"> <li>A recording paper jam occurred under the film cartridge. Clear the jammed paper (p. 80).</li> </ul>
PLEASE WAIT	<ul style="list-style-type: none"> <li>The unit is checking that there is no slack on the film. Wait a while.</li> </ul>
POLLING ERROR	<ul style="list-style-type: none"> <li>The other party's fax machine does not provide the polling function. Check with the other party.</li> </ul>
REDIAL TIME OUT	<ul style="list-style-type: none"> <li>The other party's fax machine is busy or has run out of recording paper. Try again.</li> </ul>
REMOVE DOCUMENT	<ul style="list-style-type: none"> <li>The document is jammed. Remove the jammed document (p. 82).</li> <li>Attempted to transmit a document longer than 600 mm. Press <b>(STOP)</b> to remove the document. Divide the document into two or more sheets and try again.</li> </ul>
TRANSMIT ERROR	<ul style="list-style-type: none"> <li>A transmission error occurred. Try again.</li> </ul>
UNIT OVERHEATED	<ul style="list-style-type: none"> <li>The unit is too hot. Let the unit cool down.</li> </ul>

## When a function does not work, check here before requesting help

### General

Problem	Cause & Remedy
I cannot make and receive calls.	<ul style="list-style-type: none"> <li>The power cord or telephone line cord is not connected. Check the connections (p. 22).</li> </ul>
The unit does not work.	<ul style="list-style-type: none"> <li>Disconnect the unit from the telephone line and connect the line to a known working telephone. If the working telephone operates properly, contact our service personnel to have the unit repaired. If the working telephone does not operate properly, contact your telephone company.</li> </ul>
The unit does not ring.	<ul style="list-style-type: none"> <li>The ringer volume is set to off. Adjust it to a suitable level (p. 27).</li> </ul>
The unit displays "CHECK PAPER" though the paper is inserted.	<ul style="list-style-type: none"> <li>The paper is inserted halfway. Insert it correctly (p. 20, 21) and press <b>(START/SET/COPY)</b> to clear the message.</li> </ul>

(continued)

## General (cont.)

Problem	Cause & Remedy
The other party complains they only hear a fax tone and cannot talk.	<ul style="list-style-type: none"> <li>• The FAX ONLY mode is set. Tell them the number is only used for faxes or change to another receive mode on your unit (p. 56, 57).</li> </ul>
The <b>REDIAL/PAUSE</b> button does not function properly.	<ul style="list-style-type: none"> <li>• If this button is pressed during dialling, a pause will be inserted. If pressed immediately after a dial tone is obtained, the last number dialled will be redialled.</li> </ul>
The receive mode does not function as explained on pages 56 and 57.	<ul style="list-style-type: none"> <li>• A distinctive ring pattern is set (p. 61).</li> <li>• The TEL/FAX mode is set (p. 62–65).</li> </ul>
During programming, I cannot enter a code or ID number.	<ul style="list-style-type: none"> <li>• All or part of the numbers are the same. Change the number (p. 66, 69).</li> </ul>
The film runs out quickly.	<ul style="list-style-type: none"> <li>• The HELP button, copy function, and reports use more film.</li> </ul>

## Fax – sending

Problem	Cause & Remedy
I cannot send document.	<ul style="list-style-type: none"> <li>• The other party's fax machine is busy or has run out of paper. Try again.</li> <li>• The other party's machine is not a facsimile. Check with the other party.</li> <li>• The other party's fax machine rings too many times. Send the fax manually – dial the number, confirm the fax tone, then press <b>START/SET/COPY</b>.</li> </ul>
The other party complains that letters on their received document are distorted.	<ul style="list-style-type: none"> <li>• If your line has special telephone services such as call waiting, the service may have been activated during fax transmission. Connect the unit to a line that does not have these services.</li> <li>• The extension telephone on the same line is off the hook. Hang up the extension telephone and try again.</li> </ul>
The other party complains that dirty patterns or black lines appear on their received document.	<ul style="list-style-type: none"> <li>• The glass or rollers are dirty. Clean them (p. 87).</li> </ul>
I cannot make an international fax call.	<ul style="list-style-type: none"> <li>• Use the overseas transmission mode (p. 53).</li> <li>• Add two pauses at the end of the telephone number (p. 29) or dial manually.</li> </ul>

# Operations

## Fax – receiving

Problem	Cause & Remedy
I cannot receive document automatically.	<ul style="list-style-type: none"> <li>• The receive mode is set to the TEL mode. Set to the FAX ONLY or TEL/FAX mode.</li> <li>• The time taken to answer a call is too long. Decrease the number of rings (p. 60, 65).</li> </ul>
The display shows "CONNECTING....." but faxes are not received.	<ul style="list-style-type: none"> <li>• The incoming call is not a fax. Change the receive mode to the TEL mode.</li> </ul>
The recording image is faint.	<ul style="list-style-type: none"> <li>• The sender transmitted a faint document. Ask them to transmit a clearer copy of the document.</li> <li>• The thermal head is dirty. Clean it (p. 87).</li> </ul>
The printing quality is poor.	<ul style="list-style-type: none"> <li>• Some paper has instructions recommending which side to print on. Try turning the paper over.</li> </ul>
A blank sheet is ejected after the received document is printed out.	<ul style="list-style-type: none"> <li>• The receiving reduction rate is not programmed correctly. Program the proper rate (p. 67).</li> </ul>
A black line appears on the received document.	<ul style="list-style-type: none"> <li>• The center rib is dirty. Clean it (p. 87).</li> </ul>

## Receive mode

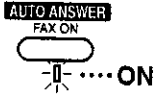
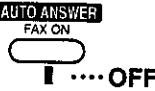
Problem	Cause & Remedy
I cannot select the desired receive mode.	<ul style="list-style-type: none"> <li>• If you want to set the FAX ONLY or TEL/FAX mode:               <ul style="list-style-type: none"> <li>– Select the desired mode using feature #77 (p. 64), and</li> <li>– Press <b>AUTO ANSWER</b> to turn on the AUTO ANSWER light.</li> </ul> </li> <li>• If you want to set the TEL mode:               <ul style="list-style-type: none"> <li>– Press <b>AUTO ANSWER</b> to turn off the AUTO ANSWER light.</li> </ul> </li> </ul> <div style="text-align: right; margin-top: 10px;">     </div>

## Copying

Problem	Cause & Remedy
The unit does not make a copy.	<ul style="list-style-type: none"> <li>• You cannot make a copy during programming. Make the copy after programming or stop the programming.</li> </ul>
A dirty pattern or a black line appears on the copied document.	<ul style="list-style-type: none"> <li>• The glass or rollers are dirty. Clean them (p. 87).</li> <li>• The center rib is dirty. Clean it (p. 87).</li> </ul>
The copied image is distorted.	<ul style="list-style-type: none"> <li>• The thermal head is dirty. Clean it (p. 87).</li> </ul>
The printing quality is poor.	<ul style="list-style-type: none"> <li>• Some paper has instructions recommending which side to print on. Try turning the paper over.</li> </ul>

(continued)

## Copying (cont.)

Problem	Cause & Remedy
<p>The printing is faint.</p> <div style="display: flex; justify-content: space-around; align-items: center;"> <div style="text-align: center;"> <p>Original</p> <div style="border: 1px solid black; padding: 5px; width: 60px;">ABC</div> </div> <div style="text-align: center;"> <p>Copy</p> <div style="border: 1px solid black; padding: 5px; width: 60px;">ABC</div> </div> </div>	<ul style="list-style-type: none"> <li>You may have used paper with a cotton and/or fiber content that is over 20%, such as letterhead or resume paper.</li> </ul>
The document is not copied properly.	<ul style="list-style-type: none"> <li>The film is not inserted correctly. Insert it correctly (p. 85, 86).</li> </ul>
The copied document is blank.	<ul style="list-style-type: none"> <li>The film is not inserted correctly. Insert it correctly (p. 85, 86).</li> </ul>
A paper jam occurs during copying.	<ul style="list-style-type: none"> <li>The film is not inserted correctly. Insert it correctly (p. 85, 86).</li> </ul>

## If a power failure occurs

- The unit will not function.
- Fax transmission and reception will be interrupted.
- If delayed transmission is programmed and the start time has passed during a power failure, transmission will be attempted soon after power is restored.
- If fax document is stored in memory, they will be lost. When power is restored, a power down report will be printed out stating which contents in memory have been erased.

## Power down report

The power down report will be automatically printed out after power is restored.  
The report will not be printed out if there are no documents stored in memory.

### Sample of a power down report

POWER DOWN REPORT				
			POWER DOWN AT:Jan. 05 1999 04:30AM	
			RESTARTED AT:Jan. 05 1999 04:31AM	
<< WARNING >> CONTENTS HAVE BEEN CLEARED DUE TO POWER DOWN. FOR ADDITIONAL INFORMATION, PLEASE SEE THE JOURNAL REPORT.				
NO.	OTHER FACSIMILE	MODE	PAGES	FUNCTION
01	<FAX # NOT AVAIL.>	RCV	01	MEMORY RECEIVE

# Jams

## Recording paper jams

If the unit does not eject any recording paper during reception or copying, the recording paper has jammed. Remove the jammed paper.

### When paper has jammed under the film cartridge

The display will show the following message.

Display: PAPER JAMMED

Remove the jammed paper as follows.

**1** Open the cover by pressing the cover open button.

**2** Remove the film cartridge.

**3** Remove the jammed recording paper.

**4** If the film is slack, tighten it by winding the gears.

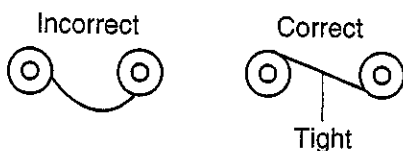

**5** Replace the film cartridge by first placing the front of the cartridge into the unit and then lowering the back of the cartridge, where there is an attached sticker, into place.

**6** Close the cover securely by pushing down on the dotted area at both ends.

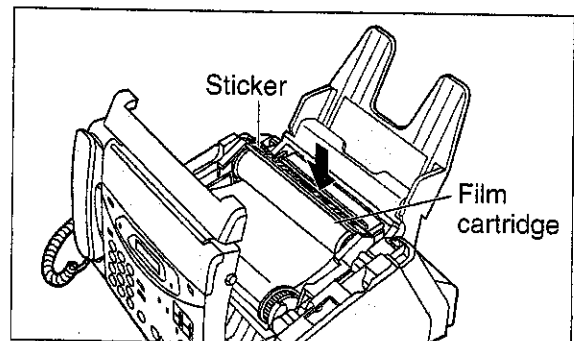
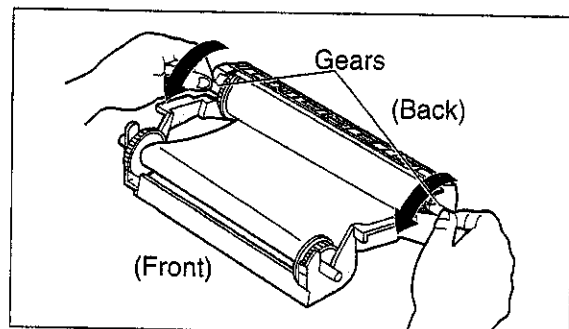
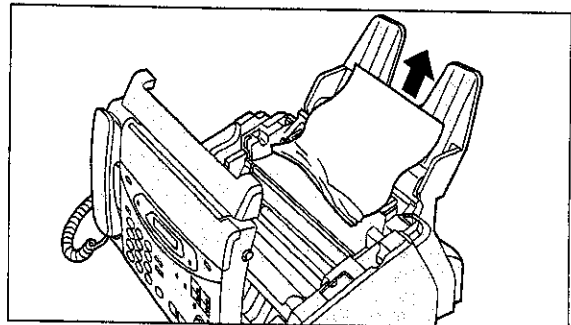
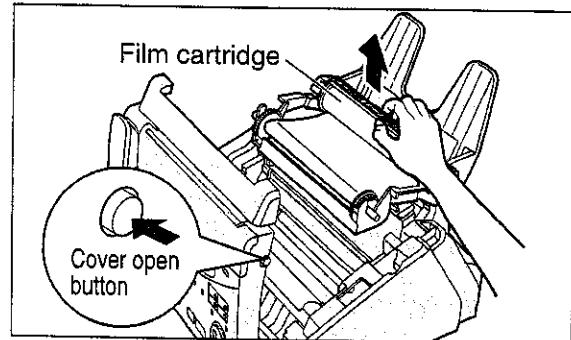



## When paper has jammed near the recording paper entrance

The display will show the following message.

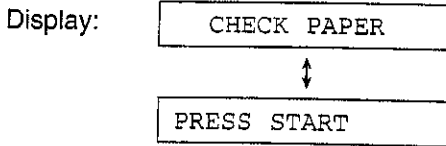

Remove the jammed paper as follows.

- 1** Pull the tension bar forward and hold open while pulling out the jammed recording paper from the recording paper entrance.
- 2** Press **START/SET/COPY** to clear the message.

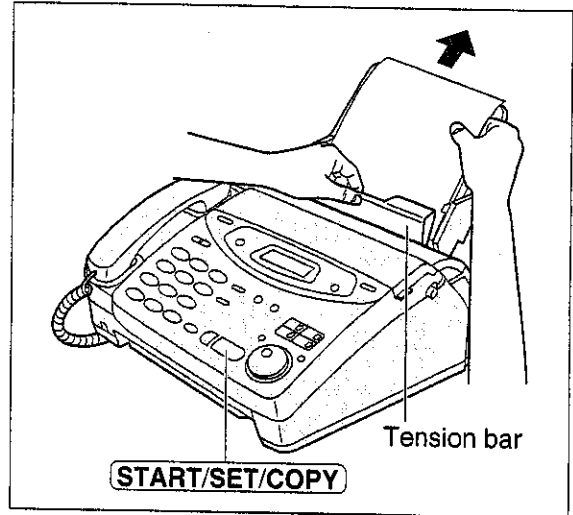

## When paper has not been ejected even though "PAPER JAMMED" or "CHECK PAPER" is not displayed

Confirm the recording paper exit. If there is any jammed paper, remove it as follows.

- 1** Tilt the unit up and pull the jammed recording paper out of the recording paper exit.

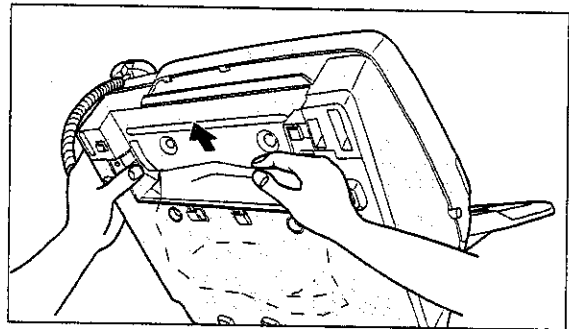

- 2** Remove the jammed recording paper from the recording paper exit.
  - If you cannot remove the jammed paper, remove it by following the instructions on page 80.

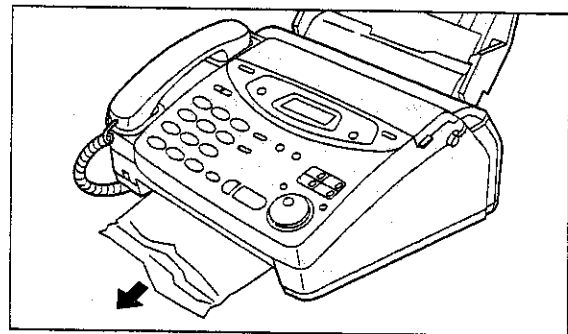

Help

# Jams

## Sending document jams

If the unit does not release the document during feeding, remove the jammed document.

- 1 Open the cover by pressing the cover open button.
- 2 Remove the jammed document carefully.
- 3 Close the cover securely by pushing down on the dotted area at both ends.

**Note:**

- Do not forcibly pull out the jammed paper before opening the cover.

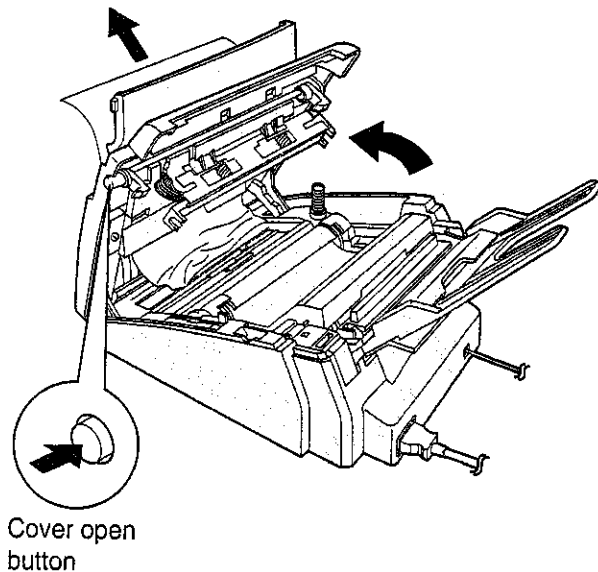
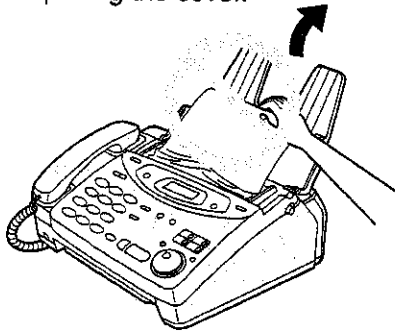

## Sending document does not feed, or multi-feeds

If no feeding or multiple feeding occurs frequently, adjust the feeder pressure.

- 1 Open the cover by pressing the cover open button.
- 2 Shift the position of the green lever by using an instrument with a pointed end, such as a paper clip.  
**Left:** When document multiple feeds.  
**Center:** Standard position (pre-selected)  
**Right:** When document does not feed.
- 3 Close the cover securely by pushing down on the dotted area at both ends.

**Note:**

- When shifting the green lever, do not touch the surrounding parts.

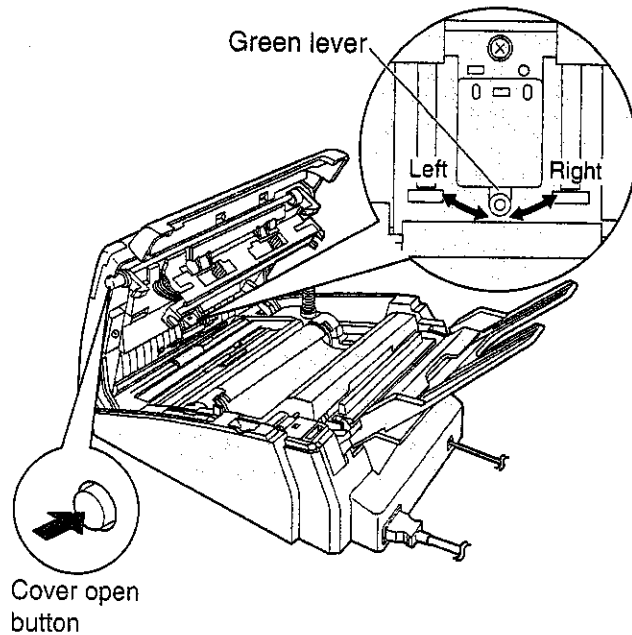

## How much film you have left

To check the amount of remaining film, proceed as follows. The display indicates the approximate amount of remaining film.

Display: FILM E \_ \_ \_ \_ █ █ █ █ F



FILM E \_ █ F

When the film indicator points to this position, the remaining film will print up to 20 pages of A4 size document. Prepare a new film or film cartridge for replacement.

**1** Press **MENU**.

Display: 1.SYSTEM SET UP

**2** Press **▣**, then **1 8**.

FILM REMAIN

**3** Press **START/SET/COPY**.

Example: FILM E \_ \_ \_ \_ █ █ █ █ F

**4** Press **STOP**.

SETUP ITEM [ ]

**5** Press **MENU**.

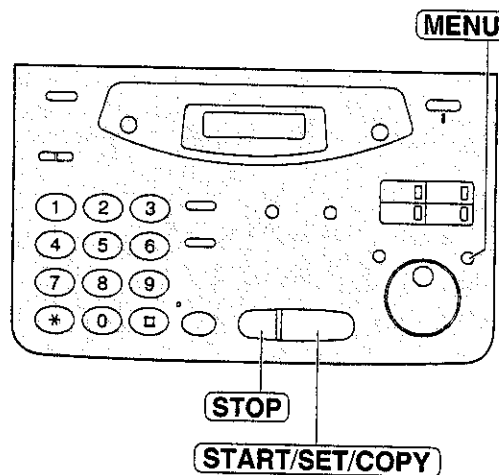

# Ink Film

## Replacing the film or film cartridge

When the unit detects the end of the film, the following message will be displayed.

Display:

FILM NEAR EMPTY

The remaining film prints about 10 pages of A4 size document. Prepare a new film or film cartridge.

FILM EMPTY

The film is empty. Install a new film or film cartridge.

The following is available for replacement:

**KX-FA137A:** Film cartridge

- Replacement film (KX-FA136A) can be installed in the cartridge after initial usage.

To order, see page 12.

### ■ Changing the film cartridge (KX-FA137A)

**1** Open the cover by pressing the cover open button.

**2** Remove the used film cartridge.

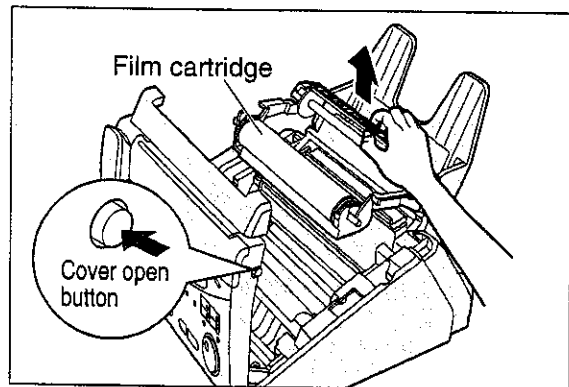

**3** Remove the film stopper from the new film cartridge by pressing it up. Turn the film cartridge over so that the attached sticker is facing up.

- If the film is slack, tighten it by winding the gears.

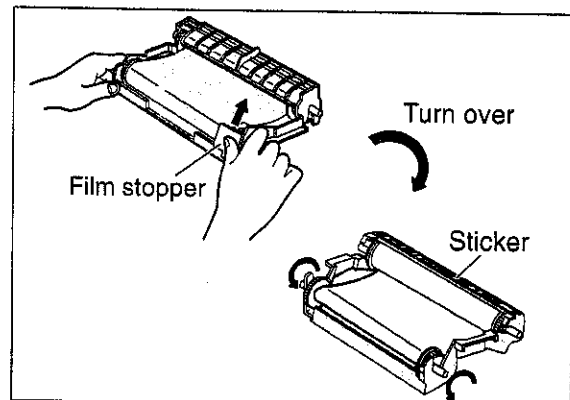
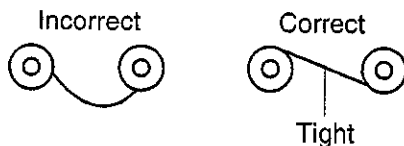

**4** Replace the film cartridge by first placing the front of the cartridge into the unit and then lowering the back of the cartridge, where there is an attached sticker, into place.

**5** Close the cover securely by pushing down on the dotted area at both ends.

- The unit will check that film is installed correctly. The following message will be displayed.

Display: PLEASE WAIT

- If the following message is displayed, the film cartridge is not inserted correctly.

CHECK FILM

Reinsert it correctly.

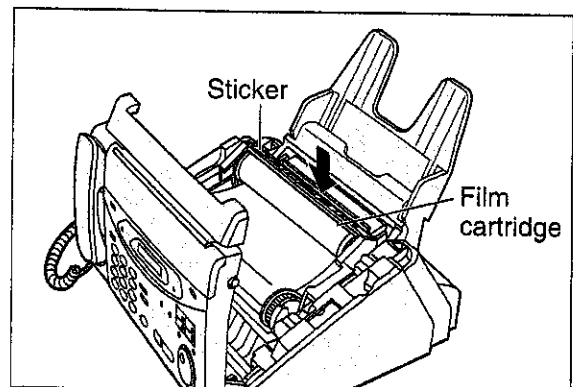

## ■ Changing the film (KX-FA136A)

**1** Open the cover by pressing the cover open button.

**2** Remove the film cartridge.

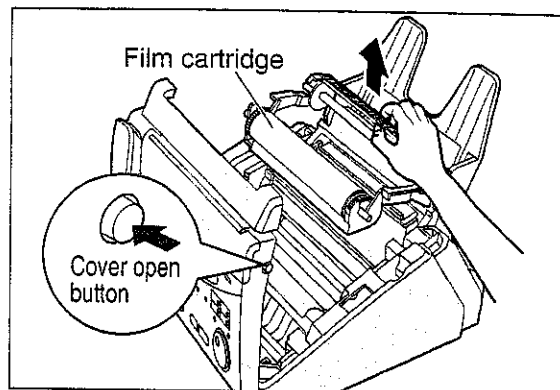

**3** Unlock the four gears by (A) pulling the top side gears (blue and green gears) forward and (B) lifting up the bottom side gears (green gears). Remove the used film.

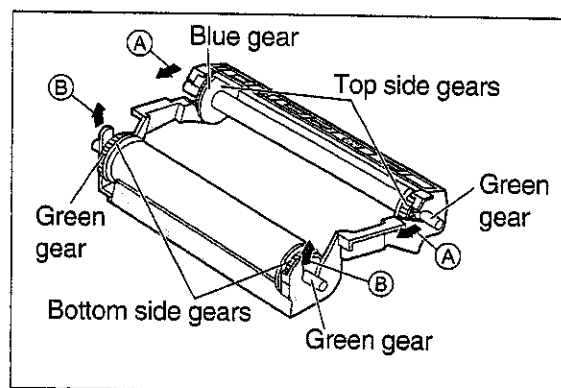

**4** Remove the four gears from the used film cores.

**Caution:**

- The film is not reusable. To order a new film, see page 12.

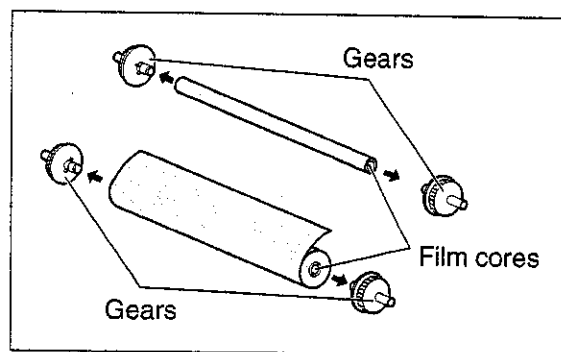

**5** Insert the blue gear into the blue core of the new film.

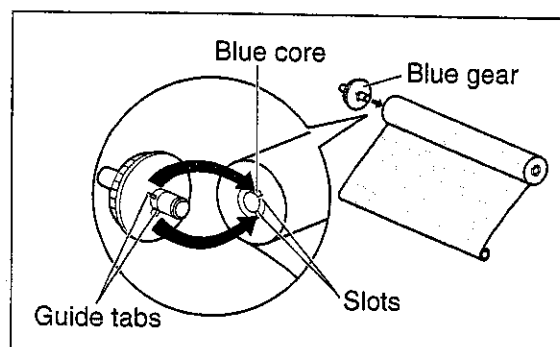

(continued)

# Ink Film

- 6** Insert the three green gears into the remaining cores of the new film.

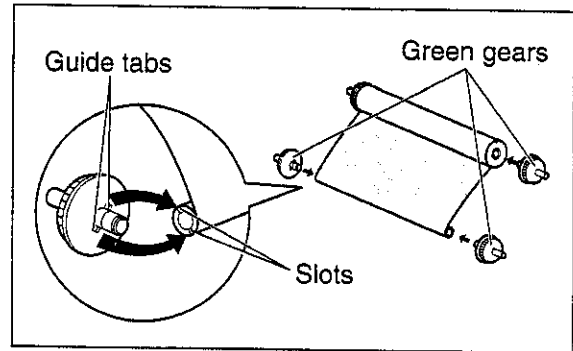

- 7** Insert the film into the cartridge so that the blue gear matches the "BLUE" on the cartridge.  
 • The shiny side should be facing up.

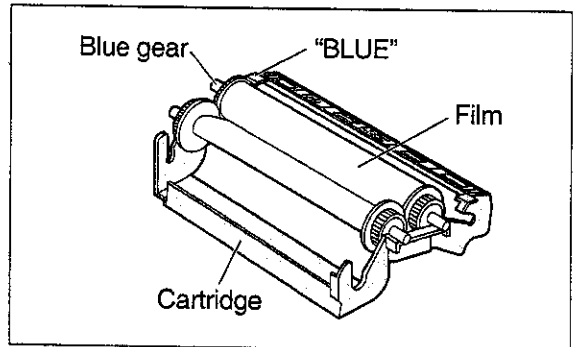

- 8** Lock the four gears of the film by (A) pushing back the top side gears and (B) pushing down the bottom side gears until they lock into place.

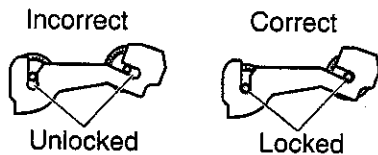

- If the film is slack, tighten it by winding the bottom side gears.

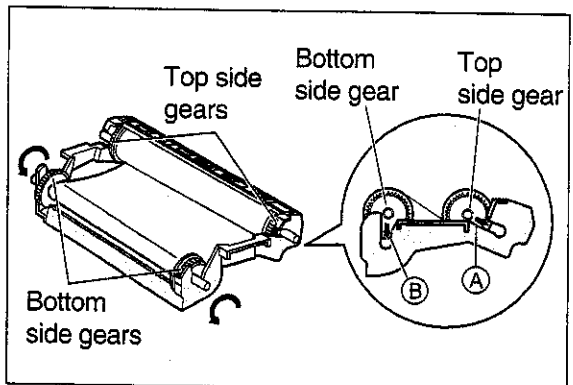
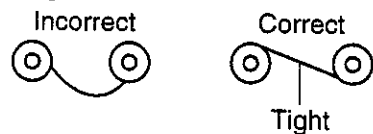

- 9** Replace the film cartridge by first placing the front of the cartridge into the unit and then lowering the back of the cartridge, where there is an attached sticker, into place.

- 10** Close the cover securely by pushing down on the dotted area at both ends.  
 • The unit will check that the film is installed correctly. The following message will be displayed.

Display: PLEASE WAIT

- If the following message is displayed, the film is not inserted correctly.

CHECK FILM

Reinsert it correctly.

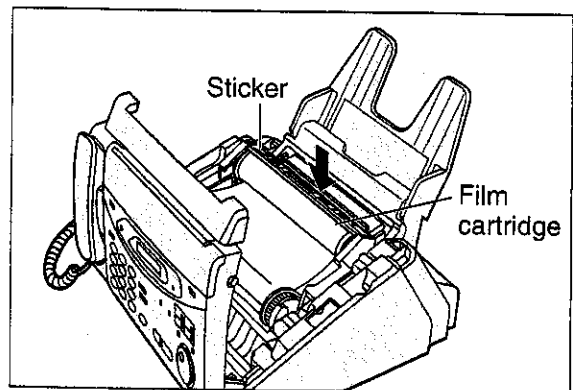

## Document feeder

If misfeeding occurs frequently or if dirty patterns or black bands appear on a copied or transmitted document, clean the document feeder.

- 1** Disconnect the power cord and the telephone line cord.
- 2** Open the cover by pressing the cover open button.
- 3** Clean the document feeder rollers, sub roller and rubber flap with a cloth moistened with isopropyl rubbing alcohol, and let all parts dry thoroughly.
- 4** Clean the white plate and glass with a soft dry cloth.
- 5** Close the cover securely by pushing down on the dotted area at both ends.
- 6** Connect the power cord and the telephone line cord.

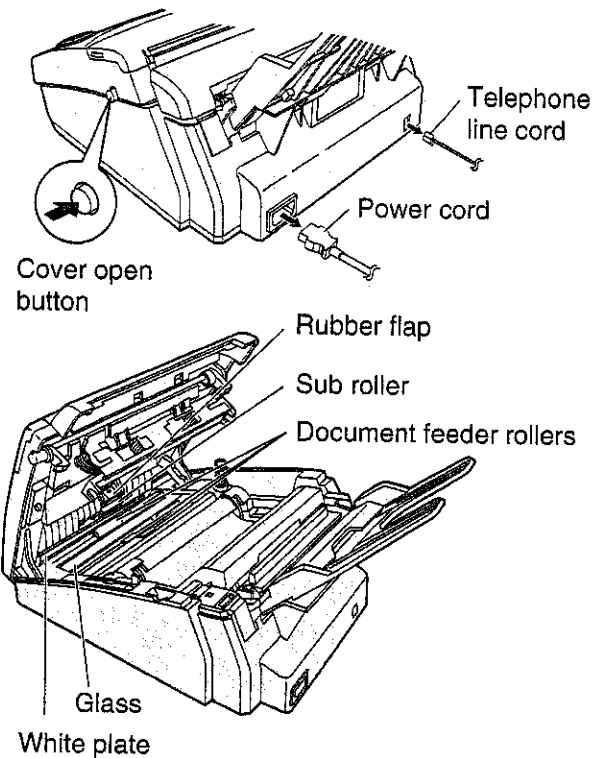

**Caution:**

- Do not use paper products, such as paper towels or tissues, to clean the inside of the unit.

■ **Cleaning the center rib on the film cartridge:**

If a black line appears in the center of a copied or received document, remove the film cartridge, turn it over and clean the center rib with a soft dry cloth. Replace the film cartridge in its original position.

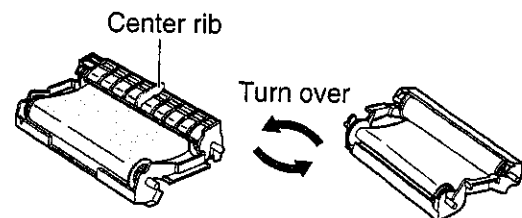

## Thermal head and black bar

If dirty patterns or black or white bands appear on a copied or received document, clean the thermal head and black bar.

- 1** Disconnect the power cord and the telephone line cord.
- 2** Open the cover by pressing the cover open button.
- 3** Clean the thermal head and black bar with a cloth moistened with isopropyl rubbing alcohol, and let it dry thoroughly.
- 4** Close the cover securely by pushing down on the dotted area at both ends.
- 5** Connect the power cord and the telephone line cord.

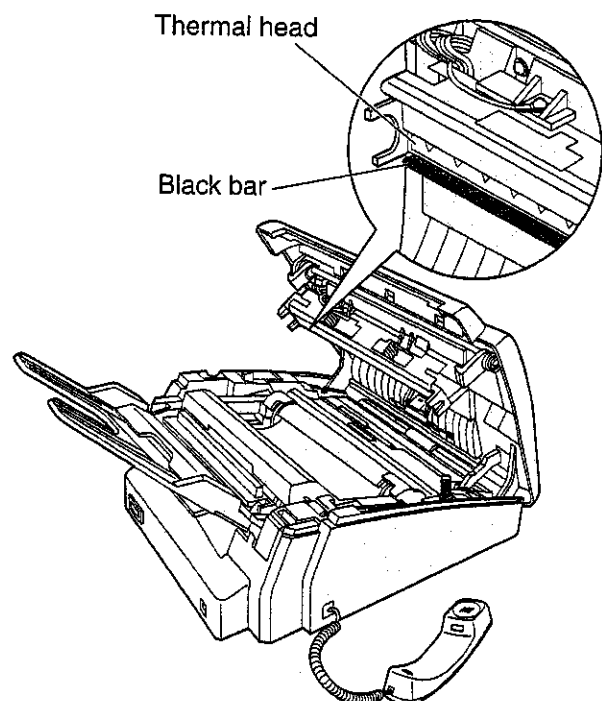

**Caution:**

- To prevent a malfunction due to static electricity, do not use a dry cloth and do not touch the thermal head directly with your fingers.

# Print Reports

## Printing the feature settings, telephone numbers, journal, printer test list, broadcast list and Caller ID list

You can print out the following report and lists.

**Feature list:** provides you with the current settings of the basic and advanced programming features (p. 94, 95).

**Telephone number list:** provides you with names and telephone numbers which are stored in the One-Touch Dial and EASY DIAL directory. The telephone number codes are as shown below.

P: A pause has been entered.

F: A recall has been entered.

[ ]: A secret telephone number has been entered. (The telephone number is not printed.)

**Journal report:** keeps records of fax transmissions and receptions. This report will be printed automatically after every 35 fax communications (p. 47).

**Printer test list:** allows you to check the print quality of your unit. If the test print has a dirty pattern, or blurred points or lines, clean the thermal head (p. 87).

**Broadcast list:** provides you with names and telephone numbers which are stored in the BROADCAST keys (p. 50–52).

**Caller ID list:** keeps records of the last 35 callers after subscribing to a Caller ID service. This report will be printed automatically after every 35 callers (p. 40).

**1** Press **MENU** two times.

Display: 2.PRINT REPORT

**2** For the **feature list**, press **[ ]**, then **1**.

SETUP LIST

For the **telephone number list**, press **[ ]**, then **3**.

TEL NO. LIST

For the **journal report**, press **[ ]**, then **4**.

JOURNAL REPORT

For the **printer test list**, press **[ ]**, then **5**.

PRINTER TEST

For the **broadcast list**, press **[ ]**, then **6**.

BROADCAST LIST

For the **Caller ID list**, press **[ ]**, then **8**.

CALLER ID LIST

**3** Press **START/SET/COPY** to start printing.

PRINTING

- To stop printing, press **STOP**.
- After printing, the following will be displayed.

PRINT ITEM [ ]

**4** Press **MENU**.

### Note:

- In step 2, you can select the desired item by rotating **EASY DIAL**.

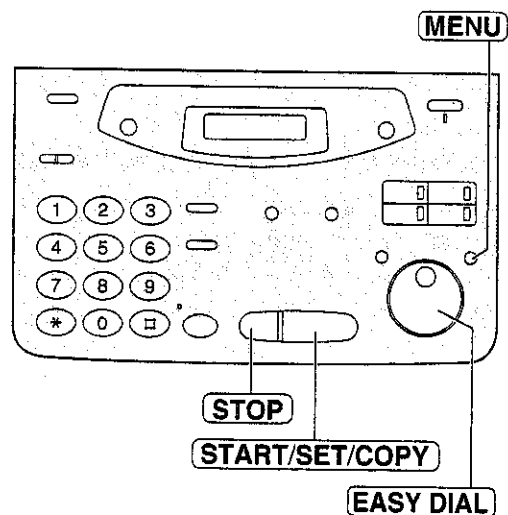



## Original mode

Use this feature when you need to transmit or copy a document with faint or dark writing.

The following choices are available:

**NORMAL:** Used for a document with normal writing (Pre-selected setting).

**LIGHT:** Used for a document with faint writing.

**DARKER:** Used for a document with dark writing.

Set this feature before starting transmission or copying.

- 1 Press **MENU**.  
Display: 1.SYSTEM SET UP
- 2 Press **■**, then **5** **8**.  
ORIGINAL
- 3 Press **START/SET/COPY**.  
MODE=NORMAL ▼▲
- 4 Press ▼ or ▲ to select the desired setting.
- 5 Press **START/SET/COPY**.  
SETUP ITEM [ ]
- 6 Press **MENU**.

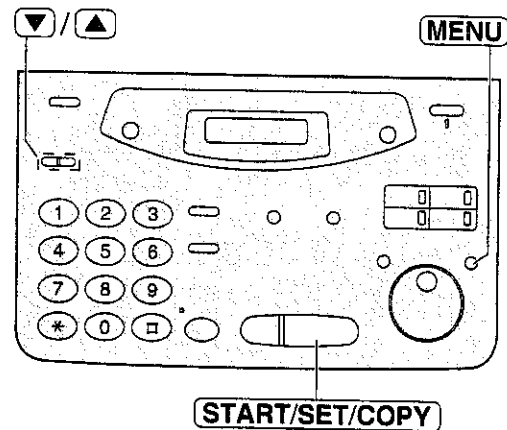

### Note:

- This feature will return to the normal mode after transmission or copying is completed.
- These settings are available in the standard, fine and super fine resolutions.

# Display Contrast / Reset

## Changing the display contrast

Use this feature to adjust the display contrast.

**NORMAL:** (Pre-selected setting)

**DARKER:** Used when the display contrast is too light.

- 1 Press **MENU**.  
Display: 1.SYSTEM SET UP
- 2 Press **⇨**, then **3 9**.  
LCD CONTRAST
- 3 Press **START/SET/COPY**.  
MODE=NORMAL ▼▲
- 4 Press ▼ or ▲ to select the desired setting.
- 5 Press **START/SET/COPY**.  
SETUP ITEM [ ]
- 6 Press **MENU**.

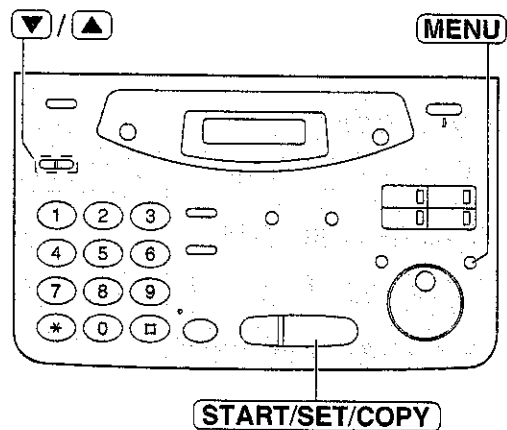

## Resetting the advanced features

Use this feature to return the advanced features (p. 94, 95), to their pre-selected settings, except the ECM communication.

- 1 Press **MENU**.  
Display: 1.SYSTEM SET UP
- 2 Press **⇨**, then **8 0**.  
SET DEFAULT
- 3 Press **START/SET/COPY**.  
RESET=NO ▼▲
- 4 Press ▼ or ▲ to select "YES".  
RESET=YES ▼▲
- 5 Press **START/SET/COPY**.  
RESET OK?

• If this feature is not required, press **STOP**.

- 6 Press **START/SET/COPY** again for confirmation.  
RESET COMPLETED  
↓  
SETUP ITEM [ ]

- 7 Press **MENU**.

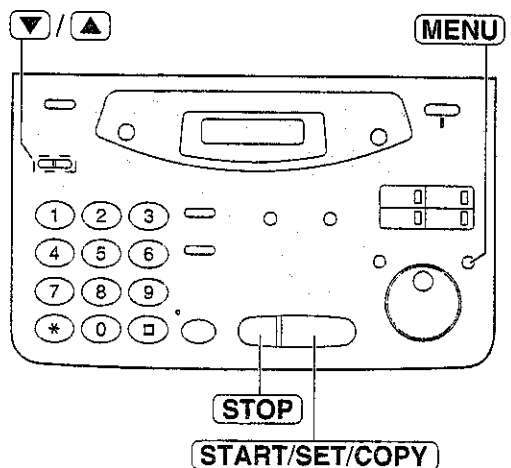

## Technical data about this product

<b>Applicable Lines:</b>	Public Switched Telephone Network
<b>Document Size:</b>	Max. 216 mm in width Max. 600 mm in length
<b>Effective Scanning Width:</b>	208 mm
<b>Recording Paper Size:</b>	A4: 210 mm x 297 mm
<b>Effective Printing Width:</b>	202 mm
<b>Transmission Time*:</b>	Approx. 12 s/page (Original mode)** Approx. 30 s/page (G3 Normal mode)
<b>Scanning Density:</b>	Horizontal: 8 pels/mm Vertical: 3.85 lines/mm —STANDARD mode 7.7 lines/mm —FINE/HALF TONE mode 15.4 lines/mm —SUPER FINE mode
<b>Halftone Level:</b>	64-level
<b>Scanner Type:</b>	Contact Image Sensor (CIS)
<b>Printer Type:</b>	Thermal Transfer Printing
<b>Data Compression System:</b>	Modified Huffman (MH), Modified READ (MR), Modified Modified READ (MMR)
<b>Modem Speed:</b>	9,600 / 7,200 / 4,800 / 2,400 bps; Automatic Fallback
<b>Operating Environment:</b>	5 °C – 35 °C, 20 % – 80 % RH (Relative Humidity)
<b>Dimensions (H x W x D):</b>	143 mm x 325 mm x 305 mm
<b>Mass (Weight):</b>	Approx. 4.0 kg
<b>Power Consumption:</b>	Standby: Approx. 6.5 W Transmission: Approx. 15 W Reception: Approx. 42 W (When receiving a 20% black document) Copy: Approx. 45 W (When copying a 20% black document) Maximum: Approx. 150 W (When copying a 100% black document)
<b>Power Supply:</b>	220 – 240 V AC, 50/60 Hz
<b>Memory Capacity:</b>	Approx. 28 pages of memory reception Approx. 25 pages of memory transmission (Based on the CCITT of No. 1 Test Chart in standard resolution, without using the Error Correction Mode.)

\* Transmission speed depends upon the contents of the pages, resolution, telephone line conditions and capability of the receiving unit.

\*\* The 12 second speed is based upon the CCITT No. 1 Test Chart and original mode.  
If the capability of the other party's machine is inferior to your unit, the transmission time may be longer.

**Note:**

- Any details given in these instructions are subject to change without notice.
- The pictures and illustrations in these instructions may vary slightly from the actual product.

CCITT No. 1 Test Chart

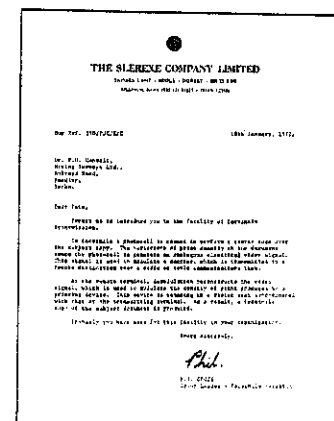

# Index

## Index

- A**
  - A4 paper guides .....18
  - Accessories .....12
  - Advanced features .....94, 95
    - (Resetting) .....90
  - AUTO ANSWER button .....56–59, 64
  - AUTO ANSWER mode .....56, 57, 59, 64
  - Auto disconnection .....69
- B**
  - Basic features .....94
  - BROADCAST keys .....50–52
  - Broadcast list .....88
  - Broadcast report .....52
- C**
  - Caller ID .....35–40
  - Caller ID list .....40, 88
  - CALLER ID SEARCH button .....36–38
  - Character table .....25
  - Cleaning .....87
  - COLLATE button .....72
  - Communication messages .....74
  - Connecting tone .....55
  - Connections .....5, 22
  - Copy
    - (Collated) .....72
    - (Enlargement/reduction) .....72, 73
    - (Multiple copies) .....72
  - COPY button .....9, 72
- D**
  - Date and time .....23
  - Delayed transmission .....48
  - Directory feature .....32, 34, 44
  - DIRECTORY
    - PROGRAM button ...30, 32, 33, 50, 51
  - Display
    - (Contrast) .....90
    - (Error messages) .....75, 76
  - Distinctive ring service .....61
  - Document feeder cleaning .....87
  - Document jam .....82
  - Document size .....45, 91
- E**
  - EASY DIAL
    - (Making a voice call) .....34
    - (Selecting characters) .....25
    - (Sending faxes) .....44
    - (Storing) .....32, 33
  - Enlarge/Reduce copy .....72, 73
  - Error correction mode .....54
  - Error messages .....74–76
  - Extension telephone .....63, 66
- F**
  - Facsimile telephone number .....26
  - FaxAbility .....61
  - Fax activation code .....66
  - Fax auto redial .....43
  - FAX ONLY mode .....56, 59, 60
  - FAX ONLY ring count .....60
  - Fax pager .....70
  - Feature list .....88
  - Feeder cleaning .....87
  - Feeder jam .....82
  - Feeder pressure .....82
  - Film .....83–86
  - Film cartridge .....84
  - Film detection .....71
  - Friendly reception .....58, 69
- H**
  - Handset cord .....5, 22
  - HANDSET MUTE button .....28
  - Handset receiver volume .....27
  - HELP button .....13
  - HYPHEN key .....25, 30
- I**
  - Ink film .....83–86
  - INSERT key .....24, 25
- J**
  - Jam .....80–82
  - Journal auto print .....47
  - Journal report .....47, 88
- L**
  - List
    - (Broadcast) .....52, 88
    - (Caller ID) .....40, 88
    - (Feature) .....88
    - (Journal) .....47, 88
    - (Printer test) .....88
    - (Sending) .....46
    - (Telephone number) .....88
  - Location panel .....14, 15
  - Logo .....24, 25
  - LOWER key .....30, 31, 38, 50
- M**
  - Memory reception alert .....58, 68
  - Memory transmission .....49
  - MONITOR button .....28, 41
  - Monitor volume .....27
- N**
  - NAME/TEL NO. key .....34

- O** One-Touch Dial
  - (Making a voice call) . . . . .31
  - (Sending faxes) . . . . .43
  - (Storing) . . . . .30
  - Original mode . . . . .89
  - Other size documents . . . . .67
  - Overseas transmission mode . . . . .53
  - Overview . . . . .16
  
- P** Pager call . . . . .70
  - Paper guides . . . . .18
  - Paper jam . . . . .80, 81
  - Paper stacker . . . . .19
  - Paper tray . . . . .18
  - PAUSE button . . . . .29
  - Polling . . . . .71
  - Power down report . . . . .79
  - Power failure . . . . .79
  - Power supply/cord . . . . .5, 22, 91
  - Printing paper size . . . . .91
  - Printing reports . . . . .88
  - Problem solving . . . . .76–79
  - Programmable features . . . . .94, 95
  
- Q** QUICK SCAN button . . . . .49, 72
  
- R** RECALL button . . . . .29
  - Receiving
    - (Fax) . . . . .8, 58
    - (Setting) . . . . .56, 57
  - Receiving reduction . . . . .67
  - Recording paper . . . . .20, 21, 91
  - Recording paper jam . . . . .80, 81
  - REDIAL button . . . . .28, 42
  - Report
    - (Broadcast) . . . . .52, 88
    - (Caller ID) . . . . .40, 88
    - (Feature) . . . . .88
    - (Journal) . . . . .47, 88
    - (Printer test) . . . . .88
    - (Sending) . . . . .46
    - (Telephone number) . . . . .88
  - Reset . . . . .90
  - RESOLUTION button . . . . .42
  - Ring count
    - (FAX ONLY) . . . . .60
    - (Silent fax recognition) . . . . .65
    - (TEL/FAX) . . . . .65
  - Ring pattern detection . . . . .61
  - Ringer volume . . . . .27
  
- S** SECRET key . . . . .30, 32
  - Sending
    - (Broadcast) . . . . .50–52
    - (EASY DIAL) . . . . .44
    - (From memory) . . . . .49
    - (Manually) . . . . .7, 42
    - (One-Touch Dial) . . . . .43
  - Sending document (Does not feed or multi-feeds) . . . . .82
  - Sending jam . . . . .82
  - Sending report . . . . .46
  - Set default . . . . .90
  - Silent fax recognition ring count . . . . .65
  - Specifications . . . . .91
  - Storing
    - (Broadcast) . . . . .50
    - (Caller ID list) . . . . .40
    - (EASY DIAL) . . . . .32, 33
    - (One-Touch Dial) . . . . .30
  
- T** TEL mode . . . . .56, 58
  - TEL/FAX delayed ring count . . . . .65
  - TEL/FAX mode . . . . .62–65
  - Telephone line cord . . . . .5, 22
  - Telephone number list . . . . .88
  - Thermal head cleaning . . . . .87
  - Transmission
    - (Broadcast) . . . . .50–52
    - (EASY DIAL) . . . . .44
    - (From memory) . . . . .49
    - (Manually) . . . . .7, 42
    - (One-Touch Dial) . . . . .43
  - Transmittable document . . . . .45, 91
  
- V** Voice call
  - (Answering) . . . . .6, 28
  - (EASY DIAL) . . . . .34
  - (Making) . . . . .6, 28
  - (One-Touch Dial) . . . . .31
  - Voice contact . . . . .41
  - VOLUME button . . . . .27

# Features Summary

## Summary of user programmable features

### Basic features

Code	Feature & Display	Available settings	Meaning	Page
#01	Setting the date and time <b>SET DATE &amp; TIME</b>	(2 digits for each entry)	mm/dd/yy hh:mm	23
#02	Setting your logo <b>YOUR LOGO</b>	(Up to 30 characters)		24
#03	Setting your facsimile telephone number <b>YOUR FAX NO.</b>	(Up to 20 digits)		26
#04	Printing the sending report <b>SENDING REPORT</b>	<b>ERROR</b> ON OFF	If transmission fails Activate Deactivate	46
#06	Setting the ring count in the FAX ONLY mode <b>FAX RING COUNT</b>	<b>2, 3, 4, 5, 6, 7, 8, 9</b>	2 to 9 rings	60
#18	Checking the amount of remaining film <b>FILM REMAIN</b>			83

(The pre-selected setting is in bold.)

#### Note:

- You can display basic features in the order above by rotating **EASY DIAL** instead of entering the code number (#01, #02, etc.).

### Advanced features

Code	Feature & Display	Available settings	Meaning	Page
#22	Setting the journal report to print automatically <b>AUTO JOURNAL</b>	<b>ON</b> OFF	Activate Deactivate	47
#23	Sending documents overseas <b>OVERSEAS MODE</b>	<b>ON</b> OFF	Activate Deactivate	53
#25	Sending a fax at a specified time <b>DELAYED SEND</b>	<b>ON</b> OFF	Activate Deactivate	48
#26	Setting the Caller ID list to print automatically <b>AUTO CALL. LIST</b>	<b>ON</b> OFF	Activate Deactivate	40
#30	Setting the silent fax recognition ring count <b>SILENT FAX RING</b>	<b>3, 4, 5, 6, 7, 8, 9</b>	3 to 9 rings	65

# Features Summary

Code	Feature & Display	Available settings	Meaning	Page
#31	Setting the Distinctive Ring pattern RING DETECTION	ON	Activate	61
		OFF	Deactivate	
#36	Receiving other sizes of documents RCV REDUCTION	100%	Deactivate reduction	67
		<b>92%</b>	92% reduction	
		86%	86% reduction	
		72%	72% reduction	
#39	Changing the display contrast LCD CONTRAST	<b>NORMAL</b>	Normal contrast	90
		DARKER	Darker contrast	
#41	Changing the fax activation code FAX ACTIVATION	<b>ON / CODE= * 9</b>	Activate	66
		OFF	Deactivate	
#44	Setting the memory reception alert RECEIVE ALERT	<b>ON</b>	Activate	68
		OFF	Deactivate	
#46	Setting the friendly reception FRIENDLY RCV	<b>ON</b>	Activate	69
		OFF	Deactivate	
#49	Setting the auto disconnection AUTO DISCONNECT	<b>ON / CODE= * 0</b>	Activate	69
		OFF	Deactivate	
#58	Setting the original mode ORIGINAL	<b>NORMAL</b>	Used for normal writing	89
		LIGHT	Used for faint writing	
		DARKER	Used for dark writing	
#68	Setting the ECM communication ECM SELECTION	<b>ON</b>	Activate	54
		OFF	Deactivate	
#70	Signaling your pager when your unit receives a fax FAX PAGER CALL	<b>ON</b>	Activate	70
		OFF	Deactivate	
#76	Setting the connecting tone CONNECTING TONE	<b>ON</b>	Activate	55
		OFF	Deactivate	
#77	Changing the AUTO ANSWER setting AUTO ANSWER	<b>FAX ONLY</b>	Facsimile only mode	64
		TEL/FAX	Telephone/Facsimile mode	
#78	Setting the TEL/FAX delayed ring count TEL/FAX RING	<b>2, 3, 4, 5, 6, 7, 8, 9</b>	2 to 9 rings	65
#79	Setting the film detection FILM DETECTION	<b>ON</b>	Activate	71
		OFF	Deactivate	
#80	Resetting the advanced features SET DEFAULT	<b>YES</b>	Reset	90
		NO	Will not reset.	

(The pre-selected setting is in bold.)

**For future reference**

Date of purchase \_\_\_\_\_

Serial number \_\_\_\_\_

(found on the rear of the unit)

Dealer's name and address \_\_\_\_\_

Dealer's telephone number \_\_\_\_\_

**Kyushu Matsushita Electric Co., Ltd.**

1-62, 4-chome, Minoshima, Hakata-ku, Fukuoka 812-8531, Japan

Printed in Malaysia

**PFQX1334ZB** WM0799WN1099



## Free Manuals Download Website

<http://myh66.com>

<http://usermanuals.us>

<http://www.somanuals.com>

<http://www.4manuals.cc>

<http://www.manual-lib.com>

<http://www.404manual.com>

<http://www.luxmanual.com>

<http://aubethermostatmanual.com>

Golf course search by state

<http://golfingnear.com>

Email search by domain

<http://emailbydomain.com>

Auto manuals search

<http://auto.somanuals.com>

TV manuals search

<http://tv.somanuals.com>