

Panasonic



This pictured model is KX-FP151.

Operating Instructions

Compact Plain Paper Fax

Model No. **KX-FP151E**

Compact Plain Paper Fax with
Telephone Answering System

Model No. **KX-FP155E**



Please read these Operating Instructions before using the unit and save for future reference.

These models are designed to be used in the United Kingdom and Ireland.

Thank you for purchasing a Panasonic facsimile.

Things you should keep a record of

Attach your sales receipt here

For your future reference

Date of purchase _____

Serial number _____

(found on the rear of the unit)

Dealer's name and address _____

Dealer's telephone number _____

Caution:

- Note that the images of copied or received documents will remain on the used ink film. Use discretion when disposing of the used ink film.
- Do not rub or use an eraser on the printed side of recording paper, as the print may smear.
- In the event of problems, you should contact your equipment supplier in the first instance.
- This equipment is designed for use on the the UK and Republic of Ireland analogue telephone network.

Declaration of Conformity:

We, Kyushu Matsushita Electric (U.K.) Ltd. / Panasonic Testing Centre (Europe) GmbH, declare that this equipment is in compliance with the essential requirements and other relevant provisions of Directive 1999/5/EC.

If you want to get a copy of the original Declaration of Conformity of our products which relates to the R&TTE, please contact to our web address:

<http://doc.panasonic-tc.de>

Note:

- The suffix in the model number will be omitted in these instructions.
- Most figures shown in these operating instructions are based on a KX-FP151.

Copyright:

This manual is copyrighted by Kyushu Matsushita Electric Co., Ltd. (KME) and its licensee. Under the copyright laws, this manual may not be reproduced in any form, in whole or part, without the prior written consent of KME and its licensee.

© Kyushu Matsushita Electric Co., Ltd. 2001

IMPORTANT

Panasonic

WARRANTY REGISTRATION

PLEASE FAX BACK TO REGISTER FOR YOUR 12 MONTHS WARRANTY

Thank you for purchasing your Panasonic facsimile. By filling in the section below, this will ensure the following:

- We will register your unit on our warranty database. Should you ever require a service call under warranty, your call will be dealt with quickly and efficiently.
- We will send you a reply fax to confirm your registration and the correct operation of your unit.
- If you have any problems, please call our customer helpline on 08701 580560 for UK. For Republic of Ireland, please refer to place of purchase.

Simply, follow these instructions:

1. Please fill in the section below in block capitals and in ink.

Your name

Company name (if applicable)

Your address

Your postcode

Telephone no. Fax no.

Model no.

Serial no. Date of purchase

Day Month Year

2. Fax this form to **08700 600001 and we will fax back to confirm receipt of your details. Please allow 14 working days for this. In addition, we will also send you information of our maintenance contracts.**

TERMS AND CONDITIONS

1. This machine is supplied with a one year return to base warranty. **Please retain your Proof of Purchase and Packaging in the unlikely event that your machine should require attention.** In addition to this return to base warranty, you can upgrade to a next day swop out service or an on site repair. For further information please contact us on **08701 580560** or visit our web site at **www.panasonic.co.uk**
2. This warranty is in addition to and does not in any way affect any statutory or other right of consumer purchases. This warranty relates only to product used within Mainland Great Britain, please refer to your dealer for warranty information relating to use elsewhere within the United Kingdom.
3. This product is designed for use only on the United Kingdom and Ireland's Public Switched Telephone Network and should be only for normal purposes and in accordance with standard operating instructions.
4. You should complete the registration form overleaf and fax it to us within 7 days of purchase; failure to do so may result in a delay in providing warranty service.
5. This warranty covers breakdowns due to design or manufacturing faults; it does not apply to damage, however caused, wear or tear, neglect, incorrect adjustment or repair, or to any items of limited life.
6. This warranty does not cover consumables, i.e. ink films, film refills, ink cartridges, toner cartridges, drum units, paper and paper loads or any optional accessories which may have been purchased either at the same time, as or subsequent to, the main unit. Such accessories should be returned to the point of purchase if found to be faulty.
7. In the event of a failure, please take the following action;
 - a. Refer to the "Help" section of your instruction manual in order to identify and possibly correct the problem;
 - b. If the problem is not resolved after referring to the user guide, please contact our customer helpline on 08701 580560 for UK.
For Republic of Ireland, please refer to your place of purchase.
8. In the event of our helpline being unable to resolve the problem, our operators will give you specific instructions on the return to base warranty procedure. You will be asked to return your facsimile machine to our workshop for repair. We will instruct you on how to package your machine carefully, as any damage caused by poor packaging will not be covered by the warranty.
9. Where the product is found to be faulty as a result of unauthorised repairs, modifications or damage, either by accident, misuse or improper installation, then Panasonic reserve the right to charge the customer the actual cost of repair, at a price related to the market rate for such work.
10. This warranty applies to the original purchaser only and is not transferable.
11. The warranty period applicable to this product shall be 12 months from date of purchase.

Fax to 08700 600001

Safety instructions

Important safety instructions

When using this unit, basic safety precautions should always be followed to reduce the risk of fire, electric shock, or personal injury.

1. Read and understand all instructions.
2. Follow all warnings and instructions marked on this unit.
3. Unplug this unit from power outlets before cleaning. Do not use liquid or aerosol cleaners. Use a damp cloth for cleaning.
4. Do not use this unit near water, for example near a bath tub, wash bowl, kitchen sink, or the like.
5. Place the unit securely on a stable surface. Serious damage and/or injury may result if the unit falls.
6. Do not cover slots and openings on the unit. They are provided for ventilation and protection against overheating. Never place the unit near radiators, or in a place where proper ventilation is not provided.
7. Use only the power source marked on the unit. If you are not sure of the type of power supplied to your home, consult your dealer or local power company.
8. For safety purposes this unit should be earthed. The 3 Pin 13A should be inserted into a suitable socket outlet.
9. Do not place objects on the mains lead. Install the unit where no one can step or trip on the cord.
10. Do not overload wall outlets and extension cords. This can result in the risk of fire or electric shock.
11. Never push any objects through slots in this unit. This may result in the risk of fire or electric shock. Never spill any liquid on the unit.
12. To reduce the risk of electric shock, do not disassemble this unit. Take the unit to an authorised service centre when service is required. Opening or removing covers may expose you to dangerous voltages or other risks. Incorrect reassembly can cause electric shock when the unit is subsequently used.
13. Unplug this unit from the wall outlet and refer servicing to an authorised service centre when the following conditions occur:
 - A. When the power supply cord or plug is damaged or frayed.
 - B. If liquid has been spilled into the unit.
 - C. If the unit has been exposed to rain or water.
 - D. If the unit does not work normally by following the operating instructions. Adjust only controls covered by the operating instructions. Improper adjustment may require extensive work by an authorised service centre.
 - E. If the unit has been dropped or physically damaged.
 - F. If the unit exhibits a distinct change in performance.
14. During thunderstorms, avoid using telephones except cordless types. There may be a remote risk of an electric shock from lightning.
15. Do not use this unit to report a gas leak, when in the vicinity of the leak.

SAVE THESE INSTRUCTIONS

INSTALLATION:

- Never install telephone wiring during a lightning storm.
- Never install telephone jacks in wet locations unless the jack is specifically designed for wet locations.
- Never touch uninsulated telephone wires or terminals unless the telephone line has been disconnected at the network interface.
- Use caution when installing or modifying telephone lines.

WARNING:

- To prevent the risk of fire or electrical shock, do not expose this product to rain or any type of moisture.

OTHER INFORMATION:

- Keep the unit away from electrical noise generating devices, such as fluorescent lamps and motors.
- The unit should be kept free from dust, high temperature and vibration.
- The unit should not be exposed to direct sunlight.
- Do not place heavy objects on top of this unit.
- Do not touch the plug with wet hands.

Table of Contents

Initial Preparation

Accessories	Included accessories	6
	Accessory information	7
Help Button	Help function	8
Finding the Controls	Overview	9
	Location	10
Setup	Ink film – installing / replacing	12
	Paper tray	14
	Recording paper	14
	Metal bar	15
	Connections	16
	Date and time, your logo and facsimile telephone number	17
Volume	Adjusting volume	21

Telephone

Recall Feature	RECALL button (to use the recall feature)	21
Navigator Directory	Storing names and telephone numbers into the directory	22
	Editing a stored entry	23
	Erasing a stored entry	23
	Making a phone call using the directory	24
Recording	Recording a telephone conversation (KX-FP155 only)	24
Caller ID	Caller ID service from your phone company	25
	Viewing and calling back using caller information	26
	Storing caller information into the directory	28
Voice Contact	Talking to the other party after fax transmission or reception	29

Fax

Sending Faxes	Sending a fax manually	30
	Documents you can send	31
	Sending a fax using the directory	32
	Broadcast transmission	33
Receiving Faxes	Setting the unit to receive faxes	36
	TEL mode (answering all calls manually)	38
	FAX ONLY mode (all calls are received as faxes)	39
	TEL/FAX mode (receiving phone calls with ring signals and faxes without ring signals when you are near the unit)	40
	Using the unit with an answering machine (KX-FP151 only)	42
	Extension telephone	44
	Receive polling (retrieving a fax placed on another fax machine)	44
	Pager call	45

Copy

Copying	Making a copy	46
----------------	-------------------------	----

Answering Device (KX-FP155 only)

Setup	TAD/FAX mode (receiving phone calls and faxes automatically) . . .	48
Greeting	Recording your own greeting messages	49
	Erasing your own recorded greeting messages	50
Memo Message	Leaving a message for others or yourself	51
Incoming Messages	Listening to recorded messages	52
Remote Operation	Operating from a remote location	53
Voice Mailbox	How callers can leave you private messages	56
	Recording your own mailbox greeting messages	57
	Listening to recorded messages	58
	Listening to recorded messages from a remote location	59
Option	Transferring recorded messages to another telephone	60

Programmable Features

Features	Programming	61
Summary	Basic features	62
	Advanced features	64

Help





Error Messages	Reports	71
	Display	72
Operations	When a function does not work, check here before requesting help	73
	If a power failure occurs	76
Jams	Recording paper jam	77
	Document jams – sending	78
Cleaning	Document feeder	79
	Thermal head	79

General Information

Printed Reports	Reference lists and reports	80
Specifications	Technical data about this product	81
Important Information	Important Information	83
	Fitting a plug to the mains lead	84
Guarantee	Condition of guarantee	85
Index	Program index	86
	Index	86

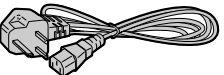
Accessories

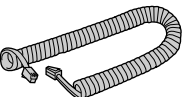
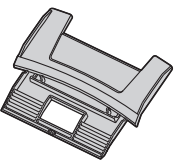
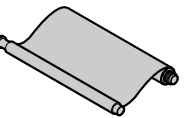
Included accessories

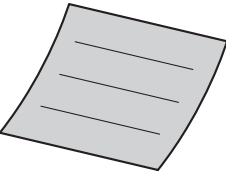
Mains lead.....1  Order No. PQJA10039Z	Telephone line cord...1  Order No. PQJA87S	Handset.....1  Order No. PFJXE1001Z	Handset cord.....1  Order No. PFJA1029Y
Paper tray1  Order No. PFKS1043Z2	Ink film.....1  The included film roll will print about 28 A4-sized pages.	Operating instructions1  Order No. PFQX1628Z	Quick Start Sheet1  Order No. PFQW1682Z

- If any items are missing or damaged, check with the place of purchase.
- The order numbers listed above are subject to change without notice.
- Save the original carton and packing materials for future shipping and transportation of the unit.

Accessories

Accessory information

Panasonic Accessories and Consumables DIRECT

- Order accessory and consumable items for all Facsimile Products with ease and confidence either by going on line through our Internet Accessory ordering application at www.panasonic.co.uk
- Or telephone our Customer Care Centre on **08701 580560 Mon - Friday 9:00am - 5:30pm**
- Most major credit and debit cards accepted.
- All enquires transactions and distribution facilities are provided directly by Panasonic UK Ltd.
- It couldn't be simpler!

We recommend that you buy a full-size replacement film for continuous use of your unit. For best results, use genuine Panasonic replacement film Model No. KX-FA55X.

Model No.	Item	Specifications / Usage
KX-FA55X	Replacement film	2 rolls – 216 mm x 50 m

- **The ink film is not reusable. Do not rewind and use the ink film again.**

Extension telephone adaptor for UK

● KX-FP151 only

When using the unit with an external answering machine (p. 42), please purchase an extension telephone adaptor by contacting one of the following:

- www.panasonic.co.uk
- Panasonic Customer Care Centre on Telephone number 08701 580560
- local Panasonic authorised dealer

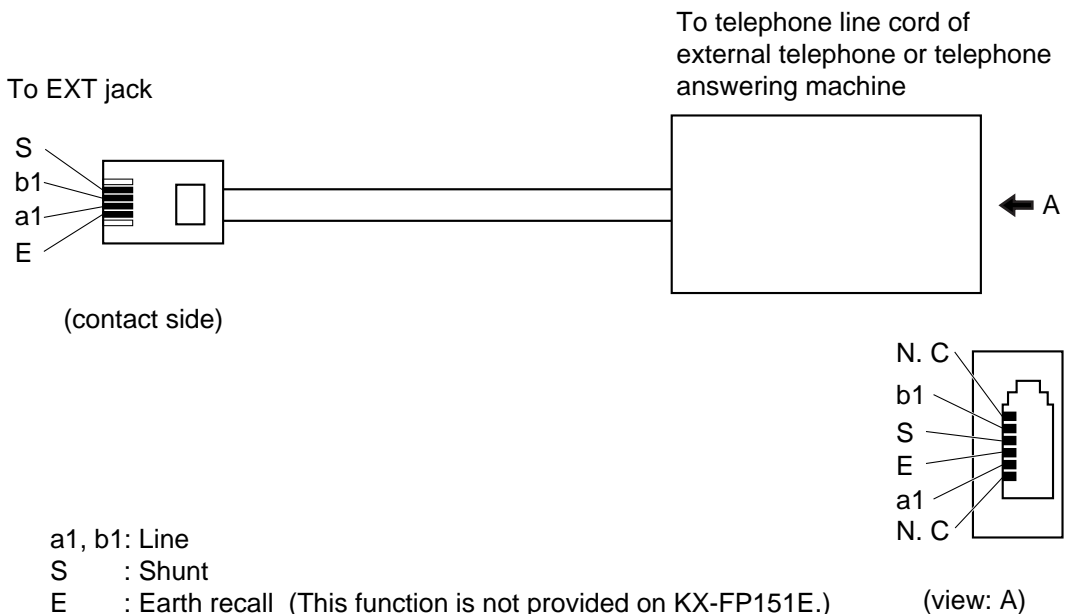

Help Button

Help function

You can print a quick reference for assistance as follows.

■ For KX-FP151

1 Press **HELP**.

Display: PRESS NAVI. [◀ ▶]
& SET

2 Press **◀** or **▶** until the desired item is displayed.

1. How to set the date, time, your logo and fax number.

QUICK SET UP
PRESS SET

2. How to program the features.

FEATURE LIST
PRESS SET

3. How to store names in the directory and how to dial them.

DIRECTORY
PRESS SET

4. Help with problems receiving faxes.

FAX RECEIVING
PRESS SET

5. How to use the copier function.

COPIER
PRESS SET

6. List of available reports.

REPORTS
PRESS SET

7. How to use the Caller ID service.

CALLER ID
PRESS SET

3 Press **SET**.

PRINTING

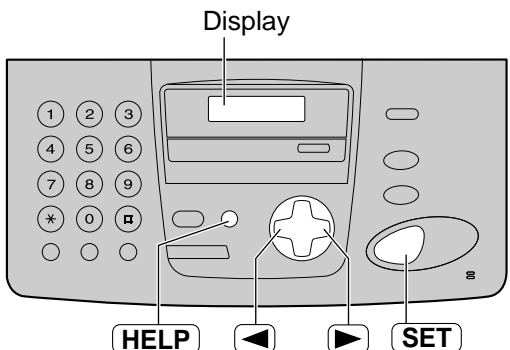

■ For KX-FP155

1 Press **HELP**.

Display: PRESS NAVI. [◀ ▶]
& SET

2 Press **◀** or **▶** until the desired item is displayed.

1. How to send faxes with the voice guide.

SEND GUIDE
PRESS SET

2. How to set the date, time, your logo and fax number.

QUICK SET UP
PRESS SET

3. How to program the features.

FEATURE LIST
PRESS SET

4. How to store names in the directory and how to dial them.

DIRECTORY
PRESS SET

5. Help with problems operating the answering device.

TAD OPERATION
PRESS SET

6. Help with problems receiving faxes.

FAX RECEIVING
PRESS SET

7. How to use the copier function.

COPIER
PRESS SET

8. List of available reports.

REPORTS
PRESS SET

9. How to use the Caller ID service.

CALLER ID
PRESS SET

3 Press **SET**.

PRINTING

Finding the Controls

Overview

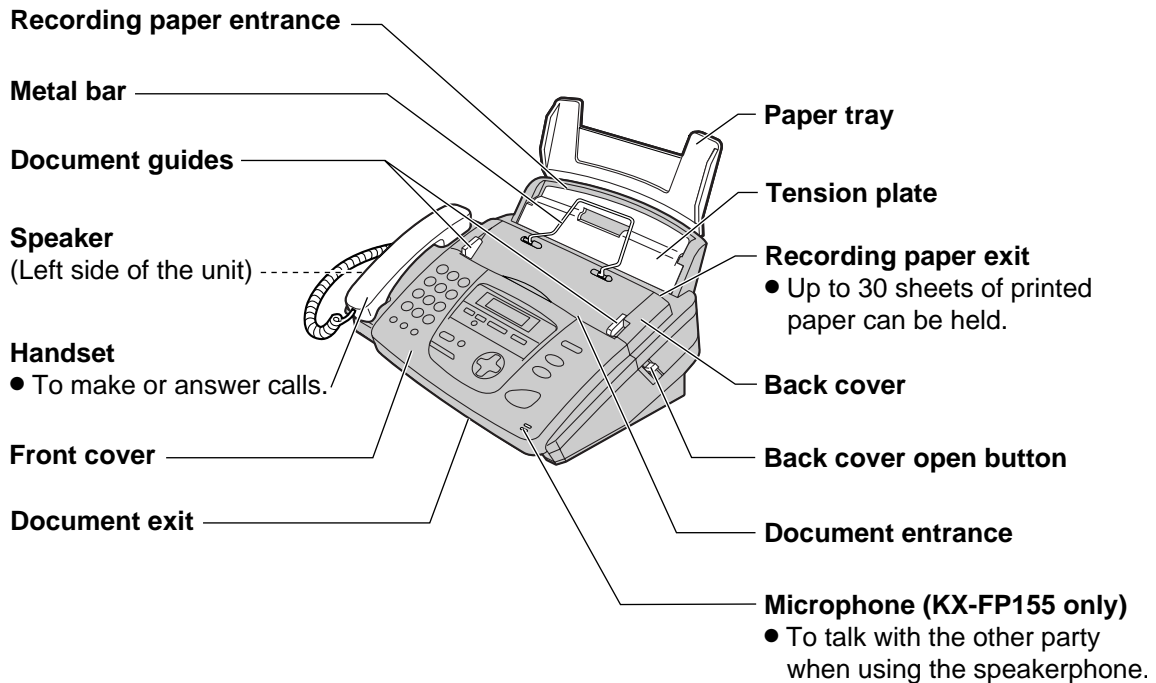

* The pictured model is KX-FP155.

Note:

- The document will be ejected from the front of the unit. Install the unit on a desk or floor with a smooth surface and do not place anything in front of the unit.

Speakerphone operation (KX-FP155 only)

- Use the speakerphone in a quiet room.
- Adjust the speakerphone volume using **+** or **-**.
- To switch to the handset, lift the handset. To switch back to the speakerphone, press **DIGITAL SP-PHONE**.

Finding the Controls

Location

■ For KX-FP151

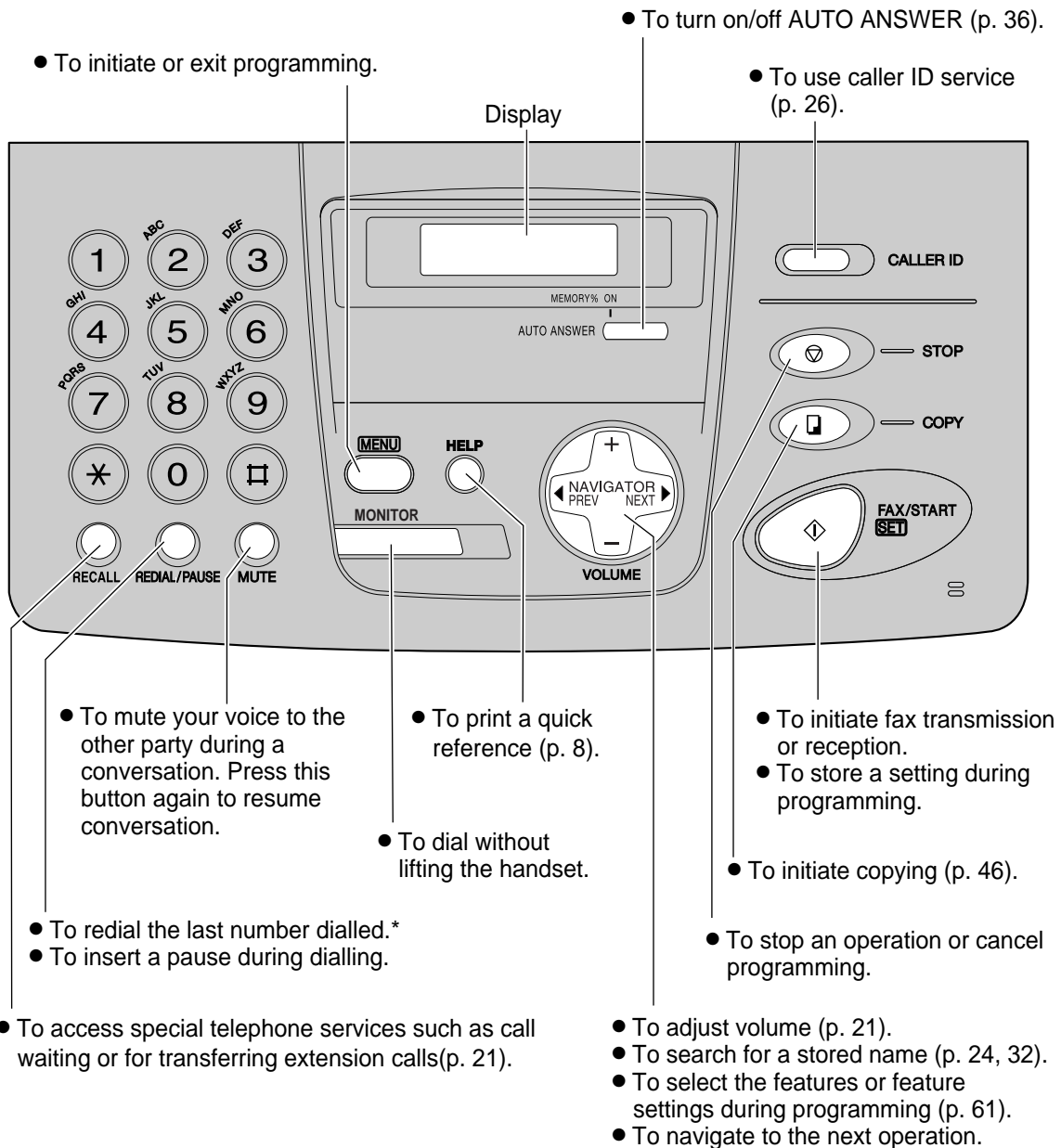

*If the line is busy when you make a phone call using the **MONITOR** button, the unit will automatically redial the number up to 5 times.

Finding the Controls

■ For KX-FP155

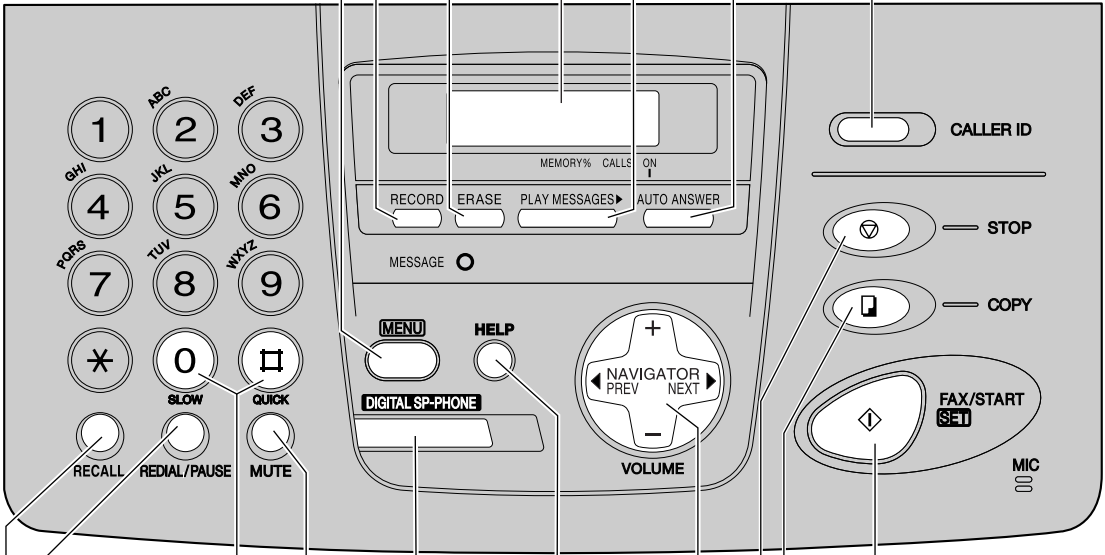
- To erase recorded messages (p. 52).
 - To record your own greeting messages (p. 49).
 - To initiate or exit programming.
 - To play recorded messages (p. 52).
 - To turn on/off AUTO ANSWER (p. 36).
 - To use caller ID service (p. 26).
- 
- The diagram shows the control panel of the KX-FP155. It features a numeric keypad (1-9, *, 0, #) with letters for speed dialing. A central display shows 'MEMORY% CALLS ON'. Below the display are buttons for RECORD, ERASE, PLAY MESSAGES, and AUTO ANSWER. A MESSAGE indicator light is present. To the right of the keypad are buttons for MENU, HELP, and DIGITAL SP-PHONE. A large circular NAVIGATOR button with directional arrows and a central '+' sign is used for volume and menu navigation. On the far right, there are buttons for CALLER ID, STOP, COPY, FAX/START, and a MIC icon.
- For slow or quick playback (p. 52).
 - To mute your voice to the other party during a conversation. Press this button again to resume conversation.
 - To redial the last number dialled.*
 - To insert a pause during dialling.
 - To access special telephone services such as call waiting or for transferring extension calls (p. 21).
 - To print a quick reference (p. 8).
 - For speakerphone operation (p. 9).
 - To initiate fax transmission or reception.
 - To store a setting during programming.
 - To initiate copying (p. 46).
 - To stop an operation or cancel programming.
 - To adjust volumes (p. 21).
 - To search for a stored name (p. 24, 32).
 - To select the features or feature settings during programming (p. 61).
 - To navigate to the next operation.

*If the line is busy when you make a phone call using the **DIGITAL SP-PHONE** button, the unit will automatically redial the number up to 5 times.

Setup

Ink film – installing / replacing

Install the included ink film or replace the used ink film with new one.

Model No. KX-FA55X: Replacement film (2 rolls)

Each roll prints about 140 A4-sized pages. See page 7 for accessory information.

- 1 Open the front cover by pulling up the centre part.

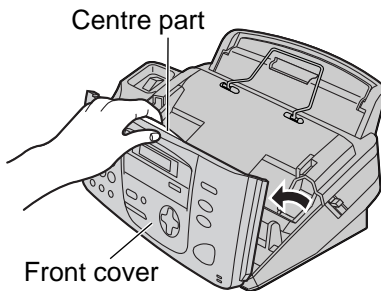

- 2 Push the back cover open button (green) on the right side of the unit.
OR
Push the back cover open lever (green) inside of the unit.

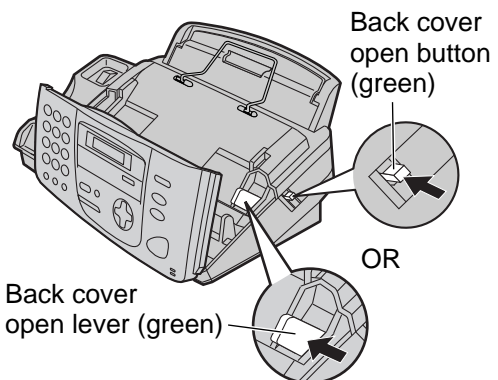

- 3 Open the back cover.
 - For first time installation of the supplied ink film, skip to step 6.

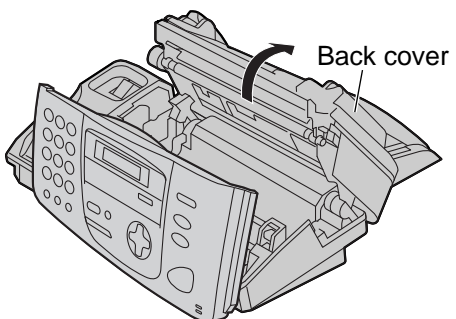

- 4 **For replacement only**
Pull out the blue gear and remove the used ink film. Remove the used core.

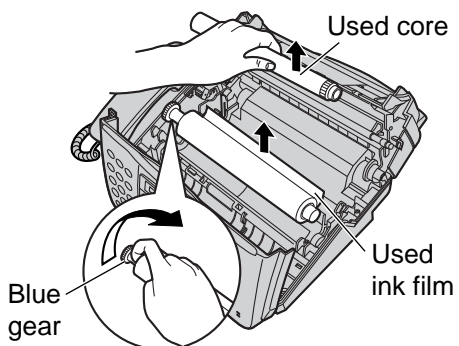

(continued)

Setup

- 5 For replacement only**
 Remove the stoppers and tags from the new ink film. Find the "T" shaped gear (blue).

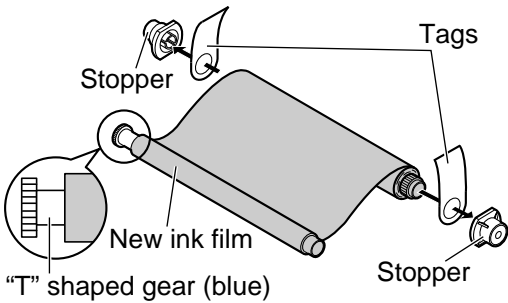

- 6** Insert the blue core of the front ink film roll into the right slot of the unit (①). Insert the "T" shaped gear (blue) into the left slot of the unit (②). Insert the rear ink film roll (③).

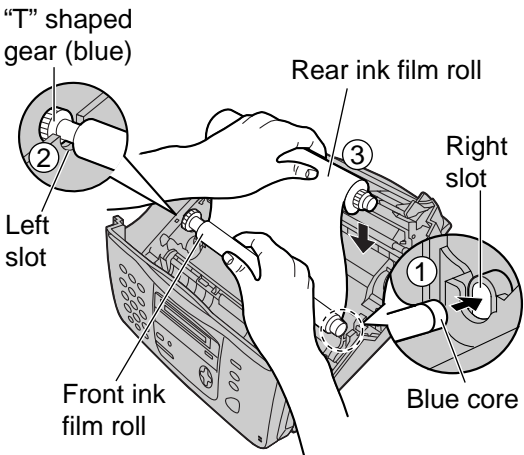

- 7** Turn the "T" shaped gear (blue) in the direction of the arrow.
 • Make sure that the ink film is wrapped around the blue core at least once.

Correct

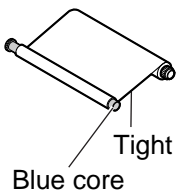

Incorrect

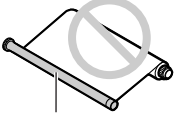

The ink film is not wrapped around the blue core.

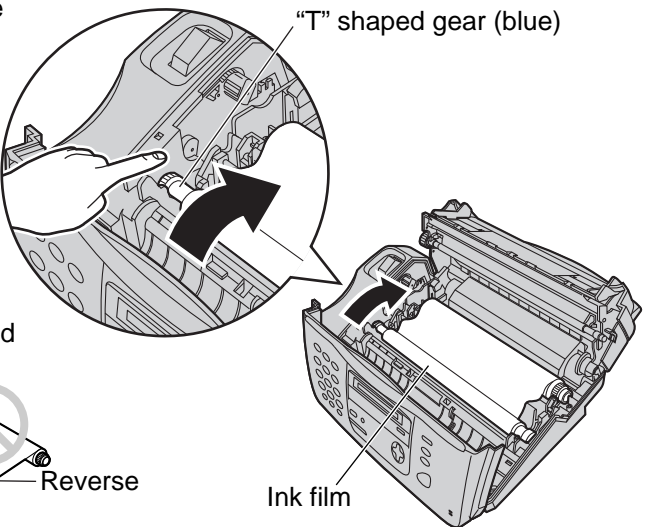
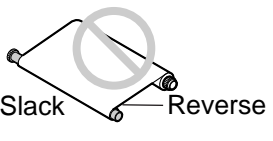
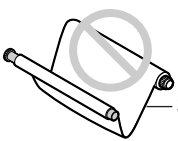

- 8** Close the back cover securely by pushing down on the dotted area at both ends (①). Close the front cover securely (②).

- The following will be displayed while the unit is checking that there is no slack in the ink film.

Display: PLEASE WAIT

Note:

- The ink film is completely safe to touch, and will not rub off on your hands like carbon paper.

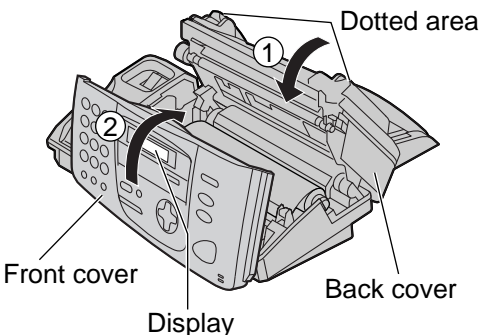

Setup

Paper tray

Insert tabs on the paper tray into slits on the back of the unit.

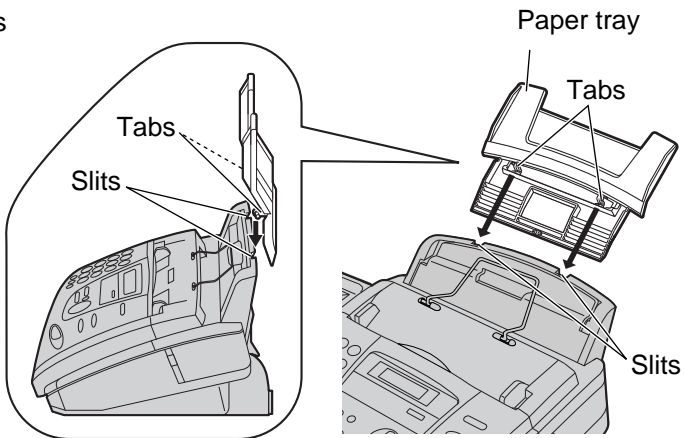

Note:

- Do not place the unit in areas where the paper tray may be obstructed (i.e. by a wall, etc.).

Recording paper

A4-sized recording paper can be loaded. The unit can hold up to 50 sheets of 60 g/m² to 75 g/m² paper or 30 sheets of 90 g/m² paper.

See the note for paper specifications on page 82.

- Fan the stack of paper to prevent a paper jam.
- Pull the tension plate forward and hold open while inserting the paper.
 - The paper should not be over the tab.
 - If the paper is not inserted correctly, readjust the paper, or the paper may jam.

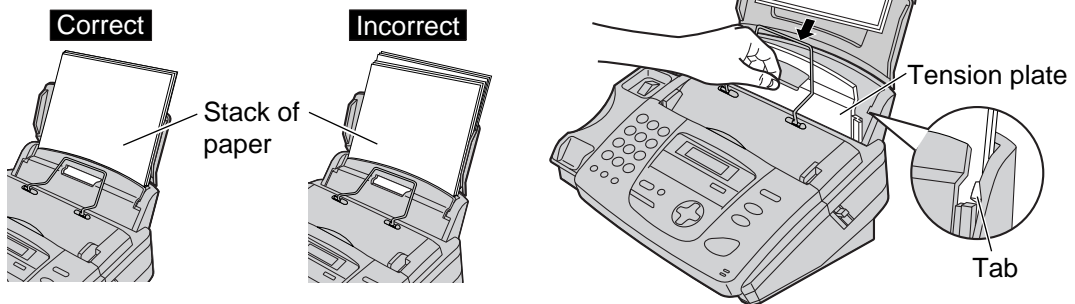

To add paper

- Pull the tension plate forward and hold open while removing all of the installed paper.
- Add paper to the stack of paper you removed and straighten.
- Fan the stack of paper.
- Pull the tension plate forward and hold open while inserting the paper.

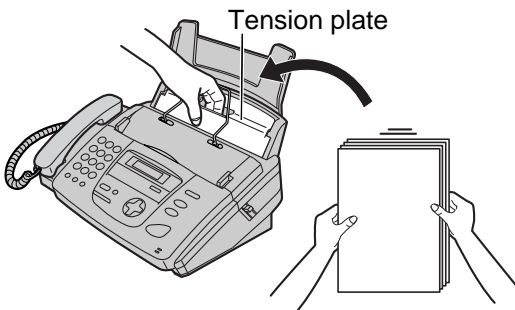

Setup

Metal bar

The recording paper will be ejected from the top of the unit after printing. The metal bar prevents the printed paper from curling. Do not remove the metal bar. If the bar comes off, attach it into the slots on the recording paper exit.

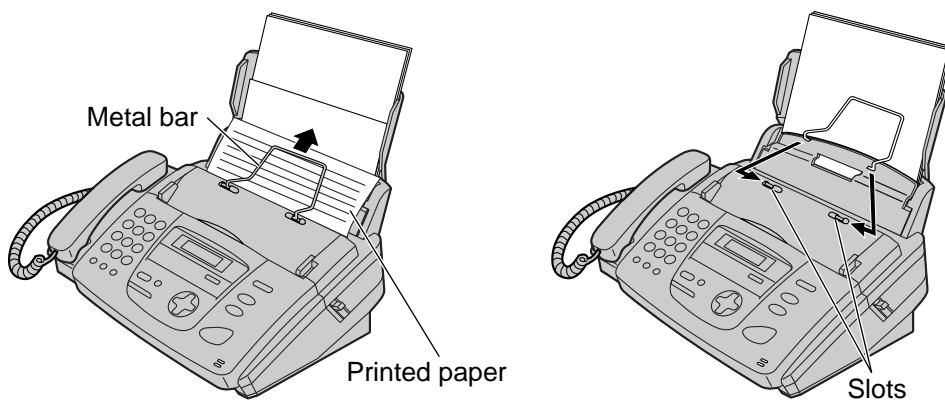

Setup

Connections

Connect the handset cord, and the telephone line cord, then the mains lead.

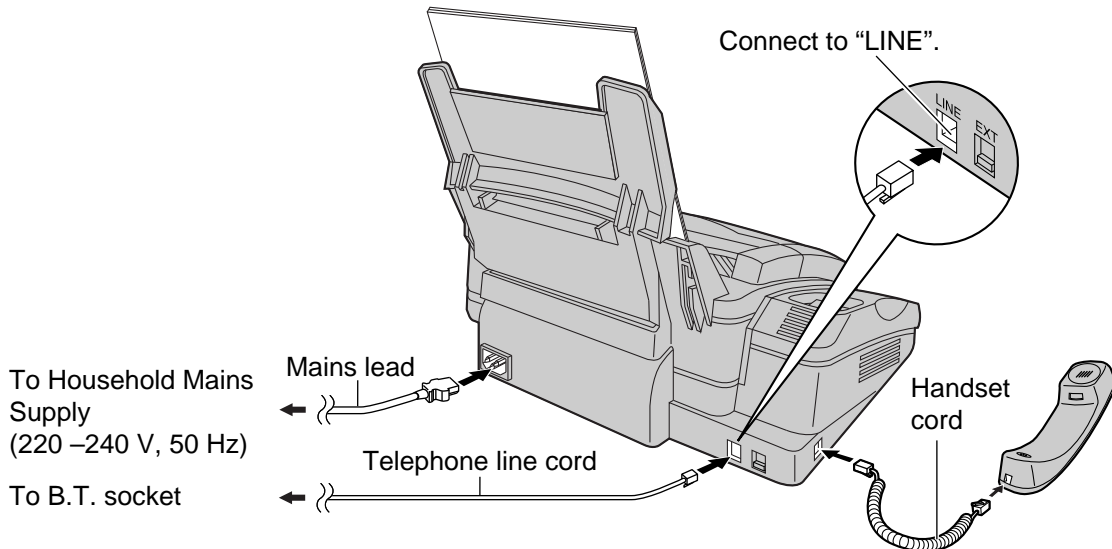

Caution:

- When you operate this product, the power outlet should be near the product and easily accessible.
- Be sure to use the telephone line cord included in this unit.
- Do not extend the telephone line cord.

Note:

- If you want to connect an answering machine to this unit, see page 42 (KX-FP151 only).
- Telephone line connection is TNV (Telecommunication Network Voltage).

To use the fax machine with a computer on the same line

- We recommend you use separate wall jacks for the fax machine and the computer.
- Set the fax machine to TEL mode (p. 38).
- The device which has the shortest ring setting will answer the call first.
- If the computer provides a port for a telephone line, connect the fax machine to this port on the computer.

Date and time, your logo and facsimile telephone number

You should program the date and time, your logo and facsimile telephone number. This information will be printed on each page transmitted from your unit.

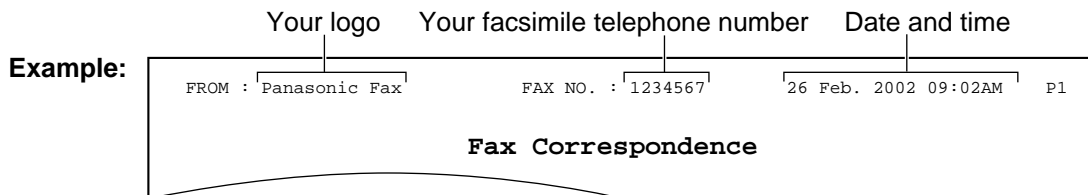

Setting the date and time

1 Press **MENU**.

Display: SYSTEM SET UP
PRESS NAVI. [◀ ▶]

2 Press **◀** or **▶** until the following is displayed.

SET DATE & TIME
PRESS SET

3 Press **SET**.

Cursor
Example: D: 01/M: 01/Y: 02
TIME: 12:00AM

4 Enter the correct day/month/year by selecting 2 digits for each, using the dial keypad.

Example: 10 August, 2002

Press **1 0 0 8 0 2**.

D: 10/M: 08/Y: 02
TIME: 12:00AM

5 Enter the correct hour/minute by selecting 2 digits for each, using the dial keypad.

Press ***** to select "AM" or "PM".

Example: 3:15 PM

1. Press **0 3 1 5**.

D: 10/M: 08/Y: 02
TIME: 03:15AM

2. Press ***** until "PM" is displayed.

D: 10/M: 08/Y: 02
TIME: 03:15PM

6 Press **SET**.
• The next feature will be displayed.

YOUR LOGO
PRESS SET

7 Press **MENU**.

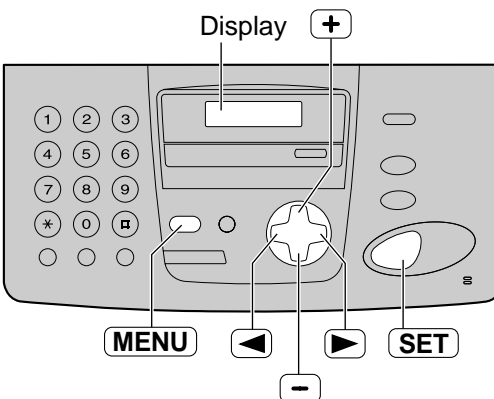

Note:

- You can enter the number by pressing **+** or **-** in steps 4 and 5. In this case, press **▶** to move the cursor.
- The accuracy of the clock is approximately ± 60 seconds a month.

To correct a mistake

- Press **◀** or **▶** to move the cursor to the incorrect number, and make the correction.

Setup

Setting your logo

The logo can be your company, division or name.

- 1** Press **MENU**.

Display: SYSTEM SET UP
PRESS NAVI. [◀ ▶]

- 2** Press **◀** or **▶** until the following is displayed.

YOUR LOGO
PRESS SET

- 3** Press **SET**.

LOGO=

- 4** Enter your logo, up to 30 characters, using the dial keypad. See the next page for details.

Example: "Bill"

1. Press **2** 2 times.

Cursor
LOGO=B

2. Press **4** 6 times.

LOGO=Bi

3. Press **5** 6 times.

LOGO=Bi1

4. Press **▶** to move the cursor to the next space and press **5** 6 times.

LOGO=Bill

- 5** Press **SET**.

- The next feature will be displayed.

YOUR FAX NO.
PRESS SET

- 6** Press **MENU**.

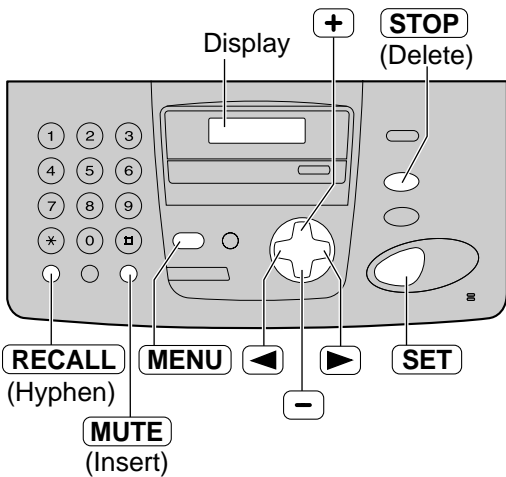

Note:

- You can enter your logo by pressing **+** or **-** (see the next page) in step 4. In this case, press **▶** to move the cursor.

To correct a mistake

- Press **◀** or **▶** to move the cursor to the incorrect character, and make the correction.

To delete a character

- Move the cursor to the character you want to delete and press **STOP**.



To insert a character

- Press **◀** or **▶** to move the cursor to the position to the right of where you want to insert the character.
- Press **MUTE** to insert a space and enter the character.

Setup

To select characters with the dial keypad

Pressing the dial keys will select a character as shown below.

Keys	Characters
①	1 [] { } + - / = , . _ ` : ; ?
②	A B C a b c 2
③	D E F d e f 3
④	G H I g h i 4
⑤	J K L j k l 5
⑥	M N O m n o 6
⑦	P Q R S p q r s 7
⑧	T U V t u v 8
⑨	W X Y Z w x y z 9
⑩	0 () < > ! " # \$ % & ¥ * @ ^ ' →
RECALL	Hyphen button (To insert a hyphen.)
MUTE	Insert button (To insert one character or one space.)
STOP	Delete button (To delete a character.)
	▶ key (To move the cursor to the right.) To enter another character using the same number key, move the cursor to the next space.
	◀ key (To move the cursor to the left.)

To select characters using **+** or **-**

Instead of pressing the dial keys, you can select characters using **+** or **-**.

1. Press **+** or **-** until the desired character is displayed.
2. Press  to move the cursor to the next space.
 - The character displayed in step 1 is inserted.
3. Return to step 1 to enter the next character.

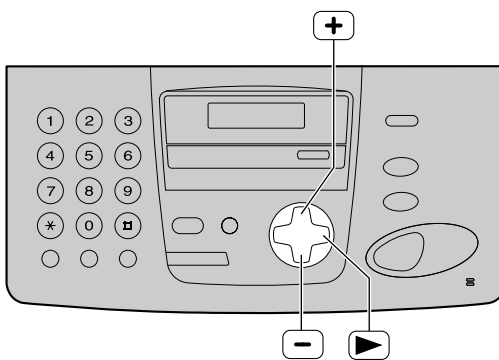

Display order of characters

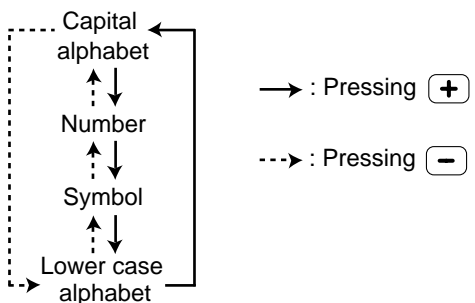

Setup

Setting your facsimile telephone number

1 Press **MENU**.

Display: SYSTEM SET UP
PRESS NAVI. [◀ ▶]

2 Press **◀** or **▶** until the following is displayed.

YOUR FAX NO.
PRESS SET

3 Press **SET**.

NO. =

4 Enter your facsimile telephone number, up to 20 digits, using the dial keypad.

Example: NO. =1234567

5 Press **SET**.

- The next feature will be displayed.

SENDING REPORT
=ERROR [±]

6 Press **MENU**.

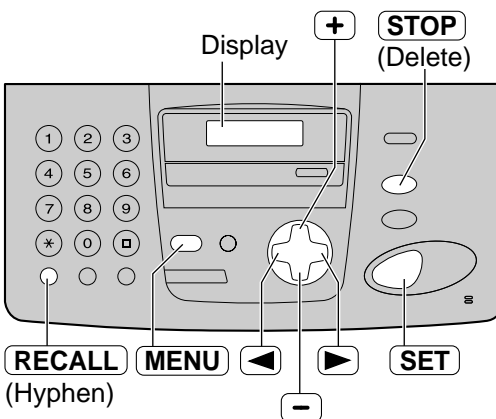

Note:

- You can enter your facsimile telephone number by pressing **+** or **-** in step 4. In this case, press **▶** to move the cursor.
- The ***** button replaces the digit with a "+" and the **□** button replaces it with a space.

Example (using the dial keypad): +234 5678

Press ***** **2** **3** **4** **□** **5** **6** **7** **8**.

- To enter a hyphen in a telephone number, press **RECALL**.

To correct a mistake

- Press **◀** or **▶** to move the cursor to the incorrect number, and make the correction.

To delete a number

- Move the cursor to the number you want to delete and press **STOP**.

Volume / Recall feature

Adjusting volume

Ringer volume

4 levels (high/middle/low/off) are available.

While the unit is idle, press **+** or **-**.

- If any documents are in the document entrance, you cannot adjust the ringer volume. Confirm that there are no documents in the entrance.

To turn the ringer off:

1. Press **-** repeatedly until the following is displayed.

Display: RINGER OFF= OK?
YES: SET/NO: STOP

2. Press **SET**.

RINGER OFF

- To turn the ringer back on, press **+**.

While the ringer volume is set to off:

When a call is received, the unit will not ring and will display the following.

INCOMING CALL

Monitor/Speaker volume

8 levels (high to low) are available.

While using the monitor/speakerphone, press **+** or **-**.

Fax voice guidance volume (KX-FP155 only)

9 levels (high to off) are available.

While listening to the fax voice guidance, press **+** or **-**.

Answering device volume (KX-FP155 only)

9 levels (high to off) are available.

While listening to the recorded messages, press **+** or **-**.

Ringer pattern

- You can select one of three ringer patterns. Change the setting (feature #17 on page 63). The ringer pattern you selected will sound when the unit receives a call.

RECALL button (to use the recall feature)

RECALL is used to access special telephone services (optional) such as call waiting.

Contact your telephone company business office for details.

Example: Call waiting

When a call waiting tone is heard during a conversation:

To hold the existing call and accept the waiting call

Press **RECALL**.

- Each time you press **RECALL**, you can switch between the first and second call.

Incoming calls cannot be dropped by the person who has received the call.

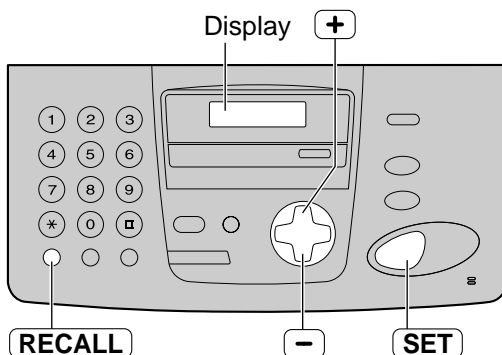

If your unit is connected to a PBX, pressing **RECALL** allows you to access some features of your host PBX such as transferring an extension call.

Navigator Directory

Storing names and telephone numbers into the directory

For rapid access to frequently dialed numbers, the unit provides the navigator directory (100 entries).

- 1 Press **MENU** repeatedly until the following is displayed.

Display: DIRECTORY SET
NAVI.=* BROAD=#

- 2 Press ***** to select "NAVI."

NAME=
STORE:PRESS SET

- 3 Enter the name, up to 10 characters (see page 19 for instructions).

Example: NAME=Alice
STORE:PRESS SET

- 4 Press **SET**.

NO.=

- 5 Enter the telephone number, up to 30 digits, using the dial keypad.

Example: NO.=5552233

- If you want to enter a hyphen, press **RECALL**.

- 6 Press **SET**.

REGISTERED

↓

NAME=
STORE:PRESS SET

- To program other entries, repeat steps 3 to 6.

- 7 Press **MENU** to exit the program.

Helpful hint:

- You can confirm the stored entries on the telephone number list (p. 80).

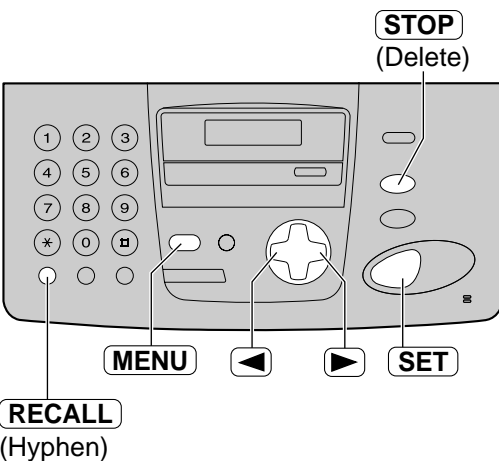

Note:

- When the following is displayed in step 6, you can store only 5 more entries.

Display: REGISTERED
SPACE= 5 DIRS.

- If there is no space to store new entries, the following is displayed in step 6.

REGISTERED
DIRECTORY FULL

Erase unnecessary entries (p. 23).

- A hyphen or a space entered in a telephone number counts as two digits.

To correct a mistake

- Press **◀** or **▶** to move the cursor to the incorrect character/number, and make the correction.

To delete a character/number

- Move the cursor to the character/number you want to delete, and press **STOP**.

Navigator Directory

Editing a stored entry

- 1** Press **[▶]**.
 • Confirm that there are no documents in the document entrance.

Display: DIRECTORY [+ -]

- 2** Press **[+]** or **[-]** until the desired entry is displayed.

Example: Mary
0123456



Mary
EDIT:PRESS MENU

- 3** Press **[MENU]**.

Example: NAME=Mary
EDIT=* DELETE=#

- 4** Press **[*]** to select "EDIT".

Example: NAME=Mary
STORE:PRESS SET

- If you do not need to edit the name, skip to step 6.

- 5** Edit the name (see page 19 for instructions).

- 6** Press **[SET]**.

Example: NO.=0123456

- If you do not need to edit the telephone number, skip to step 8.

- 7** Edit the telephone number. For further details, see page 22.

- 8** Press **[SET]**.

REGISTERED

Erasing a stored entry

- 1** Press **[▶]**.
 • Confirm that there are no documents in the document entrance.

Display: DIRECTORY [+ -]

- 2** Press **[+]** or **[-]** until the desired entry is displayed.

Example: Mary
0123456



Mary
EDIT:PRESS MENU

- 3** Press **[MENU]**.

Example: NAME=Mary
EDIT=* DELETE=#

- 4** Press **[#]** to select "DELETE".

DELETE OK?
YES:SET/NO:STOP

- To cancel erasing, press **[STOP]**.

- 5** Press **[SET]**.

DELETED

- The stored name and number are erased.

Note:

- You can use the following method to erase (KX-FP155 only).

1. Press **[▶]**.
 • Confirm that there are no documents in the document entrance.
2. Press **[+]** or **[-]** until the desired entry is displayed.
3. Press **[ERASE]**.
4. Press **[SET]**.

Navigator Directory / Recording

Making a phone call using the directory

Before using this feature, program the desired names and telephone numbers into the directory (p. 22).

- 1 Press .
 - Confirm that there are no documents in the document entrance.

Display: DIRECTORY [+ -]

- 2 Press or until the desired entry is displayed.

Example: Lisa
2233445



Lisa
EDIT:PRESS MENU

- If the desired name has not been stored, press **STOP** and dial the number manually.

- 3 Lift the handset or press **MONITOR** (KX-FP151)/**DIGITAL SP-PHONE** (KX-FP155).

- The unit will start dialling automatically.

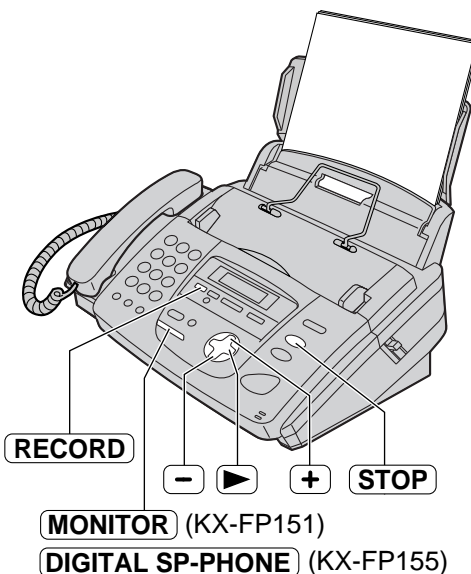

To search for a name by initial

Example: "Lisa"

1. Press .
 - Confirm that there are no documents in the document entrance.

Display: DIRECTORY [+ -]

2. Press or to enter the directory.

3. Press **5** repeatedly until any name with the initial "L" is displayed.

- To search for symbols (not letters or numbers), press *****.

4. Press until "Lisa" is displayed.

- To stop the search, press **STOP**.
- To make a call, lift the handset or press **MONITOR**/**DIGITAL SP-PHONE**.

Recording a telephone conversation (KX-FP155 only)

You can record a telephone conversation. This conversation can be played back later, either directly or remotely (p. 52, 54).

- 1 During a telephone conversation, press **RECORD**.

Display: 2WAY RECORDING

- 2 To stop recording, press **STOP** or replace the handset if you are using it.

Note:

- There may be legal restrictions on recording two-way telephone conversations. Inform the other party that the conversation is being recorded.

Caller ID service from your phone company

This unit is compatible with the Caller ID service offered by your local telephone company. To use this feature, you must subscribe to the Caller ID service.

Important:

- This unit is designed in accordance with the “FSK based subscriber line protocol” under the ETS (European Telecommunication Standard) and only supports the basic CLIP (Calling Line Identification Presentation) features.
- This unit will only display the caller’s telephone number and name.
- This unit will not support future additional telephone services.
- This unit cannot support services based on the “DTMF based subscriber line protocol”.
- Depending on the service of the local telephone company, the date/time of the call or the caller’s name may not be displayed.

Change the following ring settings to 2 or more rings beforehand.

- For KX-FP151: FAX ring setting (feature #06 on page 62) and TEL/FAX ring setting (feature #78 on page 70).
- For KX-FP155: TAD ring setting (feature #06 on page 62), FAX ring setting (feature #06 on page 62) and TEL/FAX ring setting (feature #78 on page 70).

How Caller ID is displayed

The calling party’s telephone number or name will be displayed after the first ring. You then have the option of whether or not to answer the call depending on the caller.

The unit will automatically store the caller information (telephone number, name and the time of the call). You can view the caller information (p. 26) and print the caller ID list (p. 80).

Note:

- If the unit is connected to a PBX (Private Branch Exchange) system, you may not receive the caller information. Consult your PBX supplier.
- If the unit cannot receive caller information, the following will be displayed.

OUT OF AREA

The caller dialed from an area which does not provide Caller ID service.

PRIVATE CALLER

The caller requested not to send caller information.

OR

WITHHELD

LONG DISTANCE

The caller made a long distance call.

To confirm caller information using the Caller ID list

The unit will store information for the most recent 30 callers.

- To print manually, see page 80.
- To print automatically after every 30 new calls, activate feature #26 (p. 64).

Caller ID

Viewing and calling back using caller information

You can easily view caller information and call back.

Important:

- Calling back will not be possible in the following cases.
 - The telephone number includes data other than numbers (i.e. * or #).
 - The caller information does not include a telephone number.

1 Press **CALLER ID**.

Example:

2 NEW CALLS PRESS NAVI . [+ -]

(2 new calls are received)

2 Press **+** to search from the most recent caller information.
Press **-** to search from the oldest caller information.

3 Lift the handset or press **MONITOR** (KX-FP151)/**DIGITAL SP-PHONE** (KX-FP155) to call back the displayed party.

- The unit will start dialling automatically.
- To send a fax – insert the document **FACE DOWN** and press **FAX/START** (p. 30).

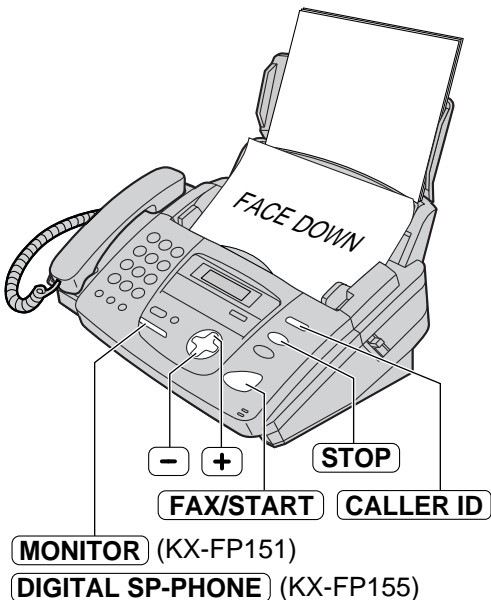

To display the caller's name

Press **CALLER ID** after step 2.

Example:

3456789012 11:20AM 20Jul

 ↔

SAM LEE 11:20AM 20Jul

 ✓ This means this call has already been viewed or answered.

Display while viewing

NO NAME RCVD

 When the unit could not receive a name.

NO CALLER DATA

 When no calls have been received.

To stop viewing

Press **STOP** after step 2.

Caller ID

Erasing all caller information

- 1** Press **MENU** repeatedly until the following is displayed.

Display: CALLER SET UP
PRESS SET

- 2** Press **SET**.

CALL LIST ERASE
PRESS SET

- 3** Press **SET**.

ERASE ALL OK?
YES:SET/NO:STOP

- To cancel erasing, press **STOP**, then **MENU**.

- 4** Press **SET**.

ERASE COMPLETED

- 5** Press **STOP** to exit the program.

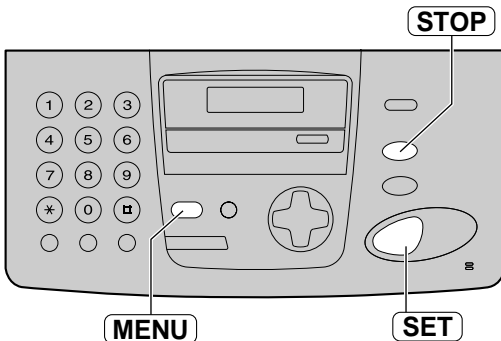

Erasing specific caller information (KX-FP155 only)

- 1** Press **CALLER ID**.

Example: 2 NEW CALLS
PRESS NAVI.[+ -]

- 2** Press **+** or **-** until the desired entry is displayed.

Example: 3453809
12:10AM 20Jul

- 3** Press **ERASE**.

DELETED

Example: 4567890
12:12AM 20Jul

- To erase other entries, repeat steps 2 and 3.

- 4** Press **STOP** to exit the program.

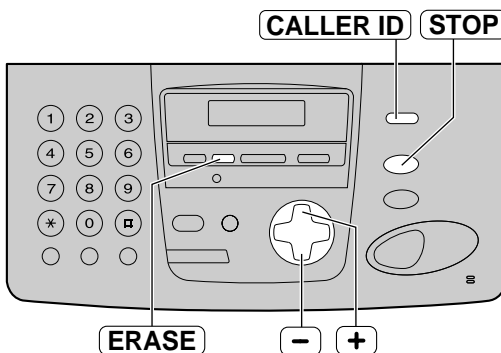

Caller ID

Storing caller information into the directory

Important:

- This feature is not available in the following cases.
 - The telephone number includes data other than numbers (i.e. * or #).
 - The caller information does not include a telephone number.

1 Press **CALLER ID**.

Example: 2 NEW CALLS
PRESS NAVI. [+ -]

2 Press **+** or **-** until the number desired entry is displayed.

Example: 1345678901
11:50AM 14Apr

3 Press **MENU**.

NAME=
STORE:PRESS SET

4 Press **SET**.

Example: NO.=1345678901

5 Press **SET**.

REGISTERED

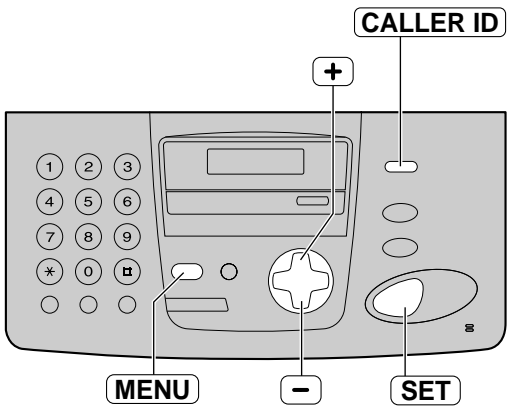

Note:

- You can confirm the stored entries on the telephone number list (p. 80).
- The unit can only store a name of up to 10 characters long.
- To edit a name and number, see page 23.

Voice Contact

Talking to the other party after fax transmission or reception

You can talk to the other party after a fax message is completed. This will save the added expense and time of making another call.

This feature only works when the other party's fax machine is equipped with a voice contact feature.

Initiating voice contact

- 1 Press **MONITOR** (KX-FP151)/**DIGITAL SP-PHONE** (KX-FP155) while transmitting or receiving documents.

Example:

TO: 23456789 VOICE STANDBY

- Your unit will call the other party with a distinctive ring.
- When the other party answers, your unit will emit a distinctive ring.

- 2 Press **DIGITAL SP-PHONE** (KX-FP155) or lift the handset to start talking.

Note:

- If you initiate voice contact during transmission, when the other party answers, the unit will call you with a distinctive ring after all of the documents have been transmitted.
- If you initiate voice contact during reception, when the other party answers, the unit will call you with a distinctive ring after the current page of the document has been received.

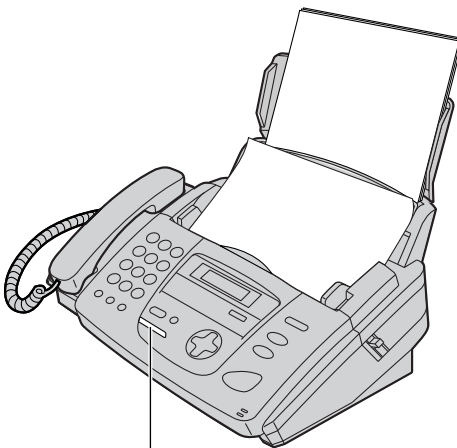

MONITOR (KX-FP151)
DIGITAL SP-PHONE (KX-FP155)

Receiving a request for voice contact

- 1 If the other party initiates voice contact, your unit will sound a distinctive ring and the following will be displayed.

Display:

PLEASE PICK UP

- 2 Press **DIGITAL SP-PHONE** (KX-FP155) or lift the handset within 10 seconds of the distinctive ring.

Note:

- If you do not answer within 10 seconds of the distinctive ring;
 - in TAD/FAX mode, your unit will play a greeting message and record an incoming voice message (KX-FP155 only).
 - in FAX ONLY, TEL or TEL/FAX mode, the line will be disconnected.

Sending Faxes

Sending a fax manually

- Adjust the width of the document guides to the size of the document.
- Insert the document (up to 10 pages) **FACE DOWN** until a single beep is heard and the unit grasps the document.

Display: STANDARD
PRESS NAVI. [+ -]

- If necessary, press **[+]** or **[-]** repeatedly to select the desired resolution (see below).
- Lift the handset or press **MONITOR** (KX-FP151)/**DIGITAL SP-PHONE** (KX-FP155).

TEL=
PRESS NAVI. [▶]

- Dial the fax number.

Example: TEL=5678901

- When a fax tone is heard:**
Press **FAX/START**, and replace the handset if you are using it.
OR

When the other party answers your call:
Ask them to press their start button. When the fax tone is heard, press **FAX/START**.

CONNECTING
STANDARD [±]

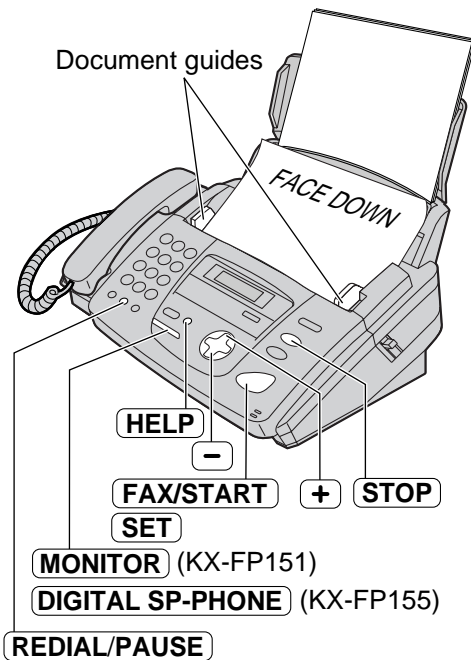

To select the resolution

Select the desired resolution according to the type of document.

- **STANDARD:** For printed or typewritten originals with normal-sized characters.
- **FINE:** For originals with small printing.
- **SUPER FINE:** For originals with very small printing. This setting only works with other compatible fax machine.
- **PHOTO:** For originals containing photographs, shaded drawings, etc.
- Using the “FINE”, “SUPER FINE”, or “PHOTO” setting will increase transmission time.
- If the resolution setting is changed during feeding, it will be effective from the next sheet.

To redial the last number

Press **REDIAL/PAUSE**.

- If the line is busy, the unit will automatically redial the number up to 5 times.
- During redial, the following will be displayed.

Display: WAITING REDIAL

- To cancel redialling, press **STOP**.

To stop transmission

Press **STOP**.

To transmit more than 10 pages at a time

- Insert the first 10 pages of the document. Add the other pages (up to 10 at a time) before the last page feeds into the unit.

Sending Faxes

Convenient way to send a fax

You can dial the fax number first before inserting the document. This is convenient if the other party's number is indicated on the document.

1. Enter the fax number.
 - The handset must be on the cradle.
2. Insert the document.
3. Press **FAX/START**.

Quick scan feature

This feature is helpful when you want to send the document, then take it for other uses. To use this feature, activate feature #34 on page 65.

1. Insert the document.
 2. Enter the fax number.
 3. Press **FAX/START**.
- The document will be fed into the unit and scanned into memory. The unit will then transmit the data. If the document exceeds the memory capacity (p. 81), sending will be cancelled and this feature will be turned off automatically. Transmit the entire document manually.

Sending a fax with the voice guide (KX-FP155 only)

You can send documents by following the voice guide.

1. Press **HELP** 2 times.
 2. Press **SET**.
 3. Follow steps 1 to 6 on page 30.
- After transmission, the voice guide will turn off automatically.

Sending report for confirmation

This report will provide you with a printed record of transmission results. To use this feature, activate feature #04 (p. 62). For the communication message in the result column, see page 71.

Journal report

The unit stores the 30 most recent fax communication results.

- To print manually, see page 80.
- To print automatically after every 30 new fax communications, activate feature #22 (p. 64).

For the communication message in the result column, see page 71.

Documents you can send

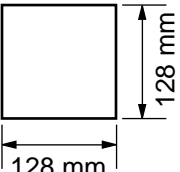
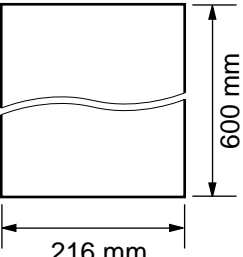
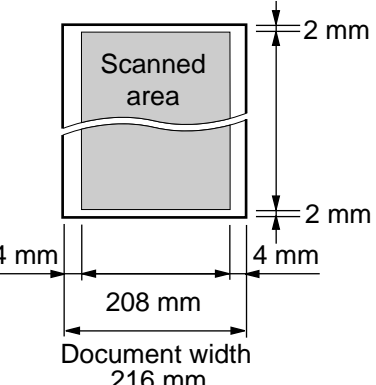
Minimum size	Maximum size	Effective scanning area	Document weight
			Single sheet: 45 g/m ² to 90 g/m ² Multiple sheets: 60 g/m ² to 75 g/m ²

Note:

- Remove clips, staples or other similar fasteners.
- Check that ink, paste or correction fluid has dried.
- Do not send the following types of documents: (Use copies for fax transmission.)
 - Chemically treated paper such as carbon or carbonless duplicating paper
 - Electrostatically charged paper
 - Badly curled, creased or torn paper
 - Paper with a coated surface
 - Paper with a faint image
 - Paper with printing on the opposite side that can be seen through the front (e.g. newspaper)
- To transmit the document(s) with a width of less than the A4 size (210 mm), we recommend using a copy machine to copy the original document onto A4 or letter-sized paper, then transmit the copied document.

Sending Faxes

Sending a fax using the directory

Before using this feature, program the desired names and telephone numbers into the directory (p. 22).

1 Adjust the width of the document guides to the size of the document.

2 Insert the document (up to 10 pages) **FACE DOWN** until a single beep is heard and the unit grasps the document.

Display: STANDARD
PRESS NAVI. [+ -]

3 If necessary, press **+** or **-** repeatedly to select the desired resolution (p. 30).

4 Press **▶**.

DIRECTORY [+ -]

5 Press **+** or **-** until the desired entry is displayed.

Example: Sam
1789653

- For further details about using the directory, see page 24.

6 Press **FAX/START**.

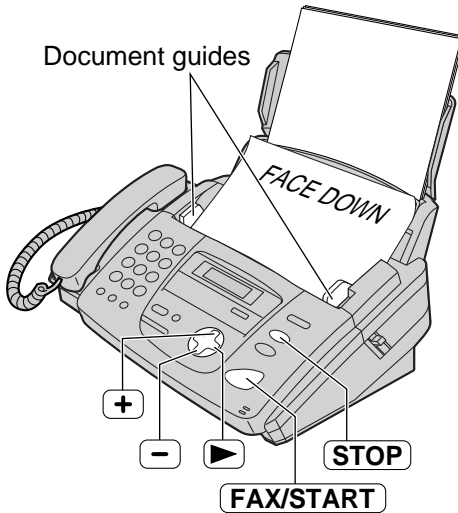

Fax auto redial

If the line is busy or if there is no answer, the unit will automatically redial the number up to 5 times.

- This feature is also available for delayed transmission (feature #25 on page 64).
- During redial, the following will be displayed.

Display: WAITING REDIAL

- To cancel redialling, press **STOP**.

If your unit does not send a fax

- Confirm the stored telephone number on the display and check that the number dialed is answered by the other party's machine (p. 24).
- The connecting tone will be heard during dialling to tell you the status of the other party's machine (feature #76 on page 69).

Sending Faxes

Broadcast transmission

This feature is useful for sending the same document to selected parties (up to 20 entries). First program the entries, then see page 35 for transmission.

- To send to selected parties only once, see page 35.

Programming entries into the broadcast memory

- 1 Press **MENU** repeatedly until the following is displayed.

Display: `DIRECTORY SET
NAVI.=* BROAD=#`

- 2 Press **▣** to select "BROAD".

`DIR= [00]
NAVI.[+ -] & SET`

- 3 Press **+** or **-** until the desired entry is displayed.

Example: `MIKE
987-654-3210`

- 4 Press **SET**.

Example: `DIR=MIKE [01]
STORE:PRESS SET`

- To program other entries, repeat steps 3 and 4 (up to 20 entries).

- 5 Press **SET** to exit the program.

`REGISTERED`

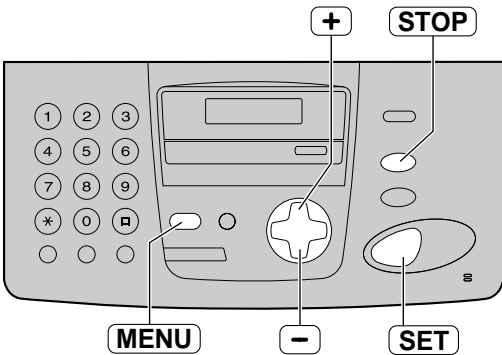

Note:

- If you enter the wrong entry, press **STOP** after step 4 to erase the entry.
- Confirm the stored entries by printing a broadcast programming list (p. 80).

Sending Faxes

Adding a new entry into the broadcast memory

- 1** Press **[▶]**.
 • Confirm that there are no documents in the document entrance.

Display: DIRECTORY [+ -]

- 2** Press **[+]** or **[-]** until the following is displayed.

<BROADCAST>
EDIT:PRESS MENU

- 3** Press **[MENU]**.

BROADCAST
ADD=* DELETE=#

- 4** Press **[*]** to select "ADD".

- 5** Press **[+]** or **[-]** until the desired entry you want to add is displayed.

Example: Mary
584-372-4123

- 6** Press **[SET]**.

REGISTERED



Example:

Nikki
385-217-9365

- To add other entries, repeat steps 5 and 6 (up to 20 entries).

- 7** Press **[STOP]** to exit the program.

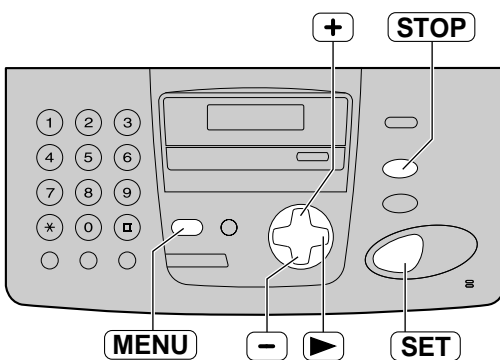

Erasing a stored entry in the broadcast memory

- 1** Press **[▶]**.
 • Confirm that there are no documents in the document entrance.

Display: DIRECTORY [+ -]

- 2** Press **[+]** or **[-]** until the following is displayed.

<BROADCAST>
EDIT:PRESS MENU

- 3** Press **[MENU]**.

BROADCAST
ADD=* DELETE=#

- 4** Press **[#]** to select "DELETE".

- 5** Press **[+]** or **[-]** until the desired entry you want to erase is displayed.

Example: Dick
328-143-2968

- To cancel erasing, press **[STOP]**.

- 6** Press **[SET]**.

DELETE OK?
YES:SET/NO:STOP

- 7** Press **[SET]**.

DELETED



Example:

Bob
0123456

- To erase other entries, repeat steps 5 to 7.

- 8** Press **[STOP]** to exit the program.

Sending Faxes

Sending the same document to pre-programmed parties

- 1 Insert the document **FACE DOWN**.
 - If necessary, press **+** or **-** repeatedly to select the desired resolution (p. 30).
- 2 Press **▶**.

Display: DIRECTORY [+ -]
- 3 Press **+** or **-** until the following is displayed.

<BROADCAST>
SEND:PRESS SET
- 4 Press **SET**.
 - The document will be fed into the unit and scanned into memory. The unit will then transmit the data to each entry, calling each number sequentially.
 - After transmission, the stored document will be erased automatically, and the unit will automatically print a broadcast sending report.

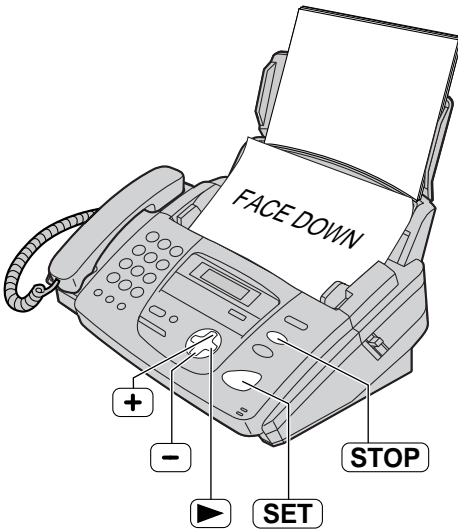

Note:

- If you select the "FINE", "SUPER FINE" or "PHOTO" resolution, the number of pages that the unit can transmit will decrease.
- If the document exceeds the memory capacity (p. 81), sending will be cancelled.
- If one of the entries is busy or does not answer, it will be skipped. All skipped entries will be redialled up to 5 times after all of the other entries have been called.

To send to selected parties only once

You can also select the parties for each transmission.

1. Follow steps 1 and 2 above.
2. Press **+** or **-** until the following is displayed.

Display: <ONE TIME BROAD>
PRESS SET
3. Press **SET** to start programming the entries you want to transmit.

DIR= [00]
NAVI.[+ -] & SET
4. Press **+** or **-** until the desired entry you want to transmit is displayed.

Example: Bill
6543210
5. Press **SET**.

Example: DIR=Bill [01]
SEND:PRESS SET

 - To program other entries, repeat steps 4 and 5 (up to 20 entries).
6. Press **SET** to start transmission to the programmed entries.

To cancel the broadcast setting

1. Press **STOP** while the unit displays the following.

Display: BROADCASTING

- The display will show the following.

SEND CANCELLED?
YES:SET/NO:STOP

2. Press **SET**.

Receiving Faxes

Setting the unit to receive faxes

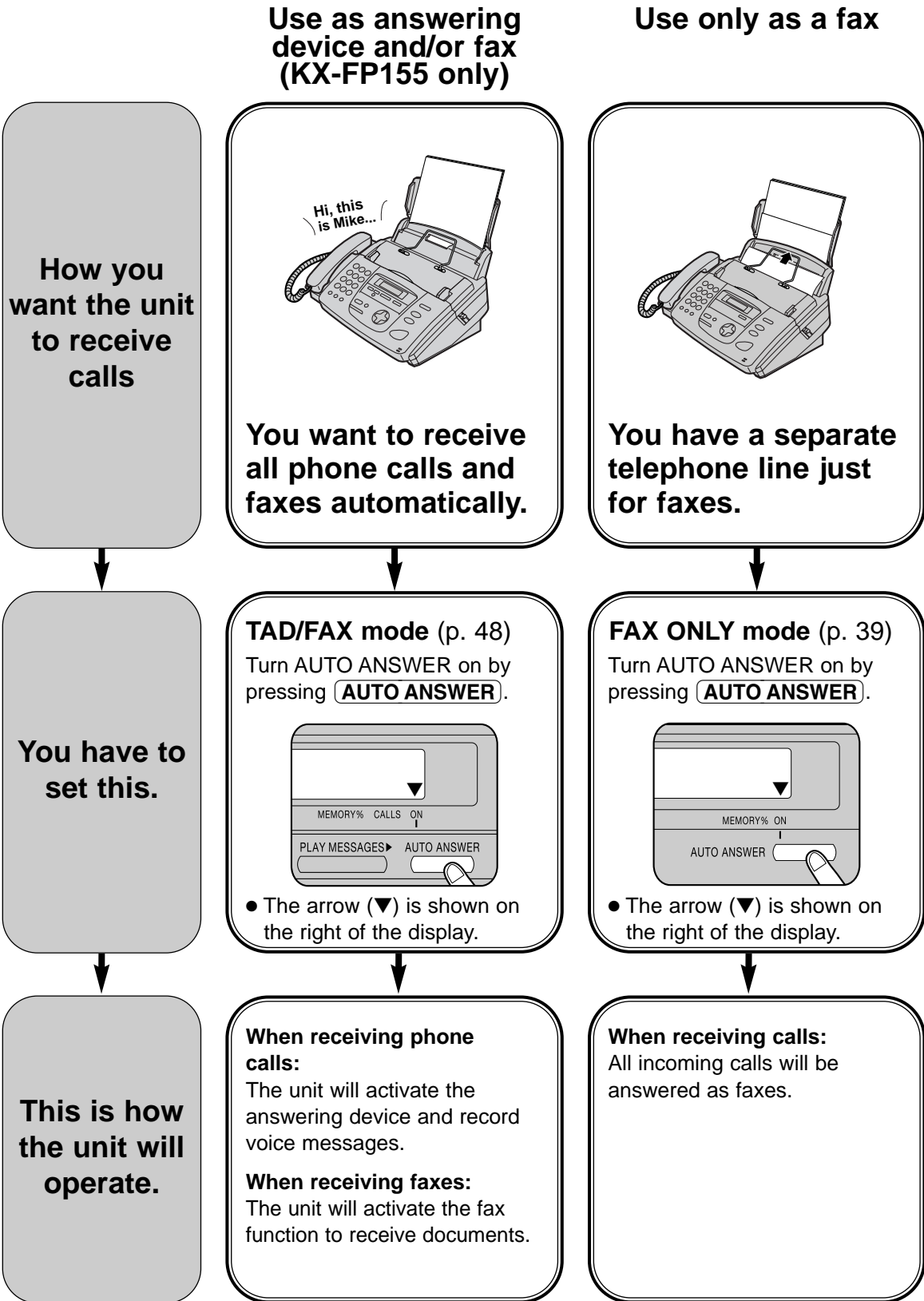

Receiving Faxes

Use as telephone/ automatic fax

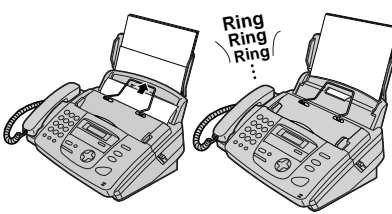

You want to answer the phone call yourself and receive faxes without rings.

TEL/FAX mode (p. 40)
Turn AUTO ANSWER on by pressing **AUTO ANSWER**.

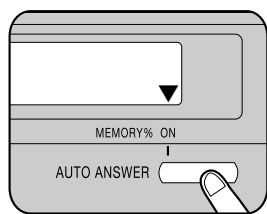

- The arrow (▼) is shown on the right of the display.

When receiving phone calls:
The unit will ring.

When receiving faxes:
The unit will receive fax documents without ringing.

Mostly phone calls



You plan to answer the calls yourself.

TEL mode (p. 38)
Turn AUTO ANSWER off by pressing **AUTO ANSWER**.

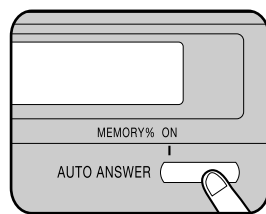

- The arrow (▼) is not shown on the right of the display.

When receiving calls:
You have to answer all calls manually.

To receive a fax document, press **FAX/START** for each fax you are receiving.

Other options

With answering machine (KX-FP151 only)

You can use the fax machine with an answering machine (p. 42, 43).

Remote fax activation

You can also receive a fax using an extension telephone. While hearing a fax calling tone with an extension telephone, press ***9** (pre-selected fax activation code) to receive a fax (p. 44).

Receiving Faxes

TEL mode (answering all calls manually)

Activating TEL mode

If the arrow (▼) is shown on the right of the display, turn it off by pressing **(AUTO ANSWER)**.

Display: TEL MODE ON

Receiving a fax manually

- 1 When the unit rings, lift the handset.
 - You can press **(MONITOR)** (KX-FP151) / **(DIGITAL SP-PHONE)** (KX-FP155).
- 2 When:
 - document reception is required,
 - a fax calling tone (slow beep) is heard, or
 - no sound is heard,
 press **(FAX/START)**.

Display: CONNECTING

- 3 Replace the handset if you are using it.
 - The unit will start fax reception.

Note:

- Up to 30 sheets of printed paper can be held. Remove the printed paper before it exceeds 30 sheets.

To stop receiving

Press **(STOP)**.

Friendly reception feature

When you answer a call and hear a fax calling tone (slow beep), the unit will automatically start fax reception.

- If this feature is not required, set feature #46 to off (p. 66).

Fax reception in memory

When a printing problem is detected, the unit will temporarily store the received document into memory. While the document is in memory:

- the display will show an error message and the following alternately,

Display: FAX IN MEMORY

- slow beeps will sound if feature #44 is set to on (p. 66).
- Follow the instructions on pages 71–73 to solve the problem.
- For memory capacity, see page 81.

38

Turning the AUTO ANSWER mode on remotely

When you are not in, and the AUTO ANSWER mode of your unit is set to off (TEL mode), you can turn the AUTO ANSWER mode on from a remote location using a touch tone telephone.

AUTO ANSWER mode:

- FAX only mode
- TEL/FAX mode
- TAD/FAX mode (KX-FP155 only)

■ For KX-FP151

1. Call your unit and wait for 10 rings.
 - You will hear a beep signal.
2. — **To switch to FAX ONLY mode:**
Press ***** within 8 seconds.
- **To switch to TEL/FAX mode:**
Press **#** within 8 seconds.
3. Hang up the handset.

Note:

- Press ***** or **#** within 8 seconds after hearing the beep, otherwise the call will be interrupted and the unit will remain in the TEL mode.

■ For KX-FP155

1. Call your unit and wait for 10 rings.
 - You will hear a beep signal.
2. Enter the remote operation ID (feature #11 on page 63) within 8 seconds.
 - You will hear a beep signal.
3. — **To switch to FAX ONLY mode:**
Press ***** within 3 seconds.
- **To switch to TEL/FAX mode:**
Press **#** within 3 seconds.
- **To switch to TAD/FAX mode:**
Wait for 3 seconds, then the greeting message will be played.
4. Hang up the handset.

Note:

- Enter the remote operation ID within 8 seconds after hearing the beep, otherwise the call will be interrupted and the unit will remain in TEL mode.

Receiving Faxes

FAX ONLY mode (all calls are received as faxes)

Activating FAX ONLY mode

- 1 Set feature #77 to "FAX ONLY" (p. 70).
- 2 If the arrow (▼) is not shown on the right of the display, turn it on by pressing

AUTO ANSWER.

Display:

FAX ONLY MODE



ON

- When receiving calls, the unit will automatically answer all calls and only receive fax documents.



AUTO ANSWER

Note:

- The number of rings before a call is answered in FAX ONLY mode can be changed (feature #06 on page 62).
- This mode should not be used with a telephone line which is used for both phone calls and faxes. Fax communication will be attempted even if someone is trying to call you. We recommend the following setup:

Example:

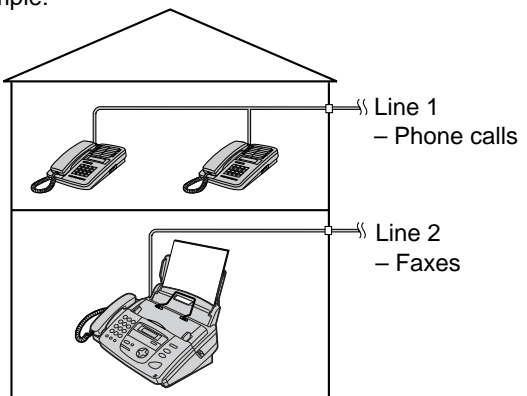

Only a fax machine is connected.

Receiving Faxes

TEL/FAX mode (receiving phone calls with ring signals and faxes without ring signals when you are near the unit)

Use this mode when you are situated near the fax machine, and want to receive faxes without the unit ringing. When a call is received, the fax machine will work as follows. To set TEL/FAX mode, see below.

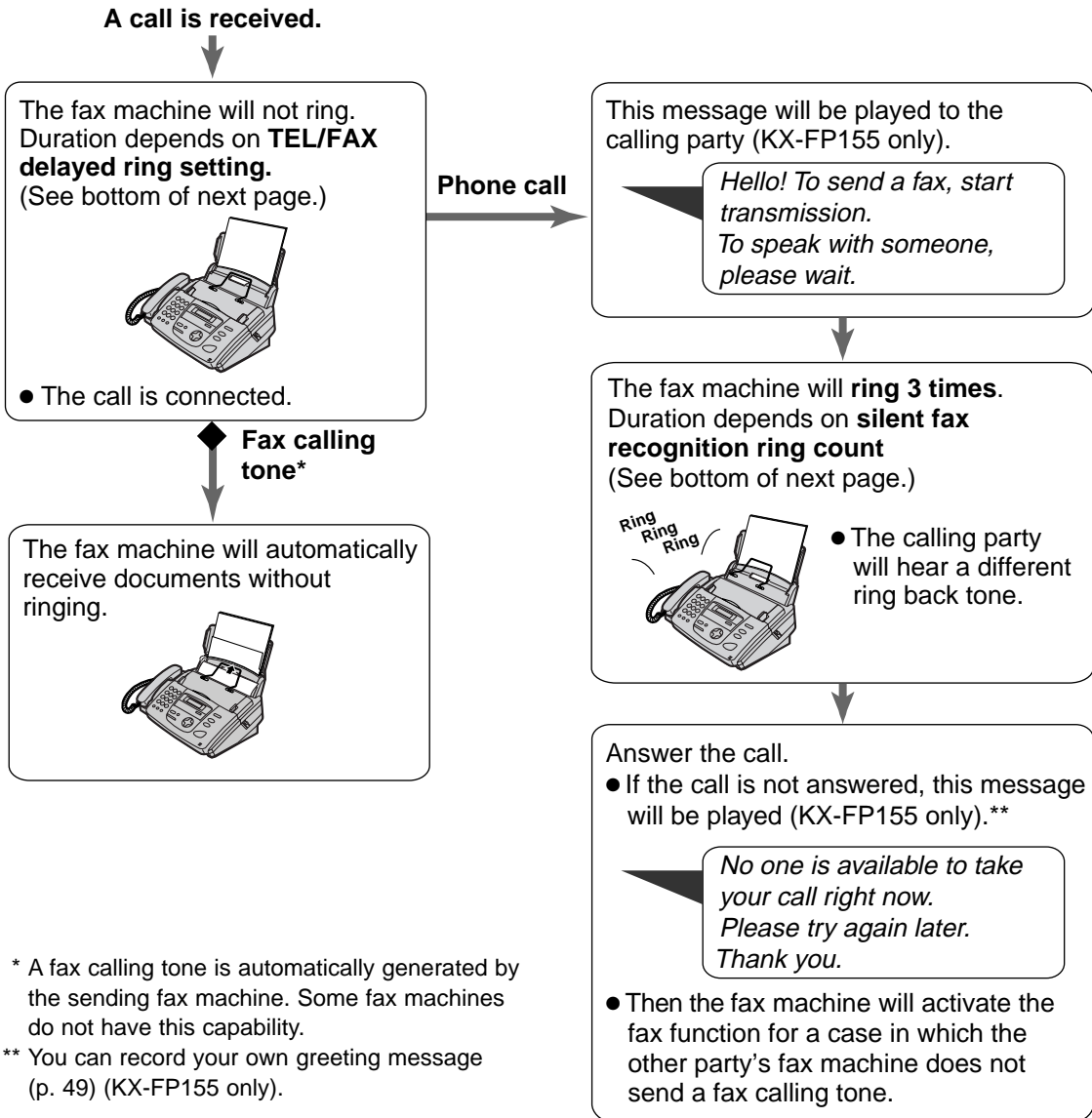

* A fax calling tone is automatically generated by the sending fax machine. Some fax machines do not have this capability.
 ** You can record your own greeting message (p. 49) (KX-FP155 only).

Note:

- The fax machine will display the following when a call is received.
 Display: INCOMING CALL
- The ringer should be on (p. 21).

To set TEL/FAX mode

1. Set feature #77 to "TEL/FAX" (p. 70).
2. If the arrow (▼) is not shown on the right of the display, turn it on by pressing **AUTO ANSWER**.

Display: ▼
ON

Receiving Faxes

When an extension telephone is connected

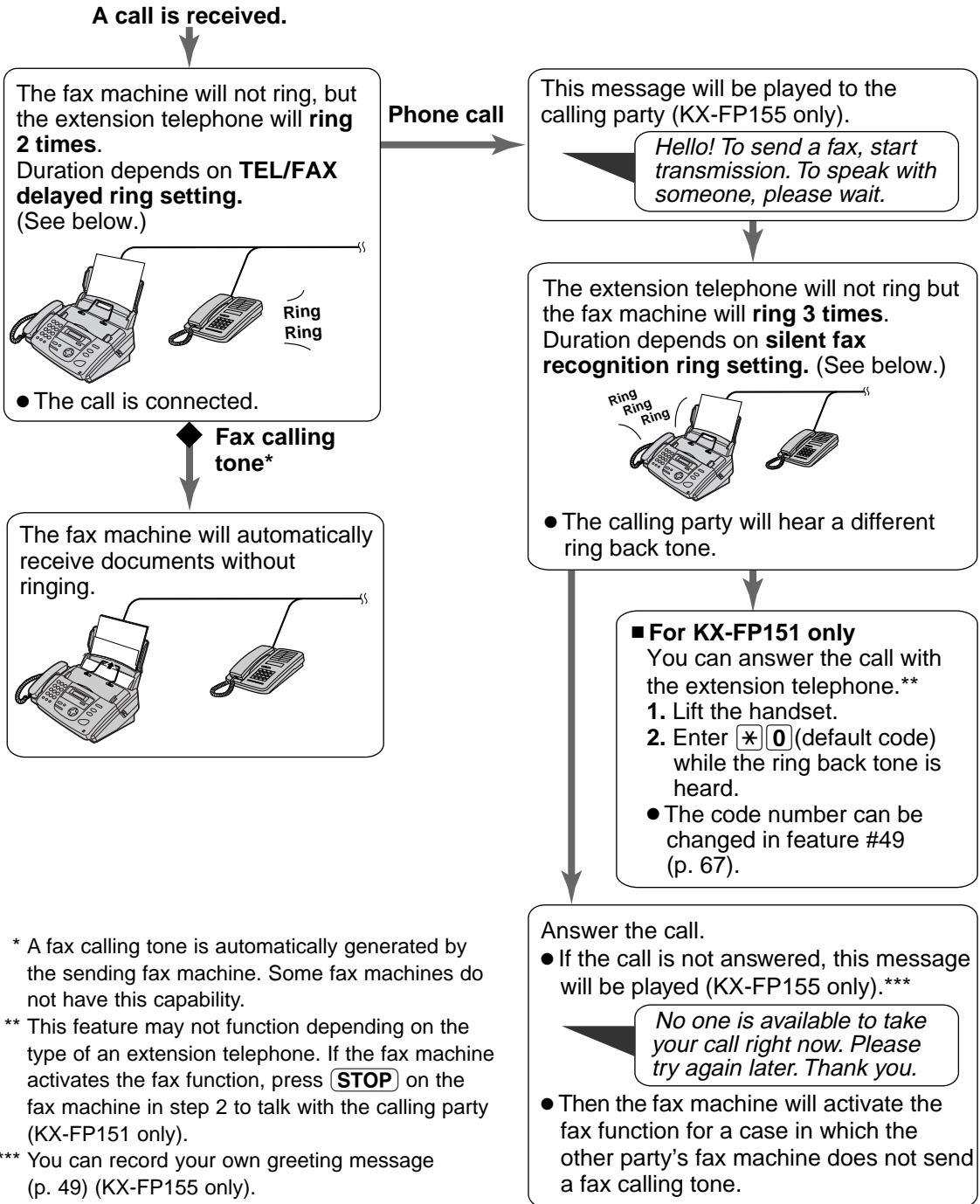

* A fax calling tone is automatically generated by the sending fax machine. Some fax machines do not have this capability.

** This feature may not function depending on the type of an extension telephone. If the fax machine activates the fax function, press **STOP** on the fax machine in step 2 to talk with the calling party (KX-FP151 only).

*** You can record your own greeting message (p. 49) (KX-FP155 only).

TEL/FAX delayed ring setting

The number of rings generated before the fax machine answers depends on the setting of feature #78 on page 70. The fax machine will not generate an audible ring during this time.

Silent fax recognition ring setting

The fax machine generates audible rings to indicate that it is receiving a phone call. The number of rings generated depends on the setting of feature #30 on page 65. This signal will not ring on an extension telephone.

Receiving Faxes

Using the unit with an answering machine (KX-FP151 only)

Setting up the fax machine and an answering machine

- 1 Connect the answering machine.

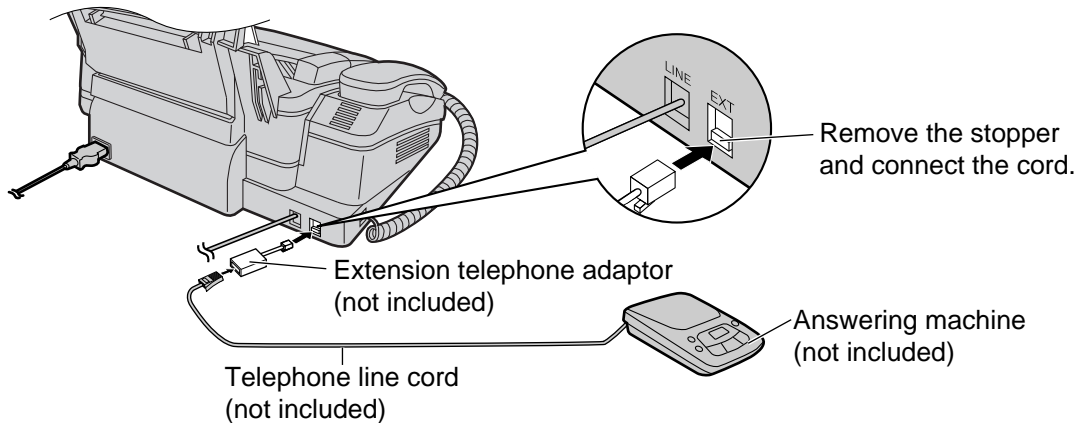

- 2 Set the number of rings on the answering machine to less than 4.
 - This will allow the answering machine to answer the call first.
- 3 Record a greeting message on the answering machine.

Example: *"This is (your name, business and/or telephone number). We are unable to answer the phone right now. To send a fax, start transmission. To leave a message, please speak after the beep. Thank you."*

 - We recommend you record a message up to 10 seconds long, and not to pause for more than 4 seconds during the message. Otherwise, both machines will not function correctly.
- 4 Activate the answering machine.
- 5 Set the fax machine to TEL mode (p. 38) or FAX ONLY mode (p. 39).
 - If you set to FAX ONLY mode, **change the ring setting in FAX ONLY mode to more than 4 (feature #06 on page 62)**. Using FAX ONLY mode will allow you to receive faxes if the answering machine is full.
- 6 Check all or part of the followings are not the same:
 - the remote access code of the answering machine
 - the fax activation code (feature #41 on page 65)

Receiving Faxes

How the fax machine and answering machine work

Receiving phone calls

The answering machine will record voice messages automatically.

Receiving faxes

The fax machine will receive documents automatically when the machine detects a fax calling tone.

Receiving a voice message and fax document in one call

See below.

Note:

- Every time the fax machine receives a document, a silent pause or fax tone may be recorded on the answering machine.

Receiving a voice message and fax document in one call

The caller can leave a voice message and send a fax document during the same call.

Inform the caller of the following procedure beforehand.

1. The caller calls your fax machine.
 - The answering machine will answer the call.
2. The caller can leave a message after the greeting message.
3. The caller presses ***9** (pre-selected fax activation code).
 - The fax machine will activate the fax function.
4. The caller presses the start button to send a document.

Note:

- The fax activation code can be changed in feature #41 (p. 65).

Receiving Faxes

Extension telephone

If you use the fax machine with an extension telephone, you can receive fax documents using the extension telephone. You do not have to press **FAX/START** on the fax machine.

Important:

- Use a touch tone telephone as the extension telephone and enter the fax activation code **firmly**.

1 When the extension telephone rings, lift the handset of the extension telephone.

2 When:

- document reception is required,
- a fax calling tone (slow beep) is heard, or
- no sound is heard,

press ***9** (pre-selected fax activation code) **firmly**.

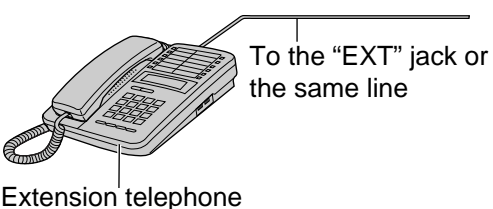

3 Hang up the handset.

- The fax machine will start reception.

Note:

- You can change the fax activation code in feature #41 (p. 65).

Receive polling (retrieving a fax placed on another fax machine)

This feature allows you to retrieve a document from another compatible machine. Therefore you pay for the call.

Make sure that no documents are fed into your unit and that the other party's machine is ready for your call.

1 Press **MENU** repeatedly until the following is displayed.

Display: POLLING
PRESS SET

2 Press **SET**.

3 Dial the fax number.

Example: FAX=3331111

4 Press **SET**.

CONNECTING.....

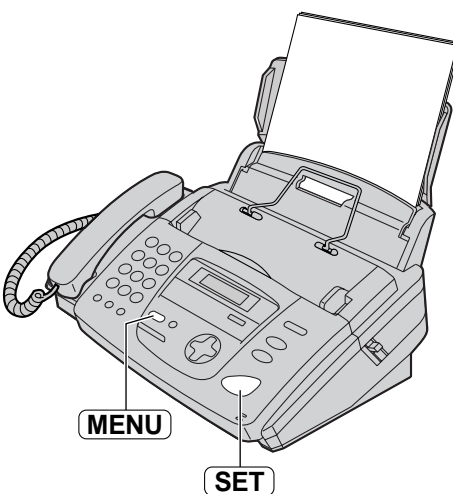

- The unit will start reception.

Receiving Faxes

Pager call

This feature allows your unit to call your pager when your unit receives the following:

- For KX-FP151: a fax document.
- For KX-FP155: a fax document or an incoming voice message.

1 Press **MENU**.

Display: SYSTEM SET UP
PRESS NAVI. [◀ ▶]

2 Press **⏏**, then **7 0**.

KX-FP151: FAX PAGER CALL
=OFF [±]

KX-FP155: PAGER CALL
=OFF [±]

3 Press **+** or **-** to select "ON".

KX-FP151: FAX PAGER CALL
=ON [±]

KX-FP155: PAGER CALL
=ON [±]

- If this feature is not required, select "OFF".

4 Press **SET**.

NO. =

5 Enter your pager number.

- You can enter a total of 46 digits and/or pauses.

Example:

1 202 555 1234PP12345678PP5555#

Your pager
number

Pauses

Your pager access
code, if required.

Message you want
displayed on your pager.

6 Press **SET**.

- The unit will dial the stored number.

PAGER TEST

7 Check that your pager received the pager test call.

8 Press **MONITOR** (KX-FP151)/
DIGITAL SP-PHONE (KX-FP155).

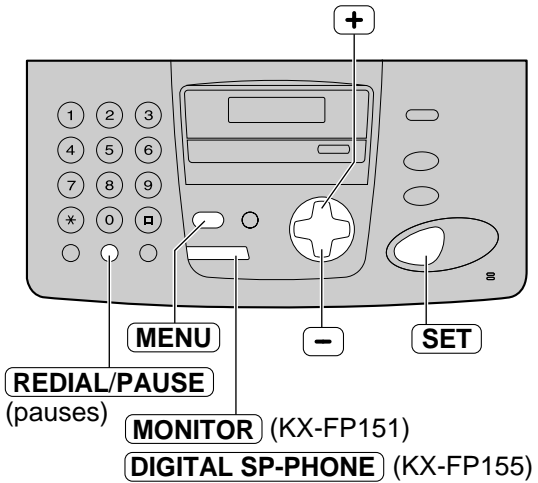

When your pager receives a pager call

Your pager will display the message you entered in step 5. (For example: 5555)

Copying

Making a copy

The unit can make single or multiple copies (up to 50).

1 Adjust the width of the document guides to the size of the document.

2 Insert the document (up to 10 pages) **FACE DOWN** until a single beep is heard and the unit grasps the document.

Display: STANDARD
PRESS NAVI. [+ -]

- If necessary, press **+** or **-** repeatedly to select the desired resolution (see below).
- Make sure the handset is on the cradle.

3 Press **COPY**.

NUMBER=1
COPY:PRESS START



NUMBER=1
OR PRESS NAVI. ▶

- If necessary, enter the number of copies (up to 50).

4 Press **START**.

- The unit will start copying.

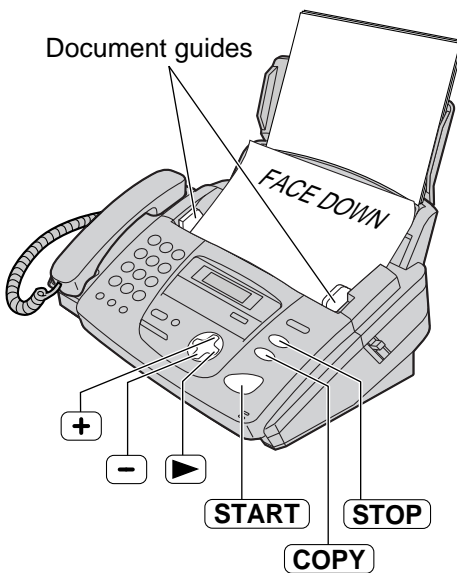

Note:

- Any transmittable document can be copied (p. 31).

To select the resolution

Select the desired resolution according to the type of document.

- **FINE**: For printed or typewritten originals with small printing.
- **SUPER FINE**: For originals with very small printing.
- **PHOTO**: For originals containing photographs, shaded drawings, etc.

- If you select "STANDARD", copying will be done using "FINE" mode.
- You can also select the resolution after pressing **COPY** in step 3.

1. Press **▶** 3 times.

Display: STANDARD [+ -]
<NUMBER>▶

2. Press **+** or **-** repeatedly to select the desired resolution.

Quick scan feature

This feature is helpful when you want to copy the document, then take it for other uses. To use this feature, activate feature #34 on page 65.

- The document will be fed into the unit and scanned into memory. The unit will then print the data.
If the document exceeds the memory capacity (p. 81), copying will be cancelled and this feature will be turned off automatically.

To stop copying

Press **STOP**.

Copying

To enlarge a document

1. Press after step 3 on page 46.

Display: ZOOM 100% [+ -]
<COLLATE>>

2. Press to select "150%" or "200%", then press **START**.
 - The unit will only enlarge the centremost part of the document, printing it on two pages.

Example of a 150% enlarged copy

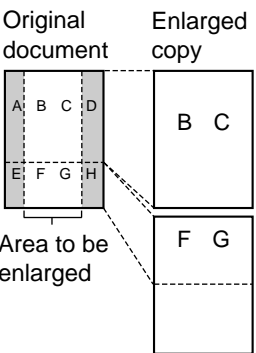

Example of a 200% enlarged copy

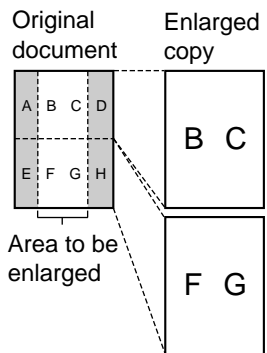

To reduce a document

1. Press after step 3 on page 46.

Display: ZOOM 100% [+ -]
<COLLATE>>

2. Press to select "92%", "86%" or "72%", then press **START**.
 - See the right table for the recommended reduction rates.

Setting	Recording paper	Original document
100% (default)	A4	A4, Letter
92%	A4	A4
86%	A4	A4
72%	A4	Legal

A4 = 210 mm x 297 mm
 Letter = 216 mm x 279 mm
 Legal = 216 mm x 356 mm

Note:

- If the appropriate reduction rate is not selected, the document may be divided and the top of the second sheet will be deleted.
- If the image at the bottom of the document is not copied when you copy a document as long as the recording paper, try 92% or 86%.

To collate multiple copies

The unit can collate multiple copies in the same order as the original document pages.

1. Press 2 times after step 3 on page 46.

Display: COLLATE OFF [+ -]
<RESOLUTION>>

2. Press or repeatedly until the following is displayed.

COLLATE ON [+ -]
<RESOLUTION>>

3. Press **START**.

Note:

- The unit will store the documents into memory while collating the copies. If memory becomes full while storing, the unit will only print out the stored pages.
- After copying, the collating feature will turn off automatically.

Example: Making two copies of a 4-page original document

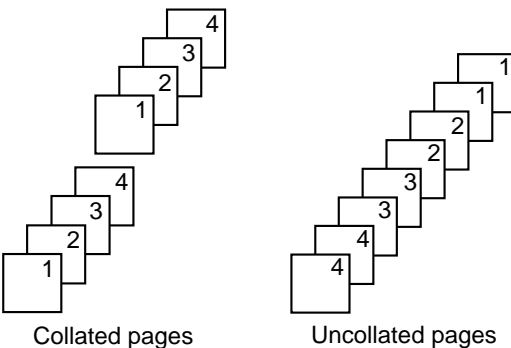

Setup (KX-FP155 only)

TAD/FAX mode (receiving phone calls and faxes automatically)

When TAD/FAX mode is set, the unit will work as a fax machine and/or answering device. If a fax tone is detected, the unit will automatically receive the fax. If a phone call is detected, the answering device will play a greeting message and the caller can leave a voice message.

Setting up the voice and fax message reception

- 1 Make sure that feature #77 is set to "TAD/FAX" (p. 70).
- 2 If the arrow (▼) is not shown on the right of the display, turn it on by pressing **AUTO ANSWER**.

Display: TAD/FAX MODE

- The unit will play the pre-recorded greeting message.
- The remaining time for recording incoming messages will be displayed.

Example: TIME = 10m13s

- You can change the speaker volume. Press **+** or **-** while listening to the greeting message.

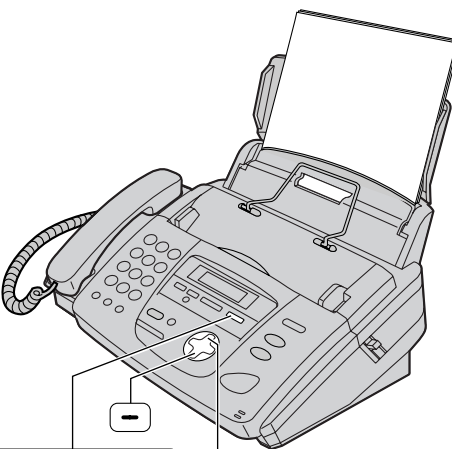

AUTO ANSWER **+** **-**

Ring setting in TAD/FAX mode

You can choose from 1, 2, 3, 4, TOLL SAVER and RINGER OFF. This setting can be changed by feature #06 on page 62.

TOLL SAVER: When you call the unit from a remote location, the number of rings will tell you if there are any new voice messages. If the unit answers on the 2nd ring, there is at least one new recorded message. If the unit answers on the 4th ring, there are no new recorded messages. To save the toll charges for the call, hang up immediately when you hear the 3rd ring. The 3rd ring indicates that there are no new recorded messages.

RINGER OFF: The unit will answer without ringing.

- If you subscribe to a Caller ID service, set to 2 or more rings.

Note:

- The incoming message recording time can be changed (feature #10 on page 63).
- When the remaining time is low, erase unnecessary messages (p. 52). For the voice memory capacity for incoming messages, see page 81.
- While an incoming call is being recorded, you can monitor it through the speaker. If this feature is not required, set feature #67 to off (p. 69).

Greeting (KX-FP155 only)

Recording your own greeting messages

You can record your own greeting messages for TAD/FAX and TEL/FAX modes. When receiving a call, your own greeting message will be played instead of the pre-recorded message. The recording time will be limited to 16 seconds. We recommend you record your message within 12 seconds to make it easier to receive faxes.

Suggested messages:

- TAD/FAX greeting message: *"This is (your name, business and/or telephone number). We are unable to answer right now. To send a fax, start transmission. To leave a message, speak after the beep. Thank you."*
- TEL/FAX greeting message: *"This is (your name, business and/or telephone number). We are unable to answer right now. Please try again later. Thank you."*

1 Set the desired mode (TAD/FAX or TEL/FAX) where you want to record a greeting message (feature #77 on page 70) beforehand.

2 Press **RECORD** 2 times.

- The display will show the following according to your selection in step 1.

TAD/FAX mode:

TAD GREETING PRESS SET

TEL/FAX mode:

TEL/FAX GREETING PRESS SET

3 Press **SET**.

- A long beep will sound.

4 Speak clearly about 20 cm away from the microphone.

- The display will show the remaining recording time.

TAD/FAX mode:

TAD	REC.	15s
-----	------	-----

TEL/FAX mode:

T/F	REC.	15s
-----	------	-----

5 When finished recording, press **STOP**.

- The unit will repeat your message. Adjust the volume using **+** or **-**.

Note:

- You can choose 60 seconds for your own TAD/FAX greeting message (feature #54 on page 68).
 - If you change to 60 seconds, we recommend that you tell the caller in your own TAD/FAX greeting message to press * 9 before starting fax transmission.
 - If you change to 16 seconds from 60 seconds, your own recorded TAD/FAX greeting message will be deleted. When receiving a call, the pre-recorded message will be played.

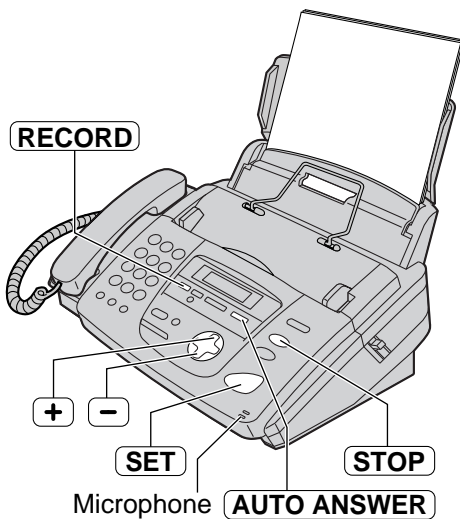

Checking the greeting messages

1. Set the desired mode (TAD/FAX or TEL/FAX) for the greeting message you want to listen to (feature #77 on page 70) beforehand.
2. If the arrow (▼) is not shown on the right of the display, turn it on by pressing **AUTO ANSWER**.

If the arrow (▼) is shown on the right of the display, turn it off once then on again.

- The display will show the following according to your selection in step 1.

TAD/FAX mode:

TAD/FAX MODE

TEL/FAX mode:

TEL/FAX MODE

- The unit will play the greeting message.

Greeting (KX-FP155 only)

Erasing your own recorded greeting messages

1 Set the desired mode (TAD/FAX or TEL/FAX) for the greeting message you want to erase (feature #77 on page 70) beforehand.

2 Press **ERASE** 2 times.

- The display will show the following according to your selection in step 1.

TAD/FAX mode:

TAD GREETING PRESS SET

TEL/FAX mode:

TEL/FAX GREETING PRESS SET

3 Press **SET**.

ERASE GREETING? YES: SET/NO: STOP

- To cancel erasing, press **STOP**.

4 Press **SET**.

GREETING ERASED

- When receiving a call, the pre-recorded greeting message will be played.

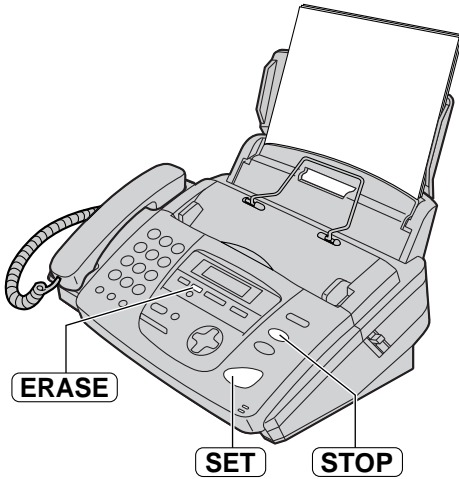

Memo Message (KX-FP155 only)

Leaving a message for others or yourself

To leave a private message for yourself or someone else, you can record a voice memo. This memo can be played back later, either directly or remotely.

1 Press **RECORD**.

Display:

MEMO MESSAGE PRESS SET

2 Press **SET**.
• A long beep will sound.

MEMO RECORDING

3 Speak clearly about 20 cm away from the microphone.

4 When finished recording, press **STOP**.



Incoming Messages (KX-FP155 only)

Listening to recorded messages

When the unit has recorded new voice messages:

- the MESSAGE indicator will flash,
- the call counter will show the total number of recorded messages, and
- slow beeps will sound if the message alert feature is activated (feature #42 on page 65).

Example:

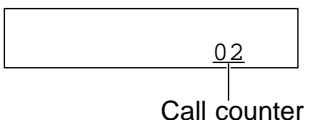

Press **PLAY MESSAGES**.

- Only the new recorded messages will be played.
- Adjust the speaker volume using **+** or **-**.
- After playing back all of the new messages, the MESSAGE indicator will stop flashing but will remain lit up.

If you press **PLAY MESSAGES** at this time, all the recorded messages will be played.

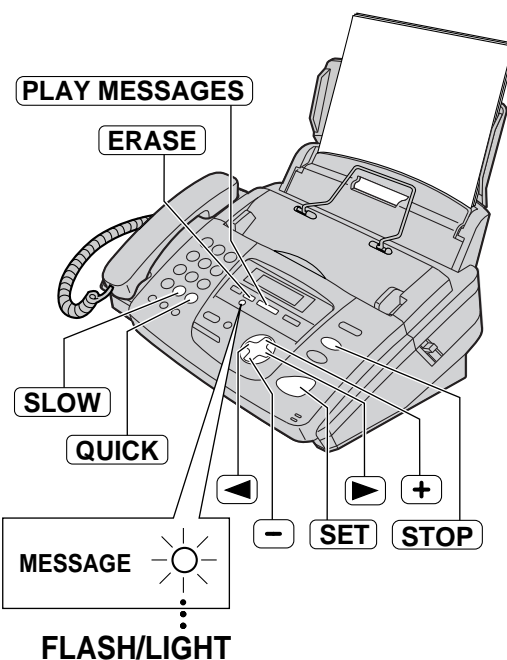

To repeat a message

Press **◀** while listening to the message.

- If you press **◀** within 5 seconds of the beginning of the message, the previous message will be played.
- To play back a specific message, press **◀** or **▶** and search for the message you want to listen to.

To skip a message

Press **▶** to play the next message.

To stop playback

Press **STOP**.

- If you press **PLAY MESSAGES** within 1 minute, the unit will resume playing the rest of the messages.

Voice time/day stamp

During playback, a synthesized voice will announce the time and day of the week that each message was recorded.

To change the playback speed

Press **QUICK** to play messages at one and a half times the original speed.

Press **SLOW** to play messages at half the original speed.

- To return to the original speed, press **QUICK** or **SLOW** again during quick or slow playback.

To erase a specific message

Press **ERASE** while listening to the message you want to erase.

To erase all the messages

Check that you have listened to all of the recorded messages.

1. Press **ERASE**.

Display: ALL MESSAGES
PRESS SET

2. Press **SET**.

ERASE MESSAGES?
YES:SET/NO:STOP

3. Press **SET**.

- Messages recorded in voice mailbox will not be erased.

Remote Operation (KX-FP155 only)

Operating from a remote location

The following operations can be performed from a remote location using a touch tone telephone. **Program the remote operation ID (feature #11 on page 63) and set the unit to TAD/FAX mode before going out (p. 48).**

Dial key	Remote command	Page	Dial key	Remote command	Page
0	Skips the greeting message	55	*4	Erases a specific message	55
1	Repeats a message	54	*5	Erases all messages	55
2	Skips a message	54	80	Changes to TEL mode	55
4	New message playback	54	81	Turns ON message transfer	55
5	All message playback	54	82	Turns OFF message transfer	55
7	Re-records a greeting message	55	83	Turns ON pager call	55
8	Continues operation	See note	84	Turns OFF pager call	55
9	Stops re-recording of a greeting message	55			

Note:

- During remote operation, the unit will stop and two beeps will be heard in the following conditions:
 - 2 minutes 40 seconds after your unit answered.
 - Every 2 minutes 40 seconds after pressing any command key.
- To listen to further messages, press **8** within 10 seconds after hearing the two beeps.

Remote operation card

Please cut out and carry this card for assistance when using the remote operation.

Mailbox Remote Operation	Notice of Remote Operation
<p>■ Recording a message in a mailbox:</p> <ol style="list-style-type: none"> 1. Call your unit. 2. Press * and the mailbox no. (1 or 2). 3. Leave a message. <p>■ Retrieving messages from a mailbox:</p> <ol style="list-style-type: none"> 1. Call your unit. 2. Press * and the mailbox no. (1 or 2). 3. Enter the mailbox password <input type="text"/> <input type="text"/>. 4. Press the remote command key (see the reverse side). <ul style="list-style-type: none"> • 81, 82, 83 and 84 cannot be used. 	<ul style="list-style-type: none"> • The remote operation is available only from a touch tone telephone when the unit is in TAD/FAX mode. • When the unit is in TEL mode, call your unit and wait for 10 rings. Enter the remote operation ID within 8 seconds and wait for 3 seconds. The unit will switch to TAD/FAX mode. • When you press a key, press firmly. • To send a document, press *9. When a fax tone is heard, start transmission.

Fold here

Remote Operation (KX-FP155 only)

Listening to recorded messages

1 Call your unit from a remote touch tone telephone.

2 Enter the remote operation ID during TAD/FAX greeting playback.

■ **When there are new messages**

The voice guide will tell you the number of new messages and they will be played automatically.

Voice guide example:

3 new messages.

● **To repeat a message:**

Press **1**.

If you press **1** within 5 seconds of the beginning of a message, the previous message will be played.

● **To skip a message:**

Press **2**.

● **To repeat only the new messages:**

Press **4**.

● **To listen to all the messages:**

Press **5**.

■ **When there are no new messages**

No new messages.

Press **5** or wait for 4 seconds to listen to all the messages.

■ **When voice memory is full**

*Sorry, no more memory.
Please erase unnecessary messages.*

Erase some or all of the messages (p. 55).

Answering Device Remote Operation

1. Call your unit.
2. Enter the remote operation ID during the greeting message.
 - The new messages will be played automatically.
 - If there are no new messages, wait for 4 seconds. All the messages will be played back.
3. Press the remote command key(s) within 10 seconds.

Key	Remote command
0	Skips the greeting message
1	Repeats a message
2	Skips a message

Key	Remote command
4	New message playback
5	All message playback
7	Re-records a greeting message
8	Continues operation
9	Stops re-recording of a greeting message
* 4	Erases a specific message
* 5	Erases all messages
8 0	Changes to TEL mode
8 1	Turns ON message transfer
8 2	Turns OFF message transfer
8 3	Turns ON pager call
8 4	Turns OFF pager call

Remote Operation (KX-FP155 only)

Other remote operations

■ Erasing a specific message

Press **[*]4** while listening to the message you want to erase.

Voice guide example:

The message has been erased.

- A long beep will sound. The unit will then play back the next message.

■ Erasing all the messages

Press **[*]5** to erase all the messages.

All messages have been erased.

- A long beep will sound.

■ Recording a marker message

You can leave an additional message.

1. Wait for the voice guide.

All messages have been played.

2. Wait about 10 seconds.

Please leave your name and message after the beep.

3. Leave a message after the beep.

■ Re-recording a greeting message

You can change the contents of the greeting messages for TAD/FAX mode.

1. Press **[7]** to start recording.
 - A long beep will sound.
2. Speak clearly up to 16 seconds.
 - If you pause for over 2 seconds, 6 beeps will sound and the recording will stop. Repeat from step 1 within 10 seconds.
3. When finished recording, press **[9]**.
 - The new greeting message will be played.

■ Skipping the greeting message

Press **[0]** during the greeting message playback.

- The unit will skip the rest of the greeting message.

■ Turning the message transfer on or off

You must pre-program a transfer telephone number beforehand (feature #60 on page 68).

Press **[8]1** to turn ON the message transfer.

*Message transfer is set.
Transfer phone number is 123...*

Press **[8]2** to turn OFF the message transfer.

Message transfer is off.

- If a transfer telephone number is not programmed, you cannot turn this feature ON.

Transfer phone number is not set.

■ Turning the pager call on or off

You must program a pager number beforehand (feature #70 on page 69).

Press **[8]3** to turn ON the pager call.

*Pager call is set.
Pager number is 098765432.*

Press **[8]4** to turn OFF the pager call.

Pager call is off.

- If a pager number is not programmed, you cannot turn this feature ON.

Pager number is not set.

■ Changing the receive mode

Press **[8]0** to change the receive mode from TAD/FAX to TEL.

- You cannot return to TAD/FAX mode in the same call. To return to TAD/FAX mode, see page 38.

Voice Mailbox (KX-FP155 only)

How callers can leave you private messages

This unit has two mailbox memories. Your caller can leave a private message in a specific mailbox. Only the person who knows the password can retrieve a message from a mailbox. This feature is useful when you share this unit with other people.

To use a mailbox

1. Record your own TAD/FAX greeting message (p. 49).
Suggested message: *"This is (your name). We are unable to answer right now. To send a fax, start transmission. To leave a message, speak after the beep. To leave a private message, press [*] and the desired mailbox number 1 or 2. Thank you."*
2. Record your own mailbox greeting message if necessary (p. 57).
Suggested message: *"This is (personal name). Please leave your name and message after the beep."*
3. Change the mailbox password if necessary.
 - For mailbox 1 password, see feature #51 on page 67.
 - For mailbox 2 password, see feature #52 on page 67.
4. Set the unit to TAD/FAX mode (p. 48).

How incoming messages are recorded in a mailbox

- 1 Call your unit from a remote touch tone telephone.
 - The TAD/FAX greeting message will be played.
- 2 Press [*] and the desired mailbox number (1 or 2).
 - A mailbox greeting message will be played.
- 3 After the beep, leave a message.

Note:

- If the caller does not enter the mailbox number in step 2, the message will be recorded in the common memory.

Voice Mailbox (KX-FP155 only)

Recording your own mailbox greeting messages

The recording time is limited to 16 seconds for each mailbox.

Suggested message: "This is (personal name). Please leave your name and message after the beep."

1 Press **MENU**.

Display: SYSTEM SET UP
PRESS NAVI. [◀ ▶]

2 For mailbox 1:
Press **☎**, then **5 5**.

BOX1 GREETING
CHECK [±]

For mailbox 2:
Press **☎**, then **5 6**.

BOX2 GREETING
CHECK [±]

3 Press **+** or **-** to select "RECORD".

Example: BOX1 GREETING
RECORD [±]

4 Press **SET**.

Example: BOX1 REC. 16s

5 Speak clearly about 20 cm away from the microphone.

- The display will show the remaining recording time.

Example: BOX1 REC. 15s

6 When finished recording, press **STOP**.

- The unit will repeat your message. Adjust the volume using **+** or **-**.

7 Press **MENU**.

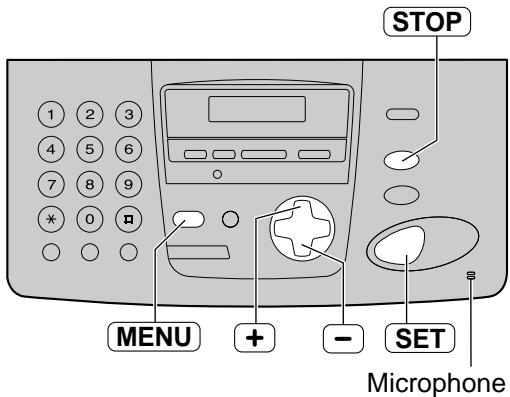

To check the mailbox greeting message

1. For mailbox 1

Press **MENU**, **☎ 5 5**.

For mailbox 2

Press **MENU**, **☎ 5 6**.

2. Press **+** or **-** to select "CHECK".

3. Press **SET**.

- The unit will play the message.

4. Press **MENU**.

To erase your own mailbox greeting message

1. For mailbox 1

Press **MENU**, **☎ 5 5**.

For mailbox 2

Press **MENU**, **☎ 5 6**.

2. Press **+** or **-** to select "ERASE".

3. Press **SET**.

- Your own message will be erased.

4. Press **MENU**.

Voice Mailbox (KX-FP155 only)

Listening to recorded messages

- 1** Press **▶** 2 times.

Display: MAILBOX [+ -]

- 2** Press **+** or **-** until the desired mailbox number is displayed.

Example: NEW MESSAGES
MAILBOX2 [±] 02



PRESS
REC/ERASE/PLAY

- 3** Press **▶** **PLAY MESSAGES**.

If you have programmed your own mailbox password, enter it.

PASSWORD=

- Only the new recorded messages will be played.
- If there are no new messages, the unit will play back all the recorded messages.

- 4** Press **■** **STOP** to end the operation.

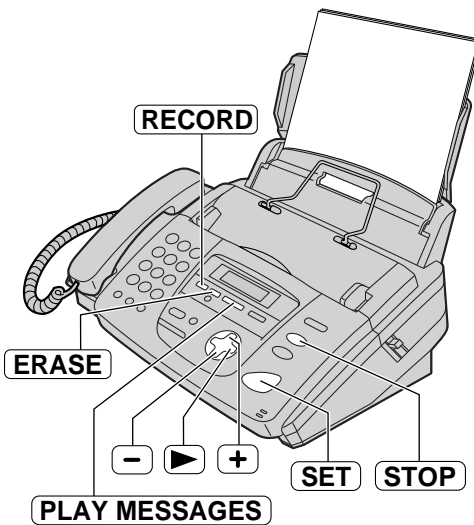

Note:

- The following features can be used during playback. See page 52 for details.
 - To repeat a message
 - To skip a message
 - To stop playback
 - To change the playback speed
 - To erase a specific message

To record a memo message into a mailbox

- 1.** Press **▶** 2 times.

Display: MAILBOX [+ -]

- 2.** Press **+** or **-** until the desired mailbox number is displayed.

Example: MAILBOX1 [±] 00



PRESS
REC/ERASE/PLAY

- 3.** Press **■** **RECORD**.

- A long beep will sound.

Example: BOX1 RECORDING

- 4.** Speak clearly about 20 cm away from the microphone.

- 5.** When finished recording, press **■** **STOP**.

To erase all the messages in a mailbox

- 1.** Press **▶** 2 times.

- 2.** Press **+** or **-** until the desired mailbox number is displayed.

Example: MAILBOX1 [±] 01



PRESS
REC/ERASE/PLAY

- 3.** Press **■** **ERASE**.

BOX1 ERASE OK?
YES:SET/NO:STOP

- 4.** Press **■** **SET**.

Voice Mailbox (KX-FP155 only)

Listening to recorded messages from a remote location

- 1 Call your unit from a remote touch tone telephone.
- 2 Press ***** and the desired mailbox number (**1** or **2**) during TAD/FAX greeting playback.
 - If you have recorded your own mailbox greeting message, it will be played.
- 3 Enter the mailbox password (default setting "555").
 - If you have programmed your own mailbox password, enter it instead of "555".

Note:

- For details on remote operation, see pages 53–55. **81**, **82**, **83**, and **84** cannot be used.

To listen to messages in another memory after playback

Press ***** and **0** (for the common memory), then enter the remote operation ID.

or

Press ***** and the desired mailbox number (**1** or **2**), then enter the mailbox password.

Option (KX-FP155 only)

Transferring recorded messages to another telephone

This feature allows your unit to call a designated telephone number each time an incoming voice message is recorded. You can retrieve the transferred message during the same call using the remote operation.

To use this feature, program the transfer telephone number first (feature #60 on page 68) and set the unit to TAD/FAX mode.

1. An incoming voice message is recorded in your unit.
2. Your unit calls the transfer telephone number.
3. Answer the call with the transfer telephone.
4. Your unit will play the transfer greeting message.
 - This message can be changed (see below).
5. Enter the remote operation ID (feature #11 on page 63).
6. Retrieve the message using the remote operation (p. 53–55).

Pre-recorded message:

This is a telephone answering system. Please enter your remote ID for remote operation.

Recording your own transfer greeting message

The recording time is limited to 16 seconds.

Suggested message: "This is a transferred message from (your name, business and/or telephone number). Please enter your remote ID for remote operation."

- 1** Press **MENU**.

Display: SYSTEM SET UP
PRESS NAVI. [◀ ▶]

- 2** Press **⏏**, then **6 1**.

TRNS-GREETING
CHECK [±]

- 3** Press **+** or **-** to select "RECORD".

TRNS-GREETING
RECORD [±]

- 4** Press **SET**.

- 5** Speak clearly about 20 cm away from the microphone.

- The display will show the remaining recording time.

Example: TRNS REC. 15s

- 6** When finished recording, press **STOP**.

- The unit will repeat your message. Adjust the volume using **+** or **-**.

- 7** Press **MENU**.

To check the transfer greeting message

1. Press **MENU**, **⏏ 6 1**.
2. Press **+** or **-** to select "CHECK".
3. Press **SET**.
 - The unit will play the message.
4. Press **MENU**.

To erase your own transfer greeting message

1. Press **MENU**, **⏏ 6 1**.
2. Press **+** or **-** to select "ERASE".
3. Press **SET**.
 - Your own message will be erased.
4. Press **MENU**.
 - When transferring a call, the pre-recorded transfer greeting message will be played.

Features Summary

Programming

The unit provides various programming features. Program the desired settings by referring to the programming tables (p. 62–70).

General programming method

1 Press **MENU**.

Display: SYSTEM SET UP
PRESS NAVI. [◀ ▶]

2 Select the feature you wish to program.

For basic features (p. 62, 63):

Press **◀** or **▶** until the desired feature is displayed.

For advanced features (p. 64–70):

Press **◀** or **▶** until the following is displayed:

ADVANCED MODE
PRESS SET

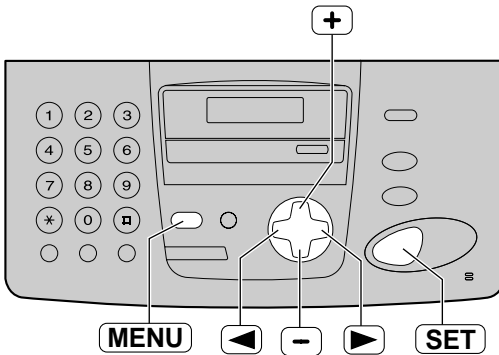

then press **SET** and press **◀** or **▶** until the desired feature is displayed.

- The current setting of the feature will be displayed.

3 Press **+** or **-** until the desired setting is displayed.

- This step may be slightly different depending on the feature.

4 Press **SET**.

- The setting you selected is set, and the next feature will be displayed.

5 To exit programming, press **MENU**.

Programming by entering the program code number directly

You can select a feature by directly entering the program code (# and 2-digit number) instead of using **◀** or **▶** in step 2.

1. Press **MENU**.

2. Press **■** and the 2-digit code number.

3. Follow steps 3 to 5 above.

- See programming tables for code numbers (p. 62–70).

To cancel programming

Press **MENU** to exit the program.

Features Summary

Basic features

How to set menu options

1. Press **MENU**.
2. Press **◀** or **▶** until the desired feature is displayed.

3. Press **+** or **-** until the desired setting is displayed.

4. Press **SET**.
5. Press **MENU**.

Note:

- Step 3 may be slightly different depending on the feature.
- See page 61 for more details.

Programming table

Code	Feature & Display	Settings	How the unit operates
#01	Setting the date and time SET DATE & TIME PRESS SET		See page 17 for details.
#02	Setting your logo YOUR LOGO PRESS SET	(Up to 30 characters)	See page 18 for details.
#03	Setting your facsimile telephone number YOUR FAX NO. PRESS SET	(Up to 20 digits)	See page 20 for details.
#04	Printing the sending report SENDING REPORT =ERROR [±] To print and check the sending report for fax transmission results (p. 31).	ERROR	"ERROR": The sending report will be printed only when fax transmission fails.
		ON	"ON": The sending report will be printed out after every transmission.
		OFF	
#06	■ For KX-FP151 only: Changing the number of rings before the unit answers a call in FAX ONLY mode FAX RING COUNT RINGS=2 [±]	1, 2, 3, 4, 5, 6, 7, 8, 9	If you are using the unit with an answering machine, set to more than 4 (p. 42).
#06	■ For KX-FP155 only: Changing the number of rings before the unit answers a call in TAD/FAX mode TAD RING COUNT RINGS=2 [±]	1, 2, 3, 4	This setting can be changed when the unit is in TAD/FAX mode. See page 48 for details.
		TOLL SAVER	
		RINGER OFF	
#06	■ For KX-FP155 only: Changing the number of rings before the unit answers a call in FAX ONLY mode FAX RING COUNT RINGS=2 [±]	1, 2, 3, 4, 5, 6, 7, 8, 9	This setting can be changed when the unit is in FAX ONLY mode.

(The default setting is in bold type.)

Features Summary

Code	Feature & Display	Settings	How the unit operates
#10	■ For KX-FP155 only: Changing the incoming message recording time <div style="border: 1px solid black; padding: 2px; width: fit-content;"> RECORDING TIME =VOX [±] </div>	VOX	“VOX”: Unlimited “1–9”: 1 minute to 9 minutes
		1, 2, 3, 4, 5 6, 7, 8, 9	
#11	■ For KX-FP155 only: Setting the remote operation ID <div style="border: 1px solid black; padding: 2px; width: fit-content;"> REMOTE TAD ID =ON [±] </div>	ON / ID=111	To select “ON” and enter ID: 1. Press MENU . 2. Press ◀ or ▶ and select this feature. 3. Press + or - to select “ON”. 4. Press SET . 5. Enter any 3-digit number except a number using 0 or 7. 6. Press SET . 7. Press MENU .
		OFF	
#17	Setting the ringer pattern <div style="border: 1px solid black; padding: 2px; width: fit-content;"> RINGER PATTERN =A [±] </div>	A	You can select the ringer pattern. The selected ringer pattern will sound during setting.
		B	
		C	

(The default setting is in bold type.)

Features Summary

Advanced features

How to set menu options

1. Press **MENU**.
2. Press **◀** or **▶** until the following is displayed:

```
ADVANCED MODE
PRESS SET
```

then press **SET** and press **◀** or **▶** until the desired feature is displayed.

3. Press **+** or **-** until the desired setting is displayed.
4. Press **SET**.
5. Press **MENU**.

Note:

- Step 3 may be slightly different depending on the feature.
- See page 61 for more details.

Programming table

Code	Feature & Display	Settings	How the unit operates
#22	Setting the journal report to print automatically AUTO JOURNAL =ON [±]	ON	"ON": The unit will print the journal report automatically after every 30 new fax communications (p. 31).
		OFF	
#23	Sending document overseas OVERSEAS MODE =OFF [±] If you have difficulty sending an overseas fax, activate this feature before starting transmission. This feature makes sending documents easier as the transmission speed is slowed down.	ON	After transmission, this feature will turn off automatically. <ul style="list-style-type: none"> • This feature is not available for broadcast transmission. • The calling charge may be higher.
		OFF	
#25	Sending a fax at a specific time DELAYED SEND =OFF [±] This feature allows you to take advantage of low-cost calling hours offered by your telephone company. <ul style="list-style-type: none"> • The setting can be reserved to take place up to 24 hours in advance. 	ON / fax no. / hh:mm	To send a document: <ol style="list-style-type: none"> 1. Insert the document. 2. Follow steps 1 and 2 above. 3. Press + or - to select "ON". 4. Press SET. 5. Enter the fax number. 6. Press SET. 7. Enter the transmission start time. Press * to select "AM" or "PM". 8. Press SET. 9. Press MENU. <ul style="list-style-type: none"> • To cancel after programming, press STOP then SET.
		OFF	
#26	Setting the Caller ID list to print automatically AUTO CALL. LIST =ON [±]	ON	"ON": The unit will print the Caller ID list automatically after every 30 new calls (p. 25).
		OFF	

(The default setting is in bold type.)

Features Summary

Code	Feature & Display	Settings	How the unit operates															
#30	<p>Changing the number of rings when the unit detects a phone call in TEL/FAX mode (silent fax recognition ring setting)</p> <div style="border: 1px solid black; padding: 2px;"> SILENT FAX RING RINGS=3 [±] </div>	3, 4, 5, 6, 7, 8, 9	See pages 40 and 41 for details.															
#34	<p>Setting the quick scan</p> <div style="border: 1px solid black; padding: 2px;"> QUICK SCAN =OFF [±] </div> <p>To scan the document into memory before sending/copying. This is helpful when you want to remove the document for other uses.</p>	ON	<p>“ON”: The unit will store the documents first and release them.</p> <ul style="list-style-type: none"> If the document exceeds the memory capacity (p. 81), sending/copying will be cancelled and this feature will be turned off automatically. 															
		OFF																
#36	<p>Receiving other size documents</p> <div style="border: 1px solid black; padding: 2px;"> RCV REDUCTION =92% [±] </div> <p>If the size of the document sent by the other party is as large as, or larger than the recording paper, the unit can reduce and print the document. Select the desired reduction rate.</p>	100%	<table border="1" style="font-size: small;"> <thead> <tr> <th>Setting</th> <th>Recording paper</th> <th>Original document</th> </tr> </thead> <tbody> <tr> <td>100%</td> <td>A4</td> <td>Letter</td> </tr> <tr> <td>92%</td> <td>A4</td> <td>A4</td> </tr> <tr> <td>86%</td> <td>A4</td> <td>A4</td> </tr> <tr> <td>72%</td> <td>A4</td> <td>Legal</td> </tr> </tbody> </table> <ul style="list-style-type: none"> If most of document sent from the other party are as long as your recording paper and they have a long heading using a few lines, we recommend selecting 86%. 	Setting	Recording paper	Original document	100%	A4	Letter	92%	A4	A4	86%	A4	A4	72%	A4	Legal
		Setting		Recording paper	Original document													
		100%		A4	Letter													
		92%		A4	A4													
86%	A4	A4																
72%	A4	Legal																
92%																		
86%																		
72%																		
#39	<p>Changing the display contrast</p> <div style="border: 1px solid black; padding: 2px;"> LCD CONTRAST =NORMAL [±] </div>	NORMAL	<p>“NORMAL”: For normal contrast “DARKER”: Used when the display contrast is too light.</p>															
		DARKER																
#41	<p>Changing the fax activation code</p> <div style="border: 1px solid black; padding: 2px;"> FAX ACTIVATION =ON [±] </div> <p>If you use an extension telephone and wish to use it to receive a fax, activate this feature, and enter the code (p. 44).</p> <ul style="list-style-type: none"> This code is also used to receive a voice message and a fax in the same call (p. 43)(KX-FP151 only). 	ON / CODE= * 9	<ol style="list-style-type: none"> Follow steps 1 and 2 on page 64. Press + or - to select “ON”. Press SET. Enter your code from 2 to 4 digits, using 0–9 and *. Press SET. Press MENU. <ul style="list-style-type: none"> Do not enter “0000”. 															
		OFF																
#42	<p>■ For KX-FP155 only: Setting the message alert</p> <div style="border: 1px solid black; padding: 2px;"> MESSAGE ALERT =OFF [±] </div> <p>To alert you with beeps when a new voice message is recorded.</p>	ON	<p>If you hear slow beeps, press PLAY MESSAGES and listen to recorded messages (p. 52). The beeps will stop.</p>															
		OFF																

(The default setting is in bold type.)

Features Summary

Advanced features (cont.)

How to set menu options

1. Press **MENU**.
2. Press **◀** or **▶** until the following is displayed:
3. Press **+** or **-** until the desired setting is displayed.
4. Press **SET**.
5. Press **MENU**.

```

ADVANCED MODE
PRESS SET
    
```

then press **SET** and press **◀** or **▶** until the desired feature is displayed.

Note:

- Step 3 may be slightly different depending on the feature.
- See page 61 for more details.

Programming table (cont.)

Code	Feature & Display	Settings	How the unit operates
#43	■ For KX-FP155 only: Setting the recording time alert <div style="border: 1px solid black; padding: 2px; margin: 5px 0;"> REC. TIME ALERT =OFF [±] </div> To alert you with beeps when there is less than 60 seconds of remaining recording time.	ON	If you hear slow beeps, erase the recorded messages (p. 52, 58). The beeps will stop.
		OFF	
#44	Setting the memory reception alert <div style="border: 1px solid black; padding: 2px; margin: 5px 0;"> RECEIVE ALERT =ON [±] </div> To alert you with a beeping sound when a document which has been received is stored into memory due to some existing problem.	ON	If you are alerted by a slow beeping sound, clear the printing problem and make sure the unit is supplied with enough paper to print the stored document. The beeps will stop.
		OFF	
#46	Setting the friendly reception <div style="border: 1px solid black; padding: 2px; margin: 5px 0;"> FRIENDLY RCV =ON [±] </div> To receive a fax automatically when you answer a call and hear a fax calling tone (slow beep).	ON	"ON": You do not have to press FAX/START for fax reception.
		OFF	

(The default setting is in bold type.)

Features Summary

Code	Feature & Display	Settings	How the unit operates
#47	<p>■ For KX-FP155 only: Setting the fax voice guidance</p> <div style="border: 1px solid black; padding: 2px; width: fit-content;"> FAX GUIDANCE =ON [±] </div> <p>If you wish to hear the voice guidance (see right) at each fax transmission/reception, set this feature to "ON".</p> <ul style="list-style-type: none"> To hear the voice guidance only when fax transmission/reception fails, select "ERROR". 	ON	Voice guidance examples: "Start transmission." "Transmission is complete." "Transmission has failed."
		OFF	"Transmission has been interrupted." "Start reception." etc.
		ERROR	
#49	<p>■ For KX-FP151 only: Setting the auto disconnection</p> <div style="border: 1px solid black; padding: 2px; width: fit-content;"> AUTO DISCONNECT =ON [±] </div> <p>To answer a call with an extension telephone in TEL/FAX mode (p. 41).</p>	ON / CODE= * 0	<ol style="list-style-type: none"> Follow steps 1 and 2 on page 66. Press [+] or [-] to select "ON". Press [SET]. Enter your code from 2 to 4 digits, using 0–9 and * .
		OFF	<ol style="list-style-type: none"> Press [SET]. Press [MENU].
#51	<p>■ For KX-FP155 only: Setting the mailbox 1 password</p> <div style="border: 1px solid black; padding: 2px; width: fit-content;"> BOX1 PASSWORD ID= </div> <p>If you wish to prevent other users from retrieving messages, program a password for mailbox 1.</p>	ID=555	<ol style="list-style-type: none"> Follow steps 1 and 2 on page 66. Enter a 3-digit number except a number using digits 0 or 7. Press [SET]. Press [MENU].
#52	<p>■ For KX-FP155 only: Setting the mailbox 2 password</p> <div style="border: 1px solid black; padding: 2px; width: fit-content;"> BOX2 PASSWORD ID= </div> <p>If you wish to prevent other users from retrieving messages, program a password for mailbox 2.</p>	ID=555	<ol style="list-style-type: none"> Follow steps 1 and 2 on page 66. Enter a 3-digit number except a number using digits 0 or 7. Press [SET]. Press [MENU].

(The default setting is in bold type.)

Features Summary

Advanced features (cont.)

How to set menu options

1. Press **MENU**.
2. Press **◀** or **▶** until the following is displayed:
3. Press **+** or **-** until the desired setting is displayed.
4. Press **SET**.
5. Press **MENU**.

```

ADVANCED MODE
PRESS SET
    
```

then press **SET** and press **◀** or **▶** until the desired feature is displayed.

Note:

- Step 3 may be slightly different depending on the feature.
- See page 61 for more details.

Programming table (cont.)

Code	Feature & Display	Settings	How the unit operates
#54	■ For KX-FP155 only: Changing the recording time for your own TAD/FAX greeting message <div style="border: 1px solid black; padding: 2px; margin-top: 5px;"> GREETING TIME =16s [±] </div>	16s	"16s": Up to 16 seconds "60s": Up to 60 seconds • See page 49 for details.
		60s	
#55	■ For KX-FP155 only: Greeting message for mailbox 1 (checking, recording or erasing) <div style="border: 1px solid black; padding: 2px; margin-top: 5px;"> BOX1 GREETING CHECK [±] </div>	CHECK	See page 57 for details.
		RECORD	
		ERASE	
#56	■ For KX-FP155 only: Greeting message for mailbox 2 (checking, recording or erasing) <div style="border: 1px solid black; padding: 2px; margin-top: 5px;"> BOX2 GREETING CHECK [±] </div>	CHECK	See page 57 for details.
		RECORD	
		ERASE	
#60	■ For KX-FP155 only: Setting the message transfer <div style="border: 1px solid black; padding: 2px; margin-top: 5px;"> MESSAGE TRANS. =OFF [±] </div> To transfer a recorded incoming message to another telephone (p. 60).	ON	<ol style="list-style-type: none"> 1. Follow steps 1 and 2 above. 2. Press + or - to select "ON". 3. Press SET. 4. Enter the transfer telephone number. 5. Press SET. 6. Press MENU. • This feature can be turned on/off from a remote location (p. 55).
		OFF	
#61	■ For KX-FP155 only: Transfer greeting message (checking, recording or erasing) <div style="border: 1px solid black; padding: 2px; margin-top: 5px;"> TRNS-GREETING CHECK [±] </div>	CHECK	See page 60 for details.
		RECORD	
		ERASE	

(The default setting is in bold type.)

Features Summary

Code	Feature & Display	Settings	How the unit operates
#67	<p>■ For KX-FP155 only: Setting the incoming message monitor</p> <div style="border: 1px solid black; padding: 2px; width: fit-content;"> ICM MONITOR =ON [±] </div> <p>To hear an incoming message (ICM) from the speaker when the answering device is recording the message.</p>	ON	If you select "OFF", you cannot monitor the incoming message.
		OFF	
#68	<p>Setting the Error Correction Mode (ECM)</p> <div style="border: 1px solid black; padding: 2px; width: fit-content;"> ECM SELECTION =ON [±] </div> <p>To send a fax even if there is static interference on the telephone line.</p>	ON	<p>This feature is available when the transmitting/receiving stations are ECM compatible.</p> <ul style="list-style-type: none"> • If received documents are in memory, follow the display message to solve the problem and print out the documents in memory before changing the setting. <p>After the setting is changed, the documents in the memory will be erased.</p>
		OFF	
#70	<p>Calling your pager</p> <div style="border: 1px solid black; padding: 2px; width: fit-content;"> FAX PAGER CALL =OFF [±] (KX-FP151) </div> <div style="border: 1px solid black; padding: 2px; width: fit-content;"> PAGER CALL =OFF [±] (KX-FP155) </div> <p>Activate this feature if you have a pager and wish to know when your unit receives the following:</p> <ul style="list-style-type: none"> — KX-FP151: a fax document. — KX-FP155: a fax document or an incoming voice message. 	ON	See page 45 for details.
		OFF	
#76	<p>Setting the connecting tone</p> <div style="border: 1px solid black; padding: 2px; width: fit-content;"> CONNECTING TONE =ON [±] </div> <p>If you often have trouble when sending a fax, this feature allows you to hear connecting tones: fax tone, ring back tone and busy tone.</p>	ON	<p>You can confirm the status of the other party's machine.</p> <ul style="list-style-type: none"> • If the ring back tone continues, the other party's machine may not be a facsimile or may have run out of paper. Check with the other party. • The connecting tone volume cannot be adjusted.
		OFF	

(The default setting is in bold type.)

Features Summary

Advanced features (cont.)

How to set menu options

1. Press **MENU**.
2. Press **◀** or **▶** until the following is displayed:
3. Press **+** or **-** until the desired setting is displayed.
4. Press **SET**.
5. Press **MENU**.

ADVANCED MODE
PRESS SET

then press **SET** and press **◀** or **▶** until the desired feature is displayed.

Note:

- Step 3 may be slightly different depending on the feature.
- See page 61 for more details.

Programming table (cont.)

Code	Feature & Display	Settings	How the unit operates
#77	■ For KX-FP151 only: Changing the receiving mode in the AUTO ANSWER setting <div style="border: 1px solid black; padding: 2px; margin-top: 5px;"> AUTO ANSWER =FAX ONLY [±] </div>	FAX ONLY	"FAX ONLY": Facsimile only mode (p. 39) "TEL/FAX": Telephone/Facsimile mode (p. 40, 41)
		TEL/FAX	
#77	■ For KX-FP155 only: Changing the receiving mode in the AUTO ANSWER setting <div style="border: 1px solid black; padding: 2px; margin-top: 5px;"> AUTO ANSWER =TAD/FAX [±] </div>	TAD/FAX	"TAD/FAX": Telephone Answering Device/Facsimile mode (p. 48) "FAX ONLY": Facsimile only mode (p. 39) "TEL/FAX": Telephone/Facsimile mode (p. 40, 41)
		FAX ONLY	
		TEL/FAX	
#78	Selecting the desired number of rings of the extension telephone if you use an extension telephone in TEL/FAX mode (TEL/FAX delayed ring setting) <div style="border: 1px solid black; padding: 2px; margin-top: 5px;"> TEL/FAX RING RINGS=2 [±] </div>	1, 2, 3, 4, 5, 6, 7, 8, 9	See pages 40 and 41 for details.
#80	Resetting advanced features to their default settings <div style="border: 1px solid black; padding: 2px; margin-top: 5px;"> SET DEFAULT RESET=NO [±] </div>	YES	1. Follow steps 1 and 2 above. 2. Press + or - to select "YES". 3. Press SET . 4. Press SET again. 5. Press MENU . • The ECM selection (feature #68 on page 69) will not be reset.
		NO	

(The default setting is in bold type.)

Error Messages

Reports

If your unit cannot send a fax, check the following:

- the number you dialled is correct,
- the other party's machine is a facsimile.

If the problem remains, correct it by following the communication message printed on the sending and journal reports (p. 31).

COMMUNICATION ERROR

(CODE: 40–42, 46–72, FF)

- A transmission or reception error occurred. Try again or check with the other party.

COMMUNICATION ERROR

(CODE: 43, 44)

- A line problem occurred. Connect the telephone line cord to a different jack and try again.
- An overseas transmission error occurred. Try using the overseas mode of feature #23 (p. 64).

DOCUMENT JAMMED

- The document is jammed. Remove the jammed document (p. 78).

ERROR-NOT YOUR UNIT

(CODE: 54, 59, 70)

- A transmission or reception error occurred because of a problem with the other party's fax machine. Check with the other party.

MEMORY FULL

- The document was not received due to memory being full.

NO DOCUMENT

- The document was not fed into the unit properly. Reinsert the document and try again.

OTHER FAX NOT RESPOND

- The other party's fax machine is busy or has run out of recording paper. Try again.
- The document was not fed properly. Reinsert the document and try again.
- The other party's fax machine rings too many times. Send the fax manually (p. 30).
- The other party's machine is not a facsimile. Check with the other party.
- The number you dialled is not in service.

PRESSED THE STOP KEY

- **STOP** was pressed and fax communication was cancelled.

OK

- Fax communication was successful.

Display

If the unit detects a problem, one or more of the following messages will appear on the display.

Display message	Cause & solution
CALL SERVICE	<ul style="list-style-type: none"> ● There is something wrong with the unit. Contact our service personnel.
CALL SERVICE2	
CHECK DOCUMENT	<ul style="list-style-type: none"> ● The document was not fed into the unit properly. Reinsert the document. If misfeeding occurs frequently, clean the document feeder rollers (p. 79) and try again.

Error Messages

Display

If the unit detects a problem, one or more of the following messages will appear on the display.

Display message	Cause & solution
CHECK MEMORY	<ul style="list-style-type: none"> The memory (telephone numbers, parameters, etc.) has been erased. Re-program.
CHECK PAPER	<ul style="list-style-type: none"> The recording paper is not installed or the unit has run out of paper. Install paper and press SET to clear the message. The recording paper is not fed into the unit properly. Reinstall paper (p. 14) and press SET to clear the message. The recording paper has jammed near the recording paper entrance. Clear the jammed paper (p. 77) and press SET to clear the message. Do not install folded or heavily curled paper.
COVER OPEN ↕ CHECK FILM	<ul style="list-style-type: none"> The covers are open. Close them. The ink film is empty. Replace the ink film with a new one (p. 12). The ink film is not installed. Install it (p. 12). The ink film is slack. Tighten it (see step 7 on page 13).
DIRECTORY FULL	<ul style="list-style-type: none"> There is no space to store new entries in the directory. Erase unnecessary entries (p. 23).
FAX IN MEMORY	<ul style="list-style-type: none"> The unit has a document in memory. See the other displayed message instructions to print out the document.
FAX MEMORY FULL	<ul style="list-style-type: none"> The memory is full of received documents due to a lack of recording paper or a recording paper jam. Install paper or clear the jammed paper. When performing memory transmission, the document being stored exceeds the memory capacity of the unit. Transmit the entire document manually.
MEMORY FULL	<ul style="list-style-type: none"> When making a copy, the document being stored exceeds the memory capacity of the unit. Press STOP to clear the message. Divide the document into sections.
MESSAGE FULL	<ul style="list-style-type: none"> There is no room left in memory to record a voice message. Erase unnecessary messages (p. 52, 55, 58).
MODEM ERROR	<ul style="list-style-type: none"> There is something wrong with the modem circuit. Contact our service personnel.
NO FAX REPLY	<ul style="list-style-type: none"> The other party's fax machine is busy or has run out of recording paper. Try again.

Error Messages / Operations

Display message	Cause & solution
PAPER JAMMED	<ul style="list-style-type: none"> ● A recording paper jam occurred. Clear the jammed paper (p. 77).
PLEASE WAIT	<ul style="list-style-type: none"> ● The unit is checking that there is no slack on the ink film. Wait for a moment while the check completes.
POLLING ERROR	<ul style="list-style-type: none"> ● The other party's fax machine does not provide the polling function. Check with the other party.
REDIAL TIME OUT	<ul style="list-style-type: none"> ● The other party's fax machine is busy or has run out of recording paper. Try again.
REMOVE DOCUMENT	<ul style="list-style-type: none"> ● The document is jammed. Remove the jammed document (p. 78). ● Attempted to transmit a document longer than 600 mm. Press STOP to remove the document. Divide the document into two or more sheets and try again.
TRANSMIT ERROR	<ul style="list-style-type: none"> ● A transmission error occurred. Try again.
UNIT OVERHEATED	<ul style="list-style-type: none"> ● The unit is too hot. Let the unit cool down.

When a function does not work, check here before requesting help

General

I cannot make and receive calls.

- The mains lead or telephone line cord is not connected. Check the connections (p. 16).
- If you used a splitter to connect the unit, remove the splitter and connect the unit to the wall jack directly. If the unit operates properly, check the splitter.

The unit does not work.

- Disconnect the unit from the telephone line and connect the line to a known working telephone. If the working telephone operates properly, contact our service personnel to have the unit repaired. If the working telephone does not operate properly, contact your telephone company.

(continued)

The unit does not ring.

- The ringer volume is set to off. Adjust it (p. 21).
- The TAD ring setting of feature #06 is set to "RINGER OFF". Change to another ring setting (p. 62) (KX-FP155 only).

The unit displays the following though the paper is inserted.

CHECK PAPER

- The paper is inserted halfway. Insert it correctly (p. 14) and press **SET** to clear the message.

(continued)

Operations

General (cont.)

The other party complains they only hear a fax tone and cannot talk.

- FAX ONLY mode is set. Tell the other party the number is only used for faxes.
- Change the receiving mode:
 - KX-FP151: TEL mode (p. 38) or TEL/FAX mode (p. 40).
 - KX-FP155: TAD/FAX mode (p. 48), TEL mode (p. 38) or TEL/FAX mode (p. 40).

The **REDIAL/PAUSE button does not function properly.**

- If this button is pressed during dialling, a pause will be inserted. If pressed immediately after a dial tone is obtained, the last number dialled will be redialled.

The receiving mode does not function properly.

- TEL/FAX mode is set (p. 40, 41).

During programming, I cannot enter the code, ID number or password (KX-FP155 only).

- All or part of the numbers are the same. Change the number: feature #11 (p. 63), #41 (p. 65), #51 and #52 (p. 67).

The ink film runs out quickly.

- The HELP printing function, copy function, and reports also use ink film.

The unit beeps.

- Recording paper or ink film has run out. Press **STOP** to stop the beeps and install paper/ink film.

The speakerphone is not working (KX-FP155 only).

- Use the speakerphone in a quiet room.
- If you have difficulty hearing the other party, adjust the volume using **+** or **-**.

Fax – sending

I cannot send documents.

- The telephone line cord is connected to the “EXT” jack on the unit. Connect to the “LINE” jack (p. 16) (KX-FP151 only).
- The other party’s fax machine is busy or has run out of recording paper. Try again.
- The other party’s machine is not a facsimile. Check with the other party.
- The other party’s fax machine rings too many times. Send the fax manually (p. 30).

(continued)

The other party complains that letters on their received document are distorted or not clear.

- If your line has special telephone services such as call waiting, the service may have been activated during fax transmission. Connect the unit to a line that does not have these services.
- The extension telephone on the same line is off the hook. Hang up the extension telephone and try again.
- Try copying the document. If the copied image is clear, there may be something wrong with the other party’s machine.

The other party complains that dirty patterns or black lines appear on their received document.

- The glass or rollers are dirty. Clean them (p. 79).

I cannot send a fax overseas.

- Use the overseas transmission mode of feature #23 (p. 64).
- Add two pauses at the end of the telephone number or dial manually.

Fax – receiving

I cannot receive documents.

- The telephone line cord is connected to the “EXT” jack on the unit. Connect to the “LINE” jack (p. 16) (KX-FP151 only).

I cannot receive documents automatically.

- The receiving mode is set to TEL mode. Set the receiving mode:
 - KX-FP151: FAX ONLY mode (p. 39) or TEL/FAX mode (p. 40).
 - KX-FP155: TAD/FAX mode (p. 48), FAX ONLY mode (p. 39) or TEL/FAX mode (p. 40).
- The time taken to answer the call is too long. Decrease the number of rings: feature #06 (p. 62), #30 (p. 65) and #78 (p. 70).
- The greeting message is too long. Shorten the message (p. 49) (KX-FP155 only).

(continued)

Operations

Fax – receiving (cont.)

The display shows the following, but faxes are not received.

CONNECTING

- The incoming call is not a fax. Change the receive mode:
 - KX-FP151: TEL mode (p. 38).
 - KX-FP155: TEL mode (p. 38) or TAD/FAX mode (p. 48).

A blank sheet is ejected.

- If a blank sheet is ejected after the received document is printed out, the receiving reduction rate is not programmed correctly. Program the proper rate in feature #36 (p. 65).
- The other party placed the document in their fax machine the wrong way. Check with the other party.

A white line or a dirty pattern appears on your recording paper.

- The glass or rollers are dirty. Clean them (p. 79).

The printing quality is poor.

- The other party sent a faint document. Ask them to send a clearer copy of the document.
- The thermal head is dirty. Clean it (p. 79).
- Some paper has instructions recommending which side to print on. Try turning the paper over.
- You may have used paper with a cotton and/or fibre content that is over 20%, such as letterhead or resume paper.

The other party complains that they cannot send a document.

- The memory is full of received documents due to a lack of recording paper or a recording paper jam. Install paper (p. 14) or clear the jammed paper (p. 77).

(continued)

Receiving mode

I cannot select the desired receiving mode.

- If you want to set TAD/FAX (KX-FP155 only), FAX ONLY or TEL/FAX mode:
 - select the desired mode using feature #77 (p. 70), and
 - press **AUTO ANSWER** to turn ON the arrow (▼) located on the right of the display.

Display:

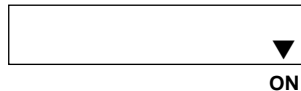

- If you want to set TEL mode:
 - press **AUTO ANSWER** to turn OFF the arrow (▼) located on the right of the display.

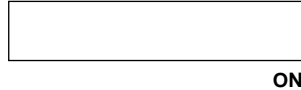

The other party complains that they cannot send a document.

- The unit is not in AUTO ANSWER mode. Press **AUTO ANSWER** to turn ON the arrow (▼) located on the right of the display.

Copying

The unit does not make a copy.

- You cannot make a copy during programming. Make the copy after programming or stop programming.

A black line, a white line or a dirty pattern appears on the copied document.

- The glass or rollers are dirty. Clean them (p. 79).

The copied image is distorted.

- The thermal head is dirty. Clean it (p. 79).

(continued)

Operations

Copying (cont.)

The printing quality is poor.

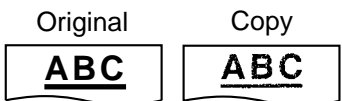

- Some paper has instructions recommending which side to print on. Try turning the paper over.
- You may have used paper with a cotton and/or fibre content that is over 20%, such as letterhead or resume paper.

Using an answering machine (KX-FP151 only)

I cannot receive documents automatically.

- Your greeting message on the answering machine is too long. Shorten the message (up to 10 seconds).
- The answering machine rings too many times. Set to 1 or 2 rings.

I cannot receive voice messages.

- Check if the answering machine is turned on and connected to the fax machine properly (p. 42).
- Set the number of rings on the answering machine to 1 or 2.

(continued)

I pressed the remote access code to access the answering machine remotely, but the line was disconnected.

- The code may include “#” which is used for certain features provided by telephone companies. Change the code on the answering machine to another number which does not include “#”.

Callers complain that they cannot send a document.

- Your answering machine has run out of recording tape. Rewind the tape to record messages.
- You set the answering machine to only give a greeting message.

Answering device (KX-FP155 only)

I cannot retrieve recorded messages from a remote location.

- Press the remote operation ID correctly and firmly (p. 54).

Messages in the mailbox do not play back.

- The mailbox password is wrong. Enter the correct password.
 - For mailbox 1 password, see feature #51 on page 67.
 - For mailbox 2 password, see feature #52 on page 67.

The other party complains that they cannot leave a voice message.

- The memory is full. Erase unnecessary messages (p. 52, 55, 58).

If a power failure occurs

- The unit will not function.
- The unit is not designed for making emergency telephone calls when the power fails. Alternative arrangements should be made for access to emergency services.
- Fax transmission and reception will be interrupted.

(continued)

- If the delayed transmission (feature #25 on page 64) is programmed and the start time is passed during a power failure, transmission will be attempted soon after power is restored.
- If any fax documents are stored in the memory, they will be lost. When power is restored, a power down report will be printed out stating which contents in the memory have been erased.

Recording paper jam

If the unit does not eject any recording paper during fax reception or copying, the recording paper has jammed and the display will show the following.

Display: PAPER JAMMED

- 1** Open the front cover by pulling up the centre part.

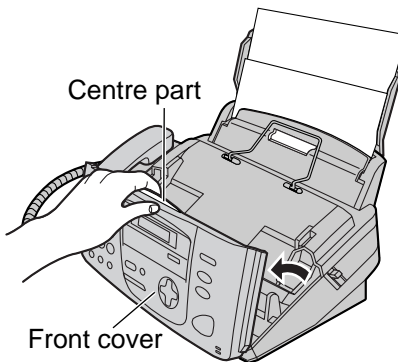

- 2** Push the back cover open button (green) on the right side of the unit.
OR
Push the back cover open lever (green) inside of the unit.

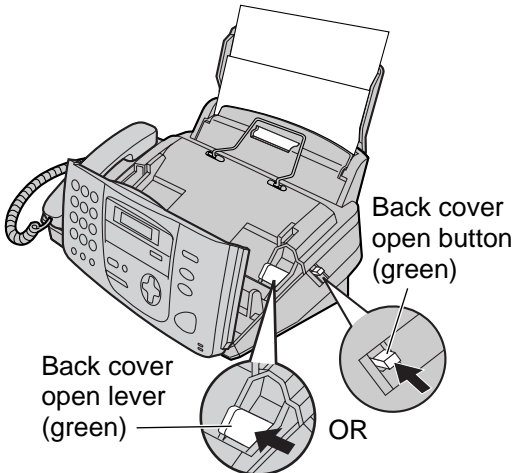

- 3** Open the back cover.

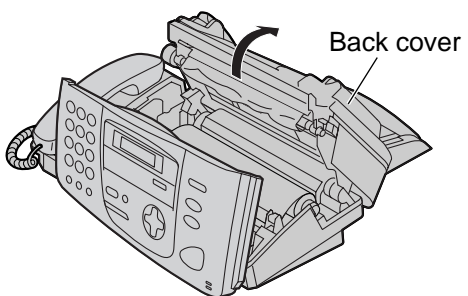

- 4** Remove the jammed recording paper.

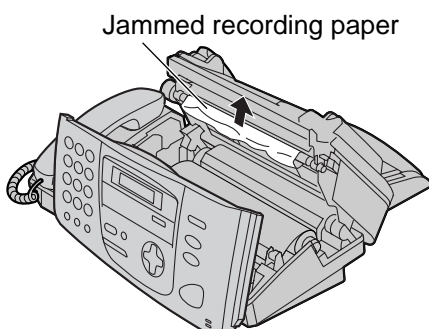

(continued)

Jams

5 Turn the “T” shaped gear (blue) in the direction of the arrow.

- Make sure that the ink film is wrapped around the blue core at least once.

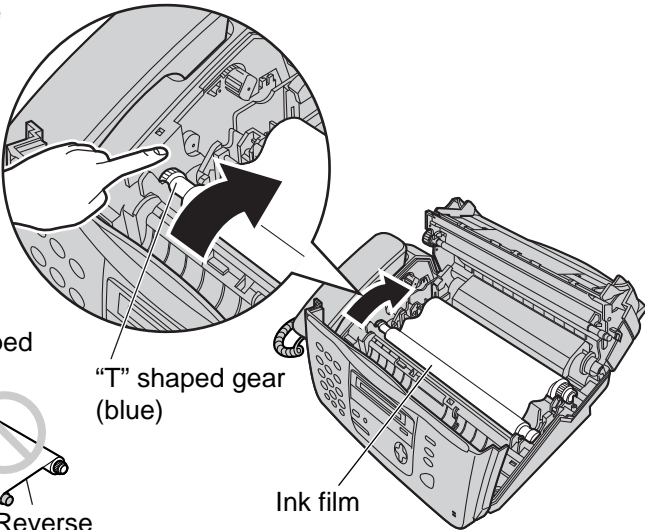
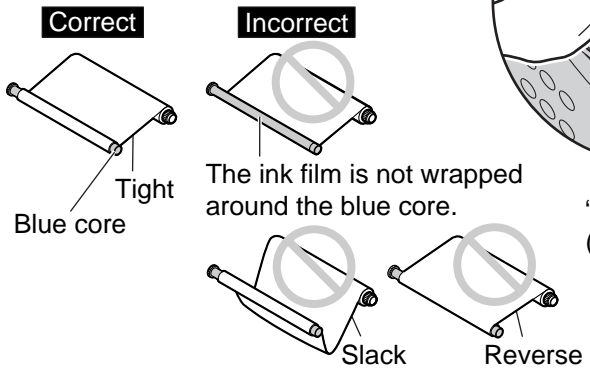

6 Close the back cover securely by pushing down on the dotted area at both ends (①). Close the front cover securely (②).

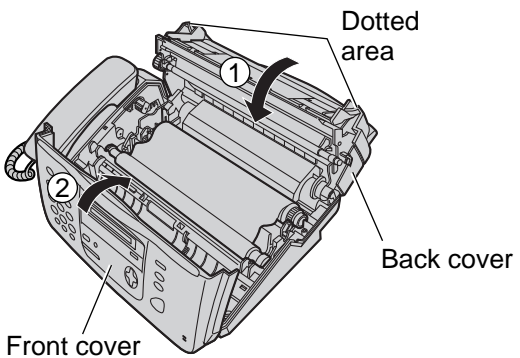

Document jams – sending

If the unit does not release the document during feeding, remove the jammed document as follows:

- 1** Open the front cover by pulling up the centre part.
- 2** Remove the jammed document carefully.
- 3** Close the front cover securely.

Note:

- Do not pull out the jammed paper forcibly before opening the front cover.

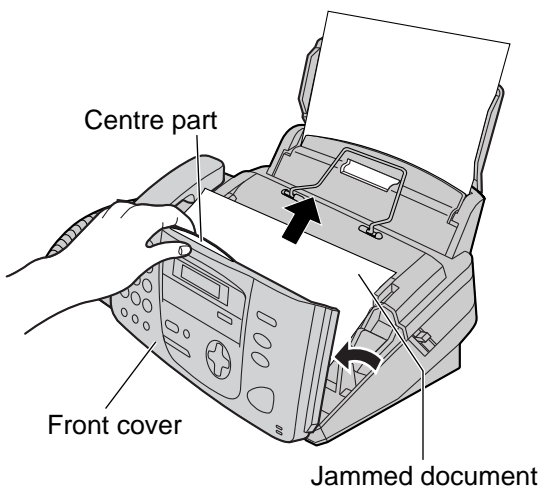

Cleaning

Document feeder

If misfeeding occurs frequently or if dirty patterns or black bands appear on a transmitted document or on the original of a copied document, clean the document feeder.

- 1** Disconnect the mains lead and the telephone line cord.
- 2** Open the front cover by pulling up the centre part.
- 3** Clean the document feeder rollers and rubber flap with a cloth moistened with isopropyl rubbing alcohol, and let all parts dry thoroughly.
- 4** Clean the glass with a soft and dry cloth.
- 5** Close the front cover securely.
- 6** Connect the mains lead and the telephone line cord.

Caution:

- Do not use paper products, such as paper towels or tissues, to clean the inside of the unit.

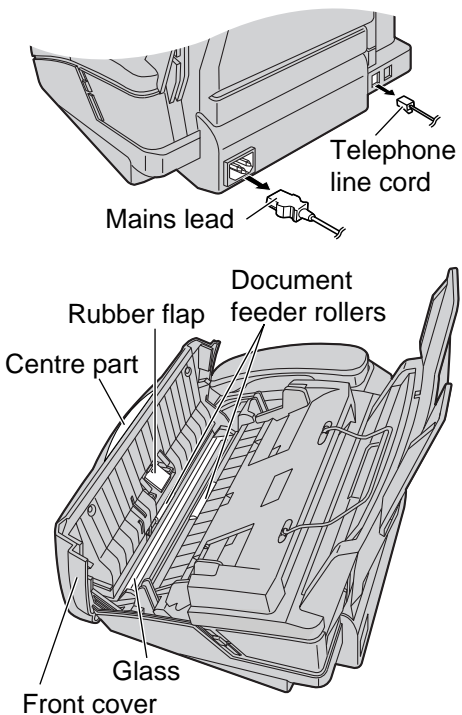

Thermal head

If dirty patterns or black or white bands appear on a copied or received document, check whether there is dust on the thermal head and clean the thermal head to remove the dust.

- 1** Disconnect the mains lead and the telephone line cord.
- 2** Open the front cover by pulling up the centre part.
- 3** Open the back cover by pushing the back cover open button (green) or pushing the back cover open lever (green).
- 4** Clean the thermal head with a cloth moistened with isopropyl rubbing alcohol, and let it dry thoroughly.
 - Do not touch the black sheets on the thermal head.
- 5** Close the back cover securely by pushing down on the dotted area at both ends. Close the front cover securely.
- 6** Connect the mains lead and the telephone line cord.

Caution:

- To prevent malfunction due to static electricity, do not use a dry cloth and do not touch the thermal head directly.

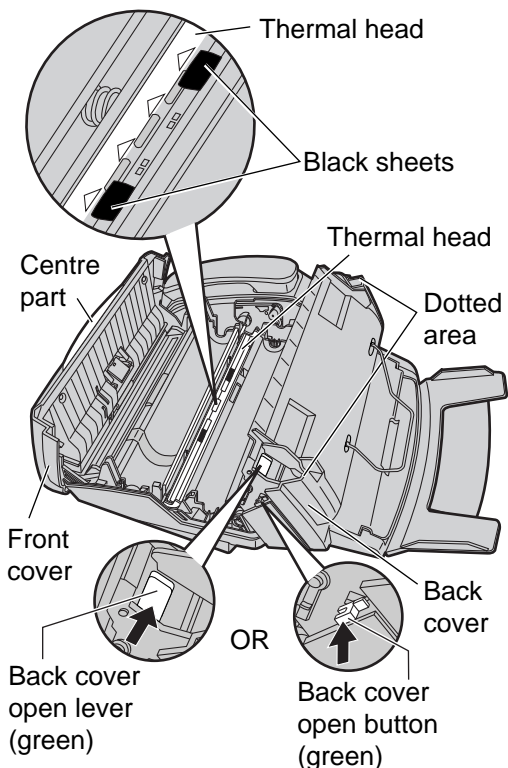

Printed Reports

Reference lists and reports

You can print out the following lists and reports for your reference.

Setup list: provides you with the current settings of the basic and advanced programming features (p. 62–70).

Telephone number list: provides you with names and telephone numbers which are stored in the directory.

Journal report: keeps records of fax transmission and reception. This report will be printed automatically after every 30 fax communications (feature #22 on page 64).

Printer test list: allows you to check the print quality of your unit. If the test print has a dirty pattern, or blurred points or lines, clean the thermal head (p. 79).

Broadcast programming list: provides you with entries which are stored in the broadcast feature (p. 33).

Caller ID list: keeps records of the last 30 callers after subscribing to a Caller ID service. This report will be printed automatically after every 30 callers (feature #26 on page 64).

- 1** Press **MENU** repeatedly until the following is displayed.

Display: PRINT REPORT
PRESS NAVI. [◀ ▶]

- 2** Press ◀ or ▶ until the desired item is displayed.

SETUP LIST
PRESS SET

TEL NO. LIST
PRESS SET

JOURNAL REPORT
PRESS SET

PRINTER TEST
PRESS SET

BROADCAST LIST
PRESS SET

CALLER ID LIST
PRESS SET

- 3** Press **SET** to start printing.

PRINTING

- To stop printing, press **STOP**.
- After printing, the printed item will be displayed.

- 4** Press **MENU**.

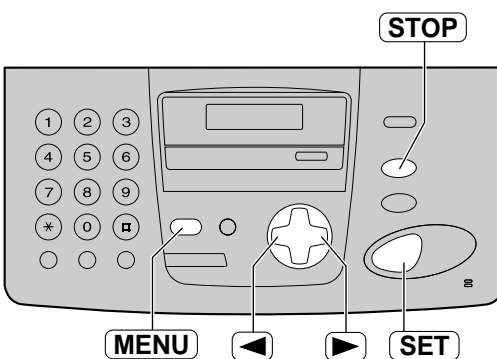

Specifications

Technical data about this product

Applicable lines:	Public Switched Telephone Network
Document size:	Max. 216 mm in width / Max. 600 mm in length
Effective scanning width:	208 mm
Effective printing width:	202 mm
Transmission time*:	<ul style="list-style-type: none"> ■ KX-FP151: Approx. 12 s/page (Original mode)** ■ KX-FP155: Approx. 8 s/page (Original mode)**
Scanning density:	Horizontal: 8 pels/mm Vertical: 3.85 lines/mm – STANDARD 7.7 lines/mm – FINE/PHOTO 15.4 lines/mm – SUPER FINE
Halftone level:	64-level
Scanner type:	Contact Image Sensor (CIS)
Printer type:	Thermal Transfer on plain paper
Data compression system:	Modified Huffman (MH), Modified READ (MR), Modified Modified READ (MMR)
Modem speed:	<ul style="list-style-type: none"> ■ KX-FP151: 9,600 / 7,200 / 4,800 / 2,400 bps; Automatic Fallback ■ KX-FP155: 14,400 / 12,000 / 9,600 / 7,200 / 4,800 / 2,400 bps; Automatic Fallback
Operating environment:	5 °C – 35 °C, 20 % – 80 % RH (Relative Humidity)
Dimensions (H x W x D):	185 mm x 345 mm x 269 mm
Mass (Weight):	Approx. 3.1 kg
Power consumption:	Standby: ■ KX-FP151: Approx. 5 W ■ KX-FP155: Approx. 6 W Transmission: Approx. 20 W Reception: Approx. 40 W (When receiving a 20% black document) Copy: Approx. 40 W (When copying a 20% black document) Maximum: Approx. 120 W (When copying a 100 % black document)
Power supply:	220–240 V AC, 50 Hz
Fax memory capacity:	Approx. 25 pages of memory transmission Approx. 28 pages of memory reception (Based on the ITU-T No. 1 Test Chart in standard resolution, without using the Error Correction Mode)
Voice memory capacity***:	Approx. 18 minutes of recording time including greeting messages (KX-FP155 only)

* Transmission speed depends upon the contents of the pages, resolution, telephone line conditions and capability of the other party's machine.

** Transmission speed is based upon the ITU-T No. 1 Test Chart and original mode.

If the capability of the other party's machine is inferior to your unit, the transmission time may be longer.

*** Recording time may be reduced by the calling party's background noise.

Note:

- Any details given in these instructions are subject to change without notice.
- The pictures and illustrations in these instructions may vary slightly from the actual product.

ITU-T No. 1 Test Chart

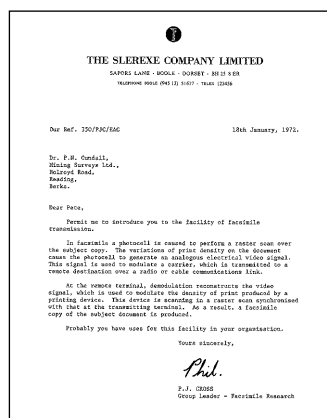

Specifications

■ Paper specifications

Recording paper size: A4: 210 mm x 297 mm

Note:

- Do not use the following types of paper:
 - Paper with a cotton and/or fibre content that is over 20%, such as letterhead paper or paper used for resumes.
 - Extremely smooth or shiny paper, or paper that is highly textured.
 - Coated, damaged or wrinkled paper.
 - Paper with irregularities, such as tabs or staples.
 - Paper which has dust, lint or oil stains.
 - Paper that will melt, vaporize, discolour, scorch or emit dangerous fumes, near 200 °C, such as vellum paper. These materials may transfer onto the fusing roller and cause damage.
 - Moist paper.
- Some paper only accepts print on one side. Try using the other side of the paper if you are not happy with the print quality or if misfeeding occurs.
- For proper feeding and best print quality, we recommend using long-grained paper.
- Do not use paper of different types or thickness at the same time. This may cause a paper jam.
- Avoid double-sided printing.
- Do not use paper printed from this unit for double-sided printing with other copiers or printers. This may cause a paper jam.
- To avoid curling, do not open paper packs until you are ready to use the paper. Store unused paper in the original packaging, in a cool and dry location.

Important Information

Important Information

The connection to the telecommunication systems must not be hard wired and must be unplugged before the earth is disconnected.

Method of connection

This apparatus is connected to the exchange line or PABX/PMBX extension by the new standard British Telecom plug and socket. Arrangements for provision of this type of termination can be made through the nearest British Telecom Sales Office.

This apparatus may be connected to the following types of installation.

- a) For connection to the public switched telephone network (PSTN) and compatible (Private Branch Exchange), which use DTMF signalling. (Please consult your supplier for an up to date list of compatible PBX's.)
- b) The apparatus can be used on extension sockets connected to a direct exchange line (D.E.L.).
- c) This apparatus is suitable for connection to the telecommunication system directly or via compatible private branch exchange as an extension. The supplier of the apparatus should be consulted for an up to date list of PBX's with which the apparatus is compatible.

It cannot be guaranteed that the apparatus will operate under all possible conditions of connection to compatible PBX's.

- This apparatus is suitable for connection to a PBX with or without initial proceed indication.
- This apparatus is suitable for connection to a PBX with or without secondary proceed indication.

Any cases of difficulty should be referred in the first instance to the supplier of the apparatus.

- d) The apparatus must not be connected in the following manner:
 - As an extension to a pay phone
 - As a party line with shared service

NOTES:

- If you experience any problems with the normal use of your apparatus, you should unplug it from the telephone outlet and connect a known working telephone in its place. If the known working telephone still gives problems, then please contact the customer service department of your PSTN operator (e.g. BT etc.). If it operates properly, then the problems are likely to be a fault in your apparatus. In this case, consult your supplier for advice.
- Your PSTN operator may charge you if they attend a service call that is not due to apparatus supplied by them.

Important Information

Fitting a plug to the mains lead

This appliance is supplied with a moulded three pin mains plug for your safety and convenience.

A 5 amp fuse is fitted in this plug.

Should the fuse need to be replaced please ensure that the replacement fuse has a rating of 5 amps and that it is approved by ASTA or BSI to BS1362.

Check for ASTA mark  or the BSI

mark  on the body of the fuse.

If the plug contains a removable fuse cover you must ensure that it is refitted when the fuse is replaced.

If you lose the fuse cover the plug must not be used until a replacement cover is obtained.

A replacement fuse cover can be purchased from your local Panasonic dealer.

IF THE FITTED MOULDED PLUG IS UNSUITABLE FOR THE SOCKET OUTLET IN YOUR HOME THEN THE FUSE SHOULD BE REMOVED AND THE PLUG CUT OFF AND DISPOSED OF SAFELY. THERE IS A DANGER OF SEVERE ELECTRICAL SHOCK IF THE CUT OFF PLUG IS INSERTED INTO ANY 13 AMP SOCKET.

If a new plug is to be fitted please observe the wiring code as shown below.

If in any doubt please consult a qualified electrician.

WARNING: THIS APPLIANCE MUST BE EARTHED.

IMPORTANT:

The wires in this mains lead are coloured in accordance with the following code:

Green-and-Yellow:	Earth
Blue:	Neutral
Brown:	Live

As the colours of the wire in the mains lead of this appliance may not correspond with the coloured markings identifying the terminals in your plug, proceed as follows.

The wire which is coloured GREEN-AND-YELLOW must be connected to the terminal in the plug which is marked with the letter E or by the Earth symbol \perp or coloured GREEN or GREEN-AND-YELLOW.

The wire which is coloured BLUE must be connected to the terminal in the plug which is marked with the letter N or coloured BLACK.

The wire which is coloured BROWN must be connected to the terminal in the plug which is marked with letter L or coloured RED.

How to replace the fuse: Open the fuse compartment with a screwdriver and replace the fuse (and fuse cover).

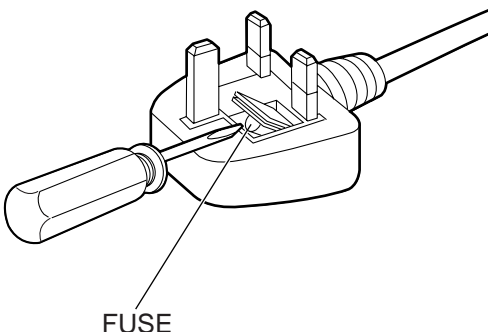
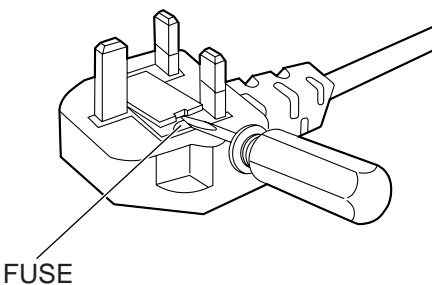

Guarantee

Condition of guarantee

This guarantee is in addition to and does not in any way affect any statutory or other rights of consumer purchasers. If within the applicable guarantee period, the appliance proves to be defective by reason of faulty design, workmanship or materials, we undertake subject to the following conditions to have the defective appliance (or any part or parts there of) repaired or replaced free of charge.

1. The appliance shall have been purchased and used solely within the UK and in accordance with standard operating instructions and the technical and/or Safety Standards required in the UK.
2. The purchaser will within 7 days of purchase complete the included warranty registration form (folded inside front cover) and fax it to us for registration. Failure to return such a form could result in delay in providing the guarantee service.
3. The appliance should be returned together with this guarantee and proof of date of purchase promptly on being found defective at the purchaser's risk and expense to the authorised dealer from whom the appliance was purchased or to the nearest authorised dealer. All enquiries must be through such dealers.
4. This guarantee shall not apply to damage caused through fire, accident, lightning, misuse, wear and tear, neglect, incorrect adjustment or repair, to damage caused through installation, adaption, modification or use in an improper manner or inconsistent with the technical and/or safety standards required in the country where this appliance is used, or to damage occurred during transit to or from the purchaser.
5. If at any time during the guarantee period any part or parts of the appliance are replaced with a part or parts not supplied or approved by us or of an objective quality safe and suitable for the appliance, or the appliance has been dismantled or repaired by any person not authorised by us, we shall have the right to terminate this guarantee in whole or in part immediately without further notice.
6. The purchaser's sole and exclusive remedy under this guarantee against us is for the repair or replacement of the appliance or any defective part or parts and no other remedy, including, but not limited to, incidental or consequential damage or loss of whatsoever nature shall be available to the purchaser.
7. This guarantee shall not apply to cassette tapes, batteries and any other items of limited nature life.
8. Our decision on all matters relating to complaints shall be final. Any appliance or defective part which has been replaced shall become our property.
9. The guarantee period applicable to this product shall be 12 months from the date of purchase.

Please keep these Operating Instructions with your receipt.

Panasonic Business Systems U.K.

Receipt No. _____	Date of Purchase _____
Model No. KX-FP151E, KX-FP155E _____	Serial No. _____

Index

Program index

Basic features

Code	Feature name	
#01	Date and time	17
#02	Your logo	18
#03	Your facsimile telephone number	20
#04	Sending report	31, 62
#06	TAD/FAX ring setting	48, 62
#06	FAX ring setting	62
#10	Recording time for an incoming message	63
#11	Remote operation ID	63
#17	Ringer pattern	21, 63

Advanced features

Code	Feature name	
#22	Journal report	31, 64
#23	Overseas mode	64
#25	Delayed transmission	64
#26	Caller ID list	25, 64
#30	Silent fax ring setting	40, 41, 65
#34	Quick scan	31, 46, 65
#36	Receiving reduction	65
#39	Display contrast	65
#41	Remote fax activation code	44, 65
#42	Message alert	65
#43	Recording time alert	66
#44	Fax receiving alert	66
#46	Friendly reception	38, 66
#47	Fax voice guidance	67
#49	Auto disconnection	41, 67
#51	Mailbox 1 password	67
#52	Mailbox 2 password	67
#54	Greeting time	68
#55	Mailbox 1 greeting	68
#56	Mailbox 2 greeting	68
#60	Message transfer	60, 68
#61	Message transfer greeting message	60, 68
#67	Incoming message monitor	69
#68	ECM selection	69
#70	Pager call	45
#76	Connecting tone	69
#77	Auto answer	70
#78	TEL/FAX ring setting	40, 41, 70
#80	Reset advanced features	70

Index

A	Accessories	6, 7
	(Paper tray)	14
	Advanced features	64–70
	Alert	
	(Memory reception)(Feature #44)	66
	(Message)(Feature #42)	65
	(Recording time)(Feature #43)	66
	Answering machine	42
	Auto answer setting (Feature #77)	70
	Auto disconnection (Feature #49)	41, 67
B	Basic features	62, 63
	Broadcast transmission	33
	Buttons	
	(AUTO ANSWER)	38–40, 48
	(CALLER ID)	26
	(Delete)	19
	(DIGITAL SP-PHONE)	24
	(ERASE)	52, 58
	(HELP)	8
	(Insert)	19
	(MONITOR)	24
	(QUICK)	52
	(RECALL)	21
	(REDIAL)	30
	(SLOW)	52
C	Call counter	52
	Caller ID	25
	(Calling back)	26
	(Storing)	28
	Caller ID list (Feature #26)	25, 64
	Caller's recording time (Feature #10)	63
	Character table	19
	Cleaning	79
	Communication messages	71
	Connecting tone (Feature #76)	69
	Connections	16
	Copy	46
	(Collation)	47
	(Enlarge)	47
	(Reduce)	47
D	Date and time (Feature #01)	17, 62
	Delayed transmission (Feature #25)	64
	Directory	
	(Making a phone call)	24
	(Selecting characters)	19
	(Sending faxes)	32
	(Storing)	22

- Display
 (Contrast)(Feature #39) 65
 (Error messages) 71, 72
 Document size 31
- E** ECM selection (Feature #68) 69
 Error messages 71–73
 Extension telephone 41, 44
- F** Facsimile telephone number
 (Feature #03) 20, 62
 Fax activation code
 (Feature #41) 44, 65
 Fax auto redial 32
 FAX ONLY mode 39
 Fax receiving 36, 37
 Fax voice guidance (Feature #47) . . 67
 Friendly reception (Feature #46) . 38, 66
- G** Greeting message
 (Message transfer)(Feature #61) . 60, 68
 (TAD/FAX) 48–50
 (TEL/FAX) 40, 41, 49, 50
 (Voice mailbox)(Feature #55, #56) . 57, 68
- I** Incoming message monitor
 (Feature #67) 69
 Ink film 12, 13
- J** Jams
 (Document) 78
 (Paper) 77
 Journal report (Feature #22) . . . 31, 64
- L** Logo (Feature #02) 18, 62
- M** Memory reception 38
 Message alert (Feature #42) 65
 Message transfer (Feature #60) . 60, 68
 Metal bar 16
- O** Overseas mode (Feature #23) 64
- P** Pager call (Feature #70) 45, 69
 Polling 44
 Power failure 76
- Q** Quick scan (Feature #34) . . . 31, 46, 65
- R** Receiving alert (Feature #44) 66
 Receiving reduction (Feature #36) . . 65
 Receiving setting 36, 37
 Recording
 (Greeting message) 49, 57, 60
 (Memo message) 51, 58
 (Telephone conversation) 24
 Recording paper 14
 Recording paper size 82
 Recording time alert (Feature #43) . . 66
 Recording time for TAD/FAX greeting
 message (Feature #54) 68
 Remote operation card 53, 54
 Remote operation ID (Feature #11) . . 63
 Reports
 (Broadcast) 80
 (Caller ID) 80
 (Journal) 80
 (Power down) 76
 (Printer test) 80
 (Sending) 31
 (Setup) 80
 (Telephone number) 80
 Reset (Feature #80) 70
 Resolution 30, 46
 Ring setting
 (FAX ONLY)(Feature #06) 62
 (Silent fax)(Feature #30) 65
 (TAD/FAX)(Feature #06) 62
 (TEL/FAX)(Feature #78) 70
 Ringer pattern (Feature #17) . . . 21, 63
- S** Sending
 (Broadcast) 35
 (Directory) 32
 (Manually) 30
 (Quick scan) 31
 Sending report (Feature #04) . . . 31, 62
 Set default (Feature #80) 70
 Storing
 (Broadcast) 33
 (Directory) 22
- T** TAD/FAX mode 48
 TEL mode 38
 TEL/FAX mode 40
 Toll saver 48
- V** Voice contact 29
 Voice mailbox 56
 Voice mailbox password
 (Feature #51, #52) 58, 59, 67
 Voice time/day stamp 52
 Volume 21

CE 0682

Sales Department:

Panasonic Business Systems U.K.

Panasonic House, Willoughby Road, Bracknell, Berkshire, RG12 8FP

Manufacturer:

Kyushu Matsushita Electric (U.K.) Ltd.

Pencarn Way, Duffryn, Newport, South Wales, NP10 8YE, The United Kingdom

PFQX1628ZA

KV1201ST0

Free Manuals Download Website

<http://myh66.com>

<http://usermanuals.us>

<http://www.somanuals.com>

<http://www.4manuals.cc>

<http://www.manual-lib.com>

<http://www.404manual.com>

<http://www.luxmanual.com>

<http://aubethermostatmanual.com>

Golf course search by state

<http://golfingnear.com>

Email search by domain

<http://emailbydomain.com>

Auto manuals search

<http://auto.somanuals.com>

TV manuals search

<http://tv.somanuals.com>