

Panasonic

Compact Plain Paper FAX
with Cordless Phone

Operating Instructions

Model No. **KX-FPC95**
KX-FPC96



FOR FAX ADVANTAGE ASSISTANCE:

- CALL
1-800-HELP-FAX (1-800-435-7329)
- E-MAIL TO
consumerproducts@panasonic.com
for customers in the USA or
Puerto Rico
- REFER TO
www.panasonic.com
for customers in the USA or
Puerto Rico

Please read these Operating
Instructions before using the unit
and save for future reference.

Thank you for purchasing a Panasonic facsimile.

Welcome to the world of Panasonic facsimiles.

This product combines facsimile, telephone, telephone answering device and copier features to provide you with more efficient office or home use. By utilizing these convenient features, you can maximize the effectiveness of this unit.

Things you should keep record of

Attach your sales receipt here

For your future reference

Date of purchase

Serial number

(found on the rear of the unit)

Dealer's name and address

Dealer's telephone number

Caution:

- The Telephone Protection Act of 1991 requires the following information to be clearly stated either at the top or bottom margin of the first message page when transmitting messages via telephone facsimile:
 - Date and time of transmission,
 - Identification of the business, entity or person(s) sending the facsimile, and
 - Telephone number of the business, entity or person(s).To program this information into your unit, complete all the instructions on pages 15 to 18.
- Note that the images of copied or received documents will remain on the used ink film. Use discretion when disposing of the used ink film.
- Do not rub or use an eraser on the printed side of recording paper, as the print may smear.

Trademarks

Hammermill® is a registered trademark of INTERNATIONAL PAPER in the United States and/or other countries.

All other trademarks identified herein are the property of their respective owners.

Energy Star

As an ENERGY STAR® Partner, Panasonic has determined that this product meets the ENERGY STAR® guidelines for energy efficiency.

ENERGY STAR is a U.S. registered mark.



Copyright:

This manual is copyrighted by Kyushu Matsushita Electric Co., Ltd. (KME) and its licensee. Under the copyright laws, this manual may not be reproduced in any form, in whole or part, without the prior written consent of KME and its licensee.

© Kyushu Matsushita Electric Co., Ltd. 2000

For best performance

Battery charge

To power the handset, charge for about **4 hours** before initial use (p. 20).

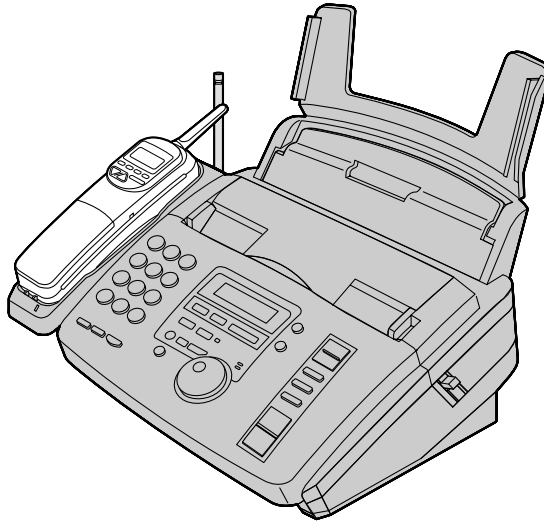

Operating distance and noise

Calls are transmitted between the main unit and the handset using wireless radio waves.

For maximum distance and noise free operation, the recommended main unit location is:

Away from electrical appliances such as TVs, radios, or personal computers.

In a **HIGH** and **CENTRAL** location with no obstructions such as walls.

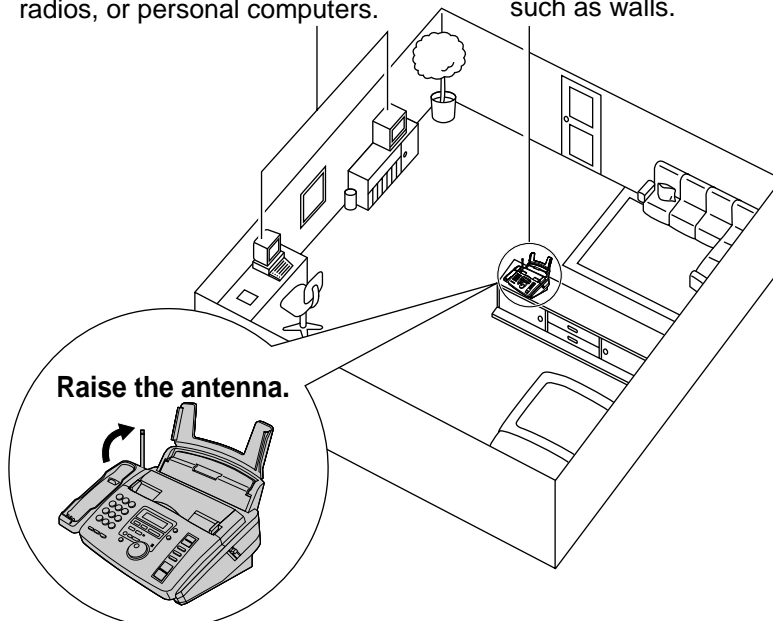

Important safety instructions

When using this unit, basic safety precautions should always be followed to reduce the risk of fire, electric shock, or personal injury.

1. Read and understand all instructions.
2. Follow all warnings and instructions marked on this unit.
3. Unplug this unit from power outlets before cleaning. Do not use liquid or aerosol cleaners. Use a damp cloth for cleaning.
4. Do not use this unit near water, for example near a bath tub, wash bowl, kitchen sink, or the like.
5. Place the unit securely on a stable surface. Serious damage and/or injury may result if the unit falls.
6. Do not cover slots and openings on the unit. They are provided for ventilation and protection against overheating. Never place the unit near radiators, or in a place where proper ventilation is not provided.
7. Use only the power source marked on the unit. If you are not sure of the type of power supplied to your home, consult your dealer or local power company.
8. For safety purposes this unit is equipped with a three prong grounded plug. If you do not have this type of outlet, please have one installed. Do not use any type of adaptor plug to defeat this safety feature.
9. Do not place objects on the power cord. Install the unit where no one can step or trip on the cord.
10. Do not overload wall outlets and extension cords. This can result in the risk of fire or electric shock.
11. Never push any objects through slots in this unit. This may result in the risk of fire or electric shock. Never spill any liquid on the unit.
12. To reduce the risk of electric shock, do not disassemble this unit. Take the unit to an authorized servicenter when service is required. Opening or removing covers may expose you to dangerous voltages or other risks. Incorrect reassembly can cause electric shock when the unit is subsequently used.
13. Unplug this unit from the wall outlet and refer servicing to an authorized servicenter when the following conditions occur:
 - A. When the power supply cord or plug is damaged or frayed.
 - B. If liquid has been spilled into the unit.
 - C. If the unit has been exposed to rain or water.
 - D. If the unit does not work normally by following the operating instructions. Adjust only controls covered by the operating instructions. Improper adjustment may require extensive work by an authorized servicenter.
 - E. If the unit has been dropped or physically damaged.
 - F. If the unit exhibits a distinct change in performance.
14. During thunderstorms, avoid using telephones except cordless types. There may be a remote risk of an electric shock from lightning.
15. Do not use this unit to report a gas leak, when in the vicinity of the leak.

**SAVE THESE
INSTRUCTIONS**

CAUTION

To reduce the risk of fire or injury to persons, read and follow these instructions.

1. Use only the battery(ies) specified.
2. Do not dispose of the battery(ies) in a fire. They may explode. Check with local waste management codes for special disposal instructions.
3. Do not open or mutilate the battery(ies). Released electrolyte is corrosive and may cause burns or injury to the eyes or skin. The electrolyte may be toxic if swallowed.
4. Exercise care in handling batteries in order not to short the battery to conductive materials such as rings, bracelets, and keys. The battery and/or conductor may overheat and cause burns.
5. Charge the battery(ies) provided with or identified for use with this product only in accordance with the instructions and limitations specified in this manual.

INSTALLATION

1. Never install telephone wiring during a lightning storm.
2. Never install telephone jacks in wet locations unless the jack is specifically designed for wet locations.
3. Never touch uninsulated telephone wires or terminals unless the telephone line has been disconnected at the network interface.
4. Use caution when installing or modifying telephone lines.

WARNING

- To prevent the risk of fire or electrical shock, do not expose this product to rain or any type of moisture.

OTHER INFORMATION

- Keep the unit away from electrical noise generating devices, such as fluorescent lamps and motors.
- The unit should be kept free from dust, high temperature and vibration.
- The unit should not be exposed to direct sunlight.
- Do not place heavy objects on top of this unit.
- Do not touch the plug with wet hands.

Table of Contents

Initial Preparation

Accessories	Included accessories	8
	Accessory order information	9
Help Button	Help function	10
Finding the Controls (Main Unit)	Location	11
	Overview	12
Setup (Main Unit)	Removing the information leaflet	12
	Paper tray	12
	Recording paper	13
	Connections	14
	Date and time, your logo and facsimile telephone number	15
Setup (Handset)	Location	19
	Battery charge	20
	Belt clip	21
	Headset (not included)	21
Volumes	Adjusting volumes	22

Telephone

Making and Answering Calls	Voice calls - making	24
	Voice calls - answering	26
	Intercom between the handset and the main unit	27
	Transferring a call between the handset and the main unit	29
	Remote speakerphone	30
	Setting the auto talk feature	32
	TONE, FLASH and PAUSE buttons	33
Automatic Dialing (Handset)	Storing telephone numbers in the handset	34
	Making a voice call with the handset using stored numbers	35
JOG DIAL	Storing names and telephone numbers in the JOG DIAL directory	36
	Making a voice call using the JOG DIAL directory	39
Caller ID	Caller ID service from your phone company	40
	Calling back/storing/editing/erasing/caller information	44
	For call waiting service users	47
Voice Contact	Talking to the other party after fax transmission or reception	48

Fax

Sending Faxes	Sending a fax manually/using the JOG DIAL directory	49
	Sending a fax with the voice guide	53
	One time broadcast transmission	54
	Broadcast transmission to pre-programmed parties	55
Receiving Faxes	Setting the unit to receive faxes	58
	TEL mode (answering all calls manually)	60
	FAX ONLY mode (all calls are received as faxes)	61
	TEL/FAX mode (receiving voice calls with rings and fax calls without rings when you are near the unit)	62
	Using the unit with a computer	64
	Extension telephone	64
	Pager call - when the unit receives a fax or voice message	65

Copy

Copying	Making a copy	66
----------------	-------------------------	----

Answering Device

Setup	TAD/FAX mode (using the built-in answering device and receiving voice and fax calls automatically)	68
Greeting	Pre-recorded greeting messages	69
	Recording your own greeting messages	70
	Erasing your own recorded greeting messages	71
Incoming Messages	Listening to recorded messages	72
	Erasing recorded messages	73
Recording	Memo message (leaving a message for others or yourself)	74
From the Handset	Operating from the handset	75
Remote Operation	Operating from a remote location	77
	Operation from a remote touch tone telephone	78
Option	Transferring recorded messages to another telephone.	80

Programmable Features

Features Summary	Programming	82
	Basic features	83
	Advanced features	84

Help







Error Messages	Reports	89
	Display	90
Operations	When a function does not work, check here before requesting help	92
	If a power failure occurs	97
Jams	Recording paper jam	98
	Sending document jams	99
	Sending document does not feed, or multi-feeds	99
Ink Film	Replacing the ink film	100
Battery	Replacing the handset battery	102
Cleaning	Document feeder	103
	Thermal head	104
	Charge contacts	104

General Information

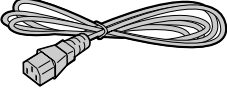
Print Reports	Reference lists and reports	105
Limited Warranty	Limited Warranty	106
	Servicenter Directory	107
FCC Information	List of FCC requirements and information	108
Specifications	Technical data about this product	109
Index	Index	110

Accessories

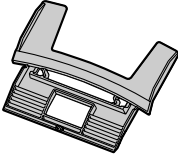
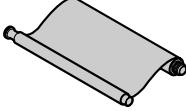
Included accessories

<p>Power cord.....1</p>  <p>Part No. PFJA1030Z</p>	<p>Telephone line cord...1</p>  <p>Part No. PQJA10075Z</p>	<p>Cordless handset1</p>  <p>—The rechargeable battery is pre-installed.</p>	<p>Belt clip1</p>  <p>Part No. PQKE10083Z1</p>
<p>Paper tray1</p>  <p>Part No. PFKS1040Y2</p>	<p>Ink film.....1 (included film roll)</p>  <p>—The ink film is pre-installed.</p>	<p>Operating instructions...1</p>  <p>Part No. PFQX1454Z</p>	

- If any items are missing or damaged, check with the place of purchase.
- The part numbers listed above are subject to change without notice.
- Save the original carton and packing materials for future shipping and transportation of the unit.

Accessory order information

- The included film roll is 10 meters (32½') long.
We recommend that you buy full size replacement film – 50 meters (164') for continuous use of your unit.
For best results, use genuine Panasonic replacement film Model No. KX-FA53 or KX-FA55.
- To install legal size recording paper, use a legal paper tray Model No. KX-FA50-B (p. 12).

To order

Telephone: Call 1-201-348-7292.

Fax: Send a fax to 1-877-375-4020.

Include:

- your name, shipping address and telephone number,
- credit card type, number, expiration date and your signature,
- order part number and quantity.

Via the Internet: Visit our web site: <http://www.panasonic.com/store>
(for customers in the USA or Puerto Rico ONLY)

- If you have any questions regarding accessory orders, please contact us at this E-MAIL ADDRESS: panasonicdirect@panasonic.com
(for customers in the USA or Puerto Rico ONLY)
or call us at: 201-348-7292

Model No.	Item	Specifications / Usage
KX-FA53	Replacement film	1 roll – 216 mm x 50 m (8½" x 164')
KX-FA55	Replacement film	2 rolls – 216 mm x 50 m (8½" x 164')
KX-FA50-B	Legal paper tray	To install legal size recording paper.
KX-A36	Rechargeable battery	Ni-Cd battery
KX-TCA87	Headset	For a hands-free telephone conversation

Note:

- The ink film is not reusable. Do not rewind and use the ink film again.

Help Button

Help function

You can print a quick reference for assistance as follows.

1 Press **HELP**.

Display: ROTATE ↻ & SET

2 Rotate **JOG DIAL** until the desired item is displayed.

1. How to send faxes with the voice guide

1.SEND GUIDE

2. How to set the date, time, your logo and fax number

2.QUICK SET UP

3. How to program the features

3.FEATURE LIST

4. How to store names in the JOG DIAL directory and how to dial them

4.JOG-DIAL

5. Help with problems operating the answering device

5.TAD OPERATION

6. Help with problems sending/receiving faxes

6.FAX SND/RCV

7. How to use the copier function

7.COPIER

8. Frequently asked questions and answers

8.Q and A

9. Explanation of error messages shown on the display

9.ERRORS

10. List of available reports

10.REPORTS

11. How to use the Caller ID service

11.CALLER ID

3 Press **SET**.

PRINTING

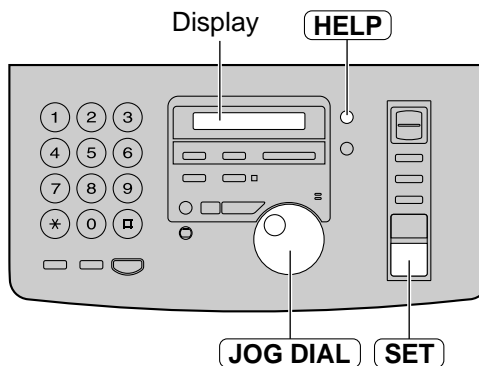

Finding the Controls (Main Unit)

Location

Dial keypad

- For the Caller ID service (p. 42, 45).
- To print the Caller ID list (p. 43).
- For voice muting (p. 25, 26).
- To use special features or services (p. 33).
- To insert a hyphen (p. 36, 37)
- To redial the last number dialed (p. 25, 50).
- To insert a pause during dialing (p. 33).
- To change from pulse to tone during dialing (p. 33).

Display

- To turn on/off the AUTO ANSWER mode (p. 58, 59).
- To adjust volumes (p. 23).
- To select an enlargement/reduction rate in the copy mode (p. 66, 67).
- To confirm a stored telephone number (p. 39).
- To print a quick reference (p. 10).

Buttons and Controls

- To initiate or exit programming.
- To initiate fax transmission, reception or copying.
- To store a setting during programming.
- To stop an operation or cancel programming.
- To select a resolution (p. 49).
- To search for a stored name (p. 39, 49).
- To select characters during programming (p. 17).
- To select the features/feature settings during programming (p. 82).
- To record your own greeting messages (p. 70).
- To record memo messages (p. 74).
- To erase recorded messages (p. 73).
- To erase your own greeting messages (p. 71).
- To store or edit names and telephone numbers (p. 36).
- To page or locate the handset (p. 28, 29).
- To play recorded messages (p. 72).

Finding the Controls / Setup (Main unit)

Overview

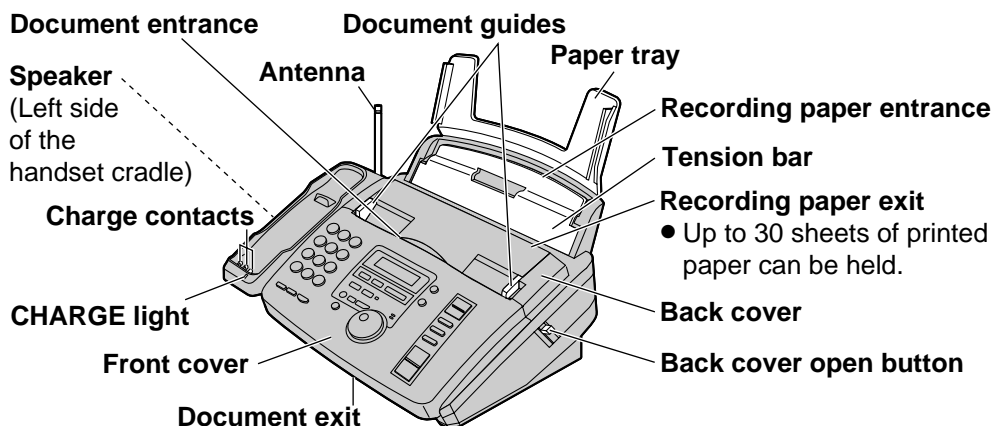

Note:

- The document will be ejected from the front of the unit. Install the unit on a desk or floor with a smooth surface and do not place anything in front of the unit.

Removing the information leaflet

- 1 Open the front cover by pulling up the center part.
- 2 Remove and read the information leaflet.
- 3 Close the front cover securely.

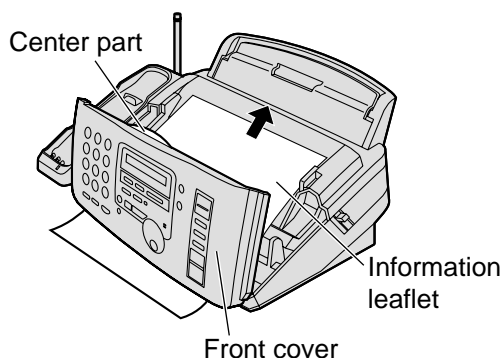

Paper tray

Insert one tab on the paper tray into one slot on the back of the unit (①) and then insert the other tab into the other slot (②).

Note:

- Do not place the unit in areas where the paper tray may be obstructed by a wall, etc.

To use legal size paper

- Please purchase a legal paper tray, Model No. KX-FA50-B (p. 9) and install as shown above.

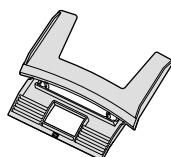

KX-FA50-B
Legal paper tray

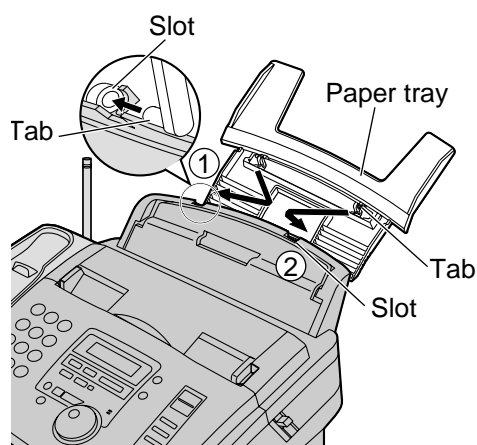

Recording paper

Letter* or legal** size recording paper can be loaded. The unit can hold up to 50 sheets of 60 g/m² to 75 g/m² (16 lb. to 20 lb.) paper or 30 sheets of 90 g/m² (24 lb.) paper.

*Letter = 216 mm x 279 mm (8½" x 11")

**Legal = 216 mm x 356 mm (8½" x 14")

If you use legal size paper, please purchase a legal paper tray, Model No. KX-FA50-B (p. 9) and install it (p. 12).

For best results, only use inkjet paper such as Hammermill® Jet Print. If you use other types of paper, the print quality may be affected.

- 1** Fan the stack of paper to prevent a paper jam.
- 2** Pull the tension bar forward and hold open while inserting the paper.
 - The paper should not be over the tab.
 - If the paper is not inserted correctly, readjust the paper or the paper may jam.

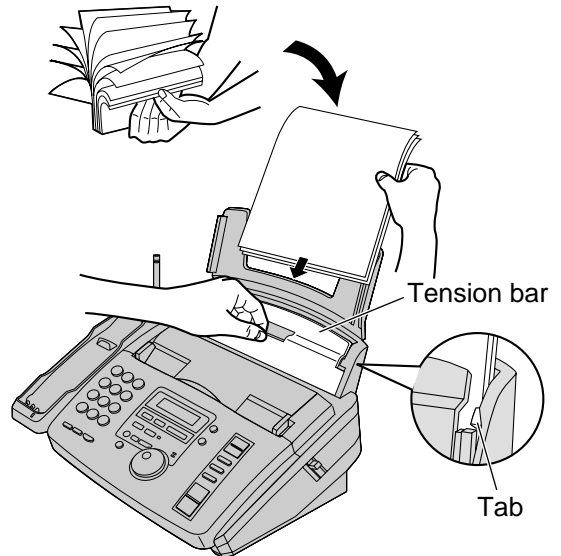
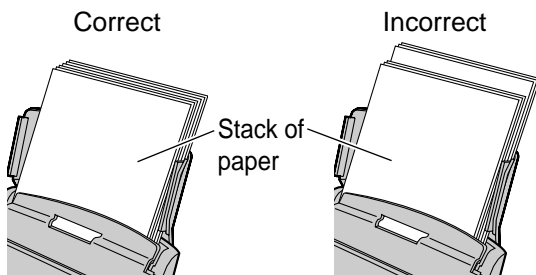

Note for recording paper:

- Avoid paper with a cotton and/or fiber content that is over 20%, such as letterhead paper or paper used for resumes.
- Do not use different types or thicknesses of paper at the same time. This may cause a paper jam.
- Avoid extremely smooth or shiny paper that is highly textured.
- Avoid paper that is coated, damaged or wrinkled.

Note:

- Avoid double-sided printing.
- Do not use paper printed from this unit for double-sided printing with other copiers or printers, or the paper may jam.
- Some paper only accepts print on one side. Try using the other side of paper if you are not happy with the print quality.

Adding paper

1. Pull the tension bar forward and hold open while removing all of the installed paper.
2. Add paper to the removed paper and straighten.
3. Fan the stack of paper.
4. Pull the tension bar forward and hold open while inserting the paper.

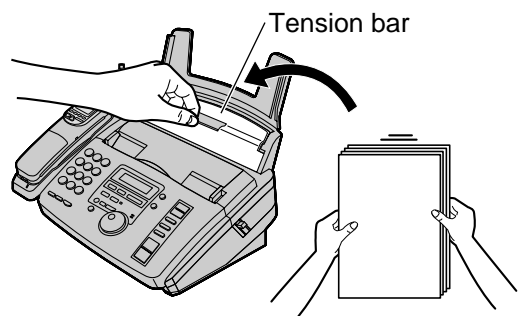

Setup (Main unit)

Connections

- 1 Connect the telephone line cord.
- 2 Connect the power cord.
 - When the power is turned on for the first time, the unit will print some basic information.

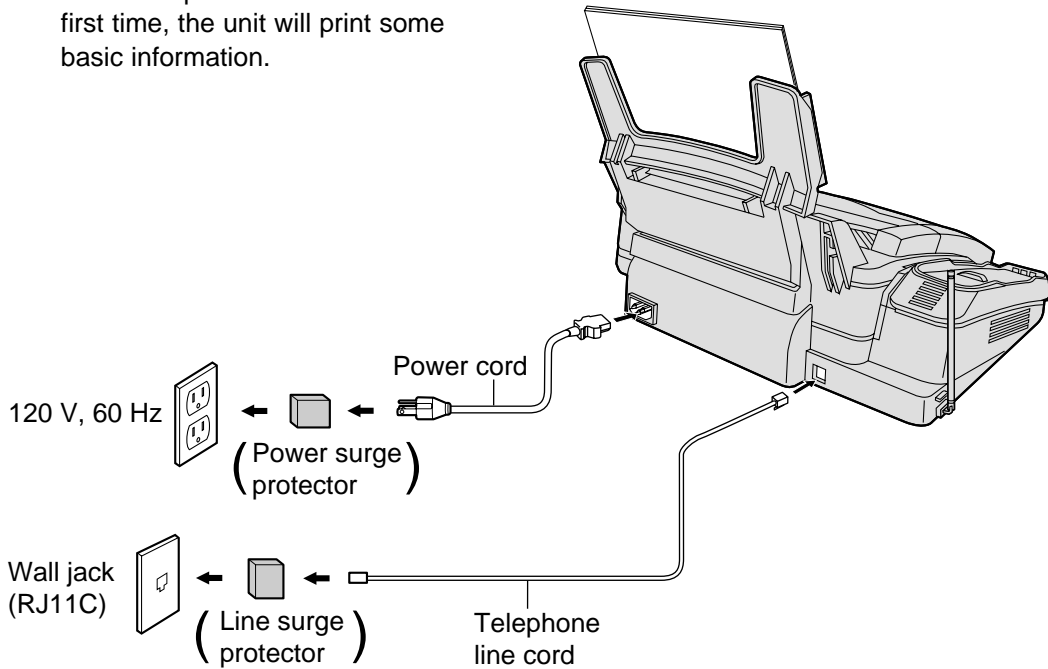

Note:

- For additional equipment protection, we recommend the use of a surge protector. The following types are available; TELESPIKE BLOK MODEL TSB (TRIPPE MFG. CO.), SPIKE BLOK MODEL SK6-0 (TRIPPE MFG. CO.), SUPER MAX (PANAMAX) or MP1 (ITW LINX).
The warranty does not cover damage due to power line surges or lightning.
- When you operate this product, the power outlet should be near the product and easily accessible.

Date and time, your logo and facsimile telephone number

You should program the date and time, your logo and facsimile telephone number. This information will be printed on each page transmitted from your unit, fulfilling the requirements of the Telephone Protection Act of 1991.

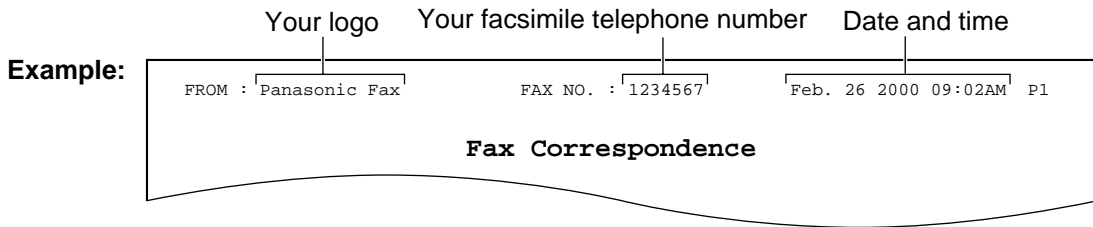

Setting the date and time

1 Press **MENU** .
Display: 1.SYSTEM SET UP

2 Press **□**, then **0 1** .
SET DATE & TIME

3 Press **SET** .
M:01/D:01/Y:00
Cursor

4 Enter the correct month/day/year by selecting 2 digits for each, using the dial keypad.
Example: Aug. 10, 2000
Press **0 8 1 0 0 0** .
M:08/D:10/Y:00

5 Press **SET** .
TIME: 12:00AM

6 Enter the correct hour/minute by selecting 2 digits for each, using the dial keypad.
Press ***** to select "AM" or "PM".
Example: 3:15PM
1. Press **0 3 1 5** .
TIME: 03:15AM

2. Press ***** until "PM" is displayed.
TIME: 03:15PM

7 Press **SET** .
SETUP ITEM []

8 Press **MENU** .

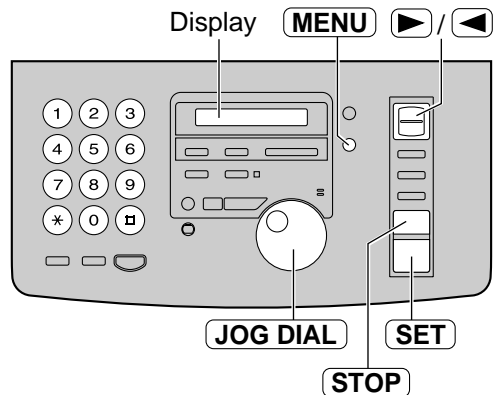

Note:

- You can enter your number by rotating **JOG DIAL** in steps 4 and 6. In this case, press **▶** to move the cursor.
- The accuracy of the clock is approximately ±60 seconds a month.

To correct a mistake

- Press **▶** or **◀** to move the cursor to the incorrect number, and make the correction.
- If you press **STOP** while programming, the display will return to the previous one.

Setup (Main unit)

Setting your logo

The logo can be your company, division or name.

1 Press **MENU** .
Display: 1.SYSTEM SET UP

2 Press **⏏**, then **0 2** .
YOUR LOGO

3 Press **SET** .
LOGO=

4 Enter your logo, up to 30 characters, using the dial keypad. See next page for details.

Example: Bill

1. Press **2** twice.

LOGO=B
Cursor

2. Press **4** six times.

LOGO=Bi

3. Press **5** six times.

LOGO=Bi_

4. Press **▶** to move the cursor to the next space and press **5** six times.

LOGO=Bill_

5 Press **SET** .
SETUP ITEM []

6 Press **MENU** .

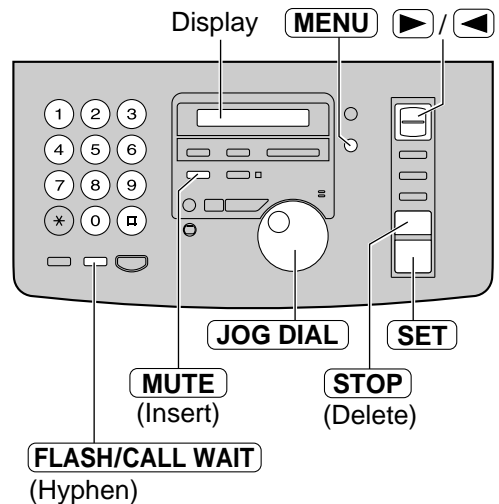

Note:

- You can enter your logo by rotating **JOG DIAL** (see next page).

To correct a mistake

- Press **▶** or **◀** to move the cursor to the incorrect character, and make the correction.

To delete a character

- Move the cursor to the character you want to delete and press **STOP** .



To insert a character

- Press **▶** or **◀** to move the cursor to the position to the right of where you want to insert the character.
- Press **MUTE** (Insert) to insert a space and enter the character.

Setup (Main unit)

To select characters with the dial keypad

Pressing the dial keys will select a character as shown below.

Keys	Characters
①	1 [] { } + - / = , . _ ` : ; ?
②	A B C a b c 2
③	D E F d e f 3
④	G H I g h i 4
⑤	J K L j k l 5
⑥	M N O m n o 6
⑦	P Q R S p q r s 7
⑧	T U V t u v 8
⑨	W X Y Z w x y z 9
⑩	0 () < > ! " # \$ % & ¥ * @ ^ ' →
FLASH/CALL WAIT	Hyphen button (To insert a hyphen.)
MUTE	Insert button (To insert one character or one space.)
STOP	Delete button (To delete a character.)
	▶ key (To move the cursor to the right.) To enter another character using the same number key, move the cursor to the next space.
	◀ key (To move the cursor to the left.)

To select characters using the JOG DIAL

Instead of pressing the dial keys, you can select characters using the JOG DIAL.

1. Rotate **JOG DIAL** until the desired character is displayed.
2. Press  to move the cursor to the next space.
• The character displayed in step 1 is inserted.
3. Return to step 1 to enter the next character.

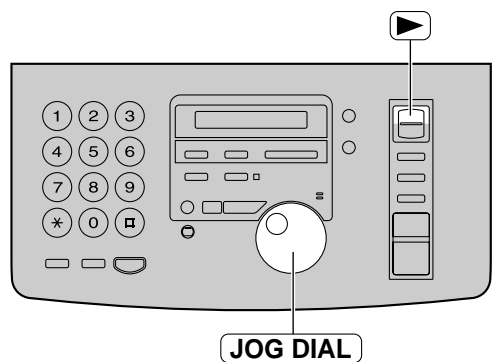

Display order of characters

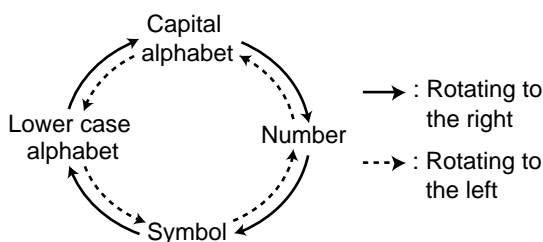

Setup (Main unit)

Setting your facsimile telephone number

- 1** Press **MENU**.
Display: 1.SYSTEM SET UP
- 2** Press **[]**, then **0** **3**.
YOUR FAX NO.
- 3** Press **SET**.
NO. =
- 4** Enter your facsimile telephone number, up to 20 digits, using the dial keypad.
Example: NO. =1234567
- 5** Press **SET**.
SETUP ITEM []
- 6** Press **MENU**.

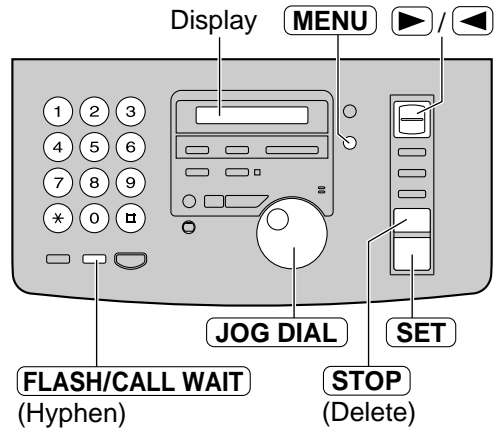

Note:

- You can enter your facsimile telephone number by rotating **JOG DIAL**. If using **JOG DIAL**, press **[▶]** to move the cursor.
- The **[*]** button replaces the digit with a "+" and the **[]** button replaces it with a space.
Example (using the dial keypad): +234 5678
Press **[*]** **2** **3** **4** **[]** **5** **6** **7** **8**.
- To enter a hyphen in a telephone number, press **FLASH/CALL WAIT** (Hyphen).

To correct a mistake

- Press **[▶]** or **[◀]** to move the cursor to the incorrect number, and make the correction.

To delete a number

- Move the cursor to the number you want to delete and press **STOP**.

Location

(Front)

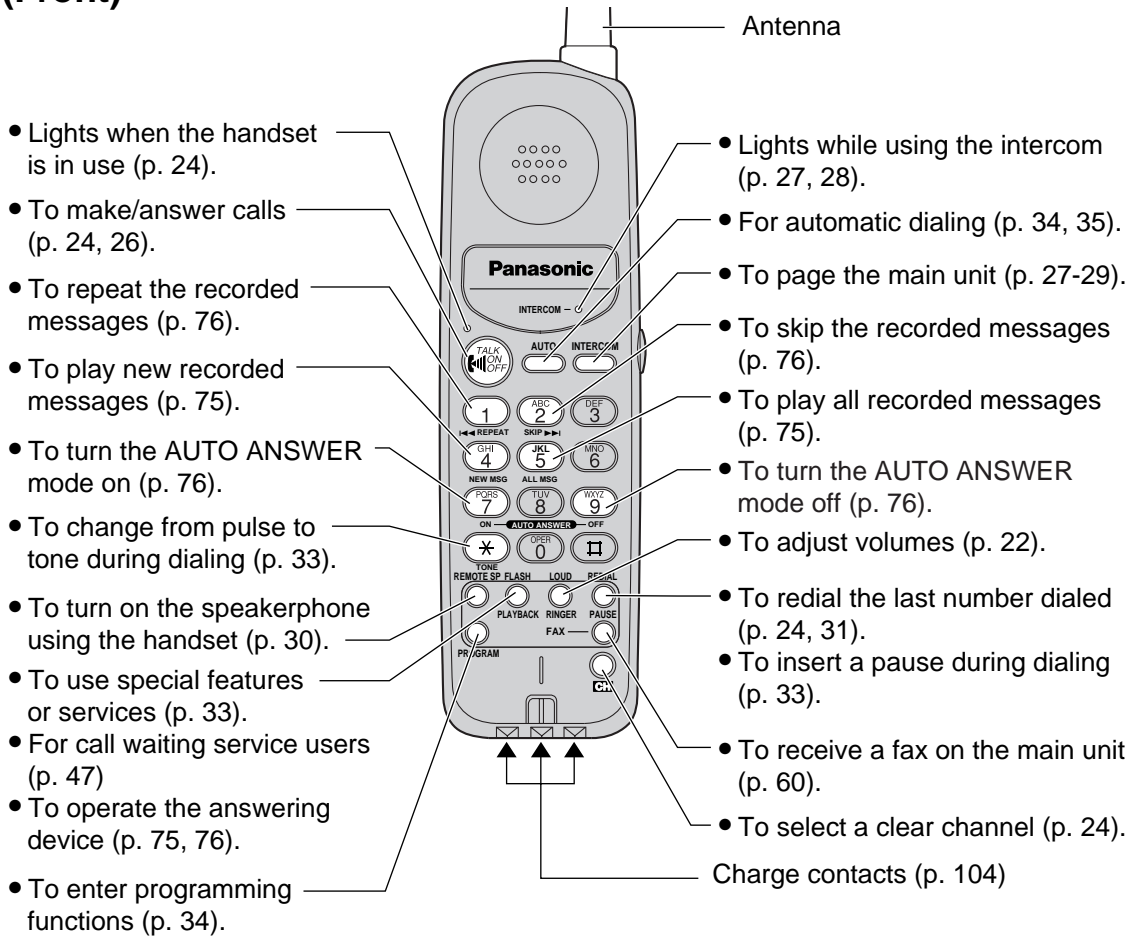

(Back)

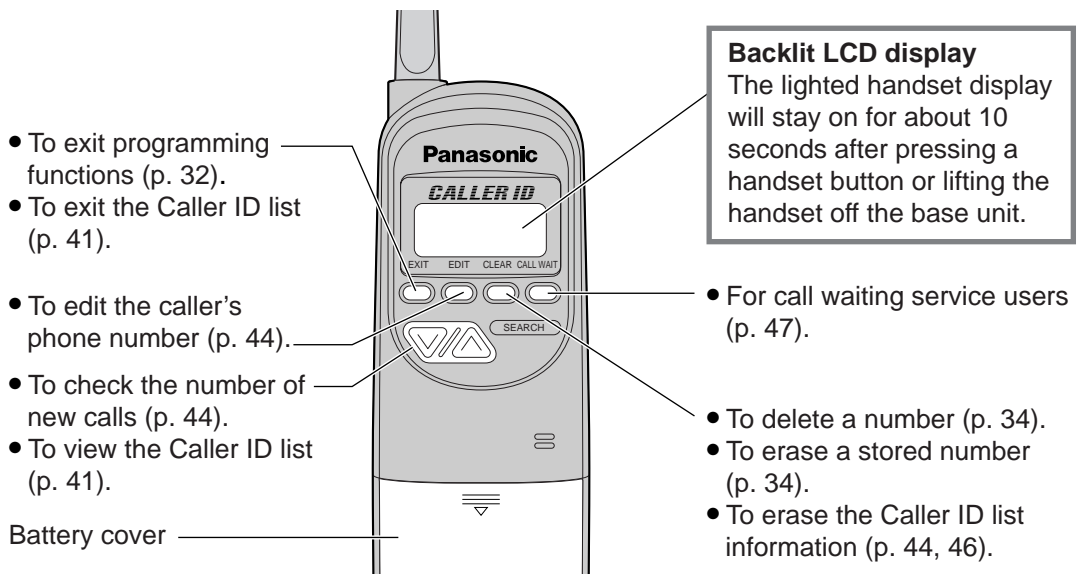

Setup (Handset)

Battery charge

Place the handset on the cradle of the main unit for about **4 hours**.

- The CHARGE light will turn on.

Note:

- **Clean the handset and the main unit charge contacts with a dry cloth once a month**, or the battery may not charge properly (p. 104).
- The battery cannot be overcharged.

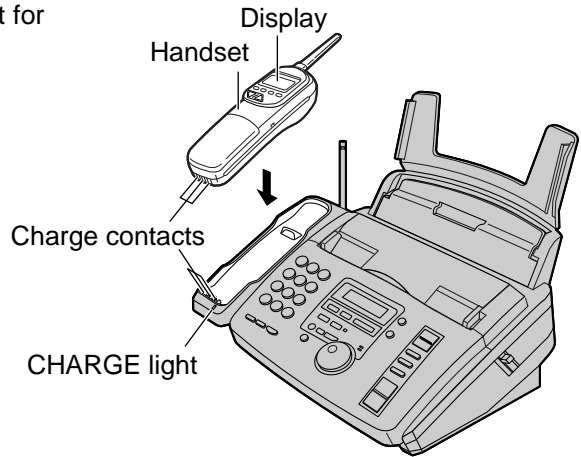

Automatic security code setting

Whenever you place the handset on the main unit, the unit will automatically select one of a million security codes. These codes help to avoid unauthorized use of your telephone line by another cordless telephone.

Battery life

If your Panasonic battery is fully charged, the battery life will be as follows.

While in use (in conversation)	Up to about 8 hours
While not in use (stand-by/off the main unit)	Up to about 21 days

Note:

- Battery life may vary depending on usage conditions and ambient temperature.

Stand-by mode

(The handset is off the main unit.)

The handset enters the stand-by mode after you finish using the handset (making/answering a call, viewing the Caller ID List, etc.).

Display is blank, but the handset can receive calls.

The battery life is conserved in this mode.

Battery strength

You can check the present battery strength on the display while the handset is on the main unit, while it is in use (making/answering a call etc.), or after viewing the Caller ID List, programming, etc. The battery strength indicator will remain on for about 5 seconds after using the handset, then the display will return to the stand-by mode (see left).

The battery strength is indicated as shown in the chart below.

Display prompt	Battery strength
{ ■■■ }	Fully charged
{ ■■ }	Medium
{ ■ }	Low
{ ■ } (flashing)	Needs to be recharged.

Recharge

Recharge the battery when:

- the following message is displayed on the handset,
- “{ ■ }” flashes on the handset display, or
- the handset beeps intermittently while it is in use.

Display:

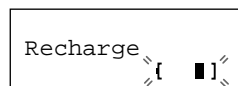

- If you DO NOT recharge the handset battery for more than 15 minutes, the display will keep indicating the above message and/or “{ ■ }” will continue to flash.

Belt clip

■ To install the belt clip

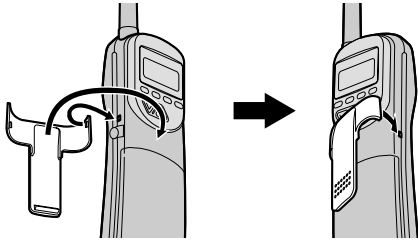

■ To remove the belt clip

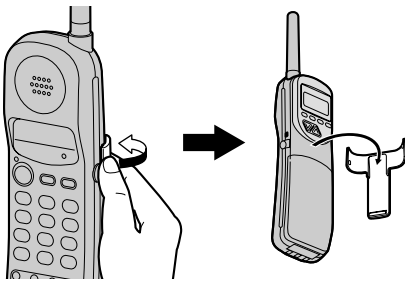

Wearing the belt clip

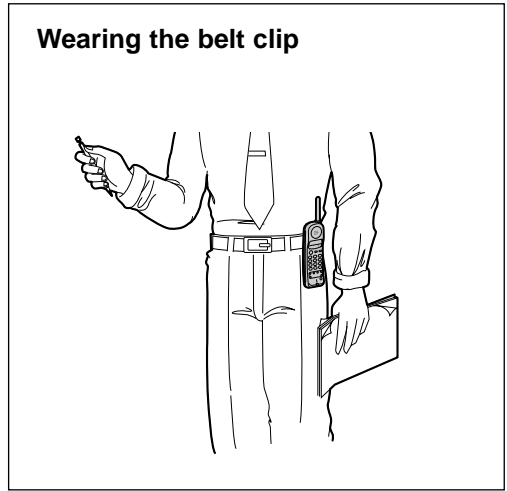

Headset (not included)

Plugging the headset into the handset allows a hands-free telephone conversation. For best results, use the Panasonic headset Model No. KX-TCA87. To order, see page 9.

■ To connect the headset

Open the headset jack cover, and connect the headset to the headset jack as shown below.

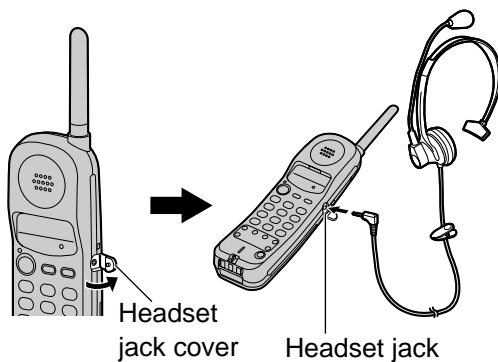

Wearing the headset

1. Place the headset on your head and attach the clothing clip to the desired position.

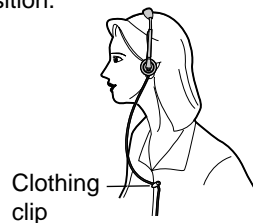

2. Adjust the microphone so it is near your mouth.



Adjusting volumes

Handset

Ringer volume

3 levels (high/low/off) are available.

Make sure the TALK indicator is off.

1. Press **LOUD/RINGER**.
 - The current ringer will sound.
2. To change the volume, press **LOUD/RINGER** again within 5 seconds.

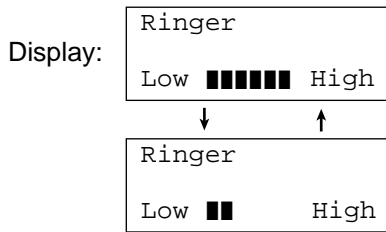

- The new ringer will sound.
- If you do not press **LOUD/RINGER** within 5 seconds, the volume will not change.

■ To turn the ringer off:

Press and hold **LOUD/RINGER** until you hear 2 beeps.

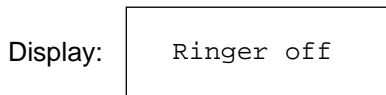

- To turn the ringer back on, press **LOUD/RINGER**. The sound will be at a loud level.

■ While the ringer volume is set to off:

When receiving a call, the handset will not ring, and the TALK indicator will flash.

Handset volume

3 levels (high/middle/low) are available.

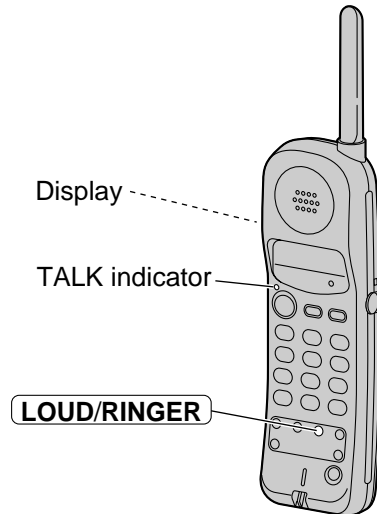
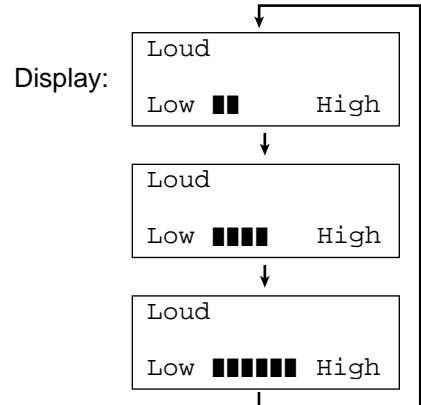

While talking, press **LOUD/RINGER**.



Main unit

Ringer volume

4 levels (high/middle/low/off) are available.

While the unit is idle, press  or .

■ To turn the ringer off:

1. Press  repeatedly until the following message is displayed.

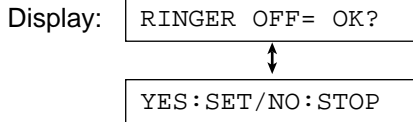

2. Press .

- To turn the ringer back on, press .

■ While the ringer volume is set to off:

The display will show the following message.





When a call is received, the unit will not ring and will show the following message.



Speaker volume

8 levels (high to low) are available.

While using the speakerphone, press

 or .

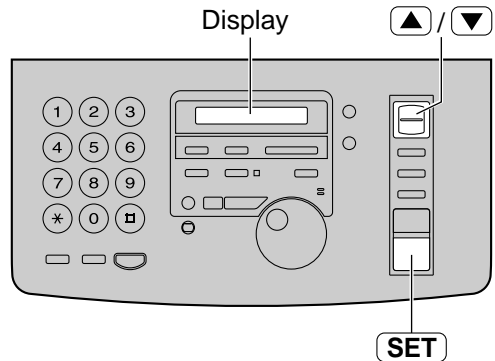

Making and Answering Calls

Voice calls - making

With the handset

1 ■ Handset is off the main unit:

Press **TALK**.

Example:

Talk CH10

Channel number

- The TALK indicator will light.
- The selected channel number will be displayed.

■ Handset is on the main unit:

Lift the handset and press **TALK**.

- The TALK indicator will light.
- The selected channel number will be displayed.

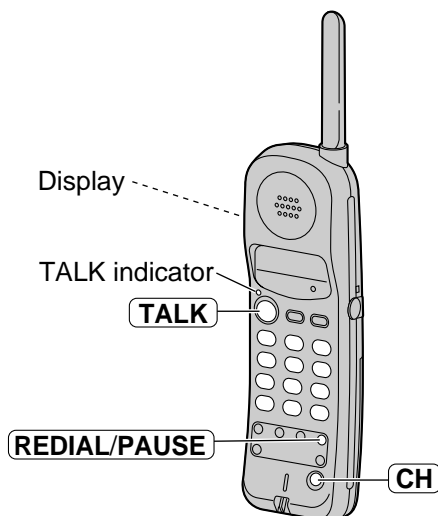

2 Dial the telephone number.

Example:

Talk 1112222 CH10

- If you misdial, press **TALK** and start again from step 1.

3 When you have finished talking, press **TALK** or place the handset on the main unit.

- The TALK indicator will turn off.

Note:

- If an alarm tone sounds when you press **TALK**;
—move towards the main unit, or
—place the handset on the main unit.
Then try again.
- If the TALK button on the handset is pressed while using the main unit, the call will be switched to the handset and the main unit is disconnected.
- The dialing mode is set to "TONE" as the default setting. If you cannot dial, change to "PULSE" with feature #13 (p. 83).

To redial the last number

The last number dialed will be redialed.

- The number to be redialed is different between the main unit and the handset.

1. Press **TALK**.
2. Press **REDIAL/PAUSE**.

If noise interferes with the conversation

Press **CH** to select a clear channel or move closer to the main unit.

- The selected channel number will be displayed.

Example:

Talk 00-01-30 CH12

Channel number

While the handset is in use

On the main unit, the IN USE indicator lights and the following will be displayed.

Display:

CORDLESS IN USE

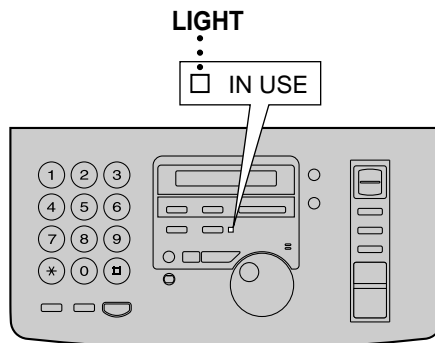

Making and Answering Calls

With the speakerphone

1 Press **DIGITAL SP-PHONE**.

Display:

2 Dial the telephone number.

Example:

- If you misdial, hang up and dial again.

3 When the other party answers, talk into the microphone.

4 When finished talking, press **DIGITAL SP-PHONE**.

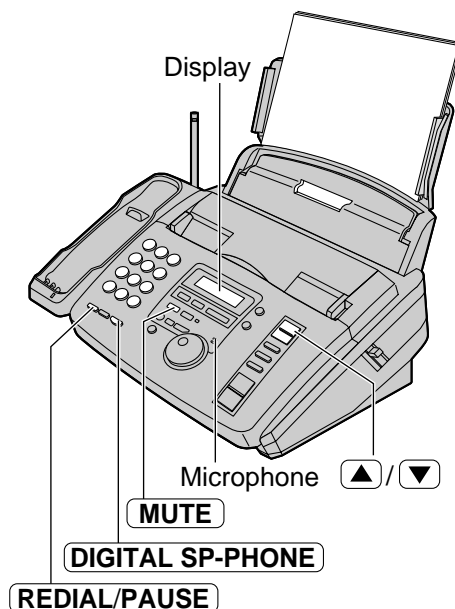

Note:

- If the TALK button on the handset is pressed while using the main unit, the call is switched to the handset and the main unit is disconnected.
- The dialing mode is set to "TONE" as the default setting. If you cannot dial, change to "PULSE" with feature #13 (p. 83).

To redial the last number

The last number dialed will be redialed.

- The number to be redialed is different between the main unit and the handset.

1. Press **DIGITAL SP-PHONE** or lift the handset.
2. Press **REDIAL/PAUSE**.

To mute your voice to the other party

1. Press **MUTE** during a telephone conversation.

Display:

- The other party cannot hear you, but you can hear them.
2. To resume the conversation, press **MUTE** again.

Speakerphone operation

- Use the speakerphone in a quiet room.
- Adjust the speakerphone volume using **▲** or **▼**.

Making and Answering Calls

Voice calls - answering

With the handset

- 1** ■ **Handset is off the main unit:**
Press **TALK** when the handset rings.
● You can also answer a call by pressing any dial key 0 to 9, *, or #.
(Any key talk feature)

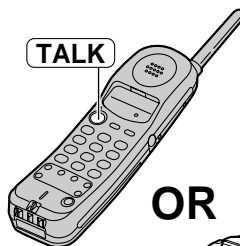

- **Handset is on the main unit:**
Lift the handset when the main unit rings.

- 2** When finished talking, press **TALK** or place the handset on the main unit.

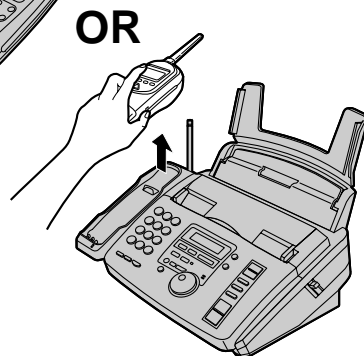

With the speakerphone

- 1** When the unit rings, press **DIGITAL SP-PHONE**.

- 2** When you have finished talking, press **DIGITAL SP-PHONE**.

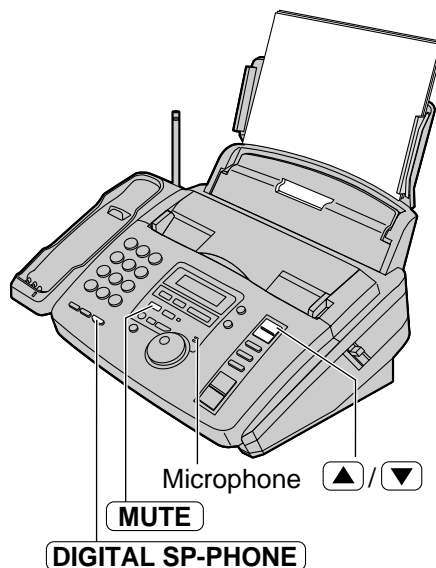

To mute your voice to the other party

1. Press **MUTE** during a telephone conversation using the speakerphone.

Display:

- The other party cannot hear you, but you can hear them.
2. To resume the conversation, press **MUTE** again.

Speakerphone operation

- Use the speakerphone in a quiet room.
- Adjust the speakerphone volume using **▲** or **▼**.

Making and Answering Calls

Intercom between the handset and the main unit

Paging the main unit from the handset

1 Handset:

Press **INTERCOM**.

- The INTERCOM indicator will flash, then light.

2 Main unit:

When the main unit rings, answer through the microphone.

- While using the intercom, the display will show:

For the main unit: INTERCOM CALL

For the handset: Intercom

(Example)

00-01-12 [■■■■]

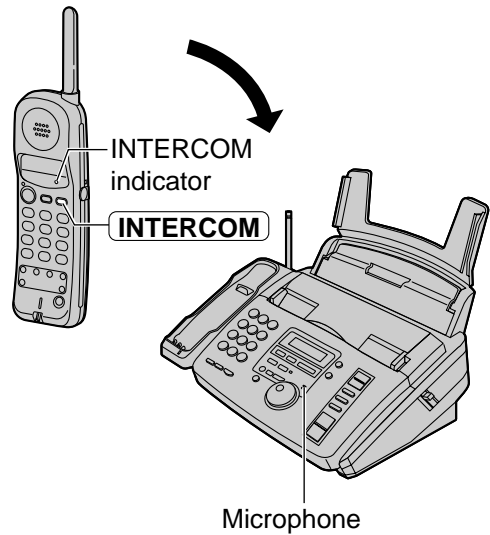

3 Handset:

When finished, press **INTERCOM**.

- The INTERCOM indicator will turn off.

Making and Answering Calls

Paging the handset from the main unit (handset locator)

Using this feature, you can locate the handset if it has been misplaced.

1 Main unit:

Press **LOCATOR/INTERCOM**.

- The IN USE indicator will flash and start paging the handset for 1 minute.
- The handset will display the following message.

Display:

Paging
Press INTERCOM

- To stop paging, press **LOCATOR/INTERCOM** again.

2 Handset:

Press **INTERCOM** to answer.

- The INTERCOM indicator will light.
- The IN USE indicator on the main unit will light.

3 Main unit:

Speak into the microphone.

- While using the intercom, the display will show:

For the main unit:

INTERCOM CALL

For the handset:

Intercom

(Example)

00-01-12 [■■■■]

4 Handset:

When finished, press **INTERCOM**.

- The INTERCOM and IN USE indicators will turn off.

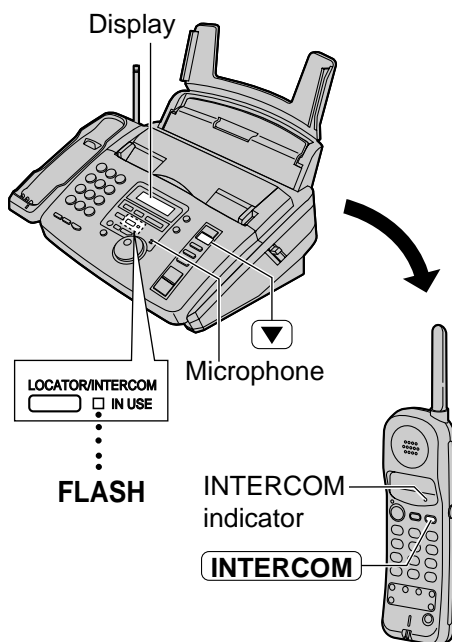

While using the intercom

- Intercom calls can only be ended by the handset.
- If the handset user has difficulty hearing the main unit user, ask the main unit user to decrease the speaker volume by pressing **▼**.

Making and Answering Calls

Transferring a call between the handset and the main unit

The intercom can be used during a call. This feature enables you to transfer a call between the handset and the main unit.

From the handset to the main unit

1 Handset:
During a call, press **INTERCOM**.

- The handset user can talk with the main unit user.
- The call will be put on hold.

Example:

Intercom hold
00-01-12 [■■■■]

2 Main unit:
Talk with the handset user through the microphone.

Display:

HOLD

↓

INTERCOM HOLD

3 Main unit:
To answer the call, press **DIGITAL SP-PHONE**.

- The transfer will be completed.

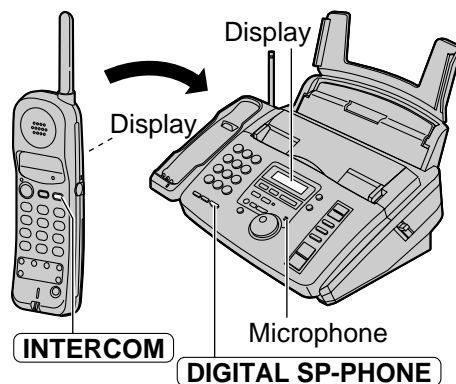

From the main unit to the handset

1 Main unit:
During a call, press **LOCATOR/INTERCOM** to page the handset.

- The call will be put on hold, and the following message will be displayed on the main unit and the handset.

For the main unit:

HOLD

For the handset:

Paging
Press INTERCOM

2 Handset:
Press **INTERCOM** to answer the page.

Example:

Intercom hold
00-01-12 [■■■■]

- The main unit will display the following message.

INTERCOM HOLD

3 Handset:
To answer the call, press **TALK**.

- The transfer will be completed.
- The main unit will display the following message.

CORDLESS IN USE

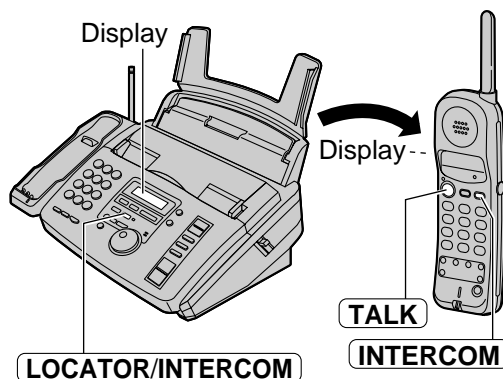

Making and Answering Calls

Remote speakerphone

Switching a call to the DIGITAL SP-PHONE with the handset

- 1 Handset:**
Press **REMOTE SP** on the handset during a call.

Display:
Remote sp-phone
00-00-27 [■■■■]

- The INTERCOM indicator flashes.
- The call is switched to the main unit.

- 2 Main unit:**
Talk into the microphone from a distance of about 20 cm (8 inches).

- To switch to the handset, see below.

- 3 Main unit:**
Press **DIGITAL SP-PHONE** to hang up.
• You can also hang up by pressing **REMOTE SP**.

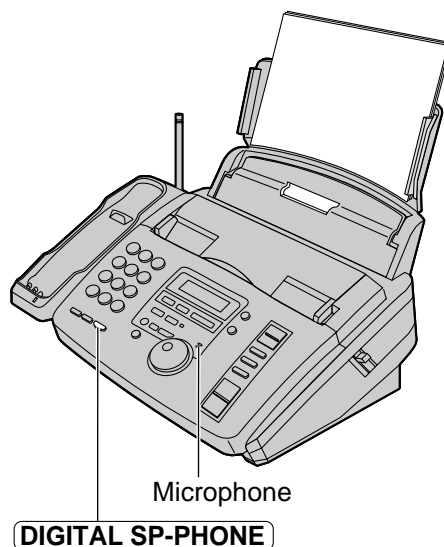
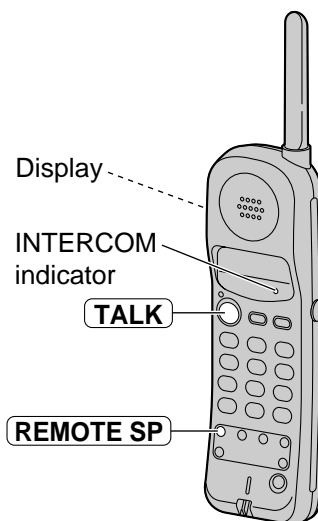

To switch to the handset (while using the remote speakerphone)

Press **TALK** on the handset.

- You can continue the conversation using the handset. The speakerphone will be disconnected.
- To hang up, press **TALK** or place the handset on the main unit.

Making and Answering Calls

Making a call using the handset as a remote control

- 1** Press **REMOTE SP**.
- On the main unit and the handset, the following message will be displayed.

For the main unit: TEL=

For the handset:
(Example) Remote sp-phone
00-00-27 [■■■■]

- 2** Dial the telephone number.

Example: Remote sp-phone
1234567
00-00-27 [■■■■]

- You can also dial with the main unit keypad.

Example: TEL=1234567

- 3** When you hear the other party, talk into the microphone on the main unit.
- To switch to the handset, see the bottom of page 30.

- 4** To hang up, press **REMOTE SP**.
- You can also hang up by pressing **DIGITAL SP-PHONE** on the main unit.

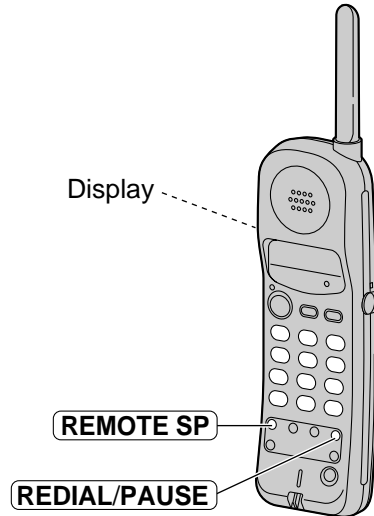

Answering a call using the handset as a remote control

- 1** When the handset rings, press **REMOTE SP**.
- On the main unit, the IN USE indicator lights and the following message will be displayed.

Display: CORDLESS IN USE

- 2** Talk into the microphone on the main unit.
- To switch to the handset, see the bottom of page 30.

- 3** To hang up, press **REMOTE SP**.
- You can also hang up by pressing **DIGITAL SP-PHONE** on the main unit.

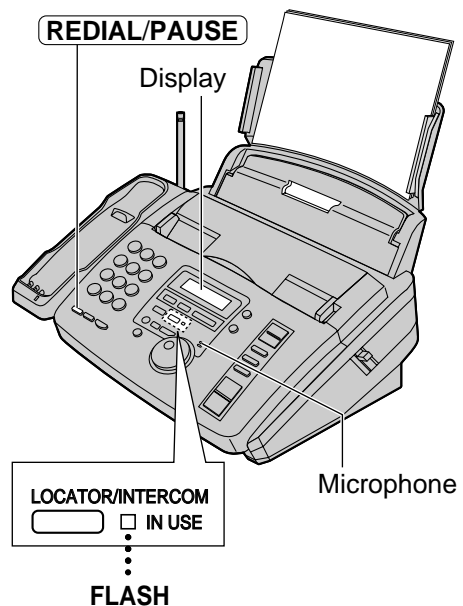

To redial the last number

The last number dialed will be redialed.

- The number to be redialed is different between the main unit and the handset.

- Press **REMOTE SP**.
- Press **REDIAL/PAUSE**.

Making and Answering Calls

Setting the auto talk feature

The Auto Talk feature allows you to answer a call by lifting the handset off the main unit without pressing **TALK**. This feature is set to "ON" as a default. If you want to view caller's information on the display after lifting the handset, turn this feature OFF by programming.

The TALK indicator light must be off before programming.

1 Press **PROGRAM**.

Display: Save AUTO# ?
v=Next ^=Yes

- The TALK indicator flashes.

2 Press repeatedly until the following is displayed.

Talk switching?
v=Next ^=Yes

3 Press .

Auto talk
v=On ^=Off

4 ■ To select OFF:
Press .

Auto talk
Off

■ To select ON:
Press .

Auto talk
On

- A long beep sounds.
- The handset will return to the stand-by mode.

Note:

- To answer a call when the auto talk feature is OFF, lift the handset off the base unit, and press **TALK**.

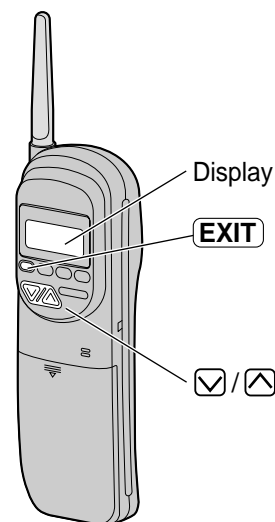
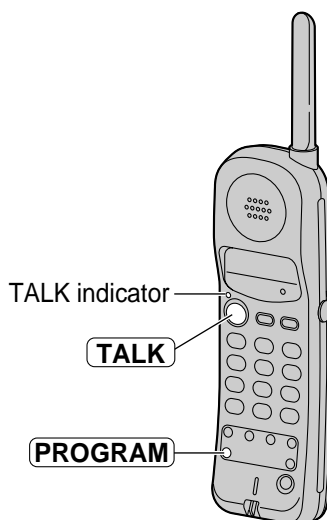

To cancel during programming

1. Press **EXIT** or **PROGRAM**.
2. Start again from step 1.

PHONE, FLASH and PAUSE buttons

PHONE button

The **PHONE** (*) button is used for rotary pulse dial services and allows you to temporarily change from pulse to tone mode during a dialing operation.

When you hang up, the unit will automatically return to the pulse mode.

FLASH/CALL WAIT button

The **FLASH/CALL WAIT** / **FLASH** button allows you to use special features of a host exchange (if connected) or local telephone company services such as call waiting. For further details, contact your host exchange supplier or local telephone company.

Entering pauses

When the **REDIAL/PAUSE** button is pressed during dialing, a pause will be inserted.

Example 1:

If your unit is connected to a host exchange, insert a pause to get an outside line.



Line access code

Example 2:

If a transmission error occurs during an overseas fax transmission, add two pauses at the end of the telephone number.

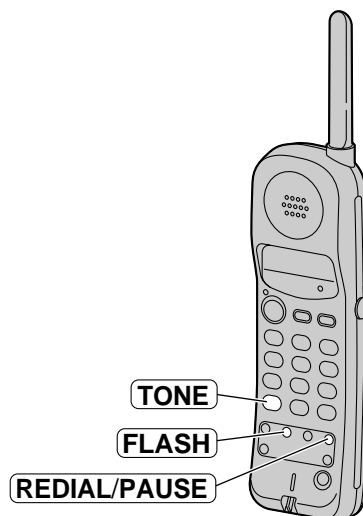
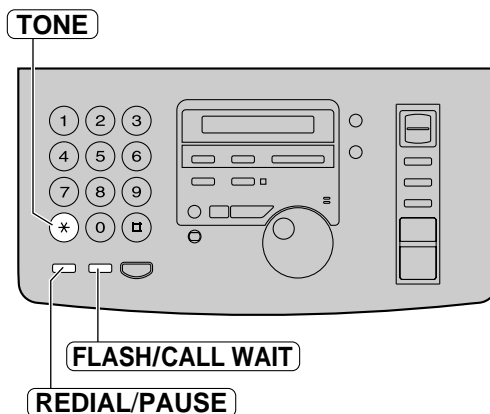
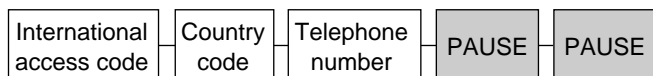

Note:

- TONE and PAUSE can be stored into a telephone number in the JOG DIAL directory.

Automatic Dialing (Handset)

Storing telephone numbers in the handset

You can store up to 10 telephone numbers in the handset. The dial keys (0 to 9) function as memory stations. Make sure the TALK indicator is off.

1 Press **PROGRAM**.

Display: Save AUTO# ?
v=Next ^=Yes

- The TALK indicator will flash.

2 Press **^**.

Enter phone no.

3 Enter the telephone number up to 22 digits.

Example: 3334444
AUTO=Save

- If you misdial, press **CLEAR**. Digits are erased from the right.
- To cancel during programming, press **PROGRAM** or **EXIT** to end storing, and start again from step 1.

4 Press **AUTO**.

Select 0-9
to save in AUTO

5 Press a memory station number (0 to 9).

Example: 3334444
Save in AUTO 1

- A one-beep confirmation tone will sound.
- The TALK indicator will turn off.
- To store other numbers, repeat steps 1 to 4.

Note:

- Numbers stored in the handset cannot be accessed by the main unit.
- A pause entered in a telephone number counts as one digit.

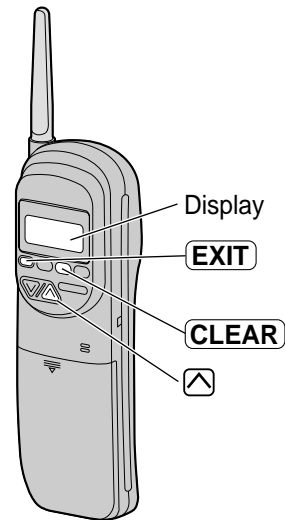
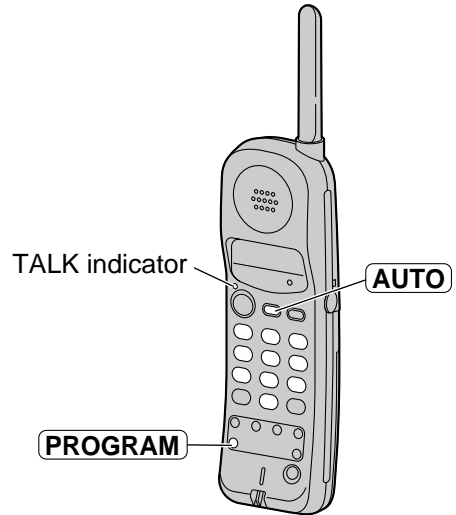

To erase a stored number

1. Press **PROGRAM**.
2. Press **^**.
3. Press **CLEAR**.

Display: AUTO=Clear

4. Press **AUTO**.
5. Press the memory station number (0 to 9) you want to erase.
 - 1 beep sounds and erasing is completed.

Automatic Dialing (Handset)

Making a voice call with the handset using stored numbers

- 1** Press **TALK**.
 - The TALK indicator will light.
- 2** Press **AUTO**.
- 3** Press the desired memory station number (0 to 9).
 - The stored telephone number will be dialed.
- 4** When you have finished talking, press **TALK**.
 - The TALK indicator will turn off.

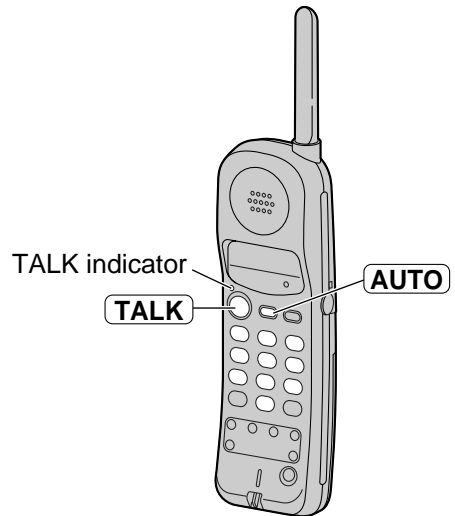

Note:

- Numbers stored in the handset cannot be accessed by the main unit.
- For further details on handset operation, see page 24.

Storing names and telephone numbers in the JOG DIAL directory

For rapid access to frequently dialed numbers, the unit provides a JOG DIAL directory (50 stations).

For your convenience, the following station has been pre-programmed.

HELP-FAX (1-800-435-7329): If you cannot correct a problem after trying the help function (p. 10), call using this station (p. 39).

If you do not need the above station, you can erase it (p. 38).

1 Press **DIRECTORY PROGRAM**.

Display: USE JOG-DIAL OR

↓

PRESS DIR.PROG.

2 Rotate **JOG DIAL** until the following is displayed.

NAME=

3 Enter the name, up to 10 characters, by following the instructions on the next page.

Example: NAME=Alice

4 Press **SET**.

NO. =

5 Enter the telephone number, up to 30 digits, using the dial keypad.

Example: NO. =5552233

- If you want to enter a hyphen, press **FLASH/CALL WAIT**.

6 Press **SET**.

REGISTERED

↓

NAME=

- To program other items, repeat steps 3 to 6.

7 Press **DIRECTORY PROGRAM** to exit the program.

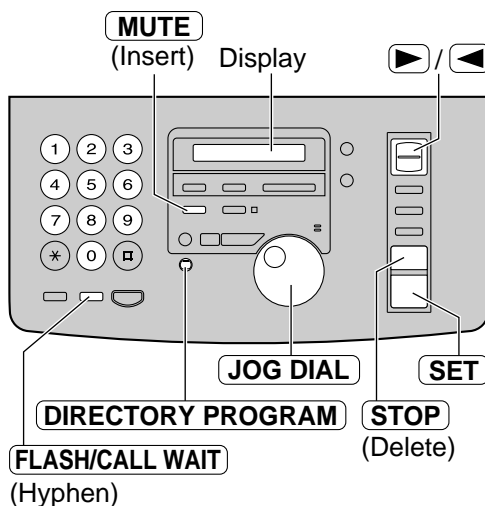

Helpful hint:

- You can confirm the stored items on the display (p. 39) or on the telephone number list (p. 105).

Note:

- When the following message is displayed in step 6, you can only store 5 more items.

Display: SPACE= 5 DIRS.

- If there is no space to store new stations, the following message is displayed in step 1.

JOG-DIAL FULL

Erase unnecessary stations (p. 38).

- A hyphen or a space entered in a telephone number counts as two digits.

To correct a mistake



- Press **▶** or **◀** to move the cursor to the incorrect character/number, and make the correction.

To delete a character/number

- Move the cursor to the character/number you want to delete and press **STOP**.

To select characters with the dial keypad

Pressing the dial keys will select a character as shown below.

Keys	Characters
①	1 [] { } + - / = , . _ ` : ; ?
②	A B C a b c 2
③	D E F d e f 3
④	G H I g h i 4
⑤	J K L j k l 5
⑥	M N O m n o 6
⑦	P Q R S p q r s 7
⑧	T U V t u v 8
⑨	W X Y Z w x y z 9
⑩	0 () < > ! " # \$ % & ¥ * @ ^ ' →
FLASH/CALL WAIT	Hyphen button (To insert a hyphen.)
MUTE	Insert button (To insert one character or one space.)
STOP	Delete button (To delete a character.)
	▶ key (To move the cursor to the right.) To enter another character using the same number key, move the cursor to the next space.
	◀ key (To move the cursor to the left.)

To select characters using the JOG DIAL

Instead of pressing the dial keys, you can select characters using the JOG DIAL.

1. Rotate **JOG DIAL** until the desired character is displayed.
2. Press  to move the cursor to the next space.
•The character displayed in step 1 is inserted.
3. Return to step 1 to enter the next character.

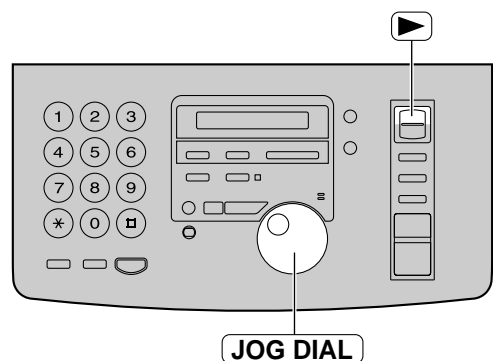

Display order of characters

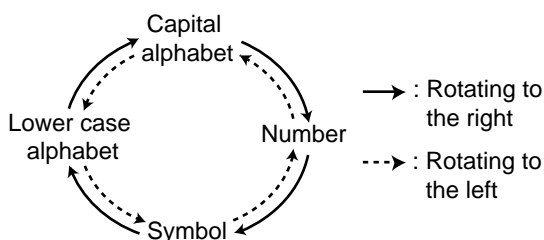

Editing/erasing a stored name and number

- 1** Rotate **JOG DIAL** until the desired name is displayed.

Example:

- 2** Press **DIRECTORY PROGRAM**.

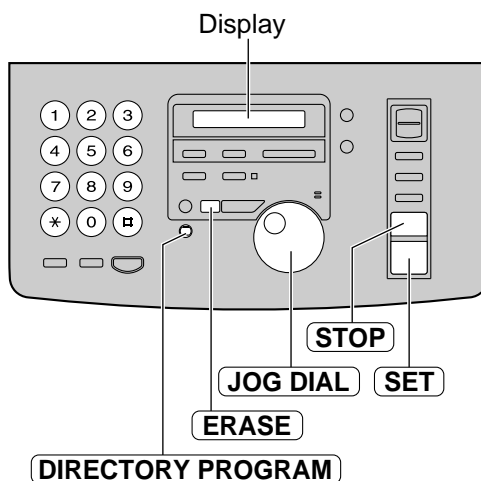

Editing

- 3** Press ***** to select "EDIT".

- If you do not need to edit the name, skip to step 5.

- 4** Edit the name by following the instructions on page 37.

- 5** Press **SET**.

Example:

- If you do not need to edit the telephone number, skip to step 7.

- 6** Edit the telephone number. For further details, see page 36.

- 7** Press **SET**.

Erasing

- 3** Press **#** to select "DELETE".



- To cancel erasing, press **STOP**.

- 4** Press **SET**.

- The stored name and number are deleted.

Note:

- You can use the following method to erase.
 1. Rotate **JOG DIAL** until the desired name is displayed.
 2. Press **ERASE**.
 3. Press **SET**.

Making a voice call using the JOG DIAL directory

Before using this feature, program the desired names and telephone numbers into the directory (p. 36).

- 1 Rotate **JOG DIAL** until the desired name is displayed.

Example:

- 2 ■ **Handset is off the main unit:**
Press **TALK** on the handset.

- **Handset is on the main unit:**
Press **DIGITAL SP-PHONE** or lift the handset.

- The unit will start dialing automatically.

- 3 When the other party answers, speak with the handset or talk into the microphone.

- 4 When finished talking, press **TALK** / **DIGITAL SP-PHONE** or replace the handset.

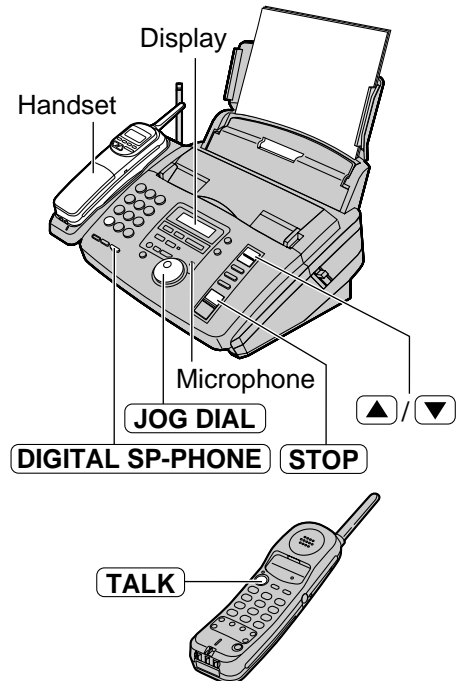

Helpful hint:

- You can confirm the stored items on the display (see below) or on the telephone number list (p. 105).

Note:

- If the desired name has not been stored, press **STOP** and dial the number manually.

To confirm the stored items on the display

1. Rotate **JOG DIAL** until the desired name is displayed.

Example:

2. Press **▲** or **▼**.

- To stop the operation, press **STOP**.

3. ■ **Handset is off the main unit:**
Press **TALK** on the handset.

- **Handset is on the main unit:**
Press **DIGITAL SP-PHONE** or lift the handset.

- The unit will automatically dial the number.

To search for a name by initial

Example: If you want to search for the name "Lisa"

1. Rotate **JOG DIAL** until any name is displayed.

Example:

2. Press **5** repeatedly until any name with the initial "L" is displayed (see the character table on page 37).

3. Rotate **JOG DIAL** to the right until "Lisa" is displayed.

- To stop the operation, press **STOP**.

4. ■ **Handset is off the main unit:**
Press **TALK** on the handset.

- **Handset is on the main unit:**
Press **DIGITAL SP-PHONE** or lift the handset.

- The unit will automatically dial the number.

Note:

- When you want to search for symbols (not letters or numbers), press ***#** in step 2.

Caller ID service from your phone company

This unit is compatible with the Caller ID service offered by your local telephone company. To use this feature, you must subscribe to Caller ID service.

Set the following ring count settings to 2 or more rings beforehand.

- TAD ring count and FAX ring count (feature #06 on page 83)
- TEL/FAX ring count (feature #78 on page 88)

How Caller ID is displayed

The calling party's name or telephone number will be displayed after the first ring. You then have the option of whether or not to answer the call depending on the caller.

■ Using the main unit

Example:

■ Using the handset

The unit will automatically store the caller's information (name and telephone number) and the time of the call. You can view the caller's information (p. 41, 42) and print the Caller ID list (p. 43).

Note:

- If the unit is connected to a PBX (Private Branch Exchange) system, you may not receive the caller's information. Consult your PBX supplier.
- If the unit cannot receive caller information, the unit will show the following.

■ Main unit

Display:

■ Handset

The caller dialed from an area which does not provide a Caller ID service.

The caller requested not to send any information.

The caller made a long distance call.

To check the number of new calls

■ While the handset is on the main unit:

If you have received 10 new calls, the handset will show the following.

Example:

When you lift the handset, the display changes to the following.

Example:

■ While the handset is off the main unit:

Press or to turn the display on. If you have received 10 new calls, the display will show the following.

Example:

- After 10 seconds, the display changes to the stand-by mode (p. 20)

Viewing caller information on the display

Once a call is received, the caller's information will be stored in the unit and the handset as a new call. After viewing, it will be stored as an old call.

Handset

1 ■ Handset is off the main unit:

Press  or .

■ Handset is on the main unit:

Lift the handset.

Example (2 new calls are received):

Display:

2 new calls
v=New ^=Old

2 ■ To search from the most recent to oldest call:

Press  repeatedly.

■ To search from the oldest to most recent call:

Press  repeatedly.

3 Press **EXIT** to stop viewing.

Note:

- Once new calls have been checked, "✓" will be added.

Example:

KEVIN PARKER
333-4444
11:50A JUN10 ✓

- If the following message is displayed in step 1, there is no caller information stored in the handset. Press **EXIT** to exit the list.

No caller data

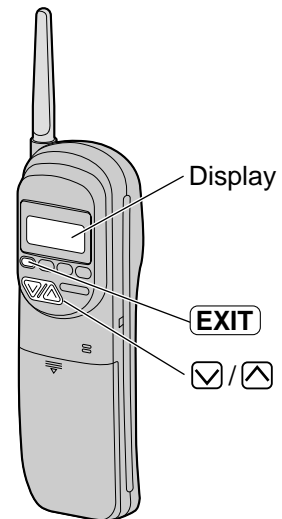

Main Unit

- 1 Press **CALLER ID SEARCH**.
Example (2 new calls are received):

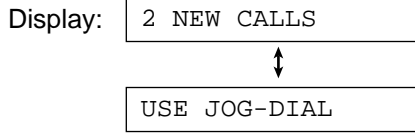

- 2
 - To search from the most recent to oldest call:
Rotate **JOG DIAL** to the right (clockwise).
 - To search from the oldest to the most recent call:
Rotate **JOG DIAL** to the left.

- 3 Press **STOP** to stop viewing.

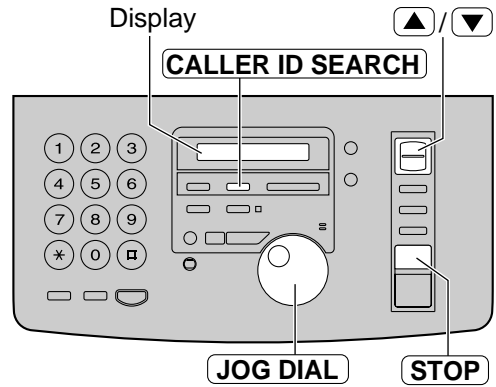

To search for caller information

■ Main Unit

- If the unit could not receive caller information, the main unit will show:
NO NAME RCVD
- After the last new call has been displayed, the main unit will show:
END OF NEW CALL
- After all calls are displayed, the main unit will show:
END
- If no calls have been received, the main unit will show:
NO CALLER DATA

■ Handset

- If no calls have been received, the handset will show:
No caller data

Note:

- If you want to know the caller's telephone number and the date/time of the call, press **▲** or **▼** repeatedly while the display shows the name.

Example:

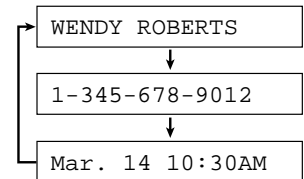

Confirming caller information using the Caller ID list

The unit will store caller information for up to 30 calls (Caller ID list).

- 1 To print the Caller ID list manually, press **PRINT**.

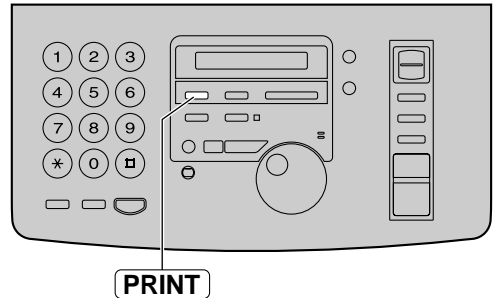

Sample of a Caller ID list

CALLER ID LIST				
Mar. 14 2000 11:37AM				
【 NEW 】				
NO.	NAME	TELEPHONE NUMBER	TIME OF CALL	ANSWER
01	WENDY ROBERTS	345-678-9012	Mar. 14 10:30AM	FAX
02	ALLAN STONE	456-789-0123	Mar. 13 08:35AM	TAD
【 OLD 】				
NO.	NAME	TELEPHONE NUMBER	TIME OF CALL	ANSWER
01	MIKE TIMAR	987-654-3210	Mar. 11 09:35AM	TEL

NEW: Shows a call you have not yet viewed.

OLD: Shows a call you have already viewed.

FAX: Facsimile reception

TAD: Telephone answering device responded.

TEL: Telephone call received.

(blank) : Not answered.

Note:

- The Caller ID list will be printed out automatically after every 30 new calls. This feature is set to "ON" as a default with feature #26 (p. 85). If you select "OFF", the unit will not print the list automatically but will store the records of received calls.
- When the total number of calls reaches 30 and a new call is received, the oldest data will automatically be erased.

Calling back/storing/editing/erasing caller information

In the handset

1 ■ **Handset is off the main unit:**
Press or .

■ **Handset is on the main unit:**
Lift the handset.

Example:

3 new calls
∇=New ∧=Old

2 Press or repeatedly until the desired name (or telephone number) is displayed.

Example:

CINDY TURNER
1-234-456-7890
11:20A JAN12

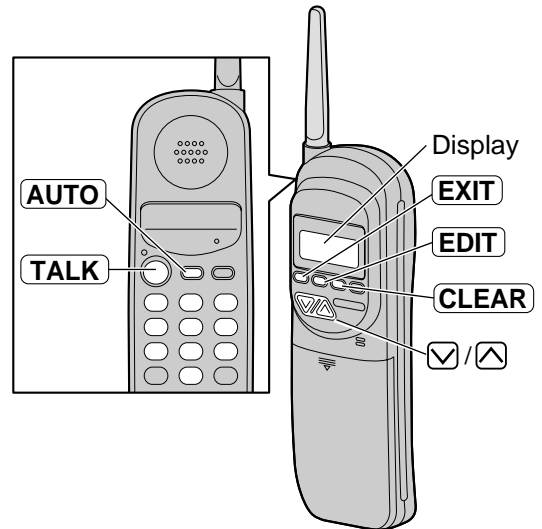

Calling back

3 Press **TALK**.

- The unit will start dialing automatically.

Important:

- This feature is not available in the following cases.
 - The telephone number includes data other than numbers (ie., * or #).
 - The caller's information does not include a telephone number.

Note:

- You can store up to 10 telephone numbers in the handset.
The dial keys (0 to 9) function as memory stations.
- Numbers stored in the handset cannot be accessed by the main unit.

Storing

3 Press **AUTO**.

Display:

Save in AUTO
Select 0-9

4 Press a station memory number (0 to 9).
Example (Store in station memory 0):

Example:

12344567890
Save in AUTO 0

- The telephone number will be stored.
- To store other items, repeat steps 2 to 4.
- Press **EXIT** to exit the program.

To edit the telephone number

Press **EDIT** repeatedly in step 2. Each time you press **EDIT**, the telephone number will change as follows.

1.

1	-	Area code	-	Local telephone number
---	---	-----------	---	------------------------

 ("1" added)
2.

Local telephone number

 (area code omitted)
3.

Area code	-	Local telephone number
-----------	---	------------------------
4.

1	-	Local telephone number
---	---	------------------------

 ("1" added and area code omitted)

Erasing

3 Press **CLEAR**.

- The caller's information will be erased.

Example:

Clear
↓
TOM REAGAN
444-5555
12:20A JAN12

- To erase other items, repeat steps 2 and 3.

4 Press **EXIT** to exit the program.

In the JOG DIAL of the main unit

1 Press **CALLER ID SEARCH**.

Example: 2 NEW CALLS

Display: USE JOG-DIAL

2 Rotate **JOG DIAL** until the desired name (or telephone number) is displayed.

Example: ALLAN STONE

Calling back

3 Press **DIGITAL SP-PHONE** or lift the handset.

- The unit will start dialing automatically.
- To send a fax – insert the document FACE DOWN and press **FAX START**. See pages 49 and 50 for details.

Important:

- This feature is not available in the following cases.
 - The telephone number includes data other than numbers (ie., * or #).
 - The caller's information does not include a telephone number.

Storing

3 Press **DIRECTORY PROGRAM**.

NAME=WENDY ROBE

- If the directory is full, a name and number cannot be stored. Erase unnecessary stations in the JOG DIAL directory (p. 38).

4 Press **SET**.

Example: NO.=3456789012

5 Press **SET**.

REGISTERED

- The name and telephone number will be stored.
- To store other items, repeat steps 2 to 4.

Erasing

3 Press **ERASE**.

- The caller's information will be erased.

DELETED

Example: ALLAN STONE

- To erase other items, repeat steps 2 and 3.

4 Press **STOP** to exit the program.



Note:

- You can confirm the stored items on the display (p. 39) or on the telephone number list (p. 105).
- You can only store a name up to 10 characters long.
- To edit items stored in the JOG DIAL directory, see page 38.



To edit the telephone number

Press ***** repeatedly in step 2. Each time you press *****, the telephone number will change as follows.

1. **1** – Area code – Local telephone number ("1" added)
2. Local telephone number (area code omitted)
3. Area code – Local telephone number
4. **1** – Local telephone number ("1" added and area code omitted)

Erasing all stored caller information

Handset

1 ■ Handset is off the main unit:
Press  or .

■ Handset is on the main unit:
Lift the handset.

Example:

0 new call
∨=New ∧=Old

2 Press .

Press CLEAR for
all clear

3 Press .

All clear

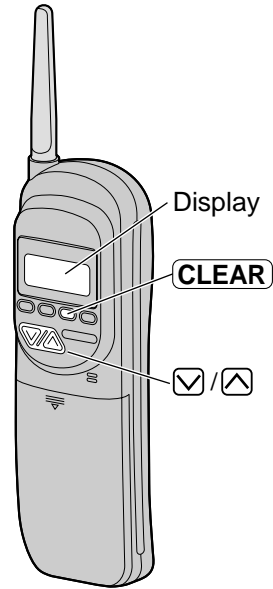

Main unit

1 Press  three times.

Display:



3.CALLER SET UP

2 Press .

CALL LIST ERASE

3 Press .

ALL ERASE OK?

- To cancel erasing, press , then .

4 Press .

ERASE COMPLETED

5 Press  to exit the program.

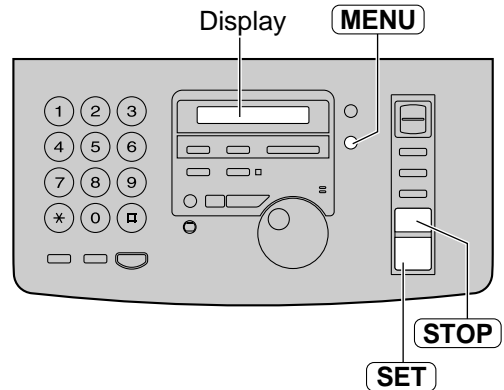

For call waiting service users

Visual Call Waiting (Call Waiting ID) Service

Visual Call Waiting (Call Waiting ID) Service allows your handset to display the second caller's information.

- 1** When you receive a second call, you will hear a call-waiting tone, and the display will show:

For the handset:
(Example)

NANCY BROWN
1-000-222-3333
----Waiting----

For the main unit:
(Example)

NANCY BROWN

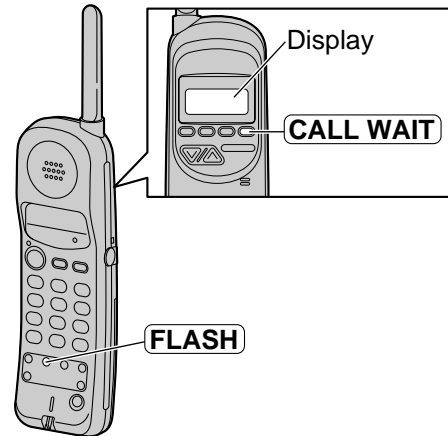

- 2** Press **FLASH/CALL WAIT** or **FLASH/**
CALL WAIT .

- The first call is put on hold and you can answer the second call.
- To return to the first caller, press **FLASH/CALL WAIT** or **FLASH/**
CALL WAIT .

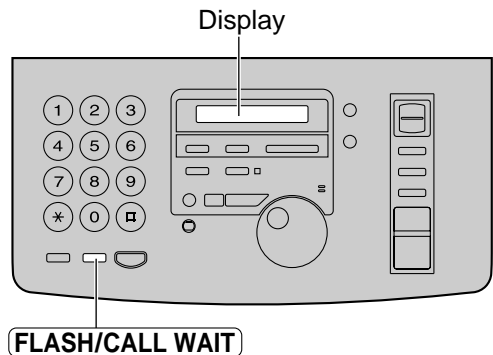

Note:

- The second caller's information will not be displayed when:
 - you are having a conversation with the main unit while the handset is off the main unit,
 - the answering system is recording someone's message,
 - a parallel connected telephone is in use, or
 - you are sending or receiving a document.
- Please contact your telephone company for details and availability in your area.

Voice Contact

Talking to the other party after fax transmission or reception

You can talk to the other party after a fax message is completed. This will save the added expense and time of making another call.

This feature only works when the other party's fax machine is equipped with a voice contact feature.

Initiating voice contact

- 1** Press **DIGITAL SP-PHONE** while transmitting or receiving documents.

Display: VOICE STANDBY

- Your unit will call the other party with a distinctive ring.
- When the other party answers, your unit will emit a distinctive ring.

- 2** To start talking:
- Press **DIGITAL SP-PHONE**,
 - Lift the handset, or
 - Press **TALK** on the handset.

Note:

- If you initiate voice contact during transmission, the unit will call you with a distinctive ring after all of the documents have been transmitted.
- If you initiate voice contact during reception, the unit will call you with a distinctive ring after the current page of the document has been received.

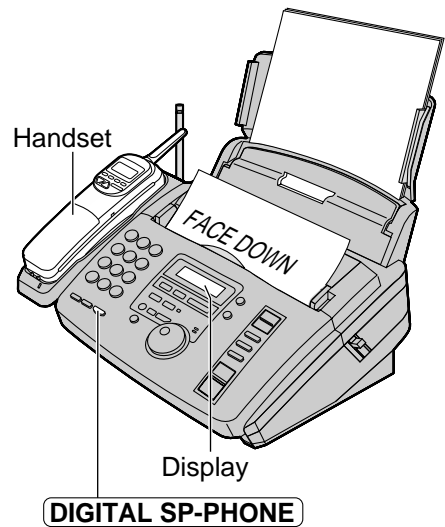

Receiving a request for voice contact

- 1** If the other party initiates voice contact, your unit will sound a distinctive ring and the following will be displayed.

Display: PLEASE PICK UP

- 2** To start talking:
- Press **DIGITAL SP-PHONE**,
 - Lift the handset, or
 - Press **TALK** on the handset.
- within 10 seconds of the distinctive ring to start talking.

Note:

- If you do not answer within 10 seconds of the distinctive ring;
 - In the TAD/FAX mode, your unit will play a greeting message and record an incoming voice message.
 - In the FAX ONLY, TEL or TEL/FAX mode, the line will be disconnected.

Sending a fax manually/using the JOG DIAL directory

1 Adjust the width of the document guides to the size of the document.

2 Insert the document (up to 10 pages) **FACE DOWN** until a single beep is heard and the unit grabs the document.

Display: STANDARD

3 If necessary, press **RESOLUTION** repeatedly to select the desired setting (see right).

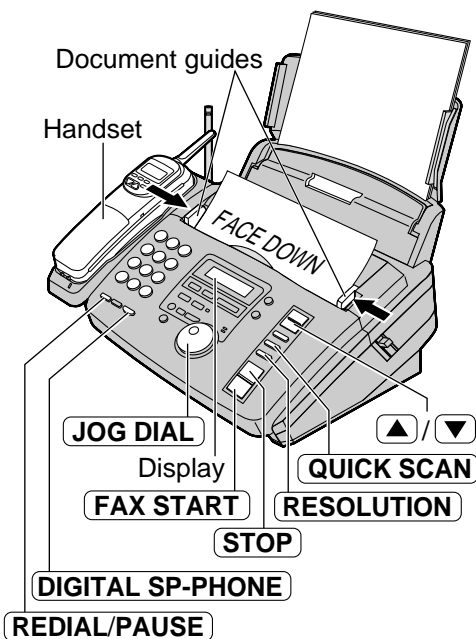

Manually

4 Press **DIGITAL SP-PHONE** or lift the handset.

TEL=

5 Dial the fax number.

Example: TEL=5678901

6 **When a fax tone is heard:**

Press **FAX START**, and replace the handset if using it.

OR

When the other party answers your call:

Ask them to press their start button. When a fax tone is heard, press **FAX START** and replace the handset if using it.

CONNECTING.....

Using the JOG DIAL directory

4 Rotate **JOG DIAL** until the desired name is displayed.

Example: Alice

- To confirm the number, press **▲** or **▼**.
- For further details about using the JOG DIAL, see page 39.

5 Press **FAX START**.

FAX=<Alice>

↓
CONNECTING.....

To select the resolution

Select the desired resolution according to the type of document.

STANDARD: For printed or typewritten originals with normal-sized characters.

FINE: For originals with small printing.

SUPER FINE: For originals with minute printing.

HALF TONE: For originals containing photographs, shaded drawings, etc.

- Using the "FINE", "SUPER FINE" or "HALF TONE" setting will increase the transmission time.
- If the resolution setting is changed during feeding, it will be effective from the next sheet.
- The "SUPER FINE" resolution only works with other compatible fax machines.

From memory

You can press **QUICK SCAN** instead of **FAX START** to scan the document into memory before sending.

After storing, the unit will transmit the document.

- The memory capacity is approx. 25 pages based on the ITU-T No. 1 Test Chart in standard resolution (p. 109).
- If the document exceeds the memory capacity, sending will be canceled.

Sending Faxes

To transmit more than 10 pages at a time

Insert the first 10 pages of the document. Add the extra pages (up to 10) before the last page is fed into the unit.

To stop transmission

Press **STOP** .

To redial the last number

Press **REDIAL/PAUSE** .

- If the line is busy, the unit will automatically redial the number up to 2 times.
- During redial, the following will be displayed.

Display:

WAITING REDIAL

- To cancel redialing, press **STOP** .

Fax auto redial for the JOG DIAL directory

If the line is busy or there is no answer when using the JOG DIAL directory, the unit will automatically redial the number up to 2 times.

- This feature is also available for delayed transmission (feature #25 on page 84).
- During redial, the following will be displayed.

Display:

WAITING REDIAL

- To cancel redialing, press **STOP** .

Convenient way to send a fax

You can dial the fax number first before inserting the document. This is convenient if the other party's number is indicated on the document.

1. Enter the fax number.
 - The handset must be on the cradle.
2. Insert the document.
3. Press **FAX START** .

If your unit does not send a fax using the JOG DIAL directory

- Confirm the stored items on the display (p. 39) or on the telephone number list (p. 105).
- Check that the number dialed is answered by the other party's machine.
 1. Rotate **JOG DIAL** until the desired name is displayed.
 2. Press **DIGITAL SP-PHONE** .
 - The connecting tone will be heard during dialing to tell you the status of the other party's machine (feature #76 on page 88).

Documents you can send

Minimum size

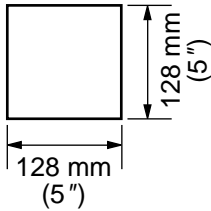

Maximum size

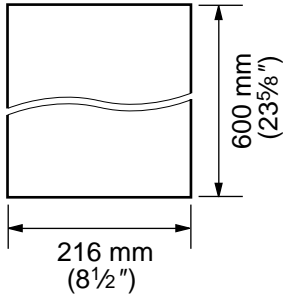

Effective scanning area

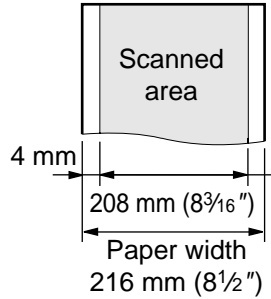

Document weight

Single sheet:

45 g/m² to 90 g/m²
(12 lb. to 24 lb.)

Multiple sheets:

60 g/m² to 75 g/m²
(16 lb. to 20 lb.)

Note:

- Remove clips, staples or other similar fastening objects.
- Check that ink, paste or correction fluid has dried.
- Do not send the following types of documents. Use copies for fax transmission.
 - Chemically treated paper such as carbon or carbonless duplicating paper
 - Electrostatically charged paper
 - Heavily curled, creased or torn paper
 - Paper with a coated surface
 - Paper with a faint image
 - Paper with printing on the opposite side that can be seen through the front (e.g. newspaper)

Sending Faxes

Reports for confirmation

To confirm the communication results, the following reports are available.

Sending report

This report will provide you with a printed record of fax transmission results. To use this feature, activate feature #04 (p. 83).

Sample of a sending report

SENDING REPORT									
Jan. 20 2000 09:19AM									
YOUR LOGO :									
YOUR FAX NO. :									
NO.	OTHER FACSIMILE	START TIME	USAGE TIME	MODE	PAGES	RESULT	*CODE		
01	2345678	Jan. 20 09:18AM	00'51	SND	00	COMMUNICATION ERROR	43		

SND: Sent directly.

Communication
message (p. 89)

Error code

Journal report

The unit stores the 30 most recent fax communication results. When a new communication occurs, the oldest communication result will be erased.

—To print manually, see page 105.

—To print automatically after every 30 new fax communications, select “ON” with feature #22 (p. 84).

If you select “OFF”, the unit will not print the journal automatically but store the records of fax communications.

Sample of a journal report

JOURNAL									
Jan. 25 2000 11:22AM									
YOUR LOGO :									
YOUR FAX NO. :									
NO.	OTHER FACSIMILE	START TIME	USAGE TIME	MODE	PAGES	RESULT	*CODE		
01	3332222	Jan. 21 07:14AM	00'45	SND	01	OK			
02	9998765	Jan. 21 08:17AM	00'58	RCV	02	OK			
03	John	Jan. 21 09:18AM	00'48	RCV	01	OK			
04	555556677	Jan. 21 10:25AM	02'45	SND	03	COMMUNICATION ERROR	43		
				SND	05	OK			
				SND	02	OK			

SND: Sent directly.

RCV: Received directly.

Communication
message (p. 89)

Error code

Sending a fax with the voice guide

You can send documents by following the voice guide. After transmission, the voice guide will turn off automatically.

1 Press **HELP** twice.

Display: 1.SEND GUIDE

2 Press **SET**.

Voice guide:

To transmit, insert the document face down until you hear the beep.

3 Insert the document **FACE DOWN**.

- If necessary, press **RESOLUTION** repeatedly to select the desired setting (p. 49).

Press the speaker phone button, then dial the phone number. When the fax tone is heard, press the start button.

4 Press **DIGITAL SP-PHONE**.

- You can also use the handset.

5 Dial the fax number.

6 When a fax tone is heard, press **FAX START**.

Start transmission.

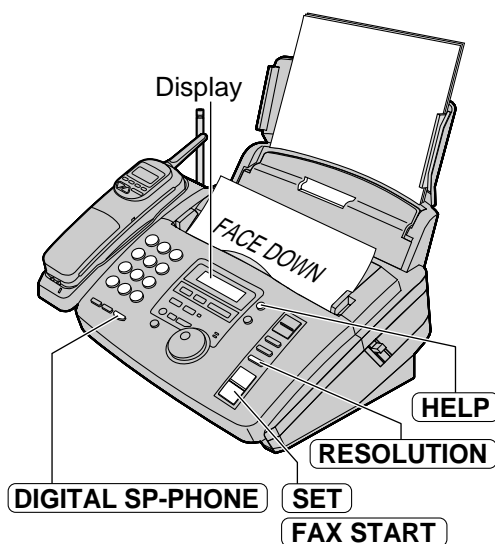

Sending Faxes

One time broadcast transmission

This feature is useful for sending the same document to selected parties whose fax numbers are stored in the JOG DIAL directory. If you only wish to send a document once, select the parties for each transmission.

Before programming, make sure that the desired stations have been stored in the JOG DIAL directory (p. 36).

- 1 Insert the document **FACE DOWN**.
 - If necessary, press **RESOLUTION** repeatedly to select the desired setting (p. 49).
- 2 Rotate **JOG DIAL** until the following is displayed.
Display: <ONE TIME BROAD>
- 3 Press **SET**.
DIR= [000]
- 4 Rotate **JOG DIAL** until the desired name is displayed.
Example: Bill [000]
- 5 Press **SET**.
DIR=Bill [001]
 - To program other stations, repeat steps 4 and 5 (up to 20 stations).
- 6 Press **FAX START** after programming all of the desired stations.
 - The document will be fed into the unit and scanned into memory. The unit will then transmit the data to each station, calling each number sequentially.
 - After transmission, the stored document will be erased automatically, and the unit will automatically print a broadcast sending report (p. 57).

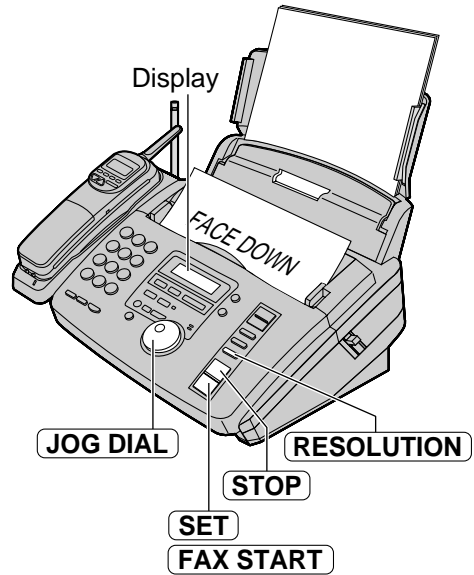

Note:

- If you select the "FINE", "SUPER FINE" or "HALF TONE" resolution, the number of pages that the unit can transmit will decrease.
- If one of the stations is busy or does not answer, the station will be skipped. All skipped stations will be redialed up to 2 times after all of the other stations have been called.

To cancel the broadcast setting

1. Press **STOP** while the unit displays the following message.

Display: BROADCASTING

- The display will show the following.

SEND CANCELED?



YES: SET/NO: STOP

2. Press **SET**.

Broadcast transmission to pre-programmed parties

This feature is useful for sending the same document often to selected parties whose fax numbers are stored in the JOG DIAL directory. First program the parties (see below) then see page 57 for transmission.

Before programming, make sure that the desired stations have been stored in the JOG DIAL directory (p. 36).

Programming the stations in the broadcast memory

1 Press **DIRECTORY PROGRAM** twice.

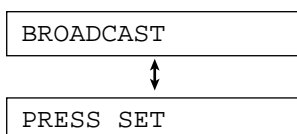

2 Press **SET**.

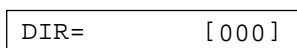

3 Rotate **JOG DIAL** until the desired name is displayed.

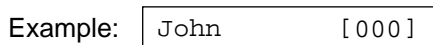

4 Press **SET**.

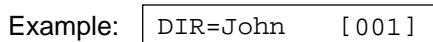

- To program other stations, repeat steps 4 and 5 (up to 20 stations).

5 Press **SET** after programming all of the desired stations.

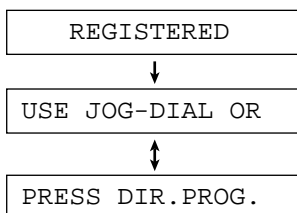

6 Press **STOP** to exit the program.

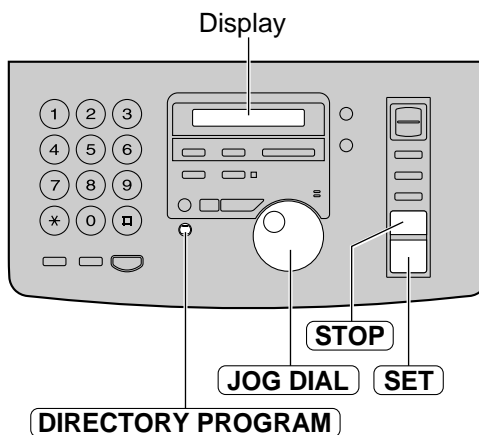

Note:

- If you enter the wrong station, press **STOP** after step 4 to erase the station.
- Confirm the stored numbers by printing a broadcast programming list (p. 105).

Sending Faxes

Adding/erasing a station in the broadcast memory

1 Rotate **JOG DIAL** until the following is displayed.

Display: <BROADCAST>

2 Press **DIRECTORY PROGRAM**.

ADD=* DELETE=#

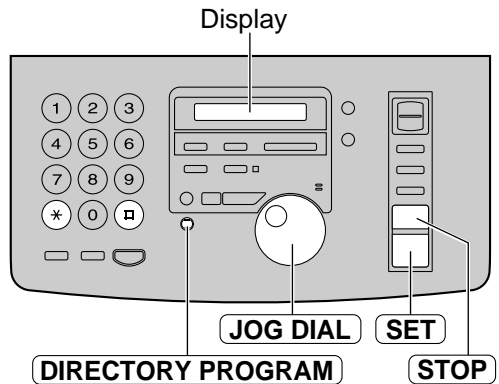

Adding

3 Press ***** to select "ADD".

4 Rotate **JOG DIAL** until the desired name is displayed.

Example: Mike

5 Press **SET**.

REGISTERED

Example: Nikki

- To add other stations, repeat steps 4 and 5 (up to 20 stations).

6 Press **DIRECTORY PROGRAM** to exit the program.

Erasing

3 Press **#** to select "DELETE".

4 Rotate **JOG DIAL** until the desired name is displayed.

Example: Dick

- To cancel erasing, press **STOP**.

5 Press **SET**.

DELETE OK?

YES:SET/NO:STOP

6 Press **SET**.

DELETED

Example: Bob

- To delete other stations, repeat steps 4 to 6.

7 Press **DIRECTORY PROGRAM** to exit the program.

Sending to pre-programmed parties in the broadcast memory

The same document will be sent to the specific parties whose numbers are stored in broadcast memory.

The memory capacity is approx. 25 pages based on the ITU-T No. 1 Test Chart in standard resolution (p. 109).

- 1 Insert the document **FACE DOWN**.
 - If necessary, press **RESOLUTION** repeatedly to select the desired setting (p. 49).

- 2 Rotate **JOG DIAL** until the following is displayed.

Display: <BROADCAST>

- 3 Press **FAX START**.
 - The document will be fed into the unit and scanned into memory. The unit will then transmit the data to each station, calling each number sequentially.
 - After transmission, the stored document will be erased automatically, and the unit will automatically print a broadcast sending report (see below).



Note:

- If you select the “FINE”, “SUPER FINE” or “HALF TONE” resolution, the number of pages that the unit can transmit will decrease.
- If one of the stations is busy or does not answer, the station will be skipped. All skipped stations will be redialed up to 2 times after all of the other stations have been called.

To cancel the broadcast setting

1. Press **STOP** while the unit displays the following message.

Display: BROADCASTING

- The display will show the following.

SEND CANCELED?
 ↓
YES: SET/NO: STOP

2. Press **SET**.

Sample of a broadcast sending report

BROADCAST REPORT					
NO.	OTHER FACSIMILE	START TIME	USAGE TIME	PAGES	RESULT
YOUR LOGO : Jan. 10 2000 09:36AM					
YOUR FAX NO. :					
01	Mike	Jan. 10 09:31AM	01'10	02	OK
02	Peter	Jan. 10 09:33AM	01'08	02	OK
03	Sam	Jan. 10 09:34AM	01'09	02	OK
04	Kim	Jan. 10 09:35AM	01'10	02	OK
TOTAL			004'37	008	

Receiving Faxes

Setting the unit to receive faxes

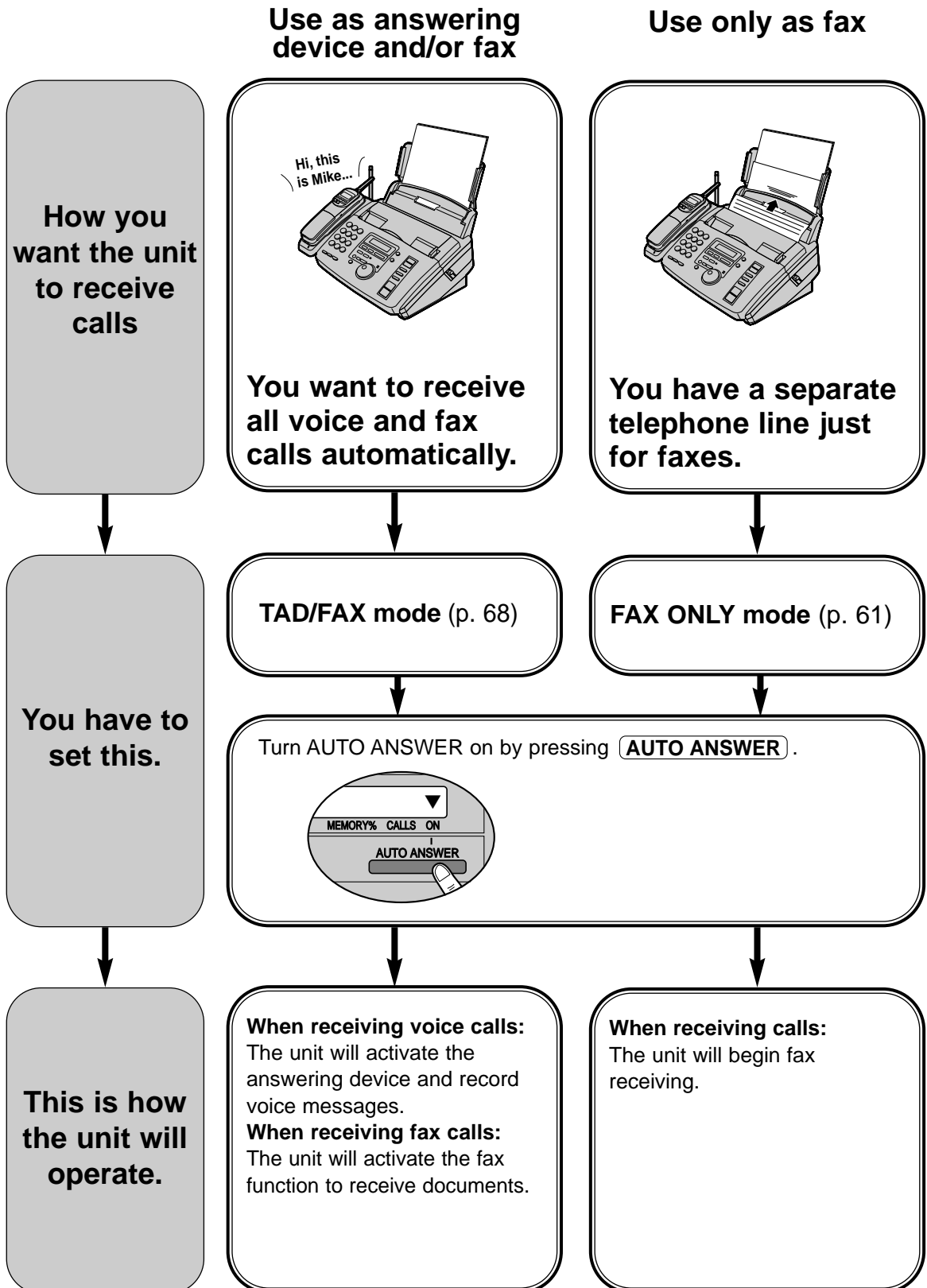

Voice mail service (Distinctive Ring)

2-number example

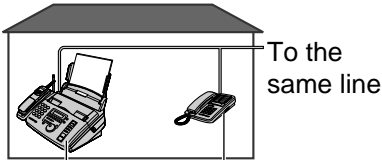

Facsimile No. (555-1333) Telephone No. (555-1111)

You need to subscribe to Distinctive Ring Service.

Setting the Distinctive Ring pattern (feature #31 on page 85)

Select the same ring pattern assigned to the facsimile number.

- A:** Standard ring (one long ring)
- B:** Double ring (two short rings)
- C:** Triple ring (short-long-short rings)
- D:** Other triple ring (short-short-long rings)

When the fax machine detects a call matching the selected Distinctive Ring pattern: The fax machine will activate the fax function.

When the fax machine detects other ring patterns: The fax machine will operate based on the AUTO ANSWER setting.

Mostly voice calls



You plan to answer the calls yourself.

TEL mode (p. 60)

Turn AUTO ANSWER off by pressing **AUTO ANSWER**.

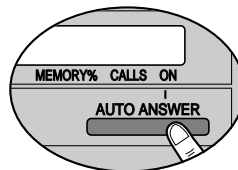

When receiving calls:

You have to answer all calls manually.
To receive a fax document, press **FAX START** for each fax call.

Other options

With PC

If you have a computer attached to the same telephone line, see page 64.

TEL/FAX mode

If you are near the unit and want to use it to receive voice calls yourself and fax calls automatically, see pages 62 and 63.

Remote fax activation

You can also receive a fax from an extension phone. If you answer a call with an extension phone and hear the fax calling tone, press *** 9** (pre-selected fax activation code) to receive a fax (p. 64).

Receiving Faxes

TEL mode (answering all calls manually)

Activating the TEL mode

If the arrow (▼) is shown on the right of the display, turn it off by pressing **AUTO ANSWER**.

Display: TEL MODE ON

Receiving a fax manually

■ With the main unit

- 1 When the unit rings, lift the handset to answer the call.
- 2 When:
 - document reception is required,
 - a fax calling tone (slow beep) is heard, or
 - no sound is heard,press **FAX START**.

CONNECTING.....

- 3 Replace the handset.
 - The unit will start fax reception.

■ With the handset

- 1 When the handset rings, press **TALK**.
- 2 When:
 - document reception is required,
 - a fax calling tone (slow beep) is heard, or
 - no sound is heard,press **FAX** until a single beep is heard.
 - The only way to stop receiving a fax is by pressing **STOP** on the main unit.

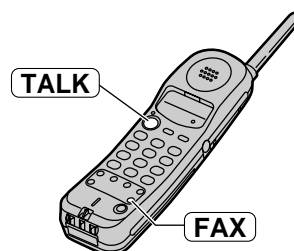
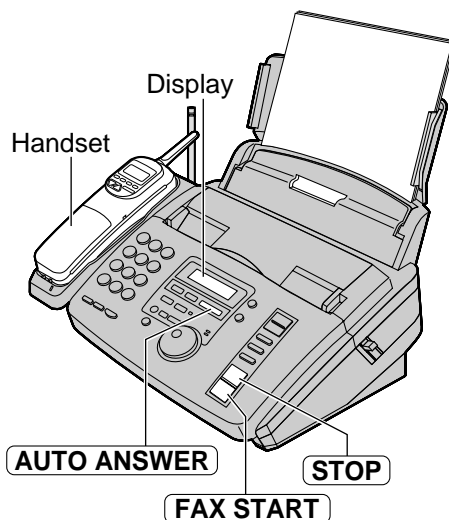

Note:

- If you do not answer the call within 15 rings, the unit will temporarily activate the answering device. The greeting message will then be played. If the remote operation ID (feature #11 on page 83) is entered during the greeting message, the unit will change to the TAD/FAX mode.
- Up to 30 sheets of printed paper can be held. Remove the printed paper before it exceeds 30 sheets.

To stop receiving

Press **STOP**.

Friendly reception feature

When you answer a call and hear a fax calling tone (slow beep), the unit will automatically start fax reception.

- If this feature is not required, set feature #46 to "OFF" (p. 86).

Fax reception in memory

When a printing problem is detected, the unit will temporarily store the received document into memory.

While the document is in memory;

- the display will show an error message and the following message alternately.

Display: FAX IN MEMORY

- slow beeps will sound (memory reception alert). See feature #44 on page 86.
- Follow the instructions on pages 90 and 91 to solve the problem.
- For memory capacity, see page 109.

FAX ONLY mode --- --- (all calls are received as faxes)

Activating the FAX ONLY mode

1 Set feature #77 to "FAX ONLY" (p. 88).

2 If the arrow (▼) is not shown on the right of the display, turn it on by pressing **AUTO ANSWER**.

- The display will show the number of rings before the unit answers a call in the FAX ONLY mode.

Display:

PICKUP & RCV FAX

↓

AFTER 3 RINGS ↻

3 If necessary, rotate **JOG DIAL** until the desired ring count is displayed, and press **SET**.

Display:

▼

ON

- When receiving calls, the unit will automatically answer all calls and only receive fax documents.

Note:

- If the arrow (▼) is already shown on the right of the display and you wish to change the ring count, turn the arrow off once then on again by pressing **AUTO ANSWER** and follow the instructions in step 3.
- This mode should not be used with a telephone line which is used for both voice and fax calls. Fax communication will be attempted even if someone is trying to call you.

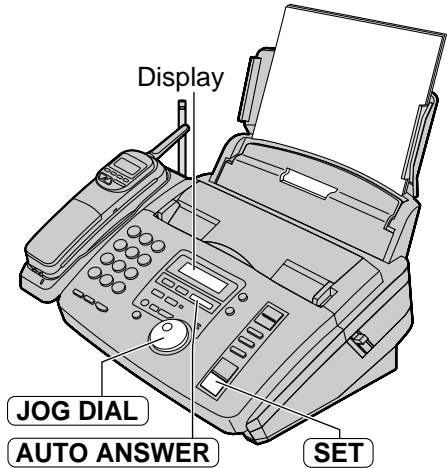

If you have a telephone line just for faxes, we recommend the following setup.

Example: One telephone line is used for voice calls and a separate telephone line for faxes.

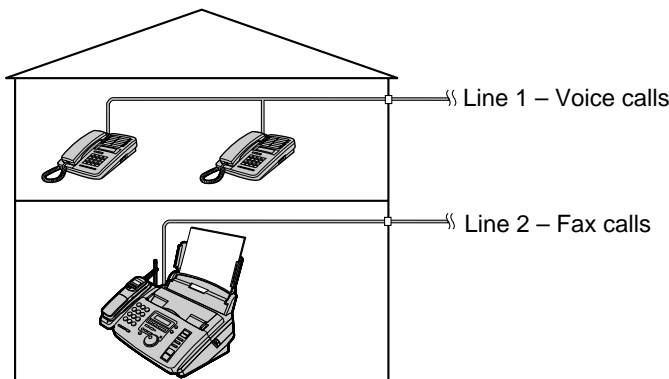

Only a fax machine is connected.

Receiving Faxes

TEL/FAX mode (receiving voice calls with rings and fax calls without rings when you are near the unit)

Use this mode when you are always near the fax machine, and want to receive faxes without ringing. When a call is received, the fax machine will work as follows. To set the TEL/FAX mode, see below.

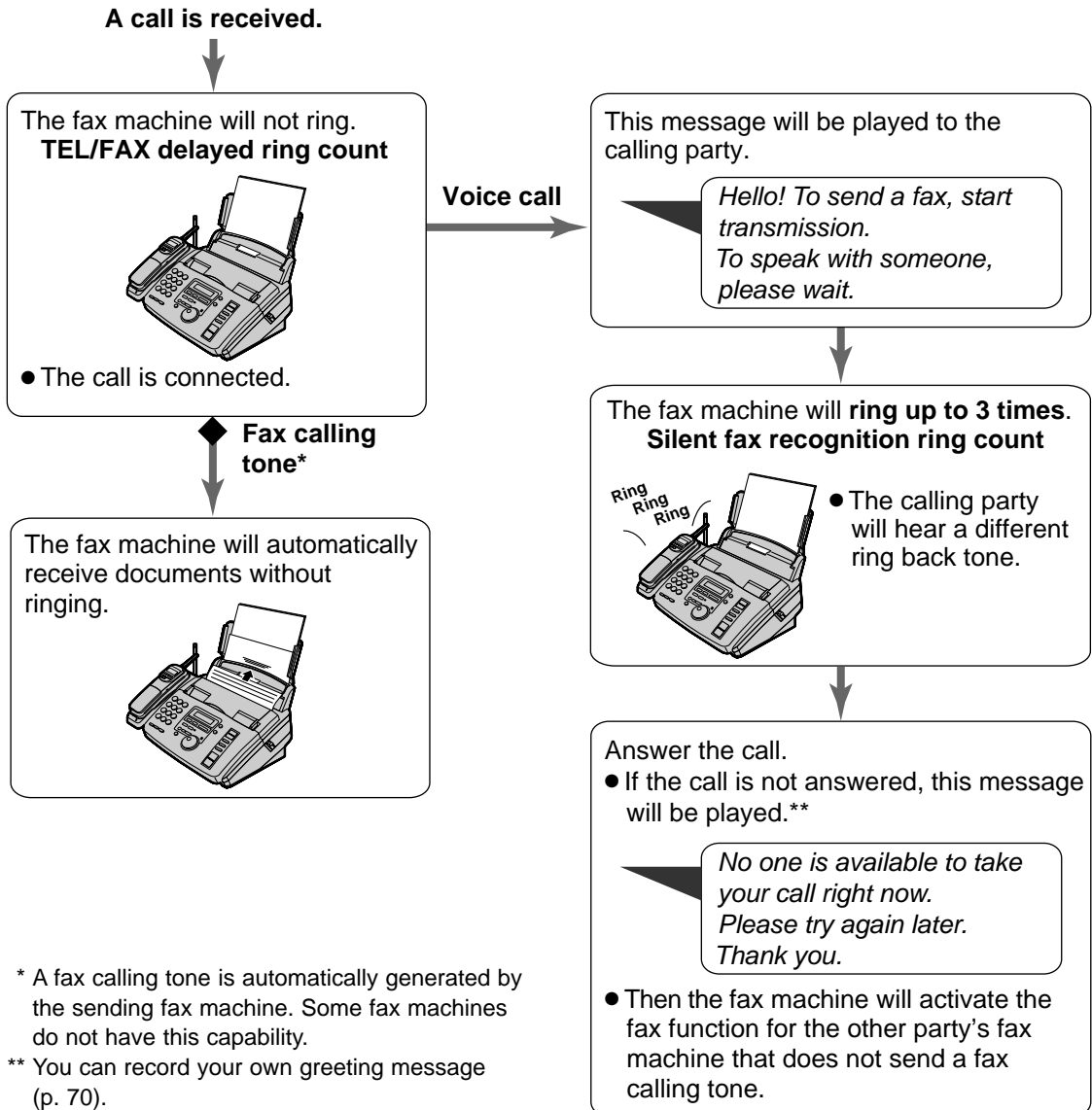

Note:

- The fax machine will display the following when a call is received.

Display:

- The ringer should be on (p. 22, 23).

To set the TEL/FAX mode

1. Set feature #77 to "TEL/FAX" (p. 88).
2. If the arrow (▼) is not shown on the right of the display, turn it on by pressing **AUTO ANSWER**.

Display:
ON

When an extension telephone is connected

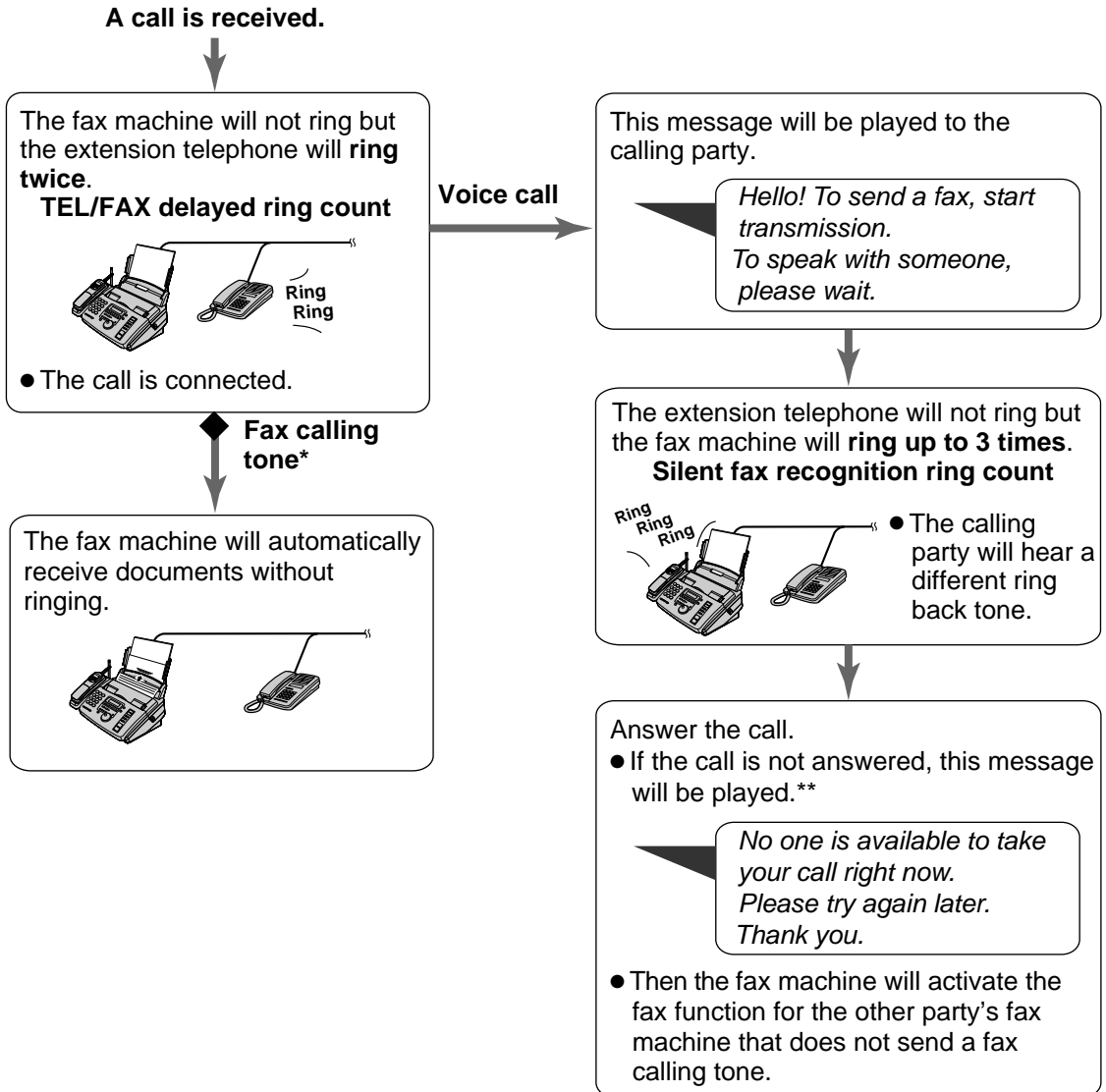

TEL/FAX delayed ring count

The number of rings generated before the fax machine answers depends on the setting of feature #78 on page 88. The fax machine will not generate an audible ring during this time.

Silent fax recognition ring count

The fax machine generates audible rings to indicate that it is receiving a voice call. The number of rings generated depends on the setting of feature #30 on page 85. This signal will not ring at an extension telephone.

Receiving Faxes

Using the unit with a computer

We recommend you use separate wall jacks for the unit and the computer.

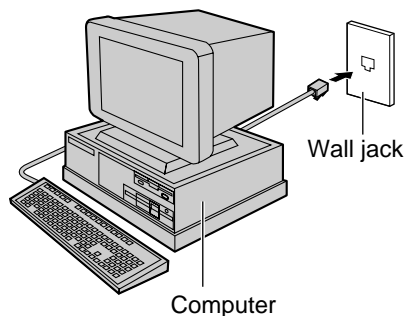
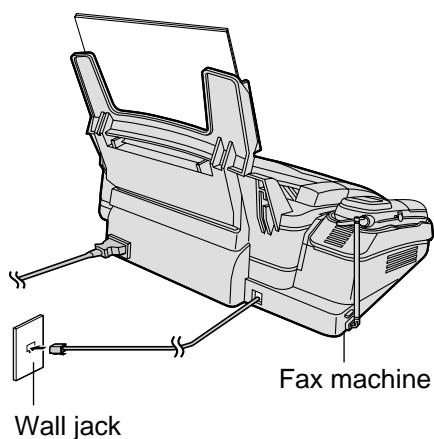

Note:

- Set the fax machine to the TEL mode.
- The device which has the shortest ring count will answer a call first.

Extension telephone

If you use the fax machine with an extension telephone, you can receive fax documents using the extension telephone.

You do not have to press **FAX START** on the fax machine.

Important:

- Use a touch tone telephone as the extension telephone and enter the fax activation code **firmly**.

1 When the extension telephone rings, lift the handset of the extension telephone.

2 When:
— document reception is required,
— a fax calling tone (slow beep) is heard, or
— no sound is heard,
press *** 9** (pre-selected fax activation code) **firmly**.

3 Hang up the handset.
• The fax machine will start reception.

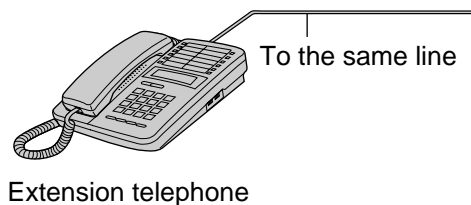

Note:

- You can change the fax activation code in feature #41 (p. 85).

Pager call - when the unit receives a fax or voice message

This feature allows your unit to call your pager when your unit receives a fax document or an incoming voice message.

- If you have subscribed to a Caller ID service, your pager will display the caller's telephone number before the number "11" or "22" (see below).

1 Press **MENU**.
Display: 1. SYSTEM SET UP

2 Press **□**, then **7 0**.
PAGER CALL

3 Press **SET**.
MODE=OFF ↻

4 Rotate **JOG DIAL** to select "ON".
MODE=ON ↻

- If this feature is not required, select "OFF".

5 Press **SET**.
NO. =

6 Enter your pager number.
• You can enter a total of 46 digits and/or pauses.

Example:

1 202 555 1234PP12345678PP
 Your pager number Pauses Your pager access code, if required.

7 Press **SET**.
• The unit will dial the stored number.
PAGER TEST

8 Check that your pager receives a pager test call.

9 Press **DIGITAL SP-PHONE**.

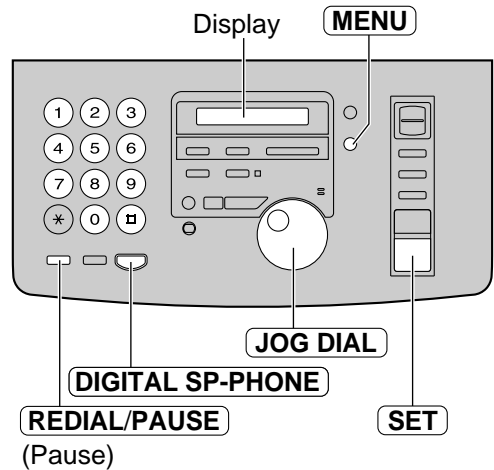

When your pager receives a pager call

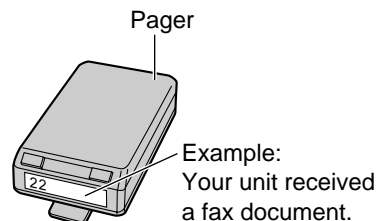

Your pager will beep and display as follows;
 — "11" : when your unit receives a voice message.
 — "22" : when your unit receives a fax document.

Copying

Making a copy

The unit can make single or multiple copies (up to 50). Any transmittable document (p. 51) can be copied.

- 1 Adjust the width of the document guides to the size of the document.
- 2 Insert the document (up to 10 pages) **FACE DOWN** until a single beep is heard and the unit grabs the document.

Display:

- Make sure the handset is on the cradle.
- If necessary, press **RESOLUTION** repeatedly to select the desired setting (p. 49).

- 3 Press **COPY START** .

- If necessary, enter the number of copies (up to 50).
- If necessary, choose an enlargement/reduction rate by pressing **COPY ZOOM** . See next page.
- If you want to print collated (sorted) copies, press **COLLATE** until the following is displayed.

- 4 Press **COPY START** .
 - The unit will start printing.
 - If you want to remove the copy document for other uses, press **QUICK SCAN** instead of **COPY START** . The unit will feed the document and scan it into memory, then start printing.

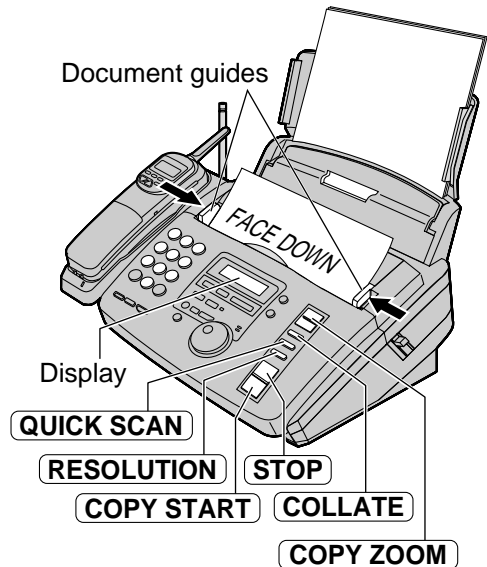

Note:

- If a resolution is not selected, "FINE" resolution will automatically be selected.
- You can make or receive a voice call while making copies.
- After copying, the enlargement/reduction rate setting will return to "100%".

To stop copying

Press **STOP** .

Printing collated (sorted) copies

Example: Making two copies of a 4-page original document

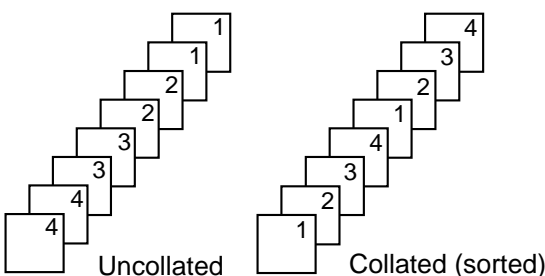

Note:

- If you turn the collating feature on, the unit will store the documents into memory. If memory becomes full while storing, the unit will only print out the stored pages.
- After copying, the collating feature will turn off automatically.

To enlarge a document

Select "200%" or "150%" by pressing **COPY ZOOM** (+). The unit will only enlarge the center part of the document and print it on two pages.

Example of a 200% enlarged copy

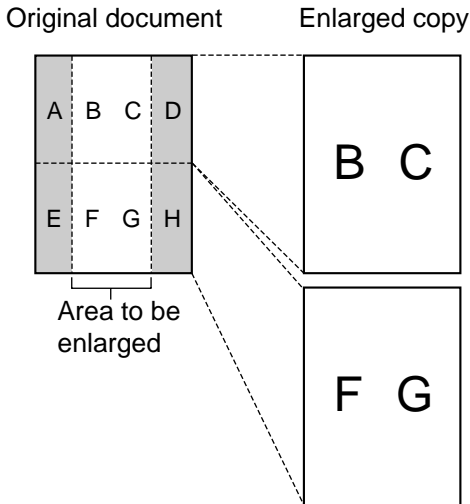

Example of a 150% enlarged copy

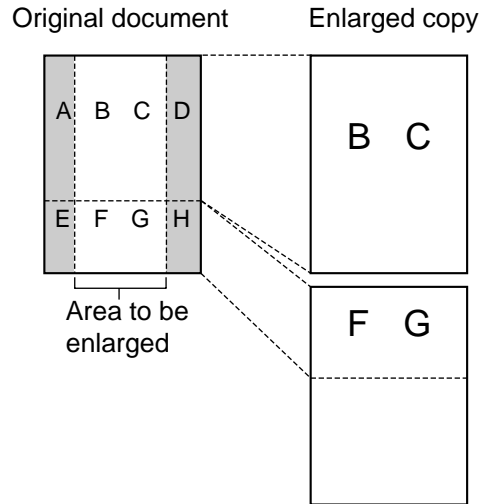

To reduce a document

The unit can reduce the original document.

Select the desired setting by pressing **COPY ZOOM** (-).

Recommended reduction rates:

Setting	Size of recording paper	Size of original document
100% (default)	Letter	Letter
	Legal*	Letter, A4, Legal
92%	Letter	A4
86%	Letter	A4
72%	Letter	Legal

Letter = 216 mm x 279 mm (8½" x 11")

Legal = 216 mm x 356 mm (8½" x 14")

A4 = 210 mm x 297 mm (8¼" x 11¹¹/₁₆")

*If you use legal size paper, please purchase a legal paper tray, Model No. KX-FA50-B (p. 9) and install it (p. 12).

Note:

- If the appropriate reduction rate is not programmed, the document may be divided and the top of the second sheet will be deleted.

TAD/FAX mode (using the built-in answering device and receiving voice and fax calls automatically)

When the TAD/FAX mode is set, the unit will work as a fax machine and/or answering device. If a fax call is detected, the unit will automatically receive the fax. If a voice call is detected, the answering device will play a greeting message and the caller can leave a voice message.

- You can use either the pre-recorded greeting messages (p. 69) or your own greeting message (p. 70).

Setting up the voice and fax message reception

- 1 Set feature #77 to "TAD/FAX" (p. 88).
- 2 If the arrow (▼) is not shown on the right of the display, turn it on by pressing **AUTO ANSWER**.
 - The unit will play the greeting message.
 - The display will show the number of rings before the unit answers a call in the TAD/FAX mode.

Display: PICKUP &RCV CALL
↓
AFTER 2 RINGS ㊦

- 3 If necessary, rotate **JOG DIAL** until the desired ring count (see below) is displayed, and press **SET**.
 - The remaining time for recording incoming messages will be displayed.

Example: TIME = 10m13s
↓
ON

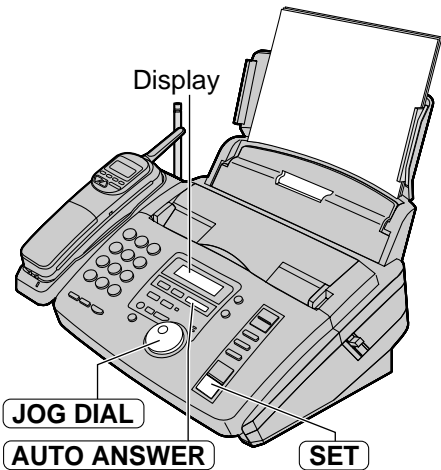

Note:

- If the arrow (▼) is already shown on the right of the display and you wish to change the ring count, turn the arrow off once then on again by pressing **AUTO ANSWER** and follow the instructions in step 3.
- The incoming message recording time can be changed (feature #10 on page 83).
- For voice memory capacity for incoming messages, see page 109.
- When the remaining time is low, erase unnecessary messages (p. 73).
- While an incoming call is being recorded, you can monitor it through the speaker. If this feature is not required, set to "OFF" (feature #67 on page 87).

Ring count in the TAD/FAX mode

You can choose from 1, 2, 3, 4, TOLL SAVER and RINGER OFF.

TOLL SAVER: When you call the unit from a remote location, the number of rings will tell you if there are any new voice messages. If the unit answers on the second ring, there is at least one new recorded message. If the unit answers on the fourth ring, there are no new recorded messages. To save the toll charges for the call, hang up immediately when you hear the third ring. The third ring indicates that there are no new recorded messages.

RINGER OFF: The unit will answer without ringing.

- If you subscribe to a Caller ID service, set to 2 or more rings.
- You can also select the setting with programming feature #06 (p. 83).

Pre-recorded greeting messages

The unit has pre-recorded greeting messages. Depending on the situation, one of the following messages will be played to the caller. For your own greeting message, see page 70.

■ When the unit is ready to receive voice and fax calls:

*Hello! We are unable to answer right now.
To send a fax, please start transmission.
To leave a voice message, please speak
after the beep.
Thank you.*

■ When voice or fax memory is full:

Display: MESSAGE FULL

*Hello! We are unable to answer right now.
To send a fax, please start transmission.
To leave a voice message, please try again
later.
Thank you.*

FAX MEMORY FULL

*Hello! We are unable to answer right now.
To send a fax, please try again later.
To leave a voice message, please speak
after the beep.
Thank you.*

MESSAGE FULL

and

FAX MEMORY FULL

*Hello! We are unable to answer right now.
Please try again later.
Thank you.*

Note:

- To clear the problem, see pages 90 and 91.

Recording your own greeting messages

You can record your own greeting messages for the TAD/FAX and TEL/FAX modes. When receiving a call, your own greeting message will be played instead of the pre-recorded message. The recording time will be limited to 16 seconds. We recommend you record your message within 12 seconds to make it easier to receive faxes.

Suggested messages

TAD/FAX greeting message	<i>"This is (your name, business and/or telephone number). We are unable to answer right now. To send a fax, start transmission. To leave a message, speak after the beep. Thank you."</i>
TEL/FAX greeting message	<i>"This is (your name, business and/or telephone number). We are unable to answer right now. Please try again later. Thank you."</i>

1 Select the desired mode (TAD/FAX or TEL/FAX) where you want to record a greeting message (feature #77 on page 88).

2 Press **RECORD** two times.
• The display will show the following according to your selection in step 1.

TAD/FAX mode:

TEL/FAX mode:

↑

3 Press **START**.
• A long beep will sound.

4 Speak clearly about 20 cm (8 inches) away from the microphone.

• The display will show the remaining recording time.

TAD/FAX mode:

TEL/FAX mode:

5 When finished recording, press **STOP**.
• The unit will repeat your message.
Adjust the volume using **▲** or **▼**.

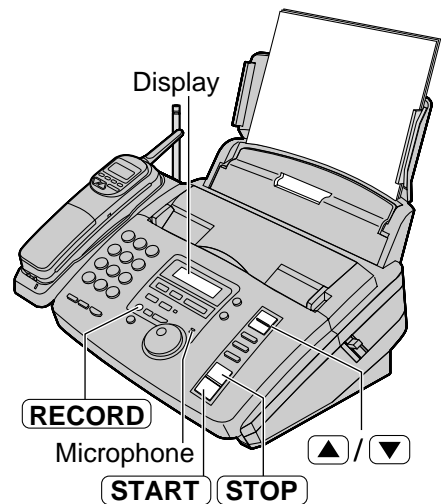

Note:

- If you make a mistake while recording, start again from step 2.
- You can choose 60-seconds for your own TAD/FAX greeting message (feature #54 on page 87).

Checking the greeting messages

- 1 Select the desired mode (TAD/FAX or TEL/FAX) where you want to listen to a greeting message (feature #77 on page 88).
- 2 If the arrow (▼) is not shown on the right of the display, turn it on by pressing **AUTO ANSWER**.
If the arrow (▼) is shown on the right of the display, turn it off once then on again.

TAD/FAX mode: PICKUP &RCV CALL



AFTER 2 RINGS ↻

TEL/FAX mode: TEL/FAX MODE

- The unit will play the greeting message.

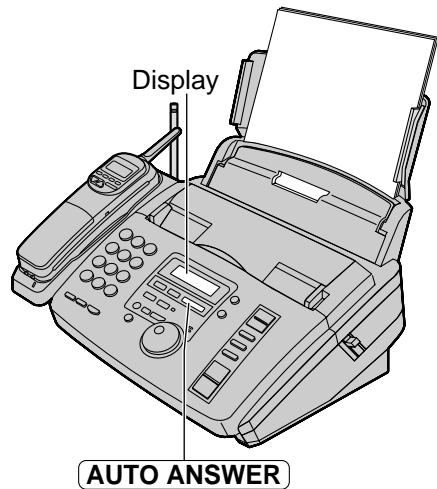

Erasing your own recorded greeting messages

- 1 Select the desired mode (TAD/FAX or TEL/FAX) where you want to erase the greeting message (feature #77 on page 88).
- 2 Press **ERASE** twice.
 - The display will show the following according to your selection in step 1.

TAD/FAX mode: 2. TAD GREETING

TEL/FAX mode: 2. T/F GREETING



PRESS START

- 3 Press **START**.

ERASE GREETING?



YES: SET/NO: STOP

- To cancel erasing, press **STOP**.

- 4 Press **SET**.

GREETING ERASED

- When receiving a call, the pre-recorded greeting message will be played.

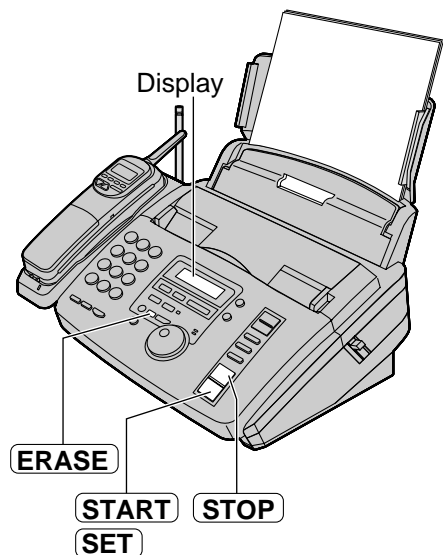

Incoming Messages

Listening to recorded messages

When the unit has recorded new voice messages:

- the PLAY MESSAGES indicator will flash,
- the call counter will show the total number of recorded messages, and
- slow beeps will sound if the message alert feature is activated (feature #42 on page 85).

Press **PLAY MESSAGES**.

- Only the new recorded messages will be played.
- Adjust the speaker volume using **▲** or **▼**.
- After playing back all of the new messages, the PLAY MESSAGES indicator will stop flashing and just light up.

If you press **PLAY MESSAGES** at this time, all the recorded messages will be played.

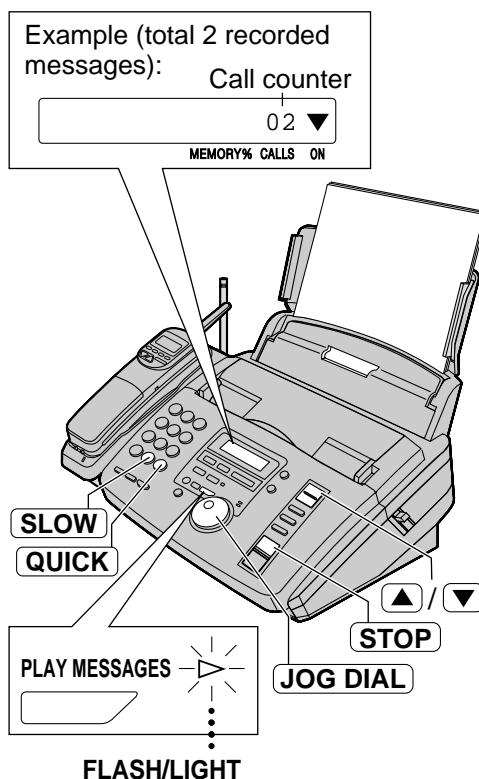

Repeating a message

Rotate **JOG DIAL** one click to the left while listening to the message.

- If you rotate **JOG DIAL** to the left within 5 seconds of the beginning of the message, the previous message will be played.
- To play back a specific message, rotate **JOG DIAL** to the left or right and search for the message you want to listen to.

Skipping a message

Rotate **JOG DIAL** one click to the right to play the next message.

Stopping playback

Press **STOP**.

- If you press **PLAY MESSAGES** within 1 minute, the unit will resume playing the rest of the messages.

Changing the playback speed

Press **QUICK** to play messages at one and a half times the original speed.

Press **SLOW** to play messages at half the original speed.

- To return to the original speed, press **QUICK** or **SLOW** again during quick or slow playback.

Voice time/day stamp

During playback, a synthesized voice will announce the time and day of the week that each message was recorded.

Erasing recorded messages

Erase unnecessary messages to prevent memory from becoming full.

Erasing a specific message

- 1 Press **ERASE** while listening to the message you want to erase.

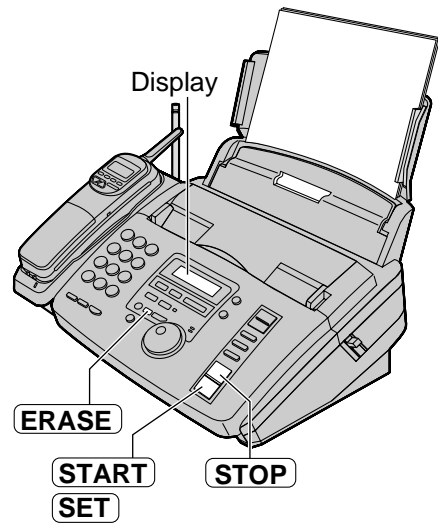
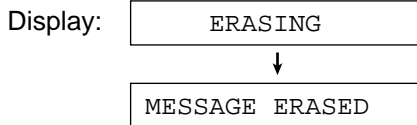

Erasing all the messages

Check that you have listened to all of the recorded messages.

- 1 Press **ERASE**.

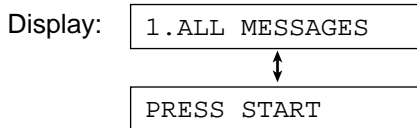

- 2 Press **START**.

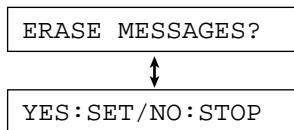

- To cancel erasing, press **STOP**.

- 3 Press **SET**.

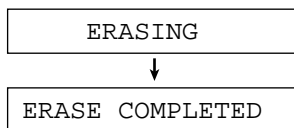

Note:

- Greeting messages can not be erased this way.

Recording

Memo message (leaving a message for others or yourself)

To leave a private message for yourself or someone else, you can record a voice memo. This memo can be played back later, either directly or remotely.

1 Press **RECORD**.

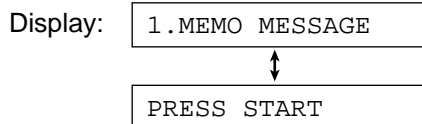

2 Press **START**.

- A long beep will sound.

MEMO RECORDING

3 Speak clearly about 20 cm (8 inches) away from the microphone.

4 When finished recording, press **STOP**.

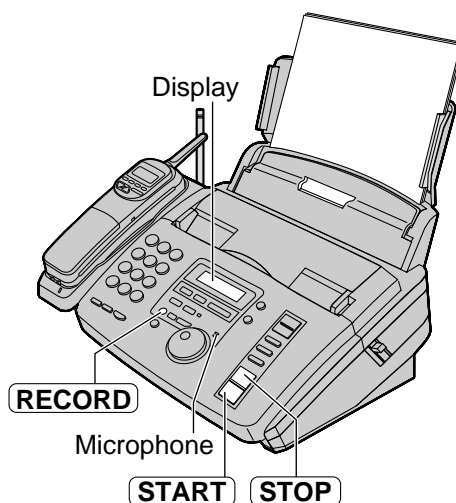

Operating from the handset

The following operations can be performed remotely with the handset.

Dial Key	Remote command	Page	Dial Key	Remote command	Page
1	Repeats a message	76	7	Turns ON the AUTO ANSWER mode	76
2	Skips a message	76	9	Turns OFF the AUTO ANSWER mode(Changes to the TEL mode)	76
4	New message playback	See below	* 4	Erases a specific message	76
5	All messages playback	See below	* 5	Erases all messages	76

Listening to record messages

1 Press **PLAYBACK**.

Display:

Remote operation
CH10

- The TALK indicator will flash.
- The voice guide will tell you the number of new recorded messages and they will be played automatically.

Voice guide example:

3 new messages.

- **To repeat the new recorded messages:**
Press **4**.
- **To listen to all of the recorded messages:**
Press **5**.

2 Press **PLAYBACK** to end the operation.

- The TALK indicator will turn off.

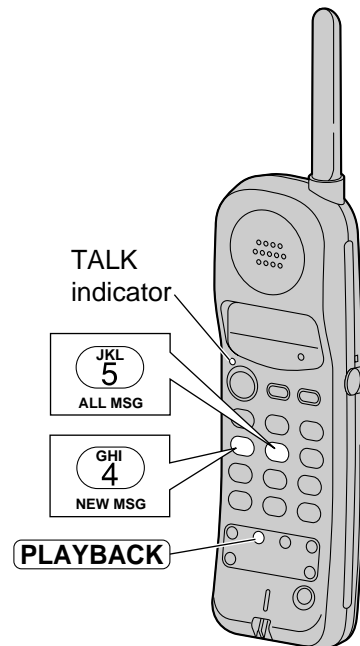

When there are no new recorded messages

The voice guide will be heard.

Voice guide example:

No new messages

Press **5** or wait 4 seconds to listen to all of the recorded messages.

When memory is full

The voice guide will be heard after playing the messages.

Voice guide example:

Sorry, no more memory.
Please erase unnecessary messages.

Erase some or all of the messages (p. 76).

From the Handset

During playback

Repeating a message

Press **1** to play the current message.

- If you press **1** within 5 seconds of the beginning of a message, the previous message will be played.

Skipping a message

Press **2**.

Erasing a specific message

Press *** 4** while listening to the message you want to erase.

The message has been erased.

- A long beep will also sound and the unit will then playback the next message.

Erasing all the messages

Press *** 5** to erase all the messages.

All messages have been erased.

- A long beep will also sound.

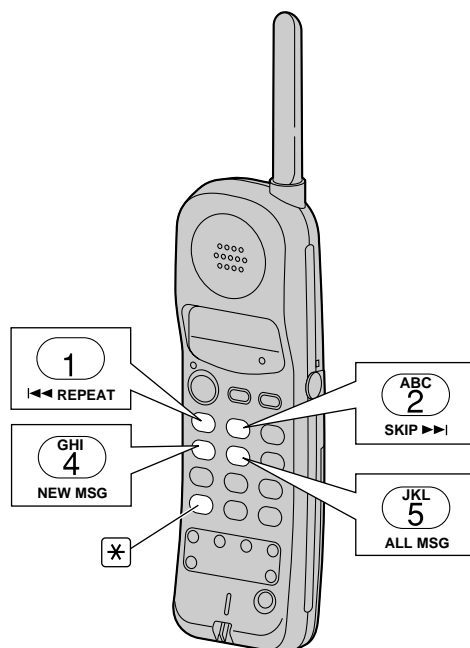

Turning the AUTO ANSWER mode on or off

1 Press **PLAYBACK**.

2 To turn **ON** the AUTO ANSWER mode, press **7**.

OR

To turn **OFF** the AUTO ANSWER mode, press **9**.

3 Press **PLAYBACK** to end the operation.

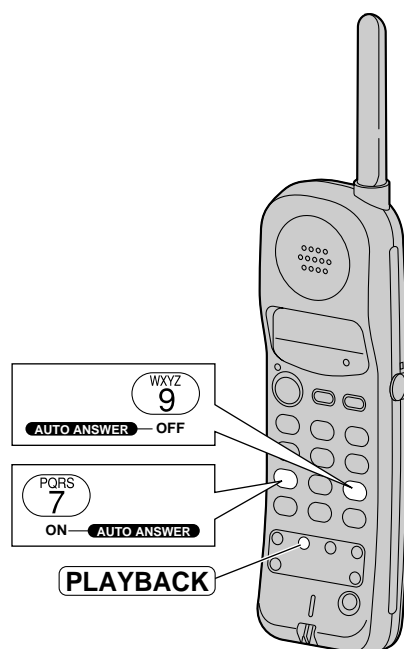

Operating from a remote location

The following operations can be performed from a remote location using a touch tone telephone. **Program the remote operation ID (feature #11 on page 83) and set the unit to the TAD/FAX mode before going out (p. 68).**

Dial key	Remote command	Page	Dial key	Remote command	Page
0	Skips the greeting message	79	*4	Erases a specific message	79
1	Repeats a message	78	*5	Erases all messages	79
2	Skips a message	78	80	Changes to the TEL mode	79
4	New message playback	78	81	Turns ON message transfer	79
5	All messages playback	78	82	Turns OFF message transfer	79
6	Room monitor	79	83	Turns ON pager call	79
7	Re-records a greeting message	79	84	Turns OFF pager call	79
9	Stops re-recording of a greeting message	79			

Remote operation card

Please cut out and carry this card for assistance when using the remote operation.

Answering Device Remote Operation	Notice of Remote Operation
<ol style="list-style-type: none"> 1. Call your unit. 2. Enter the remote operation ID <input type="text"/> <input type="text"/> <input type="text"/> during the greeting message. <ul style="list-style-type: none"> ● The new messages will be played automatically. ● If there are no new messages, wait for 4 seconds. All the messages will be played back. 3. Press the remote command key(s) within 10 seconds (see the reverse side). 	<ul style="list-style-type: none"> ● The remote operation is available only from a touch tone telephone when the unit is in the TAD/FAX mode. ● When the unit is in the TEL mode, call your unit and wait for 15 rings. The answering device will temporarily answer the line. Enter the remote operation ID during the greeting message. The unit will switch to the TAD/FAX mode. ● When you press a key, press firmly. ● To send a document, press *9. When a fax tone is heard, start transmission.

Remote Operation

Operation from a remote touch tone telephone

Listening to recorded messages

1 Call your unit.

2 Enter the remote operation ID during the TAD/FAX greeting playback.

When there are new recorded messages

The voice guide will tell you the number of new recorded messages and they will be played automatically.

Voice guide example:

3 new messages.

- **To repeat only the new messages:**

Press **4**.

- **To repeat the current message:**

Press **1**.

If you press **1** within 5 seconds of the beginning of a message, the previous message will be played.

- **To listen to all the messages:**

Press **5**.

- **To skip a message:**

Press **2**.

When there are no new recorded messages

No new messages.

Press **5** or wait for 4 seconds to listen to all the messages.

When voice memory is full

Sorry, no more memory.
Please erase unnecessary messages.

Erase some or all of the messages (see next page).

Key	Remote command
0	Skips the greeting message
1	Repeats a message
2	Skips a message
4	New message playback
5	All messages playback
6	Room monitor
7	Re-records a greeting message
9	Stops re-recording of a greeting message

Key	Remote command
*4	Erases a specific message
*5	Erases all messages
80	Changes to the TEL mode
81	Turns ON message transfer
82	Turns OFF message transfer
83	Turns ON pager call
84	Turns OFF pager call

Other remote operations

■ Erasing a specific message

Press **[*] 4** while listening to the message you want to erase.

Voice guide example:

The message has been erased.

- A long beep will also sound. The unit will then play back the next message.

■ Erasing all the messages

Press **[*] 5** to erase all the messages.

All messages have been erased.

- A long beep will also sound.

■ Monitoring the room

Press **6** to monitor the sound for about 30 seconds in the room where the unit is installed.

- After 30 seconds, a beep sounds. To continue monitoring, press **6** again within 10 seconds.

■ Recording a marker message

You can leave an additional message.

1. Wait for the voice guide.

All messages have been played.

2. Wait about 10 seconds.

Please leave your name and message after the beep.

3. Leave a message after the beep.

■ Re-recording a greeting message

You can change the contents of the TAD/FAX greeting message.

1. Press **7** to start recording.
 - A long beep will sound.
2. Speak clearly up to 16 seconds.
 - If you pause for over 2 seconds, 6 beeps will sound and the recording will stop. Repeat from step 1 within 10 seconds.
3. When finished recording, press **9**.
 - The new greeting message will be played.

■ Skipping the greeting message

Press **0** during the greeting message playback.

- The unit will skip the rest of the greeting message.

■ Turning the message transfer on or off

You must pre-program a transfer telephone number beforehand (feature #60 on page 87).

Press **8 1** to turn ON the message transfer.

*Message transfer is set.
Transfer phone number is 123...*

Press **8 2** to turn OFF the message transfer.

Message transfer is off.

- If a transfer telephone number is not programmed, you cannot turn this feature ON.

Transfer phone number is not set.

■ Turning the pager call on or off

You must program a pager number beforehand (feature #70 on page 87).

Press **8 3** to turn ON the pager call.

*Pager call is set.
Pager number is 098765432.*

Press **8 4** to turn OFF the pager call.

Pager call is off.

- If a pager number is not programmed, you cannot turn this feature ON.

Pager number is not set.

■ Changing the receive mode

Press **8 0** to change the receive mode from TAD/FAX to TEL.

- You cannot return to the TAD/FAX mode in the same call. To return to the TAD/FAX mode, see below.

■ Returning to the TAD/FAX mode

1. Call your unit and wait for 15 rings.
 - The answering device will temporarily answer the call.
2. Enter the remote operation ID during the greeting message.
 - Your unit will switch to the TAD/FAX mode.

Transferring recorded messages to another telephone

This feature allows your unit to call a designated telephone number each time an incoming voice message is recorded. You can retrieve the transferred message during the same call using the remote operation.

Program the transfer telephone number first (feature #60 on page 87) and set to the TAD/FAX mode.

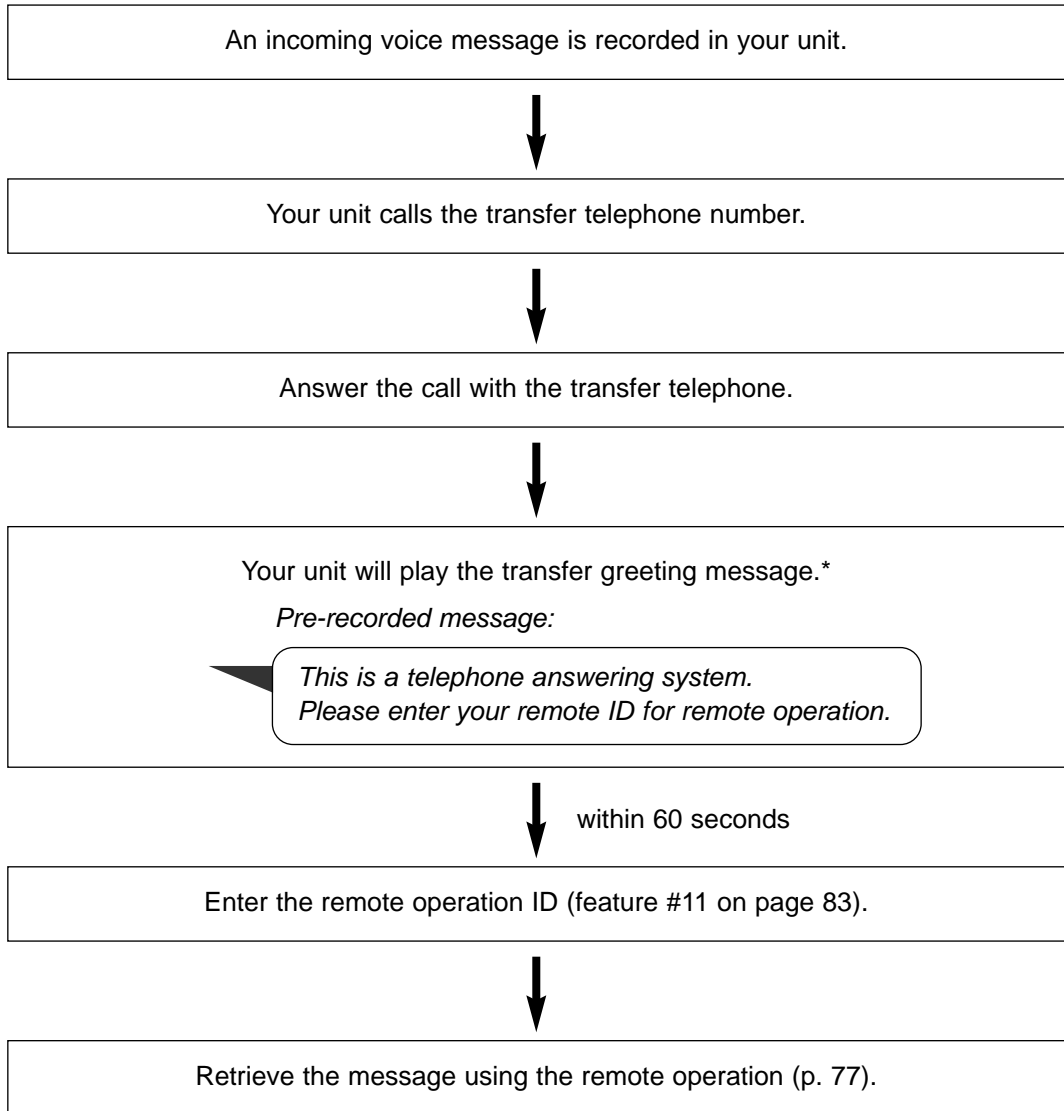

* This message can be changed (see next page).

Recording your own transfer greeting message

The recording time is limited to 16 seconds.

Suggested message

"This is a transferred message from (your name, business and/or telephone number). Please enter your remote ID for remote operation."

1 Press **MENU**.
Display: 1.SYSTEM SET UP

2 Press **⏏**, then **6** **1**.
TRNS-GREETING

3 Press **SET**.
CHECK ↻

4 Rotate **JOG DIAL** to select "RECORD".
RECORD ↻

5 Press **SET**.
TRNS REC. 16s

6 Speak clearly about 20 cm (8 inches) away from the microphone.

- The display will show the remaining recording time.

Example: TRNS REC. 15s

7 When finished recording, press **STOP**.

- The unit will repeat your message. Adjust the volume using **▲** or **▼**.

8 Press **MENU**.

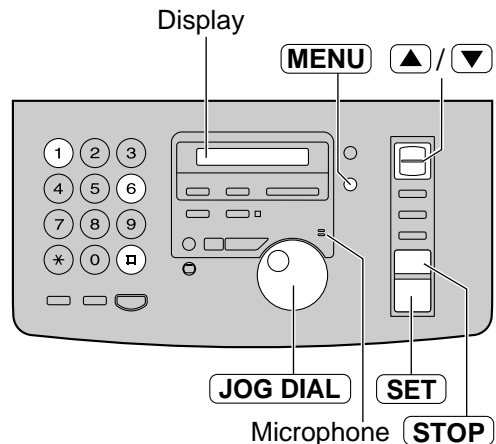

To check your transfer greeting message

- Press **MENU**, **⏏** **6** **1**, then **SET**.
- Rotate **JOG DIAL** to select "CHECK".
- Press **SET**.
 - The unit will play your message.
- Press **MENU**.

To erase your transfer greeting message

- Press **MENU**, **⏏** **6** **1**, then **SET**.
- Rotate **JOG DIAL** to select "ERASE".
- Press **SET**.
 - Your own message will be erased.
- Press **MENU**.
 - The pre-recorded greeting message will be played when transferring a call.

Features Summary

Programming

The unit provides various programming features. Program the desired setting by referring to the programming tables (p. 83–88).

General programming method

1 Press **MENU**.

Display: 1.SYSTEM SET UP

2 Select the feature you wish to program.

■ **For basic features** (p. 83)

Rotate **JOG DIAL** until the desired feature is displayed.

■ **For advanced features** (p. 84–88)

Rotate **JOG DIAL** until the following is displayed.

ADVANCED MODE

Press **SET** and rotate **JOG DIAL** until the desired feature is displayed.

3 Press **SET**.

- The current setting of the feature will be displayed.

4 Rotate **JOG DIAL** until the desired setting is displayed.

- This step may be slightly different depending on the feature.

5 Press **SET**.

- The setting you selected is set, and the next feature will be displayed.

6 To exit programming, press **MENU**.

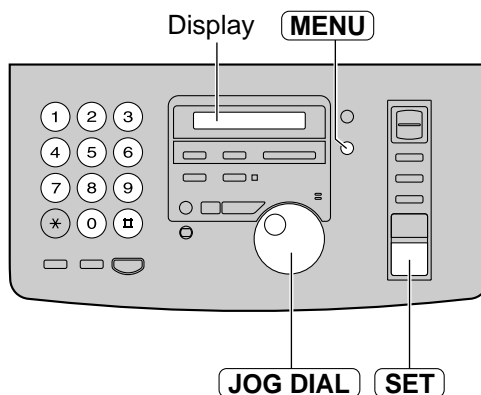

Programming by entering the program code number directly

You can select a feature by directly entering the program code (# and 2-digit number) instead of using **JOG DIAL**.

1. Press **MENU**.

2. Press **#** and the 2-digit code number.

3. Follow steps 3 to 6 above.

- See programming tables (p. 83–88) for codes.

To cancel programming

Press **MENU** to exit the program.

Basic features

Programming table

Code	Display & Feature	Settings	How the unit operates
#01	<div style="border: 1px solid black; padding: 2px; display: inline-block;">SET DATE & TIME</div> To set the date and time	mm/dd/yy hh:mm (2 digits for each entry)	See page 15 for details.
#02	<div style="border: 1px solid black; padding: 2px; display: inline-block;">YOUR LOGO</div> To set your logo	(Up to 30 characters)	See pages 16 and 17 for details.
#03	<div style="border: 1px solid black; padding: 2px; display: inline-block;">YOUR FAX NO.</div> To set your facsimile telephone number	(Up to 20 digits)	See page 18 for details.
#04	<div style="border: 1px solid black; padding: 2px; display: inline-block;">SENDING REPORT</div> To print and check the sending report for fax transmission results	ERROR	"ERROR": The sending report will be printed only when fax transmission fails (p. 52). "ON": The sending report will be printed after every transmission.
		ON	
		OFF	
#06	<div style="border: 1px solid black; padding: 2px; display: inline-block;">TAD RING COUNT</div> To change the number of rings before the unit answers a call in the TAD/FAX mode	1, 2, 3, 4	This setting is also available after activating the TAD/FAX mode. See page 68 for details.
		TOLL SAVER	
		RINGER OFF	
#06	<div style="border: 1px solid black; padding: 2px; display: inline-block;">FAX RING COUNT</div> To change the number of rings before the unit answers a call in the FAX ONLY mode	1, 2, 3, 4	This setting is also available after activating the FAX ONLY mode (p. 61).
#10	<div style="border: 1px solid black; padding: 2px; display: inline-block;">RECORDING TIME</div> To change the recording time for an incoming message	VOX	"VOX": Unlimited "1 MIN": Up to 1 minute
		1 MIN	
#11	<div style="border: 1px solid black; padding: 2px; display: inline-block;">REMOTE TAD ID</div> To operate the answering device from a remote location	ID = 111	<ol style="list-style-type: none"> 1. Follow steps 1–3 on page 82. 2. Enter any 3–digit number except a number using 0 or 7. 3. Press SET. 4. Press MENU.
#13	<div style="border: 1px solid black; padding: 2px; display: inline-block;">DIALING MODE</div> If you cannot dial, change the setting depending on your telephone line service.	TONE	"TONE": For tone dial service. "PULSE": For rotary pulse dial service.
		PULSE	

(The default setting is in bold type.)

Features Summary

Advanced features

How to set menu options

1. Press **MENU** .
2. Rotate **JOG DIAL** until the following is displayed.

Display: ADVANCED MODE

Press **SET** and rotate **JOG DIAL** until the desired feature is displayed.

3. Press **SET** .
4. Rotate **JOG DIAL** until the desired setting is displayed.
5. Press **SET** .
6. Press **MENU** .

Note:

- Step 4 may be slightly different depending on the feature.
- See page 82 for more details.

Programming table

Code	Display & Feature	Settings	How the unit operates
#22	<div style="border: 1px solid black; padding: 2px; display: inline-block;">AUTO JOURNAL</div> To print the journal report automatically for fax communications	ON	"ON": The unit will print the journal report automatically after every 30 new fax communications (p. 52).
		OFF	
#23	<div style="border: 1px solid black; padding: 2px; display: inline-block;">OVERSEAS MODE</div> If you have difficulty sending an overseas fax, activate this feature before starting transmission. This feature makes sending documents easier as the transmission speed is slowed down.	NEXT FAX	"NEXT FAX": For the next attempted fax transmission. After transmission, the unit will return to the previous setting. "ERROR": When previous fax transmission fails and you redial the same number. ● This feature is not available for broadcast transmission. ● The calling charge may be higher.
		ERROR	
		OFF	
#25	<div style="border: 1px solid black; padding: 2px; display: inline-block;">DELAYED SEND</div> To send a fax automatically at a specified time. This allows you to take advantage of low-cost calling hours offered by your telephone company. ● The setting can be reserved to take place up to 24 hours in advance.	ON / fax no. / hh:mm	To send a document: 1. Insert the document. 2. Follow steps 1–3 above. 3. Rotate JOG DIAL to select "ON". 4. Press SET . 5. Enter the fax number. 6. Press SET . 7. Enter the transmission start time. Press * to select "AM" or "PM". 8. Press SET . 9. Press MENU . ● To cancel after programming, press STOP then SET .
		OFF	

(The default setting is in bold type.)

Features Summary

Code	Display & Feature	Settings	How the unit operates																	
#26	<div style="border: 1px solid black; padding: 2px; display: inline-block;">AUTO CALL. LIST</div> To print the Caller ID list automatically	ON	"ON": The unit will print the Caller ID list automatically after every 30 new calls (p. 43).																	
		OFF																		
#30	<div style="border: 1px solid black; padding: 2px; display: inline-block;">SILENT FAX RING</div> To change the number of rings when the unit detects a voice call in the TEL/FAX mode	3, 4, 5, 6	See pages 62 and 63 for details.																	
#31	<div style="border: 1px solid black; padding: 2px; display: inline-block;">RING DETECTION</div> If you subscribe to a Distinctive Ring Service (Identa-Ring) from your telephone company, activate this feature. This feature is also required for voice mail service.	A, B , C, D	Select the ring pattern to be assigned to the facsimile number. A: Standard ring (one long ring) B: Double ring (two short rings) C: Triple ring (short-long-short rings) D: Other triple ring (short-short-long rings) • For more information about telephone services, contact your telephone company.																	
		OFF																		
#36	<div style="border: 1px solid black; padding: 2px; display: inline-block;">RCV REDUCTION</div> If the size of the document sent by the other party is as large as, or larger than the recording paper, the unit can reduce and print the document. Select the desired reduction rate.	100%	<table border="1"> <thead> <tr> <th>Setting</th> <th>Recording paper</th> <th>Original document</th> </tr> </thead> <tbody> <tr> <td>100%</td> <td>Legal</td> <td>Letter, A4</td> </tr> <tr> <td rowspan="2">92%</td> <td>Letter</td> <td>Letter</td> </tr> <tr> <td>Legal</td> <td>Legal</td> </tr> <tr> <td>86%</td> <td>Letter</td> <td>A4</td> </tr> <tr> <td>72%</td> <td>Letter</td> <td>Legal</td> </tr> </tbody> </table>	Setting	Recording paper	Original document	100%	Legal	Letter, A4	92%	Letter	Letter	Legal	Legal	86%	Letter	A4	72%	Letter	Legal
		Setting		Recording paper	Original document															
		100%		Legal	Letter, A4															
		92%		Letter	Letter															
				Legal	Legal															
86%	Letter	A4																		
72%	Letter	Legal																		
92%																				
86%																				
72%																				

(The default setting is in bold type.)

(continued)

Features Summary

Advanced features (cont.)

How to set menu options

1. Press **MENU**.
2. Rotate **JOG DIAL** until the following is displayed.

Display: ADVANCED MODE

Press **SET** and rotate **JOG DIAL** until the desired feature is displayed.

3. Press **SET**.
4. Rotate **JOG DIAL** until the desired setting is displayed.
5. Press **SET**.
6. Press **MENU**.

Note:

- Step 4 may be slightly different depending on the feature.
- See page 82 for more details.

Programming table (cont.)

Code	Display & Feature	Settings	How the unit operates
#43	REC. TIME ALERT To alert you with beeps when there is less than 60 seconds of remaining recording time.	ON	If you hear slow beeps, erase the recorded messages (p. 73). The beeps will stop.
		OFF	
#44	RECEIVE ALERT To alert you with beeps when a received document is stored into memory due to a problem.	ON	If you hear slow beeps, clear the printing problem or supply paper to print the stored document. The beeps will stop.
		OFF	
#46	FRIENDLY RCV To receive a fax automatically when you answer a call and hear a fax calling tone (slow beep).	ON	"ON": You do not have to press FAX START for fax reception.
		OFF	
#47	FAX GUIDANCE If you wish to hear the voice guidance (see right) at each fax transmission/reception, set this feature to "ON". <ul style="list-style-type: none"> ● To hear the voice guidance only when fax transmission/reception fails, select "ERROR". 	ON	Voice guidance example: "Start transmission." "Transmission is complete." "Transmission has failed." "Transmission has been interrupted."
		OFF	"Start reception." "Reception is complete." "Reception has failed." "Reception has been interrupted."
		ERROR	"Reception has been interrupted."

(The default setting is in bold type.)

Features Summary

Code	Display & Feature	Settings	How the unit operates
#54	<div style="border: 1px solid black; padding: 2px; width: fit-content;">GREETING TIME</div> <p>To change the recording time for your own TAD/FAX greeting message (p. 70)</p>	16s	<p>“16s”: Up to 16 seconds “60s”: Up to 60 seconds</p> <ul style="list-style-type: none"> • If you change to 60 seconds, we recommend that you tell the caller in your own greeting message to press *9 before starting fax transmission. • If you change to 16 seconds from 60 seconds, your own recorded greeting message will be deleted and will be played the pre-recorded message.
		60s	
#60	<div style="border: 1px solid black; padding: 2px; width: fit-content;">MESSAGE TRANS.</div> <p>To transfer a recorded incoming message to another telephone (p. 80)</p>	ON	<ol style="list-style-type: none"> 1. Follow steps 1–3 on page 86. 2. Rotate JOG DIAL to select “ON”. 3. Press SET. 4. Enter the transfer telephone number. 5. Press SET. 6. Press MENU. <ul style="list-style-type: none"> • This feature can be turned on/off from a remote location (p. 79).
		OFF	
#61	<div style="border: 1px solid black; padding: 2px; width: fit-content;">TRNS-GREETING</div> <p>To check, record or erase a transfer greeting message</p>	CHECK	See page 81 for details.
		RECORD	
		ERASE	
#67	<div style="border: 1px solid black; padding: 2px; width: fit-content;">ICM MONITOR</div> <p>To hear an incoming message (ICM) from the speaker when the answering device is recording the message.</p>	ON	If you select “OFF”, you cannot monitor the incoming message.
		OFF	
#70	<div style="border: 1px solid black; padding: 2px; width: fit-content;">PAGER CALL</div> <p>If you have a pager and wish to know when your unit receives a fax or an incoming message, activate this feature.</p>	ON	See page 65 for details.
		OFF	

(The default setting is in bold type.)

(continued)

Features Summary

Advanced features (cont.)

How to set menu options

1. Press **MENU**.
2. Rotate **JOG DIAL** until the following is displayed.

Display: ADVANCED MODE

Press **SET** and rotate **JOG DIAL** until the desired feature is displayed.

3. Press **SET**.
4. Rotate **JOG DIAL** until the desired setting is displayed.
5. Press **SET**.
6. Press **MENU**.

Note:

- Step 4 may be slightly different depending on the feature.
- See page 82 for more details.

Programming table (cont.)

Code	Display & Feature	Settings	How the unit operates
#76	<div style="border: 1px solid black; padding: 2px; width: fit-content;">CONNECTING TONE</div> <p>If you often have trouble when sending a fax, this feature allows you to hear connecting tones; fax tone, ring back tone and busy tone.</p>	ON	<p>You can confirm the status of the other party's machine.</p> <ul style="list-style-type: none"> • If the ring back tone continues, the other party's machine may not be a facsimile or may have run out of paper. Check with the other party. • The connecting tone volume cannot be adjusted.
		OFF	
#77	<div style="border: 1px solid black; padding: 2px; width: fit-content;">AUTO ANSWER</div> <p>To change the receive mode in the AUTO ANSWER setting</p>	TAD/FAX	<p>"TAD/FAX": Telephone Answering Device/Facsimile mode (p. 68) "FAX ONLY": Facsimile only mode (p. 61) "TEL/FAX": Telephone/Facsimile mode (p. 62, 63)</p> <ul style="list-style-type: none"> • If you select "TEL/FAX", the unit will print an information list.
		FAX ONLY	
		TEL/FAX	
#78	<div style="border: 1px solid black; padding: 2px; width: fit-content;">TEL/FAX RING</div> <p>If you use an extension telephone in the TEL/FAX mode, select the desired number of rings to be generated before the unit answers.</p>	1, 2, 3, 4	See pages 62 and 63 for details.
#80	<div style="border: 1px solid black; padding: 2px; width: fit-content;">SET DEFAULT</div> <p>To reset the advanced features to their default settings</p>	YES	<ol style="list-style-type: none"> 1. Follow steps 1–3 above. 2. Rotate JOG DIAL to select "YES". 3. Press SET. 4. Press SET again. 5. Press MENU.
		NO	

(The pre-selected setting is in bold type.)

Reports

If your unit cannot send a fax, check the following.

- The number you dialed is correct.
- The other party's machine is a facsimile.

If the problem remains, correct it by following the communication message printed on the sending and journal reports (p. 52).

Communication message	Error code	Cause & Remedy
COMMUNICATION ERROR	40–42 46–52 58, 65 68, 72 FF	● A transmission or reception error occurred. Try again or check with the other party.
	43 44	● An overseas transmission error occurred. Try using the overseas mode (feature #23 on page 84).
DOCUMENT JAMMED	—	● The document is jammed. Remove the jammed document (p. 99).
ERROR-NOT YOUR UNIT	54 59 70	● A transmission or reception error occurred because of a problem with the other party's fax machine. Check with the other party.
MEMORY FULL	—	● The document was not received due to memory being full.
NO DOCUMENT	—	● The document was not fed into the unit properly. Reinsert the document and try again.
OTHER FAX NOT RESPOND	—	<ul style="list-style-type: none">● The other party's fax machine is busy or has run out of recording paper. Try again.● The document was not fed properly. Reinsert the document and try again.● The other party's fax machine rings too many times. Send a fax manually – dial the number, confirm the fax tone, and press FAX START.● The other party's machine is not a facsimile. Check with the other party.● The number you dialed is not in service.
PRESSED THE STOP KEY	—	● STOP was pressed and fax communication was canceled.
THE COVER WAS OPENED	—	● The covers were opened. Close them and try again.
OK	—	● Fax communication was successful.

Error Messages

Display

If the unit detects a problem, one or more of the following messages will appear on the display.

Main unit

Display message	Cause & Remedy
CALL SERVICE CALL SERVICE2	<ul style="list-style-type: none"> There is something wrong with the unit. Contact our service personnel.
COVER OPEN ↑ CHECK FILM	<ul style="list-style-type: none"> The covers are open. Close them. The ink film is empty. Replace the ink film with a new one (p. 100, 101). The ink film is not installed. Install it (p. 100, 101). The ink film is slack. Tighten it (see step 6 on page 101).
CHECK DOCUMENT	<ul style="list-style-type: none"> The document is not fed into the unit properly. Reinsert the document. If misfeeding occurs frequently, clean the document feeder rollers (p. 103) and try again. If the problem remains, adjust the feeder pressure (p. 99).
CHECK MEMORY	<ul style="list-style-type: none"> Memory (telephone numbers, parameters, etc.) has been erased. Re-program.
CHECK PAPER	<ul style="list-style-type: none"> The recording paper is not installed or the unit has run out of paper. Install paper and press SET to clear the message. The recording paper is not fed into the unit properly. Reinstall paper (p. 13) and press SET to clear the message. The recording paper has jammed near the recording paper entrance. Clear the jammed paper (p. 98) and press SET to clear the message. Do not install folded or heavily curled paper.
FAX IN MEMORY	<ul style="list-style-type: none"> The unit has a document in memory. See the other displayed message instructions to print out the document.
FAX MEMORY FULL	<ul style="list-style-type: none"> Memory is full of received documents due to a lack of recording paper or a recording paper jam etc. Install paper or clear the jammed paper. When performing memory transmission, the document being stored exceeds the memory capacity of the unit. Transmit the entire document manually.
JOG-DIAL FULL	<ul style="list-style-type: none"> There is no space to store new stations in the JOG DIAL directory. Erase unnecessary stations (p. 38).
MEMORY FULL	<ul style="list-style-type: none"> When making a copy, the document being stored exceeds the memory capacity of the unit. Press STOP to clear the message. Divide the document and try again.

Error Messages

Display message	Cause & Remedy
MESSAGE FULL	<ul style="list-style-type: none"> There is no room left in memory to record a voice message. Erase unnecessary messages (p. 73).
MODEM ERROR	<ul style="list-style-type: none"> There is something wrong with the modem circuit. Contact our service personnel.
NO FAX REPLY	<ul style="list-style-type: none"> The other party's fax machine is busy or has run out of recording paper. Try again.
PAPER JAMMED	<ul style="list-style-type: none"> A recording paper jam occurred. Clear the jammed paper (p. 98).
PLEASE WAIT	<ul style="list-style-type: none"> The unit is checking that there is no slack on the ink film. Wait for a while.
REDIAL TIME OUT	<ul style="list-style-type: none"> The other party's fax machine is busy or has run out of recording paper. Try again.
REMOVE DOCUMENT	<ul style="list-style-type: none"> The document is jammed. Remove the jammed document (p. 99). Attempted to transmit a document longer than 600 mm (23⁵/₈"). Press STOP to remove the document. Divide the document into two or more sheets and try again.
TRANSMIT ERROR	<ul style="list-style-type: none"> A transmission error occurred. Try again.
UNIT OVERHEATED	<ul style="list-style-type: none"> The unit is too hot. Let the unit cool down.

Handset

Display message	Cause & Remedy
No link to base Place on cradle and try again.	<ul style="list-style-type: none"> The handset is too far from the main unit. Move closer and try again. Play the handset on the main unit and try again. The power cord is disconnected. Plug in the power cord.
Save error	<ul style="list-style-type: none"> While programming, the handset lost communication with the main unit. Move closer to the main unit.
Please lift up and try again	<ul style="list-style-type: none"> <input checked="" type="checkbox"/> or <input checked="" type="checkbox"/> was pressed while the handset was on the main unit. Lift the handset and press <input checked="" type="checkbox"/> or <input checked="" type="checkbox"/> again.
Not available	<ul style="list-style-type: none"> <input checked="" type="checkbox"/> or <input checked="" type="checkbox"/> , PLAYBACK or INTERCOM was pressed while the main unit was not in th stand-by mode.

When a function does not work, check here before requesting help

General

Problem	Cause & Remedy
I cannot make and receive calls.	<ul style="list-style-type: none"> ● The power cord or telephone line cord is not connected. Check the connections (p. 14). ● If you used a splitter to connect the unit, remove the splitter and connect the unit to the wall jack directly. If the unit operates properly, check the splitter.
I cannot make calls.	<ul style="list-style-type: none"> ● The dialing mode setting is wrong. Change the setting of feature #13 (p. 83).
The unit does not work.	<ul style="list-style-type: none"> ● Disconnect the unit from the telephone line and connect the line to a known working telephone. If the working telephone operates properly, contact our service personnel to have the unit repaired. If the working telephone does not operate properly, contact your telephone company.
The unit does not ring.	<ul style="list-style-type: none"> ● The ringer volume is set to off. Adjust it to a suitable level (p. 22, 23). ● The TAD ring count of feature #06 is set to "RINGER OFF". Change to another ring count (p. 83).
The unit displays the following message though the paper is inserted. <div data-bbox="111 1035 403 1078" style="border: 1px solid black; padding: 5px; margin: 10px 0;">CHECK PAPER</div>	<ul style="list-style-type: none"> ● The paper is inserted halfway. Insert it correctly (p. 13) and press SET to clear the message.
The other party complains they only hear a fax tone and cannot talk.	<ul style="list-style-type: none"> ● The FAX ONLY mode is set. Tell them the number is only used for faxes or change to TAD/FAX, TEL or TEL/FAX mode (p. 58, 59).
The REDIAL/PAUSE button does not function properly.	<ul style="list-style-type: none"> ● If this button is pressed during dialing, a pause will be inserted. If pressed immediately after a dial tone is obtained, the last number dialed will be redialed.
The receive mode does not function as explained on pages 58 and 59.	<ul style="list-style-type: none"> ● A Distinctive Ring pattern of feature #31 is set (p. 85). ● The TEL/FAX mode is set (p. 62, 63).
During programming, I cannot enter the code or ID number.	<ul style="list-style-type: none"> ● All or part of the numbers are the same. Change the code or ID number of features #11 (p. 83) and #41 (p. 85).
The ink film runs out quickly.	<ul style="list-style-type: none"> ● The HELP printing function, copy function, and reports also use ink film.
The unit beeps.	<ul style="list-style-type: none"> ● Recording paper or ink film has run out. Press STOP to stop the beeps and install paper/ink film.
The speakerphone is not working.	<ul style="list-style-type: none"> ● Use the speakerphone in a quiet room. ● If you have difficulty hearing the other party, adjust the volume using ▲ or ▼. ● If you and the other party speak at the same time, parts of your conversation will be cut off. Speak alternately.

(continued)

General (cont.)

Problem	Cause & Remedy
The LOCATOR/INTERCOM button does not function.	<ul style="list-style-type: none"> The handset is too far from the main unit or is engaged in an outside call.
The CHARGE light never goes out while charging.	<ul style="list-style-type: none"> This is normal.
While having an intercom call, a series of tones is heard.	<ul style="list-style-type: none"> Someone is calling you from outside. Press TALK or DIGITAL SP-PHONE to answer the outside call. The intercom call will be terminated.

Cordless handset

Problem	Cause & Remedy
The handset does not work.	<ul style="list-style-type: none"> Make sure that the battery is installed correctly (p. 102). Charge the battery fully (p. 20). Clean the charge contacts (p. 104) and charge again.
The handset does not ring.	<ul style="list-style-type: none"> The ringer volume is set to off. Press LOUD/RINGER (p. 22).
<p>The display shows the following message and an alarm the sounds when I press TALK / REMOTE SP / INTERCOM or PLAYBACK .</p> <div style="border: 1px solid black; padding: 5px; width: fit-content; margin: 10px auto;"> <p>No link to base Place on cradle and try again.</p> </div>	<ul style="list-style-type: none"> The handset is too far from the main unit. Move closer and try again. Place the handset on the main unit and try again. The power cord is disconnected. Plug in the power cord.
Static, sound cuts in/out, fades. Interference from other electrical units.	<ul style="list-style-type: none"> Locate the handset and the main unit away from electrical appliances. Move closer to the main unit. Press CH to select a clear channel. Raise the main unit antenna.
The handset stops working while being used.	<ul style="list-style-type: none"> Place the handset on the main unit, and disconnect the power cord to reset the unit. Connect the power cord, and try again.
I cannot store a telephone number in the handset memory.	<ul style="list-style-type: none"> You cannot store a number while the unit is in the talk or intercom mode. Do not pause for over 60 seconds while storing a number.
While storing a telephone number in the handset, it starts to ring.	<ul style="list-style-type: none"> To answer a call, press TALK . The program will be canceled. Store the number again.

(continued)

Cordless handset (cont.)

Problem	Cause & Remedy
I cannot redial by pressing REDIAL/PAUSE .	<ul style="list-style-type: none"> • The redial function does not work right after storing telephone numbers in the handset (p. 34). • If the last number dialed was more than 32 digits long, the number will not be redialed.
“[■]” flashes, the unit beeps intermittently and/or the following message is displayed. <div style="border: 1px solid black; padding: 5px; width: fit-content; margin: 10px auto;">Recharge</div>	<ul style="list-style-type: none"> • Charge the battery fully (p. 20)
You charged the battery fully, but “[■]” continues to flash and/or the following message is still displayed. <div style="border: 1px solid black; padding: 5px; width: fit-content; margin: 10px auto;">Recharge</div>	<ul style="list-style-type: none"> • Clean the charge contacts (p. 104) and charge again. • It is time to replace the battery. Please purchase a new battery (p. 9).
I cannot receive documents by pressing FAX on the handset.	<ul style="list-style-type: none"> • Press FAX until a single beep is heard.
The handset display is blank.	<ul style="list-style-type: none"> • The handset is in the stand-by mode (p. 20). Press <input checked="" type="checkbox"/> or <input type="checkbox"/> to turn the display on.
The handset display is still blank after pressing <input checked="" type="checkbox"/> or <input type="checkbox"/> .	<ul style="list-style-type: none"> • Charge the battery fully (p. 20).
The handset display goes to the stand-by mode while viewing the caller information.	<ul style="list-style-type: none"> • Do not pause for over 60 seconds while searching. • DIGITAL SP-PHONE was pressed.

Fax – sending

Problem	Cause & Remedy
I cannot send documents.	<ul style="list-style-type: none"> • The other party's fax machine is busy or has run out of recording paper. Try again. • The other party's machine is not a facsimile. Check with the other party. • The other party's fax machine rings too many times. Send a fax manually – dial the number, confirm the fax tone, then press FAX START.
The other party complains that letters on their received document are distorted or not clear.	<ul style="list-style-type: none"> • If your line has special telephone services such as call waiting, the service may have been activated during fax transmission. Connect the unit to a line that does not have these services. • The extension telephone on the same line is off the hook. Hang up the extension telephone and try again. • Try copying the document. If the copied image is clear, there may be something wrong with the other party's machine.

(continued)

Fax – sending (cont.)

Problem	Cause & Remedy
The other party complains that dirty patterns or black lines appear on their received document.	<ul style="list-style-type: none"> ● The glass or rollers are dirty. Clean them (p. 103).
I cannot make an international fax call.	<ul style="list-style-type: none"> ● Use the overseas transmission mode of feature #23 (p. 84). ● Add two pauses at the end of the telephone number (p. 33) or dial manually.

Fax – receiving



Problem	Cause & Remedy
I cannot receive documents automatically.	<ul style="list-style-type: none"> ● The receive mode is set to the TEL mode. Set to the TAD/FAX, FAX ONLY or TEL/FAX mode (p. 58, 59). ● The time taken to answer the call is too long. Decrease the number of rings of features #06 (p. 83), #30 (p. 85) and #78 (p. 88). ● The greeting message is too long. Shorten the message (p. 70).
The display shows the following message but faxes are not received. <div style="border: 1px solid black; padding: 2px; display: inline-block;">CONNECTING.....</div>	<ul style="list-style-type: none"> ● The incoming call is not a fax. Change the receive mode to the TEL or TAD/FAX mode (p. 58, 59).
The recording image is faint.	<ul style="list-style-type: none"> ● The other party sent a faint document. Ask them to send a clearer copy of the document. ● The thermal head is dirty. Clean it (p. 104).
The printing quality is poor.	<ul style="list-style-type: none"> ● Some paper has instructions recommending which side to print on. Try turning the paper over. We recommend smooth paper such as Hammermill® Jet Print for clearer printing. ● Check the document of the other party.
A blank sheet is ejected.	<ul style="list-style-type: none"> ● If a blank sheet is ejected after the received document is printed out, the receiving reduction rate is not programmed correctly. Program the proper rate in feature #36 (p. 85). ● The other party placed the document in their fax machine the wrong way. Check with the other party.
I cannot receive documents by pressing FAX on the handset.	<ul style="list-style-type: none"> ● Press FAX until a single beep is heard.

Operations

Receive mode

Problem	Cause & Remedy
<p>I cannot select the desired receive mode.</p>	<ul style="list-style-type: none"> ● If you want to set the TAD/FAX, FAX ONLY or TEL/FAX mode: <ul style="list-style-type: none"> — Select the desired mode using feature #77 (p. 88), and — Press AUTO ANSWER to turn on the arrow (▼) on the right of the display. <p style="text-align: right;">Display: <input style="width: 150px;" type="text" value="▼"/> ON</p> ● If you want to set the TEL mode: <ul style="list-style-type: none"> — Press AUTO ANSWER to turn off the arrow (▼) on the right of the display. <p style="text-align: right;"><input style="width: 150px;" type="text"/> ON</p>
<p>The other party complains that they cannot send a document.</p>	<ul style="list-style-type: none"> ● The unit is not in AUTO ANSWER mode. Press AUTO ANSWER to turn on the arrow (▼) on the right of the display. <p style="text-align: right;"><input style="width: 150px;" type="text" value="▼"/> ON</p>

Copying

Problem	Cause & Remedy
<p>The unit does not make a copy.</p>	<ul style="list-style-type: none"> ● You cannot make a copy during programming. Make the copy after programming or stop the programming.
<p>A dirty pattern or a black line appears on the copied document.</p>	<ul style="list-style-type: none"> ● The glass or rollers are dirty. Clean them (p. 103).
<p>The copied image is distorted.</p>	<ul style="list-style-type: none"> ● The thermal head is dirty. Clean it (p. 104).
<p>The printing quality is poor.</p>	<ul style="list-style-type: none"> ● Some paper has instructions recommending which side to print on. Try turning the paper over. We recommend smooth paper such as Hammermill® Jet Print for clearer printing.
<p>The printing is faint.</p> <div style="display: flex; justify-content: space-around; align-items: center; margin-top: 10px;"> <div style="text-align: center;"> <p>Original</p>  </div> <div style="text-align: center;"> <p>Copy</p>  </div> </div>	<ul style="list-style-type: none"> ● You may have used paper with a cotton and/or fiber content that is over 20%, such as letterhead or resume paper. We recommend smooth paper such as Hammermill® Jet Print for clearer printing.

Answering device

Problem	Cause & Remedy
New messages cannot be recorded in the TAD/FAX mode.	<ul style="list-style-type: none"> The memory is full. Erase unnecessary messages (p. 73, 79).
I cannot retrieve recorded messages from a remote location.	<ul style="list-style-type: none"> Press the remote operation ID correctly and firmly (p. 78).
While operating the answering device from the handset, a series of tones is heard.	<ul style="list-style-type: none"> Someone is calling you from outside. Press TALK to answer the outside call. The remote operation will be terminated.
I cannot operate the answering device with the handset.	<ul style="list-style-type: none"> Someone is operating the answering device. You are too far from the main unit. Move closer.

If a power failure occurs

- The unit will not function.
- Fax transmission and reception will be interrupted.
- If delayed transmission of feature #25 (p. 84) is programmed and the start time has passed during a power failure, transmission will be attempted soon after power is restored.
- If fax documents are stored in memory, they will be lost. When power is restored, a power down report will be printed out stating which contents in memory have been erased.

Sample of a power down report

POWER DOWN REPORT				
			POWER DOWN AT:Jan. 05 2000 04:30AM	
			RESTARTED AT:Jan. 05 2000 04:31AM	
			YOUR LOGO :	
			YOUR FAX NO. :	
<< WARNING >>				
CONTENTS HAVE BEEN CLEARED DUE TO POWER DOWN.				
FOR ADDITIONAL INFORMATION, PLEASE SEE THE JOURNAL REPORT.				
NO.	OTHER FACSIMILE	MODE	PAGES	FUNCTION
01	<FAX # NOT AVAIL.>	RCV	01	MEMORY RECEIVE

Recording paper jam

If the unit does not eject any recording paper during fax reception or copying, the recording paper has jammed and the display will show the following message.

Display: PAPER JAMMED

Remove the jammed paper as follows.

1 Open the front cover by pulling up the center part.

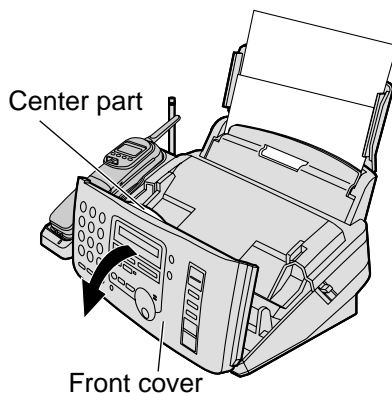

2 Push the back cover open button (①) and open the back cover (②).

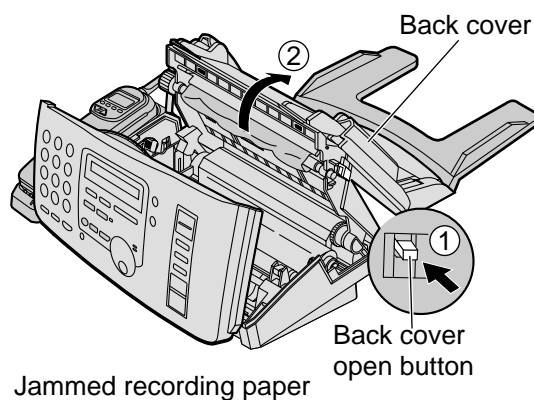

3 Remove the jammed recording paper.

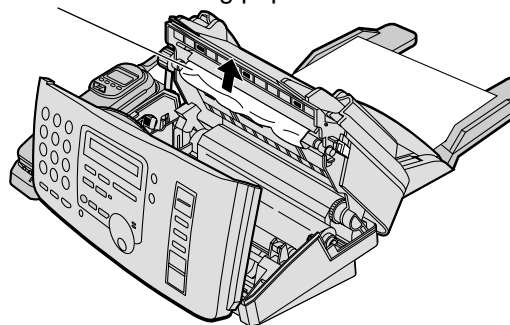

4 If the ink film is slack, tighten it by winding the gear.

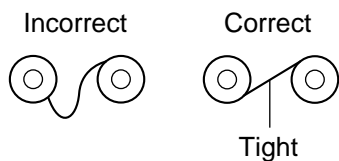

5 Close the back cover securely by pushing down on the dotted area at both ends (①). Close the front cover securely (②).

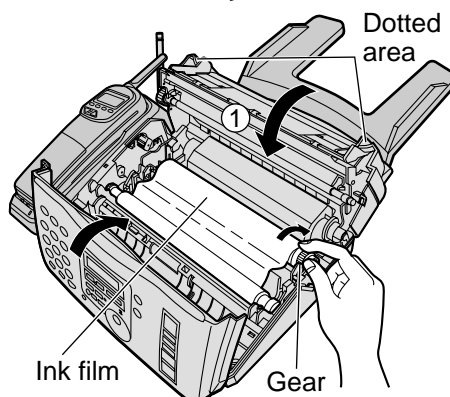

Sending document jams

If the unit does not release the document during feeding, remove the jammed document as follows.

- 1** Open the front cover by pulling up the center part.
- 2** Remove the jammed document carefully.
- 3** Close the front cover securely.

Note:

- Do not pull out the jammed paper forcibly before opening the front cover.

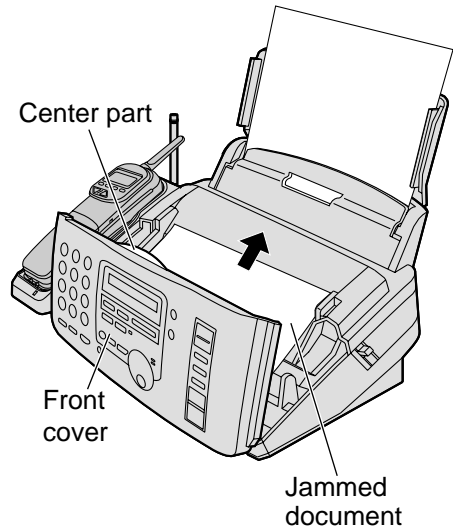

Sending document does not feed, or multi-feeds

If no feeding or multiple feeding occurs frequently, adjust the feeder pressure.

- 1** Open the front cover by pulling up the center part.
- 2** Shift the position of the green lever by using an instrument with a pointed end, such as a paper clip.
 - Left:** When documents multiple feed.
 - Center:** Standard position (pre-selected)
 - Right:** When documents do not feed.
- 3** Close the front cover securely.

Note:

- When shifting the green lever, do not touch the rubber flap.

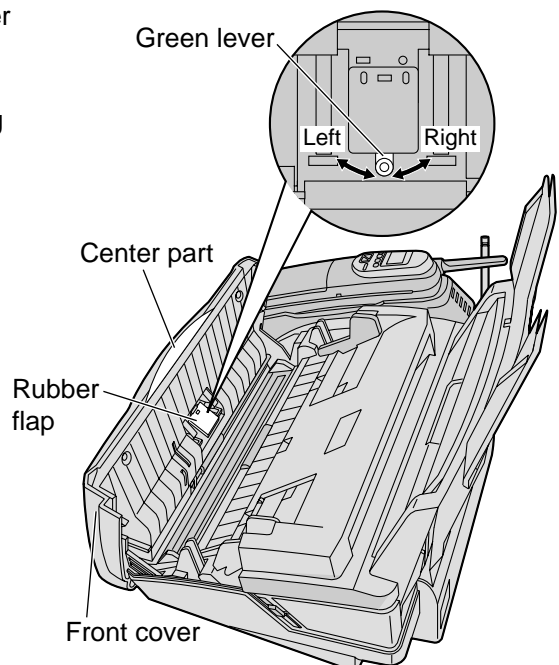

Replacing the ink film

When the unit runs out of ink film, the following message will be displayed.

Display:

CHECK FILM

Install a new ink film. The following ink films are available for replacement. Each roll prints about 150 letter-size pages. See page 9 for accessory order information.

Model No. KX-FA53: Replacement film (1 roll)

Model No. KX-FA55: Replacement film (2 rolls)

- 1 Open the front cover by pulling up the center part.

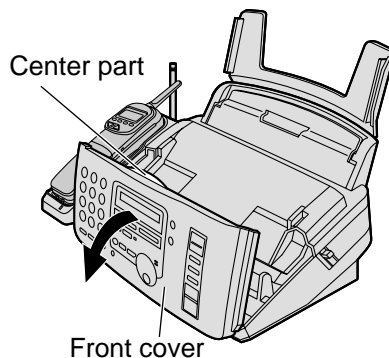

- 2 Push the back cover open button (①) and open the back cover (②).

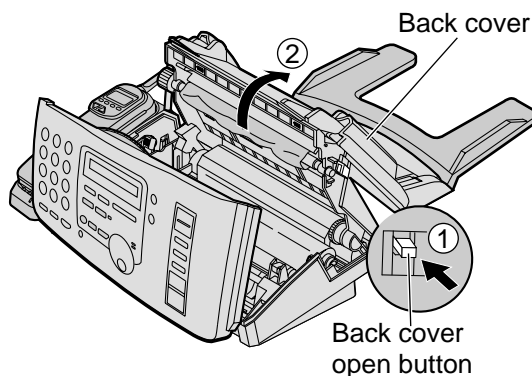

- 3 Pull up the blue gear side and remove the used ink film. Remove the used core.

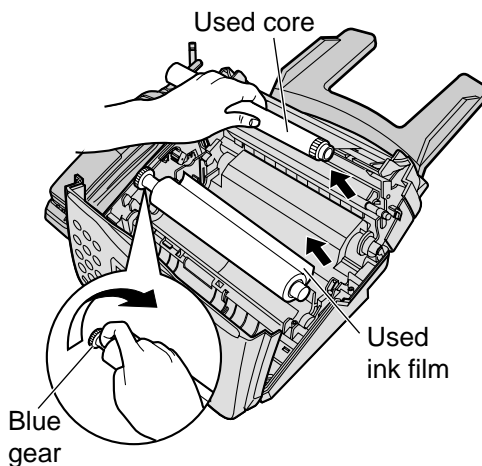

- 4** Remove the stoppers and tags from the new ink film. Find the "T" shaped gear (blue).

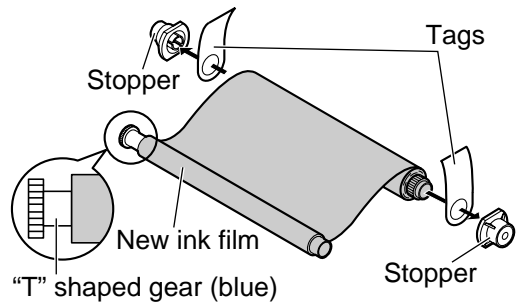

- 5** Insert the blue core of the front ink film roll into the right slot of the unit (①). Insert the "T" shaped gear (blue) into the left slot of the unit (②). Insert the back ink film roll (③).

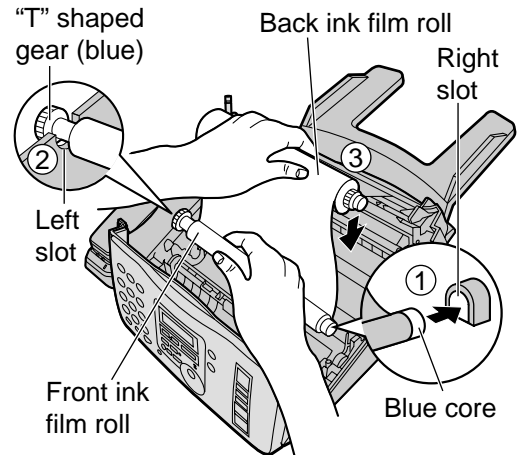

- 6** If the ink film is slack, tighten it by winding the gear.

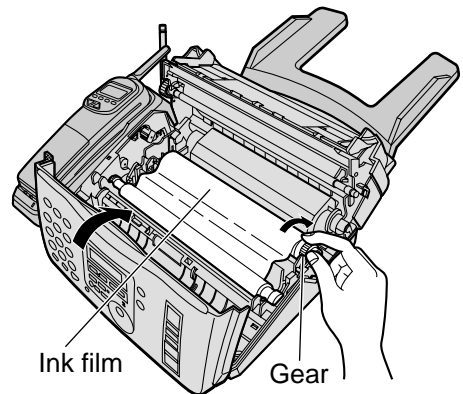
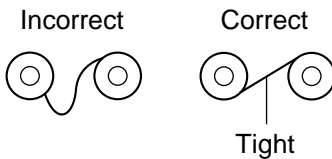

- 7** Close the back cover securely by pushing down on the dotted area at both ends (①). Close the front cover securely (②).

- The following message will be displayed while the unit is checking that there is no slack on the ink film.

Display: PLEASE WAIT

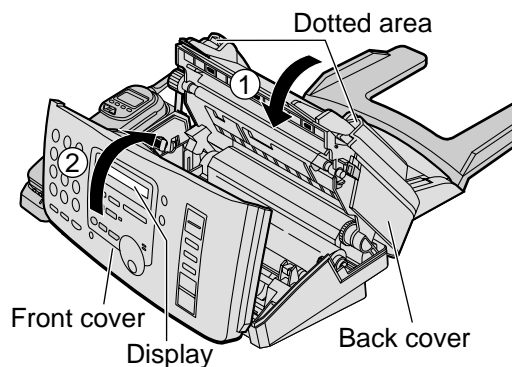

Note:

- The ink film is completely safe to touch, and will not rub off on your hands like carbon paper.

Battery

Replacing the handset battery

If “{ ■ }” flashes and/or “Recharge” is displayed after being fully charged, replace the battery with a new Panasonic rechargeable battery Model No. KX-A36. To order see page 9. To prevent memory loss, replace the battery within 3 minutes.

- 1 Press down on the arrow and slide the handset cover.



- 2 Disconnect the battery lead and remove the battery.

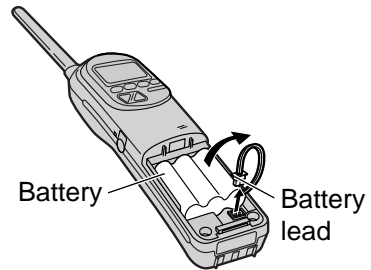

- 3 Connect the new battery lead and insert the battery into the handset.

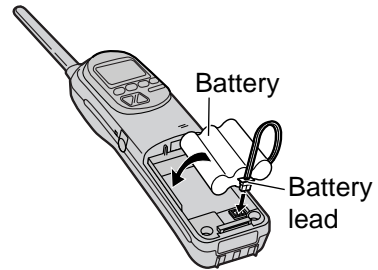

- 4 Replace the handset cover on the handset.
 - Be sure to charge the new battery for about **4 hours** (p. 20).

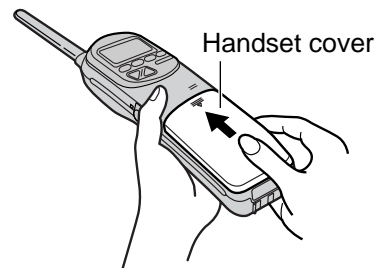

Attention:

- Use only a Panasonic rechargeable battery Model No. KX-A36.
- The product you have purchased is powered by a nickel cadmium battery which is recyclable.

At the end of its useful life, under various state and local laws, it is illegal to dispose of this battery into your municipal waste stream.

Please call 1-800-8-BATTERY for information on how to recycle this battery.



Document feeder

If misfeeding occurs frequently or if dirty patterns or black bands appear on a transmitted document or on the original of a copied document, clean the document feeder.

- 1** Disconnect the power cord and the telephone line cord.
- 2** Open the front cover by pulling up the center part.
- 3** Clean the document feeder rollers and rubber flap with a cloth moistened with isopropyl rubbing alcohol, and let all parts dry thoroughly.
- 4** Clean the glass with a soft dry cloth.
- 5** Close the front cover securely.
- 6** Connect the power cord and the telephone line cord.

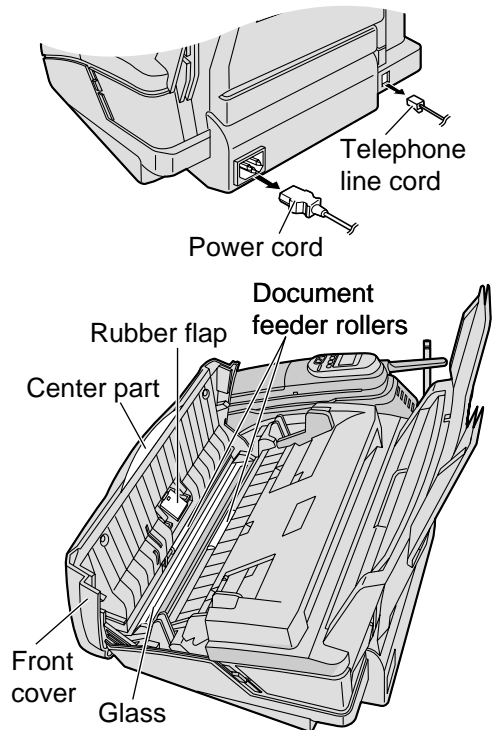

Caution:

- Do not use paper products, such as paper towels or tissues, to clean the inside of the unit.

Cleaning

Thermal head

If dirty patterns or black or white bands appear on a copied or received document, clean the thermal head.

- 1** Disconnect the power cord and the telephone line cord.
- 2** Open the front cover by pulling up the center part.
- 3** Open the back cover by pushing the back cover open button.
- 4** Clean the thermal head with a cloth moistened with isopropyl rubbing alcohol, and let it dry thoroughly.
- 5** Close the back cover securely by pushing down on the dotted area at both ends. Close the front cover securely.
- 6** Connect the power cord and the telephone line cord.

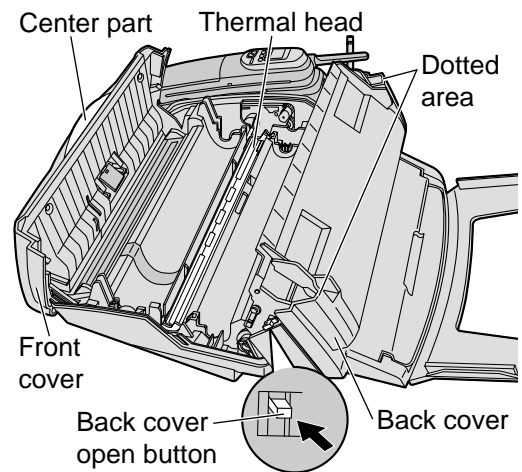
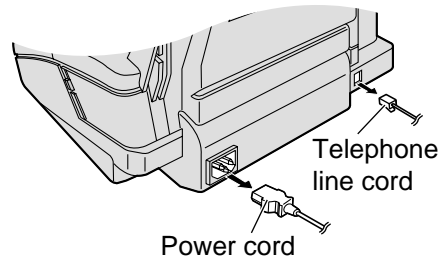

Caution:

- To prevent malfunction due to static electricity, do not use a dry cloth and do not touch the thermal head directly.

Charge contacts

Clean the charge contacts with a dry, soft cloth once a month, or the battery may not charge properly.

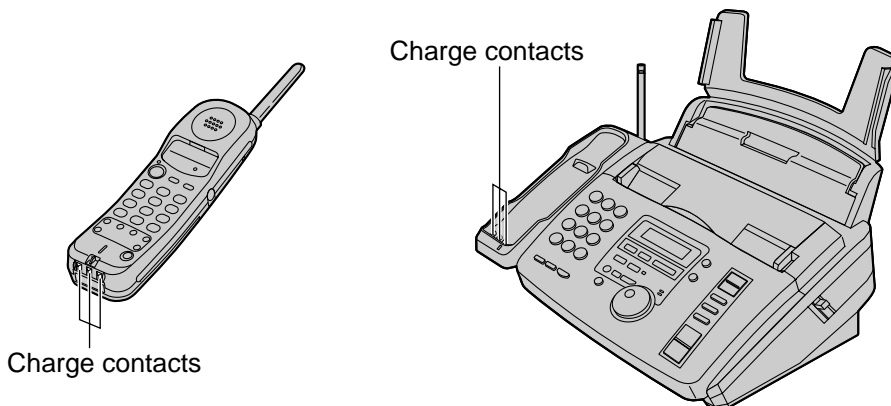

Reference lists and reports

You can print out the following lists and reports for your reference.

Setup list: provides you with the current settings of the basic and advanced programming features (p. 83–88).

Telephone number list: provides you with names and telephone numbers which are stored in the JOG DIAL directory. The telephone number codes are as shown below.

P: A pause has been entered.

F: A flash has been entered.

Journal report: keeps records of fax transmission and reception. This report will be printed automatically after every 30 fax communications (p. 52).

Printer test list: allows you to check the print quality of your unit. If the test print has a dirty pattern, or blurred points or lines, clean the thermal head (p. 104).

Broadcast programming list: provides you with names and telephone numbers which are stored in the broadcast feature (p. 55).

Caller ID list: keeps records of the last 30 callers after subscribing to a Caller ID service. This report will be printed automatically after every 30 callers (p. 43).

1 Press **MENU** twice.

Display: 2.PRINT REPORT

2 Rotate **JOG DIAL** until the desired item is displayed.

SETUP LIST

TEL NO. LIST

JOURNAL REPORT

PRINTER TEST

BROADCAST LIST

CALLER ID LIST

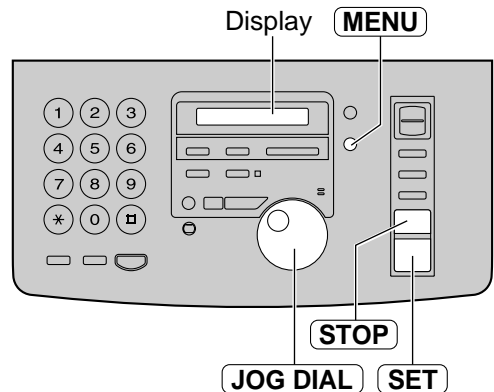

3 Press **SET** to start printing.

PRINTING

- To stop printing, press **STOP**.
- After printing, the printed item will be displayed.

4 Press **MENU**.

Limited Warranty

Panasonic Consumer Electronics Company, Division of Matsushita Electric Corporation of America

One Panasonic Way, Secaucus,
New Jersey 07094

Panasonic Sales Company Division of Matsushita Electric of Puerto Rico, Inc.

Ave. 65 de Infantería, Km. 9.5, San Gabriel
Industrial Park, Carolina, Puerto Rico 00985

PANASONIC Facsimile Products Limited Warranty

Have any questions? CALL 1-800-HELP-FAX (1-800-435-7329) on:

How to operate the unit, How to get repair service, How to get supplies.

Panasonic Consumer Electronics Company or Panasonic Sales Company (collectively referred to as "the warrantor"), will repair this product with new or refurbished parts, free of charge, in the USA or Puerto Rico for one (1) year limited warranty from the date of original purchase in the event of a defect in materials or workmanship.

This Limited Warranty Excludes both Labor and Parts for: batteries, antennas, and cosmetic parts (cabinet).

Carry-in or mail-in service in the USA or Puerto Rico can be obtained during the warranty period by contacting a Panasonic Services Company (PASC) Factory Servicenter listed in the Servicenter Directory. Or call, toll free, 1-800-HELP-FAX (1-800-435-7329) to locate a PASC Factory Servicenter. Carry-in or mail-in service in Puerto Rico can be obtained during the warranty period by calling the Panasonic Sales Company telephone number listed in the Servicenter Directory.

This warranty is extended only to the original purchaser. A purchase receipt or other proof of date of original purchase will be required before warranty service is rendered.

This warranty only covers failures due to defects in material or workmanship which occur during normal use and (when applicable) does not cover the ink film, the toner cartridge and drum unit or the print and ink film. The inability of this product to interface with any specific computer is not a manufacturing defect and is outside of the scope of this Limited Warranty. In no event shall the warrantor be liable by reason of such incompatibility. The warranty does not cover damages which occur in shipment, or failures which are caused by products not supplied by the warrantor such as non Panasonic ink film, or failures which result from accident, misuse, abuse, neglect, mishandling, faulty installation, misapplication, set-up adjustments, improper operation or maintenance, alteration, modification, power line surge, improper voltage supply, lightning damage, signal reception problems, rental use of the product, or service by anyone other than a PASC Factory Servicenter or a PASC authorized Servicenter, or damage that is attributable to acts of God.

LIMITS AND EXCLUSIONS

There are no express warranties except as listed above.

THE WARRANTOR SHALL NOT BE LIABLE FOR INCIDENTAL OR CONSEQUENTIAL DAMAGES RESULTING FROM THE USE OF THIS PRODUCT, OR ARISING OUT OF ANY BREACH OF THIS WARRANTY. ALL EXPRESS AND IMPLIED WARRANTIES, INCLUDING THE WARRANTIES OF MERCHANTABILITY, ARE LIMITED TO THE APPLICABLE WARRANTY PERIOD SET FORTH ABOVE.

Some states do not allow the exclusion or limitation of incidental or consequential damages, or limitations on how long an implied warranty lasts, so the above exclusions or limitations may not apply to you.

This warranty gives you specific legal rights and you may also have other rights which vary from state to state. If a problem with this product develops during or after the warranty period, you may contact your dealer or Servicenter. If the problem is not handled to your satisfaction, then write to the Customer Satisfaction Center at the company address indicated above.

For product service

- Servicenters are listed on next page.
- Call toll free 1-800-HELP-FAX (435-7329) for the location of an authorized servicenter.
- After the fax advantage program, please contact our Continued Services Technical Support Line at 1-900-555-PANA (1-900-555-7262). If you have difficulty reaching this number, it may be blocked by your phone company. Please contact your local phone company to correct this.

When you ship the product

- Carefully pack your unit, preferably in the original carton.
- Attach a letter, detailing the symptom or problem, to the outside of the carton.
- Send the unit to an authorized servicenter, prepaid and adequately insured.
- Do not send your unit to the Panasonic Consumer Electronics Company or to any executive or regional sales offices. These locations do not repair consumer products.

Servicenter Directory

For Product Information, Operating Assistance, Literature Request, Dealer Locations, and all Customer Service inquiries please contact:
1-800-HELP-FAX (1-800-435-7329), Monday-Friday 9am - 8pm EST.

Web Site: www.panasonic.com

(for customers in the USA or Puerto Rico ONLY)

You can purchase parts, accessories or locate your nearest servicenter by visiting our Web Site.

Factory Servicenters Locations

<p>CALIFORNIA 6550 Katella Avenue Cypress, CA 90630</p> <p>800 Dubuque Avenue S. San Francisco, CA 94080</p> <p>20201 Sherman Way Suite 102 Canoga Park, CA 91306</p> <p>3878 Ruffin Road Suite A San Diego, CA 92123</p> <p>COLORADO 1640 South Abilene Street Suite D Aurora, CO 80012</p> <p>FLORIDA 3700 North 29th Avenue Suite 102 Hollywood, FL 33020</p>	<p>GEORGIA 8655 Roswell Road Suite 100 Atlanta, GA 30350</p> <p>ILLINOIS 9060 Golf Road Niles, IL 60714</p> <p>1703 North Randall Road Elgin, IL 60123 (Pick-up / Drop-off only)</p> <p>MARYLAND 62 Mountain Road Glen Burnie, MD 21061</p> <p>MASSACHUSETTS 60 Glacier Drive Suite G Westwood, MA 02090</p>	<p>MICHIGAN 37048 Van Dyke Avenue Sterling Heights, MI 48312</p> <p>MINNESOTA 7850-12th Avenue South Airport Business Center Bloomington, MN 55425</p> <p>OHIO 2236 Waycross Road Civic Center Plaza Forest Park, OH 45240</p> <p>PENNSYLVANIA 2221 Cabot Blvd. West Suite B Langhorne, PA 19047</p>	<p>TEXAS 13615 Welch Road Suite #101 Farmers Branch, TX 75244</p> <p>WASHINGTON 20425-84th Avenue South Kent, WA 98032</p> <p>HAWAII 99-859 Iwaiwa Street Aiea, Hawaii 96701 Phone (808) 488-1996 Fax (808) 486-4369</p>
--	--	---	--

Service in Puerto Rico

Matsushita Electric of Puerto Rico, Inc. Panasonic Sales Company/ Factory Servicenter:
Ave. 65 de Infantería, Km. 9.5, San Gabriel Industrial Park, Carolina, Puerto Rico 00985
Phone (787) 750-4300 Fax (787) 768-2910

List of FCC requirements and information

If required by the telephone company, inform them of the following.

- FCC Registration No.:
(found on the rear of the unit)
- Ringer Equivalence No.:
(found on the rear of the unit)
- The particular telephone line to which the equipment is connected.

This unit must not be connected to a coin operated line. If you are on a party line, check with your local telephone company.

Ringer Equivalence Number (REN):

This REN is useful in determining the quantity of devices you may connect to your telephone line and still have all of those devices ring when your telephone number is called. In most but not all areas, the sum of the REN's of all devices connected to one line should not exceed five (5.0). To be certain of the number of devices you may connect to your line, as determined by the REN, you should contact your local telephone company to determine the maximum REN for your calling area.

In the event that terminal equipment causes harm to the telephone network, the telephone company should notify the customer, if possible, that service may be stopped. However, where prior notice is impractical, the company may temporarily cease service providing that they:

- a) Promptly notify the customer.
- b) Give the customer an opportunity to correct the problem with their equipment.
- c) Inform the customer of the right to bring a complaint to the Federal Communication Commission pursuant to procedures set out in FCC Rules and Regulations Subpart E of Part 68.

The Telephone Company may make changes in its communications facilities, equipment operations, or procedures where such action is reasonably required in the operation of its business and is not inconsistent with the rules and regulations in FCC Part 68. If such changes can be reasonably expected to render any customer terminal equipment incompatible with telephone company communications facilities, or require modification or

alteration of such terminal equipment, or otherwise materially affect its use or performance, the customer shall be given adequate notice in writing, to allow the customer an opportunity to maintain uninterrupted service.

CAUTION:

Any changes or modifications not expressly approved by the party responsible for compliance could void the user's authority to operate this device.

When programming emergency numbers and/or making test calls to emergency numbers:

1. Remain on the line and briefly explain to the dispatcher the reason for the call before hanging up.
2. Perform such activities in the off-peak hours; such as early morning or late evenings.

This telephone provides magnetic coupling to hearing aids.

NOTE:

This equipment has been tested and found to comply with the limits for a Class B digital device, pursuant to Part 15 of the FCC Rules. These limits are designed to provide reasonable protection against harmful interference in a residential installation. This equipment generates, uses, and can radiate radio frequency energy and, if not installed and used in accordance with the instructions, may cause harmful interference to radio communications. However, there is no guarantee that interference will not occur in a particular installation. If this equipment does cause harmful interference to radio or television reception, which can be determined by turning the equipment off and on, the user is encouraged to try to correct the interference by one or more of the following measures:

- Reorient or relocate the receiving antenna.
- Increase the separation between the equipment and receiver.
- Connect the equipment into an outlet on a circuit different from that to which the receiver is connected.
- Consult the dealer or an experienced radio/TV technician for help.

Technical data about this product

■ Main Unit

Applicable Lines:	Public Switched Telephone Network
Document Size:	Max. 216 mm (8½") in width Max. 600 mm (23⅝") in length
Effective Scanning Width:	208 mm (8⅜")
Recording Paper Size:	Letter: 216 mm x 279 mm (8½" x 11") Legal: 216 mm x 356 mm (8½" x 14")
Effective Printing Width:	208 mm (8⅜")
Transmission Time*:	Approx. 9 s/page (Original mode)**
Scanning Density:	Horizontal: 8 pels/mm (203 pels/inch) Vertical: 3.85 lines/mm (98 lines/inch) —"STANDARD" mode 7.7 lines/mm (196 lines/inch) —"FINE"/"HALF TONE" mode 15.4 lines/mm (392 lines/inch) —"SUPER FINE" mode
Halftone Level:	64-level
Scanner Type:	Contact Image Sensor (CIS)
Printer Type:	Thermal Transfer on plain paper
Data Compression System:	Modified Huffman (MH), Modified READ (MR)
Modem Speed:	14,400 / 12,000 / 9,600 / 7,200 / 4,800 / 2,400 bps; Automatic Fallback
Operating Environment:	5 °C – 35 °C (41 °F – 95 °F), 20 % – 80 % RH (Relative Humidity)
Dimensions (H x W x D):	185 mm x 368 mm x 276 mm (7⅜" x 14½" x 10⅞")
Mass (Weight):	Approx. 3.8 kg (8.5 lb.)
Power Consumption:	Standby: Approx. 4 W Transmission: Approx. 16 W Reception: Approx. 42 W (When receiving a 20% black document) Copy: Approx. 42 W (When copying a 20% black document) Maximum: Approx. 135 W (When copying a 100% black document)
Power Supply:	120 V AC, 60 Hz
Memory Capacity:	Voice memory***: Approx. 18 minutes of recording time including greeting messages Fax memory: Approx. 28 pages of memory reception Approx. 25 pages of memory transmission (Based on the ITU-T No. 1 Test Chart in standard resolution.)

■ Handset

Operating Environment:	5 °C – 35 °C (41 °F – 95 °F), 45 % – 85 % RH (Relative Humidity)
Dimensions (H x W x D):	Approx. 45 mm x 55 mm x 271 mm (1⅞" x 2⅜" x 10⅞")
Mass (Weight):	Approx. 260 g (0.6 lb.)
Power Supply:	Ni-Cd battery (3.6 V, 600 mAh)
Frequency:	926 MHz–927 MHz, 902 MHz–903 MHz (30 channels)
Security Codes:	1,000,000

* Transmission speed depends upon the contents of the pages, resolution, telephone line conditions and capability of the other party's machine.

** The 9 second speed is based upon the ITU-T No. 1 Test Chart and original mode. If the capability of the other party's machine is inferior to your unit, the transmission time may be longer.

*** Recording time may be reduced by the calling party's background noise.

Note:

- Any details given in these instructions are subject to change without notice.
- The pictures and illustrations in these instructions may vary slightly from the actual product.

ITU-T No. 1 Test Chart

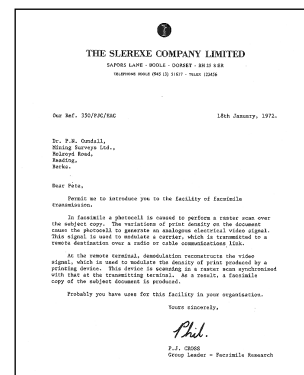

Index

- A**
 - Accessories8, 9
 - Advanced features84–88
 - Alert
 - (Memory reception)(Feature #44) . . .60, 86
 - (Message)(Feature #42)85
 - (Recording time)(Feature #43)86
 - Any key talk feature26
 - AUTO ANSWER button/mode58, 59
 - AUTO ANSWER setting (Feature #77)88
 - AUTO button34, 35
- B**
 - Basic features83
 - Battery
 - (Charging)20
 - (Life)20
 - (Replacing)102
 - Belt clip21
 - Broadcast programming list105
 - Broadcast sending report57
 - Broadcast transmission54–57
- C**
 - Call counter72
 - Caller ID40–47
 - Caller ID list (Feature #26)43, 85, 105
 - CALLER ID SEARCH button42, 45
 - Caller's recording time (Feature #10)83
 - CALL WAIT button47
 - Character table17, 37
 - CH button24
 - Cleaning103–104
 - CLEAR button34, 44, 46
 - COLLATE button66
 - Communication messages89
 - Computer, using with64
 - Connecting tone (Feature #76)88
 - Connections14
 - Copy66, 67
 - Copy enlargement/reduction66, 67
 - COPY START button66
- D**
 - Date and time (Feature #01)15, 83
 - Delayed transmission (Feature #25)84
 - Delete button16, 17, 36, 37
 - Dialing mode (Feature #13)83
 - DIGITAL SP-PHONE button25, 48
 - Directory feature36
 - DIRECTORY PROGRAM button36
 - Display
 - (Contrast)(Feature #39)85
 - (Error messages)90, 91
 - Distinctive Ring service
 - (Feature #31)85
 - Document feeder103
 - Document jam99
 - Document size51, 109
- E**
 - EDIT button44
 - Enlarge copy66, 67
 - ERASE button73
 - Error messages89–91
 - EXIT button32, 41
- Extension telephone**63, 64
- F**
 - Facsimile telephone number
 - (Feature #03)18, 83
 - Fax activation code (Feature #41)85
 - Fax auto redial50
 - FAX button60
 - FAX ONLY mode58, 61
 - FAX ONLY ring count
 - (Feature #06)61, 83
 - Fax pager (Feature #70)65, 87
 - FAX START button49
 - Fax voice guidance (Feature #47)86
 - Fax voice guide53
 - Feature programming82–88
 - Feeder cleaning103
 - Feeder jam99
 - Feeder pressure99
 - Film9, 100, 101
 - FLASH button33
 - Friendly reception (Feature #46)60, 86
- G**
 - Greeting message
 - (Message transfer)(Feature #61)81, 87
 - (TAD/FAX)69–71
 - (TEL/FAX)62, 63, 70, 71
- H**
 - Handset volume22
 - Headset21
 - HELP button10
 - Hyphen button36, 37
- I**
 - Identa-Ring (Feature #31)85
 - Incoming message monitor (Feature #67)87
 - Ink film9, 100, 101
 - Insert button36, 37
 - INTERCOM button27–29
- J**
 - Jam98, 99
 - JOG DIAL
 - (Making a voice call)39
 - (Repeating the recorded messages)72
 - (Selecting characters)37
 - (Sending faxes)49
 - (Skipping the recorded messages)72
 - (Storing)36–38
 - Journal auto print (Feature #22)84
 - Journal report52, 105
- L**
 - Legal paper12, 13
 - List / Report
 - (Broadcast programming)105
 - (Broadcast sending)57
 - (Caller ID) (Feature #26)43, 85, 105
 - (Journal)52, 105
 - (Power down)97
 - (Printer test)105
 - (Sending)52
 - (Setup)105
 - (Telephone number)105
 - Logo (Feature #02)16, 83
 - LOUD/RINGER button22

M	Memory reception alert (Feature #44) . . .60, 86	Ring pattern detection (Feature #31)85
	Memory transmission49	Ringer volume
	Message alert (Feature #42)85	(Handset)22
	Message transfer (Feature #60) 80, 81, 87	(Main Unit)23
	MUTE button26	S
O	Overseas transmission mode	Sending
	(Feature #23)84	(Broadcast)54–57
P	Pager call (Feature #70)65, 87	(From memory)49
	Paper jam98	(JOG DIAL)49
	Paper tray12	(Manually)49
	PAUSE button33	Sending document
	PLAY MESSAGES button72	(Does not feed or multi-feeds)99
	Power down report97	Sending report (Feature #04)52, 83
	Power failure97	Set default (Feature #80)88
	Power supply14, 109	Setup list105
	Printer test list105	Silent fax recognition ring (Feature #30) . . .85
	Printing paper size109	SKIP
	Printing reports105	(Handset)76
	Problem solving92–97	(Main Unit)72
	PROGRAM button34	SLOW button72
	Programmable features82–88	Speaker volume23
	Pulse dialing (Feature #13)83	Specifications109
Q	QUICK button72	Storing
	QUICK SCAN button49, 66	(Caller information)44
R	Receiving	(Handset)34
	(Fax)60	(JOG DIAL)36–38
	(Setting)58, 59	T
	Receiving alert (Feature #44)86	TAD/FAX mode58, 68
	Receiving reduction (Feature #36)85	TAD/FAX ring count (Feature #06)68, 83
	Recording	TALK button24, 26
	(Greeting message)70, 81	TEL mode59, 60
	(Memo message)74	TEL/FAX delayed ring count (Feature #78) .88
	Recording paper13, 109	TEL/FAX mode59, 62, 63
	Recording paper jam98	Telephone number list105
	Recording time alert (Feature #43)86	Thermal head cleaning104
	Recording time for TAD/FAX greeting	Toll saver68
	message (Feature #54)87	TONE button33
	REDIAL button24, 50	Tone dialing (Feature #13)83
	(Handset)24, 31	Transmission
	(Main Unit)25, 50	(Broadcast)54–57
	Reduce copy67	(From memory)49
	Remote operation card77, 78	(JOG DIAL)49
	Remote operation ID (Feature #11)83	(Manually)49
	REMOTE SP button30	Transmittable document51
	REPEAT	V
	(Handset)76	Voice call
	(Main Unit)72	(Answering)26
	Reduce copy66, 67	(JOG DIAL)39
	Replacement film9, 100, 101	(Making)24, 25
	Reset (Feature #80)88	Voice contact48
	RESOLUTION button49	Voice mail59
	Ring count	Voice time/day stamp72
	(FAX ONLY)(Feature #06)83	VOLUME button22, 23
	(Silent fax recognition)	
	(Feature #30)63, 85	
	(TAD/FAX)(Feature #06)68, 83	
	(TEL/FAX)(Feature #78)88	

Panasonic FAX ADVANTAGE PROGRAM

*Free peace of mind,
direct from Panasonic*

NO EXTRA COST



- **1-year limited warranty¹ parts & labor**
- **Toll-free help line**
- **Free overnight replacement³ and repair program**

The Panasonic Fax Advantage Consumer Service Program.

Panasonic knows that if your fax machine is not up and running, neither is your business. That's why we created the Panasonic Fax Advantage Program. Included at no extra cost with the purchase of a Panasonic Fax Machine, the Fax Advantage Program can provide a free replacement unit² overnight if your original unit is in need of repair.

Here's how it works:

1. If you have a problem with your fax while it is covered by the one-year limited warranty¹, call our toll-free help-line at 1-800-HELPFAX.
2. Talk to one of our technical experts to diagnose your problem over the phone.
3. If repairs are necessary and you are entitled to service under the terms and conditions of the limited warranty³, we will send a refurbished replacement unit to you overnight or second business day delivery, depending on the time of your call.

A second option available under our one-year limited warranty is to mail-in or carry-in your fax to one of our Regional Service centers, where the unit will be repaired and returned to you.

Instructions

If you choose to receive a replacement unit under the Fax Advantage Program, Panasonic will provide a replacement unit which will be completely refurbished, quality-tested by Panasonic technicians and individually hand-inspected before it is shipped to you. You will keep the replacement unit and send the original unit to us in the replacement unit's box. UPS will pick up the unit at no charge to you, should it be determined that you are entitled to warranty service. A proof-of-purchase must be included with the returned product. Any unit that is replaced by Panasonic and not shipped with proper proof-of-purchase by you will be subject to a minimum \$100.00 charge. The original unit must be properly packaged in the same manner as the replacement unit, utilizing

the packing materials provided. Damage due to improper or inadequate packing will be charged to you as an out-of-warranty cost. If our 1-800-HELPFAX technicians determine that your unit may be an "out-of-box failure"⁴, we will attempt to provide you with a factory-new replacement unit⁵. You must ship a copy of your receipt with your original unit to verify that you purchased the unit within 10 days prior to your 1-800-HELPFAX call.

Requirements

You must give our technicians a valid credit card number (Discover, VISA, Master Card, or American Express/Optima). Product that is not returned to Panasonic by 10 business days after shipment of the replacement product will be charged to your credit card account at Panasonic's Suggested Retail Price (see dealer for details). If your original unit is not eligible for warranty service, your card will be charged for the non-warranty repair of the unit at Panasonic's current rate for parts and labor and for any shipping charges associated with this program. If you do not wish to pay out-of-warranty repair costs, you will be responsible for returning the replacement unit to Panasonic and for paying all shipping charges associated with this program including the overnight delivery of the replacement product to you, shipment of the problem unit to Panasonic, shipment of the replacement unit back to Panasonic and the return of your original unit back to you. Credit status will be verified prior to sending the replacement product.

1. See dealer for limited warranty details.
2. Replacement unit is refurbished.
3. Replacement program excludes Puerto Rico and is subject to termination at any time without advance notice.
4. "Out-of-box failure" is an inoperable unit that was purchased no more than 10 days prior to your 1-800-HELPFAX call, and would otherwise qualify for warranty service under the terms and conditions of the limited warranty.
5. Panasonic reserves the right to send a refurbished unit.

**Panasonic Consumer Electronics
Company, Division of Matsushita
Electric Corporation of America**
One Panasonic Way, Secaucus,
New Jersey 07094

**Panasonic Sales Company,
Division of Matsushita Electric of
Puerto Rico, Inc. ("PSC")**
Ave. 65 de Infantería, Km. 9.5
San Gabriel Industrial Park, Carolina,
Puerto Rico 00985

Free Manuals Download Website

<http://myh66.com>

<http://usermanuals.us>

<http://www.somanuals.com>

<http://www.4manuals.cc>

<http://www.manual-lib.com>

<http://www.404manual.com>

<http://www.luxmanual.com>

<http://aubethermostatmanual.com>

Golf course search by state

<http://golfingnear.com>

Email search by domain

<http://emailbydomain.com>

Auto manuals search

<http://auto.somanuals.com>

TV manuals search

<http://tv.somanuals.com>