

Panasonic

2-Line Plain Paper FAX

Model No.

KX-FPW111

Quick Start



To get started,
please read the
Quick Start section
(p. 4 – 11).

Initial Preparation

Telephone

Fax/Copy

Help

General Information

Comienzo rápido
en español

OPERATING INSTRUCTIONS

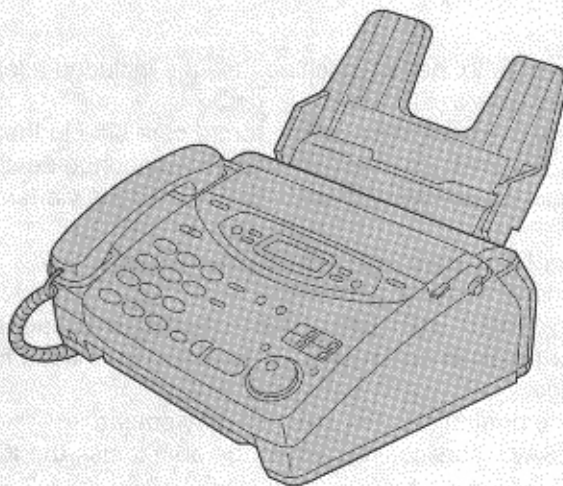

Please read these Operating Instructions before using the unit and save for future reference.

- This unit is designed for use in the United States of America, and may not operate in other countries. (See page 118 for more details.)
- Este producto ha sido diseñado para su uso en los Estados Unidos de América, y puede no funcionar correctamente en otros países. (Consulte la página 118 para tener más detalles.)

**FOR OPERATION ASSISTANCE,
CALL 1-800-HELP-FAX (1-800-435-7329)
OR SEND A FAX TO 1-215-741-6376.**

Comienzo rápido (p. 119)

Thank you for purchasing a Panasonic facsimile.

Welcome to the world of Panasonic facsimiles.

This product combines facsimile, telephone and copier features to provide you with more efficient office or home use. By utilizing these convenient features, you can maximize the effectiveness of this unit.

Things you should keep record of

Attach your sales receipt here

For future reference

Date of purchase

Serial number

(found on the rear of the unit)

Dealer's name and address

Dealer's telephone number

Caution:

- When connecting telephone line cords to the fax machine, use the included telephone line cords for reliable data communications and compliance with FCC rules.
- When connecting 4-wire telephone line cord, connect the ferrite core side to the fax machine.
- The Telephone Protection Act of 1991 requires the following information to be clearly stated either at the top or bottom margin of the first message page when transmitting messages via telephone facsimile;
 - Date and time of transmission,
 - Identification of the business, entity or person(s) sending the facsimile, and
 - Telephone number of the business, entity or person(s).To program this information into your unit, complete all the instructions on pages 29 to 32.
- Note that the images of copied or received documents will remain on the used film. Use discretion when disposing of the used film cartridge.
- Do not rub or use an eraser on the printed side, as the print may smear.
- If you have not applied to the *faxSAV*[®] service, you will not be able to use the IQ-FAX function (p. 63–65).

Trademarks

faxSAV is a registered trademark of FaxSav Incorporated.

Hammermill[®] is a registered trademark of INTERNATIONAL PAPER in the United States and/or other countries.

All other trademarks identified herein are the property of their respective owners.

Copyright:

This manual is copyrighted by Kyushu Matsushita Electric Co., Ltd. (KME) and its licensee. Under the copyright laws, this manual may not be reproduced in any form, in whole or part, without the prior written consent of KME and its licensee.

© Kyushu Matsushita Electric Co., Ltd. 1999

Important safety instructions

When using this unit, basic safety precautions should always be followed to reduce the risk of fire, electric shock, or personal injury.

1. Read and understand all instructions.
2. Follow all warnings and instructions marked on this unit.
3. Unplug this unit from AC outlets before cleaning. Do not use liquid or aerosol cleaners. Use a damp cloth for cleaning.
4. Do not use this unit near water, for example near a bath tub, wash bowl, kitchen sink, or the like.
5. Place the unit securely on a stable surface. Serious damage and/or injury may result if the unit falls.
6. Do not cover slots and openings on the unit. They are provided for ventilation and protection against overheating. Never place the unit near radiators, or in a place where proper ventilation is not provided.
7. Use only the power source marked on the unit. If you are not sure of the type of power supplied to your home, consult your dealer or local power company.
8. For safety purposes this unit is equipped with a three prong grounded plug. If you do not have this type of outlet, please have one installed. Do not use any type of adaptor plug to defeat this safety feature.
9. Do not place objects on the power cord. Install the unit where no one can step or trip on the cord.
10. Do not overload wall outlets and extension cords. This can result in the risk of fire or electric shock.
11. Never push any objects through slots in this unit. This may result in the risk of fire or electric shock. Never spill any liquid on the unit.
12. To reduce the risk of electric shock, do not disassemble this unit. Take the unit to an authorized servicenter when service is required. Opening or removing covers may expose you to dangerous voltages or other risks. Incorrect reassembly can cause electric shock when the unit is subsequently used.
13. Unplug this unit from the wall outlet and refer servicing to an authorized servicenter if any of the following occur:
 - A. If the power supply cord or plug is damaged or frayed.
 - B. If liquid has been spilled into the unit.
 - C. If the unit has been exposed to rain or water.
 - D. If the unit does not work normally by following the operating instructions. Adjust only controls covered by the operating instructions. Improper adjustment may require extensive work by an authorized servicenter.
 - E. If the unit has been dropped or physically damaged.
 - F. If the unit exhibits a distinct change in performance.
14. During thunderstorms, avoid using telephones, except cordless types. There may be a remote risk of an electric shock from lightning.
15. Do not use this unit to report a gas leak when in the vicinity of the leak.

SAVE THESE INSTRUCTIONS

INSTALLATION:

1. Never install telephone wiring during a lightning storm.
2. Never install telephone jacks in wet locations unless the jack is specifically designed for wet locations.
3. Never touch uninsulated telephone wires or terminals unless the telephone line has been disconnected at the network interface.
4. Use caution when installing or modifying telephone lines.

WARNING:

- To prevent the risk of fire or electrical shock, do not expose this product to rain or any type of moisture.

OTHER INFORMATION

- Keep the unit away from electrical noise generating devices, such as fluorescent lamps and motors.
- The unit should be kept free from dust, high temperature and vibration.
- The unit should not be exposed to direct sunlight.
- Do not place heavy objects on top of this unit.
- Do not touch the plug with wet hands.

Installation

Before installation (p. 21)

A. Remove the shipping tape.

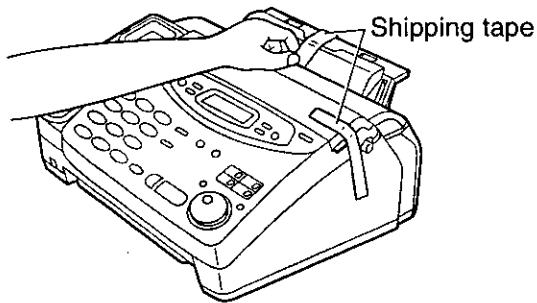

B. Open the cover, remove the leaflet under the film cartridge and close the cover.

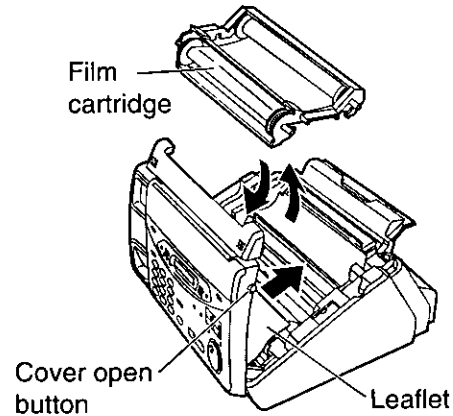

1

Paper tray (p. 22)

Insert the two tabs on the paper tray into the slots on the back of the unit.

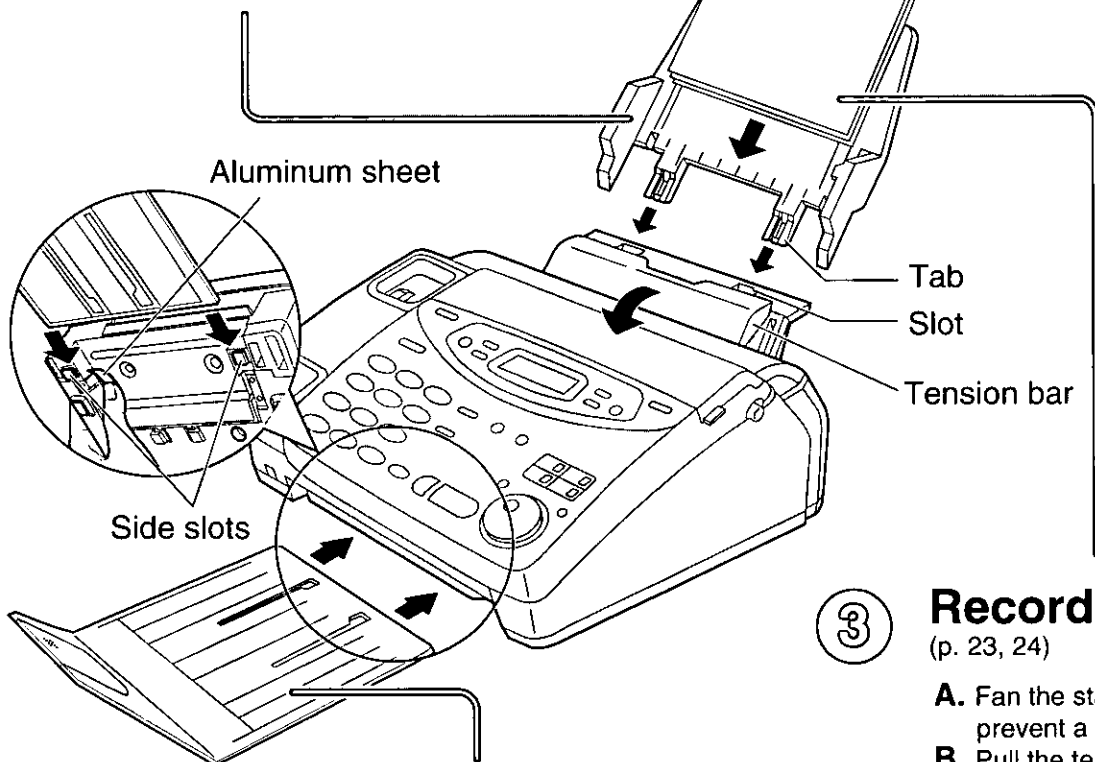

2

Paper stacker (p. 22)

- A.** Lift the front of the unit and hold the aluminum sheet.
- B.** Insert the paper stacker into the side slots.

3

Recording paper (p. 23, 24)

- A.** Fan the stack of paper to prevent a paper jam.
- B.** Pull the tension bar forward and hold open while inserting the paper.

Connections

■ To connect to a two-line telephone jack (RJ14C)

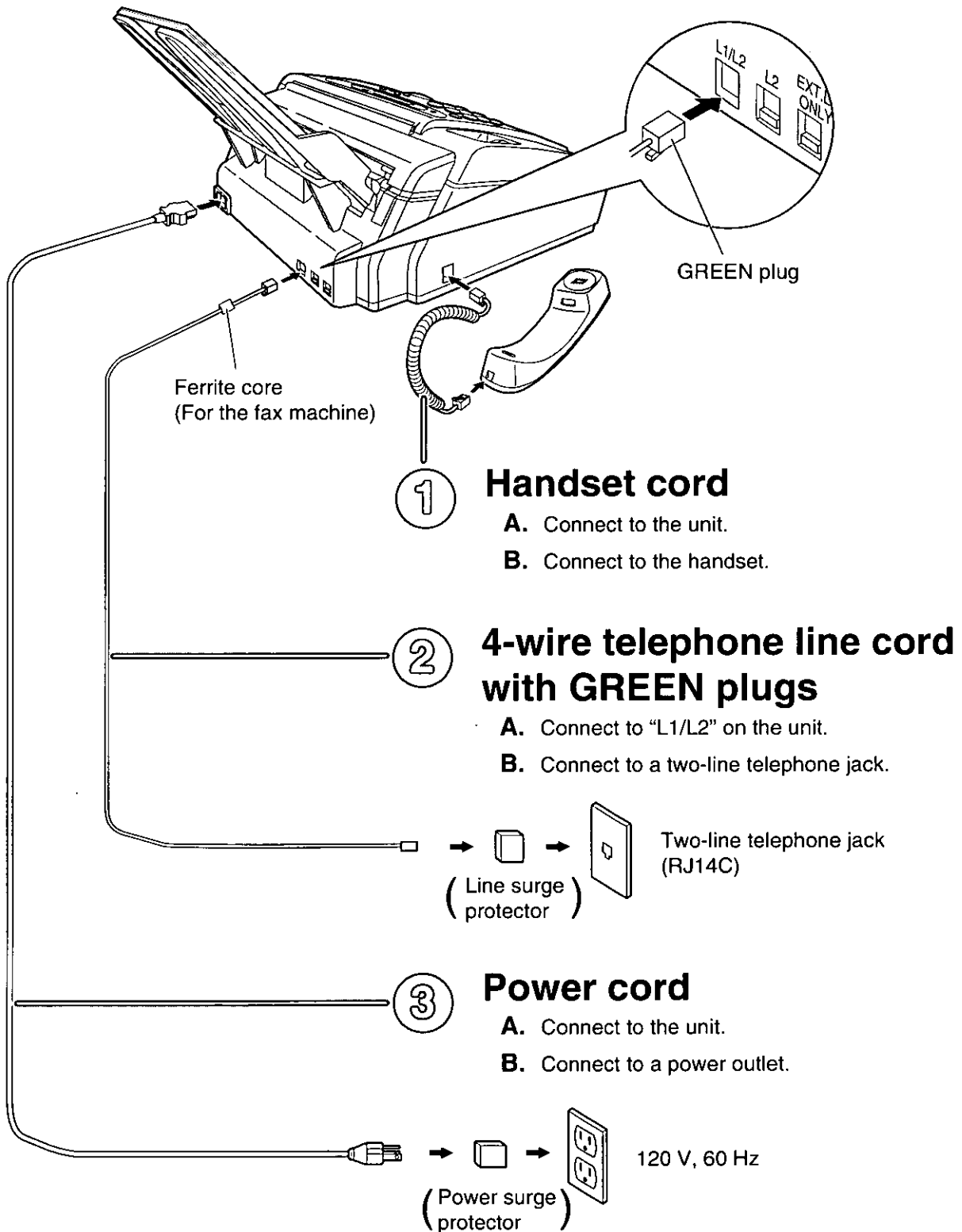

- For further details, see pages 25–28.
- To connect a telephone answering machine, see page 82.

Quick Start

■ To connect to two single line telephone jacks (RJ11C)

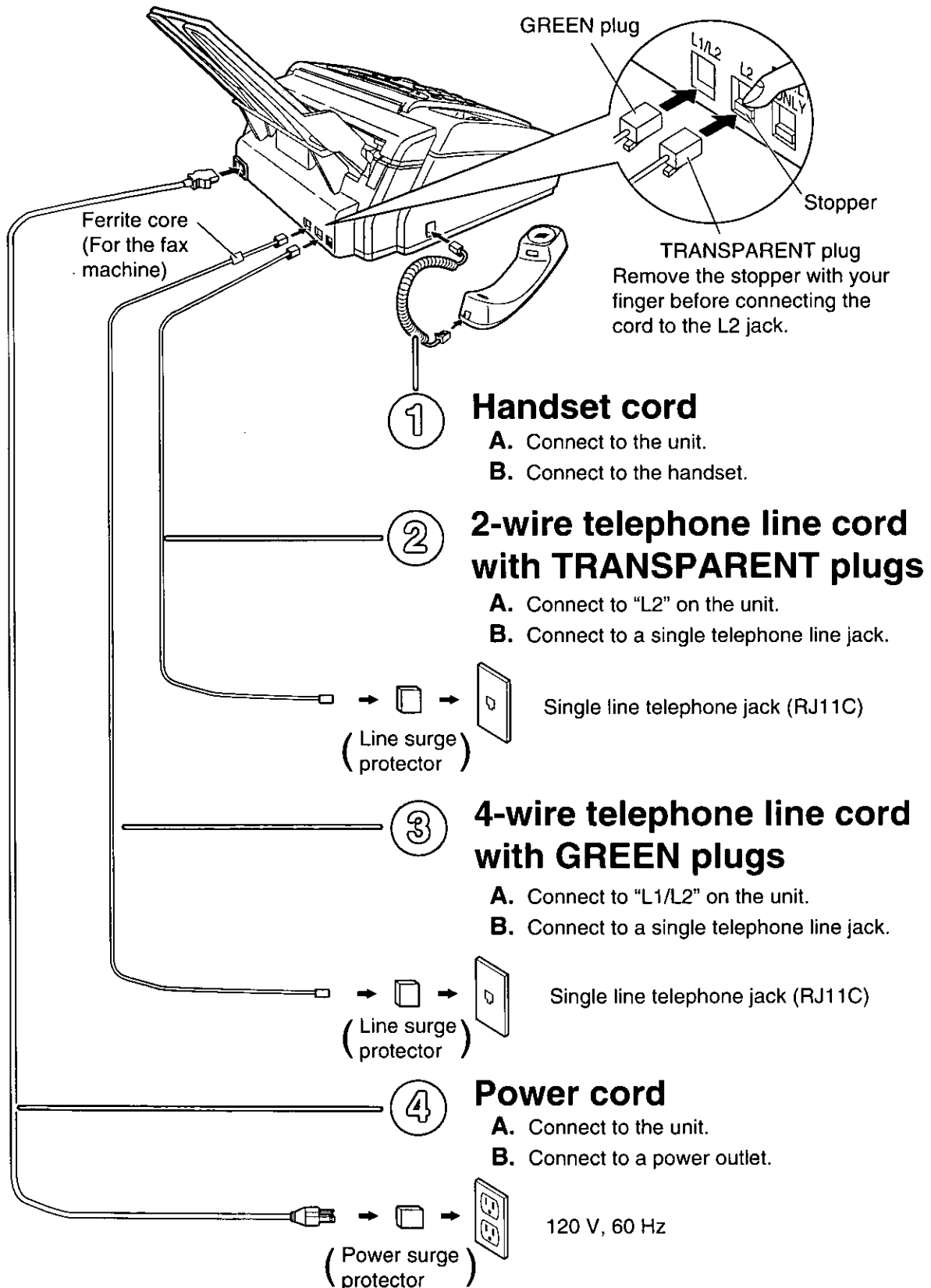

- For further details, see pages 25–28.
- To connect a telephone answering machine, see page 82.

Voice calls - making/answering

Voice calls - making

- ① Lift the handset.
 - A free line is selected automatically and the line indicator lights green.

- ② Dial the number.

- ③ When finished talking, replace the handset.

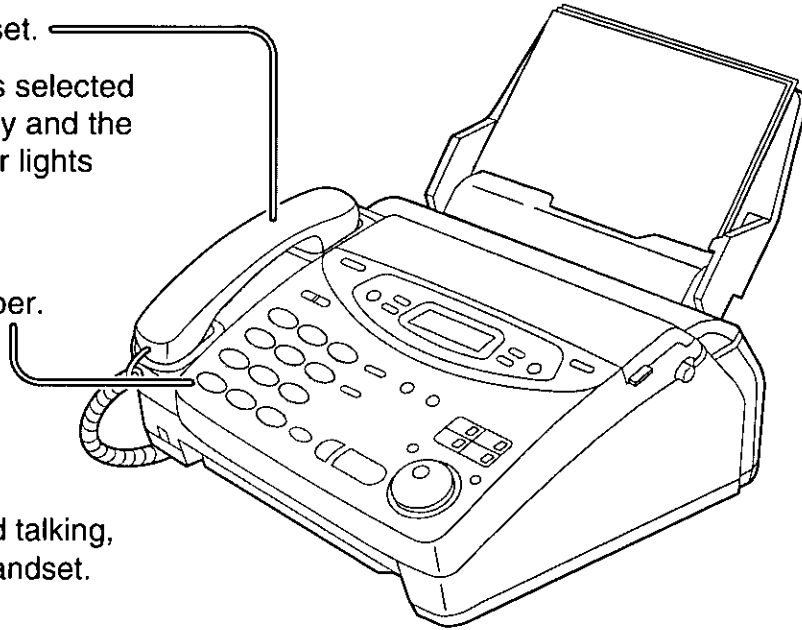

- For further details, see page 39.
- If you are having trouble, see page 102.

Voice calls - answering

1

When the unit rings, lift the handset.

- The calling line is selected automatically and the line indicator lights green.

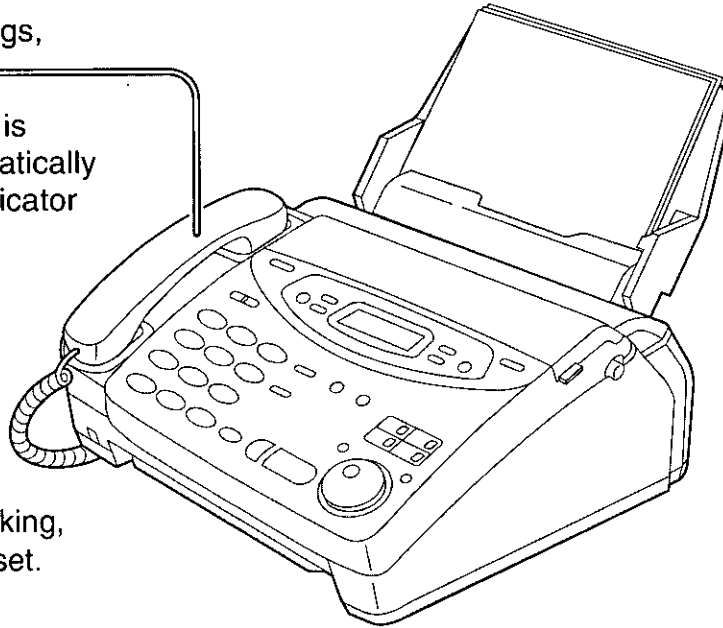

2

When finished talking, replace the handset.

- For further details, see page 40.
- If you are having trouble, see page 102.

Faxes - sending/receiving

Faxes - sending

- 1 Open the document feeder tray.

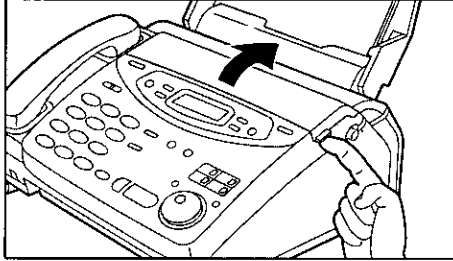

- 2 Adjust the width of the document guides to the size of the document.

- 3 Insert the document until a single beep is heard and the unit grabs the document.

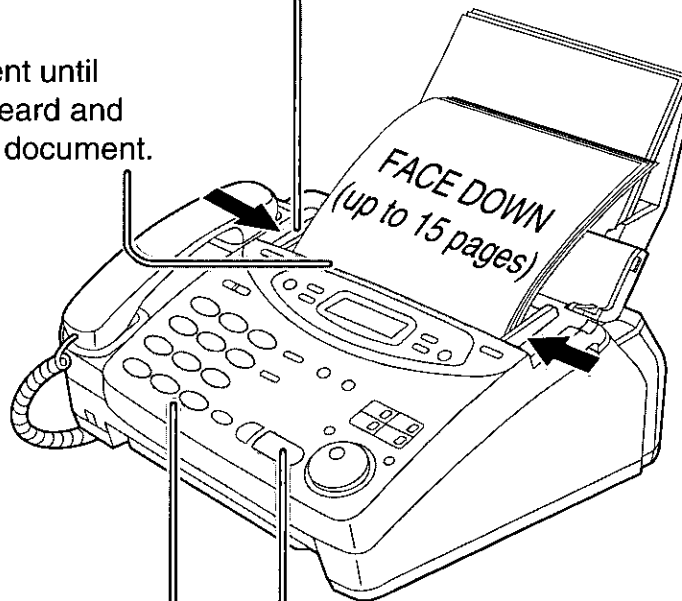

- 4 Dial the fax number.

- 5 Press **START/SET/COPY**.

- For further details, see page 58.
- If you are having trouble, see pages 102 and 103.

Faxes - receiving

- ① When the unit rings, lift the handset.

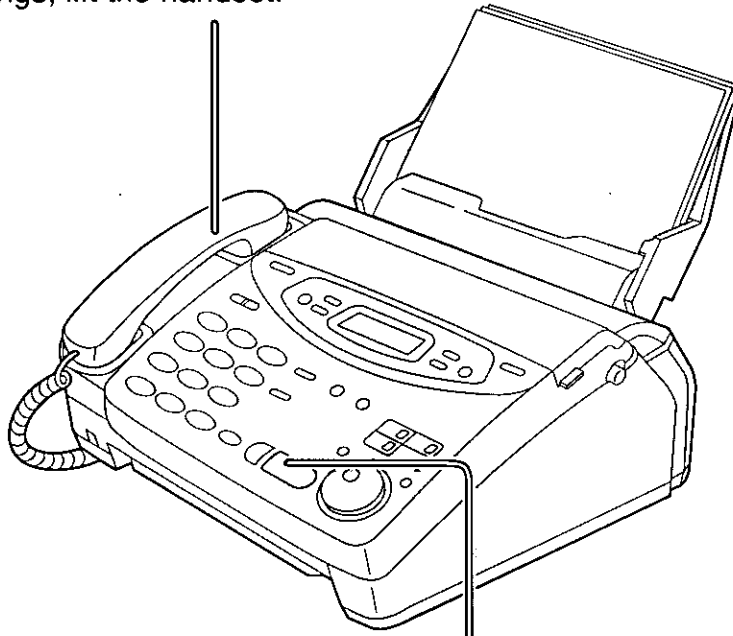

- ② When:
 - document reception is required,
 - a fax calling tone (slow beep) is heard, or
 - no sound is heard,press **START/SET/COPY**.

- ③ Replace the handset.

- For further details, see page 78.
- You can select the way to receive calls according to your needs (p. 74–77).
- If you are having trouble, see page 103.

Copying

- 1 Open the document feeder tray.

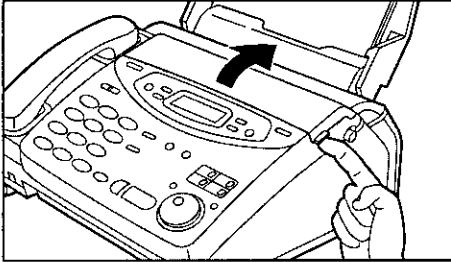

- 2 Adjust the width of the document guides to the size of the document.

- 3 Insert the document until a single beep is heard and the unit grabs the document.
 - Make sure the handset is on the cradle.

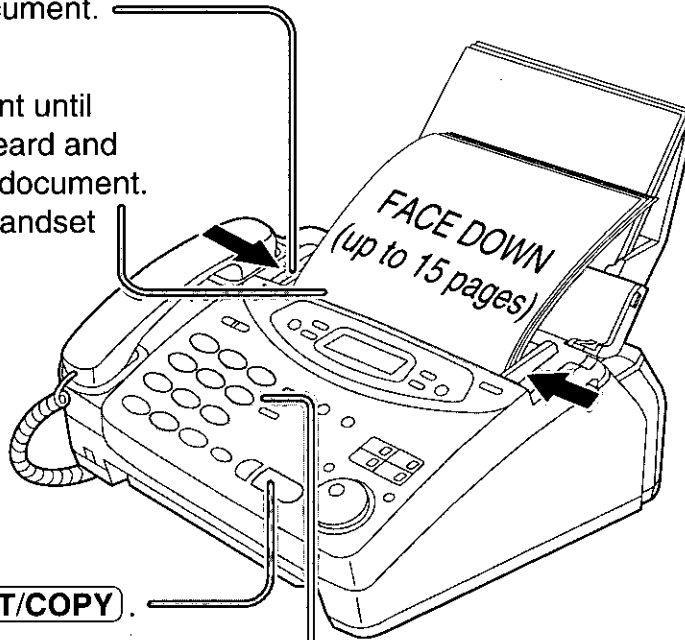

- 4 Press **START/SET/COPY**.

- 5 Enter the number of copies.

- 6 Press **START/SET/COPY**.

- For further details, see page 97.
- If you are having trouble, see page 104.

Table of Contents

Initial Preparation	Accessories	Included accessories	15
		Accessory order information	15
	Features	Features of this 2-line system	16
	Help Button	Help function	17
	Finding the Controls	Location	18
		Overview	20
	Setup	Before installation	21
		Paper tray	22
		Paper stacker	22
		Recording paper	23
Connections		25	
Date and time, your logo and facsimile telephone number		29	
Dialing mode (touch tone or pulse)		33	
Line usage selection		34	
Line mode		35	
Line ringer mode		36	
Switching telephone numbers between line 1 and line 2		37	
Volumes	Adjusting volumes	38	
Telephone	Making and Answering Calls	Voice calls - making	39
		Voice calls - answering	40
		Using the other line during a conversation	41
		Making conference call	42
		TONE and PAUSE buttons	43
	One-Touch Dial	Storing names and telephone numbers in the One-Touch Dial	44
		Making a voice call using the One-Touch Dial	45
	JOG DIAL	Storing names and telephone numbers in the JOG DIAL directory	46
		Making a voice call using the JOG DIAL directory	49
	Caller ID	Caller ID service from your phone company	50
		Viewing the Caller ID list on the display	51
Calling back from the Caller ID list		52	
Storing telephone numbers in the One-Touch Dial and JOG DIAL directory from the Caller ID list		53	
Erasing all callers' information		54	
Storing your area code		55	
Automatic Caller ID list	56		
Voice Contact	Talking to the caller after fax transmission or reception	57	

Fax/Copy

Sending Faxes	Sending a fax manually	58	
	Documents you can send	59	
	Sending a fax using the One-Touch Dial	60	
	Sending a fax using the JOG DIAL directory	61	
	Sending a fax during a conversation	62	
	IQ-FAX	63	
	Sending report for confirmation	66	
	Automatic journal report	67	
	Delayed transmission (sending a fax at a specified time)	68	
	From memory	69	
	Multiple stations	70	
	Overseas	73	
	Connecting tone	73	
	<hr/>		
	Receiving Faxes	Setting Line 1 to receive calls	74
		Setting Line 2 to receive calls	76
		TEL mode (answering all calls manually)	78
		FAX ONLY mode (all calls are received as faxes)	79
Using the unit with an answering machine		82	
Extension telephone		85	
Fax activation code		85	
Distinctive Ring service (ring pattern detection feature)		86	
TEL/FAX mode (receiving voice calls with rings and fax calls without rings when you are near the unit)		88	
Other size documents		92	
Silent detection (receiving faxes from older model fax machines)		93	
Memory reception alert		93	
Friendly reception		94	
Pager call - when your unit receives a fax		95	
Film detection	96		
<hr/>			
Copying	Making a copy	97	

Help

Error Messages	Reports	99
	Display	100
<hr/>		
Operations	When a function does not work, check here before requesting help	102
	If a power failure occurs	105
<hr/>		
Jams	Recording paper jams	106
	Sending document jams	108
	Sending document does not feed, or multi-feeds	108
<hr/>		
Ink Film	How much film you have left	109
	Replacing the film cartridge	109
<hr/>		
Cleaning	Document feeder	111
	Thermal head and black bar	111

Initial Preparation

Telephone

Fax/Copy

Help

General Information

Comienzo rápido en español

General Information

Print Reports	Printing the feature settings, telephone numbers, journal, printer test list, broadcast list and Caller ID list	112
Display Contrast	Changing the display contrast	113
Reset	Resetting the advanced features	113
FCC Information	List of FCC requirements and information	114
Limited Warranty	Limited Warranty Servicenter Directory Notes for product service and shipping the product	115 116 117
Energy Star	Energy Star	117
Specifications	Technical data about this product	118

Comienzo rápido en español

Comienzo rápido en español	119
-----------------------------------	-----------	-----

Index	127
Features Summary	Summary of user programmable features	129

Included accessories

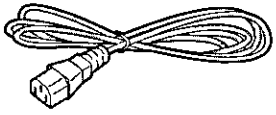
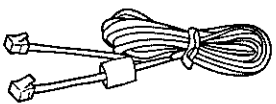
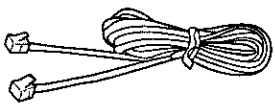
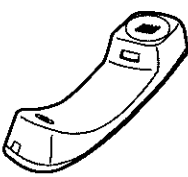
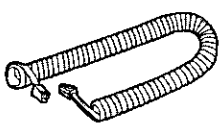
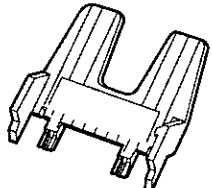
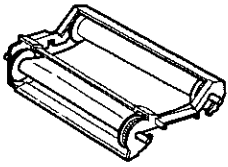
Power cord1  Part No. PFJA1030Z	4-wire telephone line cord with green plugs .1  Part No. PFWAFPW111M	2-wire telephone line cord with transparent plugs1  Part No. PQJA10075Z	Handset1  Part No. PFJXE0805Z
Handset cord1  Part No. PFJA1029Z	Paper tray1  Part No. PFKS1030Z1	Film cartridge1 (with free starter film)  —The film cartridge is pre-installed.	

- When connecting telephone line cords to the fax machine, use the included telephone line cords for reliable data communications and compliance with FCC rules.
- When connecting 4-wire telephone line cord, connect the ferrite core side to the fax machine.
- If any items are missing or damaged, check with the place of purchase.
- The part numbers listed above are subject to change without notice.
- Save the original carton and packing materials for future shipping and transportation of the unit.

Accessory order information

The free starter film cartridge is only 20 meters (65') long. We recommend that you buy regular film cartridge [100 m (328')] for continuous use of your unit.

For best results, use genuine Panasonic film cartridge Model No. KX-FA65.

To order, call toll-free 1-800-332-5368 or see the fax order instructions below.

Fax order: Please send a fax to 1-800-237-9080. Include: your name, shipping address, telephone number, credit card type, number, expiry date and your signature, order part number and quantity, and delivery method – overnight, 2nd day, or ground.

Model No.	Description	Specifications
KX-FA65	Film cartridge	216 mm × 100 m (8½" × 328') roll

Note:

- The film cartridge is not reusable. Do not rewind and use the film again.

Features

Features of this 2-line system

The KX-FPW111 can use two telephone lines allowing you to hold a voice conversation on one line, and send/receive a fax message on the other line. In addition, both lines can be used to hold a conference call with two parties. Below are examples showing how the system can be used.

1. When one line is used for fax communication:

You can make or receive a voice call on the other line.

2. When one line is used for voice communication:

You can send or receive a document on the other line.

3. When an external telephone answering machine connected to the facsimile is used for LINE 1:

You can send or receive documents on LINE 2.

4. While having a conversation on one line:

You can make or answer a second call on the other line and then combine both calls to make a conference call.

Important:

- If one line is busy sending/receiving a fax, the other line can only be used for voice communication.

Auto line selection

The unit will automatically select a free line when you lift the handset or press **MONITOR**. Line 1 is given priority over line 2 when both lines are free. When a line is ringing, that line will automatically be selected when you lift the handset.

You can directly select either line 1 or 2 by pressing **LINE 1** or **LINE 2** before making or answering a call.

Different line features

Line 1 has various convenient features for voice and fax calls.

The following features are available on this line:

- Receiving faxes automatically (AUTO ANSWER mode)
- Sending a fax using the FaxSav service
- Recording voice messages and receiving fax documents (using the external telephone answering machine)
- Remote fax receiving using the extension telephone
- Compatible with Caller ID service
- Three types of receive mode (TEL, FAX ONLY, TEL/FAX)

Line 2 is a simple telephone/facsimile line that allows you to answer all voice and fax calls yourself.

Distinguishable ringer

There is a difference between the ringer sound of line 1 and line 2.

You can control each ringer volume separately (p. 38).

Help function

You can print a quick reference for assistance as follows.

1 Press **HELP**.

Display: **PRESS [▼▲] & [SET]**

2 Press **▼** or **▲** until the desired item is displayed. The following items are available.

1. How to program your unit

1. HOW TO SET UP

2. How to store names in the JOG DIAL directory and how to dial them

2. JOG/AUTO DIAL

3. Help with problems sending faxes

3. FAX SENDING

4. Help with problems receiving faxes

4. FAX RECEIVING

5. How to use the copier function

5. COPIER

6. Frequently asked questions and answers

6. Q and A

7. Explanation of error messages shown on the display

7. ERRORS

8. List of available reports

8. REPORTS

9. How to use the Caller ID service

9. CALLER ID

3 Press **START/SET/COPY**.

PRINTING

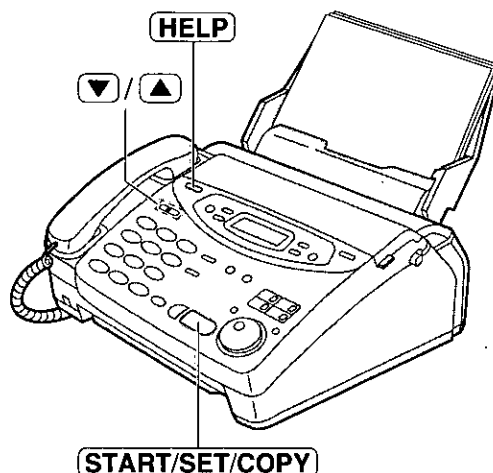

Finding the Controls

Location

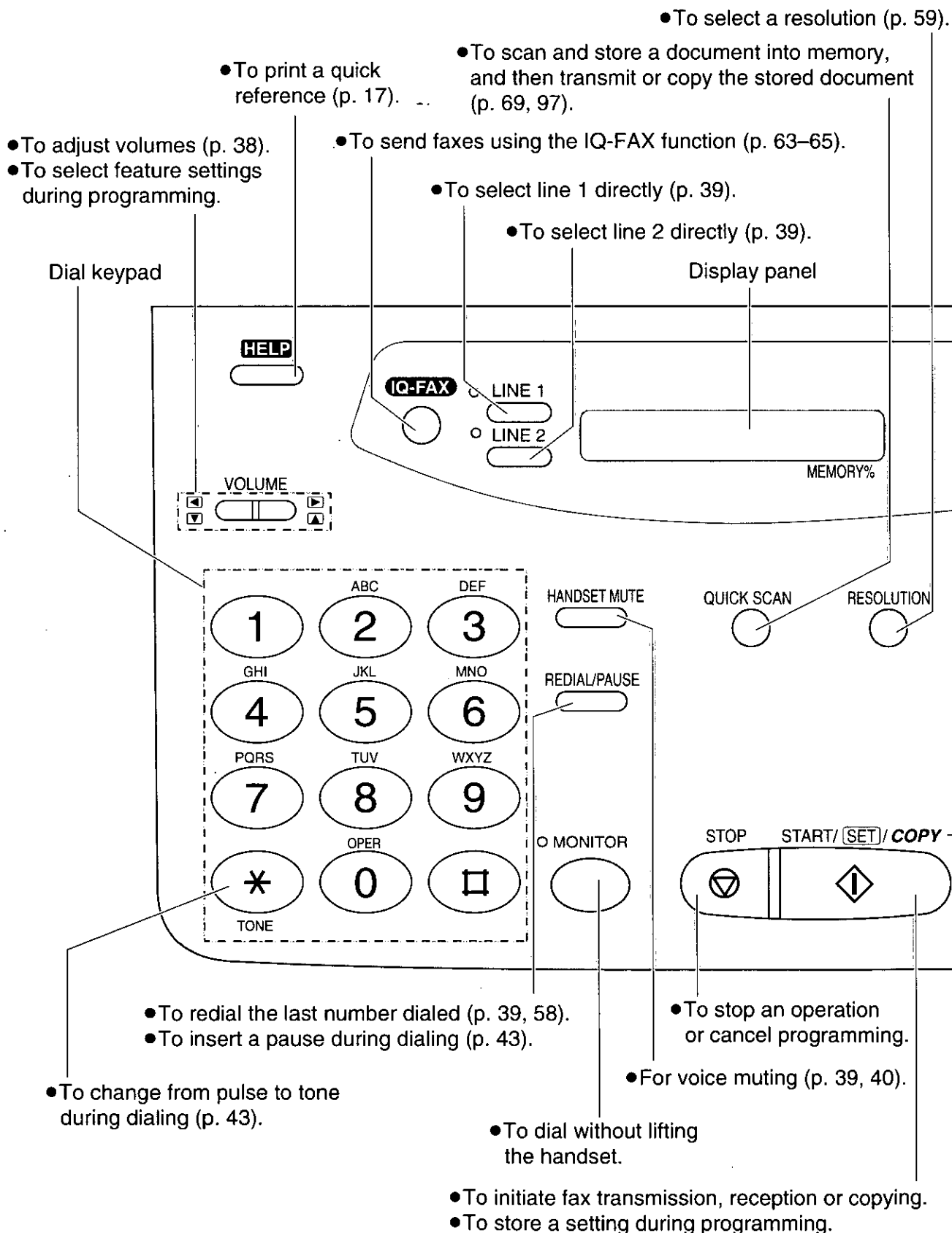

- To put a call on hold (p. 39).

- To make a conference call (p. 42).

- For the Caller ID service (p. 50–56).

- For transmission to multiple stations (p. 70–72).
- For the One-Touch Dial (p. 44, 45, 60).
- Command keys

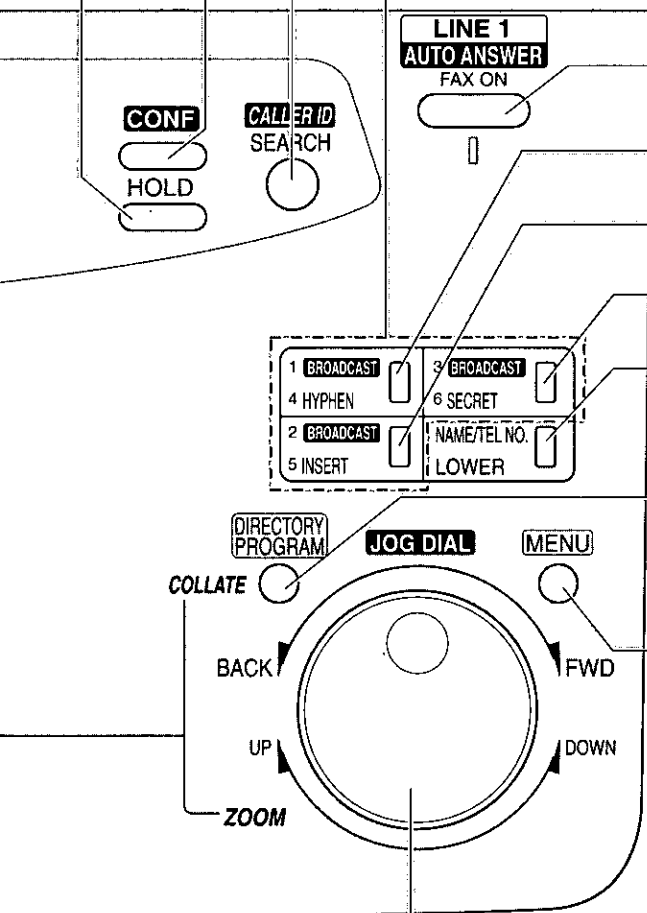

- To turn the auto answer mode for line 1 on/off (p. 74).

- To insert a hyphen (p. 31, 32).

- To insert one character or one space (p. 30, 31).

- To keep the telephone number secret (p. 44, 46).

- To confirm a stored telephone number (p. 49).

- To select stations 4–6 for the One-Touch Dial (p. 44, 45, 60).

- To store or edit names and telephone numbers (p. 44, 46–48, 70, 71).

- To choose “Collated” or “Uncollated” in the copy mode (p. 97).

- To initiate or exit programming.

- To search for a stored name (p. 46, 61).

- To select characters during programming (p. 31).

- To select the basic features during programming (p. 129).

- To select an enlargement/reduction rate in the copy mode (p. 97, 98).

Finding the Controls

Overview

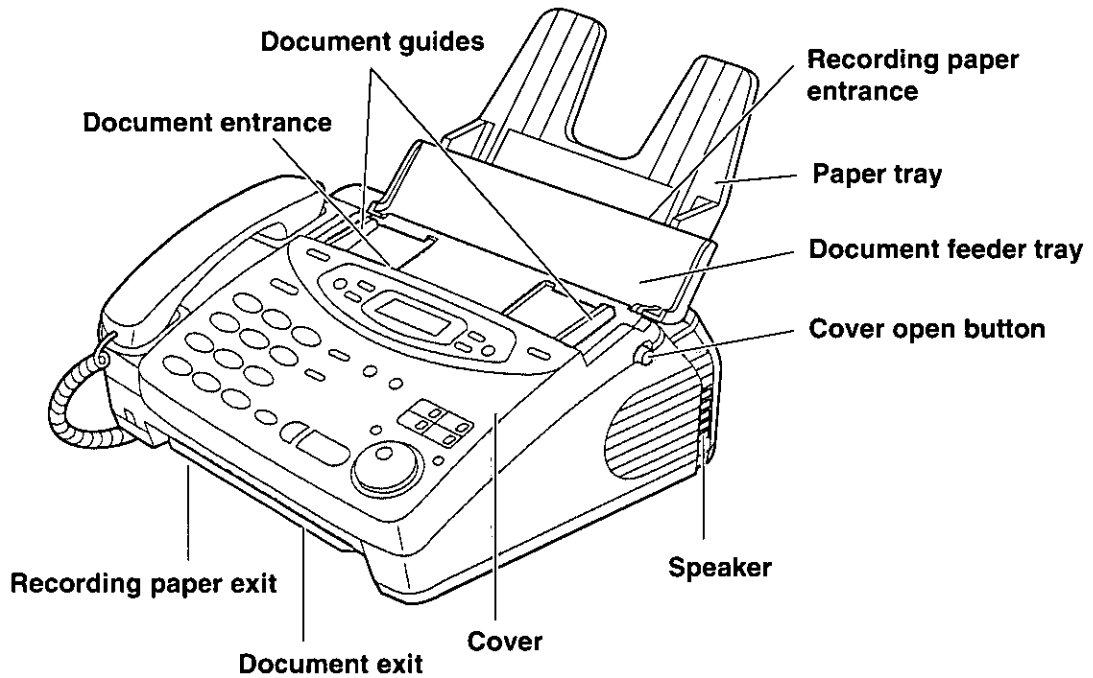

Note:

- The document and recording paper will be ejected from the front of the unit. Install the unit on a desk or floor with a smooth surface and do not place anything in front of the unit.

Before installation

- 1** Remove the shipping tape.

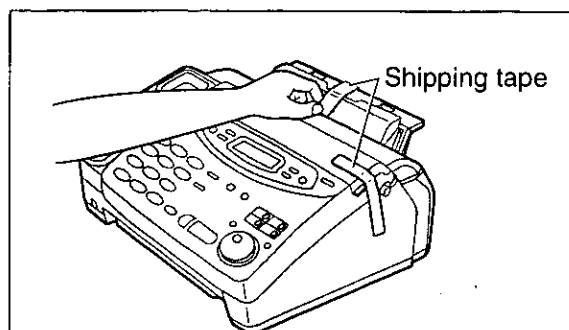

- 2** Open the cover by pressing the cover open button.

- 3** Lift the film cartridge, remove the leaflet and replace the film cartridge.

- 4** Close the cover securely by pushing down on the dotted area at both ends.

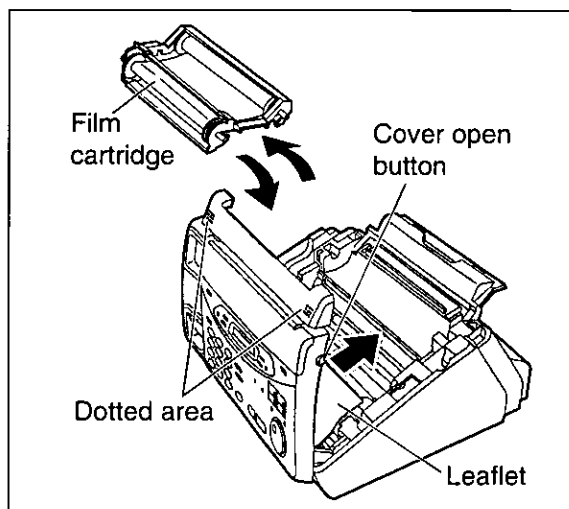

Setup

Paper tray

Insert the two tabs on the paper tray into the slots on the back of the unit.

- Do not place the unit in areas where the paper tray may be obstructed by a wall, etc.

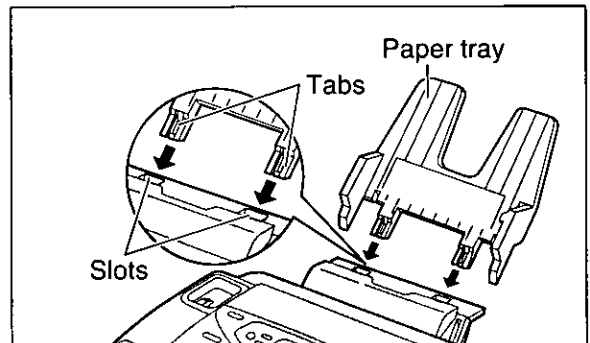

Paper stacker

- 1 Remove the shipping tape from the paper stacker.
- 2 Lift the front of the unit and hold the aluminum sheet up to prevent it being bent by the paper stacker while inserting the paper stacker into the side slots.

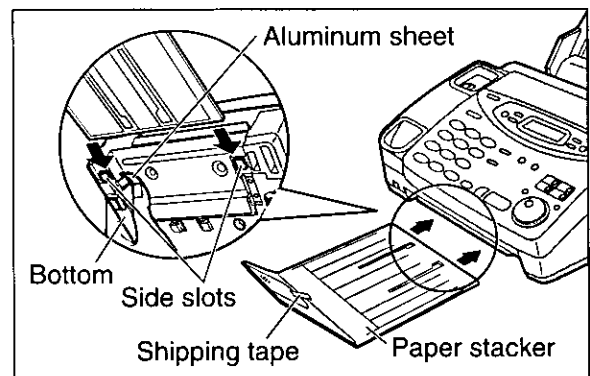

- 3 Confirm that the paper stacker is locked into the center slots and slide back.

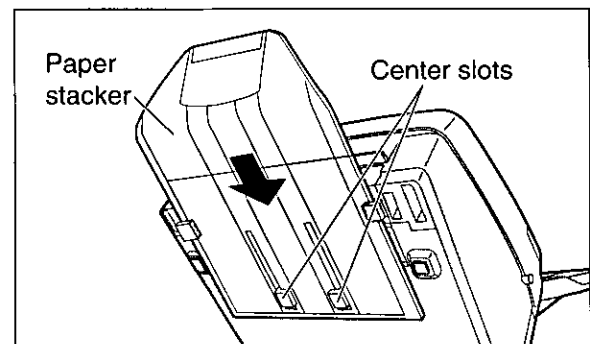

- 4 Slide the paper stacker forward until it stops.

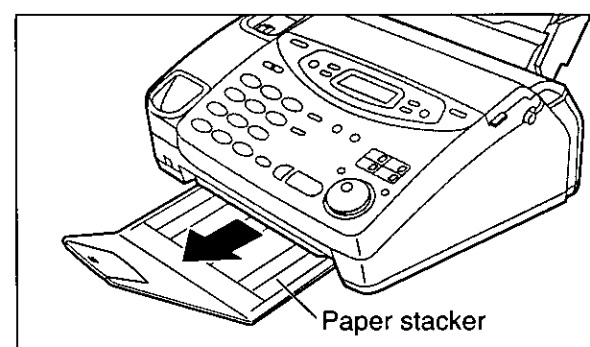

Using legal size paper

- 1 Press the dotted area on the paper stacker extender.

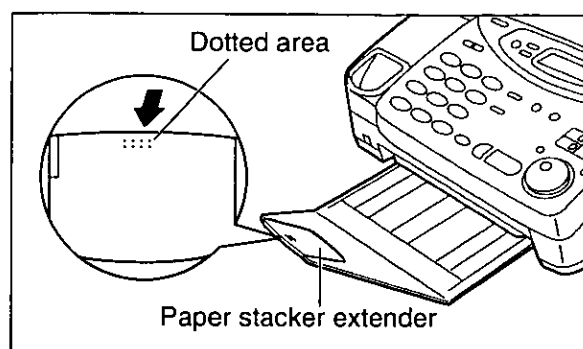

- 2 Open the paper stacker extender.

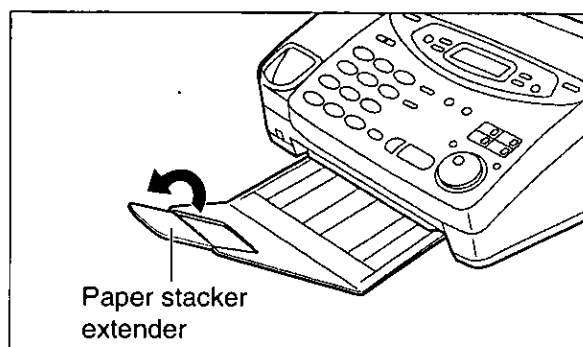

Recording paper

Letter or legal size recording paper can be loaded. The paper tray can hold up to 150 sheets of 75 g/m² (20 lb.) paper. You may use 60 g/m² to 90 g/m² (16 lb. to 24 lb.) paper.

For best results, only use inkjet paper such as Hammermill® Jet Print. If you use other types of paper, the print quality may be affected.

- 1 Fan the stack of paper to prevent a paper jam.

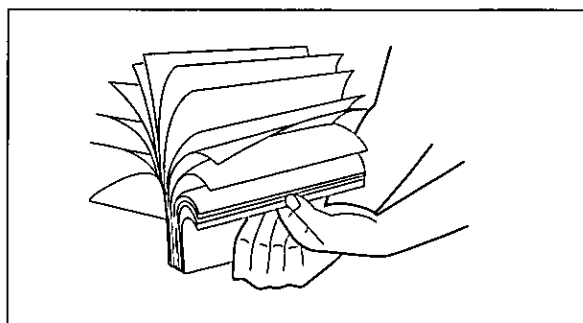

(continued)

Setup

- 2** Pull the tension bar forward and hold open while inserting the paper.
- The height of the stack of the paper should not exceed the upper limit on the paper tray, otherwise the paper may jam or multi-feed.
 - The paper should not be over the tab.
 - If the paper is not inserted correctly, readjust the paper or the paper may jam.

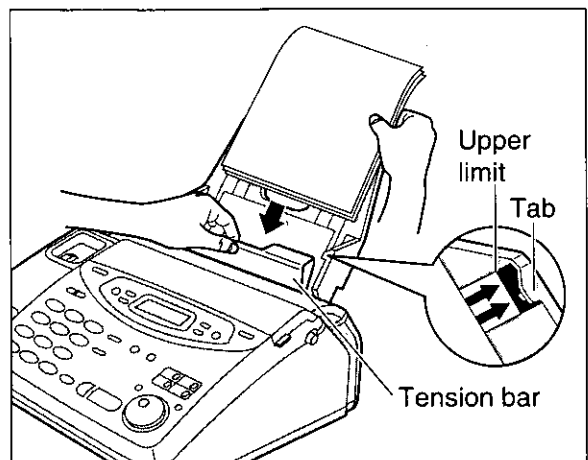
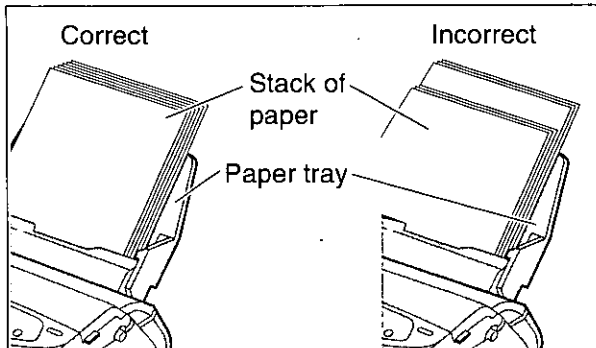

Note:

- Avoid paper with a cotton and/or fiber content that is over 20%, such as letterhead paper or paper used for resumes.
- Do not use different types or thicknesses of paper in the paper tray at the same time. This may cause a paper jam.
- Avoid extremely smooth or shiny paper that is highly textured. Also avoid paper that is coated, damaged or wrinkled.
- Avoid double-sided printing.
- Do not use paper printed from this unit for double-sided printing with other copiers or printers, or the paper may jam.
- Do not reinsert the ejected paper into the recording paper exit.
- Some paper only accepts print on one side. Try using the other side of paper when you are not happy with the print quality.

Adding paper to the paper tray

1. Pull the tension bar forward and hold open while removing all of the installed paper.
2. Add paper to the removed paper and straighten.
3. Fan the stack of paper.
4. Pull the tension bar forward and hold open while inserting the paper.

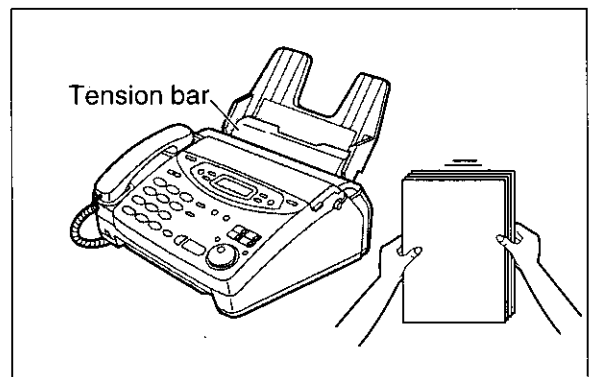

Connections

Connecting the handset cord

Connect the handset cord to the unit and connect to the handset.

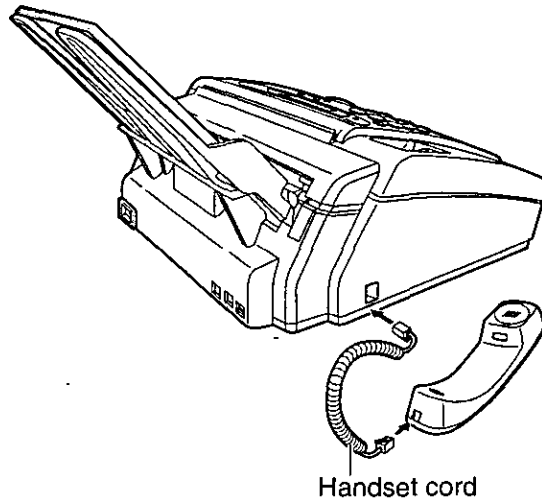

Connecting the telephone line cord(s)

- When connecting telephone line cords to the fax machine, use the included telephone line cords for reliable data communications and compliance with FCC rules.
- When connecting 4-wire telephone line cord, connect the ferrite core side to the fax machine.
- For additional equipment protection, we recommend the use of a surge protector. See note on page 27 for more information.

■ To connect a two-line telephone jack (RJ14C)

- Connect the 4-wire telephone line cord with GREEN plugs to L1/L2 jack on the unit.
- Connect to a two-line telephone jack (RJ14C).

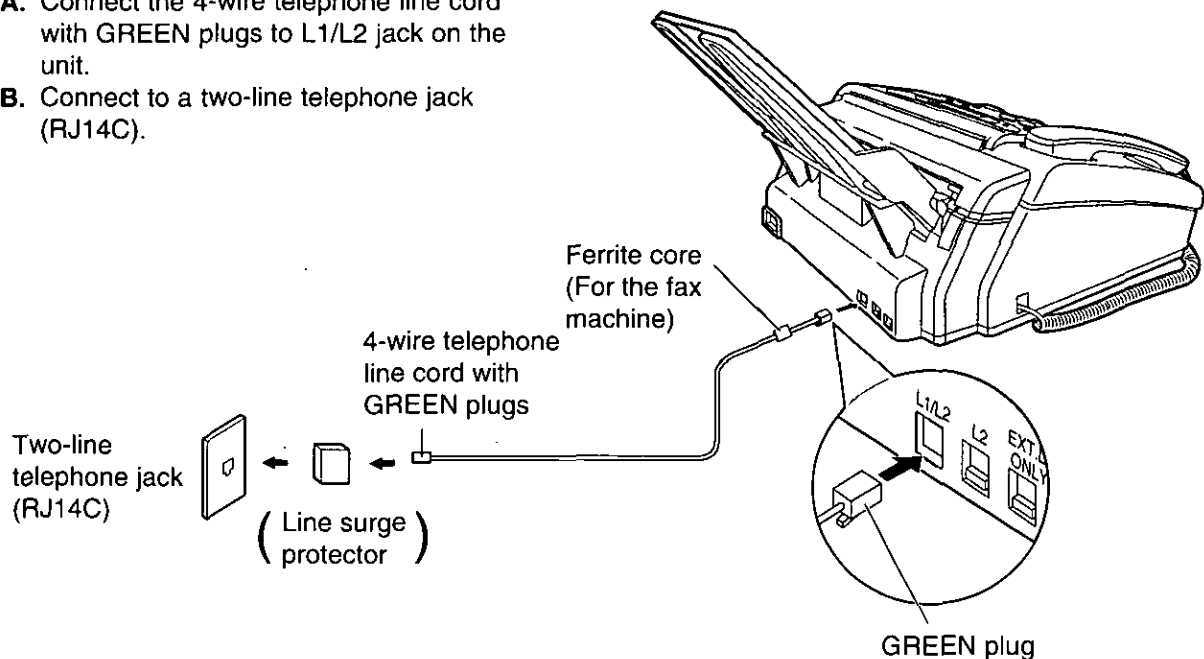

Caution:

- Do not connect another telephone line to the L2 jack. Doing so may cause damage to your unit.

Setup

■ To connect two single-line telephone jacks (RJ11C)

- A. Connect the 2-wire telephone line cord with TRANSPARENT plugs to L2 jack on the unit and connect to a single line telephone jack (RJ11C).
- B. Connect the 4-wire telephone line cord with GREEN plugs to L1/L2 jack on the unit and connect to a single line telephone jack (RJ11C).

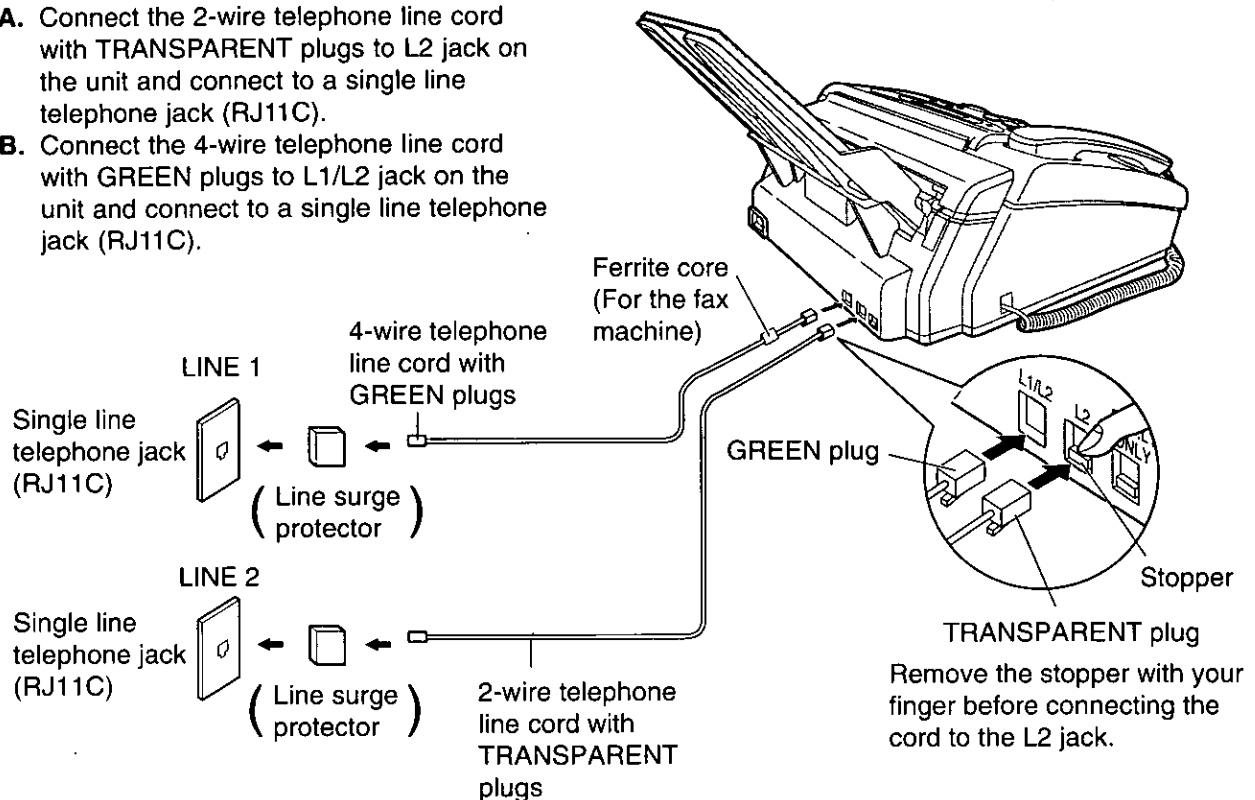

- If you connect the unit to a private branch exchange, connect as follows:
 - A. Connect the 4-wire telephone line cord to "L2" jack
 - B. Connect the 2-wire telephone line cord to "L1/L2" jack.

■ If you use the unit only as a single-line telephone/facsimile

- A. Connect the 2-wire telephone line cord with TRANSPARENT plugs to L1/L2 jack on the unit.
- B. Connect to a single line telephone jack (RJ11C).

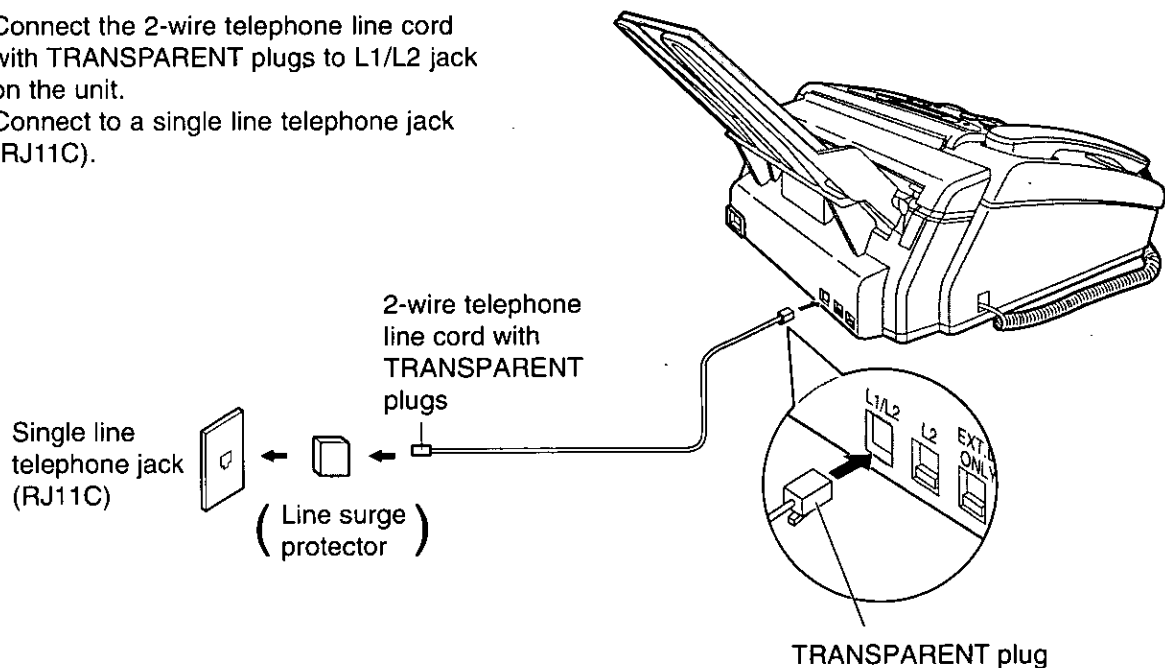

Note:

- If you use the unit as a single-line telephone/facsimile, set the line usage selection (p. 34).

Connecting the power cord

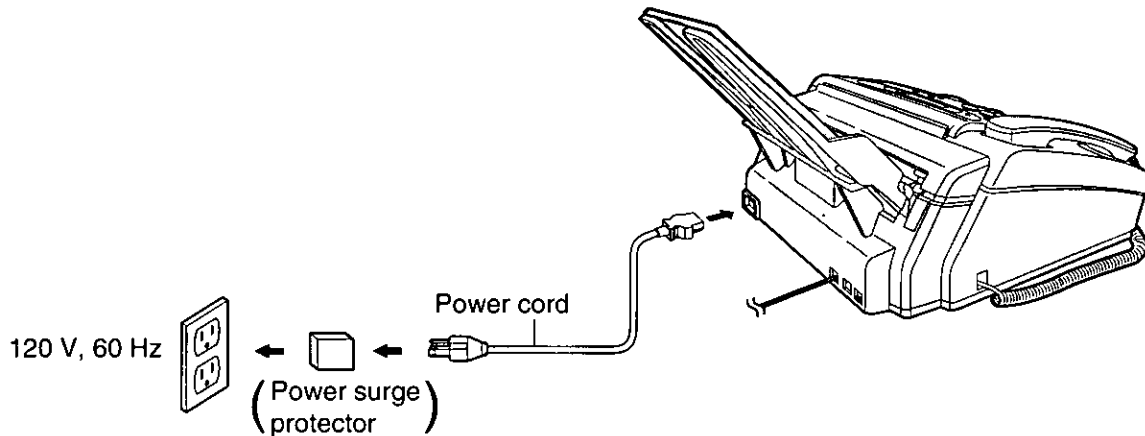

Note:

- For additional equipment protection, we recommend the use of a surge protector. The following types are available; TELESPIKE BLOK MODEL TSB (TRIPPE MFG. CO.), SPIKE BLOK MODEL SK6-0 (TRIPPE MFG. CO.), SUPER MAX (PANAMAX) or MP1 (ITW LINX).
- The warranty does not cover damage due to power line surges or lightning.
- When you operate this product, the power outlet should be near the product and easily accessible.
- If you want to connect an answering machine to the unit, see page 82.

Automatic dialing mode setting

- When the telephone line cord(s) and the power cord are connected, the unit will automatically start to detect the dialing mode of your telephone line.

Display: CHECKING LINE

Wait until one of the following messages is displayed.

LINE IS TONE

Your line has touch tone service.

LINE IS PULSE

Your line has rotary pulse dial service.

- If the power cord is disconnected or a power failure occurs, the unit will detect the dialing mode again when power is restored.
- If you connect the power cord before connecting the telephone line cord(s), the following messages will be shown alternately.

NO TEL LINE

INSERT TEL LINE

Connect the telephone line cord(s).

Checking the telephone number applied to each line

When the unit is connected to 2-line telephone jack or two single line telephone jacks, follow these steps to check the telephone number for each line.

- 1** Press **LINE 1**.
 - The line indicator lights green.
- 2** Lift the handset.
- 3** Dial one of the telephone numbers.
- 4** If a **busy tone is heard**, the telephone number dialed is applied to **LINE 1**.

If the unit rings and the **LINE 2 indicator flashes red**, the telephone number dialed is applied to **LINE 2**.
- 5** Replace the handset.

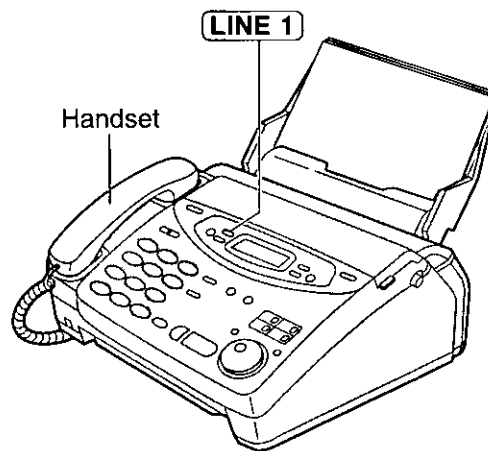

Note:

- There is a difference on their features between line 1 and line 2 (see "Different line features" on page 16). If the dialed telephone number is not applied to the desired line, change the setting of the line as shown below.

To switch telephone numbers between line 1 and line 2

- **When the unit is connected to 2-line telephone jack (RJ14C) as shown on page 25:**
Change the setting of the LINE CHANGE feature (p. 37).
- **When the unit is connected to two single line telephone jacks (RJ11C) as shown on page 26:**
Change the connections of two telephone lines each other at the wall jacks.

Explanation of line indicators

Line indicator	Line condition
Off	The line is free.
Flashing quickly (Red)	An incoming call is being received.
On (Green)	The line is selected.
On (Red)	When the facsimile is in use or when an extension telephone/external telephone answering machine is in use.
Flashing (Green)	The call is on hold.

Date and time, your logo and facsimile telephone number

You should program the date and time, your logo and facsimile telephone number. This information will be printed on each page transmitted from your unit, fulfilling the requirements of the Telephone Protection Act of 1991.

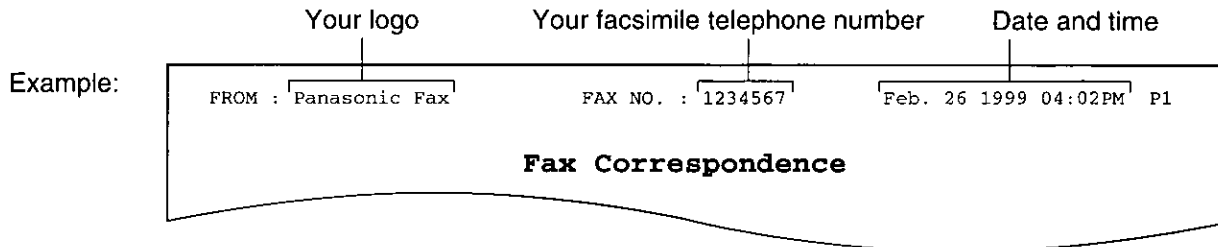

Setting the date and time

1 Press **[MENU]**.

Display: 1.SYSTEM SET UP

2 Press **[#]**, then **[0]** **[1]**.

SET DATE & TIME

3 Press **[START/SET/COPY]**.

M:01/D:01/Y:99

Cursor

4 Enter the correct month/day/year by selecting each 2 digits using the dial keypad.

Example: Aug. 10, 1999

Press **[0]** **[8]** **[1]** **[0]** **[9]** **[9]**.

M:08/D:10/Y:99

5 Press **[START/SET/COPY]**.

TIME: 12:00AM

6 Enter the correct hour/minute by selecting each 2 digits using the dial keypad. Press **[*]** to select "AM" or "PM".

Example: 3:15PM

1. Press **[0]** **[3]** **[1]** **[5]**.

TIME: 03:15AM

2. Press **[*]** until "PM" is displayed.

TIME: 03:15PM

7 Press **[START/SET/COPY]**.

SETUP ITEM []

8 Press **[MENU]**.

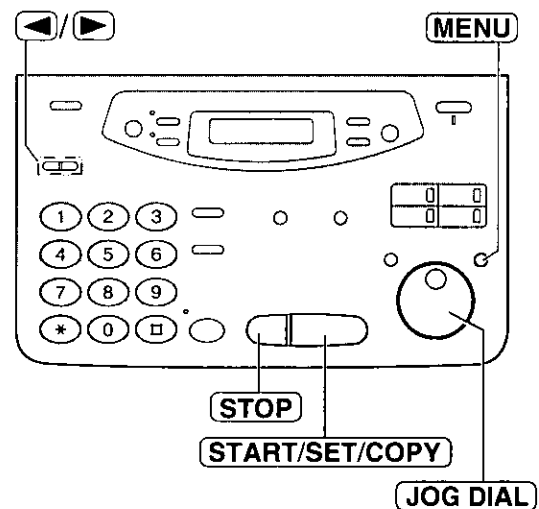

Note:

- You can enter the number by rotating **[JOG DIAL]** in steps 4 and 6. In this case, press **[▶]** to move the cursor.
- The accuracy of the clock is approximately ±60 seconds a month.

To correct a mistake

- Press **[◀]** or **[▶]** to move the cursor to the incorrect number, then make the correction.
- If you press **[STOP]** while programming, the display will return to the previous one.

Setup

Setting your logo

The logo can be your company, division or name.

- 1 Press **MENU**.
Display: 1. SYSTEM SET UP
- 2 Press **#**, then **0** **2**.
YOUR LOGO
- 3 Press **START/SET/COPY**.
LOGO=
- 4 Enter your logo, up to 30 characters, by using the dial keypad. See next page for details.
Example: Bill
 1. Press **2** twice.
LOGO=B
Cursor
 2. Press **4** six times.
LOGO=Bi
 3. Press **5** six times.
LOGO=Bi
 4. Press **▶** to move the cursor to the next space and press **5** six times.
LOGO=Bill
- 5 Press **START/SET/COPY**.
SETUP ITEM []
- 6 Press **MENU**.

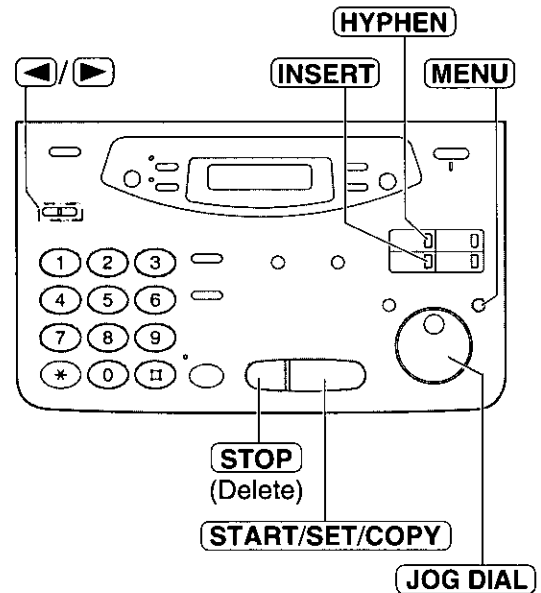

Note:

- You can enter your logo by rotating **JOG DIAL** (see next page).

To correct a mistake

- Press **◀** or **▶** to move the cursor to the incorrect character, then make the correction.

To delete a character





- Move the cursor to the character you want to delete and press **STOP**.

To insert a character

1. Press **◀** or **▶** to move the cursor to the position to the right of where you want to insert the character.
2. Press **INSERT** (One-Touch Dial key 2) to insert a space and enter the character.

To select characters with the dial keypad

Pressing the dial keys will select a character as shown below.

Keys	Characters
①	1 [] { } + - / = , . _ ` : ; ?
②	A B C a b c 2
③	D E F d e f 3
④	G H I g h i 4
⑤	J K L j k l 5
⑥	M N O m n o 6
⑦	P Q R S p q r s 7
⑧	T U V t u v 8
⑨	W X Y Z w x y z 9
⑩	0 () < > ! " # \$ % & ¥ * @ ^ ' →
	HYPHEN key (To insert a hyphen.)
	INSERT key (To insert one character or one space.)
STOP	Delete key (To delete a character.)
	◀ key (To move the cursor to the left.)
	▶ key (To move the cursor to the right.) To enter another character using the same number key, move the cursor to the next space.

To select characters using the JOG DIAL

Instead of pressing the dial keys, you can select characters using the JOG DIAL.

1. Rotate **JOG DIAL** until the desired character is displayed.
2. Press  to move the cursor to the next space.
 - The character displayed in step 1 is inserted.
3. Return to step 1 to enter the next character.

Display order of characters

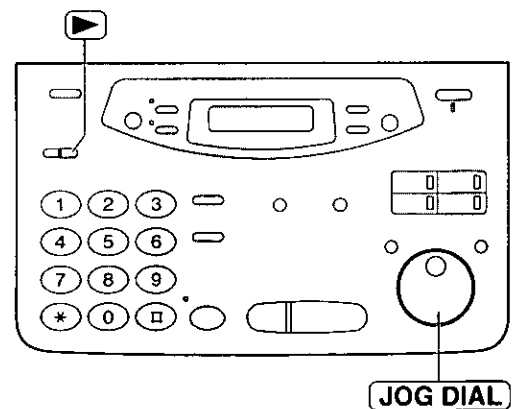
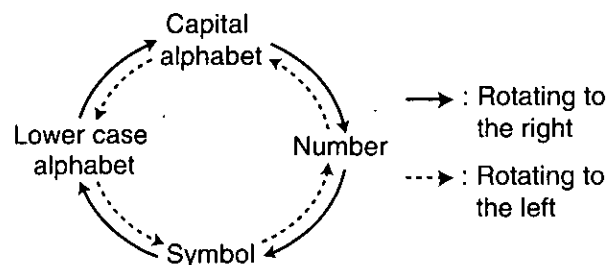

Setup

Setting your facsimile telephone numbers

- 1** Press **MENU**.
Display: 1. SYSTEM SET UP
- 2** Press **#**, then **0** **3**.
YOUR FAX NO.
- 3** Press **START/SET/COPY**.
LINE1=
- 4** Enter your facsimile telephone number connected to line 1 up to 20 digits using the dial keypad.
Example: LINE1=1234567
- 5** Press **START/SET/COPY**.
LINE2=
- 6** Enter your facsimile telephone number connected to line 2 up to 20 digits using the dial keypad.
Example: LINE2=7654321
- 7** Press **START/SET/COPY**.
SETUP ITEM []
- 8** Press **MENU**.

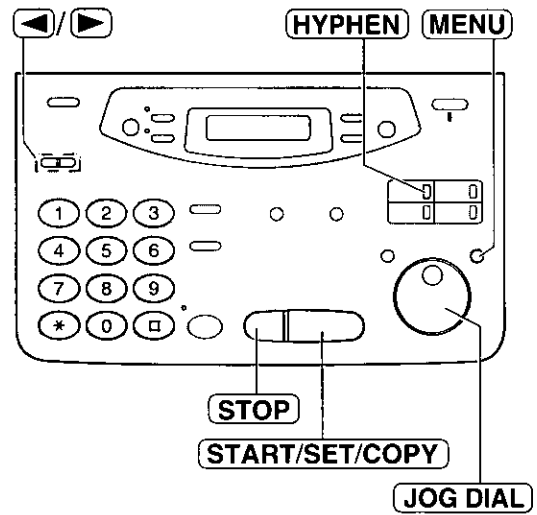

Note:

- You can enter your facsimile telephone number by rotating **JOG DIAL**. If using **JOG DIAL**, press **▶** to move the cursor.
- The ***** button replaces the digit with a "+" and the **#** button replaces it with a space.
Example (using the dial keypad): +234 5678
Press ***234#5678**.
- To enter a hyphen in a telephone number, press **HYPHEN** (One-Touch Dial key 1).

To correct a mistake

- Press **◀** or **▶** to move the cursor to the incorrect number, then make the correction.

To delete a number

- Move the cursor to the number you want to delete and press **STOP**.

Dialing mode (touch tone or pulse)

When the unit is turned on, it will automatically set the dialing mode if this feature is set to "AUTO".
If you cannot dial, change the dialing mode setting to "TONE" or "PULSE" by following the instructions below.

- 1 Press **MENU**.
Display: 1. SYSTEM SET UP
- 2 Press **#**, then **1** **3**.
DIALING MODE
- 3 Press **START/SET/COPY**.
MODE=AUTO ▼▲
- 4 Press ▼ or ▲ to select the desired setting.
- 5 Press **START/SET/COPY**.
SETUP ITEM []
- 6 Press **MENU**.

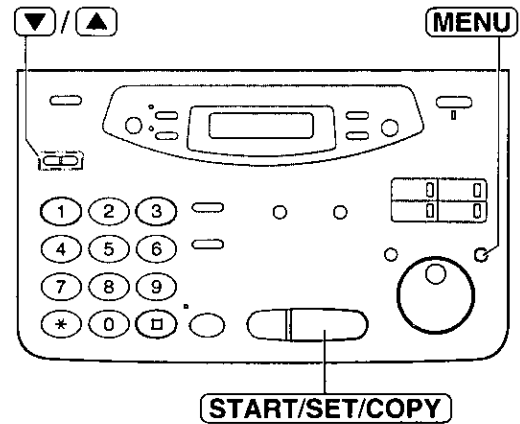

Setup

Line usage selection

The unit can be connected two telephone lines. If only one line is connected, the following programming is necessary.

- 1 Press **MENU**.
Display: 1.SYSTEM SET UP
- 2 Press **#**, then **2** **7**.
C.O.L SELECTION
- 3 Press **START/SET/COPY**.
LINE1=ON ▼▲
- 4 If line 1 is not connected:
Press ▼ or ▲ to select "OFF".
If line 1 is connected:
Press ▼ or ▲ to select "ON".
- 5 Press **START/SET/COPY**.
LINE2=ON ▼▲
- 6 If line 2 is not connected:
Press ▼ or ▲ to select "OFF".
If line 2 is connected:
Press ▼ or ▲ to select "ON".
- 7 Press **START/SET/COPY**.
SETUP ITEM []
- 8 Press **MENU**.

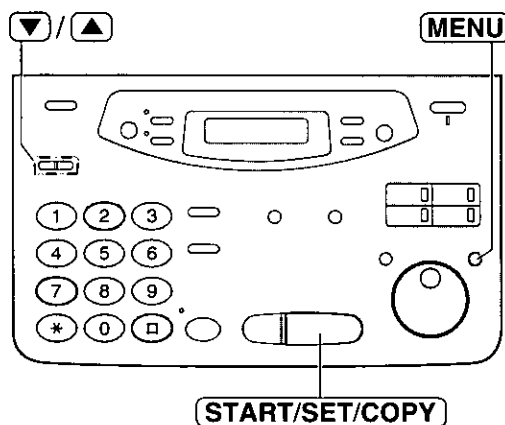

Line mode

If either line 1 or 2, or both lines are connected to a host exchange (PBX - Private Branch Exchange), change the line mode setting from "CO-Central Office" to "PBX".

- 1 Press **MENU**.
Display: 1.SYSTEM SET UP
- 2 Press **#**, then **2** **9**.
LINE MODE
- 3 Press **START/SET/COPY**.
LINE1=CO ▼▲
- 4 When line 1 is connected to a host exchange, press ▼ or ▲ to select "PBX".
LINE1=PBX ▼▲
- 5 Press **START/SET/COPY**.
LINE2=CO ▼▲
- 6 When line 2 is connected to a host exchange, press ▼ or ▲ to select "PBX".
LINE2=PBX ▼▲
- 7 Press **START/SET/COPY**.
SETUP ITEM []
- 8 Press **MENU**.

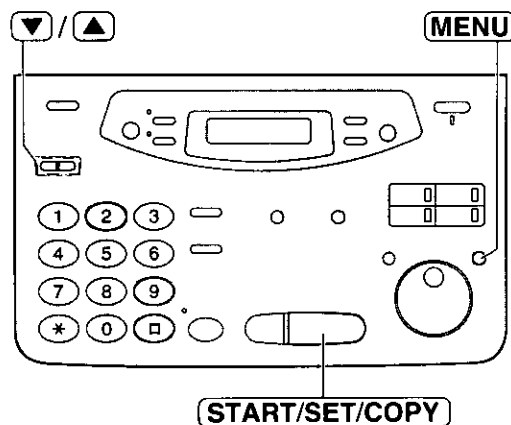

Setup

Line ringer mode

The unit can be programmed not to ring for the second call received during a telephone conversation. If this feature is set to off, the unit will let you know an incoming call only by a red flashing of the line indicator. To set this feature off, proceed as follows.

- 1 Press **MENU**.
Display: 1.SYSTEM SET UP
- 2 Press **#**, then **3 2**.
LINE RINGER MODE
- 3 Press **START/SET/COPY**.
MODE=ON ▼▲
- 4 Press ▼ or ▲ to select "OFF".
MODE=OFF ▼▲
- 5 Press **START/SET/COPY**.
SETUP ITEM []
- 6 Press **MENU**.

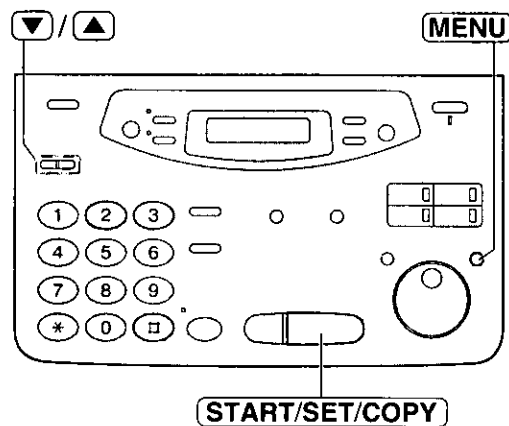

Switching telephone numbers between line 1 and line 2

When you connect the unit to 2-line telephone jack (RJ14C) and want to switch telephone numbers between line 1 and line 2, follow these steps.



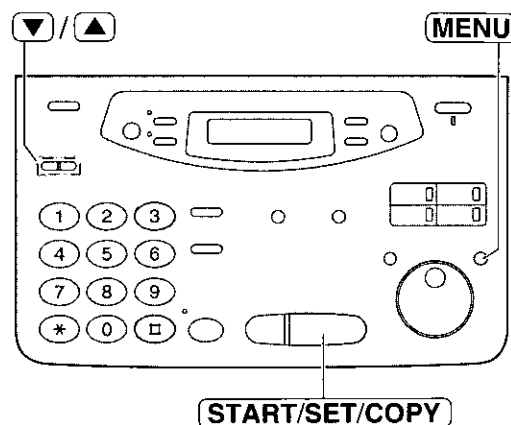

- 1 Press **MENU**.
Display: 1.SYSTEM SET UP
- 2 Press **#**, then **3 3**.
LINE CHANGE
- 3 Press **START/SET/COPY**.
MODE=STANDARD ▼▲
- 4 Press ▼ or ▲ to select "SWITCH".
MODE=SWITCH ▼▲
- 5 Press **START/SET/COPY**.
SETUP ITEM []
- 6 Press **MENU**.



Adjusting volumes

Ringer volume

4 levels (high/middle/low/off) are available for each line.

1. While the unit is idle, press  or .
•The line 1 and 2 indicators will flash.
2. For LINE 1, press **LINE 1**.
For LINE 2, press **LINE 2**.
3. Press  or  to adjust the volume.

■ To turn the ringer off:

Press  repeatedly until the following message is displayed.

Example: Line 1 is selected.

Display: RINGER1 OFF=OK?
↑
YES: PRESS SET

Press **START/SET/COPY**.

•To turn the ringer back on, press .

■ While the ringer volume is set to off:

The display will show the following message.

Example: L1:RINGER OFF

When a call is received, the unit will not ring and will display the following.

INCOMING CALL

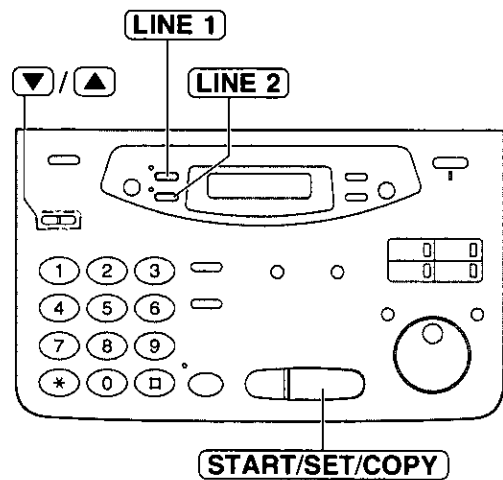

Handset receiver volume

5 levels (high to low) are available.

While using the handset, press  or .

Monitor volume

8 levels (high to low) are available.

While using the monitor, press  or .

Voice calls - making

When you lift the handset or press **MONITOR**, a free line will be selected automatically.

- 1 Press **MONITOR** or lift the handset.

Display:

- A free line is selected automatically and the line indicator lights green.

- 2 Dial the telephone number.

Example:

- If you misdial, hang up and dial again.

- 3 When the other party answers, speak with the handset.

- 4 When finished talking, replace the handset.

Note:

- Line 1 will be selected if it is free, but if it is engaged, line 2 will be selected.
- You may select line by directly pressing **LINE 1** or **LINE 2**.

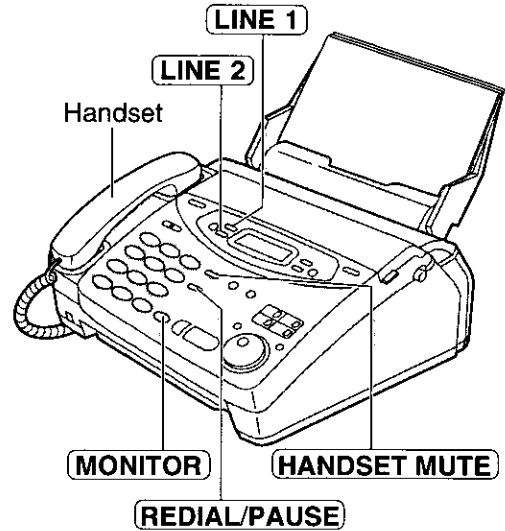

To redial the last number

1. Press **MONITOR** or lift the handset.
2. Press **REDIAL/PAUSE**.
3. When the other party answers, speak with the handset.

To put a call on hold

Press **HOLD**.

- The line indicator flashes green.
- You may place the handset on the cradle.

To release the hold

Press the LINE button being on hold and lift the handset.

- If an extension phone is connected on the same line, you can also release the hold by lifting its handset.

To mute your voice to the other party

1. Press **HANDSET MUTE** during a telephone conversation using the handset.

Display:

- The other party cannot hear you, but you can hear them.
2. To resume the conversation, press **HANDSET MUTE** again.

Making and Answering Calls

Voice calls - answering

While a call is being received, the unit rings and the called line indicator flashes red.

- 1 When the unit rings, lift the handset.
 - The calling line is selected automatically and the line indicator lights green.
- 2 When finished talking, replace the handset.

Note:

- When the ringer volume of the called line is set to off, the unit will not ring.

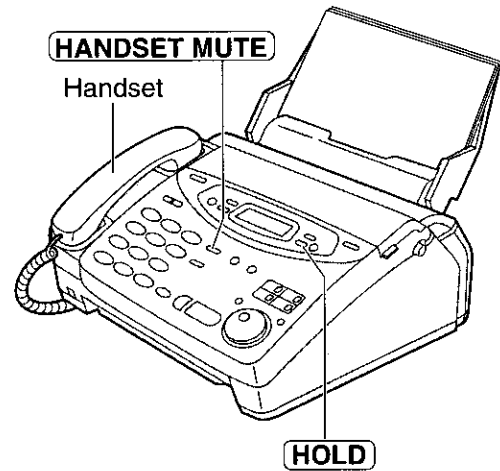

To mute your voice to the other party

1. Press **HANDSET MUTE** during a telephone conversation using the handset.

Display: <MUTE>

- The other party cannot hear you, but you can hear them.
2. To resume the conversation, press **HANDSET MUTE** again.

To transfer a call to an extension phone

1. Press **HOLD** during a conversation and then replace the handset.
 - The line indicator changes from steady to flashing green light.
2. Lift the handset of the extension phone to continue the conversation.
 - The line indicator changes from flashing to a steady red light.

Using the other line during a conversation

During a conversation, if the other line indicator flashes red, an incoming call is being received. You can answer the second call while holding the first call. You can also make a call without terminating the first call.

Example: If you are using LINE 1

1 Press **HOLD** to put the first call (line 1) on hold.

Display:

- The LINE 1 indicator flashes green.

2 Press the other line button (**LINE 2**) to make or answer a second call.

- The LINE 2 indicator lights green.

3 To return to the first call (line 1), press the line button for the first call (**LINE 1**).

- The LINE 1 indicator lights green, then the second call is terminated.

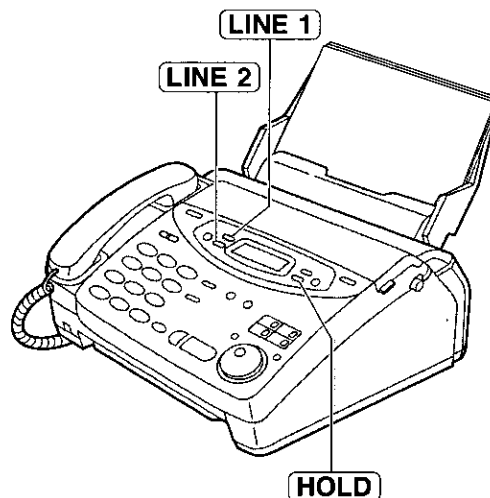

Note:

- To hold the second call in step 3, press **HOLD** before pressing the line button for the first call.

Using the other line during fax communication

While sending or receiving fax messages on one line, you can place or answer a voice call on the other line.

Example: If you are using LINE 1 for fax communication

Press the other line button (**LINE 2**) to make or answer the second call.

- The LINE 2 indicator lights green.

Note:

- You cannot send or receive faxes while using the other line for fax communication.

Making and Answering Calls

Making a conference call

While having a conversation on one line, you can make or answer a second call on the other line and then combine both calls together to make a conference call.

Example: If you are using LINE 1

1 Press **HOLD** to put the first call (line 1) on hold.

Display: ON HOLD

- The LINE 1 indicator flashes green.

2 Press the other line button (**LINE 2**) to make or answer a second call.

- The LINE 2 indicator lights green.

3 When the second call is connected, press **CONF** to make a conference call.

CONFERENCE CALL

- Both line indicators light green.

4 To hang up both line, replace the handset.

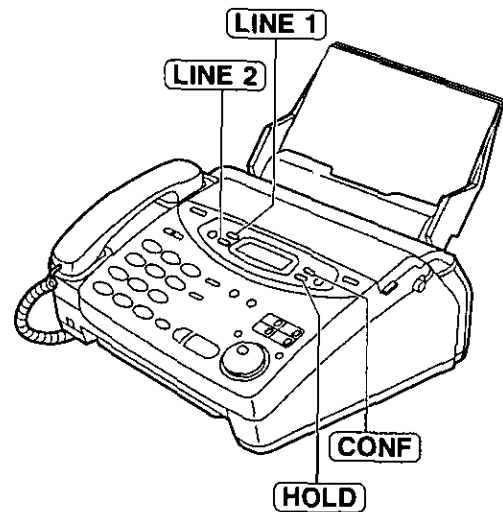

TONE and PAUSE buttons

TONE button

The **TONE** (*) button is used for rotary pulse dial services and allows you to temporarily change from pulse to tone mode during a dialing operation. When you hang up, the unit will automatically return to pulse mode.

Entering pauses

When the **REDIAL/PAUSE** button is pressed during dialing, a pause will be inserted. Pressing **REDIAL/PAUSE** once creates a 5 second pause.

Example 1:

If your unit is connected to a host exchange, insert a pause to get an outside line.

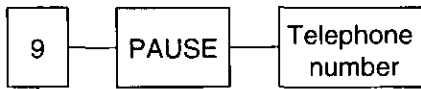

Line access code

Example 2:

If a transmission error occurs during an overseas transmission, add two pauses at the end of the telephone number.

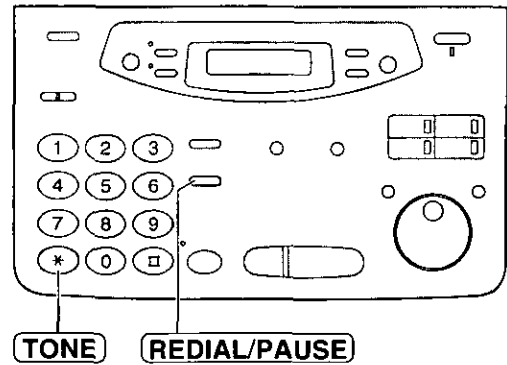
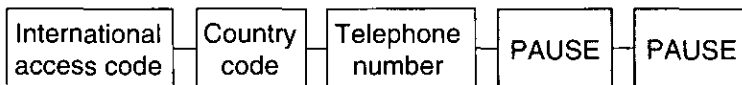

Telephone

Note:

- TONE and PAUSE can be stored into a telephone number in the One-Touch Dial and the JOG DIAL directory.

One-Touch Dial

Storing names and telephone numbers in the One-Touch Dial

The unit's memory allows you to use the One-Touch Dial for rapid access to your most frequently dialed numbers. 6 stations are available.

- One-Touch Dial keys 1, 2 or 3 can be used as One-Touch Dial keys (DIAL MODE) or as broadcast keys (BROADCAST). These functions cannot be used at the same time. For the broadcast function, see pages 70 to 72.

1 Press **DIRECTORY PROGRAM**.

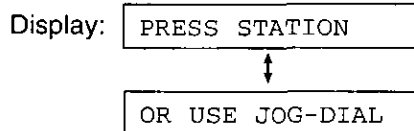

2 For stations 1-3
Press one of the One-Touch Dial keys.

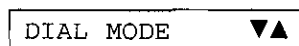

Press **START/SET/COPY** to go to the next prompt.

For stations 4-6

Press **LOWER**, then press one of the One-Touch Dial keys.

3 Enter the station name, up to 10 characters, by following the instructions on page 31.

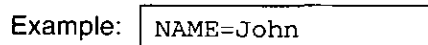

4 Press **START/SET/COPY**.

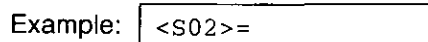

5 Enter the telephone number up to 30 digits.
• To enter a hyphen in a telephone number, press **HYPHEN** (One-Touch Dial key 1).

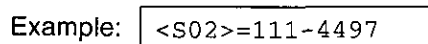

6 Press **START/SET/COPY**.

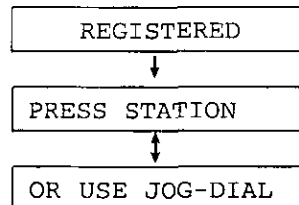

- To program other stations, repeat steps 2 to 6.

7 Press **DIRECTORY PROGRAM** to exit the program.

Note:

- If "DIAL MODE" is not displayed when you select stations 1, 2 or 3 in step 2, the broadcast function has been set. To use the station as a One-Touch Dial key, press ▼ to select "DIAL MODE". The broadcast function will be canceled.
- A hyphen entered in a telephone number counts as two digits.

44

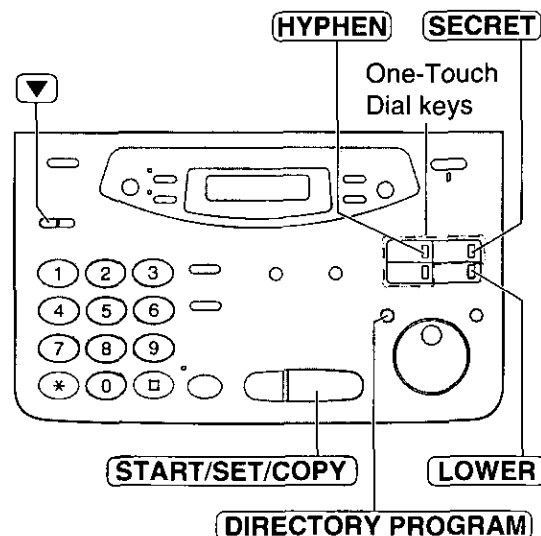

Helpful hint:

- You can confirm the stored items on the display (p. 49) or on the telephone number list (p. 112).

To keep the telephone number secret

Press **SECRET** (One-Touch Dial key 3) after entering the telephone number in step 5.

- A secret number can not be viewed after this is set.
- The telephone number will not appear on the telephone number list.
- Pressing **SECRET** does not count as a digit.

To edit a stored station name and number

Enter the desired name in step 3.

Enter the desired number in step 5.

To erase a stored station name and number, see page 48.

Making a voice call using the One-Touch Dial

Before using this feature, program the desired names and telephone numbers into the One-Touch Dial (p. 44).

- 1** Press **MONITOR** or lift the handset.

Display:

- A free line is selected automatically.
- Check that there are no documents in the document feeder tray.

- 2** For stations 1–3
Press the desired One-Touch Dial key.

For stations 4–6
Press **LOWER**, then press the desired One-Touch Dial key.

Example:

- 3** When the other party answers, speak with the handset.

- 4** When finished talking, replace the handset.

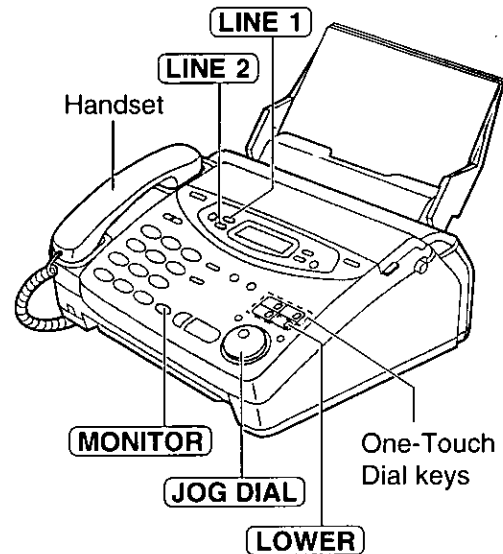

Helpful hints:

- You may select the line by pressing **LINE 1** or **LINE 2**.
- You can confirm the stored items on the display (p. 49) or on the telephone number list (p. 112).
- You can use the JOG DIAL directory to select the station name instead of using the One-Touch Dial keys. Rotate **JOG DIAL** until the desired name is displayed, then press **MONITOR** or lift the handset.

Storing names and telephone numbers in the JOG DIAL directory

For rapid access to frequently dialed numbers, the unit also provides a JOG DIAL directory (100 stations) in addition to the One-Touch Dial. For your convenience, the following 2 stations have been pre-programmed in the JOG DIAL directory.

HELP-FAX (1-800-435-7329): If you cannot correct a problem after trying the help function (p. 17), call using this station (p. 49).

IQ-FAX-CS (IQ-FAX Customer Service Center) (1-888-332-9728): If you have a problem with IQ-FAX, call using this station (p. 49).

If you do not need the above stations, you can edit or erase them (p. 47, 48).

1 Press **DIRECTORY PROGRAM**.

Display:

↓

2 Rotate **JOG DIAL** until the following is displayed.

3 Enter the name, up to 10 characters, by following the instructions on page 31.

Example:

4 Press **START/SET/COPY**.

5 Enter the telephone number up to 30 digits using the dial keypad.

Example:

- If you want to enter a hyphen, press **HYPHEN**.

6 Press **START/SET/COPY**.

↓

- To program other items, repeat steps 3 to 6.

7 Press **DIRECTORY PROGRAM** to exit the program.

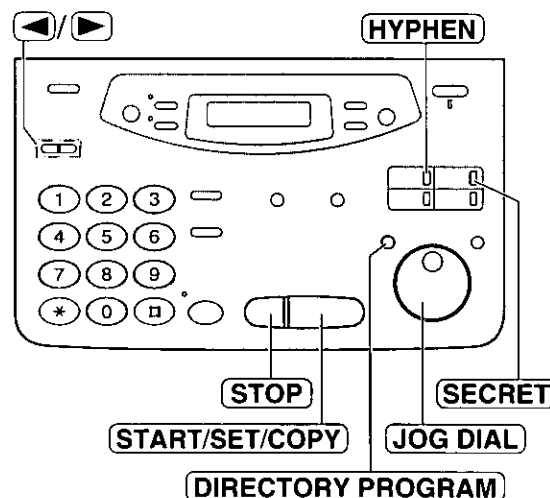

Helpful hint:

- You can confirm the stored items on the display (p. 49) or on the telephone number list (p. 112).

Note:

- You can store items during a telephone conversation.
- When the following message is displayed in step 6, you can only store 5 items.

Display:

- If the unit shows "JOG-DIAL FULL" in step 1, there is no space to store new stations. Erase unnecessary stations (p. 48).
- A hyphen or a space entered in a telephone number is counted as two digits.

To correct a mistake

- Press **◀** or **▶** to move the cursor to the incorrect character, then make the correction.

To delete a character or number

- Move the cursor to the character or number you want to delete and press **STOP**.

To keep the telephone number secret

Press **SECRET** (One-Touch Dial key 3) after entering the telephone number in step 5.

- A secret number can not be viewed after this is set.
- The telephone number will not appear on the telephone number list.
- Pressing **SECRET** does not count as a digit.

Editing a stored name and number

- 1** Rotate **JOG DIAL** until the desired name is displayed.

Example:

- 2** Press **DIRECTORY PROGRAM**.

- 3** Press ***** to select "EDIT".

- If you do not need to edit the name, skip to step 5.

- 4** Edit the name by following the instructions on page 31.

- 5** Press **START/SET/COPY**.

Example:

- If you do not need to edit the telephone number, skip to step 7.

- 6** Edit the telephone number. For further details, see page 46.

- 7** Press **START/SET/COPY**.

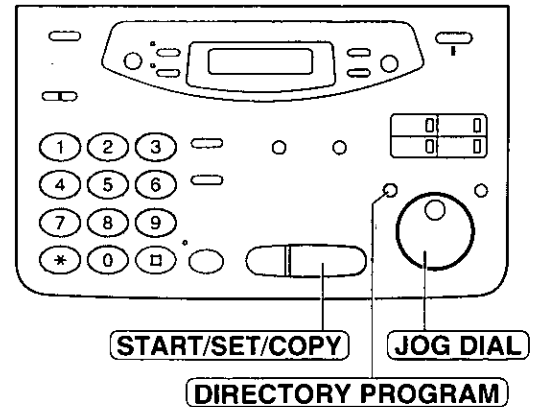

Telephone

JOG DIAL

Erasing a stored name and number

You can also erase a name and number stored in the One-Touch Dial by following the instructions below.

- 1 Rotate **JOG DIAL** until the desired name is displayed.

Example:

- 2 Press **DIRECTORY PROGRAM**.

- 3 Press **#** to select "DELETE".



- If you do not want to erase the item, press **STOP**.

- 4 Press **START/SET/COPY**.

- The stored name and number are deleted.

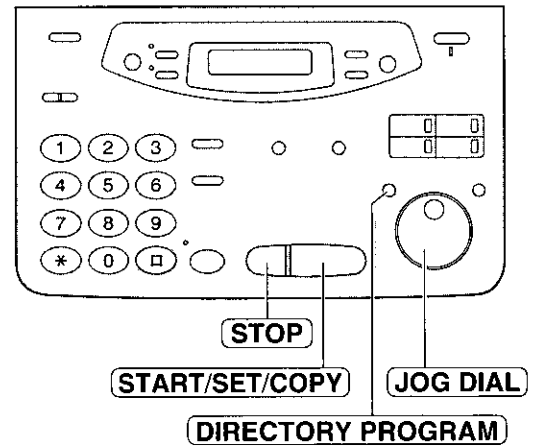

Making a voice call using the JOG DIAL directory

Before using this feature, program the desired names and telephone numbers into the directory (p. 46).

- 1 Rotate **JOG DIAL** until the desired name is displayed.

Example:

- 2 Press **MONITOR** or lift the handset.

- A free line is selected and the unit will start dialing automatically.

- 3 When the other party answers, speak with the handset.

- 4 When finished talking, replace the handset.

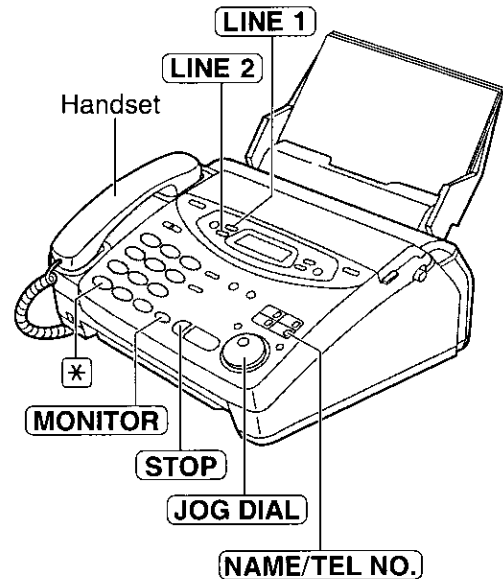

Note:

- You may select the line by pressing **LINE 1** or **LINE 2**.
- If the desired name has not been stored, press **STOP** and dial the number manually.

Helpful hint:

- You can confirm the stored items on the display (see below) or on the telephone number list (p. 112).

To confirm the stored items on the display

1. Rotate **JOG DIAL** until the desired name is displayed.

Example:

2. Press **NAME/TEL NO.**.

- To stop the operation, press **STOP**.
3. Press **MONITOR** or lift the handset.
- The unit will automatically dial the number.

To search for a name by initial

Example: When you want to search for the name "Lisa"

1. Rotate **JOG DIAL** until any name is displayed.

Example:

2. Press **5** repeatedly until any name with the initial "L" is displayed (see the character table on page 31).

3. Rotate **JOG DIAL** to the right until "Lisa" is displayed.

- To stop the operation, press **STOP**.
4. Press **MONITOR** or lift the handset.
- The unit will automatically dial the number.

Note:

- When you want to search for symbols (not letters or numbers), press ***** in step 2.

Caller ID

Caller ID service from your phone company

This unit is compatible with a Caller ID service offered by your local telephone company. To use this feature, you must subscribe to a Caller ID service.

Caller ID and its capabilities

Caller ID allows you to view the name or telephone number of the caller before you answer the call. The calling party information (name has priority) will be displayed after the first ring. By using Caller ID, you have the option of whether or not to answer the call depending on the caller. The unit also stores the caller's information and prints a list automatically after every 35 calls (p. 56).

- To print out the Caller ID list manually, see page 112.

Important:

- This feature is not available on line 2. When you subscribe to a Caller ID service, use line 1 telephone number.
- When you subscribe to a Caller ID service, set the following ring count settings to 2 or more rings:
 - FAX ONLY mode ring count for line 1 (p. 81), and
 - TEL/FAX delayed ring count (p. 91).

How Caller ID is displayed

- 1 When a call is received, the display will show the caller's name after the first ring.

Example:

- 2 You can display the caller's name and number respectively by pressing .

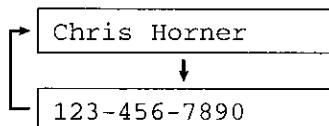

- 3 After hanging up, the caller's information (name, telephone number and the time of the call) will automatically be saved in the Caller ID list (p. 51).

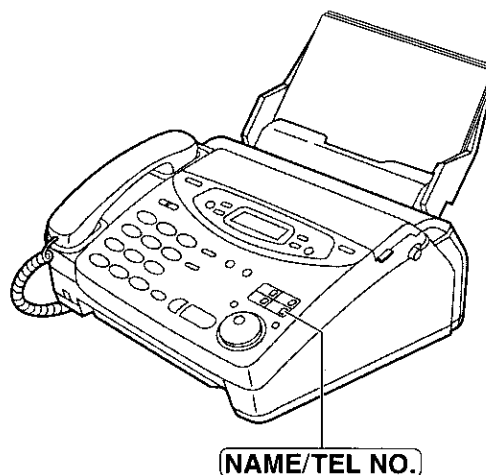

Note:

- If the unit is connected to a PBX system, you may not receive the caller's information. Consult your PBX supplier.
- The Caller ID service is currently provided in calling areas by caller identification technology. If the caller's information cannot be received, the display will show as follows.

Display:

The caller dialed from an area which does not provide the Caller ID service.

The caller has requested not to send their information.

The caller made a long distance call.

- When the unit receives a call while sending or receiving fax documents on the other line, the caller's information cannot be displayed.

Viewing the Caller ID list on the display

The unit stores the caller's information and makes a list of up to 35 callers in chronological order. When the memory is full and the unit receives a new call, the oldest data will automatically be erased. With the Caller ID list, the following convenient features are available.

- Viewing who has called you on the display (See below.)
- Dialing a telephone number from the list (p. 52)
- Storing a telephone number for automatic dialing from the list (p. 53)
- Printing out a Caller ID list (p. 112)

1 Press **CALLER ID SEARCH**.

Example: 2 NEW CALLS

Display: USE JOG-DIAL

2 Rotate **JOG DIAL** to search the Caller ID list (see below).

3 If you want to know the caller's phone number and the date/time of the call, press **NAME/TEL NO.** repeatedly while the display is showing the desired name.

- The display will alternate the name, number and date/time by pressing **NAME/TEL NO.**

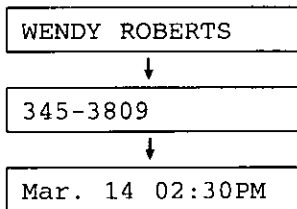

4 Press **STOP** to exit the Caller ID list.

Display: NO NAME RCVD

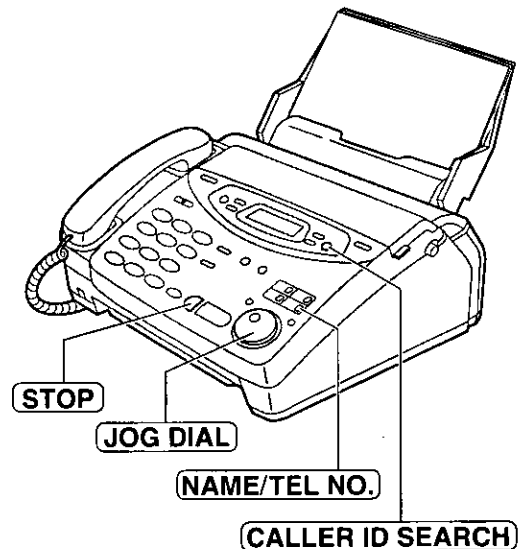

Telephone

Note:

- If the caller's name cannot be received, the following message will be displayed.

Ex. When you search from the most recent call/oldest call

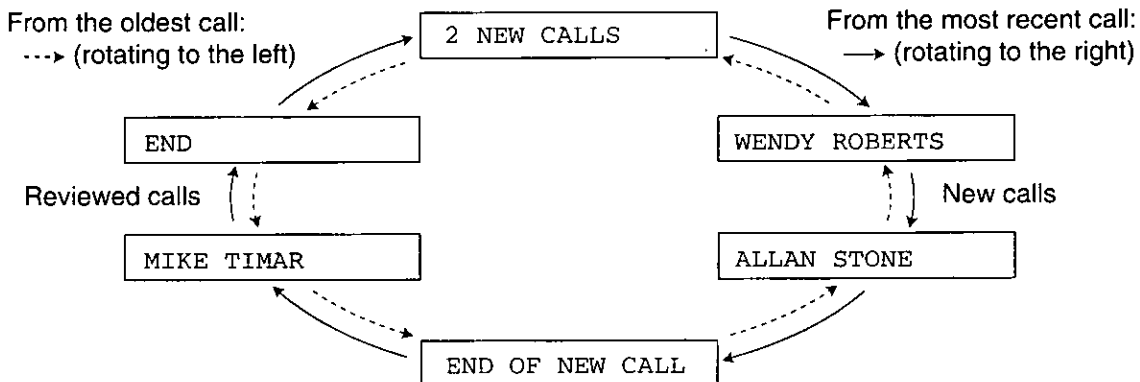

Note:

- To move between calls, rotate **JOG DIAL**.
- The display will show "END OF NEW CALL" after the last new call in the list.
- The display will show "END" after the last call in the list.
- If the display shows "NO CALLER DATA" and a beep sounds, the Caller ID list is empty.

Calling back from the Caller ID list

You can easily call back a telephone number recorded in the Caller ID list.

Important:

- This feature is not available in the following cases.
 - The telephone number includes data other than numbers (ie., * or #).
 - The telephone number information was not received.

1 Press **CALLER ID SEARCH**.

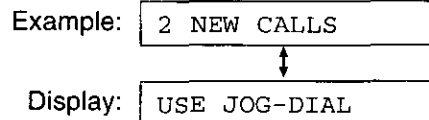

2 Rotate **JOG DIAL** until the desired name or telephone number is displayed.



3 Press **MONITOR** or lift the handset.

- A free line is selected and the unit will start dialing automatically.

4 When the other party answers, speak with the handset.

5 When finished talking, replace the handset.

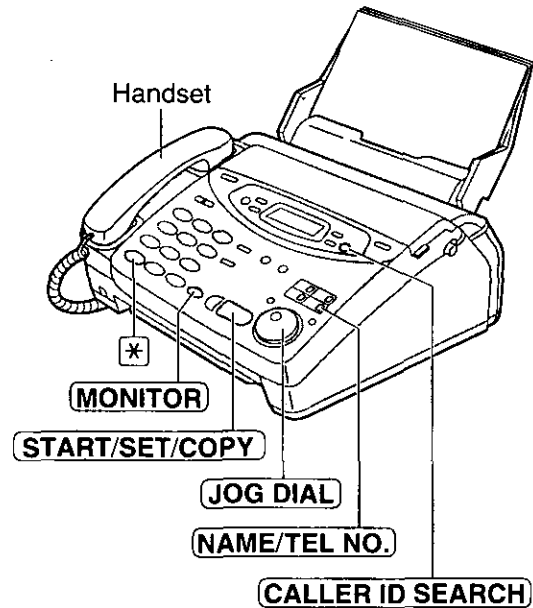

Note:

- You can send a fax by pressing **START/SET/COPY** with a document on the document feeder tray after step 3.
- If a telephone number is not displayed when pressing **NAME/TEL NO.**, you cannot call back that caller.

To edit 10 digit telephone numbers into one of 4 patterns

Press ***** in step 2 to select a pattern.
Each time you press *****, the number will be arranged into one of 4 different patterns.

- a: Telephone number
- b: 1- Area code - Telephone number
- c: 1- Telephone number
- d: Area code - Telephone number

Storing telephone numbers in the One-Touch Dial and JOG DIAL directory from the Caller ID list

You can store names and telephone numbers in the One-Touch Dial and JOG DIAL directory from the Caller ID list.

Important:

- This feature is not available in the following cases.
 - The telephone number includes data other than numbers (ie., * or #).
 - The telephone number information was not received.

1 Press **CALLER ID SEARCH**.

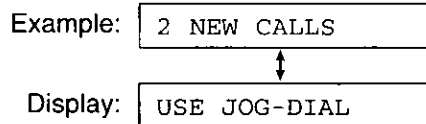

2 Rotate **JOG DIAL** until the name you want to store is displayed.

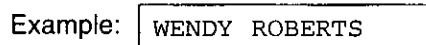

3 Press **DIRECTORY PROGRAM**.

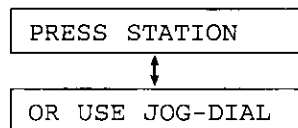

4 a: To store in the One-Touch Dial memory:
For stations 1–3, press one of the One-Touch Dial keys.

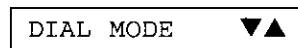

Press **START/SET/COPY**.

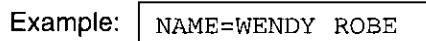

Press **START/SET/COPY**.

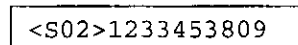

For stations 4–6, press **LOWER**, then press one of the One-Touch Dial keys.

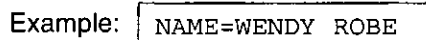

Press **START/SET/COPY**.

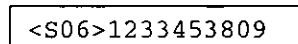

- A new entry will overwrite any previous information.
- If you are using One-Touch Dial keys 1, 2 or 3 as BROADCAST keys (p. 70), One-Touch Dial keys cannot be used for this feature.
- You can only store a name up to 10 characters long. To edit the name and number, see the instructions on page 44.

b: To store in the JOG DIAL directory:
Rotate **JOG DIAL**.

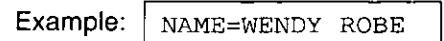

Press **START/SET/COPY**.

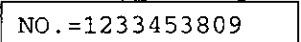

- If the directory is full, a name and number cannot be stored.
- You can only store a name up to 10 characters long. To edit the name and number, see the instructions on page 47.

5 Press **START/SET/COPY**.

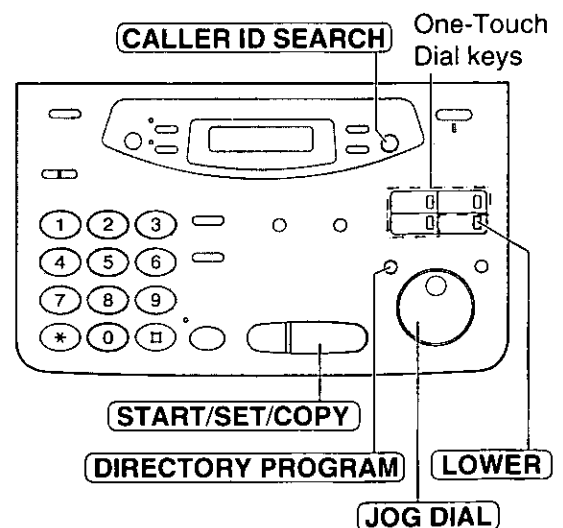
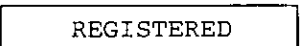

Note:

- You cannot store caller information in the One-Touch Dial and JOG DIAL directory if a telephone number is not displayed.

Telephone

Erasing all callers' information

You can erase all of the entries in the Caller ID list.

- 1** Press **MENU** three times.
Display: **3.CALLER SET UP**
- 2** Press **START/SET/COPY**.
PRESS [▼▲] & [SET]
- 3** Press **▼** or **▲** until the following message is displayed.
CALL LIST ERASE
- 4** Press **START/SET/COPY**.
ALL ERASE OK?
 - If you do not want to erase the information, press **STOP**.
- 5** Press **START/SET/COPY**.
ERASE COMPLETED
- 6** Press **STOP** to exit the program.

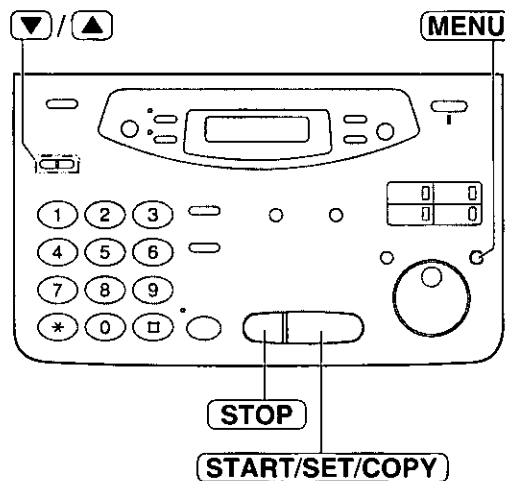

Storing your area code

When this feature is set, the caller's telephone number will be displayed without the area code when a call is received from the same area. If the call is received from outside your area, the telephone number will be displayed with "1" at the beginning.

- 1 Press **MENU** three times.
Display: 3.CALLER SET UP
- 2 Press **START/SET/COPY**.
PRESS [▼▲] & [SET]
- 3 Press ▼ or ▲ until the following message is displayed.
AREA CODE
- 4 Press **START/SET/COPY**.
CODE=
- 5 Enter your area code using 3 digits with the dial keypad.
- 6 Press **START/SET/COPY**.
REGISTERED
- 7 Press **STOP** to exit the program.

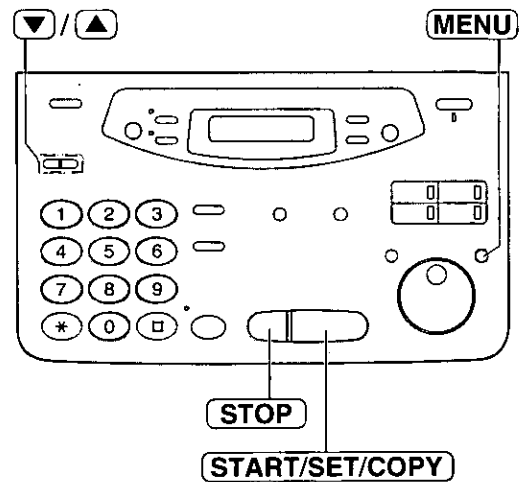

To erase the area code

- Press **STOP** when your area code is displayed in step 4. Then, press **START/SET/COPY**. Press **STOP** to exit the program.

Caller ID

Automatic Caller ID list

This feature will print a Caller ID list automatically after every 35 new calls.

After printing, only the oldest caller information will be erased when a new call is received.

When this feature is turned off, the unit will store the records of caller information, but will not print the Caller ID list automatically.

1 Press **MENU**.

Display: 1. SYSTEM SET UP

2 Press **#**, then **2** **6**.

AUTO CALL. LIST

3 Press **START/SET/COPY**.

MODE=ON

4 Press **▼** or **▲** to select the desired setting.
• If this feature is not required select "OFF".

5 Press **START/SET/COPY**.

SETUP ITEM []

6 Press **MENU**.

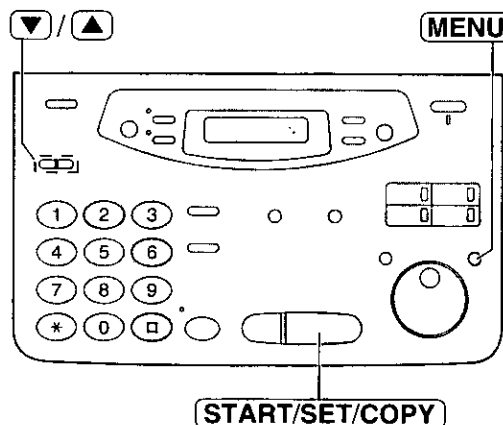

Sample of a Caller ID list

CALLER ID LIST				
[NEW]				
NO.	NAME	TELEPHONE NUMBER	TIME OF CALL	ANSWER
01	WENDY ROBERTS	123-345-3809	Jan. 04 02:35PM	FAX
02	ALLAN STONE	456-103-2238	Jan. 03 08:35AM	TEL
[OLD]				
NO.	NAME	TELEPHONE NUMBER	TIME OF CALL	ANSWER
01	MIKE TIMAR	789-345-1029	Jan. 01 02:35PM	TEL

- The NAME/TELEPHONE NUMBER/TIME OF CALL information is received through a Caller ID service.
- ANSWER: How the call was received by the unit.
 - FAX: Facsimile
 - TEL: Telephone
- If the unit did not respond to the call, the ANSWER column will be blank.
- You can also print a Caller ID list manually (p. 112).

Talking to the caller after fax transmission or reception

You can have a conversation with the same call after a fax message is completed. This will save the added expense and time of making another call.

This feature only works when the other party's fax machine is equipped with a voice contact feature.

Initiating voice contact

- 1 Press the line button of the line used for fax communication while transmitting or receiving documents.

Display: VOICE STANDBY

- Your unit will call the other party with a distinctive ring.
- When the other party answers, your unit will emit a distinctive ring.

- 2 Lift the handset to start talking.

Note:

- If you initiate voice contact during transmission, the unit will call you with a distinctive ring after all of the documents have been transmitted.
- If you initiate voice contact during reception, the unit will call you with a distinctive ring after the current page of the document is received.

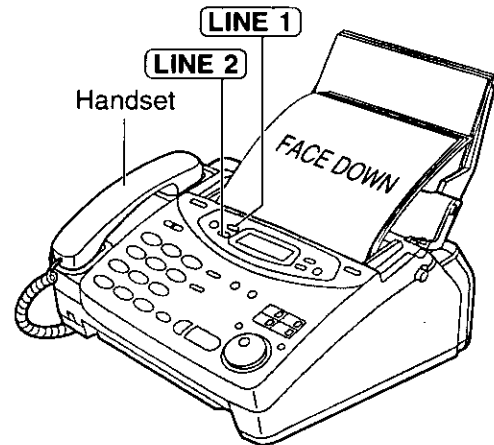

Receiving a request for voice contact

- 1 If the other party initiates voice contact, your unit will sound a distinctive ring and the line indicator will flash red.

Display: PLEASE PICK UP

- 2 Press the line button and lift the handset to start talking.

Note:

- If you do not answer within 10 seconds of hearing the distinctive ring, the line will be disconnected.

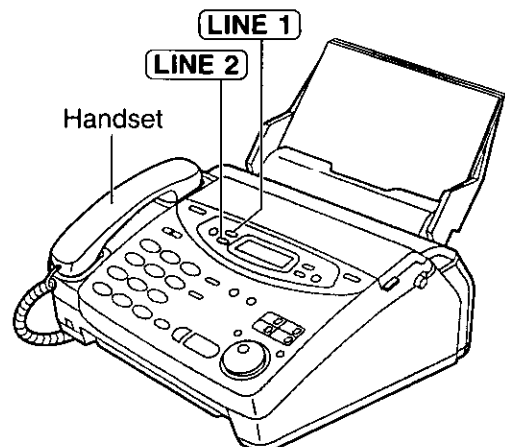

Sending Faxes

Sending a fax manually

When you lift the handset or press **MONITOR**, a free line will be selected automatically.

- 1 Open the document feeder tray.
- 2 Adjust the width of the document guides to the size of the document.
- 3 Insert the document (up to 15 pages) **FACE DOWN** until a single beep is heard and the unit grabs the document.

Display:

- 4 If necessary, press **RESOLUTION** repeatedly to select the desired setting (p. 59).
- 5 Press **MONITOR** or lift the handset (This step is optional. See note.).
 - A free line is selected automatically and the line indicator lights green.

- 6 Dial the fax number.

Example:

- 7 When a fax tone is heard:
Press **START/SET/COPY**, and replace the handset if using it.
OR
When the other party answers your call:
Lift the handset if using the monitor and ask them to press their **start** button. When a fax tone is heard, press **START/SET/COPY** and replace the handset.

- The line indicator lights red.

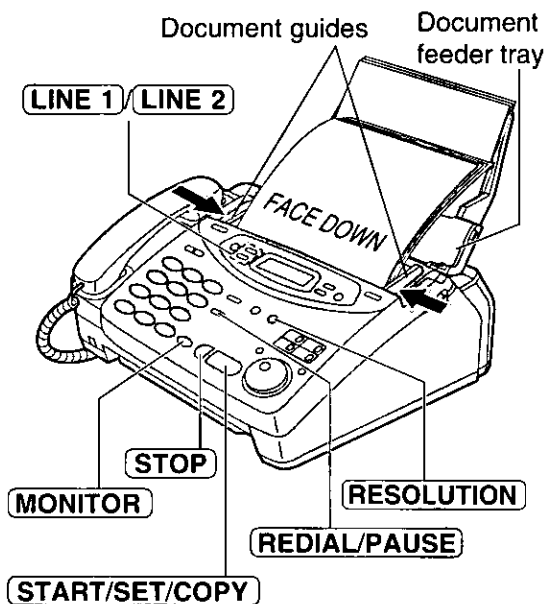

Note:

- You may select the line by directly pressing **LINE 1** or **LINE 2**.
- If you cannot send a fax, confirm the problem by printing a journal report (p. 112) and see page 99 to solve the problem.
- Performing step 5 allows you to identify any possible problems in sending a fax. For the parties with whom you have experienced no problems, you can skip step 5. Dial the fax number and press **START/SET/COPY**.

To redial the last number

Press **REDIAL/PAUSE**.

- If the line is busy, the unit will automatically redial the number up to 2 times.
- During redial, the following will be displayed.

Display:

- To cancel redialing, press **STOP**.

To feed more than 15 pages at a time

Insert the first 15 pages of the document. Add the extra pages (up to 15) before the last page is fed into the unit.

To stop transmission

Press **STOP**.

To eject the document, press **STOP** again.

To select the resolution

Select the desired resolution according to the type of document.

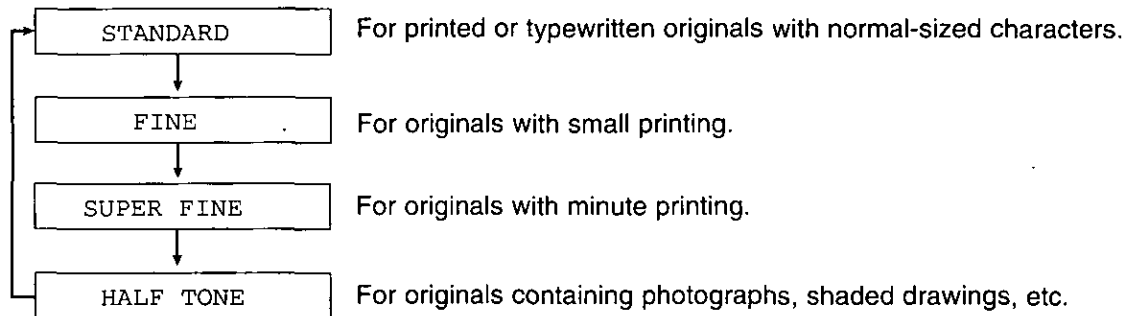

- Using the fine, super fine or half tone setting will increase the transmission time.
- If the resolution setting is changed during feeding, it will be effective from the next sheet.
- The super fine resolution only works with other compatible fax machines.

Documents you can send

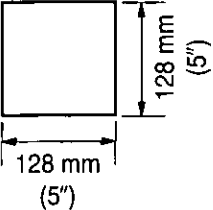
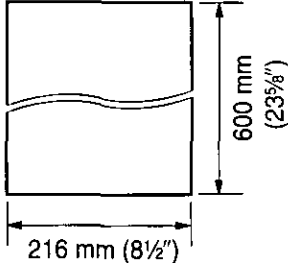
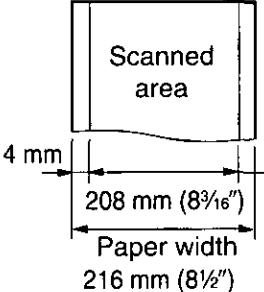
Minimum size	Maximum size	Effective scanning area	Document weight
			<p>Single sheet: 45 g/m² to 90 g/m² (12 lb. to 24 lb.)</p> <p>Multiple sheets: 60 g/m² to 75 g/m² (16 lb. to 20 lb.)</p>

Note:

- Remove clips, staples or other similar fastening objects.
- Check that ink, paste or correction fluid has dried.
- Do not send the following types of documents. Use copies for fax transmission.
 - Chemically treated paper such as carbon or carbonless duplicating paper
 - Electrostatically charged paper
 - Heavily curled, creased or torn paper
 - Paper with a coated surface
 - Paper with a faint image
 - Paper with printing on the opposite side that can be seen through the front (e.g. newspaper)

Sending Faxes

Sending a fax using the One-Touch Dial

Before using this feature, program the desired names and telephone numbers into the One-Touch Dial (p. 44).

- 1 Open the document feeder tray.
- 2 Adjust the width of the document guides to the size of the document.
- 3 Insert the document (up to 15 pages) **FACE DOWN** until a single beep is heard and the unit grabs the document.

Display: STANDARD

- 4 If necessary, press **RESOLUTION** repeatedly to select the desired setting (p. 59).

- 5 **For stations 1–3**
Press the desired One-Touch Dial key.
For stations 4–6
Press **LOWER**, then press the desired One-Touch Dial key.

Example: FAX=<John>
↓
CONNECTING.....

- The unit will select a free line and start transmission.

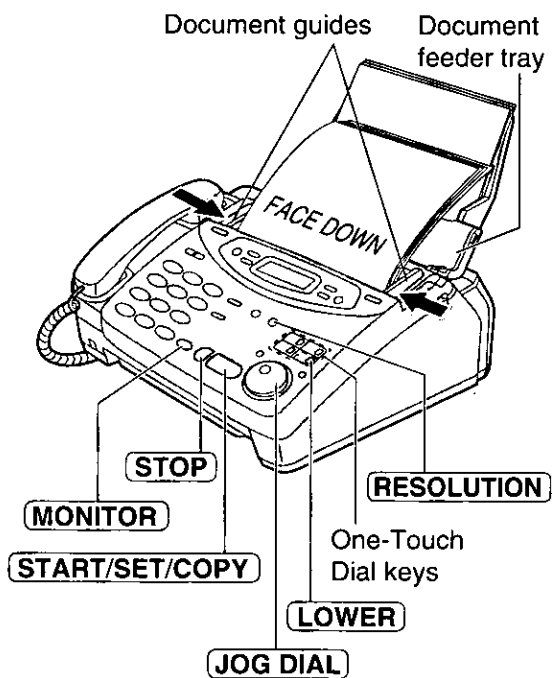

Helpful hints:

- You can confirm the stored items on the display (p. 49) or on the telephone number list (p. 112).
- You can use the JOG DIAL directory to select the station name instead of using the One-Touch Dial keys. Rotate **JOG DIAL** until the desired name is displayed, then press **START/SET/COPY**.
- The connecting tone will be heard during dialing to tell you the status of the other party's machine (p. 73).

If your unit does not send a fax

Verify that the number dialed is answered by the other party's machine.

1. Press **MONITOR**.
2. **For stations 1–3**
Press the desired One-Touch Dial key.
For stations 4–6
Press **LOWER**, then press the desired One-Touch Dial key.

Fax auto redial

If the line is busy or there is no answer, the unit will automatically redial the number up to 2 times.

- This feature is also available for;
 - sending faxes using the JOG DIAL directory (p. 61), and
 - delayed transmission (p. 68).
- During redial, the following will be displayed.

Display: WAITING REDIAL

- To cancel redialing, press **STOP**.

Sending a fax using the JOG DIAL directory

Before using this feature, program the desired names and telephone numbers into the directory (p.46).

- 1** Open the document feeder tray.
- 2** Adjust the width of the document guides to the size of the document.
- 3** Insert the document (up to 15 pages) **FACE DOWN** until a single beep is heard and the unit grabs the document.

Display: STANDARD

- 4** If necessary, press **RESOLUTION** repeatedly to select the desired setting (p. 59).

- 5** Rotate **JOG DIAL** until the desired name is displayed.

Example: Alice

- To confirm the number, press **NAME/TEL NO.**

- 6** Press **START/SET/COPY**.

FAX=<Alice>
↓
CONNECTING.....

- The unit will select a free line and start transmission.

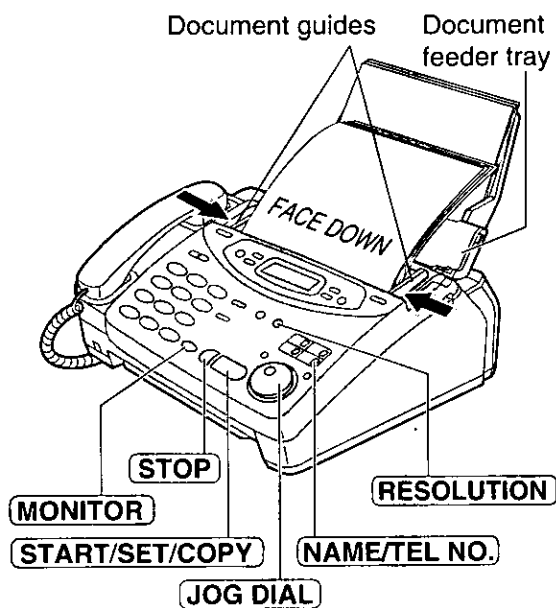

Helpful hints:

- You can confirm the stored items on the display (p. 49) or on the telephone number list (p. 112).
- The connecting tone will be heard during dialing to tell you the status of the other party's machine (p. 73).

Note:

- If the desired name has not been stored, press **STOP** and dial the number manually.
- For further details about using the JOG DIAL, see page 49.

If your unit does not send a fax

Verify that the number dialed is answered by the other party's machine.

1. Rotate **JOG DIAL** until the desired name is displayed.
2. Press **MONITOR**.

Sending Faxes

Sending a fax during a conversation

While having a conversation on one line, you can send a fax on the other line.

Example: If you are using LINE 1

1 Press **HOLD** to put the first call (line 1) on hold.

ON HOLD

- The line 1 indicator flashes green.

2 Insert the documents **FACE DOWN**, and then press the other line button (**LINE 2**) to make a second call.

- The line 2 indicator lights green.

3 Enter the fax number using the dial keypad, One-Touch Dial or **JOG DIAL**.

4 Press **START/SET/COPY**.

- If you use **JOG DIAL** in step 3, press **START/SET/COPY** again.
- The line 2 indicator lights red.

5 To return to the first call (line 1), press the line button of the first call (**LINE 1**).

- The line 1 indicator lights green.

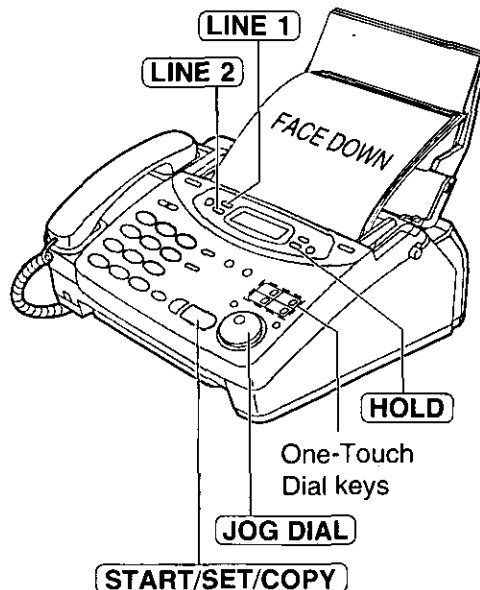

IQ-FAX

This feature can only be used by those who apply to the FaxSav service.

IQ-FAX is intelligent faxing which allows you to send faxes via the Internet using the IQ-FAX button. Behind the IQ-FAX button is the FaxSav Global Fax Network which manages the delivery of your fax to any fax machine in the world. It routes your fax via the best and most time-efficient route and will automatically resend your fax for you, if the receiving fax machine is unavailable.

This "fax-only" network has the added advantage of cost efficiency due to the Internet being integrated into the network. Every fax is secure since the FaxSav network utilizes the highest encryption legally allowed, ensuring that your document stays secure. You get the benefits of carefree faxing with savings associated with the use of the Internet. It is simple, quick, and secure.

For more information, contact FaxSav at 1-888-332-9728. This number is pre-programmed in the JOG DIAL directory (p. 46).

Important:

- This feature is not available on line 2. When you apply to the FaxSav service, use line 1 telephone number.

How your fax is sent to the other party's fax machine

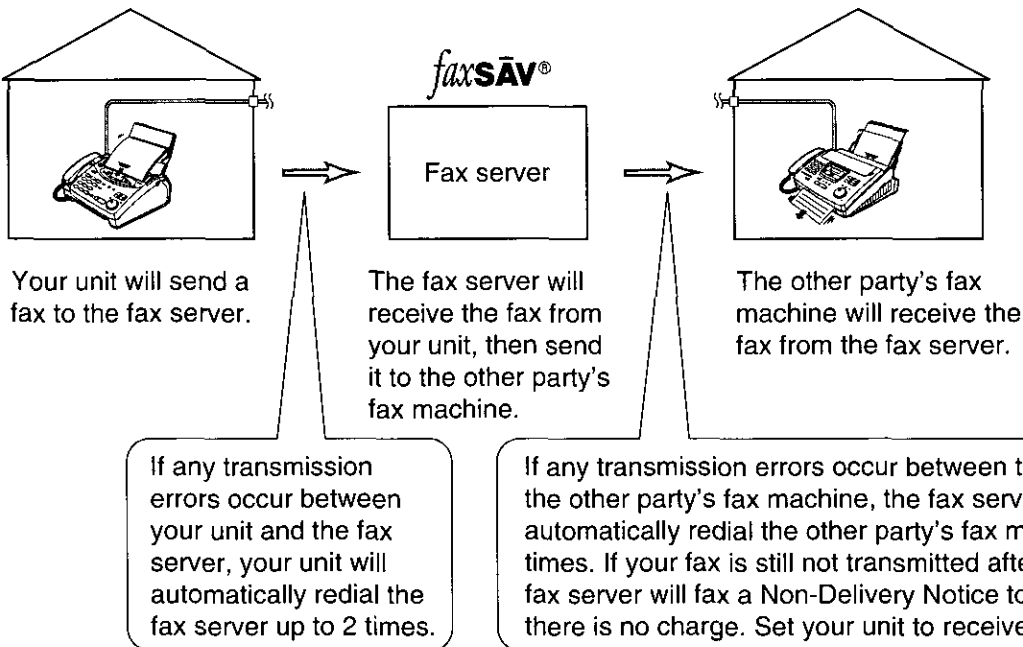

How to apply for the FaxSav Internet service for your unit

- 1 Fill out the attached application form and fax it to 1-800-909-6649.
 - The FaxSav company will send you a welcome fax after they have activated your account.
 - There is no application or monthly fee. You pay only for the faxes you send.
- 2 To activate the IQ-FAX function from your fax machine, set feature setting #75 to "ON" (see next page).

Sending Faxes

Turning on the IQ-FAX function

Before programming, confirm that your application has been processed by FaxSav.

1 Press **MENU**.
Display: 1.SYSTEM SET UP

2 Press **#**, then **7 5**.
IQ-FAX

3 Press **START/SET/COPY**.
MODE=OFF ▼▲

4 Press ▼ or ▲ to select "ON".
MODE=ON ▼▲

•If this feature is not required, select "OFF".

5 Press **START/SET/COPY**.
SETUP ITEM []

6 Press **MENU**.

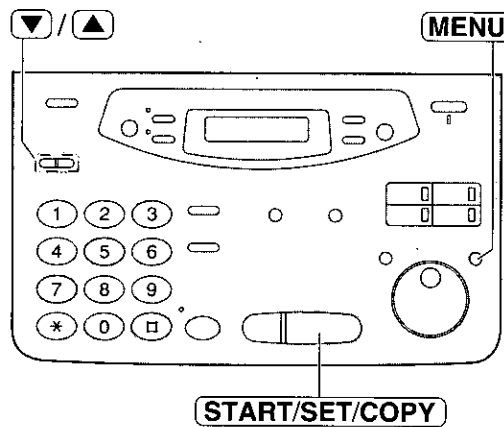

Sending a fax using the Internet

- 1** Open the document feeder tray.
- 2** Adjust the width of the document guides to the size of the document.
- 3** Insert the document (up to 15 pages) **FACE DOWN** until a single beep is heard and the unit grabs the document.

Display: STANDARD

- 4** If necessary, press **RESOLUTION** repeatedly to select the desired setting (p. 59).

- 5** Press **IQ-FAX**.

IQFAX TO WHERE?

- 6** Enter the fax number using the dial keypad, One-Touch Dial, **JOG DIAL** or **BROADCAST** key.

•When using the **JOG DIAL**, press **START/SET/COPY** after displaying the desired item.

Example: FAX-<Adam>

- 7** Press **START/SET/COPY**.

TRYING IQ-FAX



CONNECTING.....



SENDING P 1



SENT TO SERVER

•If the number you dialed is out of the FaxSav network service area, the unit will show the following messages and send the fax directly over the telephone line.

OUT OF NETWORK



SENDING NORMAL

•If "OUT OF NETWORK" is displayed when sending a fax long-distance or internationally using IQ-FAX, then contact FaxSav at 1-888-332-9728.

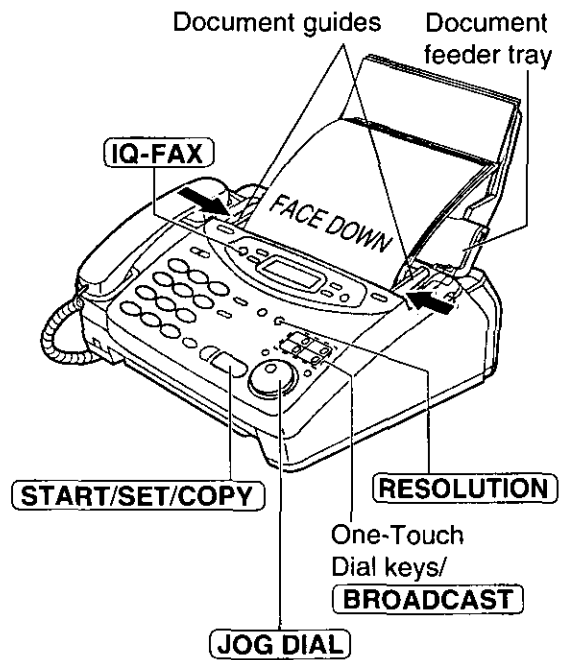

If you cannot send a fax

Contact FaxSav at 1-888-332-9728.

The FaxSav customer service center may send you a program update. While receiving this update, you will not be able to operate the unit and the following message will be displayed for about 3 minutes.

Display: LOADING IQ-DATA

During this time, you will not be able to operate extension telephones, if they are connected.

If a loading error occurs, the unit will display the following message.

LOADING ERROR

In this case, contact FaxSav at 1-888-332-9728.

Sending Faxes

Sending report for confirmation

The sending report will provide you with a printed record of fax transmission results. One of the following choices is available.

ERROR: The sending report will print out only when fax transmission fails (pre-selected setting).

ON: The sending report will always print out, indicating whether fax transmission is successful or not.

OFF: The sending report will not print.

- 1 Press **MENU**.
Display: 1.SYSTEM SET UP
- 2 Press **#**, then **0** **4**.
SENDING REPORT
- 3 Press **START/SET/COPY**.
MODE=ERROR ▼▲
- 4 Press ▼ or ▲ to select the desired setting.
- 5 Press **START/SET/COPY**.
SETUP ITEM []
- 6 Press **MENU**.

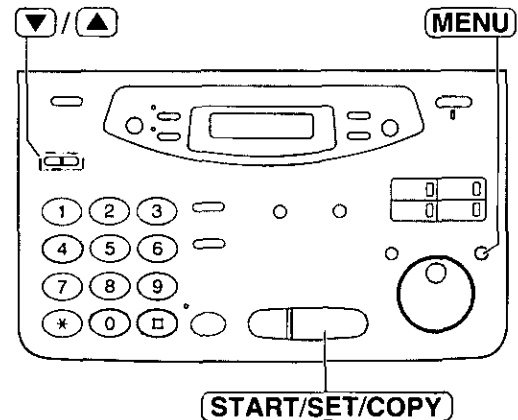

Sample of a sending report

SENDING REPORT		Jan. 20 1999 01:19PM					
NO.	OTHER FACSIMILE	START TIME	USAGE TIME	MODE	PAGES	RESULT	*CODE
01	2345678	Jan. 20 01:18PM	00'51	SND	00	COMMUNICATION ERROR	(43)

SND: Sent directly.
IQ-FAX: Sent to the fax server.

Communication message (p. 99)

Error code (for service personnel use only)

Note:

- If your fax is not transmitted to the other party's fax machine using the FaxSav network, the FaxSav network will send a Non-Delivery Notice to your unit.

Automatic journal report

This feature prints a journal report automatically after every 35 new fax communications. After printing, only the oldest communication result will be erased when a new communication occurs. When this feature is deactivated, the unit will store the records of the fax communications, but will not print the journal report automatically.

- 1 Press **MENU**.
Display: 1.SYSTEM SET UP
- 2 Press **#**, then **2** **2**.
AUTO JOURNAL
- 3 Press **START/SET/COPY**.
MODE=ON
- 4 Press **▼** or **▲** to select the desired setting.
• If this feature is not required, select "OFF".
- 5 Press **START/SET/COPY**.
SETUP ITEM []
- 6 Press **MENU**.

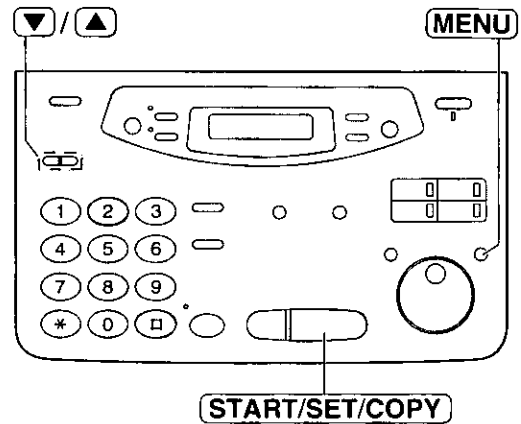

Fax/Copy

Sample of a journal report

JOURNAL							
Jan. 25 1999 05:22PM							
NO.	OTHER FACSIMILE	START TIME	USAGE TIME	MODE	PAGES	RESULT	*CODE
01	3332222	Jan. 21 02:14PM	00'45	SND	01	OK	
02	9998765	Jan. 21 03:17PM	00'58	IQ-FAX	02	OK	
03	John	Jan. 21 05:18PM	00'48	RCV	01	OK	
04	555556677	Jan. 22 10:35AM	02'45	SND	03	COMMUNICATION ERROR	(43)
05			02'50	SND	05	OK	
				RCV	03	OK	

SND: Sent directly.
 IQ-FAX: Sent to the fax server.
 RCV: Received directly.

Communication message (p. 99)

Error code (for service personnel use only)

Note:

- You can also print a journal report manually (p. 112).
- If your fax is not transmitted to the other party's fax machine using the FaxSav network, the FaxSav network will send a Non-Delivery Notice to your unit.

Sending Faxes

Delayed transmission (sending a fax at a specified time)

Using a built-in clock, this unit can send documents automatically at a specified time. This allows you to take advantage of low-cost calling hours offered by your telephone company. The delayed transmission can be reserved to take place up to 24 hours in advance.

- 1 Insert the document **FACE DOWN** until a single beep is heard and the unit grabs the document.

Display: STANDARD

- 2 Press **MENU**.

1. SYSTEM SET UP

- 3 Press **#**, then **2 5**.

DELAYED SEND

- 4 Press **START/SET/COPY**.

MODE=OFF ▼▲

- 5 Press ▼ or ▲ to select "ON".

MODE=ON ▼▲

- 6 Press **START/SET/COPY**.

FAX=

- 7 Enter the fax number using the dial keypad, One-Touch Dial or **JOG DIAL**.

- 8 Press **START/SET/COPY**.

TIME=12:00AM

- 9 Enter the transmission start time. Press ***** to select "AM" or "PM".

Example (using the dial keypad): 11:30PM
Press **1130**, then press ***** until "PM" is displayed.

TIME=11:30PM

- 10 Press **START/SET/COPY**.

SETUP ITEM []

- 11 Press **MENU**.

SEND AT 11:30PM

- At the programmed time, the unit will automatically start transmission.

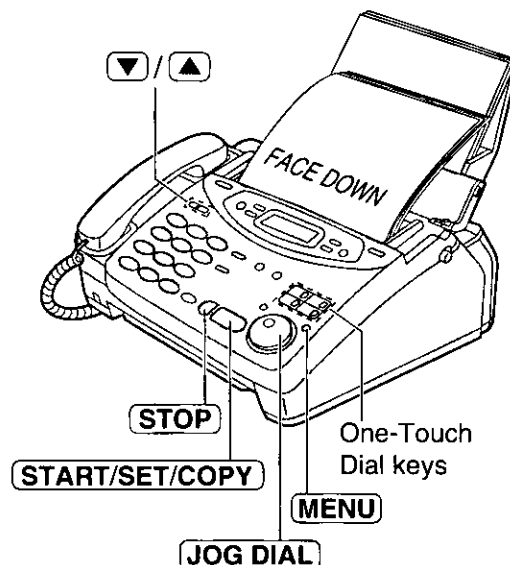

Note:

- You can receive, transmit and copy documents while delayed transmission is set.

To cancel the delayed transmission setting

1. Press **STOP** while the unit is idle.

Display: SEND CANCELED?



YES: PRESS SET

2. Press **START/SET/COPY**.

From memory

The unit is able to scan and store documents into memory, and then transmit the stored document. The memory capacity is approx. 25 pages based on the CCITT No. 1 Test Chart in standard resolution. For the CCITT No. 1 Test Chart, see page 118.

- 1** Insert the document **FACE DOWN**.
- 2** Enter the fax number using the dial keypad.
- 3** Press **QUICK SCAN**.

- The document will be fed into the unit and scanned into memory. After storing all of the pages, the unit will transmit the document.
- The amount of memory used will be shown as a percentage on the display.

Display: PAGES=01 05
Amount of memory used (%) —

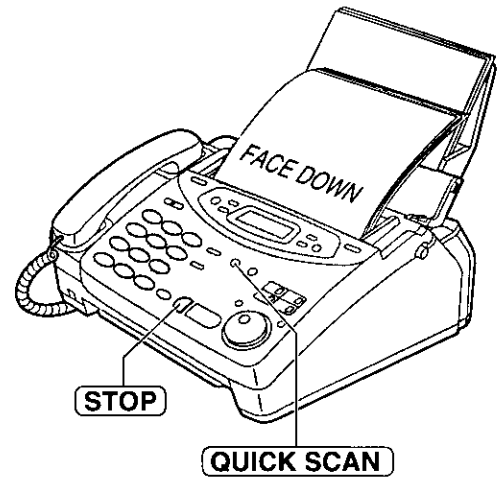

Fax/Copy

Note:

- The stored document will be automatically erased after transmission.
- To cancel the memory transmission, press **STOP** during or after scanning the document.
- If you select the fine, super fine or half tone resolution, the number of documents that can be sent will decrease.
- If the stored pages exceed the memory capacity, the transmission will be canceled.
- If the other party's fax number is written on the document, you can enter the number by referring to the document before inserting it.

Sending Faxes

Multiple stations

This feature is useful for sending the same document to selected parties whose telephone numbers are stored in the One-Touch Dial or JOG DIAL directory. You must program the desired parties into one of the BROADCAST keys (One-Touch Dial keys 1, 2 or 3).

Important:

- Before programming, make sure that the desired telephone numbers have been stored into the One-Touch Dial or JOG DIAL directory.
- The BROADCAST keys can be used as One-Touch Dial keys 1, 2 or 3 or as broadcast keys. These functions cannot be used at the same time.

Programming the BROADCAST keys with telephone numbers

- 1** Press **DIRECTORY PROGRAM**.

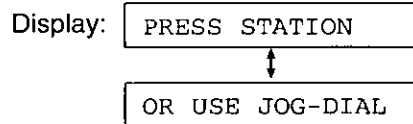

- 2** Press one of the **BROADCAST** keys.

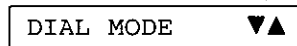

- 3** Press ▼ or ▲ to select "BROADCAST".

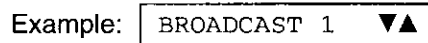

- 4** Press **START/SET/COPY**.

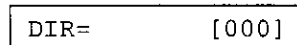

- 5** Enter the station.

a: Using the One-Touch Dial:

For stations 1–3 which are not used as **BROADCAST** keys, press the preset One-Touch Dial key.

For stations 4–6, press **LOWER**, then press the preset One-Touch Dial key.

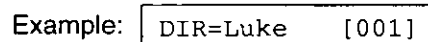

b: Using the JOG DIAL directory:

Rotate **JOG DIAL** until the desired name is displayed.

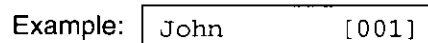

Press **START/SET/COPY**.

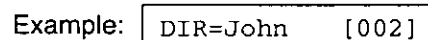

- To enter other stations, repeat this step (up to 20 stations).

- 6** Press **START/SET/COPY** after entering all of the desired stations.

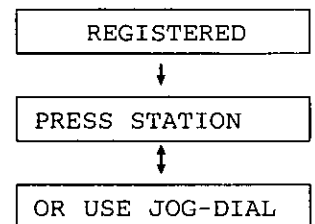

- To program another BROADCAST key, repeat steps 2 to 6.

- 7** Press **DIRECTORY PROGRAM** to exit the program.

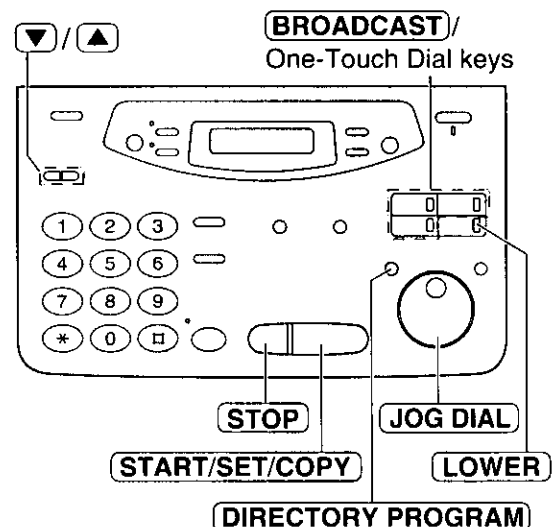

Note:

- If you make a mistake while programming, press **STOP**, then make the correction.
- Confirm the stored numbers by printing a broadcast list (p. 112).

Adding a new name and number

- 1** Rotate **JOG DIAL** until the desired BROADCAST key is displayed.

Example:

- 2** Press **DIRECTORY PROGRAM**.

- 3** Press ***** to select "ADD".

Example:

- 4** Rotate **JOG DIAL** until the desired name is displayed.

Example:

- 5** Press **START/SET/COPY**.

Example:

- To add other stations, repeat steps 4 and 5 (up to 20 stations).

- 6** Press **DIRECTORY PROGRAM** to exit the program.

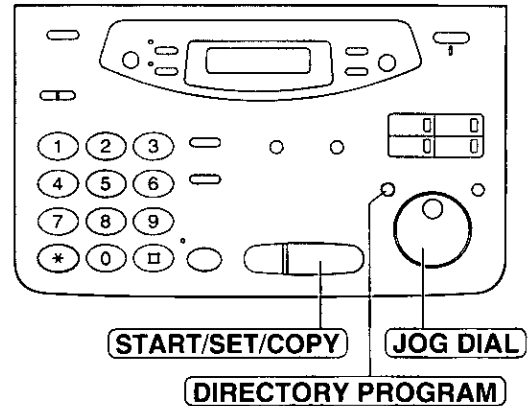

Fax/Copy

Erasing a stored name and number

- 1** Rotate **JOG DIAL** until the desired BROADCAST key is displayed.

Example:

- 2** Press **DIRECTORY PROGRAM**.

- 3** Press **#** to select "DELETE".
- The first name will be shown.

Example:

- 4** Rotate **JOG DIAL** until the desired name is displayed.

Example:

- If you do not want to erase the item, press **STOP**.

- 5** Press **START/SET/COPY**.

- 6** Press **START/SET/COPY**.

Example:

- To delete other stations, repeat steps 4 to 6.

- 7** Press **DIRECTORY PROGRAM** to exit the program.

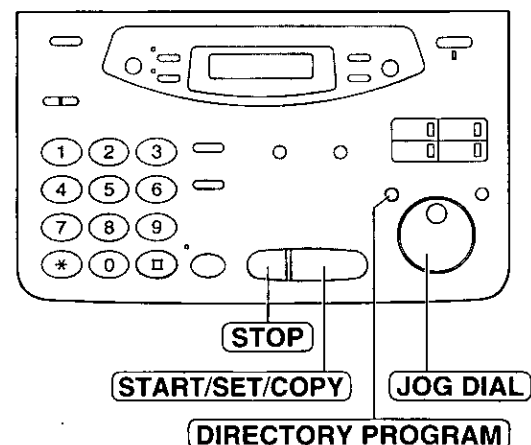

Sending Faxes

Using the BROADCAST keys

The document will be scanned and stored into memory when using the BROADCAST keys. After transmission, the stored document will be erased automatically.

The memory capacity is approx. 25 pages based on the CCITT No. 1 Test Chart in standard resolution. For the CCITT No. 1 Test Chart, see page 118.

- 1 Insert the document FACE DOWN.
- 2 Press the desired **BROADCAST** key.
 - The document will be fed into the unit and scanned into memory. The unit will then transmit the data to each station, calling each number sequentially.

Note:

- If you select the fine, super fine or half tone resolution, the number of pages that the unit can transmit will decrease.
- If one of the stations is busy or does not answer, the station will be skipped. All skipped stations will be redialed up to 2 times after all of the other stations have been called.

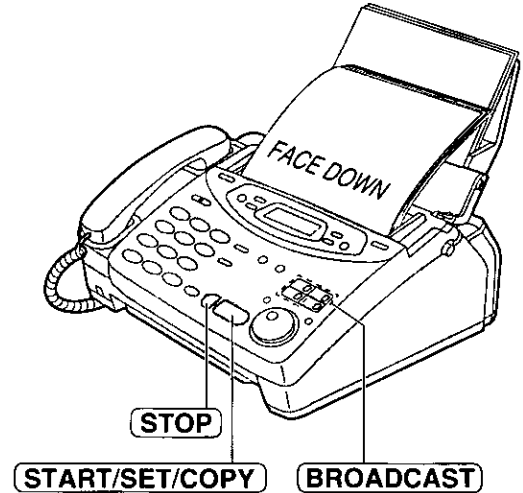

To cancel the broadcast setting

1. Press **STOP** while the unit displays "BROADCASTING".

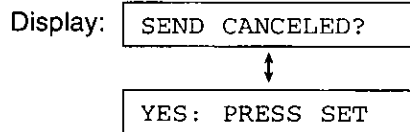

2. Press **START/SET/COPY**.

Broadcast report

After all of the transmissions have been completed, the unit will automatically print the following report.

Sample of a broadcast report:

BROADCAST REPORT 1						
Jan. 10 1999 03:36PM						
NO.	OTHER FACSIMILE	START TIME	USAGE TIME	PAGES (IQ-FAX)	RESULT	
01	Mike	Jan. 10 03:31PM	01'10	02 *	OK	
02	Peter	Jan. 10 03:33PM	01'08	02 *	OK	
03	Sam	Jan. 10 03:34PM	01'09	02 *	OK	
04	Kim	Jan. 10 03:35PM	01'10	02 *	OK	
TOTAL			004'37	008 (008)		

Total number of pages sent to the fax server.

The "*" mark in this column shows the fax has been sent to the fax server.

Overseas

You may experience difficulty when transmitting documents overseas. This feature makes sending documents easier as the transmission speed is slowed down. Before starting transmission, follow the steps below.

- 1 Press **MENU**.
Display: 1. SYSTEM SET UP
- 2 Press **#**, then **2** **3**.
OVERSEAS MODE
- 3 Press **START/SET/COPY**.
MODE=OFF ▼▲
- 4 Press ▼ or ▲ to select "ON".
MODE=ON ▼▲
 - If this feature is not required, select "OFF".
- 5 Press **START/SET/COPY**.
SETUP ITEM []
- 6 Press **MENU**.

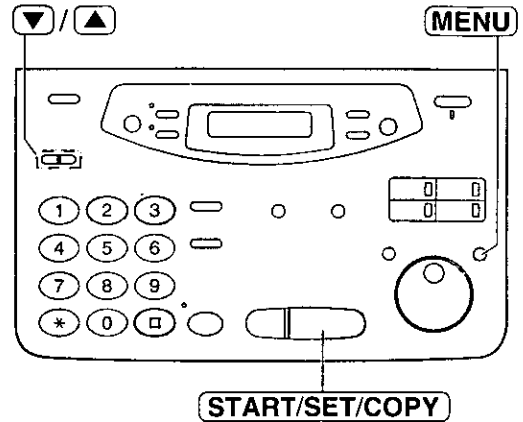

Note:

- After transmission, this feature will turn off automatically.
- This feature is not available for transmission using the BROADCAST keys.
- A slower transmission speed will lengthen the call duration. Therefore the calling charge may be higher.

Fax/Copy

Connecting tone

This feature allows you to hear connecting tones, such as a fax tone, ring back tone or busy tone for several seconds when you send a fax using the One-Touch Dial or JOG DIAL directory. This will tell you the status of the other party's machine.

If you hear a:

- Fax tone: The other party's machine is ready for reception.
- Ring back tone: If this tone continues, the other party's machine may not be a facsimile or may have run out of paper. Check with the other party.
- Busy tone: The other party's machine is busy. Let the unit continue redialing or press **STOP** and try again later.

This feature is set to "ON" as a pre-selected setting. If this feature is not required, you may turn it off.

- 1 Press **MENU**.
Display: 1. SYSTEM SET UP
- 2 Press **#**, then **7** **6**.
CONNECTING TONE
- 3 Press **START/SET/COPY**.
MODE=ON ▼▲
- 4 Press ▼ or ▲ to select the desired setting.
 - If this feature is not required, select "OFF".
- 5 Press **START/SET/COPY**.
SETUP ITEM []
- 6 Press **MENU**.

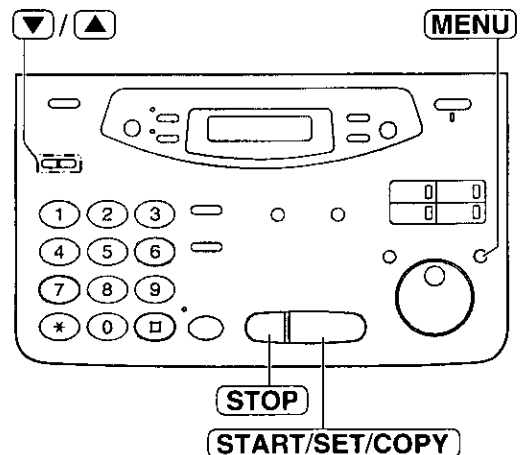

Note:

- The connecting tone volume cannot be adjusted.

Receiving Faxes

Setting Line 1 to receive calls

Option A

Option B

How you want the unit to receive calls

To answer all voice and fax calls yourself.

To receive faxes automatically.

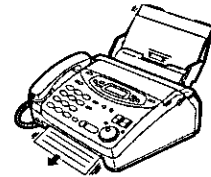

Voice/Fax call

Fax call

You have to set this.

TEL mode

(p. 78)

FAX ONLY mode

(p. 79)

The **AUTO ANSWER** light should be **OFF**.

- If the **AUTO ANSWER** light is on, press **AUTO ANSWER** to turn it off.

The **AUTO ANSWER** light should be **ON**.

- If the **AUTO ANSWER** light is off, press **AUTO ANSWER** to turn it on.

This is how the unit will operate.

When the unit rings, you must answer all calls.

- If you hear a fax calling tone (slow beep) or no sound is heard, press **START/SET/COPY**.
- An answering machine can also answer the incoming calls (p. 82).

All incoming calls will be answered as faxes, and the unit will try to receive a fax.

Option C

You have a Distinctive Ring service from the telephone company (this allows you to have up to 3 telephone numbers on the same line).

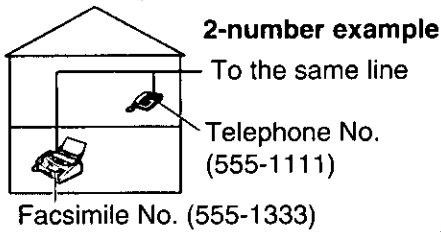

To activate the Distinctive Ring mode, select the same ring pattern assigned to the facsimile number in feature #31 (p. 87).

- A:** Standard ring (one long ring)
- B:** Double ring (two short rings)
- C:** Triple ring (short-long-short rings)
- D:** Other triple ring (short-short-long rings)

The unit will automatically answer calls received at your facsimile number. If a call is received at the other telephone number, the unit will operate based on the set receive mode.

Option D

You want to use the fax machine with an answering machine.

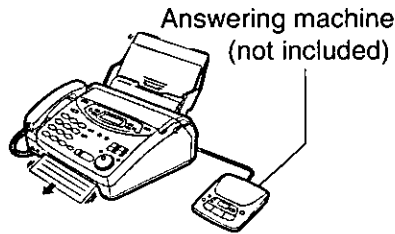

Voice/Fax call

1. Connect an answering machine to the EXT.L1 ONLY jack.
 2. Set the number of rings on the answering machine to less than 4.
 3. Record a greeting message on the answering machine.
 4. Turn on the answering machine.
 5. Program the remote activation ID into your fax machine.
- For further details, see pages 82 to 84.

Use with TEL mode or FAX ONLY mode.

If you use with FAX ONLY mode, set the FAX ONLY mode ring count for line 1 to "5 EXT.TAM" (p. 81).

When receiving voice calls:
 The answering machine will record voice messages.

When receiving fax calls:
 The fax machine will receive document.

Other options

Voice mail
 If you have a voice mail service from your telephone company, you also need to subscribe to a Distinctive Ring service (p. 86).

With PC
 If you have a computer attached to the same telephone line, see page 83.

TEL/FAX mode
 If you are near the unit and want to use it to receive your voice calls yourself and fax calls automatically, see pages 88 to 91.

Remote activation
 If you answer a telephone in another room and hear the fax tone, you can activate the unit remotely by pressing *9 (p. 85).

Fax/Copy

Receiving Faxes

Setting Line 2 to receive calls

Option A

Option B

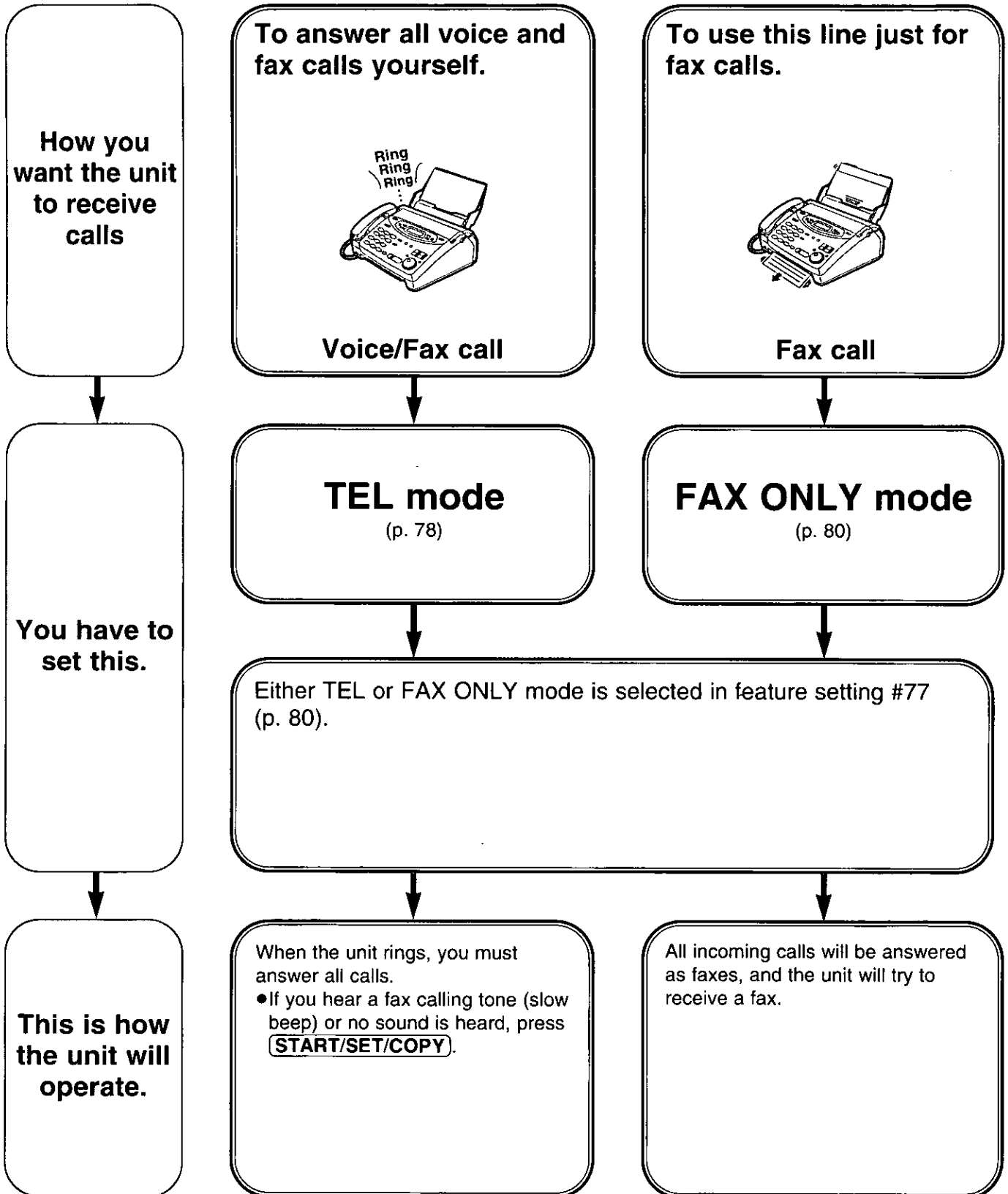

Option C

You have a Distinctive Ring service from the telephone company (this allows you to have up to 3 telephone numbers on the same line).

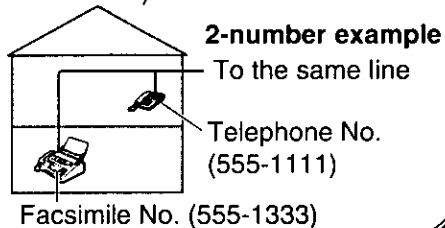

To activate the Distinctive Ring mode, select the same ring pattern assigned to the facsimile number in feature #31 (p. 87).

- A:** Standard ring (one long ring)
- B:** Double ring (two short rings)
- C:** Triple ring (short-long-short rings)
- D:** Other triple ring (short-short-long rings)

The unit will automatically answer calls received at your facsimile number. If a call is received at the other telephone number, the unit will operate based on the set receive mode.

Other options

Voice mail

If you have a voice mail service from your telephone company, you also need to subscribe to a Distinctive Ring service (p. 86).

Receiving Faxes

TEL mode (answering all calls manually)

When you use the TEL mode on line 1, turn the AUTO ANSWER mode off. If the AUTO ANSWER light is on, press **(AUTO ANSWER)**.

- The display will show the following.

Display: TEL MODE

When an incoming call arrives on either line 1 or 2, the line indicator that the call is arriving will flash red.

- 1** When the unit rings, lift the handset to answer the call.
 - The calling line is selected automatically and the line indicator lights green.
- 2** When:
 - document reception is required,
 - a fax calling tone (slow beep) is heard, or
 - no sound is heard,press **(START/SET/COPY)**.

CONNECTING.....

- The line indicator lights red.

- 3** Replace the handset.
 - The unit will start reception.

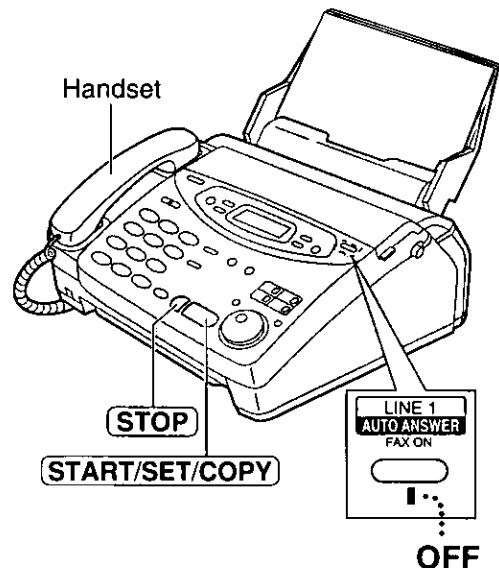

Note:

- If you do not answer the call within 15 rings, the unit will temporarily switch to the fax and the caller can send documents.

To stop receiving the document

Press **(STOP)**.

Friendly reception feature

When you answer a call and hear a fax calling tone (slow beep), the unit will automatically start receiving.

- If this feature is not required, set to "OFF" (p. 94).

To receive documents during a telephone conversation

1. Press **(HOLD)** to put the first call on hold.
 - The line indicator flashes green.
2. Press the other line button to answer the second call.
3. Press **(START/SET/COPY)**.
4. To return to the first call, press the line button of the first call.

Memory reception

When a printing problem is detected, the unit will temporarily store the received document into memory.

While document is in memory, the unit will:

- display an error message and the following message alternately.

Display: FAX IN MEMORY

—alert you with slow beeps (memory reception alert).

- Follow the instructions on pages 100 and 101 to solve the problem and print the stored document.
- For memory capacity, see page 118.

FAX ONLY mode (all calls are received as faxes)

Activating the FAX ONLY mode on line 1

If the AUTO ANSWER light is off, turn it on by pressing **AUTO ANSWER**.

- The display will show the following.

Display: FAX ONLY MODE

- The number of rings before a call is answered can be changed (p. 81).

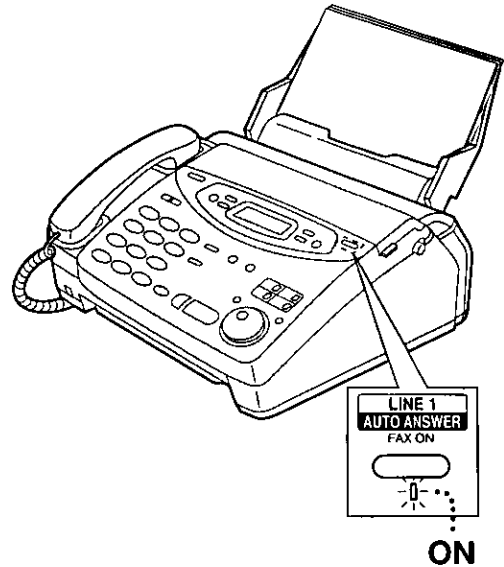

If you have a telephone line just for receiving faxes, we recommend the following setup.

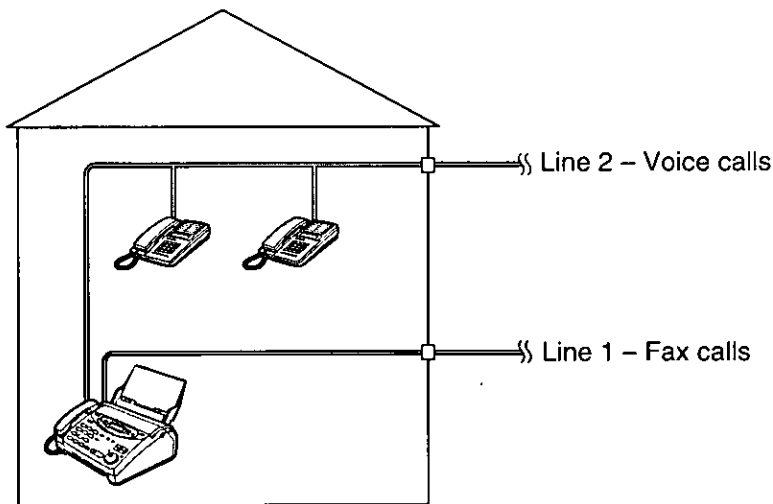

Only a fax machine is connected.

Example: One telephone line is used for voice calls and a separate telephone line for faxes. If someone sends a fax to Line 1, the fax machine will ring according to the FAX ONLY mode ring count setting (p. 81).

Receiving Faxes

Activating the FAX ONLY mode on Line 2

- 1 Press **MENU**.
Display: 1.SYSTEM SET UP
- 2 Press **#**, then **7 7**.
LINE SELECTION
- 3 Press **START/SET/COPY**.
LINE1=FAX ONLY▼▲
- 4 Press **START/SET/COPY**.
LINE2=TEL ▼▲
- 5 Press ▼ or ▲ to select "FAX ONLY".
LINE2=FAX ONLY▼▲
- 6 Press **START/SET/COPY**.
SETUP ITEM []
- 7 Press **MENU**.

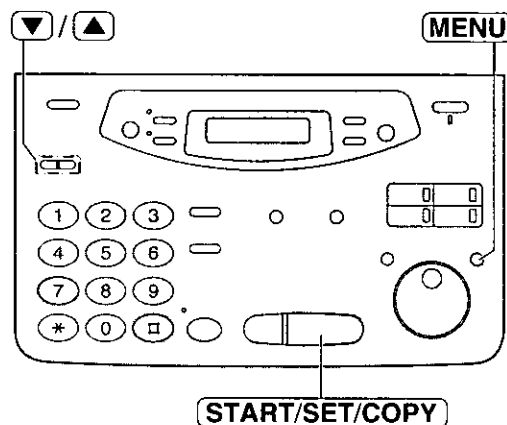

Note:

- The number of rings before a call is answered can be changed (p. 81).
- This mode should not be used with a telephone line which is used for both voice and fax calls. When the unit answers the call, fax communication is attempted even if someone is trying to call you.
- To return to the TEL mode on Line 2, select "TEL" in step 5.

FAX ONLY mode ring count

This setting determines the number of rings before the unit answers a call in the FAX ONLY mode. You can set the number of rings for each line.

Line 1: Choose from 1 to 5 rings. If you use the unit with an answering machine, select "5 EXT.TAM" (p. 82–84).

Line 2: Choose from 1 to 4 rings.

Helpful hints:

- To answer a call before the unit does, increase the number of rings.
- If you have difficulty receiving faxes, the other parties may have tried to send faxes before confirming if your unit answered or not. Decrease the number of rings.

- 1 Press **MENU**.
Display: 1 . SYSTEM SET UP
- 2 Press **#**, then **0 6**.
FAX RING COUNT
- 3 Press **START/SET/COPY**.
LINE1=2 ▼▲
- 4 Select the desired number of rings for line 1 by pressing ▼ or ▲, or entering the number using the dial keypad.
- 5 Press **START/SET/COPY**.
LINE2=1 ▼▲
- 6 Select the desired number of rings for line 2 by pressing ▼ or ▲, or entering the number using the dial keypad.
- 7 Press **START/SET/COPY**.
SETUP ITEM []
- 8 Press **MENU**.

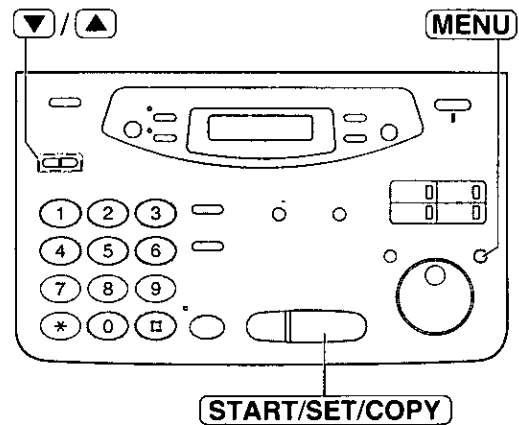

Note:

- If you subscribe to a Caller ID service, set the ring count setting to 2 or more rings (LINE 1 only).

Receiving Faxes

Using the unit with an answering machine

You can connect an answering machine to the unit. The answering machine can record voice messages coming from line 1.

Setting up the fax machine and an answering machine

- 1 Connect the answering machine to the EXT.L1 ONLY jack on the back of the fax machine.

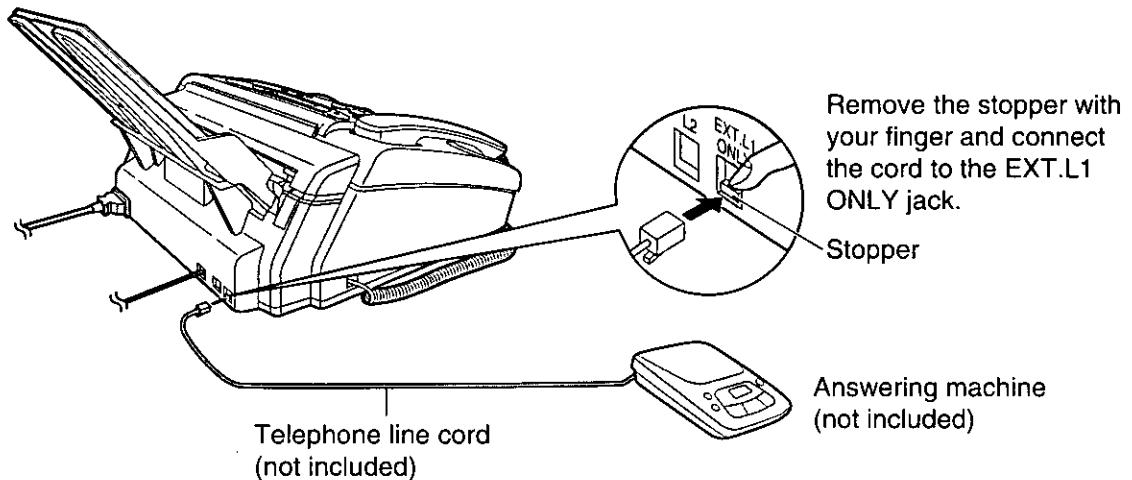

- 2 If you plan to use the FAX ONLY mode on the fax machine, set the number of rings on the answering machine to less than 4.
 - This will allow the answering machine to answer the call first.
- 3 Record a greeting message on the answering machine.

Example: "This is (your name, business and/or telephone number). We are unable to answer the phone right now. To send a fax, start transmission. To leave a message, please speak after the beep. Thank you."
- 4 Turn on the answering machine.
- 5 Set the receive mode of line 1 to the TEL mode (p. 78) or FAX ONLY mode (p. 79).
 - When you set the FAX ONLY mode, **set the FAX ONLY mode ring count for line 1 (feature setting #06) to "5 EXT.TAM"** (p. 81). The number of rings on the answering machine should be less than the FAX ONLY mode ring count so that the answering machine will answer a call first. Using the FAX ONLY mode will allow you to receive faxes if the answering machine is full.
- 6 Check the remote access code of your answering machine and program the same code into the remote operation ID of the fax machine (feature setting #12). See page 84.

Note:

- Do not pause for more than 4 seconds during the greeting message. If a 4-second pause is stored in the greeting message, all incoming calls will be routed to the unit from the answering machine even while the greeting message is playing.
- We recommend you keep the greeting message around 10 seconds long. If the greeting message is too long, some incoming fax calls may not be answered by the fax machine.
- Every time the unit receives a document, a silent pause or fax tone may be recorded on the answering machine.

How the fax machine and answering machine work

Receiving voice calls

The answering machine will record voice messages automatically.

Receiving fax calls

The fax machine will receive documents automatically.

Receiving a voice message and fax document in one call

The answering machine will record the voice message first. The fax machine will then be activated by the caller's request and receive the document. For further details, see page 84.

To use with an answering machine and computer, we recommend the following setup.

Always connect the fax machine directly to the wall jack.

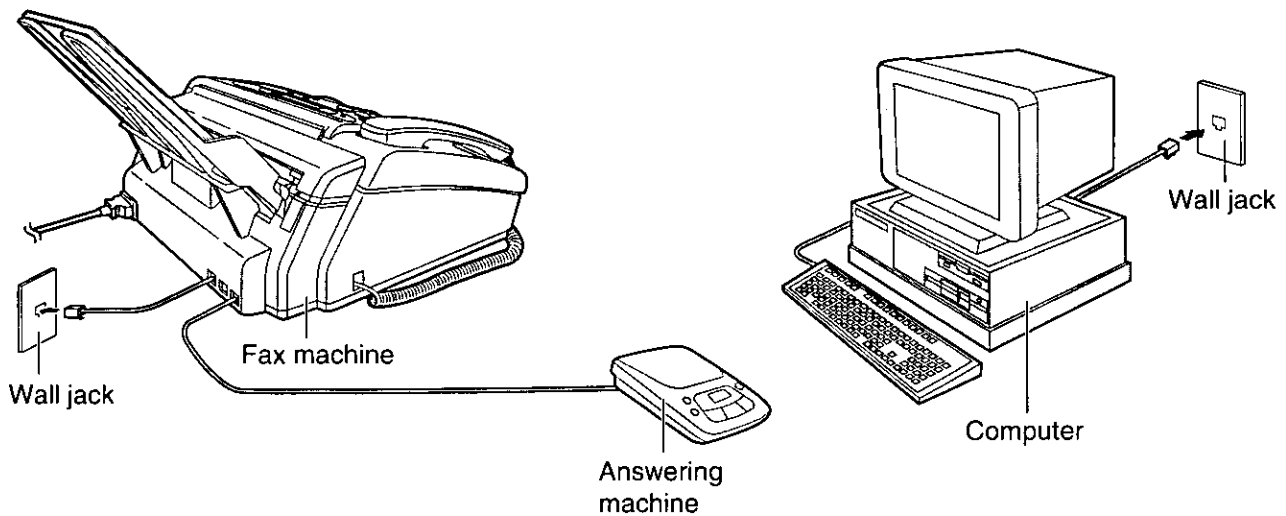

Note:

- Set the TEL mode on the fax machine.
- The device which has the shortest ring count will answer a call first. Confirm the ring count for each device.
- If you use your computer as an answering machine, connect the telephone line cord from the EXT.L1 ONLY jack on the back of the fax machine to the computer.

Receiving Faxes

Remote operation of your answering machine (remote activation ID)

Some answering machines will allow you to retrieve voice messages from a remote location. To deactivate the fax machine while you are checking your messages, set the remote activation ID code for the answering machine.

Important:

- This ID must be different from the fax activation code (p. 85).

- 1 Press **MENU**.
Display: 1. SYSTEM SET UP
- 2 Press **#**, then **1** **2**.
REMOTE TAM ACT.
- 3 Press **START/SET/COPY**.
MODE=OFF ▼▲
- 4 Press ▼ or ▲ to select "ON".
MODE=ON ▼▲
- 5 Press **START/SET/COPY**.
ID=11

- The display will show the pre-selected ID.

- 6 Enter your ID number.
 - This ID can be from 1 to 5 digits in length using 0-9, *, and #.

- 7 Press **START/SET/COPY**.
SETUP ITEM []

- 8 Press **MENU**.

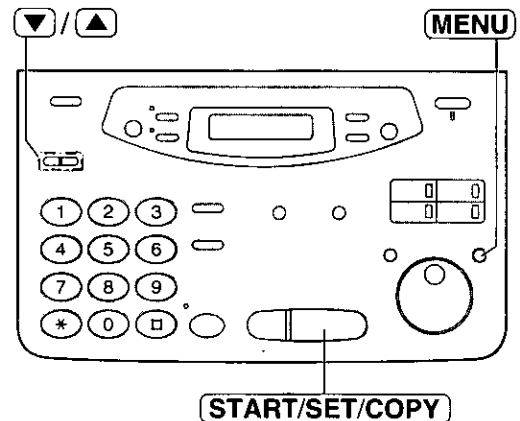

Receiving a voice message and fax document in one call

The caller can leave a voice message and send a fax document during the same call.

Inform the caller of the following procedures beforehand.

1. The caller calls your fax machine (line 1).
 - The answering machine will answer the call.
2. The caller can leave their message after the greeting message.
3. The caller presses *** 9** (pre-selected fax activation code).
 - The fax machine will activate the fax function.
4. The caller presses their start button to send a document.

Note:

- The fax activation code can be changed (p. 85).
- If the wrong fax activation code is entered, the caller must wait at least 5 seconds to reenter the correct code.

Extension telephone

You can connect an extension telephone to the EXT.L1 ONLY jack. When receiving a fax call using the extension telephone, you can activate the fax machine remotely using the extension telephone and receive fax documents. You do not have to press **START/SET/COPY** on the fax machine.

Important:

- Use a touch tone telephone as the extension telephone and enter the fax activation code **firmly**.
- You cannot answer a call coming from line 2 using the extension telephone.

1 When the extension telephone rings, lift the handset of the extension telephone.

2 When:
 —document reception is required,
 —a fax calling tone (slow beep) is heard, or
 —no sound is heard,
 press ***9** (pre-selected fax activation code) **firmly**.

3 Hang up the handset.
 • The unit will start reception.

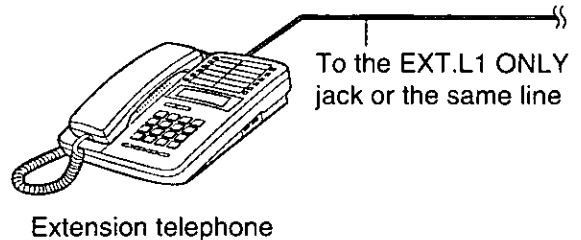

Note:

- You can change the fax activation code (see below).

Fax activation code

The fax activation code is required in the following cases;
 —to receive faxes using an extension telephone (see above).
 —to receive a voice message and fax document in the same call (p. 84).

Important:

- This code should be different from the remote activation ID (p. 84).

1 Press **MENU**.

Display: 1. SYSTEM SET UP

2 Press **#**, then **4** **1**.

FAX ACTIVATION

3 Press **START/SET/COPY**.

MODE=ON

4 Press **▼** or **▲** to select "ON".
 • If this feature is not required, select "OFF".

5 Press **START/SET/COPY**.

CODE=*9

- The display will show the pre-selected code.

6 Enter the new code.
 • This code can be from 2 to 4 digits in length using 0 – 9, and *.

7 Press **START/SET/COPY**.

SETUP ITEM []

8 Press **MENU**.

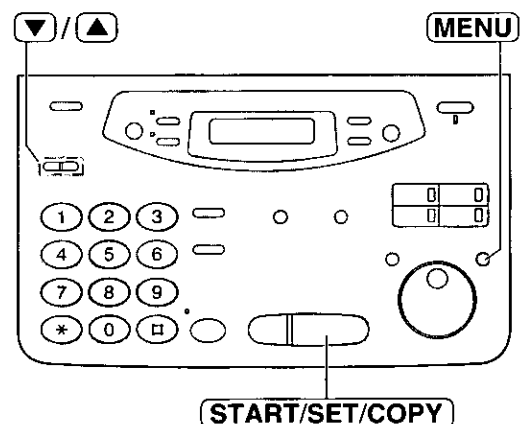

Note:

- If you subscribe to any special telephone company services which require a code, all or part of the fax activation code must be different from the service access code.
- The fax activation code should not be set to "0000".

Receiving Faxes

Distinctive Ring service --- --- (ring pattern detection feature)



This feature can only be used if you subscribe to a Distinctive Ring service from your telephone company. For more information on the availability of this service, contact your telephone company.

This feature will work regardless of the AUTO ANSWER or receive mode settings.

What is a Distinctive Ring service?

A Distinctive Ring service will give you up to 3 telephone numbers on a single telephone line, each having a different ring pattern.

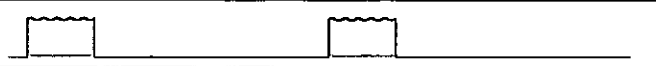
Ring patterns:

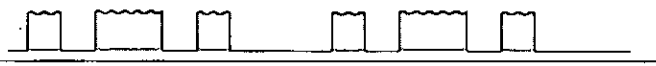
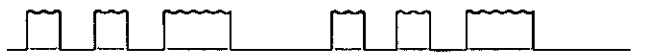
Standard ring (one long ring)	
Double ring (two short rings)	
Triple ring (short-long-short rings)	
Other triple ring (short-short-long rings)	

If you subscribe to a Distinctive Ring service, you can assign telephone numbers for personal numbers, business numbers, fax numbers, and so on.

When a call is received, you will know which number is being called by the ring pattern.

Example:

Your telephone number	Ring pattern	Use
012 1234	Standard ring	Personal
012 5678	Double ring	Business
012 9876	Triple ring	Facsimile

Using one of the telephone numbers as a facsimile number

Program the ring pattern assigned to the facsimile number (see next page).

When the unit detects a call matching the selected Distinctive Ring pattern, it will activate the fax function.

Note:

- The Distinctive Ring pattern can be programmed on one line (either line 1 or line 2).

Setting the Distinctive Ring pattern assigned for faxes

Select the ring pattern of the facsimile number that is assigned by your telephone company.

1 Press **MENU**.

Display: 1.SYSTEM SET UP

2 Press **#**, then **3 1**.

RING DETECTION

3 Press **START/SET/COPY**.

MODE=OFF ▼▲

4 Press ▼ or ▲ to select the line that has a number to be used as a facsimile number.
Example: Line 1 is selected.

MODE=LINE1 ▼▲

•If this feature is not required, select "OFF".

5 Press **START/SET/COPY**.

MODE=A ▼▲

6 Press ▼ or ▲ to select the ring pattern to be assigned to the facsimile number.

- A: Standard ring (one long ring)
- B: Double ring (two short rings)
- C: Triple ring (short-long-short rings)
- D: Other triple ring (short-short-long rings)

7 Press **START/SET/COPY**.

•When the distinctive ring pattern is set, the unit will print an information list.

PRINTING



SETUP ITEM []

8 Press **MENU**.

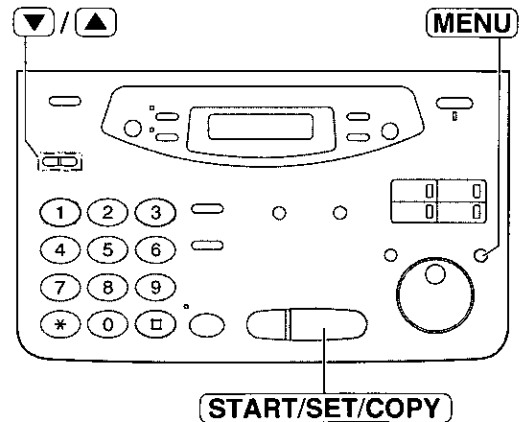

Note:

- The unit will automatically answer a Distinctive Ring call after the second ring regardless of the AUTO ANSWER, receive mode or ring count setting.
- If you have only 1 Distinctive Ring number, the most likely setting will be "B".

Receiving Faxes

TEL/FAX mode

(receiving voice calls with rings and fax calls without rings when you are near the unit)

Use this mode when you are always near the unit, are not using an answering machine, and want the fax machine to detect faxes without ringing. When a call is received on line 1, the unit will work as follows. If you have an extension telephone connected to the same line, see the next page.

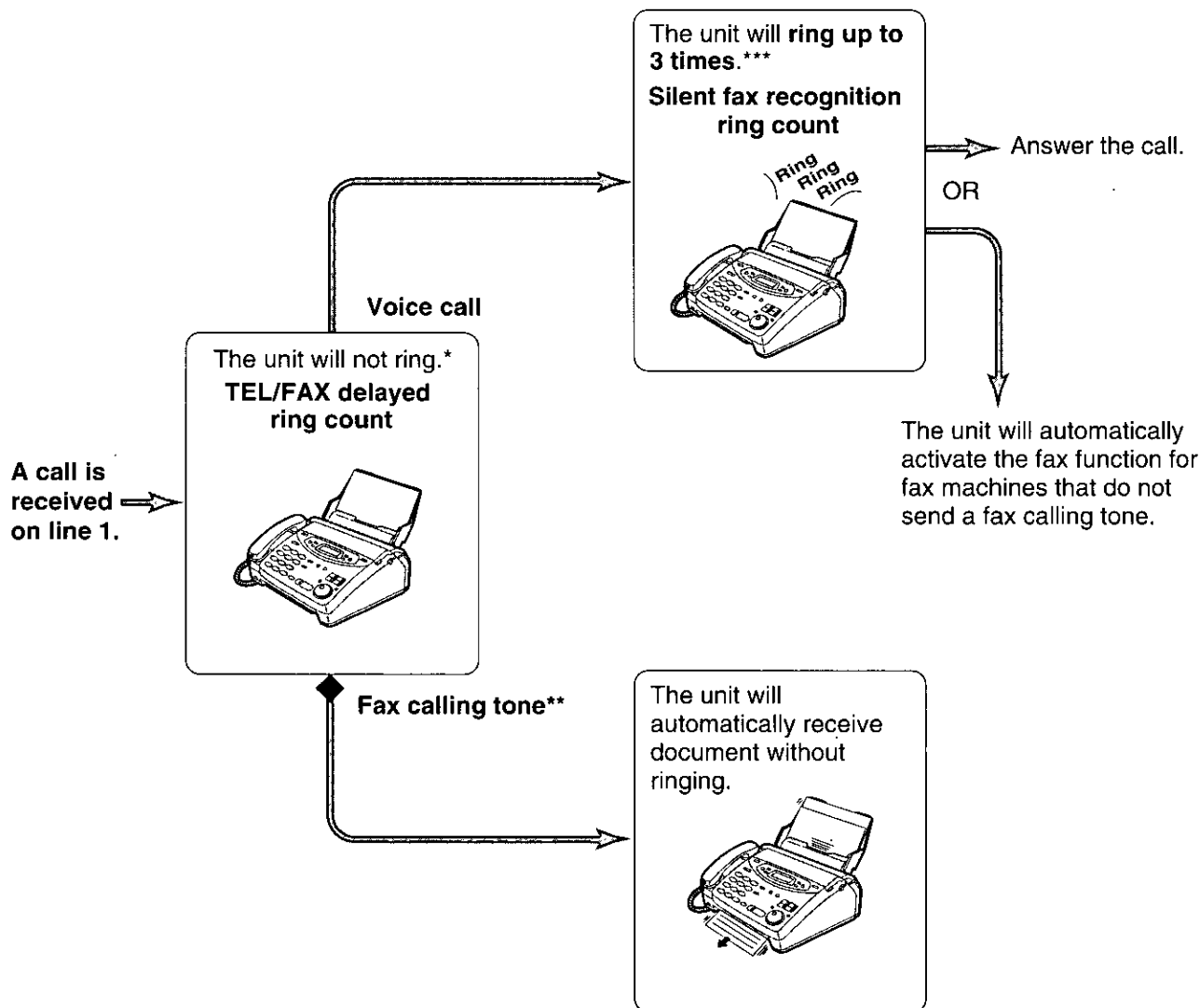

* A telephone fee will be charged to the caller from this point.

** A fax calling tone is automatically generated by the sending fax machine. Some fax machines do not have this capability.

*** While ringing, the unit will emit a different ring back tone to the calling party.

Note:

• The unit will display the following when a call is received.

Display: INCOMING CALL

• Some fax messages that are transmitted manually may not send a fax calling tone. These calls must be received manually.

• The ringer should be on (p. 38).

Ring pattern when an extension telephone is connected

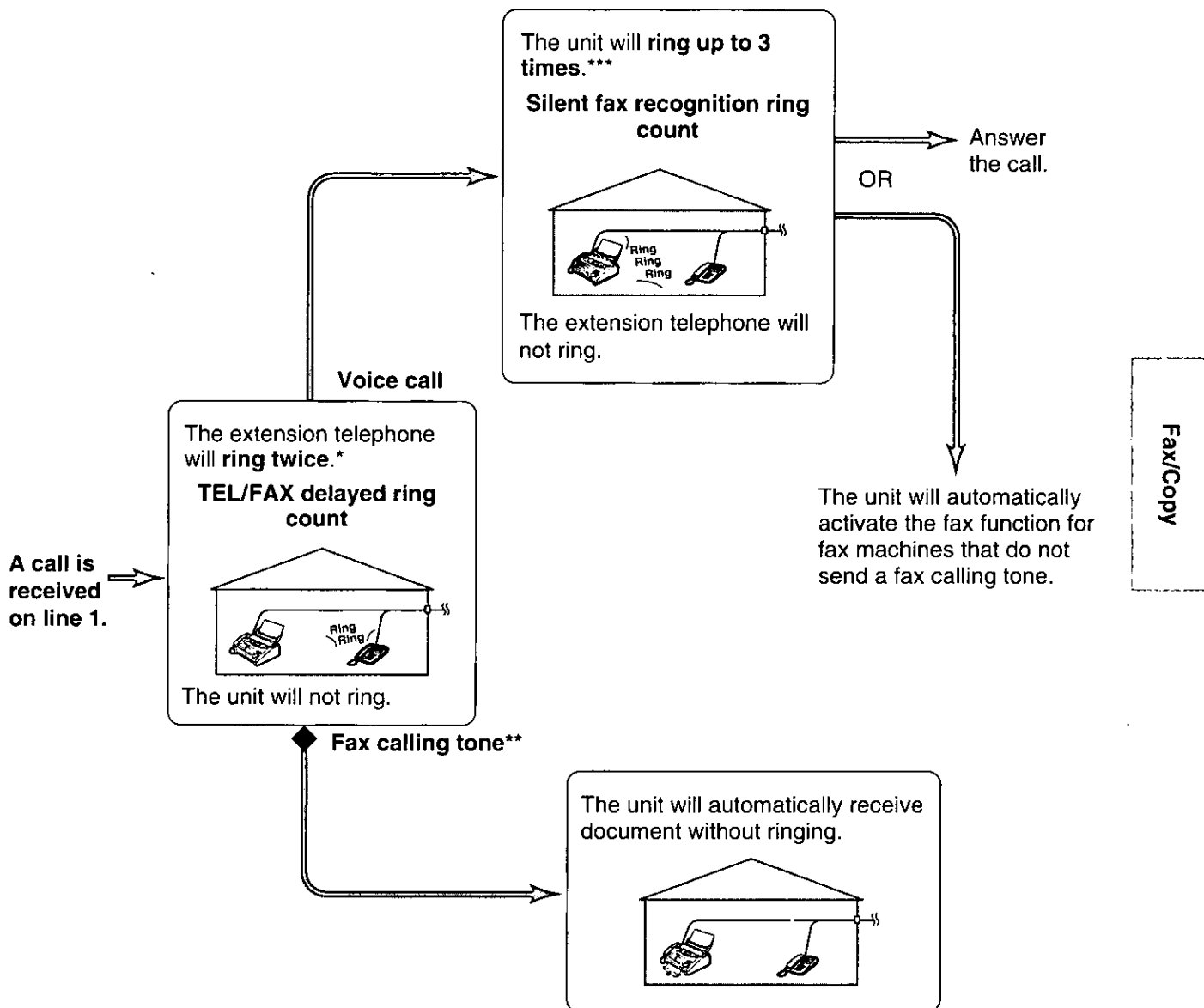

TEL/FAX delayed ring count:

Up to 4 ring signals will be generated before the unit answers, depending on feature setting #78 on page 91. In the TEL/FAX mode, the unit will not generate an audible ring during this time.

Silent fax recognition ring count:

The unit generates audible rings to indicate that it is receiving a voice call. 3 to 6 rings will be generated, depending on feature setting #30 on page 91. This signal will not ring at an extension telephone.

Receiving Faxes

Changing the AUTO ANSWER setting to the TEL/FAX mode

- 1 Press **MENU**.
Display: 1. SYSTEM SET UP
- 2 Press **#**, then **7 7**.
LINE SELECTION
- 3 Press **START/SET/COPY**.
LINE1=FAX ONLY ▼▲
- 4 Press ▼ or ▲ to select "TEL/FAX".
LINE1=TEL/FAX ▼▲
- 5 Press **START/SET/COPY**.
PRINTING
•The unit will print an information list.
LINE2=TEL ▼▲
- 6 Press **START/SET/COPY**.
SETUP ITEM []
- 7 Press **MENU**.
- 8 If the AUTO ANSWER light is off, turn it on by pressing **AUTO ANSWER**.
TEL/FAX MODE

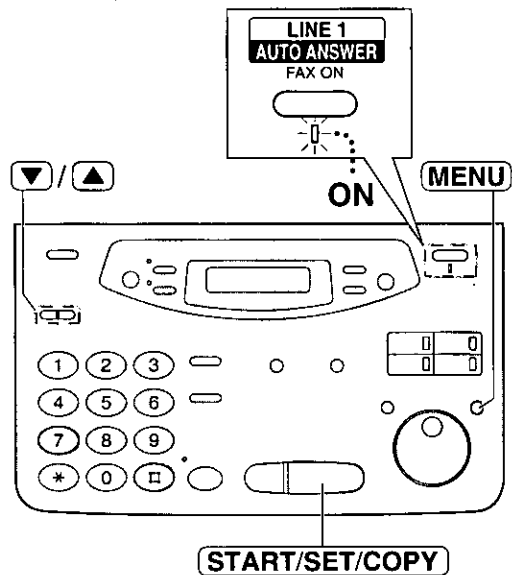

Note:

- To return to the FAX ONLY mode for line 1, select "FAX ONLY" in step 4.

We recommend the following setup.

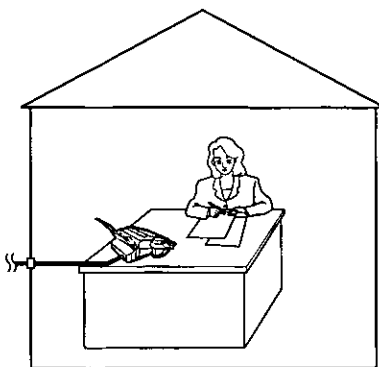

Only a fax machine is connected and you are always near the fax machine.

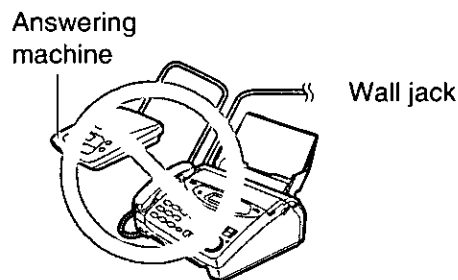

- Do not connect an answering machine when using the TEL/FAX mode.

TEL/FAX delayed ring count

This setting determines the number of times the extension telephone rings in the TEL/FAX mode. You can choose from 1 to 4 rings.

This setting does not need to be changed if an extension telephone is not connected.

- 1 Press **MENU**.
Display: 1. SYSTEM SET UP
- 2 Press **#**, then **7** **8**.
TEL/FAX RING
- 3 Press **START/SET/COPY**.
RING=2 ▼▲
- 4 Press ▼ or ▲ to select the desired number, or enter the number using the dial keypad.
- 5 Press **START/SET/COPY**.
SETUP ITEM []
- 6 Press **MENU**.

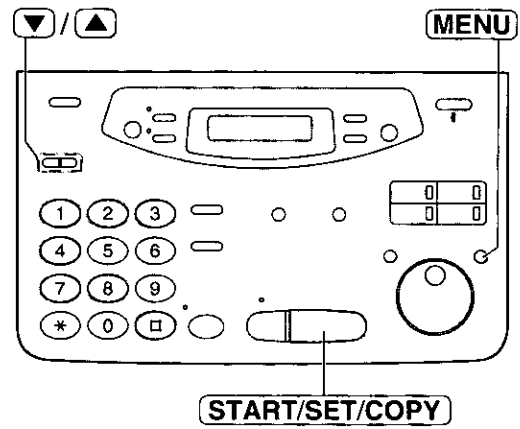

Note:

- If the number of rings is increased, you may not be able to receive document from some older model fax machines which do not send a fax calling tone.
- If you subscribe to a Caller ID service, set this ring count setting to 2 or more rings.

Fax/Copy

Silent fax recognition ring count

When the unit detects a voice call in the TEL/FAX mode, it will ring up to 3 times. The number of rings can be changed up to 6.

- 1 Press **MENU**.
Display: 1. SYSTEM SET UP
- 2 Press **#**, then **3** **0**.
SILENT FAX RING
- 3 Press **START/SET/COPY**.
RING=3 ▼▲
- 4 Press ▼ or ▲ to select the desired number, or enter the number using the dial keypad.
- 5 Press **START/SET/COPY**.
SETUP ITEM []
- 6 Press **MENU**.

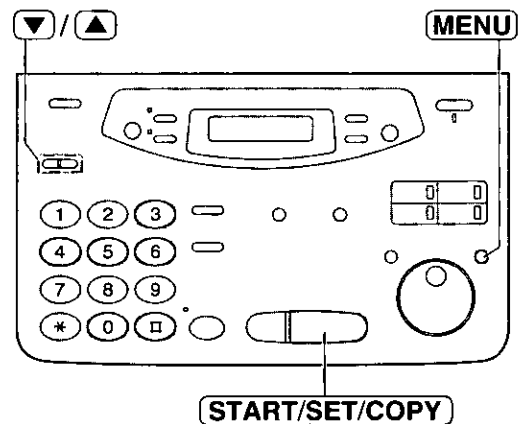

Note:

- If the number of rings is increased, you may not be able to receive document from some older model fax machines which do not send a fax calling tone.

Receiving Faxes

Other size documents

When the size of the document sent by the other party is as large as, or larger than the recording paper, the unit can reduce each page of the document and print it out on the recording paper by programming a suitable reduction rate.

The reduction rate is determined by a combination of the size of the recording paper and received document.

Recommended reduction rates:

Mode	Size of recording paper	Size of original document
100%	Legal	Letter, A4
92% (pre-selected)	Letter	Letter
	Legal	Legal
86%	Letter	A4
72%	Letter	Legal

Letter = 216 mm × 279 mm (8½" × 11")

Legal = 216 mm × 356 mm (8½" × 14")

A4 = 210 mm × 297 mm (May not be available in the United States.)

1 Press **MENU**.

Display: 1.SYSTEM SET UP

2 Press **#**, then **3** **6**.

RCV REDUCTION

3 Press **START/SET/COPY**.

MODE=92% ▼▲

4 Press ▼ or ▲ to select the desired setting.

- If this feature is not required, press ▲ to select "100%".

5 Press **START/SET/COPY**.

SETUP ITEM []

6 Press **MENU**.

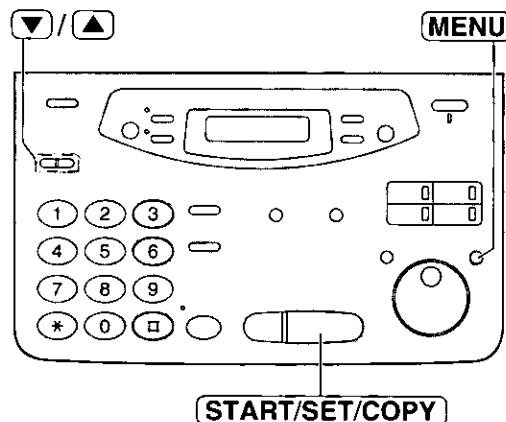

Note:

- Document usually has a heading on the top of each page which contains the sender's name/telephone number. This increases the length of each page. Therefore using the reduction mode is recommended.
- If the appropriate reduction rate is not programmed, the document will be divided.

Silent detection --- ---

(receiving faxes from older model fax machines)

This feature allows the unit to activate the fax function automatically if a silent pause longer than 4 seconds is detected when using an answering machine.

Helpful hints:

- If you wish to receive document from fax machines that do not send a fax calling tone, activate this feature.
- If you use an answering machine to give greeting messages and record incoming messages on a single cassette tape, deactivate this feature.

- 1 Press **MENU**
Display: 1.SYSTEM SET UP
- 2 Press **#**, then **4** **0**.
SILENT DETECT.
- 3 Press **START/SET/COPY**.
MODE=OFF ▼▲
- 4 Press ▼ or ▲ to select the desired setting.
- 5 Press **START/SET/COPY**.
SETUP ITEM []
- 6 Press **MENU**.

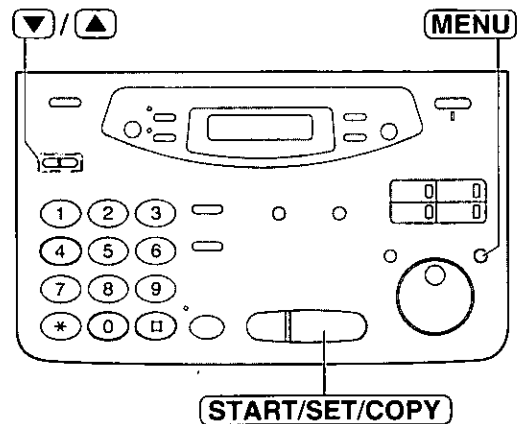

Memory reception alert --- ---

When received document is stored into memory due to a problem, the unit will alert you with beep tones. If you hear slow beeps, clear the printing problem or supply paper to print the stored document. The beep tones will stop.

- 1 Press **MENU**.
Display: 1.SYSTEM SET UP
- 2 Press **#**, then **4** **4**.
RECEIVE ALERT
- 3 Press **START/SET/COPY**.
MODE=ON ▼▲
- 4 Press ▼ or ▲ to select the desired setting.
• If this feature is not required, select "OFF".
- 5 Press **START/SET/COPY**.
SETUP ITEM []
- 6 Press **MENU**.

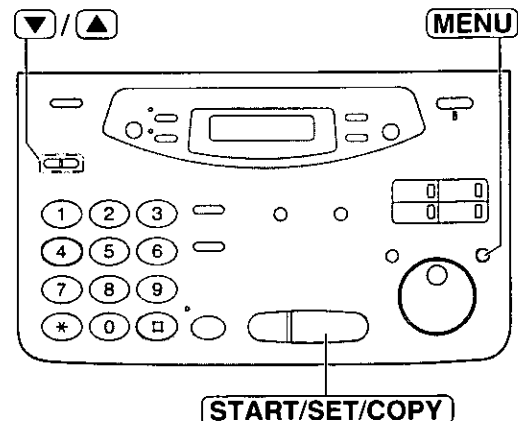

Receiving Faxes

Friendly reception

The friendly reception feature allows you to receive fax document automatically without pressing **START/SET/COPY** (p. 78).

When this feature is deactivated, you have to press **START/SET/COPY** to receive fax document each time you answer a fax call.

- 1** Press **MENU**.
Display: 1.SYSTEM SET UP
- 2** Press **#**, then **4** **6**.
FRIENDLY RCV
- 3** Press **START/SET/COPY**.
MODE=ON ▼▲
- 4** Press ▼ or ▲ to select the desired setting.
• If this feature is not required, select "OFF".
- 5** Press **START/SET/COPY**.
SETUP ITEM []
- 6** Press **MENU**.

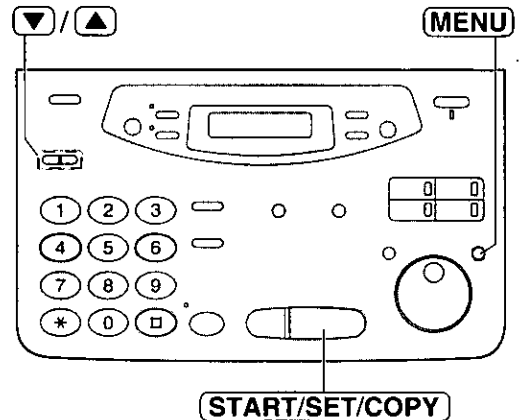

Pager call - when your unit receives a fax

This feature allows your unit to call your pager when your unit receives a fax document.

- 1 Press **MENU**.
Display: 1. SYSTEM SET UP
- 2 Press **#**, then **7 0**.
FAX PAGER CALL
- 3 Press **START/SET/COPY**.
MODE=OFF
- 4 Press **▼** or **▲** to select "ON".
MODE=ON
- 5 Press **START/SET/COPY**.
NO. =
- 6 Enter your pager number.
• You can enter a total of 46 digits and/or pauses.
- 7 Press **START/SET/COPY**.
• The unit will dial the stored number.
- 8 Confirm if the message is displayed on your pager.
- 9 Press **MONITOR**.
- 10 If the AUTO ANSWER light is off, turn it on by pressing **AUTO ANSWER**.

• If this feature is not required, select "OFF".

- 5 Press **START/SET/COPY**.
NO. =

- 6 Enter your pager number.
• You can enter a total of 46 digits and/or pauses.

Example:

1 202 555 1234 PPP 12345678 PPP 5555 #

Your pager number

Pauses

Your pager access code, if required.

Message you want displayed on your pager when your unit receives a fax.

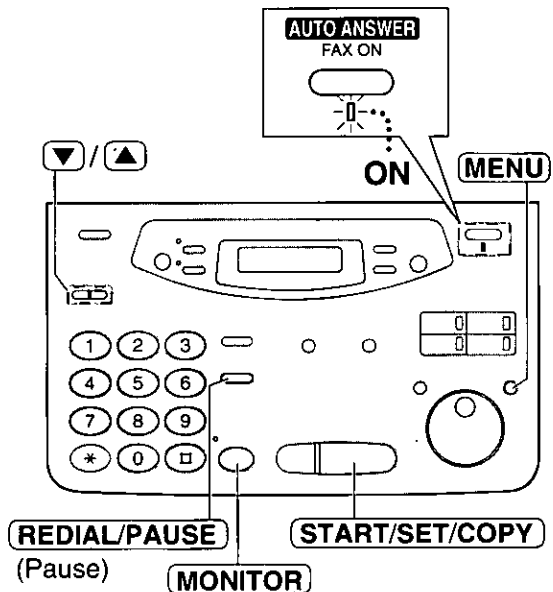

Fax/Copy

How your unit and pager work

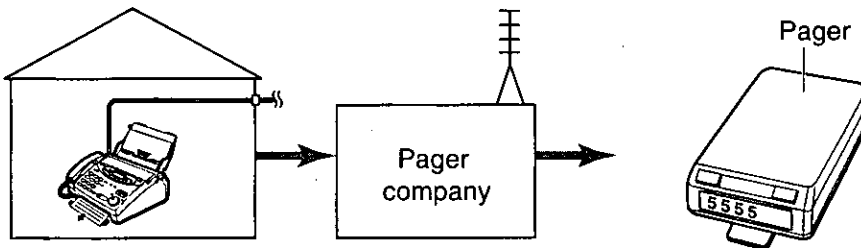

When your unit receives a fax document, it will call your pager company.

Your pager company will call your pager.

A few minutes later, your pager will display the same message you entered in step 6 above.

(For example: 5555)

If you have subscribed to a Caller ID service and the Caller ID information (telephone number) is received, your pager will display the telephone number (LINE 1 only).

Receiving Faxes

Film detection

If this feature is activated, the display will show the following message when the remaining film will only print about 15 letter size document.

Display: FILM NEAR EMPTY

- If you are using regular film cartridge with 100 m (328') roll (p. 15) when the above message is displayed, the unit will also print a report.

1 Press **MENU**.

Display: 1.SYSTEM SET UP

2 Press **#**, then **7** **9**.

FILM DETECTION

3 Press **START/SET/COPY**.

MODE=ON ▼▲

4 Press ▼ or ▲ to select the desired setting.
• If this feature is not required, select "OFF".

5 Press **START/SET/COPY**.

SETUP ITEM []

6 Press **MENU**.

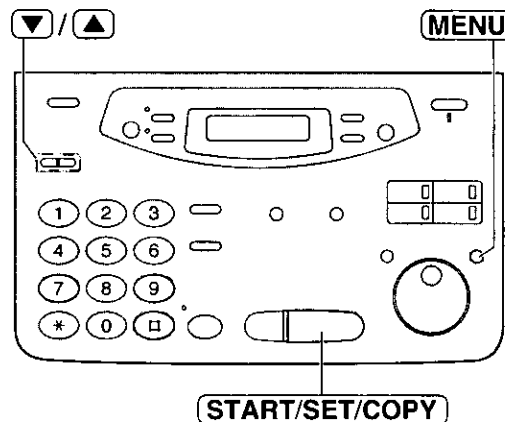

Making a copy

The unit can make single or multiple copies (up to 99). Any transmittable document (p. 59) can be copied.

- 1** Open the document feeder tray.
- 2** Adjust the width of the document guides to the size of the document.
- 3** Insert the document (up to 15 pages) **FACE DOWN** until a single beep is heard and the unit grabs the document.

Display: STANDARD

- Make sure the handset is on the cradle.

- 4** If necessary, press **RESOLUTION** repeatedly to select the desired setting (p. 59).

- 5** Press **START/SET/COPY**.

NUMBER=1 [100%]

- 6** Enter the number of copies (up to 99).

- 7** If necessary, choose an enlargement/reduction rate by rotating **JOG DIAL**. See next page.

- 8** If you want to print collated copies, press **COLLATE** until the following is displayed (see below).

COLLATE=ON

- 9** Press **START/SET/COPY**.
 - The unit will start printing.
 - OR
 - Press **QUICK SCAN** if you want to remove the copy document for other uses.
 - The unit will feed the document and scan it into memory, then start printing.

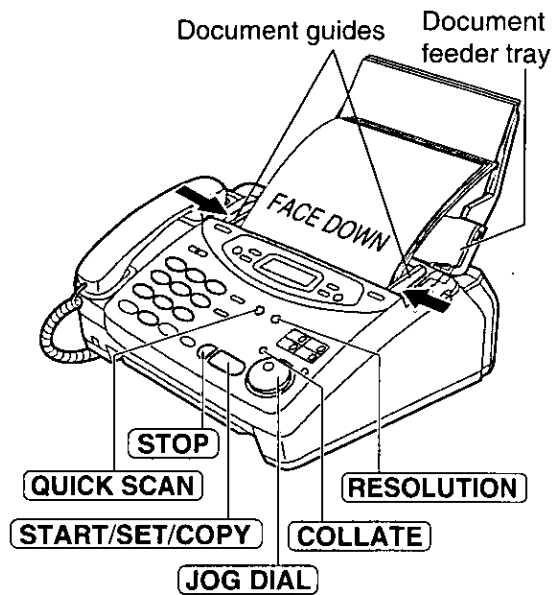

Note:

- If a resolution is not selected, FINE resolution will be selected automatically.
- You can make or receive a voice call while making copies.
- After copying, the enlargement/reduction rate setting will return to "100%".

To stop copying

Press **STOP**.

Printing collated copies

The unit will print uncollated copies. You can also print collated copies. See the example below.

Example: Making two copies of a 4 page original document

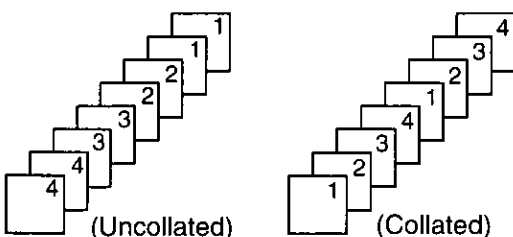

Note:

- If you turn the collating feature on, the unit will store the document into memory and print it. If memory becomes full while storing, the unit will only print out the stored pages.
- After copying, the collating feature will turn off automatically.

Copying

Choosing an enlargement/reduction rate

The unit can make enlarged or reduced copies of a document.

■ To enlarge a document:

Select "200%" or "150%" by rotating **JOG DIAL** to the right. The unit will only enlarge the center part of the document and print it on two pages. See the examples below.

Sample of an enlarged copy:

● 200% example

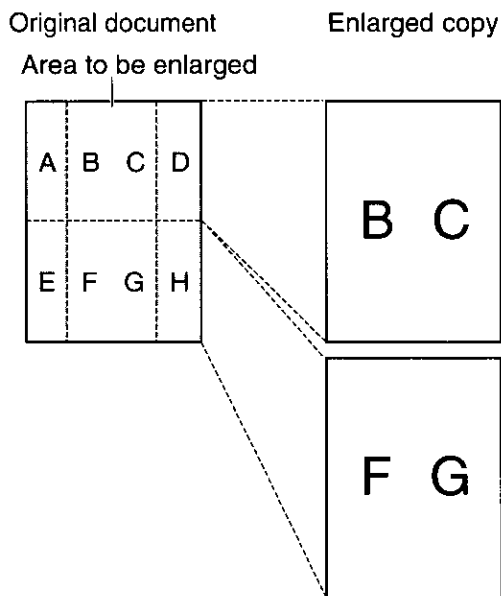

● 150% example

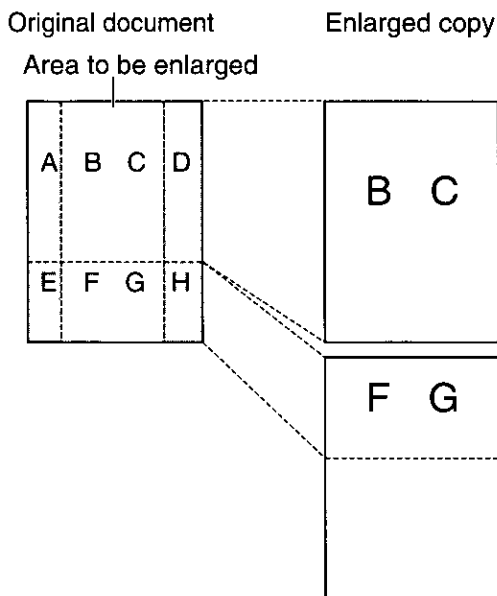

■ To reduce a document:

When you copy document that is longer than the recording paper, the unit can reduce the original document by programming a suitable reduction rate. The reduction rate is determined by the size of the recording paper and original document. Select from 92%, 86% and 72% by rotating **JOG DIAL** to the left.

Recommended reduction rates:

Mode	Size of recording paper	Size of original document
100% (pre-selected)	Letter	Letter
	Legal	Letter, A4, Legal
92%	Letter	A4
86%	Letter	A4
72%	Letter	Legal

Letter = 216 mm × 279 mm (8½" × 11")

Legal = 216 mm × 356 mm (8½" × 14")

A4 = 210 mm × 297 mm (May not be available in the United States.)

Note:

- If the appropriate reduction rate is not programmed, the document may be divided and the top of the second sheet will be deleted.

Reports

If your unit cannot send a fax, check the following.

—The number you dialed is correct.

—The other party's machine is a facsimile.

If the problem remains, correct it by following the communication message printed on the sending and journal reports (p. 66, 67).

Communication message	Error code	Cause & Remedy
COMMUNICATION ERROR	41-72 FF	<ul style="list-style-type: none"> •A transmission or reception error occurred. Try again or check with the other party.
DOCUMENT JAMMED	—	<ul style="list-style-type: none"> •The document is jammed. Remove the jammed document (p. 108).
ERROR-NOT YOUR UNIT	54, 59 70	<ul style="list-style-type: none"> •A transmission or reception error occurred because of a problem with the other party's fax machine. Check with the other party.
MEMORY FULL	—	<ul style="list-style-type: none"> •The document was not received due to memory being full.
NO DOCUMENT	—	<ul style="list-style-type: none"> •The document was not fed into the unit properly. Reinsert the document and try again.
OTHER FAX NOT RESPOND	—	<ul style="list-style-type: none"> •The other party's fax machine was busy or ran out of recording paper. Try again. •The document was not fed properly. Reinsert the document and try again. •The other party's fax machine rings too many times. To send a fax manually, dial the number, confirm the fax tone, and press START/SET/COPY. •The other party's machine is not a facsimile. Check with the other party. •The number you dialed is not in service.
PRESSED THE STOP KEY	—	<ul style="list-style-type: none"> •The STOP button was pressed and fax communication was canceled.
THE COVER WAS OPENED	—	<ul style="list-style-type: none"> •The cover was opened. Close it and try again.
OK	—	<ul style="list-style-type: none"> •Fax communication was successful.

Error Messages

Display

If the unit detects a problem, one or more of the following messages will appear on the display.

Display message	Cause & Remedy
CALL SERVICE	• There is something wrong with the unit. Contact our service personnel.
CHECK COVER	• The cover is open. Close it.
CHECK DOCUMENT	• The document is not fed into the unit properly. Reinsert the document. If misfeeding occurs frequently, clean the document feeder rollers and try again (p. 109). If the problem remains, adjust the feeder pressure (p. 108).
CHECK FILM	• The film cartridge is not installed. Install it (p. 109, 110).
CHECK MEMORY	• Memory (telephone numbers, parameters, etc.) has been erased. Re-program.
CHECK PAPER	• The recording paper is not installed or the unit has run out of paper. Install paper and press START/SET/COPY to clear the message. • The recording paper is not fed into the unit properly or has jammed near the recording paper entrance. Clear the jammed paper and press START/SET/COPY to clear the message (see "When paper has jammed near the recording paper entrance" on page 107). Do not install folded or heavily curled paper in the paper tray.
FAX IN MEMORY	• The unit has a document in memory. See the other displayed message instructions to print out the document.
FAX MEMORY FULL	• Memory is full of received document due to a lack of recording paper or a recording paper jam etc. Install paper or clear the jammed paper. • When performing memory transmission, the document being stored exceeds the memory capacity of the unit. Transmit the entire document using manual or automatic transmission.
FILM EMPTY	• The film is empty. Replace the film cartridge (p. 109, 110). • The film is slack. Tighten it (see step 4 on page 110) and install again.
FILM NEAR EMPTY	• The remaining film can print about 15 pages of letter size document. Prepare a new film cartridge (p. 15).
FREE FILM EMPTY	• The free starter film is empty. Replace the film cartridge (p. 109, 110).
JOG-DIAL FULL	• There is no space to store new stations in the JOG DIAL directory. Edit or erase unnecessary stations (p. 47, 48).
LOADING ERROR	• A loading error occurred while receiving data from FaxSav. Contact FaxSav at 1-888-332-9728.
MEMORY FULL	• When making copy, the document being stored exceeds the memory capacity of the unit. Press STOP to clear the message.
MODEM ERROR	• There is something wrong with the modem circuit. Contact our service personnel.

Error Messages

Display message	Cause & Remedy
NO FAX REPLY	<ul style="list-style-type: none">•The other party's fax machine is busy or has run out of recording paper. Try again.
PAPER JAMMED	<ul style="list-style-type: none">•A recording paper jam occurred under the film cartridge. Clear the jammed paper (p. 106).
PLEASE WAIT	<ul style="list-style-type: none">•The unit is checking that there is no slack on the film. Wait a while.
REDIAL TIME OUT	<ul style="list-style-type: none">•The other party's fax machine is busy or has run out of recording paper. Try again.
REMOVE DOCUMENT	<ul style="list-style-type: none">•The document is jammed. Remove the jammed document (p. 108).•Attempted to transmit a document longer than 600 mm (23⁵/₈"). Press the STOP button to remove the document. Divide the document into two or more sheets and try again.
TRANSMIT ERROR	<ul style="list-style-type: none">•A transmission error occurred. Try again.
UNIT OVERHEATED	<ul style="list-style-type: none">•The unit is too hot. Let the unit cool down.

Help

Operations

When a function does not work, check here before requesting help

General

Problem	Cause & Remedy
I cannot make and receive calls.	<ul style="list-style-type: none">•The power cord or telephone line cord(s) is not connected. Check the connections (p. 25–27).
I cannot make calls.	<ul style="list-style-type: none">•The dialing mode setting is wrong. Change to “TONE” or “PULSE” (p. 33).
The unit does not work.	<ul style="list-style-type: none">•Disconnect the unit from the telephone line and connect the line to a known working telephone. If the working telephone operates properly, contact our service personnel to have the unit repaired. If the working telephone does not operate properly, contact your telephone company.
The unit does not ring.	<ul style="list-style-type: none">•The ringer volume is set to off. Adjust it to a suitable level (p. 38).
The unit displays “CHECK PAPER” though the paper is inserted.	<ul style="list-style-type: none">•The paper is inserted halfway. Insert it correctly (p. 23, 24) and press START/SET/COPY to clear the message.
The other party complains they only hear a fax tone and cannot talk.	<ul style="list-style-type: none">•The FAX ONLY mode is set. Tell them the number is only used for faxes or change to another mode on your unit (p. 74–77).
The REDIAL/PAUSE button does not function properly.	<ul style="list-style-type: none">•If this button is pressed during dialing, a pause will be inserted. If pressed immediately after a dial tone is obtained, the last number dialed will be redialed.
The receive mode does not function as explained on pages 74–77.	<ul style="list-style-type: none">•A Distinctive Ring pattern is set (p. 86, 87).•The TEL/FAX mode is set (p. 88–91).
During programming, I cannot enter a code or ID number.	<ul style="list-style-type: none">•All or part of the numbers are the same. Change the number (p. 84, 85).
The film runs out quickly.	<ul style="list-style-type: none">•The HELP button, copy function, and reports use more film.

Fax – sending

Problem	Cause & Remedy
I cannot send document.	<ul style="list-style-type: none">•The telephone line cord is connected to the EXT.L1 ONLY jack on the unit. Connect to L1/L2 or L2 jack (p. 25, 26).•The other party's fax machine is busy or has run out of paper. Try again.•The other party's machine is not a facsimile. Check with the other party.•The other party's fax machine rings too many times. Send the fax manually – dial the number, confirm the fax tone, then press START/SET/COPY.
The other party complains that letters on their received document are distorted.	<ul style="list-style-type: none">•If your line has special telephone services such as call waiting, the service may have been activated during fax transmission. Connect the unit to a line that does not have these services.•The extension telephone on the same line is off the hook. Hang up the extension telephone and try again.

Fax – sending (cont.)

Problem	Cause & Remedy
The other party complains that dirty patterns or black lines appear on their received document.	<ul style="list-style-type: none"> •The glass or rollers are dirty. Clean them (p. 111).
I cannot make an international fax call.	<ul style="list-style-type: none"> •Use the overseas transmission mode (p. 73). •Add two pauses at the end of the telephone number (p. 43) or dial manually.

Fax – receiving

Problem	Cause & Remedy
I cannot receive document.	<ul style="list-style-type: none"> •The telephone line cord is connected to the EXT.L1 ONLY jack on the unit. Connect to the L1/L2 or L2 jack (p. 25, 26).
I cannot receive document automatically.	<ul style="list-style-type: none"> •The receive mode is set to the TEL mode. Set to the FAX ONLY. •The time taken to answer a call is too long. Decrease the number of rings (p. 81, 91).
The display shows “CONNECTING.....” but faxes are not received.	<ul style="list-style-type: none"> •The incoming call is not a fax. Change the receive mode to the TEL mode.
The recording image is faint.	<ul style="list-style-type: none"> •The sender transmitted a faint document. Ask them to transmit a clearer copy of the document. •The thermal head is dirty. Clean it (p. 111).
The printing quality is poor.	<ul style="list-style-type: none"> •Some paper has instructions recommending which side to print on. Try turning the paper over. We recommend smooth paper such as Hammermill® Jet Print for clearer printing.
A blank sheet is ejected after the received document is printed out.	<ul style="list-style-type: none"> •The receiving reduction rate is not programmed correctly. Program the proper rate (p. 92).

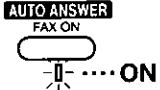
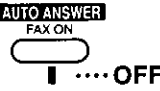

Receive mode

Problem	Cause & Remedy
I cannot select the desired receive mode.	<p>For LINE 1:</p> <ul style="list-style-type: none"> •If you want to set the FAX ONLY or TEL/FAX mode: <ul style="list-style-type: none"> —Select the desired mode using feature #77 (p. 90), and —Press AUTO ANSWER to turn on the AUTO ANSWER light.  <ul style="list-style-type: none"> •If you want to set the TEL mode: <ul style="list-style-type: none"> —Press AUTO ANSWER to turn off the AUTO ANSWER light.  <p>For LINE 2:</p> <ul style="list-style-type: none"> •Select either TEL or FAX ONLY mode using feature #77 (p. 80).

Help

Operations

Copying

Problem	Cause & Remedy
The unit does not make a copy.	<ul style="list-style-type: none"> You cannot make a copy during programming. Make the copy after programming or stop the programming.
A dirty pattern or a black line appears on the copied document.	<ul style="list-style-type: none"> The glass or rollers are dirty. Clean them (p. 111).
The copied image is distorted.	<ul style="list-style-type: none"> The thermal head is dirty. Clean it (p. 111).
The printing quality is poor.	<ul style="list-style-type: none"> Some paper has instructions recommending which side to print on. Try turning the paper over. We recommend smooth paper such as Hammermill® Jet Print for clearer printing.
The printing is faint. <div style="display: flex; justify-content: space-around; align-items: center;"> <div style="text-align: center;"> <p>Original</p>  </div> <div style="text-align: center;"> <p>Copy</p>  </div> </div>	<ul style="list-style-type: none"> You may have used paper with a cotton and/or fiber content that is over 20%, such as letterhead or resume paper. We recommend smooth paper such as Hammermill® Jet Print for clearer printing.

Using an answering machine

Problem	Cause & Remedy
I cannot receive document automatically.	<ul style="list-style-type: none"> Your greeting message on the answering machine is too long. Shorten the message (up to 10 seconds). The answering machine rings too many times. Set to 1 or 2 rings. The silent detection feature is deactivated. Activate this feature (p. 93).
I cannot receive voice messages.	<ul style="list-style-type: none"> Check if the answering machine is turned on and connected to the unit properly (p. 82). Set the number of rings on the answering machine to 1 or 2.
I cannot retrieve recorded voice messages on the answering machine from a remote location.	<ul style="list-style-type: none"> The remote access code on your answering machine is the same as your fax activation code. Set a different number for each code. You did not program your remote access code in your fax machine correctly. Program the same code that is programmed on the answering machine (p. 84).
The greeting message on your answering machine is interrupted halfway and the caller cannot leave a voice message.	<ul style="list-style-type: none"> The greeting message has a silent pause longer than 4 seconds. Re-record the greeting message.
I pressed the remote access code to access the answering machine remotely, but the line was disconnected.	<ul style="list-style-type: none"> The code may include “#” which is used for certain features provided by the telephone company. Change the code on the answering machine to another number which does not include “#” (p. 84).
Callers complain that their voice message is interrupted halfway and they cannot leave a message.	<ul style="list-style-type: none"> Advise the caller not to pause for over 4 seconds while recording their voice message.

Using an answering machine (cont.)

Problem	Cause & Remedy
Callers complain that they cannot send a document.	<ul style="list-style-type: none"> ● Your answering machine ran out of recording tape. Rewind the tape to record messages. ● You set the answering machine to only give a greeting message.
When I answer a call with the extension telephone, the unit switches to the fax mode and I cannot talk with the other party.	<ul style="list-style-type: none"> ● You paused for over 4 seconds during the conversation. To resume the conversation, press the STOP button on the unit.

If a power failure occurs

- The unit will not function.
- Transmission and reception will be interrupted.
- If fax document is stored in memory, they will be lost. When power is restored, a power down report will be printed out stating which contents in memory have been erased.
- If delayed transmission is programmed and the start time has passed during a power failure, transmission will be attempted soon after power is restored.
- If an extension telephone/answering machine is connected to the unit, you can use it during a power failure.

Power down report

The power down report will be automatically printed out after power is restored.
The report will not be printed out if there are no documents stored in memory.

Sample of a power down report

POWER DOWN REPORT				
			POWER DOWN AT: Jan. 05 1999 04:30AM	
			RESTARTED AT: Jan. 05 1999 04:31AM	
<< WARNING >> CONTENTS HAVE BEEN CLEARED DUE TO POWER DOWN. FOR ADDITIONAL INFORMATION, PLEASE SEE THE JOURNAL REPORT.				
NO.	OTHER FACSIMILE	MODE	PAGES	FUNCTION
01	<FAX # NOT AVAIL.>	RCV	01	MEMORY RECEIVE

Help

Recording paper jams

If the unit does not eject any recording paper during reception or copying, the recording paper has jammed. Remove the jammed paper.

When paper has jammed under the film cartridge

The display will show the following message.

Display: PAPER JAMMED

Remove the jammed paper as follows.

1 Open the cover by pressing the cover open button.

2 Remove the film cartridge.

3 Remove the jammed recording paper.

4 If the film is slack, turn the film cartridge over and tighten it by winding the gears.

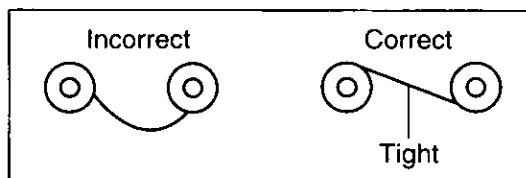

5 Turn the film cartridge over so that the "BACK" is facing up.

6 Replace the film cartridge by first placing the front of the cartridge into the unit and then lowering the "BACK" of the cartridge into place.

7 Close the cover securely by pushing down on the dotted area at both ends.

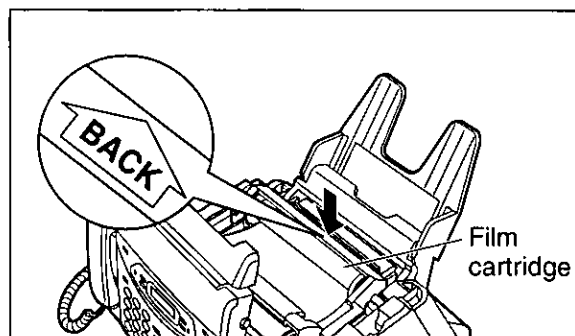
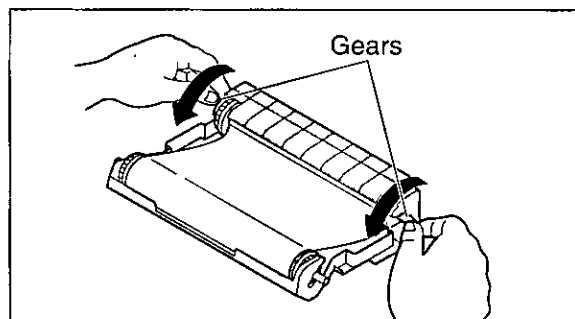
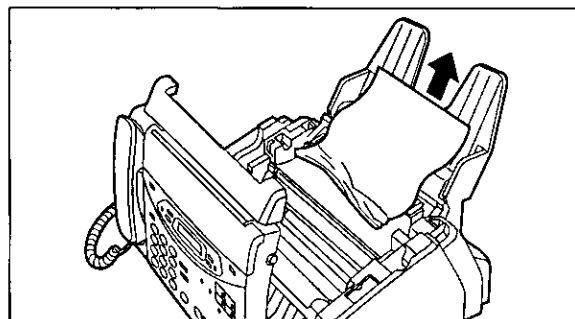
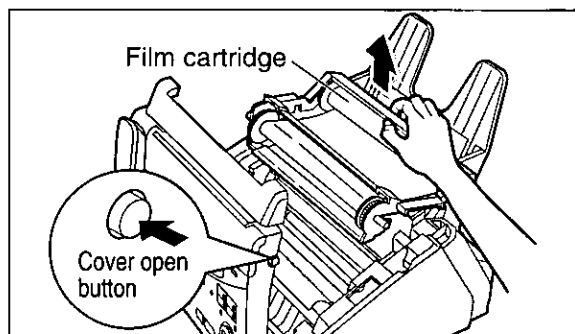

When paper has jammed near the recording paper entrance

The display will show the following message.

Display: CHECK PAPER



PRESS START

Remove the jammed paper as follows.

- 1** Pull the tension bar forward and hold open while pulling out the jammed recording paper from the recording paper entrance.
- 2** Press START/SET/COPY to clear the message.

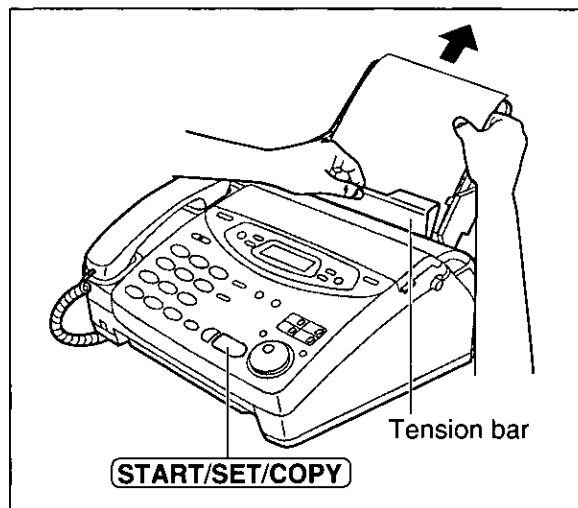

When paper has not been ejected even though “PAPER JAMMED” or “CHECK PAPER” is not displayed

Confirm the recording paper exit. If there is any jammed paper, remove it as follows.

- 1** Tilt the unit up and pull the jammed recording paper out of the recording paper exit.
- 2** Remove the jammed recording paper from the recording paper exit.
 - If you cannot remove the jammed paper, remove it by following the instructions on page 106.

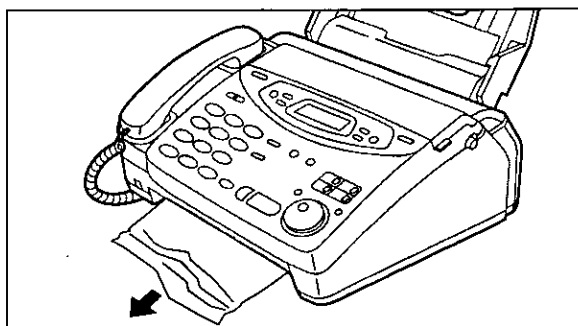
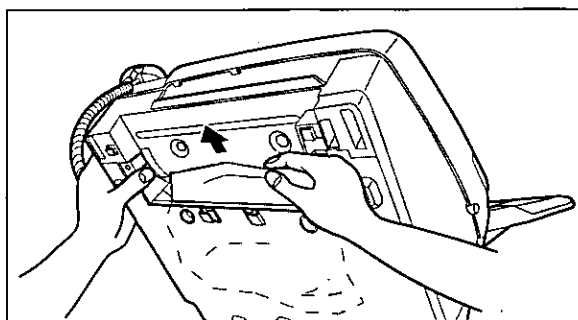

Sending document jams

If the unit does not release the document during feeding, remove the jammed document as follows.

- 1** Open the cover by pressing the cover open button.
- 2** Remove the jammed document carefully.
- 3** Close the cover securely by pushing down on the dotted area at both ends.

Note:

- Do not forcibly pull out the jammed paper before opening the cover.

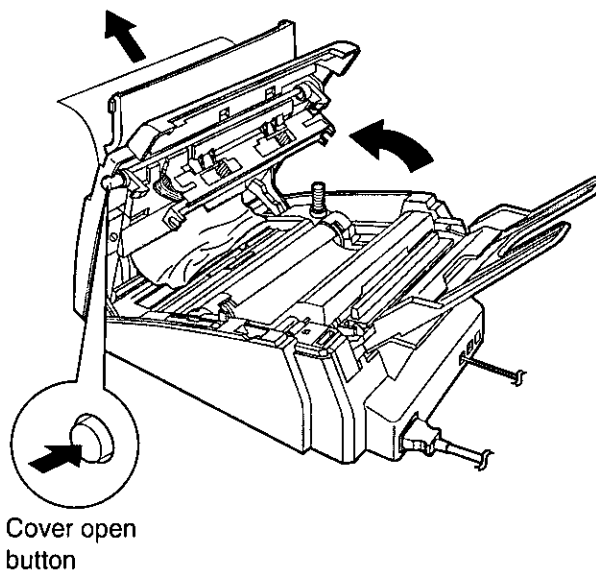
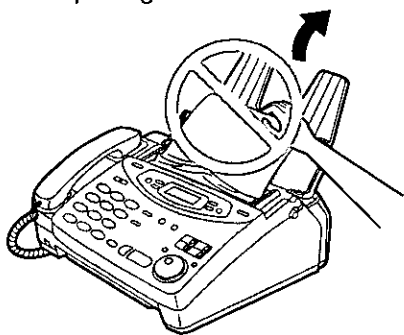

Sending document does not feed, or multi-feeds

If no feeding or multiple feeding occurs frequently, adjust the feeder pressure.

- 1** Open the cover by pressing the cover open button.
- 2** Shift the position of the green lever by using an instrument with a pointed end, such as a paper clip.
Left: When document multiple feeds.
Center: Standard position (pre-selected)
Right: When document does not feed.
- 3** Close the cover securely by pushing down on the dotted area at both ends.

Note:

- When shifting the green lever, do not touch the surrounding parts.

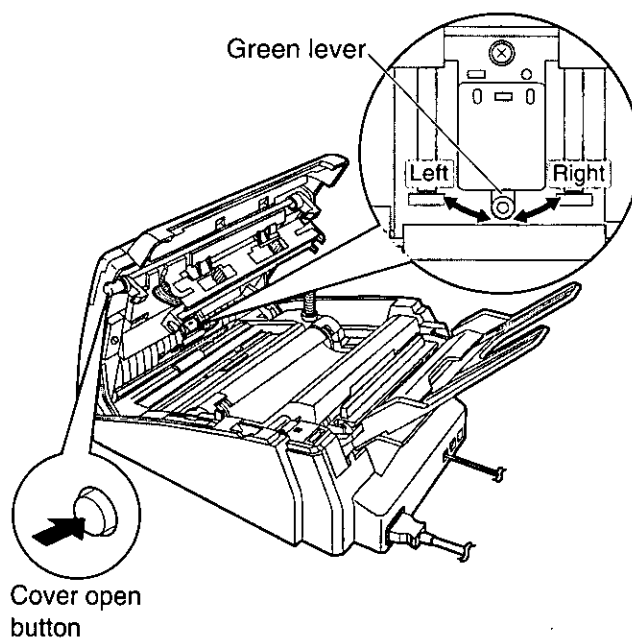

How much film you have left

To check the amount of remaining film, proceed as follows. The display indicates the approximate amount of remaining film.

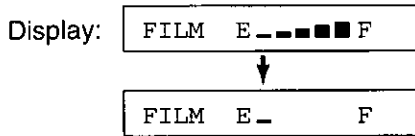

When the film indicator points to this position, the remaining film will print up to 25 pages of letter size document. Prepare a new film cartridge for replacement.

1 Press **MENU**.

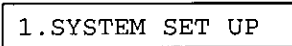
Display: 

2 Press **#**, then **1** **8**.

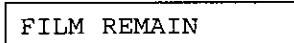

3 Press **START/SET/COPY**.

Example: 

4 Press **STOP**.

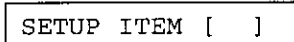

5 Press **MENU**.

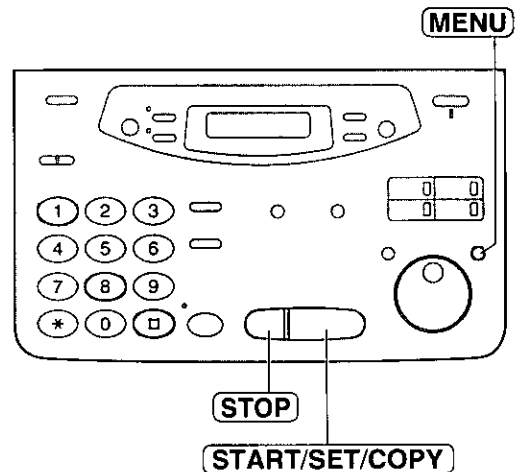

Replacing the film cartridge

When the unit detects the end of the film, the following message will be displayed.

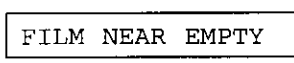
Display:  The remaining film prints about 15 pages of letter size document. Prepare a new film cartridge.

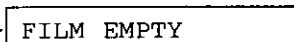
 The film is empty. Install a new film cartridge.

The following is available for replacement:
KX-FA65: Film cartridge (prints about 330 letter size pages)
 To order, see page 15.

1 Open the cover by pressing the cover open button.

2 Remove the used film cartridge.

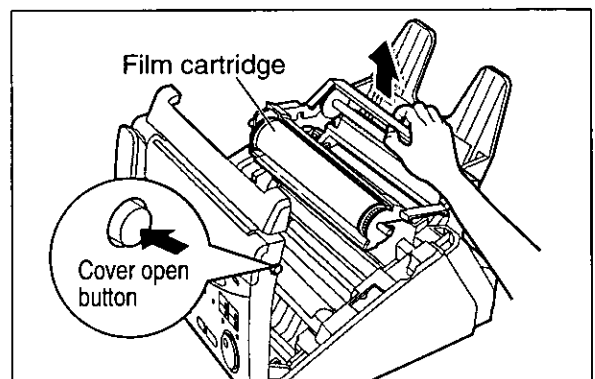

Ink Film

- 3** Remove the film stopper from the new film cartridge by pressing it up.

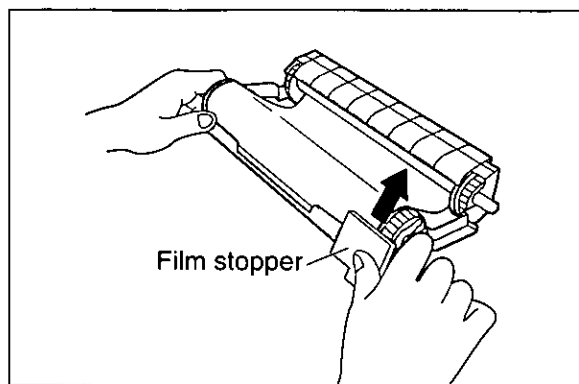

- 4** If the film is slack, tighten it by winding the gears.

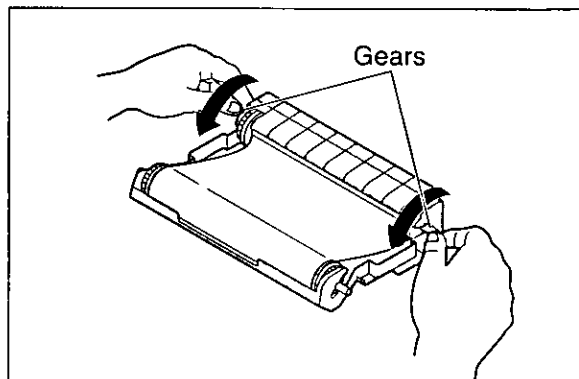
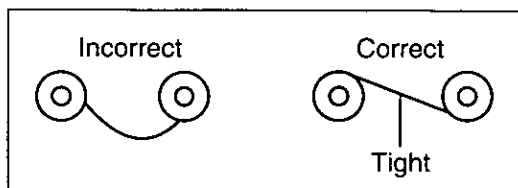

- 5** Turn the film cartridge over so that the "BACK" is facing up.

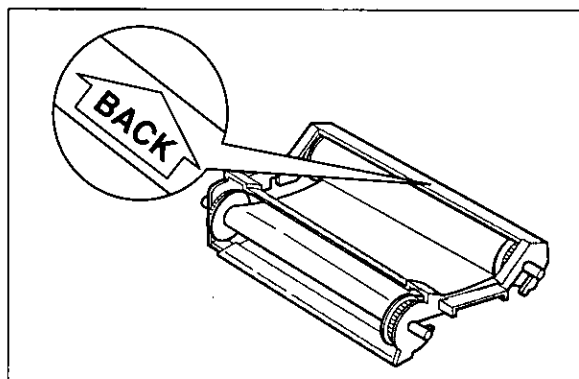

- 6** Insert the new film cartridge by first placing the front of the cartridge into the unit and then lowering the "BACK" of the cartridge into place.

- 7** Close the cover securely by pushing down on the dotted area at both ends.

- The unit will check that there is no slack on the film. The following message will be displayed.

Display: PLEASE WAIT

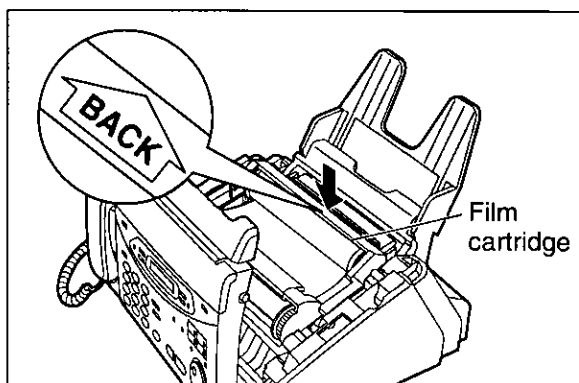

Document feeder

If misfeeding occurs frequently or if dirty patterns or black bands appear on a copied or transmitted document, clean the document feeder.

- 1** Disconnect the power cord and the telephone line cord.
- 2** Open the cover by pressing the cover open button.
- 3** Clean the document feeder rollers, sub roller and rubber flap with a cloth moistened with isopropyl rubbing alcohol, and let all parts dry thoroughly.
- 4** Clean the white plate and glass with a soft dry cloth.
- 5** Close the cover securely by pushing down on the dotted area at both ends.
- 6** Connect the power cord and the telephone line cord.

Caution:

- Do not use paper products, such as paper towels or tissues, to clean the inside of the unit.

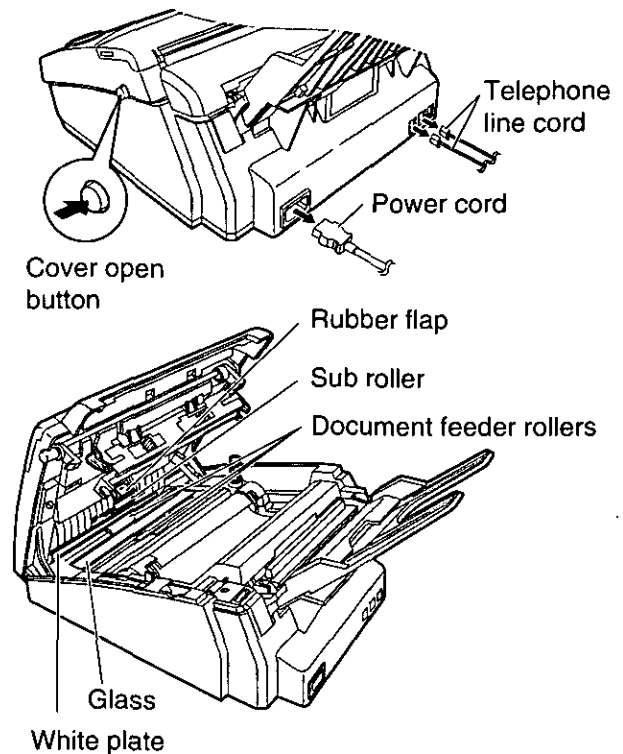

Thermal head and black bar

If dirty patterns or black or white bands appear on a copied or received document, clean the thermal head and black bar.

- 1** Disconnect the power cord and the telephone line cord.
- 2** Open the cover by pressing the cover open button.
- 3** Clean the thermal head and black bar with a cloth moistened with isopropyl rubbing alcohol, and let it dry thoroughly.
- 4** Close the cover securely by pushing down on the dotted area at both ends.
- 5** Connect the power cord and the telephone line cord.

Caution:

- To prevent a malfunction due to static electricity, do not use a dry cloth and do not touch the thermal head directly with your fingers.

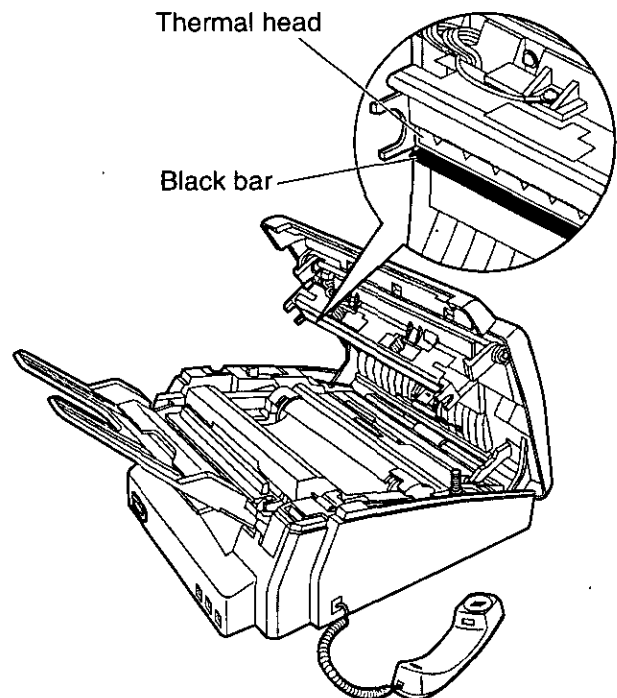

Print Reports

Printing the feature settings, telephone numbers, journal, printer test list, broadcast list and Caller ID list

You can print out the following lists/reports.

Feature list: provides you with the current settings of the basic and advanced programming features (p. 129–131).

Telephone number list: provides you with names and telephone numbers which are stored in the One-Touch Dial and JOG DIAL directory. The telephone number codes are as shown below.

P: A pause has been entered.

[]: A secret telephone number has been entered. (The telephone number is not printed.)

Journal report: keeps records of fax transmissions and receptions. This report will be printed automatically after every 35 fax communications (p. 67).

Printer test list: allows you to check the print quality of your unit. If the test print has a dirty pattern, or blurred points or lines, clean the thermal head (p. 111).

Broadcast list: provides you with names and telephone numbers which are stored in the BROADCAST keys (p. 70–72).

Caller ID list: keeps records of the last 35 callers after subscribing to a Caller ID service. Also, this report will be printed automatically after every 35 callers (p. 56).

1 Press **MENU** two times.

Display: 2. PRINT REPORT

2 For the **feature list**, press **#**, then **1**.

SETUP LIST

For the **telephone number list**, press **#**, then **3**.

TEL NO. LIST

For the **journal report**, press **#**, then **4**.

JOURNAL REPORT

For the **printer test list**, press **#**, then **5**.

PRINTER TEST

For the **broadcast list**, press **#**, then **6**.

BROADCAST LIST

For the **Caller ID list**, press **#**, then **8**.

CALLER ID LIST

3 Press **START/SET/COPY** to start printing.

PRINTING

- To stop printing, press **STOP**.
- After printing, the following will be displayed.

PRINT ITEM []

4 Press **MENU**.

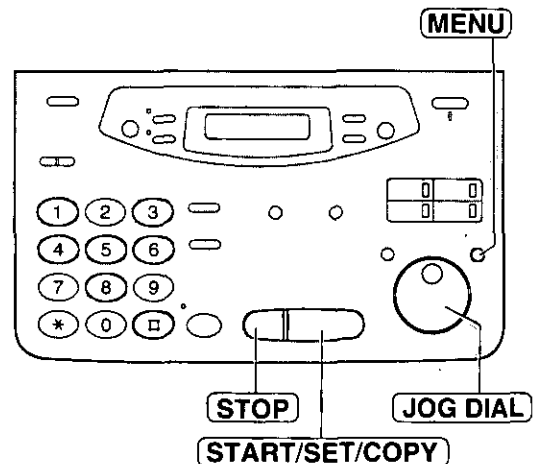

Note:

- In step 2, you can select the desired item by rotating **JOG DIAL**.

Changing the display contrast

Use this feature to adjust the display contrast.

NORMAL: (Pre-selected setting)

DARKER: Used when the display contrast is too light.

- 1 Press **MENU**.
Display: 1. SYSTEM SET UP
- 2 Press **#**, then **3 9**.
LCD CONTRAST
- 3 Press **START/SET/COPY**.
MODE=NORMAL ▼▲
- 4 Press ▼ or ▲ to select the desired setting.
- 5 Press **START/SET/COPY**.
SETUP ITEM []
- 6 Press **MENU**.

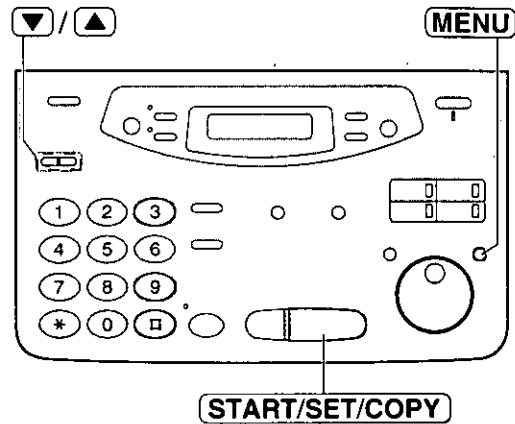

Resetting the advanced features

Use this feature to return the advanced features (p. 130, 131) to their pre-selected settings.

- 1 Press **MENU**.
Display: 1. SYSTEM SET UP
- 2 Press **#**, then **8 0**.
SET DEFAULT
- 3 Press **START/SET/COPY**.
RESET=NO ▼▲
- 4 Press ▼ or ▲ to select "YES".
RESET=YES ▼▲
- 5 Press **START/SET/COPY**.
RESET OK?
- If this feature is not required, press **STOP**.
- 6 Press **START/SET/COPY** again for confirmation.
RESET COMPLETED
↓
SETUP ITEM []
- 7 Press **MENU**.

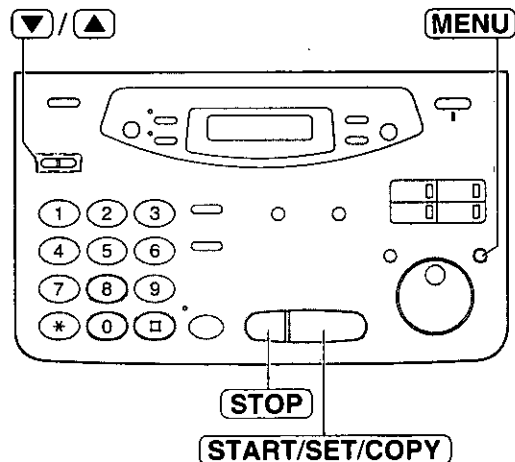

List of FCC requirements and information

If required by the telephone company, inform them of the following.

- FCC Registration No.:
(found on the rear of the unit)
- Ringer Equivalence No.:
(found on the rear of the unit)
- The particular telephone line to which the equipment is connected.

This unit must not be connected to a coin operated line. If you are on a party line, check with your local telephone company.

Ringer Equivalence Number (REN):

This REN is useful in determining the quantity of devices you may connect to your telephone line and still have all of those devices ring when your telephone number is called. In most but not all areas, the sum of the REN's of all devices connected to one line should not exceed five (5.0). To be certain of the number of devices you may connect to your line, as determined by the REN, you should contact your local telephone company to determine the maximum REN for your calling area.

In the event that terminal equipment causes harm to the telephone network, the telephone company should notify the customer, if possible, that service may be stopped. However, where prior notice is impractical, the company may temporarily cease service providing that they:

- a) Promptly notify the customer.
- b) Give the customer an opportunity to correct the problem with their equipment.
- c) Inform the customer of the right to bring a complaint to the Federal Communication Commission pursuant to procedures set out in FCC Rules and Regulations Subpart E of Part 68.

The Telephone Company may make changes in its communications facilities, equipment operations, or procedures where such action is reasonably required in the operation of its business and is not inconsistent with the rules and regulations in FCC Part 68. If such changes can be reasonably expected to render any customer terminal equipment incompatible with telephone company communications facilities, or require modification or

alteration of such terminal equipment, or otherwise materially affect its use or performance, the customer shall be given adequate notice in writing, to allow the customer an opportunity to maintain uninterrupted service.

CAUTION:

Any changes or modifications not expressly approved by the party responsible for compliance could void the user's authority to operate this device.

When programming emergency numbers and/or making test calls to emergency numbers:

1. Remain on the line and briefly explain to the dispatcher the reason for the call before hanging up.
2. Perform such activities in the off-peak hours; such as early morning or late evenings.

This telephone provides magnetic coupling to hearing aids.

NOTE:

This equipment has been tested and found to comply with the limits for a Class B digital device, pursuant to Part 15 of the FCC Rules. These limits are designed to provide reasonable protection against harmful interference in a residential installation. This equipment generates, uses, and can radiate radio frequency energy and, if not installed and used in accordance with the instructions, may cause harmful interference to radio communications. However, there is no guarantee that interference will not occur in a particular installation. If this equipment does cause harmful interference to radio or television reception, which can be determined by turning the equipment off and on, the user is encouraged to try to correct the interference by one or more of the following measures:

- Reorient or relocate the receiving antenna.
- Increase the separation between the equipment and receiver.
- Connect the equipment into an outlet on a circuit different from that to which the receiver is connected.
- Consult the dealer or an experienced radio/TV technician for help.

Panasonic Consumer Electronics Company,
Division of Matsushita Electric Corporation of
America
One Panasonic Way, Secaucus,
New Jersey 07094

Panasonic Sales Company
Division of Matsushita Electric of
Puerto Rico, Inc.
Ave. 65 de Infantería, Km. 9.5, San Gabriel
Industrial Park, Carolina, Puerto Rico 00985

PANASONIC Facsimile Products Limited Warranty

Have any questions? CALL 1-800-HELPFAX on:

How to operate the unit,
How to get repair service,
How to get supplies.

Panasonic Consumer Electronics Company or Panasonic Sales Company (collectively referred to as "the warrantor"), will repair this product with new or refurbished parts, free of charge, in the USA or Puerto Rico for one (1) year from the date of original purchase in the event of a defect in materials or workmanship.

This Limited Warranty Excludes both Labor and Parts for: batteries, antennas, and cosmetic parts (cabinet).

Carry-in or mail-in service in the USA or Puerto Rico can be obtained during the warranty period by contacting a Panasonic Services Company (PASC) Factory Servicenter listed in the Servicenter Directory. Or call, toll free, 1-800-HELP FAX (1-800-435-7329) to locate a PASC Factory Servicenter. Carry-in or mail-in service in Puerto Rico can be obtained during the warranty period by calling the Panasonic Sales Company telephone number listed in the Servicenter Directory.

This warranty is extended only to the original purchaser. A purchase receipt or other proof of date of original purchase will be required before warranty service is rendered.

This warranty only covers failures due to defects in material or workmanship which occur during normal use and (when applicable) does not cover the film cartridge, the toner cartridge and drum unit or the print and ink cartridge. The inability of this product to interface with any specific computer is not a manufacturing defect and is outside of the scope of this Limited Warranty. In no event shall the warrantor be liable by reason of such incompatibility. The warranty does not cover damages which occur in shipment, or failures which are caused by products not supplied by the warrantor such as non Panasonic ink cartridges, or failures which result from accident, misuse, abuse, neglect, mishandling, faulty installation, misapplication, set-up adjustments, improper operation or maintenance, alteration, modification, power line surge, improper voltage supply, lightning damage, signal reception problems, rental use of the product, or service by anyone other than a PASC Factory Servicenter or a PASC authorized Servicenter, or damage that is attributable to acts of God.

LIMITS AND EXCLUSIONS

There are no express warranties except as listed above.

THE WARRANTOR SHALL NOT BE LIABLE FOR INCIDENTAL OR CONSEQUENTIAL DAMAGES RESULTING FROM THE USE OF THIS PRODUCT, OR ARISING OUT OF ANY BREACH OF THIS WARRANTY. ALL EXPRESS AND IMPLIED WARRANTIES, INCLUDING THE WARRANTIES OF MERCHANTABILITY, ARE LIMITED TO THE APPLICABLE WARRANTY PERIOD SET FORTH ABOVE.

Some states do not allow the exclusion or limitation of incidental or consequential damages, or limitations on how long an implied warranty lasts, so the above exclusions or limitations may not apply to you.

This warranty gives you specific legal rights and you may also have other rights which vary from state to state. If a problem with this product develops during or after the warranty period, you may contact your dealer or Servicenter. If the problem is not handled to your satisfaction, then write to the Customer Satisfaction Center at the company address indicated above.

Limited Warranty

Servicenter Directory

For Product Information, Operating Assistance, Literature Request, Dealer Locations, and all Customer Service inquiries please contact:
1-800-HELP-FAX (435-7329), Monday-Friday 9am - 8pm EST.

Web Site: <http://www.Panasonic.com>
You can purchase parts, accessories or locate your nearest servicenter by visiting our Web Site.

Factory Servicenters Locations

CALIFORNIA 6550 Katella Avenue Cypress, CA 90630 800 Dubuque Avenue S. San Francisco, CA 94080 20201 Sherman Way Suite 102 Canoga Park, CA 91306 3878 Ruffin Road Suite A San Diego, CA 92123	GEORGIA 8655 Roswell Road Suite 100 Atlanta, GA 30350 ILLINOIS 9060 Golf Road Niles, IL 60714 1703 North Randall Road Elgin, IL 60123 (Pick-up / Drop-off only)	MICHIGAN 37048 Van Dyke Avenue Sterling Heights, MI 48312 MINNESOTA 7850-12 th Avenue South Airport Business Center Bloomington, MN 55425 OHIO 2236 Waycross Road Civic Center Plaza Forest Park, OH 45240	TENNESSEE 3800 Ezell Road Suite 806 Nashville, TN 37211 TEXAS 7482 Harwin Drive Houston, TX 77036 13615 Welch Road Suite #101 Farmers Branch, TX 75244
COLORADO 1640 South Abilene Street Suite D Aurora, CO 80012	MARYLAND 62 Mountain Road Glen Burnie, MD 21061	PENNSYLVANIA 2221 Cabot Blvd. West Suite B Langhorne, PA 19047 Chartiers Valley Shopping Center 1025 Washington Pike Bridgeville, PA 15017	WASHINGTON 20425-84 th Avenue South Kent, WA 98032
FLORIDA 3700 North 29 th Avenue Suite 102 Hollywood, FL 33020	MASSACHUSETTS 60 Glacier Drive Suite G Westwood, MA 02090		HAWAII 99-859 Iwaiwa Street Aiea, Hawaii 96701 Phone (808) 488-1996 Fax (808) 486-4369

Service in Puerto Rico

Matsushita Electric of Puerto Rico, Inc. Panasonic Sales Company/ Factory Servicenter:
Ave. 65 de Infantería, Km. 9.5, San Gabriel Industrial Park, Carolina, Puerto Rico 00985
Phone (787) 750-4300 Fax (787) 768-2910

Accessory Purchases:

1-800-332-5368 (Customer Orders Only)
Panasonic Services Company 20421 84th Avenue South, Kent, WA 98032
(6 am to 5 pm Monday – Friday; 6 am to 10:30 am Saturday; PST)
(Visa, MasterCard, Discover Card, American Express, Check)

As of Jul. '98

Notes for product service and shipping the product

For product service

- Servicers are listed on page 116.
- Call toll free 1-800-HELP-FAX (435-7329) for the location of an authorized servicer.

When you ship the product

- Carefully pack your unit, preferably in the original carton.
- Attach a letter, detailing the symptom or problem, to the outside of the carton.
- Send the unit to an authorized servicer, prepaid and adequately insured.
- Do not send your unit to the Panasonic Consumer Electronics Company or to any executive or regional sales offices. These locations do not repair consumer products.

Energy Star

As an ENERGY STAR® Partner, Panasonic has determined that this product meets the ENERGY STAR® guidelines for energy efficiency.
ENERGY STAR is a U.S. registered mark.



Specifications

Technical data about this product

Applicable Lines:	Public Switched Telephone Network
Document Size:	Max. 216 mm (8½") in width Max. 600 mm (23½") in length
Effective Scanning Width:	208 mm (8⅜")
Recording Paper Size:	Letter: 216 mm × 279 mm (8½" × 11")
Legal:	216 mm × 356 mm (8½" × 14")
Effective Printing Width:	208 mm (8⅜")
Transmission Time*:	Approx. 15 s/page (Original mode)**
Scanning Density:	Horizontal: 8 pels/mm (203 pels/inch) Vertical: 3.85 lines/mm (98 lines/inch) —STANDARD mode 7.7 lines/mm (196 lines/inch) —FINE/HALF TONE mode 15.4 lines/mm (392 lines/inch) —SUPER FINE mode
Halftone Level:	64-level
Scanner Type:	Contact Image Sensor (CIS)
Printer Type:	Thermal Transfer Printing
Data Compression System:	Modified Huffman (MH), Modified READ (MR)
Modem Speed:	9,600 / 7,200 / 4,800 / 2,400 bps; Automatic Fallback
Operating Environment:	5 °C – 35 °C (41 °F – 95 °F), 20 % – 80 % RH (Relative Humidity)
Dimensions (H × W × D):	143 mm × 325 mm × 305 mm (5⅝" × 12⅜" × 12")
Mass (Weight):	Approx. 4.0 kg (8.8 lb.)
Power Consumption:	Standby: Approx. 5.5 W Transmission: Approx. 18 W Reception: Approx. 45 W (When receiving a 20% black document) Copy: Approx. 48 W (When copying a 20% black document) Maximum: Approx. 160 W (When copying a 100% black document)
Power Supply:	120 V AC, 60 Hz (This unit will not function at 50 Hz.)
Memory Capacity:	Approx. 28 pages of memory reception Approx. 25 pages of memory transmission (Based on the CCITT of No. 1 Test Chart in standard resolution.)

* Transmission speed depends upon the contents of the pages, resolution, telephone line conditions and capability of the receiving unit.

** The 15 second speed is based upon the CCITT No. 1 Test Chart and original mode.

If the capability of the other party's machine is inferior to your unit, the transmission time may be longer.

CCITT No. 1 Test Chart

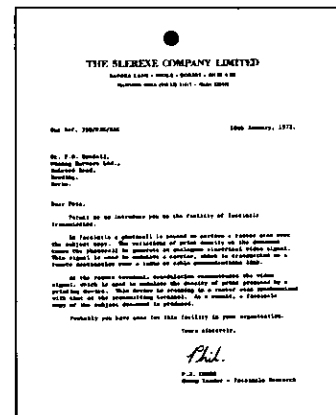

Note:

- Any details given in these instructions are subject to change without notice.
- The pictures and illustrations in these instructions may vary slightly from the actual product.

Instalación

Antes de hacer la instalación

A. Quite la cinta de transporte.

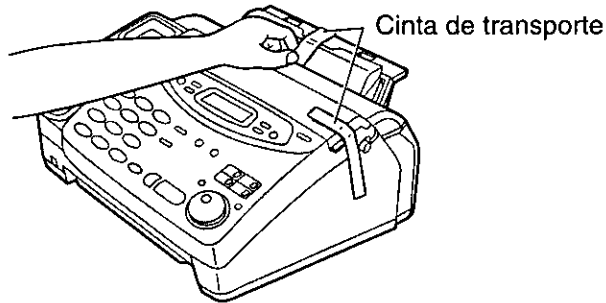

B. Abra la cubierta, quite un folleto de debajo del cartucho de película y cierre la cubierta.

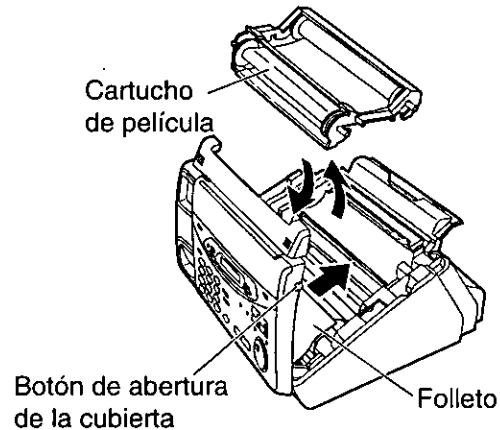

1 Bandeja de papel

Inserte las dos lengüetas de la bandeja de papel en las ranuras de la parte trasera de la unidad.

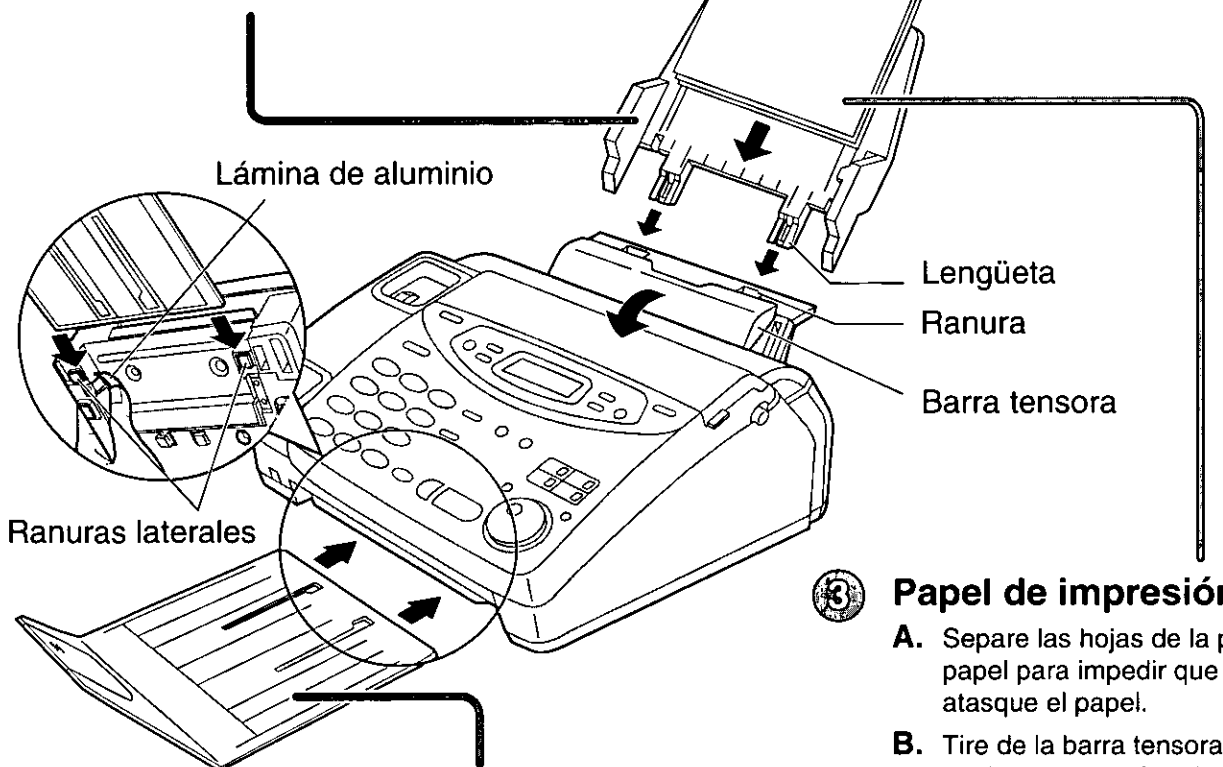

2 Soporte de documentos

- A. Levante la parte delantera de la unidad y sujete la lámina de aluminio.
- B. Inserte el soporte de documentos en las ranuras laterales.

3 Papel de impresión

- A. Separe las hojas de la pila de papel para impedir que se atasque el papel.
- B. Tire de la barra tensora hacia adelante y manténgala abierta mientras introduce el papel.

Comienzo rápido en español

Conexiones

- Cuando conecte los cables de línea telefónica al fax, utilice los cables de línea telefónica incluidos para obtener una comunicación de datos fiable y satisfacer las normas de la FCC.
- Cuando conecte un cable de línea telefónica de 4 hilos, conecte el lado del núcleo de ferrita en el fax.

■ Para conectar a una toma de línea telefónica de dos líneas (RJ14C)

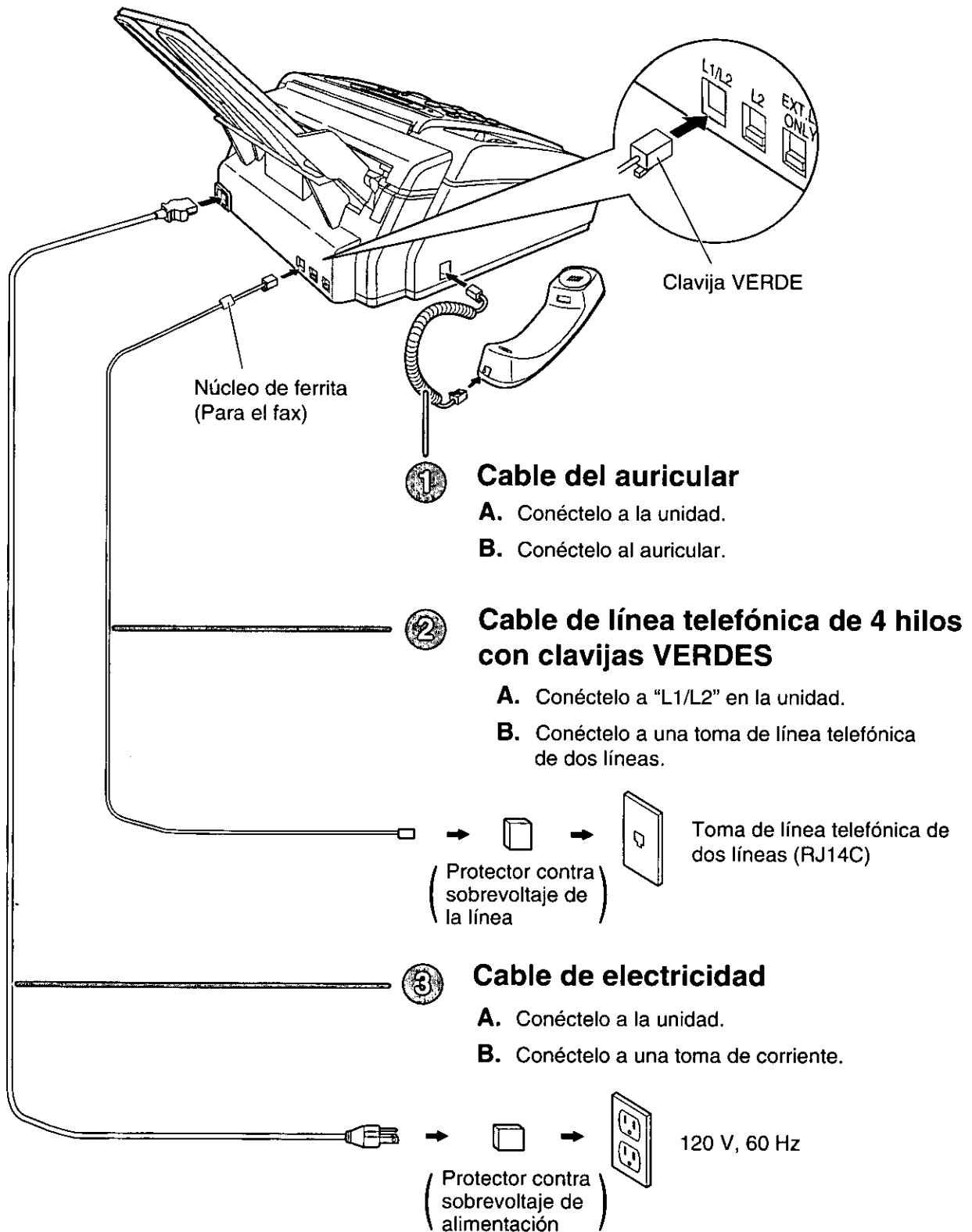

■ Para conectar a dos tomas de línea telefónica sencilla (RJ11C)

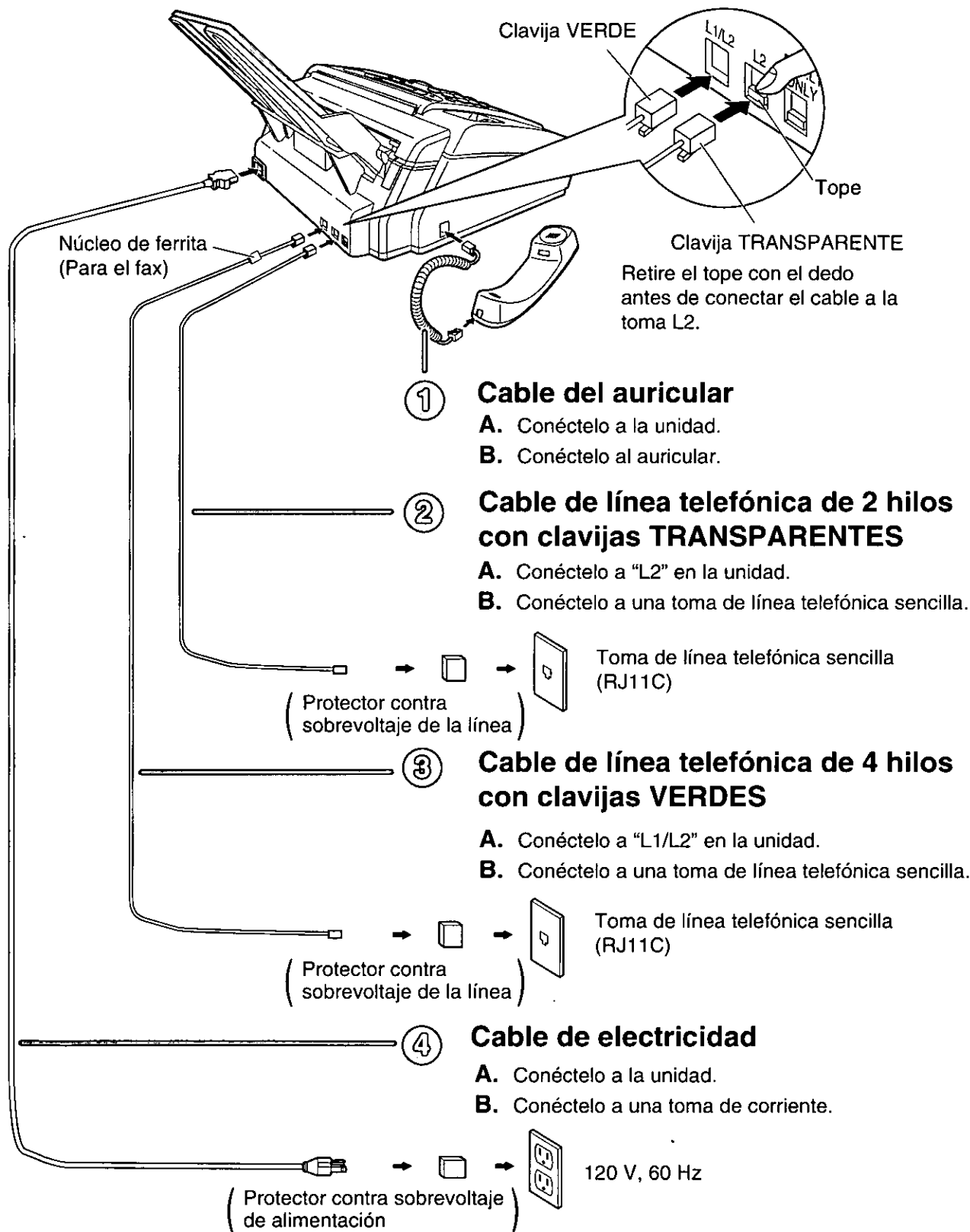

- Si conecta la unidad a una centralita privada (PBX), conéctela de la forma siguiente:
A. Conecte el cable de línea telefónica de 4 hilos a la toma "L2".
B. Conecte el cable de línea telefónica de 2 hilos a la toma "L1/L2".

Programación inicial

■ Ajuste de la fecha y la hora

- 1 Pulse **MENU**.
- 2 Pulse **#**, y luego **0 1**.
- 3 Pulse **START/SET/COPY**.
- 4 Introduzca el mes/día/año correcto seleccionándolos con 2 dígitos para cada uno utilizando el teclado de marcación o **JOG DIAL**. Si utiliza **JOG DIAL**, pulse **▶** para mover el cursor.
- 5 Pulse **START/SET/COPY**.
- 6 Introduzca la hora/minuto correcto seleccionando cada uno de ellos mediante 2 dígitos con el teclado de marcación o **JOG DIAL**. Si utiliza **JOG DIAL**, pulse **▶** para mover el cursor. Pulse ***** para seleccionar "AM" o "PM".
- 7 Pulse **START/SET/COPY**.
- 8 Pulse **MENU**.

■ Ajuste de su logotipo

- 1 Pulse **MENU**.
- 2 Pulse **#**, y luego **0 2**.
- 3 Pulse **START/SET/COPY**.
- 4 Introduzca su logotipo, con un máximo de 30 caracteres, utilizando el teclado de marcación (consulte las instrucciones de la derecha) o **JOG DIAL** (consulte la página siguiente).
 - Para introducir continuamente el mismo número, pulse **▶** para mover el cursor al siguiente espacio.
- 5 Pulse **START/SET/COPY**.
- 6 Pulse **MENU**.

■ Ajuste del número de teléfono de su facsímil

- 1 Pulse **MENU**.
- 2 Pulse **#**, y luego **0 3**.
- 3 Pulse **START/SET/COPY**.
- 4 Introduzca el número de su fax conectado a la línea 1 de hasta 20 dígitos utilizando el teclado de marcación.
- 5 Pulse **START/SET/COPY**.
- 6 Introduzca el número de su fax conectado a la línea 2 de hasta 20 dígitos utilizando el teclado de marcación.
- 7 Pulse **START/SET/COPY**.
- 8 Pulse **MENU**.

- Puede introducir el número de su fax girando **JOG DIAL**. Si utiliza **JOG DIAL**, presione **▶** para mover el cursor.
- El botón ***** reemplaza un caracter por un signo "+" y el botón **#** reemplaza un caracter por un espacio.
- Para introducir un guión en un número de teléfono, pulse **HYPHEN**.

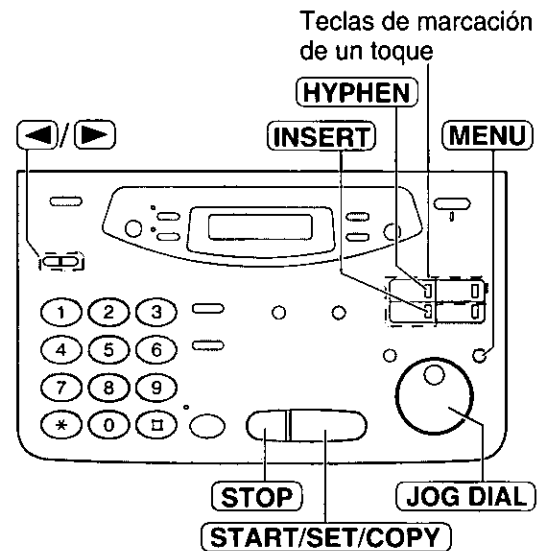

Selección de caracteres con el teclado de marcación

Tecla	Caracteres
①	1 [] { } + - / = , . - ` : ; ?
②	A B C a b c 2
③	D E F d e f 3
④	G H I g h i 4
⑤	J K L j k l 5
⑥	M N O m n o 6
⑦	P Q R S p q r s 7
⑧	T U V t u v 8
⑨	W X Y Z w x y z 9
⑩	0 () < > ! " # \$ % & ¥ * @ ^ ' →
INSERT	Se utiliza para insertar un carácter o un espacio.

Para corregir un error

- Pulse **◀** o **▶** para mover el cursor al carácter incorrecto, y luego haga la corrección.
- Para borrar un carácter, mueva el cursor al carácter que desee borrar y pulse **STOP** para las características número #02 y #03.

Memorización de nombres y números de teléfono para la marcación de un toque

- ① Pulse **DIRECTORY PROGRAM**.
- ② Para las estaciones 1-3
Pulse una de las teclas de marcación de un toque.
 - Si selecciona la tecla de marcación de un toque 1, 2 ó 3, seleccione "DIAL MODE" pulsando **▼**, y luego pulse **START/SET/COPY** para ir a la siguiente indicación.
- Para las estaciones 4-6
Pulse **LOWER**, y luego pulse una de las teclas de marcación de un toque.
- ③ Introduzca el nombre de la estación, un máximo de 10 caracteres, utilizando el teclado de marcación (consulte la página 122) o **JOG DIAL** (consulte abajo).
- ④ Pulse **START/SET/COPY**.
- ⑤ Introduzca el número de teléfono, un máximo de 30 dígitos.
- ⑥ Pulse **START/SET/COPY**.
- ⑦ Pulse **DIRECTORY PROGRAM** para salir de la programación.

Selección de caracteres con JOG DIAL

En lugar de pulsar las teclas de marcación podrá seleccionar caracteres utilizando JOG DIAL.

1. Gire **JOG DIAL** hasta que se visualice el carácter deseado.
2. Pulse **▶** para mover el cursor al siguiente espacio.
 - Se inserta el carácter visualizado en el paso 1.
3. Vuelva al paso 1 para introducir el siguiente carácter.

Orden de visualización de los caracteres

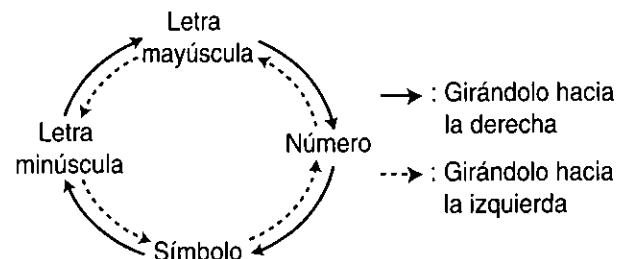

Memorización de nombres y números de teléfono en el directorio JOG DIAL

Para acceder rápidamente a los números marcados frecuentemente, además de la marcación de un toque, la unidad proporciona también el directorio JOG DIAL (100 estaciones).

- ① Pulse **DIRECTORY PROGRAM**.
- ② Gire **JOG DIAL** e introduzca el nombre, hasta 10 caracteres, utilizando el teclado de marcación (consulte la página 122) o **JOG DIAL** (consulte arriba).
- ③ Pulse **START/SET/COPY**.
- ④ Introduzca el número de teléfono, un máximo de 30 dígitos.
- ⑤ Pulse **START/SET/COPY**.
- ⑥ Pulse **DIRECTORY PROGRAM** para salir de la programación.

Para corregir un error

- Pulse **◀** o **▶** para mover el cursor al carácter incorrecto, y luego haga la corrección.

Para borrar un carácter

- Mueva el cursor al carácter que desee borrar y pulse **STOP**.

Para hacer/contestar una llamada de voz

■ Para hacer manualmente una llamada de voz

- 1 Levante el auricular.
- 2 Marque el número.
- 3 Cuando termine de conversar, vuelva a poner el auricular en su lugar.

■ Para hacer una llamada de voz utilizando la marcación de un toque

- 1 Levante el auricular.
- 2 Para las estaciones 1-3
Pulse la tecla de marcación de un toque deseada.
- 3 Para las estaciones 4-6
Pulse **LOWER**, y luego pulse la tecla de marcación de un toque deseada.
- 4 Cuando termine de conversar, vuelva a poner el auricular en su lugar.

■ Para hacer una llamada de voz utilizando el directorio JOG DIAL

- 1 Gire **JOG DIAL** hasta que se visualice el nombre deseado.
- 2 Levante el auricular.
 - La unidad empezará a marcar automáticamente.
- 3 Cuando termine de conversar, vuelva a poner el auricular en su lugar.

■ Para contestar una llamada de voz

- 1 Levante el auricular cuando oiga el timbre de la unidad.
- 2 Cuando termine de conversar, vuelva a poner el auricular en su lugar.

■ Utilización de la otra línea durante una conversación

Ejemplo: Si está utilizando **LINE 1**

- 1 Presione **HOLD** para poner la primera llamada (línea 1) en retención.
- 2 Presione el botón de la otra línea (**LINE 2**) para hacer o contestar una segunda llamada.
- 3 Para volver a la primera llamada (línea 1), presione el botón de línea de la primera llamada (**LINE 1**).

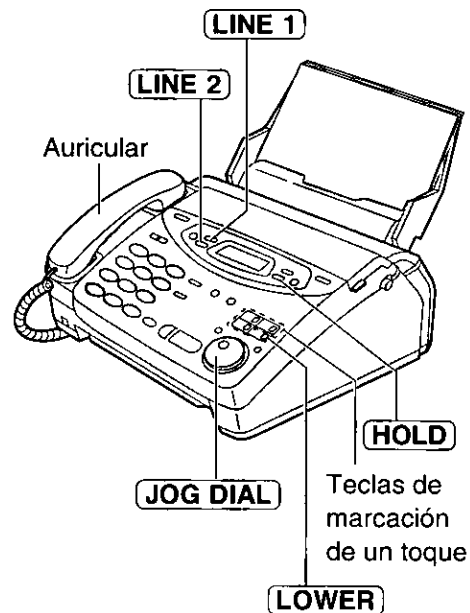

Envío de un fax

■ Envío manual de un fax

- 1 Abra la bandeja del alimentador de documentos.
- 2 Ajuste la anchura de las guías de documentos según el tamaño del documento.
- 3 Introduzca el documento hasta que oiga un pitido.
- 4 Marque el número del fax.
- 5 Pulse **START/SET/COPY**.

■ Envío de un fax utilizando la marcación de un toque

- 1 Abra la bandeja del alimentador de documentos.
- 2 Ajuste la anchura de las guías de documentos según el tamaño del documento.
- 3 Introduzca el documento hasta que oiga un pitido.
- 4 **Para las estaciones 1-3**
Pulse la tecla de marcación de un toque deseada.
Para las estaciones 4-6
Pulse **LOWER**, y luego pulse la tecla de marcación de un toque deseada.

■ Envío de un fax utilizando el directorio JOG DIAL

- 1 Abra la bandeja del alimentador de documentos.
- 2 Ajuste la anchura de las guías de documentos según el tamaño del documento.
- 3 Introduzca el documento hasta que oiga un pitido.
- 4 Gire **JOG DIAL** hasta que se visualice el nombre deseado.
- 5 Pulse **START/SET/COPY**.

■ Envío de un fax durante una conversación

Ejemplo: Si está utilizando **LINE 1**

- 1 Presione **HOLD** para poner la primera llamada (línea 1) en retención.
- 2 Introduzca los documentos con la CARA IMPRESA HACIA ABAJO, y luego presione el botón de la otra línea (**LINE 2**) para hacer una segunda llamada.
- 3 Marque el número de fax utilizando el teclado de marcación, la marcación de un toque o **JOG DIAL**.
- 4 Presione **START/SET/COPY**.
- 5 Para volver a la primera llamada (línea 1), presione el botón de línea de la primera llamada (**LINE 1**).



Comienzo rápido en español

Reciviendo un fax

■ Recepción manual de un fax

- 1 Levante el auricular cuando oiga el timbre de la unidad.
- 2 Cuando:
 - sea necesario recibir un documento,
 - se oiga un tono de llamada de fax (pitido lento), o
 - no se oiga sonido,pulse **START/SET/COPY**.
- 3 Cuelgue el auricular.

■ Para recibir documentos durante una conversación telefónica

- 1 Presione **HOLD** para poner la primera llamada en retención.
- 2 Presione el botón de la otra línea para contestar la segunda llamada.
- 3 Presione **START/SET/COPY**.
- 4 Para volver a la primera llamada, presione el botón de línea de la primera llamada.

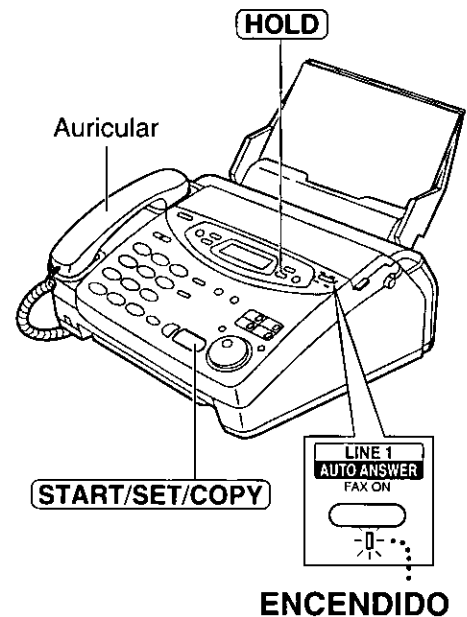

■ Recepción automática de un fax

Pulse **AUTO ANSWER** para activar el modo AUTO ANSWER.

Para hacer una copia

- 1 Abra la bandeja del alimentador de documentos.
- 2 Ajuste la anchura de las guías de documentos según el tamaño del documento.
- 3 Introduzca el documento hasta que oiga un pitido.
- 4 Pulse **START/SET/COPY**.
- 5 Introduzca el número de copias.
- 6 Pulse **START/SET/COPY**.

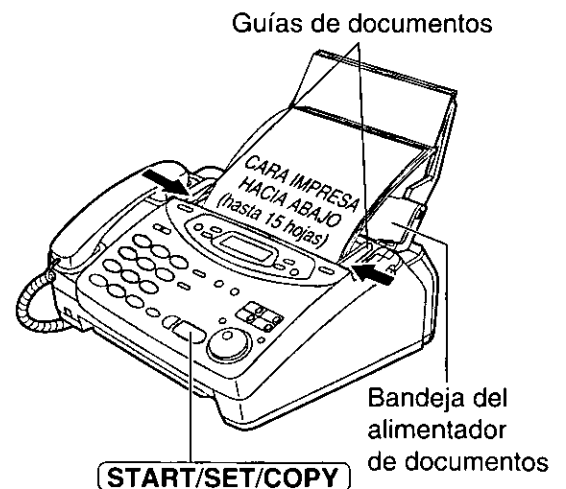

Index

- A** Accessories15
 Advanced features130, 131
 (Resetting)113
 Answering machine82–84
 Area code55
 AUTO ANSWER button74, 79, 90
 AUTO ANSWER mode74, 79, 90
 Automatic dialing mode setting27
- B** Basic features129
 BROADCAST keys70–72
 Broadcast report72, 112
- C** Caller ID50
 Caller ID list56, 112
 CALLER ID SEARCH button51–53
 Character table31
 Cleaning111
 COLLATE button97
 Communication messages99
 CONF button42
 Conference call42
 Connecting tone73
 Connections5, 6, 25–27
 Copy
 (Collated)97
 (Enlargement/reduction)97, 98
 (Multiple copies)97
 COPY button11, 97
- D** Date and time29
 Delayed transmission68
 Dialing mode33
 Directory feature46, 49, 61
 DIRECTORY
 PROGRAM button44, 46–48, 70, 71
 Display
 (Contrast)113
 (Error messages)100, 101
 Distinctive Ring service86, 87
 Document feeder cleaning111
 Document jam108
 Document size59, 118
- E** Enlarge/Reduce copy97, 98
 Error messages99–101
 Extension telephone82, 85
- F** Facsimile telephone number32
 Fax activation code85
 Fax auto redial60
 FAX ONLY mode74, 76, 79–81
 FAX ONLY ring count81
 Fax pager95
- Feature list112
 Feeder cleaning111
 Feeder jam108
 Feeder pressure108
 Film cartridge109, 110
 Film detection96
 Friendly reception78, 94
- H** Handset cord5, 6, 25
 HANDSET MUTE button39, 40
 Handset receiver volume38
 HELP button17
 HOLD button39–42
 HYPHEN key31, 32
- I** Ink film109, 110
 INSERT key30, 31
 IQ-FAX63–65
 IQ-FAX button65
- J** Jam106–108
 JOG DIAL
 (Making a voice call)49
 (Selecting characters)31
 (Sending faxes)61
 (Storing)46–48
 Journal auto print67
 Journal report67, 112
- L** Line button28, 41, 42
 Line indicator28
 Line mode35
 Line ringer mode36
 Line selection80, 90
 Line usage selection34
 List
 (Broadcast)72, 112
 (Caller ID)56, 112
 (Feature)112
 (Journal)67, 112
 (Printer test)112
 (Sending)66
 (Telephone number)112
 Location panel18, 19
 Logo30, 31
 LOWER key44, 45, 60
- M** Memory reception alert78, 93
 Memory transmission69
 MONITOR button39
 Monitor volume38
- N** NAME/TEL NO. key49

Index

- O** One-Touch Dial
 - (Making a voice call) 45
 - (Sending faxes) 60
 - (Storing) 44
 - Other size documents 92
 - Overseas transmission mode 73
 - Overview 20
- P** Pager call 95
- Paper jam 106, 107
- Paper stacker 4, 22, 23
- Paper tray 4, 22
- PAUSE button 43
- Power down report 105
- Power failure 105
- Power supply/cord 5, 6, 27, 118
- Printing paper size 118
- Printing reports 112
- Problem solving 102–105
- Programmable features 129–131
- Pulse 33
- Q** QUICK SCAN button 69, 97
- R** Receiving
 - (Fax) 10, 78
 - (Setting) 74–77
 - Receiving reduction 92
 - Recording paper 4, 23, 24, 118
 - Recording paper jam 106, 107
 - REDIAL button 39, 58
 - Remote activation ID 85
 - Report
 - (Broadcast) 72, 112
 - (Caller ID) 56, 112
 - (Feature) 112
 - (Journal) 67, 112
 - (Printer test) 112
 - (Sending) 66
 - (Telephone number) 112
 - Reset 113
 - Resolution 59
 - RESOLUTION button 58
 - Ring count
 - (FAX ONLY) 81
 - (TEL/FAX) 91
 - Ring pattern detection 86, 87
 - Ringer volume 38
- S** SECRET key 44, 46
- Sending
 - (Broadcast) 70–72
 - (From memory) 69
 - (IQ-FAX) 63–65
 - (JOG DIAL) 61
 - (Manually) 9, 58
 - (One-Touch Dial) 60
- Sending document (Does not feed or multi-feeds) 108
- Sending jam 108
- Sending report 66
- Set default 113
- Silent detection 93
- Silent fax recognition ring 91
- Specifications 118
- Storing
 - (Broadcast) 70
 - (Caller ID list) 43
 - (JOG DIAL) 46–48
 - (One-Touch Dial) 44
- T** TEL mode 74, 76, 78
- TEL/FAX delayed ring count 91
- TEL/FAX mode 88–91
- Telephone line cord 5, 6, 25, 26
- Telephone number list 112
- Thermal head cleaning 111
- TONE button 43
- Transmission
 - (Broadcast) 70–72
 - (From memory) 69
 - (IQ-FAX) 63–65
 - (JOG DIAL) 61
 - (Manually) 9, 58
 - (One-Touch Dial) 60
- Transmittable document 59, 118
- V** Voice call
 - (Answering) 8, 40
 - (JOG DIAL) 49
 - (Making) 8, 39
 - (One-Touch Dial) 45
- Voice contact 57
- VOLUME button 38

Summary of user programmable features --- ---

Basic features

Code	Feature & Display	Available settings	Meaning	Page	
#01	Setting the date and time SET DATE & TIME	(2 digits for each entry)	mm/dd/yy hh:mm	29	
#02	Setting your logo YOUR LOGO	(Up to 30 characters)		30	
#03	Setting your facsimile telephone number YOUR FAX NO.	(Up to 20 digits for each line)		32	
#04	Printing the sending report SENDING REPORT	ERROR ON OFF	If transmission fails Activate Deactivate	66	
#06	Setting the ring count in the FAX ONLY mode FAX RING COUNT	Line 1	1, 2, 3, 4, 5 EXT.TAM	1 to 5 rings (5 rings for use with an answering machine)	81
		Line 2	1, 2, 3, 4		
#12	Securing the remote operation for the answering machine REMOTE TAM ACT.	ON / ID=11 OFF	Activate Deactivate	84	
#13	Setting the dialing mode DIALING MODE	AUTO TONE PULSE	Sets the dialing mode automatically. Sets to TONE. Sets to PULSE.	33	
#18	Checking the amount of remaining film FILM REMAIN			109	

(The pre-selected setting is in bold.)

Note:

- You can display basic features in the order above by rotating **JOG DIAL** instead of entering the code number (#01, #02, etc.).

Features Summary

Advanced features

Code	Feature & Display	Available settings	Meaning	Page	
#22	Setting the journal report to print automatically <input type="text" value="AUTO JOURNAL"/>	ON	Activate	67	
		OFF	Deactivate		
#23	Sending documents overseas <input type="text" value="OVERSEAS MODE"/>	ON	Activate	73	
		OFF	Deactivate		
#25	Sending a fax at a specified time <input type="text" value="DELAYED SEND"/>	ON	Activate	68	
		OFF	Deactivate		
#26	Setting the Caller ID list to print automatically <input type="text" value="AUTO CALL. LIST"/>	ON	Activate	56	
		OFF	Deactivate		
#27	Setting line(s) to be used <input type="text" value="C.O.L SELECTION"/>	LINE 1	ON	Activate	34
			OFF	Deactivate	
		LINE 2	ON	Activate	
			OFF	Deactivate	
#29	Changing the line mode setting <input type="text" value="LINE MODE"/>	LINE 1	CO	Your line is connected to the central office.	35
			PBX	Your line is connected to the private branch exchange.	
		LINE 2	CO	Your line is connected to the central office.	
			PBX	Your line is connected to the private branch exchange.	
#30	Setting the silent fax recognition ring count <input type="text" value="SILENT FAX RING"/>	3, 4, 5, 6	3 to 6 rings	91	
#31	Setting the Distinctive Ring pattern <input type="text" value="RING DETECTION"/>	OFF	Deactivate	87	
		LINE 1	A, B, C, D		Patterns A–D
		LINE 2			
#32	Setting the ringer mode for the second call <input type="text" value="LINE RINGER MODE"/>	ON	Activate	36	
		OFF	Deactivate		
#33	Switching telephone numbers between line 1 and line 2 <input type="text" value="LINE CHANGE"/>	STANDARD	Standard	37	
		SWITCH	Switches telephone numbers.		
#36	Receiving other sizes of documents <input type="text" value="RCV REDUCTION"/>	100% 92% 86% 72%	Deactivate reduction 92% reduction 86% reduction 72% reduction	92	
#39	Changing the display contrast <input type="text" value="LCD CONTRAST"/>	NORMAL	Normal contrast	113	
		DARKER	Darker contrast		

Features Summary

Code	Feature & Display	Available settings	Meaning	Page	
#40	Setting the silent detection SILENT DETECT.	ON	Activate	93	
		OFF	Deactivate		
#41	Changing the fax activation code FAX ACTIVATION	ON / CODE=*9	Activate	85	
		OFF	Deactivate		
#44	Setting the memory reception alert RECEIVE ALERT	ON	Activate	93	
		OFF	Deactivate		
#46	Setting the friendly reception FRIENDLY RCV	ON	Activate	94	
		OFF	Deactivate		
#70	Signaling your pager when your unit receives a fax FAX PAGER CALL	ON	Activate	95	
		OFF	Deactivate		
#75	Setting the IQ-FAX function IQ-FAX	ON	Activate	64	
		OFF	Deactivate		
#76	Setting the connecting tone CONNECTING TONE	ON	Activate	73	
		OFF	Deactivate		
#77	Changing the receive mode setting for each line LINE SELECTION	LINE1	FAX ONLY	Facsimile only mode	90
			TEL/FAX	Telephone/Facsimile mode	
		LINE2	TEL	Telephone mode	80
			FAX ONLY	Facsimile only mode	
#78	Setting the TEL/FAX delayed ring count TEL/FAX RING	1, 2, 3, 4	1 to 4 rings	91	
#79	Setting the film detection FILM DETECTION	ON	Activate	96	
		OFF	Deactivate		
#80	Resetting the advanced features SET DEFAULT	YES	Reset	113	
		NO	Will not reset.		

(The pre-selected setting is in bold.)

Panasonic FAX ADVANTAGE PROGRAM

Free peace of mind, direct from Panasonic

NO EXTRA COST



- **1-year limited warranty¹ parts & labor**
- **Toll-free help line**
- **Free overnight replacement² and repair program**

The Panasonic Fax Advantage Consumer Service Program.

Panasonic knows that if your fax machine is not up and running, neither is your business. That's why we created the Panasonic Fax Advantage Program. Included at no extra cost with the purchase of a Panasonic Fax Machine, the Fax Advantage Program can provide a free replacement unit² overnight if your original unit is in need of repair.

Here's how it works:

1. If you have a problem with your fax while it is covered by the one-year limited warranty¹, call our toll-free help-line at 1-800-HELPFAX.
2. Talk to one of our technical experts to diagnose your problem over the phone.
3. If repairs are necessary and you are entitled to service under the terms and conditions of the limited warranty³, we will send a refurbished replacement unit to you overnight or second business day delivery, depending on the time of your call.

A second option available under our one-year limited warranty is to mail-in or carry-in your fax to one of our Regional Service centers, where the unit will be repaired and returned to you.

Instructions

If you choose to receive a replacement unit under the Fax Advantage Program, Panasonic will provide a replacement unit which will be completely refurbished, quality-tested by Panasonic technicians and individually hand-inspected before it is shipped to you. You will keep the replacement unit and send the original unit to us in the replacement unit's box. UPS will pick up the unit at no charge to you, should it be determined that you are entitled to warranty service. A proof-of-purchase must be included with the returned product. Any unit that is replaced by Panasonic and not shipped with proper proof-of-purchase by you will be subject to a minimum \$100.00 charge. The original unit must be properly packaged in the same manner as the replacement unit, utilizing the packing materials provided. Damage due

to improper or inadequate packing will be charged to you as an out-of-warranty cost.

If our 1-800-HELPFAX technicians determine that your unit may be an "out-of-box failure"⁴, we will attempt to provide you with a factory-new replacement unit⁵. You must ship a copy of your receipt with your original unit to verify that you purchased the unit within 10 days prior to your 1-800-HELPFAX call.

Requirements

You must give our technicians a valid credit card number (Discover, VISA, Master Card, or American Express/Optima). Product that is not returned to Panasonic by 10 business days after shipment of the replacement product will be charged to your credit card account at Panasonic's Suggested Retail Price (see dealer for details). If your original unit is not eligible for warranty service, your card will be charged for the non-warranty repair of the unit at Panasonic's current rate for parts and labor and for any shipping charges associated with this program. If you do not wish to pay out-of-warranty repair costs, you will be responsible for returning the replacement unit to Panasonic and for paying all shipping charges associated with this program including the overnight delivery of the replacement product to you, shipment of the problem unit to Panasonic, shipment of the replacement unit back to Panasonic and the return of your original unit back to you. Credit status will be verified prior to sending the replacement product.

1. See dealer for limited warranty details.
2. Replacement unit is refurbished.
3. Replacement program excludes Puerto Rico and is subject to termination at any time without advance notice.
4. "Out-of-box failure" is an inoperable unit that was purchased no more than 10 days prior to your 1-800-HELPFAX call, and would otherwise qualify for warranty service under the terms and conditions of the limited warranty.
5. Panasonic reserves the right to send a refurbished unit.

Panasonic Consumer Electronics Company, Division of Matsushita Electric Corporation of America
One Panasonic Way, Secaucus,
New Jersey 07094

Panasonic Sales Company, Division of Matsushita Electric of Puerto Rico, Inc. ("PSC")
Ave. 65 de Infantería, Km. 9.5
San Gabriel Industrial Park, Carolina,
Puerto Rico 00985

Free Manuals Download Website

<http://myh66.com>

<http://usermanuals.us>

<http://www.somanuals.com>

<http://www.4manuals.cc>

<http://www.manual-lib.com>

<http://www.404manual.com>

<http://www.luxmanual.com>

<http://aubethermostatmanual.com>

Golf course search by state

<http://golfingnear.com>

Email search by domain

<http://emailbydomain.com>

Auto manuals search

<http://auto.somanuals.com>

TV manuals search

<http://tv.somanuals.com>