

# Panasonic

## Operating Instructions

---

Personal Facsimile

Model No. **KX-FT901BX**

Model No. **KX-FT903BX**

Facsimile  
with Digital Answering System

Model No. **KX-FT907BX**



KX-FT907

Thank you for purchasing a  
Panasonic fax machine.

Please read these operating  
instructions before using the unit  
and save for future reference.

**1. Installation and Quick Start**

**Installation**

- 1.1 Included accessories ..... 4
- 1.2 Accessory information ..... 4
- 1.3 Connections ..... 5
- 1.4 Recording paper ..... 6

**Quick Start**

- 1.5 Fax sending / Copying ..... 7
- 1.6 Fax receiving ..... 7
- 1.7 Answering device (KX-FT907 only) .... 8
- 1.8 Help function ..... 9

**2. Important Information**

**Important Instructions**

- 2.1 Important safety instructions ..... 10
- 2.2 For best performance ..... 11

**3. Preparation**

**Finding the Controls**

- 3.1 Location of controls ..... 12
- 3.2 Overview ..... 13

**Volume**

- 3.3 Adjusting volume ..... 14

**Initial Programming**

- 3.4 Date and time ..... 14
- 3.5 Your logo ..... 15
- 3.6 Your fax number ..... 17

**4. Telephone**

**Automatic Dialling**

- 4.1 Storing names and telephone numbers for the one-touch dial feature and navigator directory ..... 18
- 4.2 Making phone calls using the one-touch dial feature and navigator directory .. 20

**Recording**

- 4.3 Recording a telephone conversation (KX-FT907 only) ..... 21

**Caller ID**

- 4.4 Caller ID service ..... 21
- 4.5 Viewing and calling back using caller information ..... 22
- 4.6 Storing caller information for the one-touch dial feature and navigator directory ..... 24

**Dial Lock**

- 4.7 Setting the dial lock feature ..... 25

**Voice Contact**

- 4.8 Talking to the other party after fax transmission or reception ..... 26

**5. Fax**

**Sending Faxes**

- 5.1 Sending a fax manually ..... 27
- 5.2 Documents you can send ..... 27
- 5.3 Sending faxes using the one-touch dial feature and navigator directory ..... 28
- 5.4 Broadcast transmission (KX-FT903/ KX-FT907 only) ..... 29
- 5.5 Transmit polling (letting another machine retrieve a fax on your unit) . 31

**Receiving Faxes**

- 5.6 Selecting the way to use your fax machine ..... 32
- 5.7 Receiving a fax manually – Auto answer OFF ..... 34
- 5.8 Receiving a fax automatically – Auto answer ON ..... 35
- 5.9 Receive polling (retrieving a fax placed on another fax machine) ..... 37
- 5.10 Pager call ..... 37

**6. Distinctive Ring**

**Distinctive Ring**

- 6.1 Distinctive Ring service from your phone company ..... 38
- 6.2 Using with the ring detection feature 38

**7. Copy**

**Copying**

- 7.1 Making a copy ..... 39

**8. Answering Device (KX-FT907 only)**

**Greeting**

- 8.1 Recording your greeting messages .. 40

**Memo Message**

- 8.2 Leaving a message for others or yourself ..... 41

**Incoming Messages**

- 8.3 Listening to recorded messages ..... 41

**Remote Operation**

- 8.4 Operating from a remote location ..... 43

**Message transfer**

- 8.5 Transferring recorded messages to another telephone ..... 45

**9. Programmable Features**

**Features**

- 9.1 Programming ..... 46
- 9.2 Basic features ..... 47
- 9.3 Advanced features ..... 48

## 10.Help

### Error Messages

- 10.1 Error messages – Reports ..... 51
- 10.2 Error messages – Display ..... 51

### Troubleshooting

- 10.3 When a function does not work, check here ..... 53

### Jams

- 10.4 Recording paper jams ..... 55
- 10.5 Document jams – sending ..... 56

### Cleaning

- 10.6 Document feeder / scanner glass cleaning ..... 57
- 10.7 Thermal head / head cover cleaning 58

## 11.General Information

### Printed Reports

- 11.1 Reference lists and reports ..... 59

### Specifications

- 11.2 Specifications ..... 60

### User record

- 11.3 User record ..... 61

## 12.Index

- 12.1 Index ..... 62

## 1. Installation and Quick Start

### 1.1 Included accessories

No.	Item	Quantity
①	Power cord	1
②	Telephone line cord	1
③	Handset	1
④	Handset cord	1
⑤	Recording paper (10 metres long)	1
⑥	Paper stacker (KX-FT903/KX-FT907 only)	1
⑦	Operating instructions	1

①

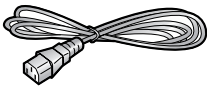

②



③

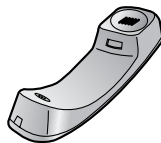

④

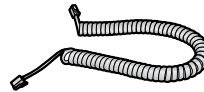

⑤

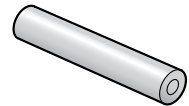

⑥



⑦



#### Note:

- If any items are missing or damaged, contact the place of purchase.
- Save the original carton and packing materials for future shipping and transportation of the unit.

### 1.2 Accessory information

Model No.	Item	Note
KX-A106	Standard thermal recording paper	216 mm × 30 m roll, with 25 mm core

#### Note:

- Use only the included or specified recording paper. Using other recording paper may affect print quality and/or cause excessive wear to the thermal head.

## 1.3 Connections

- ① Handset cord
  - The longer, uncoiled end should be connected to the unit.
- ② Telephone line cord
  - Connect to the single telephone line jack.
- ③ Power cord
  - Connect to the power outlet (220 V – 240 V, 50/60 Hz).
- ④ Paper stacker (KX-FT903/KX-FT907 only)
  - The paper stacker may not be shown in all illustrations in these operating instructions.
- ⑤ [EXT] jack (KX-FT901/KX-FT903 only)
  - Remove the stopper if attached.
- ⑥ Extension telephone (not included)

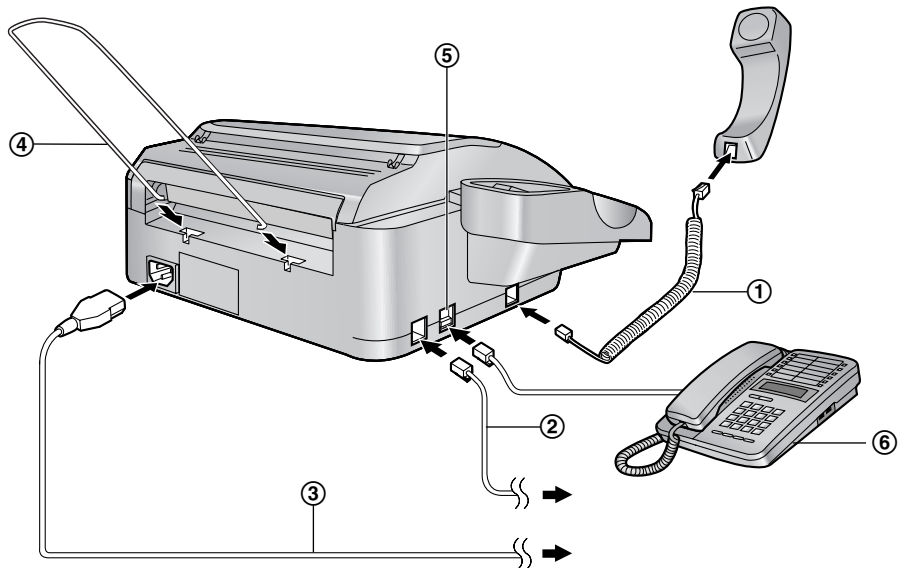
**Caution:**

- When you operate this product, the power outlet should be near the product and easily accessible.
- Keep the unit away from walls to prevent a recording paper jam as far as possible.

## 1.4 Recording paper

- 1 Open the cover by pressing the cover open button (1).

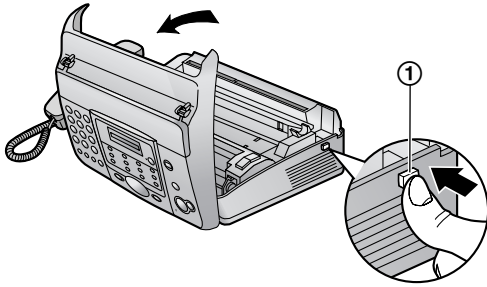

- 2 Install the recording paper.

**Correct**

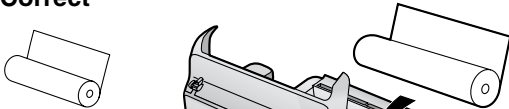

**Incorrect**



- 3 Insert the leading edge of the paper into the opening above the thermal head (1).

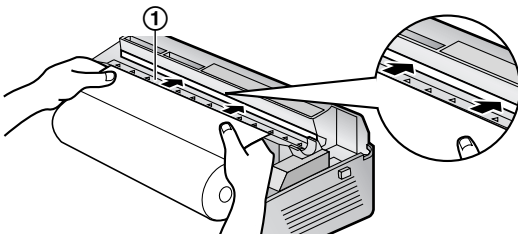

- 4 Pull the paper out of the unit.

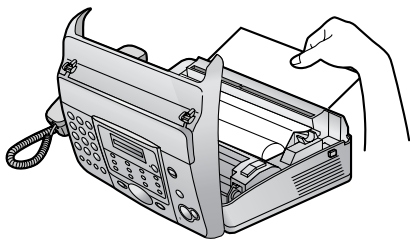

- Make sure that there is no slack in the paper roll.

- 5 Close the cover securely by pushing down on both sides.

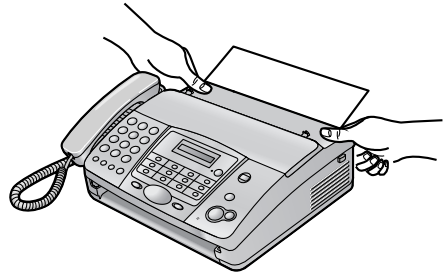

- 6 For KX-FT901:  
Press **[FAX/START]**, then tear off the excess paper by pulling it towards you.



- For KX-FT903/KX-FT907:  
Press **[FAX/START]** to cut the paper.

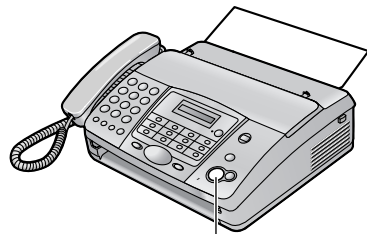

**[FAX/START]**

**Note:**

- If the paper is secured with glue or tape, cut approximately 15 cm from the beginning of the roll before installing it.
- When the power cord is connected, a message is printed each time the cover is opened then closed. If the recording paper is installed upside down, the message will not be printed. Install the paper correctly.
- For accessory information, see page 4.

## 1.5 Fax sending / Copying

- 1 Open the document feeder tray.

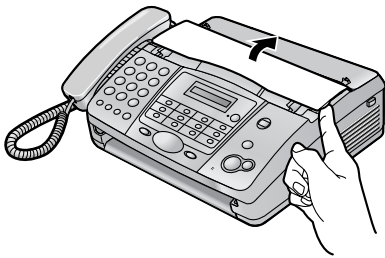

- 2 Adjust the document guides (1), and insert the document FACE DOWN.

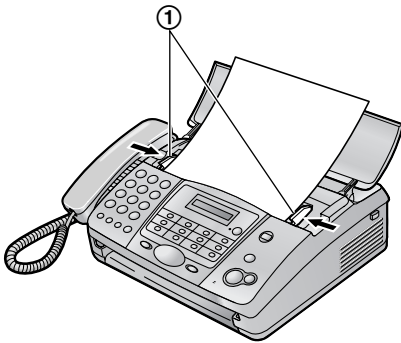

- 3 To send a fax:  
Dial the fax number and press  
[FAX/START].

To make a copy:  
Press [COPY].

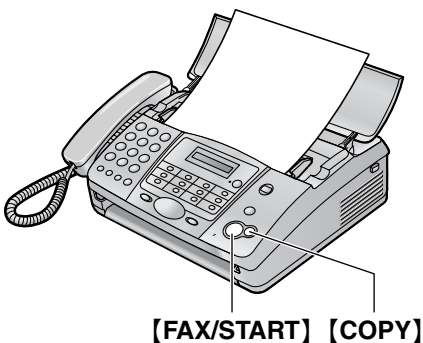

- For further details to send a fax, see page 27.  
For further details to make a copy, see page 39.

## 1.6 Fax receiving

- 1 Lift the handset to answer the call.
- 2 To receive a fax document, press  
[FAX/START].

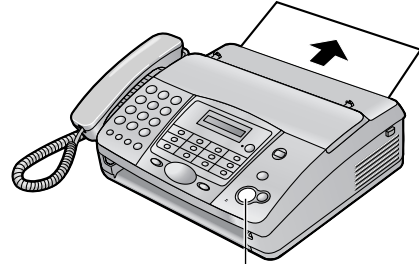

[FAX/START]

- For further details, see page 34.
- You can select how you want the unit to receive calls according to your needs (page 32).

### 1.7 Answering device (KX-FT907 only)

#### 1.7.1 Recording your own greeting message

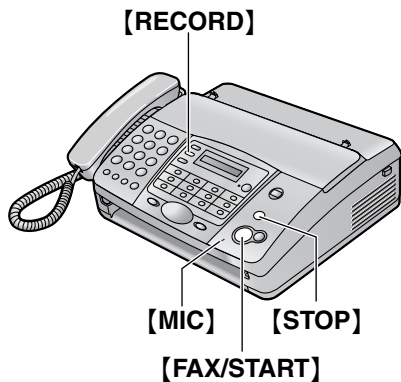

- ❶ Press **[RECORD]** 2 times.
  - ❷ Press **[FAX/START]**.
  - ❸ Speak clearly about 20 cm away from **[MIC]**, for up to 16 seconds.
  - ❹ To stop recording, press **[STOP]**.
- For further details, see page 40.

#### 1.7.2 Listening to recorded messages

The display will show the total number of recorded messages.

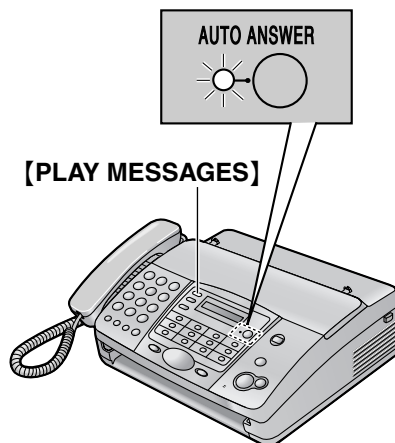

#### When the **[AUTO ANSWER]** indicator flashes:

Press **[PLAY MESSAGES]**. New messages will be played.

#### When the **[AUTO ANSWER]** indicator is ON:

Press **[PLAY MESSAGES]**. All messages will be played.

- For further details, see page 41.



## 1.8 Help function

The unit contains helpful information which can be printed for quick reference.

### How to set up:

How to program your unit.

### Directory:

How to use the one-touch dial feature and navigator directory.

### Auto answer:

Explanation of the auto answer setting.

### Caller ID:

How to use the Caller ID features.

### Telephone answering device operation (KX-FT907 only):

How to use the answering device.



- 1 Press **[HELP]** repeatedly to display the desired item.
- 2 Press **[SET]**.
  - The selected item will be printed.

### 2.1 Important safety instructions

When using this unit, basic safety precautions should always be followed to reduce the risk of fire, electric shock, or personal injury.

1. Read and understand all instructions.
2. Follow all warnings and instructions marked on this unit.
3. Unplug this unit from power outlets before cleaning. Do not use liquid or aerosol cleaners. Use a damp cloth for cleaning.
4. Do not use this unit near water, for example near a bathtub, wash bowl, kitchen sink, etc.
5. Place the unit securely on a stable surface. Serious damage and/or injury may result if the unit falls.
6. Do not cover slots and openings on the unit. They are provided for ventilation and protection against overheating. Never place the unit near radiators, or in a place where proper ventilation is not provided.
7. Use only the power source marked on the unit. If you are not sure of the type of power supplied to your home, consult your dealer or local power company.
8. For safety purposes this unit is equipped with a grounded plug. If you do not have this type of outlet, please have one installed. Do not defeat this safety feature by tampering with the plug.
9. Do not place objects on the power cord. Install the unit where no one can step or trip on the cord.
10. Do not overload power outlets and extension cords. This can result in the risk of fire or electric shock.
11. Never push any objects through slots in this unit. This may result in the risk of fire or electric shock. Never spill any liquid on the unit.
12. To reduce the risk of electric shock, do not disassemble this unit. Take the unit to an authorised service centre when service is required. Opening or removing covers may expose you to dangerous voltage or other risks. Incorrect reassembly can cause electric shock when the unit is subsequently used.
13. Unplug this unit from power outlets and refer servicing to an authorised service centre when the following conditions occur:
  - A. When the power cord is damaged or frayed.
  - B. If liquid has been spilled into the unit.
  - C. If the unit has been exposed to rain or water.
  - D. If the unit does not work normally by following the operating instructions. Adjust only controls covered by the operating instructions. Improper adjustment may require extensive work by an authorised service centre.
  - E. If the unit has been dropped or physically damaged.
  - F. If the unit exhibits a distinct change in performance.
14. During thunderstorms, avoid using telephones except cordless types. There may be a remote risk of an electric shock from lightning.
15. Do not use this unit to report a gas leak, when in the vicinity of the leak.

<b>SAVE THESE INSTRUCTIONS</b>
--------------------------------

#### CAUTION:

##### Installation

- Never install telephone wiring during a lightning storm.
- Never install telephone jacks in wet locations unless the jack is specifically designed for wet locations.
- Never touch uninsulated telephone wires or terminals unless the telephone line has been disconnected at the network interface.
- Use caution when installing or modifying telephone lines.
- Do not touch the plug with wet hands.

#### WARNING:

- To prevent the risk of fire or electrical shock, do not expose this product to rain or any type of moisture.

### 2.2 For best performance

#### Environment

- Keep the unit away from electrical noise generating devices, such as fluorescent lamps and motors.
- The unit should be kept free from dust, high temperature and vibration.
- The unit should not be exposed to direct sunlight.
- Do not place heavy objects on top of the unit.
- The unit should be kept away from heat sources such as heaters, kitchen stoves, etc. It also should not be placed in rooms where the temperature is less than 5 °C or greater than 35 °C. Damp basements should also be avoided.

#### Connection

- If any other device is connected on the same line, this unit may disturb the network condition of the device.
- If you use the unit with a computer and your internet provider instructs you to install a filter (①), please connect the telephone line cord as follows.

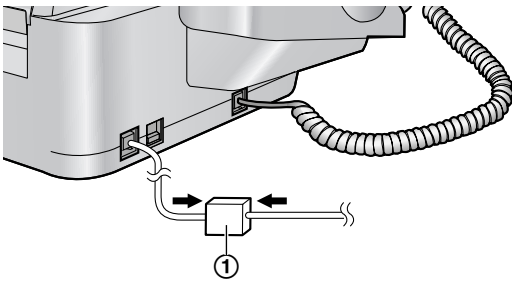

#### Speakerphone operation (KX-FT907 only)

- Use the speakerphone in a quiet room.

#### Routine care

- Wipe the outer surface of the unit with a soft cloth. Do not use benzine, thinner, or any abrasive powder.

## 3.1 Location of controls

KX-FT901  
KX-FT903

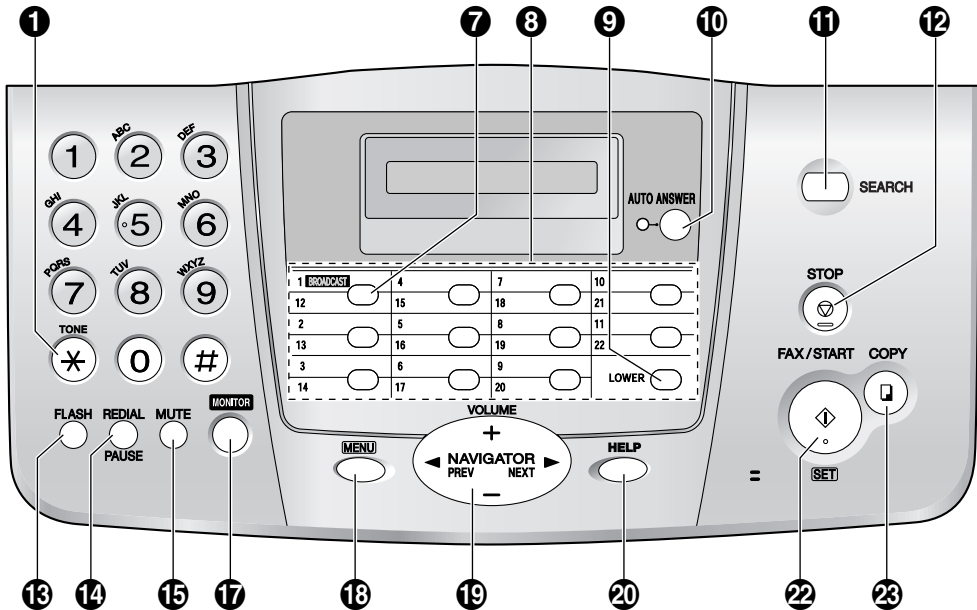

\* The pictured model is KX-FT903.

KX-FT907

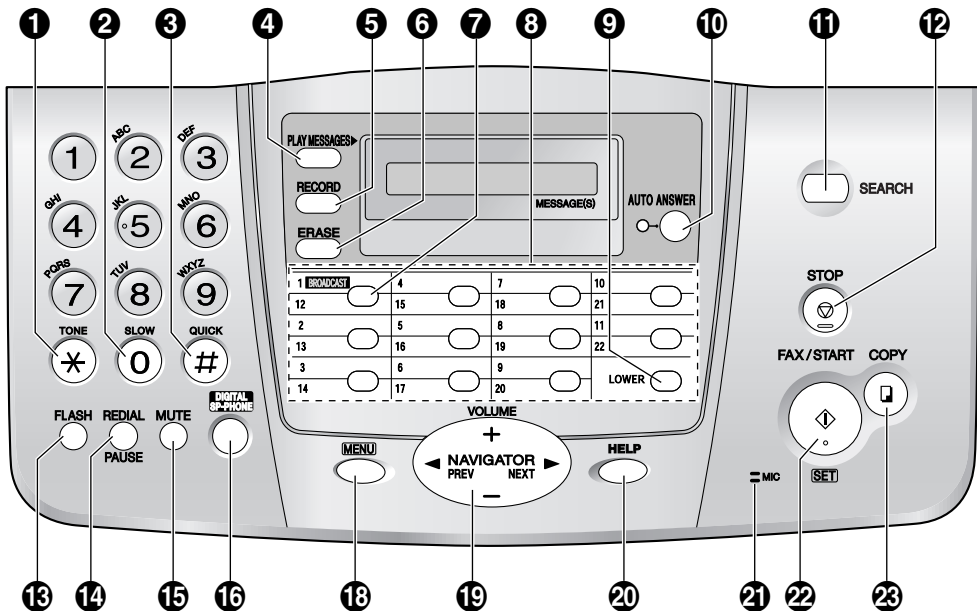

- 1 [TONE]**
  - To change from pulse to tone temporarily during dialling when your line has rotary pulse services.
- 2 [SLOW] (KX-FT907 only)**
  - To slow down message playback (page 42).
- 3 [QUICK] (KX-FT907 only)**
  - To speed up message playback (page 42).
- 4 [PLAY MESSAGES] (KX-FT907 only)**
  - To play messages (page 41).
- 5 [RECORD] (KX-FT907 only)**
  - To record messages (page 40, 41).
- 6 [ERASE] (KX-FT907 only)**
  - To erase messages (page 40, 42).
- 7 [BROADCAST] (KX-FT903/KX-FT907 only)**
  - To transmit a document to multiple parties (page 29).
- 8 Station keys**
  - To use the one-touch dial feature (page 18, 20, 28).
- 9 [LOWER]**
  - To select stations 12–22 for the one-touch dial feature (page 18, 20, 28).
- 10 [AUTO ANSWER]**
  - To turn ON/OFF the auto answer setting (page 32).
- 11 [SEARCH]**
  - To use Caller ID features (page 22, 24).
- 12 [STOP]**
  - To stop an operation or programming.
- 13 [FLASH]**
  - To access special telephone services or for transferring extension calls.
- 14 [REDIAL][PAUSE]**
  - To redial the last number dialled. If the line is busy when you make a phone call using the **[MONITOR]** (KX-FT901/KX-FT903)/**[DIGITAL SP-PHONE]** (KX-FT907) button, the unit will automatically redial the number up to 5 times.
  - To insert a pause during dialling.
- 15 [MUTE]**
  - To mute your voice to the other party during a conversation. Press this button again to resume the conversation.
- 16 [DIGITAL SP-PHONE] (KX-FT907 only)**
  - For speakerphone operation (page 11, 20).

- 17 [MONITOR] (KX-FT901/KX-FT903 only)**
  - To initiate dialling without lifting the handset.
- 18 [MENU]**
  - To initiate or exit programming.
- 19 [NAVIGATOR][VOLUME]**
  - To adjust volume (page 14).
  - To search for a stored item (page 20, 28).
  - To select features or feature settings during programming (page 46).
  - To navigate to the next operation.
- 20 [HELP]**
  - To print helpful information for quick reference (page 9).
- 21 [MIC] (KX-FT907 only)**
  - The built-in microphone.
- 22 [FAX/START][SET]**
  - To start sending or receiving a fax.
  - To store a setting during programming.
- 23 [COPY]**
  - To copy a document (page 39).

## 3.2 Overview

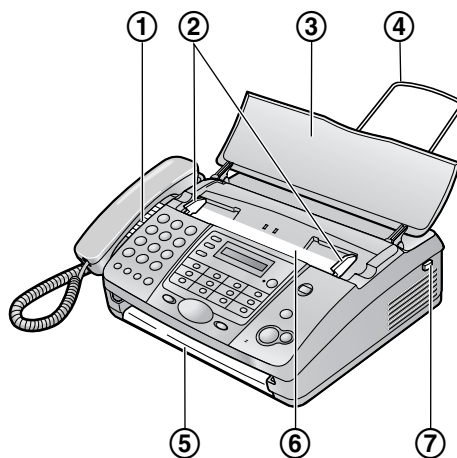

\* The pictured model is KX-FT907.

- 1 Speaker**
- 2 Document guides**
- 3 Document feeder tray**
- 4 Paper stacker (KX-FT903/KX-FT907 only)**
  - The paper stacker may not be shown in all illustrations in these operating instructions.
- 5 Document exit**
- 6 Document entrance**
- 7 Cover open button**

## 3.3 Adjusting volume

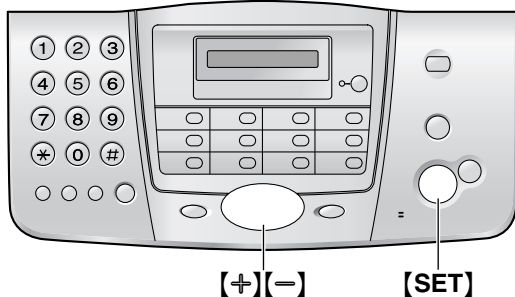

### Ringer volume

4 levels (high/medium/low/off) are available.

While the unit is idle, press [+] or [-].

- If any documents are in the document entrance, you cannot adjust the volume. Confirm that there are no documents in the entrance.

### To turn the ringer OFF

1. Press [-] repeatedly to display "RINGER OFF= OK?".
2. Press [SET].
  - When a call is received, the unit will not ring and will display "INCOMING CALL".
  - To turn the ringer back ON, press [+].

### Handset receiver volume

3 levels (high/middle/low) are available.

While using the handset, press [+] or [-].

### Speaker volume

8 levels (high to low) are available.

While using the monitor/speakerphone, press [+] or [-].

### Voice guidance volume (KX-FT907 only)

9 levels (high to off) are available.

While listening to voice guidance, press [+] or [-].

### Answering device volume (KX-FT907 only)

9 levels (high to off) are available.

While listening to recorded messages, press [+] or [-].

## 3.4 Date and time

You must set the date and time.

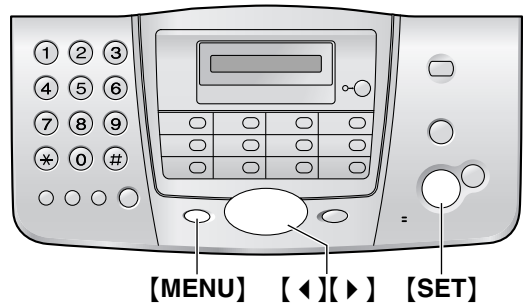

- 1 Press [MENU].

```
SYSTEM SET UP
```

- 2 Press [SET].

```
PRESS [◀▶] & [SET]
```

- 3 Press [◀] or [▶] repeatedly to display the following.

```
SET DATE & TIME
```

- 4 Press [SET].

- The underbar shows the position of the cursor.

```
M: 01 / D: 01 / Y: 04
```

- 5 Enter the current month/date/year by selecting 2 digits for each.

**Example: August 10, 2004**

Press [0][8] [1][0] [0][4].

```
M: 08 / D: 10 / Y: 04
```

- 6 Press [SET].

```
TIME: 12 : 00AM
```

- 7 Enter the current hour/minute by selecting 2 digits for each. Press [\*] repeatedly to select "AM" or "PM".

**Example: 3:15PM (12 hour clock entry only)**

1. Press [0][3] [1][5].

```
TIME: 03 : 15AM
```

2. Press [\*] repeatedly to display "PM".

```
TIME: 03 : 15PM
```

- 8 Press [SET].

- The next feature will be displayed.

- 9 Press [MENU] to exit.

**Note:**

- The other party's fax machine will print the date and time on each page you send according to your unit's date and time setting.
- The accuracy of the clock is approximately  $\pm 60$  seconds a month.

**To correct a mistake**

Press [◀] or [▶] to move the cursor to the incorrect number, and make the correction.

## 3.5 Your logo

The logo can be your name or the name of your company.

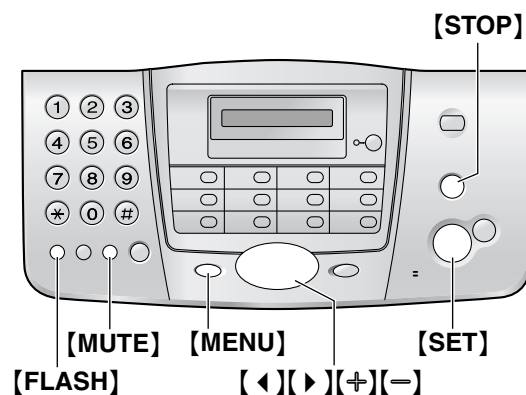

- 1 Press [MENU].

SYSTEM SET UP

- 2 Press [SET].

PRESS [◀▶] & [SET]

- 3 Press [◀] or [▶] repeatedly to display the following.

YOUR LOGO

- 4 Press [SET].

- The underbar shows the position of the cursor.

LOGO=\_

- 5 Enter your logo, up to 30 characters. See the following character table for details.

- 6 Press [SET].

- The next feature will be displayed.

- 7 Press [MENU] to exit.

**Note:**

- Your logo will be printed on each page sent from your unit.

**To enter characters with the dial keypad**

Keys	Characters
[1]	1 [ ] { } + - / = , . _ ` : ; ?
[2]	A B C a b c 2
[3]	D E F d e f 3

### 3. Preparation

Keys	Characters
[4]	G H I g h i 4
[5]	J K L j k l 5
[6]	M N O m n o 6
[7]	P Q R S p q r s 7
[8]	T U V t u v 8
[9]	W X Y Z w x y z 9
[0]	0 ( ) < > ! " # \$ % & ¥ * @ ^ ' →
[FLASH]	To enter a hyphen.
[MUTE]	To insert a space.
[STOP]	To delete a digit.

#### Note:

- To enter another character located on the same number key, press [▶] to move the cursor to the next space.

#### To enter your logo

Example: "BILL"

1. Press [2] 2 times.

LOGO=B

2. Press [4] 3 times.

LOGO=BI

3. Press [5] 3 times.

LOGO=BIL

4. Press [▶] to move the cursor to the next space and press [5] 3 times.

LOGO=BILL

#### To correct a mistake

Press [◀] or [▶] to move the cursor to the incorrect character, and make the correction.

#### To delete a character

Press [◀] or [▶] to move the cursor to the character you want to delete and press [STOP].

- To erase all of the characters, press and hold [STOP].

#### To insert a character

1. Press [◀] or [▶] to move the cursor to the position to the right of where you want to insert the character.

2. Press [MUTE] to insert a space and enter the character.

#### To select characters using [+] or [-]

Instead of pressing the dial keys, you can select characters using [+] or [-].

1. Press [+] repeatedly to display the desired character. Characters will be displayed in the following order:
  - ① Uppercase letters
  - ② Number
  - ③ Symbol
  - ④ Lowercase letters
  - If you press [-], the order will be reversed.
2. Press [▶] to insert the character.
3. Return to step 1 to enter the next character.



## 3.6 Your fax number

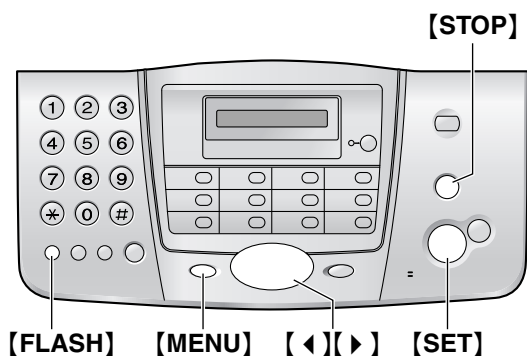

### To delete a number

Press [◀] or [▶] to move the cursor to the number you want to delete and press **[STOP]**.

- To erase all of the numbers, press and hold **[STOP]**.

- 1 Press **[MENU]**.

SYSTEM SET UP

- 2 Press **[SET]**.

PRESS [◀▶] & [SET]

- 3 Press [◀] or [▶] repeatedly to display the following.

YOUR FAX NO.

- 4 Press **[SET]**.

- The underbar shows the position of the cursor.

NO. = \_

- 5 Enter your fax number, up to 20 digits.

Example: NO. = 1234567 \_

- 6 Press **[SET]**.

- The next feature will be displayed.

- 7 Press **[MENU]** to exit.

### Note:

- Your fax number will be printed on each page sent from your unit.
- The **[\*]** button enters a "+" and the **[#]** button enters a space.

**Example: +234 5678**

Press **[\*][2][3][4][#][5][6][7][8]**.

- To enter a hyphen in a telephone number, press **[FLASH]**.

### To correct a mistake

Press [◀] or [▶] to move the cursor to the incorrect number, and make the correction.

### 4.1 Storing names and telephone numbers for the one-touch dial feature and navigator directory

For rapid access to frequently dialled numbers, the unit provides the one-touch dial feature (22 items) and navigator directory (100 items).

- You can also send faxes using the one-touch dial feature and navigator directory (page 28).

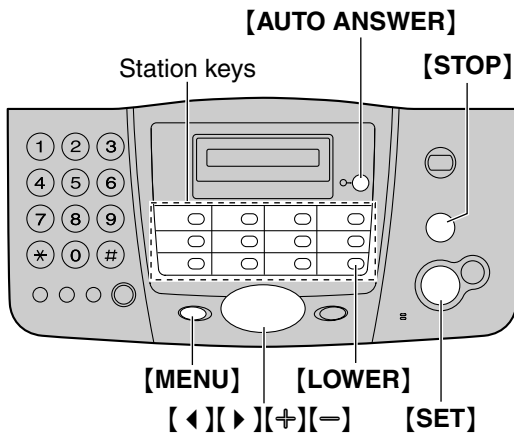

#### 4.1.1 Storing one-touch dial items

- 1 Press **[MENU]** repeatedly to display "STATION KEY".
- 2 Press **[SET]**.
- 3 Select the desired station key.

**For station 1:**  
**(KX-FT901)**

Press station 1.

**(KX-FT903/KX-FT907)**

Press station 1, then press **[SET]**.

**For stations 2–11:**

Press one of the station keys.

**For stations 12–22:**

Press **[LOWER]**, then press one of the station keys.

- 4 Enter the name, up to 10 characters (see page 15 for instructions).
- 5 Press **[SET]**.
- 6 Enter the telephone number, up to 30 digits.

- 7 Press **[SET]**.
  - To program other items, repeat steps 3 to 7.
- 8 Press **[MENU]**.

**Helpful hints:**

- You can confirm the stored items on the display (page 20) or by printing the telephone number list (page 59).

**Note:**

- A hyphen or a space entered in a telephone number counts as 2 digits.

**To correct a mistake**

Press **[<]** or **[>]** to move the cursor to the incorrect character/number, and then make the correction.

**To delete a character/number**

Press **[<]** or **[>]** to move the cursor to the character/number you want to delete, and press **[STOP]**.

- To erase all of the characters/numbers, press and hold **[STOP]**.

#### 4.1.2 Storing navigator directory items

- 1 Press **[MENU]** repeatedly to display "DIRECTORY SET".
- 2 Press **[SET]**.
- 3 Enter the name, up to 10 characters (see page 15 for instructions).
- 4 Press **[SET]**.
- 5 Enter the telephone number, up to 30 digits.
- 6 Press **[SET]**.
  - To program other items, repeat steps 3 to 6.
- 7 Press **[MENU]**.

**Helpful hints:**

- You can confirm the stored items on the display (page 20) or by printing the telephone number list (page 59).

**Note:**

- If "SPACE= 5 DIRS." is displayed, you can store only 5 more items.
- A hyphen or a space entered in a telephone number counts as 2 digits.

---

### To correct a mistake

Press [◀] or [▶] to move the cursor to the incorrect character/number, and then make the correction.

---

### To delete a character/number

Press [◀] or [▶] to move the cursor to the character/number you want to delete, and press [STOP].

- To erase all of the characters/numbers, press and hold [STOP].

---

### To keep the telephone number secret

Press [AUTO ANSWER] after entering the telephone number in the navigator directory (step 5 on page 18).

- A secret number cannot be viewed after it is stored.
- The telephone number will not appear in the telephone number list (page 59).
- This feature is not available when storing a telephone number for the one-touch dial feature.

### 4.1.3 Editing a stored item

- 1 Press [▶].
- 2 Press [⊕] or [⊖] repeatedly to display the desired item.
- 3 Press [MENU].
- 4 Press [✖].
  - If you do not need to edit the name, skip to step 6.
- 5 Edit the name. For further details, see the storing procedure on page 18.
- 6 Press [SET].
  - If you do not need to edit the telephone number, skip to step 8.
- 7 Edit the telephone number. For further details, see the storing procedure on page 18.
- 8 Press [SET].

### 4.1.4 Erasing a stored item

- 1 Press [▶].
- 2 Press [⊕] or [⊖] repeatedly to display the desired item.
- 3 Press [MENU].
- 4 Press [⊡].

- To cancel erasing, press [STOP] 2 times.

- 5 Press [SET].

### 4.2 Making phone calls using the one-touch dial feature and navigator directory

Before using this feature, store the desired names and telephone numbers for the one-touch dial feature and navigator directory (page 18).

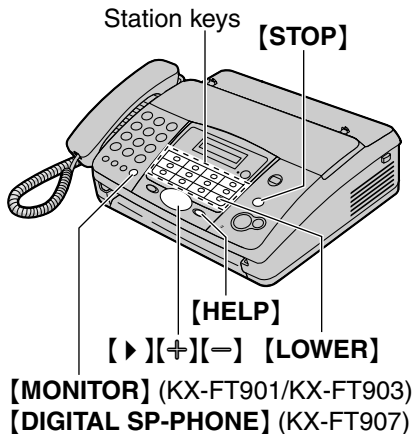

#### 4.2.1 Using the one-touch dial feature

1 Press **[MONITOR]** (KX-FT901/KX-FT903)/**[DIGITAL SP-PHONE]** (KX-FT907) or lift the handset.

2 Select the desired station key.

**For stations 1–11:**

Press the desired station key.

**For stations 12–22:**

Press **[LOWER]**, then press the desired station key.

- The unit will start dialling automatically.

#### 4.2.2 Using the navigator directory

1 Press **[▶]**.

2 Press **[+]** or **[-]** repeatedly to display the desired item.

3 Press **[MONITOR]** (KX-FT901/KX-FT903)/**[DIGITAL SP-PHONE]** (KX-FT907) or lift the handset.

- The unit will start dialling automatically.

#### To confirm the stored telephone number on the display

1. Press **[▶]**.
2. Press **[+]** or **[-]** until the desired name is displayed.
3. Press **[HELP]**.
  - To stop the operation, press **[STOP]**.
  - To make a call, press **[MONITOR]** (KX-FT901/KX-FT903)/**[DIGITAL SP-PHONE]** (KX-FT907) or lift the handset.

#### To search for a name by initial

**Example:** "LISA"

1. Press **[▶]**.
2. Press **[+]** or **[-]** to initiate the navigator directory.
3. Press **[5]** repeatedly to display any name with the initial "L" (see the character table, page 15).
  - To search for symbols (not letters or numbers), press **[\*]**.
4. Press **[-]** repeatedly to display "LISA".
  - To stop the search, press **[STOP]**.
  - To dial the displayed party, press **[MONITOR]** (KX-FT901/KX-FT903)/**[DIGITAL SP-PHONE]** (KX-FT907) or lift the handset.

### 4.3 Recording a telephone conversation (KX-FT907 only)

You can record a telephone conversation. This conversation can be played back later, either directly (page 41) or remotely (page 43).

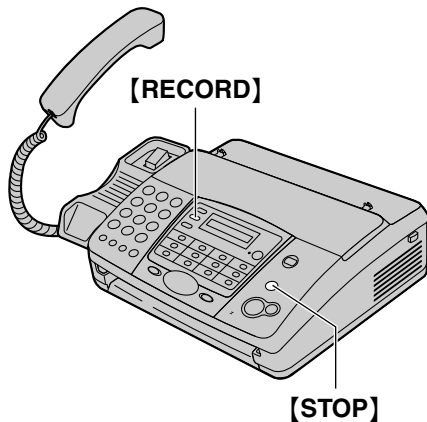

- 1 During a telephone conversation, press **[RECORD]**.
  - "2WAY RECORDING" will be displayed.
- 2 To stop recording, press **[STOP]** or replace the handset.

#### Note:

- You can also record a speakerphone telephone conversation.
- There may be legal restrictions on recording two-way telephone conversations. Inform the other party that the conversation is being recorded.

### 4.4 Caller ID service

This unit is compatible with the Caller ID service offered by your local telephone company. To use this feature, you must subscribe to a Caller ID service.

#### Important:

- This unit is designed in accordance with the ETS (European Telecommunication Standard) and only supports the basic CLIP (Calling Line Identification Presentation) features.
- This unit will only display the caller's telephone number and name.
- This unit will not support future additional telephone services.
- Depending on the service of the local telephone company, the date/time of the call or the caller's name may not be displayed.

Make sure the following ring settings are set to 2 or more rings beforehand.

- For KX-FT901/KX-FT903: FAX ring setting (feature #07, page 47) and TEL/FAX ring setting (feature #09, page 47)
- For KX-FT907: TAD ring setting (feature #06, page 47), FAX ring setting (feature #07, page 47) and TEL/FAX ring setting (feature #09, page 47)

#### 4.4.1 How Caller ID is displayed

The calling party's telephone number or name will be displayed after the first ring. You then have the option of whether or not to answer the call.

The unit will automatically store caller information (telephone number, name and the time of the call) of the 20 most recent calls. Caller information is stored by the most recent to the oldest call. When the 21st call is received, the oldest call is deleted.

Caller information can be viewed on the display one item at a time (page 22) or confirmed by printing the Caller ID list (page 59).

#### Note:

- If the unit is connected to a PBX (Private Branch Exchange) system, caller information may not be received properly. Consult your PBX supplier.
- If the unit cannot receive caller information, the following will be displayed:  
"OUT OF AREA": The caller dialed from an area which does not provide Caller ID service.

## 4. Telephone

“PRIVATE CALLER”: The caller requested not to send caller information.

“LONG DISTANCE”: The caller made a long distance call.

### To confirm caller information using the Caller ID list

- To print manually, see page 59.
- To print automatically after every 20 new calls, activate feature #26 (page 48).

## 4.5 Viewing and calling back using caller information

You can easily view caller information and call back.

### Important:

- **Calling back will not be possible in the following cases:**
  - The telephone number includes data other than numbers (i.e., \* or #).
  - The caller information does not include a telephone number.
  - The dial lock feature is activated (page 25).

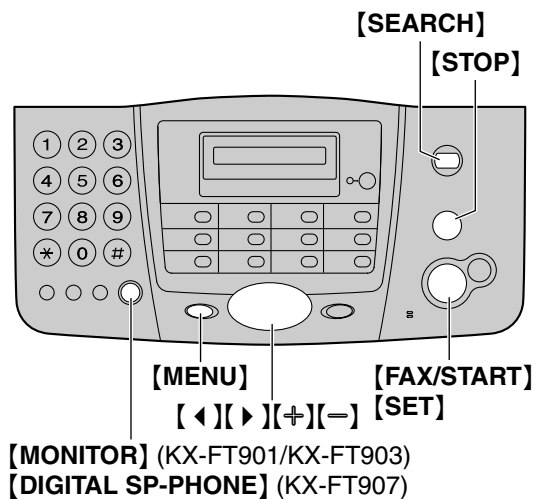

- 1 Press **[SEARCH]**.
- 2 Press **[+]** to search from the most recently received caller information.
  - If you press **[-]**, the display order will be reversed.
- 3 Press **[MONITOR]** (KX-FT901/KX-FT903)/**[DIGITAL SP-PHONE]** (KX-FT907) or lift the handset to return the call.
  - The unit will start dialling automatically.
  - To send a fax, insert the document FACE DOWN and press **[FAX/START]**.

### To change the display of caller information

Press **[SEARCH]** repeatedly after step 2.

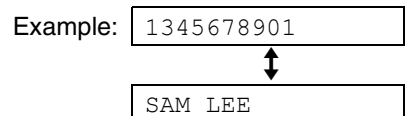

- The time of the call cannot be displayed. To confirm the time of the call, print the Caller ID list (page 59).

---

### Display while viewing

- When the unit could not receive a name, the display will show "NO NAME RCVD".
- When no calls have been received, the display will show "NO CALLER DATA".

---

### To stop viewing

Press **[STOP]** after step 2.

## 4.5.1 Editing a caller's telephone number before calling back

- 1 Press **[SEARCH]**.
- 2 Press **[+]** or **[-]** repeatedly to display the desired item.
- 3 Press **[SEARCH]** to display the telephone number.
- 4 To insert a number in front of the telephone number, press the desired dial key (0 to 9).
  - You can also initiate the editing mode by pressing **[\*]**.
- 5 Press **[MONITOR]** (KX-FT901/KX-FT903)/**[DIGITAL SP-PHONE]** (KX-FT907) or lift the handset to call back the edited number.
  - The unit will start dialling automatically.
  - To send a fax, insert the document FACE DOWN and press **[FAX/START]**.

#### Note:

- The edited telephone number will not be saved in the caller information. To store it into the navigator directory, see page 24.

---

### To correct a mistake

1. Press **[◀]** or **[▶]** to move the cursor to the incorrect number.
2. Press **[STOP]** to delete the number.
3. Enter the correct number.

---

### To delete a number

Press **[◀]** or **[▶]** to move the cursor to the number you want to delete and press **[STOP]**.

- To erase all of the numbers, press and hold **[STOP]**.

---

### To insert a number

1. Press **[◀]** or **[▶]** to move the cursor to the position to the right of where you want to insert the number.
2. Enter the number.

## 4.5.2 Erasing all caller information

- 1 Press **[MENU]** repeatedly to display "CALLER SET UP".
- 2 Press **[SET]**.
  - "CALL LIST ERASE" will be displayed.
- 3 Press **[SET]**.
  - To cancel erasing, press **[STOP]** 2 times.
- 4 Press **[SET]**.
- 5 Press **[STOP]**.

## 4.5.3 Erasing specific caller information

- 1 Press **[SEARCH]**.
- 2 Press **[+]** or **[-]** repeatedly to display the desired item.
- 3 Press **[◀]**.
  - To cancel erasing, press **[STOP]**.
- 4 Press **[SET]**.
  - To erase other items, repeat step 2 to 4.
- 5 Press **[STOP]**.

### 4.6 Storing caller information for the one-touch dial feature and navigator directory

**Important:**

- This feature is not available in the following cases.
  - The telephone number includes data other than numbers (i.e., \* or #).
  - The caller information does not include a telephone number.

- Stored names can be up to 10 characters long.
- To edit a name and number, see page 19.
- If caller information does not include the caller's name, enter the name manually. See the instructions on page 18.
- If you assign an item to a station key which already contains an item, the previous item will be replaced.

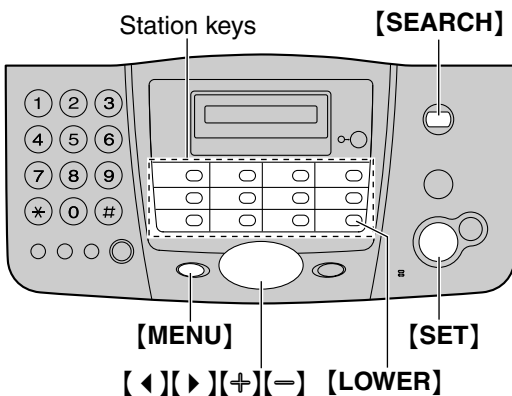

- 1 Press **[SEARCH]**.
- 2 Press **[+]** or **[-]** repeatedly to display the desired item.
- 3 Press **[MENU]**.
- 4 Select the station key or navigator directory.

**For stations 1–11:**

1. Press the desired station key.
2. Press **[SET]**.

**For stations 12–22:**

1. Press **[LOWER]**, then press the desired station key.
2. Press **[SET]**.

**For navigator directory:**

1. Press **[<]** or **[>]**.
2. Press **[SET]**.

- 5 Press **[SET]**.

**Note:**

- You can confirm the stored items by printing the telephone number list (page 59).



## 4.7 Setting the dial lock feature

Dial lock feature allows you to prevent others from making calls.

During the setting procedure of this feature;

- you must store a PIN (Personal Identification Number). This PIN is required when turning OFF dial lock.
- you must store at least one telephone number for emergency purpose. Up to 3 telephone numbers can be stored.

When the dial lock is activated, only numbers stored as emergency numbers can be dialled.

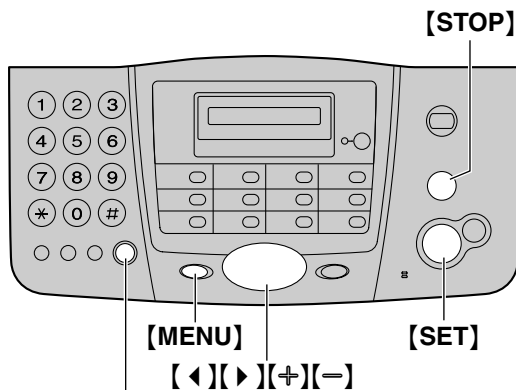

**[MONITOR]** (KX-FT901/KX-FT903)  
**[DIGITAL SP-PHONE]** (KX-FT907)

- 1 Press **[MENU]** repeatedly to display "DIAL LOCK".
  - 2 Press **[SET]**.
- CODE= \_
- 3 Enter a 2–4 digit PIN using the dial keys 0–9.
    - **Please note your PIN. If you forget your PIN, consult your nearest Panasonic service centre.**
  - 4 Press **[SET]**.
- E01= \_
- 5 Enter an emergency telephone number, up to 30 digits.
  - 6 Press **[SET]**.
  - 7 If necessary, enter a second emergency telephone number.
    - If you do not need to enter, skip to step 8.
  - 8 Press **[SET]**.

- 9 If necessary, enter a third emergency telephone number.
  - If you do not need to enter, skip to step 10.

- 10 Press **[SET]**.

### Note:

- You can also enter an emergency telephone number using the one-touch dial feature and navigator directory in steps 5, 7 and 9. Press **[+]** or **[-]** repeatedly to display the desired item, then press **[SET]**.

### To correct an emergency telephone number

Press **[◀]** or **[▶]** to move the cursor to the incorrect number, and make the correction.

- To delete a digit, move the cursor to the number you want to delete, and press **[STOP]**.
- To erase all of the digits, press and hold **[STOP]**.

### To make an emergency call

1. Press **[MONITOR]** (KX-FT901/KX-FT903)/**[DIGITAL SP-PHONE]** (KX-FT907) or lift the handset while the unit displays "DIAL LOCK".
2. Press **[+]** or **[-]** repeatedly to display the desired emergency telephone number.
3. Press **[SET]**.
  - The unit will start dialling automatically.
  - If any documents are in the document entrance, the unit will start fax transmission.

### To turn OFF dial lock

1. Press **[MENU]** repeatedly to display "DIAL LOCK".
2. Press **[SET]**.
3. Enter your PIN.
4. Press **[SET]**.

### 4.8 Talking to the other party after fax transmission or reception

You can talk to the other party after sending or receiving a fax (**voice contact feature**). This will save the added expense and time of making another call.

**Important:**

- This feature can be used only if the other party's fax machine is equipped with a voice contact feature.

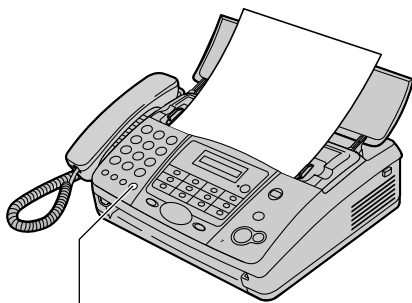

**[MONITOR]** (KX-FT901/KX-FT903)  
**[DIGITAL SP-PHONE]** (KX-FT907)

#### 4.8.1 Initiating voice contact

- 1 Press **[MONITOR]** (KX-FT901/KX-FT903)/**[DIGITAL SP-PHONE]** (KX-FT907) while sending or receiving a fax.
  - Your unit will display "VOICE STANDBY". The other party's fax machine will ring.
  - When the other party answers, your unit will ring.
- 2 Press **[DIGITAL SP-PHONE]** (KX-FT907) or lift the handset to start talking.

**Note:**

- When your unit rings while using this feature, the ring will sound slightly different than the ring heard when a call is received.
- If you initiate voice contact while sending a fax and the other party answers, your unit will ring after all of the documents have been sent.
- If you initiate voice contact while receiving a fax and the other party answers, your unit will ring after the current page has been received.

#### 4.8.2 Receiving a request for voice contact

- 1 If the other party initiates voice contact, your unit will ring and "PLEASE PICK UP" will be displayed.
- 2 Press **[DIGITAL SP-PHONE]** (KX-FT907) or lift the handset within 10 seconds and start talking.

**Note:**

- If you do not answer within 10 seconds after your unit starts ringing:
  - In TAD/FAX mode, your unit will play a greeting message and record an incoming voice message (KX-FT907 only).
  - In FAX ONLY, TEL or TEL/FAX mode, the line will be disconnected.

## 5.1 Sending a fax manually

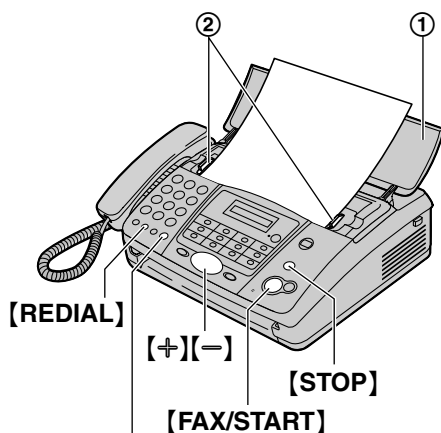

[MONITOR] (KX-FT901/KX-FT903)  
[DIGITAL SP-PHONE] (KX-FT907)

- 1 Open the document feeder tray (①).
- 2 Adjust the width of the document guides (②) to fit the actual size of the document.
- 3 Insert the document (up to 10 pages) FACE DOWN until the unit grasps the document and a single beep is heard.
  - If the document guides are not adjusted to fit the document, re-adjust them.
- 4 If necessary, press **[+]** or **[-]** repeatedly to select the desired resolution.
- 5 Press **[MONITOR]** (KX-FT901/KX-FT903)/**[DIGITAL SP-PHONE]** (KX-FT907) or lift the handset.
- 6 Dial the fax number.
- 7 **When a fax tone is heard:**  
Press **[FAX/START]**.

### When the other party answers your call:

Ask them to press their start button. When the fax tone is heard, press **[FAX/START]**.

- If you pressed **[MONITOR]** in step 5, lift the handset before speaking.

### To select the resolution

Select the desired resolution according to the type of document.

- “STANDARD”: For printed or typewritten documents with normal-sized characters.
- “FINE”: For documents with small printing.
- “SUPER FINE”: For documents with very small printing. This setting is effective only

when the other party has a compatible fax machine.

- “PHOTO”: For documents containing photographs, shaded drawings, etc.
- Using the “FINE”, “SUPER FINE” and “PHOTO” settings will increase transmission time.
- If the resolution setting is changed during feeding, it will be effective from the next page.

### To redial the last number

Press **[REDIAL]**.

- If the line is busy, the unit will automatically redial the number up to 5 times.
- To cancel redialling, press **[STOP]**.

### To send more than 10 pages at a time

Insert the first 10 pages of the document. Add the other pages (up to 10 at a time) before the last page feeds into the unit.

### To stop transmission

Press **[STOP]**.

- To eject the document, press **[STOP]** again.

### Printing a sending report

A sending report provides you with a printed record of transmission results. To print sending reports, make sure feature #04 is activated (page 47). For an explanation of error messages, see page 51.

### Printing a journal report

A journal report provides you with a printed record of the 35 most recent faxes. To print manually, see page 59. To print automatically after every 35 new fax transmissions and receptions, make sure feature #22 is activated (page 48). For an explanation of error messages, see page 51.

## 5.2 Documents you can send

### Minimum document size

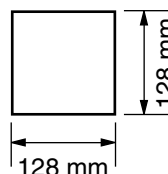

### Maximum document size

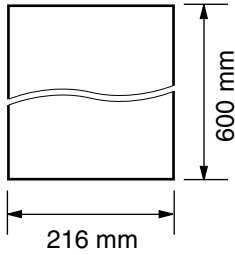

### Effective scanning area

- Shaded area will be scanned.

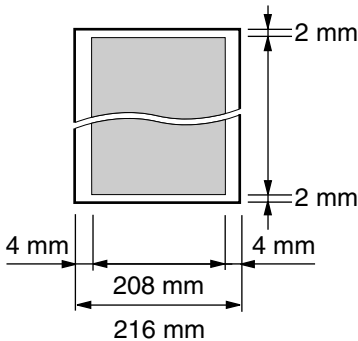

### Document weight

- Single sheet: 45 g/m<sup>2</sup> to 90 g/m<sup>2</sup>
- Multiple sheets: 60 g/m<sup>2</sup> to 80 g/m<sup>2</sup>

### Note:

- Remove clips, staples or other fasteners.
- Do not send the following types of documents: (Make a copy of the document and send the copy.)
  - Chemically treated paper such as carbon or carbonless duplicating paper
  - Electrostatically charged paper
  - Badly curled, creased or torn paper
  - Paper with a coated surface
  - Paper with a faint image
  - Paper with printing on the opposite side that can be seen through the other side, such as newsprint.
- Check that ink, paste or correction fluid has dried completely.
- To send a document with a width of less than 210 mm, we recommend using a copy machine to copy the original document onto A4 or letter-sized paper, then sending the copied document.

## 5.3 Sending faxes using the one-touch dial feature and navigator directory

Before using this feature, store the desired names and telephone numbers for the one-touch dial feature and navigator directory (page 18).

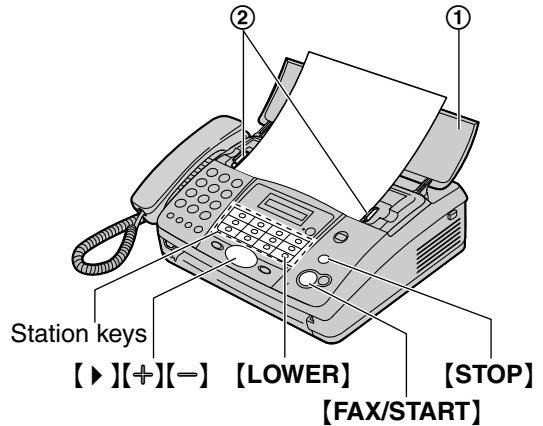

- 1 Open the document feeder tray (①).
- 2 Adjust the width of the document guides (②) to fit the actual size of the document.
- 3 Insert the document (up to 10 pages) FACE DOWN until the unit grasps the document and a single beep is heard.
  - If the document guides are not adjusted to fit the document, re-adjust them.
- 4 If necessary, press **[+]** or **[-]** repeatedly to select the desired resolution (page 27).
- 5 Enter the fax number.

#### Using stations 1–11:

Press the desired station key.

#### Using stations 12–22:

Press **[LOWER]**, then press the desired station key.

#### Using navigator directory:

Press **[▶]**, then press **[+]** or **[-]** to display the desired item and press **[FAX/START]**.

### Fax auto redial

If the line is busy or if there is no answer, the unit will automatically redial the number up to 5 times.

- To cancel redialling, press **[STOP]**.

**If your unit does not send a fax**

- Confirm that you have entered the number correctly, and that the number is a fax number.
- Confirm that the other party's fax machine is answering by turning ON the connecting tone feature (feature #76, page 50).

## 5.4 Broadcast transmission (KX-FT903/KX-FT907 only)

By storing one-touch dial and navigator directory items (page 18) into the broadcast memory, you can send the same document to multiple parties (up to 10). Your programmed items will remain in the broadcast memory, allowing frequent re-use.

- The broadcast function utilises station 1. The one-touch dial function will be cancelled.
- Both one-touch dial and navigator directory items can be stored into the broadcast memory.

### 5.4.1 Programming items into the broadcast memory

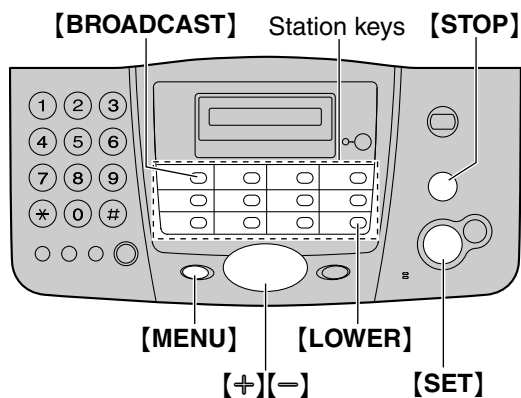

- 1 Press **[MENU]** repeatedly to display "STATION KEY".
- 2 Press **[SET]**.
- 3 Press **[BROADCAST]**.
- 4 Press **[+]** or **[-]** repeatedly to display "BROADCAST".
- 5 Press **[SET]**.
- 6 Press **[SET]**.
  - The number in brackets indicates the number of registered items.

## 5. Fax

### 7 Program items.

#### Using stations 2–11:

Press the desired station key.

#### Using stations 12–22:

Press **[LOWER]**, then press the desired station key.

#### Using navigator directory:

Press **[+]** or **[-]** repeatedly to display the desired item and press **[SET]**.

- To program other items, repeat this step (up to 10 items).

### 8 Press **[SET]**.

#### Note:

- If you program the wrong item, press **[STOP]** after step 7 to erase the item.
- If you edit a stored item (page 19) in the broadcast memory, the programmed broadcast function will be cancelled. You must re-program.

### 5.4.2 Sending the same document to pre-programmed parties

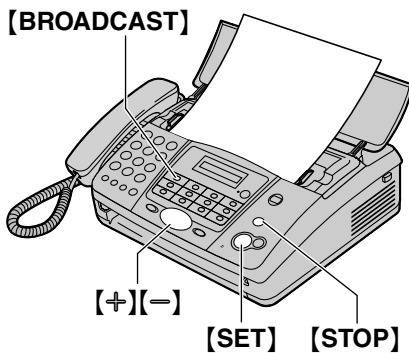

- 1 Insert the document FACE DOWN.
- 2 If necessary, press **[+]** or **[-]** repeatedly to select the desired resolution (page 27).
- 3 Press **[BROADCAST]**.
  - The document will be fed into the unit and scanned into memory. The unit will then send the data to each party, calling each number sequentially.
  - After transmission, the stored document will be erased from memory automatically, and the unit will automatically print the transmission result (**Broadcast sending report**).

#### Note:

- If you select “FINE”, “SUPER FINE” or “PHOTO” resolution, the number of pages that the unit can send will decrease.
- If the document exceeds the memory capacity, sending will be cancelled.
- If a party is busy or does not answer, it will be skipped and redialled later up to 5 times.

#### To cancel broadcast transmission

1. Press **[STOP]** while “BROADCASTING” is displayed.
  - The display will show “SEND CANCELLED?”.
2. Press **[SET]**.

## 5.5 Transmit polling (letting another machine retrieve a fax on your unit)

This feature allows another person to call your unit to retrieve a document fed into your unit. This allows you to send a fax without paying for the phone call. This feature can be used when the unit is set to TAD/FAX (KX-FT907 only), FAX ONLY or TEL/FAX mode.

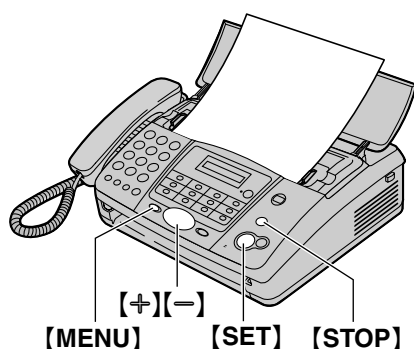

- 1 Insert the document FACE DOWN.
  - If necessary, press **[+]** or **[-]** repeatedly to select the desired resolution (page 27).
- 2 Press **[MENU]** repeatedly to display "POLLED".
- 3 Press **[SET]**.
- 4 Press **[+]** or **[-]** repeatedly to select "ON".
- 5 Press **[SET]**.

### Note:

- The caller is charged for the call, not you.
- When delayed transmission is activated (feature #25, page 48), transmit polling is not possible.

### To cancel transmit polling

1. Press **[STOP]** while "POLLED ON" is displayed.
  - The display will show "CANCEL POLLED".
2. Press **[SET]**.

### 5.6 Selecting the way to use your fax machine

Depending on your situation, select the way you prefer to use your fax machine.

- Use as a telephone answering device and/or fax (TAD/FAX mode) (KX-FT907 only)
- Use only as a fax (FAX ONLY mode)
- Use as a telephone and/or fax (TEL/FAX mode)
- Use mostly as a telephone (TEL mode)

#### 5.6.1 Use as a telephone answering device and/or fax (TAD/FAX mode) (KX-FT907 only)

##### Your situation

You want to answer phone calls using the telephone answering device and receive faxes automatically.

##### How to setup

Set the fax machine to TAD/FAX mode (page 35) by pressing **[AUTO ANSWER]** repeatedly.

- The **[AUTO ANSWER]** indicator turns ON.



##### Note:

- Make sure feature #05 is set to "TAD/FAX" beforehand (page 47).
- Do not connect an answering machine to the same telephone line. If connected, turn OFF the auto answer setting by pressing **[AUTO ANSWER]** repeatedly.

##### How phone calls and faxes are received

If the call is a phone call, the fax machine will record the caller's message automatically.

If a fax calling tone is detected, the fax machine will receive the fax automatically.

#### 5.6.2 Use only as a fax (FAX ONLY mode)

##### Your situation

You have a separate telephone line just for faxes.

##### How to setup

Set the fax machine to FAX ONLY mode (page 36) by pressing **[AUTO ANSWER]** repeatedly.

- The **[AUTO ANSWER]** indicator turns ON.

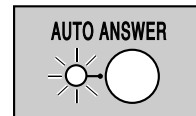

##### Note:

- Make sure feature #05 is set to "FAX ONLY" beforehand (page 47).

##### How faxes are received

All incoming calls will be answered as faxes.



### 5.6.3 Use as a telephone and/or fax (TEL/FAX mode)

#### Your situation

You want to answer phone calls yourself and receive faxes automatically without rings.

#### How to setup

Set the fax machine to TEL/FAX mode (page 36) by pressing **[AUTO ANSWER]** repeatedly.

- The **[AUTO ANSWER]** indicator turns ON.

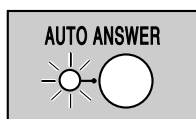

#### Note:

- Make sure feature #05 is set to "TEL/FAX" beforehand (page 47).

#### How phone calls and faxes are received

If the call is a phone call, the fax machine will ring.

If a fax calling tone is detected, the fax machine will receive the fax automatically without ringing.

### 5.6.4 Use mostly as a telephone (TEL mode)

#### Your situation

You want to answer calls by yourself. If a fax call is received, you must receive the fax manually.

#### How to setup

Set the fax machine to TEL mode (page 34) by pressing **[AUTO ANSWER]** repeatedly.

- The **[AUTO ANSWER]** indicator turns OFF.

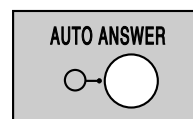

#### How to receive phone calls and faxes

You have to answer all calls manually.  
To receive a fax, press **[FAX/START]**.

# 5.7 Receiving a fax manually – Auto answer OFF

## 5.7.1 Activating TEL mode

Set the fax machine to TEL mode by pressing **[AUTO ANSWER]** repeatedly to display the following.

TEL MODE

- The **[AUTO ANSWER]** indicator turns OFF.

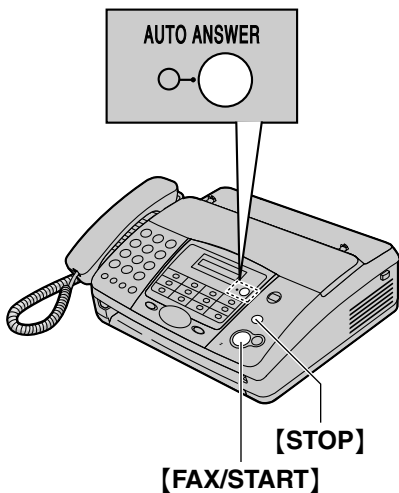

## How to receive phone calls and faxes

1. Lift the handset to answer the call.
2. When:
  - document reception is required,
  - a fax calling tone (slow beep) is heard, or
  - no sound is heard,press **[FAX/START]**.

CONNECTING.....

- The unit will start fax reception.
3. Replace the handset.

### Note:

- If you do not answer the call within 10 rings:

#### For KX-FT901/KX-FT903:

The unit will temporarily switch to fax reception. The other party can then send a fax.

#### For KX-FT907:

The unit will temporarily activate the answering device. The greeting message will

then be played and the other party can then send a fax.

## To stop receiving

Press **[STOP]**.

## Extension telephone

You can receive faxes using an extension telephone.

1. When the extension telephone rings, lift the handset of the extension telephone.
2. When:
  - document reception is required,
  - a fax calling tone (slow beep) is heard, or
  - no sound is heard,press **[\*][#][9]** (default fax activation code) **firmly**.
3. Replace the handset.
  - The fax machine will start reception.

### Note:

- To receive fax documents using the extension telephone, make sure the remote fax activation is turned ON beforehand (feature #41, page 49).

## 5.8 Receiving a fax automatically – Auto answer ON

### 5.8.1 Activating TAD/FAX mode (KX-FT907 only)

- 1 Make sure feature #05 is set to "TAD/FAX" beforehand (page 47).
- 2 Press **[AUTO ANSWER]** repeatedly to display the following.

TAD/FAX MODE

- The **[AUTO ANSWER]** indicator turns ON.
- The unit will play the pre-recorded greeting message. You can record your own greeting message (page 40).
- The remaining time for recording incoming messages will be displayed.

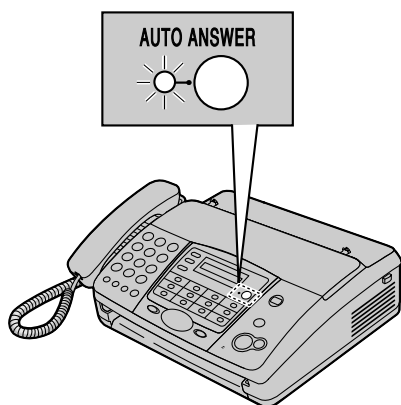

#### Note:

- The maximum incoming message recording time can be changed (feature #10, page 47).
- While an incoming call is being recorded, you can monitor it through the speaker. If this feature is not required, turn OFF feature #67 (page 50).

#### How phone calls and faxes are received

When receiving calls, the unit works as an answering device and/or fax.

- If the call is a phone call, the unit will record the caller's message automatically.
- If a fax calling tone is detected, the unit will receive the fax automatically.

#### Receiving a voice message and fax document in one call

The caller can leave a voice message and send a fax document during the same call. Inform the caller of the following procedure beforehand.

1. The caller calls your unit.
  - The answering device will answer the call.
2. The caller can leave a message after the greeting message.
3. The caller presses **[\*][9]**.
  - The unit will activate the fax function.
4. The caller presses the start button to send a fax.

#### Ring setting in TAD/FAX mode

You can choose from "1", "2" (default), "3", "4", "TOLL SAVER" and "RINGER OFF". This setting can be changed by feature #06, page 47.

- "TOLL SAVER": The unit answers after 2 rings when new messages have been recorded, and after 4 rings when there are no new messages. If you call your unit from a remote location to listen to new messages (page 43), you will know that there are no messages when the unit rings for the 3rd time. You can then hang up without being charged for the call.
- "RINGER OFF": The unit will answer without ringing.
  - If you subscribe to a Caller ID service, set to 2 or more rings.

## 5. Fax

### 5.8.2 Activating FAX ONLY mode

- 1 Make sure feature #05 is set to "FAX ONLY" beforehand (page 47).
- 2 Press **[AUTO ANSWER]** repeatedly to display the following.

FAX ONLY MODE

- The **[AUTO ANSWER]** indicator turns ON.



#### How faxes are received

When receiving calls, the unit will automatically answer all calls and only receive fax documents.

#### Note:

- The number of rings before a call is answered in FAX ONLY mode can be changed (feature #07, page 47).

### 5.8.3 Activating TEL/FAX mode

- 1 Make sure feature #05 is set to "TEL/FAX" beforehand (page 47).
- 2 Press **[AUTO ANSWER]** repeatedly to display the following.

TEL/FAX MODE

- The **[AUTO ANSWER]** indicator turns ON.
- 3 The ringer volume setting should be ON (page 14).

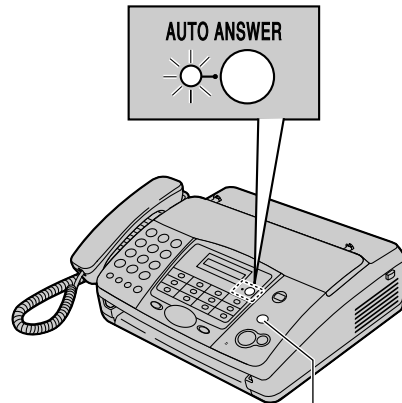

**[STOP]**

#### How phone calls and faxes are received

1. "INCOMING CALL" will be displayed but the unit will not ring.
2. The unit will wait for the duration of **2 rings** before answering the call.
  - The number of rings is determined by the "TEL/FAX delayed ring setting" (feature #09, page 47).
  - During this time, an extension telephone (if connected) will ring.
3. The unit will answer the call and try to detect a fax calling tone.

#### When a fax calling tone is detected

The unit receives the fax automatically without ringing.

#### When a fax calling tone is not detected

- ① If you recorded your TEL/FAX greeting message (page 40), it will be played for the caller (KX-FT907 only).
- ② The unit will ring **3 times**. You may answer the call.
  - The number of rings is determined by the "Silent fax recognition ring setting" (feature #30, page 48).

- Callers will hear a ring back tone different from the one generated by the telephone company.
  - An extension telephone (if connected) will not ring at this time. To answer the call with the extension telephone, lift the handset and press **[\*][0]** (default auto disconnection code) while the fax machine is ringing.
- ③ If you do not answer the call, the unit will activate the fax function.
- Some fax machines do not generate fax calling tones when sending faxes, therefore the unit will try to receive a fax even if no fax calling tone is detected.

**Note:**

- If the ring detection feature is activated (page 38) and a different ring pattern is received, the fax machine will not receive a fax automatically.
- The auto disconnection code can be changed in feature #49 on page 49.
- Even when you answer a call with the extension telephone and press the auto disconnection code, the fax machine may activate the fax function depending on the type of an extension telephone. Press **[STOP]** on the fax machine to talk with the calling party.

- 2 Press **[SET]**.
- 3 Dial the fax number.
- 4 Press **[SET]**.
  - The unit will start reception.

## 5.10 Pager call

This feature allows your unit to call your pager each time a caller leaves a message (KX-FT907 only) or your unit receives a fax.

- 1 Press **[MENU]**.
- 2 Press **[#]**, then **[7][0]**.
- 3 Press **[SET]**.
- 4 Press **[+]** or **[-]** repeatedly to select "ON".
- 5 Press **[SET]**.
- 6 Enter your pager number and any necessary dialling pauses (up to 46 digits).
 

**Example:**

  - 1 **202 555 1234PP12345678**
    - **1 202 555 1234:** Your pager number
    - **PP:** Pauses
    - **12345678:** Your pager access code, if required.
- 7 Press **[SET]**.
- 8 Press **[MENU]**.

## 5.9 Receive polling (retrieving a fax placed on another fax machine)

This feature allows you to retrieve a document from another compatible fax machine. Therefore you pay for the call.

Make sure that no documents are fed into your unit and that the other party's machine is ready for your call.

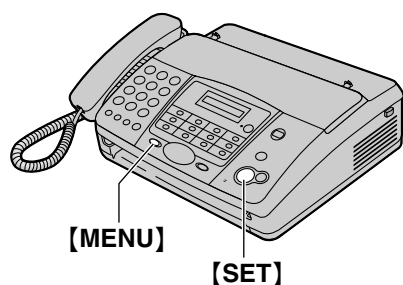

- 1 Press **[MENU]** repeatedly to display "POLLING".

### 6.1 Distinctive Ring service from your phone company

This service is convenient if you wish to have a different number for your fax machine and telephone, even when you use them on a single telephone line.

Distinctive Ring is a service offered by your local telephone company which allows you to use several telephone numbers on one telephone line. When a call is made to one of your phone numbers, the telephone company sends a ring pattern to your telephone line to indicate which number the call is intended for. By setting up this unit for Distinctive Ring, you can make the fax machine automatically start fax reception when a call comes to the fax number.

**To use this service, you must subscribe to the Distinctive Ring service offered by your local telephone company.**

### 6.2 Using with the ring detection feature

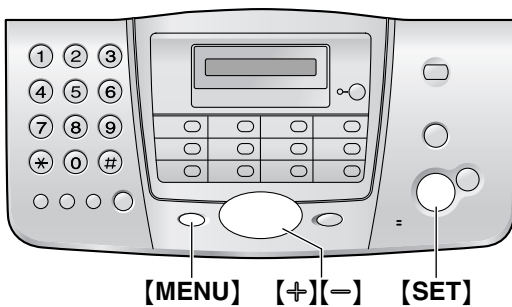





- 1 Press **[MENU]**.
- 2 Press **[\*]**, then **[3][1]**.
- 3 Press **[SET]**.
- 4 Press **[+]** or **[-]** repeatedly to select the ring pattern assigned for fax.
  - "A": Standard ring (one long ring)
  - "B": Double ring (two short rings)
  - "C": Triple ring (short-long-short-rings)
  - "D": Other triple ring (short-short-long rings)
  - "OFF" (default): Turns OFF this feature.
- 5 Press **[SET]**.
  - The unit will print an information list.
- 6 Press **[MENU]**.

**Note:**

- After programming, turn the auto answer setting to OFF (KX-FT901/KX-FT903 only).

**Ring pattern**

Ring pattern	Settings
Standard ring (one long ring)  1st ring      2nd ring	"A"
Double ring (two short rings)  1st ring      2nd ring	"B"
Triple ring (short-long-short rings)  1st ring      2nd ring	"C"
Other triple ring (short-short-long rings)  1st ring      2nd ring	"D"

## 7.1 Making a copy

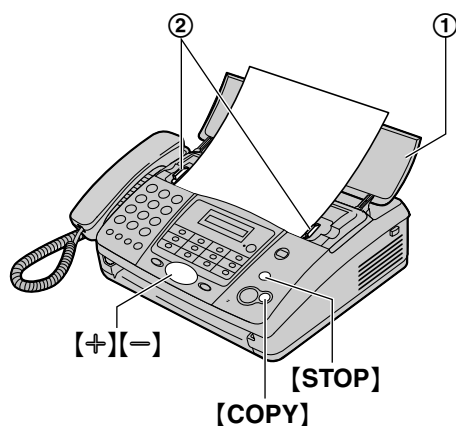

- 1 Open the document feeder tray (①).
- 2 Adjust the width of the document guides (②) to fit the actual size of the document.
- 3 Insert the document (up to 10 pages) FACE DOWN until the unit grasps the document and a single beep is heard.
  - If the document guides are not adjusted to fit the document, re-adjust them.
- 4 If necessary, press **[+]** or **[-]** repeatedly to select the desired resolution.
- 5 Press **[COPY]**.
  - The unit will start copying.

### Note:

- When you copy a multiple-page document which is longer than A4 size paper (approx. 300 mm), we recommend you insert one page at a time.
- Any document which can be sent as a fax can also be copied (page 27).
- The copied recording paper comes out somewhat longer than the document size.

### To select the resolution

Select the desired resolution according to the type of document.

- “FINE”: For printed or typewritten documents with small printing.
- “SUPER FINE”: For documents with very small printing.
- “PHOTO”: For documents containing photographs, shaded drawings, etc.
- If you select “STANDARD”, copying will be done using “FINE” mode.

### To stop copying

Press **[STOP]**.

- To eject the document, press **[STOP]** again.

### 8.1 Recording your greeting messages

You can record your own greeting message. The maximum greeting message length is;

- in TAD/FAX mode: 16 seconds (default) or 60 seconds
- in TEL/FAX mode: 16 seconds

We recommend you record a message of less than 12 seconds to make it easier to receive faxes.

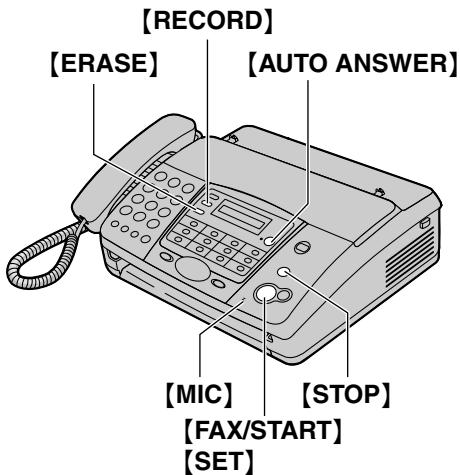

#### 1 For the TAD/FAX greeting message

Press **[RECORD]** 2 times to display "TAD GREETING".

#### For the TEL/FAX greeting message

Press **[RECORD]** 3 times to display "T/F GREETING".

- 2 Press **[FAX/START]**.
  - A long beep will sound.
- 3 Speak clearly about 20 cm away from **[MIC]**.
  - The display will show the remaining recording time.
- 4 To stop recording, press **[STOP]**.
  - The unit will repeat your message.

#### Note:

- You can change the maximum TAD/FAX greeting message recording time to 60 seconds (feature #54, page 49).
  - If you change to 60 seconds, we recommend that you tell the caller in your TAD/FAX greeting message to press **[\*][9]** before starting fax transmission.
  - If you change from 60 seconds to 16 seconds, your TAD/FAX greeting

message will be deleted. The pre-recorded greeting message will be played when a call is received.

#### To check the TAD/FAX greeting message

1. Make sure feature #05 is set to "TAD/FAX" beforehand (page 47).
2. Press **[AUTO ANSWER]** repeatedly to display "TAD/FAX MODE".
  - The unit will play the TAD/FAX greeting message.

#### To check the TEL/FAX greeting message

1. Make sure feature #05 is set to "TEL/FAX" beforehand (page 47).
2. Press **[AUTO ANSWER]** repeatedly to display "TEL/FAX MODE".
  - The unit will play the TEL/FAX greeting message.

### 8.1.1 Erasing your recorded greeting message

#### 1 For the TAD/FAX greeting message

Press **[ERASE]** 2 times to display "TAD GREETING".

#### For the TEL/FAX greeting message

Press **[ERASE]** 3 times to display "T/F GREETING".

- 2 Press **[FAX/START]**.
  - To cancel erasing, press **[STOP]**.
- 3 Press **[SET]**.

#### Note:

- If you erase your TAD/FAX greeting message, the pre-recorded greeting message will be played when a call is received.



## 8.2 Leaving a message for others or yourself

To leave a private message for yourself or someone else, you can record a voice memo. This memo can be played back later, either directly or remotely.

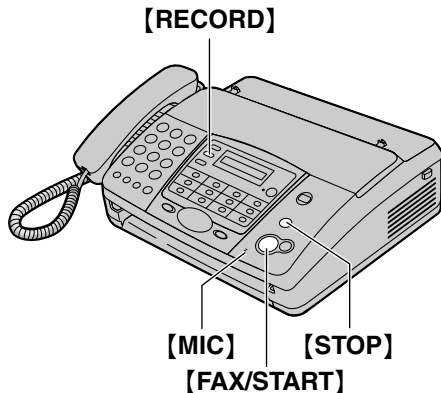

- 1 Press **[RECORD]**.
- 2 Press **[FAX/START]**.
  - A long beep will sound.
- 3 Speak clearly about 20 cm away from **[MIC]**.
- 4 To stop recording, press **[STOP]**.

## 8.3 Listening to recorded messages

When the unit has recorded new voice messages:

- The **[AUTO ANSWER]** indicator will flash when the auto answer setting is turned ON.
- The total number of recorded messages will flash on the display.

**Example:**



- The unit will beep slowly if the message alert feature is activated (feature #42, page 49).

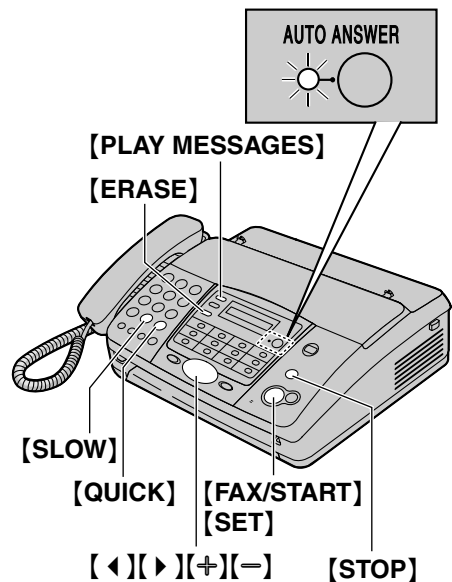

Press **[PLAY MESSAGES]**.

- Only new messages will be played.
  - Adjust the speaker volume using **[+]** or **[-]**.
  - After playing back all of the new messages;
    - the **[AUTO ANSWER]** indicator will stop flashing and will remain lit up when the auto answer setting is turned ON.
    - the total number of recorded messages will stop flashing and remain displayed.
- If you press **[PLAY MESSAGES]** at this time, all recorded messages will be played.

**Note:**

- The total recording time of all messages (greeting, incoming and memo) is **about 20 minutes** when no documents are in memory. If messages are recorded in noisy

## 8. Answering Device (KX-FT907 only)

---

environments, the actual recording time may be less.

---

### To repeat a message

Press [◀] while listening to the message.

- If you press [◀] within 5 seconds of the beginning of the message, the previous message will be played.
- To play back a specific message, press [◀] or [▶] and search for the message you want to listen to.

---

### To skip a message

Press [▶] to play the next message.

---

### To stop playback temporarily

Press [STOP].

- If you press [PLAY MESSAGES] within 1 minute, the unit will resume playing the rest of the messages.

---

### Voice time/day stamp

During playback, the unit will announce the day of the week and time that each message was recorded.

---

### To change the playback speed

Press [QUICK] to play messages at one and a half times the original speed. Press [SLOW] to play messages at half the original speed.

- To return to the original speed, press either [QUICK] or [SLOW] again during quick or slow playback.

## 8.3.1 Erasing recorded messages

### To erase a specific message

Press [ERASE] while listening to the message you want to erase.

### To erase all messages

- 1 Press [ERASE].
- 2 Press [FAX/START].
  - To cancel erasing, press [STOP].
- 3 Press [SET].

## 8.4 Operating from a remote location

You can call your unit from a remote location and access the answering device.

### Important:

- Program the remote operation ID beforehand (feature #11, page 47).
- Set the unit to TAD/FAX mode before going out (page 35).
- Use a touch tone telephone for remote operations.

### Helpful hints:

- When you press a key, press firmly.
- Please make a copy of the following table, and carry it with you when you go out.

Answering device remote operation			
1. Call your unit.		[6]	Room monitor
2. Enter the remote operation ID during the TAD/FAX greeting message.		[7]	Re-records the greeting message
3. Enter a remote command within 10 seconds.		[9]	Stops re-recording of the greeting message
		[*][4]	Erases a specific message
<b>Key</b>	<b>Remote command</b>	[*][5]	Erases all messages
[0]	Skips the greeting message	[8][0]	Changes to TEL mode
[1]	Repeats a message	[8][1]	Turns ON message transfer
[2]	Skips a message	[8][2]	Turns OFF message transfer
[4]	New message playback	[8][3]	Turns ON pager call
[5]	All message playback	[8][4]	Turns OFF pager call

### 8.4.1 Listening to recorded messages

- 1 Call your unit.
- 2 Enter the remote operation ID during the TAD/FAX greeting message.
- 3 **When there are new recorded messages**
  1. A long beep will sound.
  2. Short beep(s) will sound up to 8 times.
    - This indicates the number of new messages.
  3. New messages will be played back.

#### When there are no new messages

1. A long beep will sound (short beep will not sound).
2. Wait for 4 seconds or press [5].
3. All recorded messages will be played back.

#### When voice memory is full

6 beeps will sound after playing back the messages. Erase unnecessary messages.

### 8.4.2 Remote operations using remote commands

[1]: repeats a message. If you press this key within 5 seconds of the beginning of a message, the previous message will be played.

[2]: skips a message.

[4]: plays back new messages.

[5]: plays back all messages.

### 8.4.3 Other remote operations

#### To erase a specific message

Press [\*][4] while listening to the message you want to erase.

- A long beep and 3 short beeps will sound. The unit will then play back the next message.

#### To erase all messages

Press [\*][5] to erase all messages.

- A long beep and 3 short beeps will sound.

## 8. Answering Device (KX-FT907 only)

---

---

### To monitor the room

Press **[6]** to activate the unit's microphone and listen to the room where the unit is located for about 30 seconds.

- After 30 seconds, a beep will sound. To continue monitoring, press **[6]** again within 10 seconds.

---

### To record a marker message

After playing back messages, you can leave an additional message.

1. Wait for 3 beeps indicating the end of the remote operation.
2. Wait for 1 beep.
3. Wait about 10 seconds.
  - The voice guide and/or 1 beep will be heard.
4. Leave a message.

---

### To re-record your greeting message

You can record a new TAD/FAX greeting message.

1. Press **[7]** to start recording.
  - A long beep will sound.
2. Speak clearly for up to 16 seconds.
  - If you pause for over 2 seconds, 6 beeps will sound and recording will stop. Repeat from step 1 within 10 seconds.
3. To stop recording, press **[9]**.
  - The new greeting message will be played.

---

### To skip the greeting message

Press **[0]** during the greeting message playback.

- The unit will skip the rest of the greeting message.

---

### To turn message transfer ON or OFF

You must program a transfer telephone number beforehand (feature #60, page 50).

Press **[8][1]** to turn ON the message transfer.

Press **[8][2]** to turn OFF the message transfer.

- If a transfer telephone number is not programmed, you cannot turn this feature ON. 6 beeps will sound.

---

### To turn pager call ON or OFF

You must program a pager number beforehand (feature #70, page 37).

Press **[8][3]** to turn ON the pager call.

Press **[8][4]** to turn OFF the pager call.

- If a pager number is not programmed, you cannot turn this feature ON. 6 beeps will sound.

---

### To change from TAD/FAX to TEL mode

Press **[8][0]** to change the receiving mode from TAD/FAX to TEL.

- You cannot return to TAD/FAX mode in the same call. To return to TAD/FAX mode, see the following.

---

### To change from TEL to TAD/FAX mode

1. Call your unit and wait for 10 rings.
  - The answering device will temporarily answer the call.
2. Enter the remote operation ID (feature #11, page 47) during the greeting message.
  - A long beep will sound, and your unit will switch to TAD/FAX mode.
3. Hang up the handset.

### 8.5 Transferring recorded messages to another telephone

This feature allows your unit to call a designated telephone number each time a caller leaves a message. You can then listen to the transferred message via remote operation.

#### Important:

- To use this feature, program the transfer telephone number first (feature #60, page 50) and set the unit to TAD/FAX mode.
- You must turn ON the voice guidance feature (feature #47, page 49) or record your own transfer greeting message beforehand.

#### 8.5.1 How this feature works

- 1 An incoming voice message is recorded in your unit while you are out.
- 2 Your unit calls the transfer telephone number.
- 3 You answer the call at the transfer telephone.
- 4 Your unit will play the pre-recorded transfer greeting message.
  - If you recorded your own transfer greeting message, it will be played instead.
- 5 You enter the remote operation ID, and retrieve the message using remote operation (page 43).

#### 8.5.2 Recording your transfer greeting message

The recording time is limited to 16 seconds.

**Sample message:** *"This is a transferred message from (your name, business and/or telephone number). Please enter your remote ID for remote operation."*

- 1 Press **[MENU]**.
- 2 Press **[#]**, then **[6][1]**.
- 3 Press **[SET]**.
- 4 Press **[+]** or **[-]** repeatedly to select "RECORD".
- 5 Press **[SET]**.
- 6 Speak clearly about 20 cm away from **[MIC]**.
  - The display will show the remaining recording time.

- 7 To stop recording, press **[STOP]**.
  - The unit will repeat your message.

- 8 Press **[MENU]**.

#### To check the transfer greeting message

1. Press **[MENU]**, **[#][6][1]**, then **[SET]**.
2. Press **[+]** or **[-]** repeatedly to select "CHECK".
3. Press **[SET]**.
  - The unit will play the message.
4. Press **[MENU]**.

#### To erase your transfer greeting message

1. Press **[MENU]**, **[#][6][1]**, then **[SET]**.
2. Press **[+]** or **[-]** repeatedly to select "ERASE".
3. Press **[SET]**.
4. Press **[MENU]**.

#### Note:

- When transferring a message, the pre-recorded transfer greeting message will be played.
- If the voice guidance feature is turned OFF (feature #47, page 49) and you have erased your own transfer greeting message, the message transfer feature will be cancelled.

### 9.1 Programming

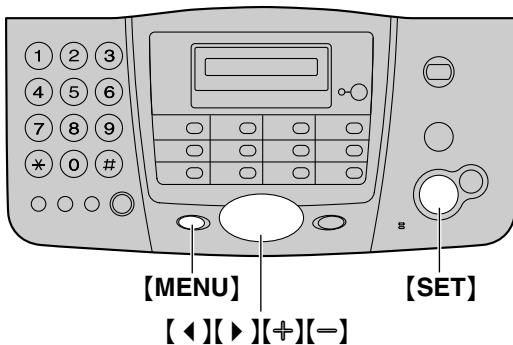

#### 9.1.1 Programming basic features

- 1 Press **[MENU]**.
- 2 Press **[SET]**.
- 3 Select the feature you wish to program. Press **[◀]** or **[▶]** repeatedly to display the desired feature.
- 4 Press **[SET]**.
  - The current setting of the feature will be displayed.
- 5 Press **[⊕]** or **[⊖]** repeatedly to display the desired setting.
  - This step may be slightly different depending on the feature.
- 6 Press **[SET]**.
  - The setting you selected is set, and the next feature will be displayed.
- 7 To exit programming, press **[MENU]**.

#### 9.1.2 Programming advanced features

- 1 Press **[MENU]**.
- 2 Press **[SET]**.
- 3 Press **[◀]** or **[▶]** repeatedly to display "ADVANCED MODE".
- 4 Press **[SET]**.
- 5 Select the feature you wish to program. Press **[◀]** or **[▶]** repeatedly to display the desired feature.
- 6 Press **[SET]**.

- The current setting of the feature will be displayed.
- 7 Press **[⊕]** or **[⊖]** repeatedly to display the desired setting.
    - This step may be slightly different depending on the feature.
  - 8 Press **[SET]**.
    - The setting you selected is set, and the next feature will be displayed.
  - 9 To exit programming, press **[MENU]**.

---

#### To program by entering the program code number directly

You can select a feature by directly entering its program code (# and a 2-digit number) instead of using **[◀]** or **[▶]**.

1. Press **[MENU]**.
2. Press **[#]** and the 2-digit code (page 47 to page 50).
3. Press **[SET]**.
4. Press **[⊕]** or **[⊖]** repeatedly to display the desired setting.
  - This step may be slightly different depending on the feature.
5. Press **[SET]**.
6. To exit programming, press **[MENU]**.

---

#### To cancel programming

Press **[MENU]** to exit.

## 9.2 Basic features

### Code #01: Setting the date and time

SET DATE & TIME

See page 14 for details.

### Code #02: Setting your logo

YOUR LOGO

See page 15 for details.

### Code #03: Setting your fax number

YOUR FAX NO.

See page 17 for details.

### Code #04: Printing a sending report

SENDING REPORT

To print a sending report for fax transmission results (page 27).

“ERROR” (default): A sending report will be printed only when fax transmission fails.

“ON”: A sending report will be printed after every transmission.

“OFF”: Sending reports will not be printed.

### Code #05 (KX-FT901/KX-FT903 only): Changing the receiving mode in the auto answer setting

AUTO ANSWER

“FAX ONLY” (default): Facsimile only mode (page 36)

“TEL/FAX”: Telephone/Facsimile mode (page 36)

### Code #05 (KX-FT907 only): Changing the receiving mode in the auto answer setting

AUTO ANSWER

“TAD/FAX” (default): Telephone Answering Device/Facsimile mode (page 35)

“FAX ONLY”: Facsimile only mode (page 36)

“TEL/FAX”: Telephone/Facsimile mode (page 36)

### Code #06 (KX-FT907 only): Changing the ring setting in TAD/FAX mode

TAD RING COUNT

To change the number of rings before the unit answers a call in TAD/FAX mode. You can select “1”, “2” (default), “3”, “4”, “TOLL SAVER” or “RINGER OFF”. See page 35 for details.

### Code #07: Changing the ring setting in FAX ONLY mode

FAX RING COUNT

To change the number of rings before the unit answers a call in FAX ONLY mode.

You can select “1”, “2” (default), “3” or “4”.

### Code #09: Changing the TEL/FAX delayed ring setting

TEL/FAX RING

If you use an extension telephone in TEL/FAX mode, select the desired number of times the extension telephone rings before the unit answers the call. You can select “1”, “2” (default), “3” or “4”. See page 36 for details.

### Code #10 (KX-FT907 only): Changing the maximum incoming message recording time

RECORDING TIME

“VOX” (default): Unlimited within the voice memory capacity (page 60).

“1 MIN”: Up to 1 minute.

### Code #11 (KX-FT907 only): Setting the remote operation ID

REMOTE TAD ID

1. Press **[MENU]**.
2. Press **[#]**, then **[1][1]**.
3. Press **[SET]**.
4. Enter any 3-digit number except a number using 0 or 7.
  - The default ID is “111”.
5. Press **[SET]**.
6. Press **[MENU]**.

### Code #13: Setting the dialling mode

DIALLING MODE

If you cannot dial, change this setting depending on your telephone line service.

“TONE” (default): For tone dial service.

“PULSE”: For rotary pulse dial service.

### 9.3 Advanced features

#### Code #22: Setting the journal report to print automatically

AUTO JOURNAL

“ON” (default): The unit will print a journal report automatically after every 35 new fax transmissions and receptions (page 27).

“OFF”: The unit will not print a journal report, but will keep a record of the last 35 fax transmissions and receptions.

#### Code #23: Sending documents overseas

OVERSEAS MODE

If you cannot send a fax overseas even if the number is correct and the line is connected, activate this feature before sending the fax. This feature improves the reliability by reducing the transmission speed.

“ON”: After transmission, this feature will turn OFF automatically.

“OFF” (default): Deactivates this feature.

#### Note:

- This feature is not available for broadcast transmission.
- Calling charges may be higher when using this feature.

#### Code #25: Sending a fax at a specific time

DELAYED SEND

This feature allows you to take advantage of low-cost calling hours offered by your telephone company. This feature can be set up to 24 hours in advance of the desired time.

To send a document:

1. Insert the document.
2. If necessary, press **[+]** or **[-]** repeatedly to select the desired resolution (page 27).
3. Press **[MENU]**.
4. Press **[⏏]** then **[2][5]**.
5. Press **[SET]**.
6. Press **[+]** or **[-]** repeatedly to select “ON”.
7. Press **[SET]**.
8. Enter the fax number.
9. Press **[SET]**.
10. Enter the transmission start time.
  - Press **[\*]** repeatedly to select “AM” or “PM”.
11. Press **[SET]**.

#### 12. Press **[MENU]**.

#### Note:

- To cancel after programming, press **[STOP]** then **[SET]**.
- When transmit polling (page 31) is activated, this feature is not available.

#### Code #26: Setting the Caller ID list to print automatically

AUTO CALL. LIST

“ON” (default): The unit will print the Caller ID list automatically after every 20 new calls (page 22).

“OFF”: The unit will not print the Caller ID list, but will keep records of the information for the last 20 callers.

#### Code #30: Changing the silent fax recognition ring setting

SILENT FAX RING

To change the number of times the unit rings while in TEL/FAX mode. You can select “3” (default), “4”, “5”, “6”, “7”, “8” or “9”. See page 36 for details.

#### Code #31: Setting the ring detection feature

RING DETECTION

See page 38 for details.

#### Code #36: Reducing the received document size

AUTO REDUCTION

To slightly reduce the received fax image when printing, so that the received document will be approximately the same length as the original document.

“ON” (default): The received fax image will be printed slightly smaller than the original image.

“OFF”: Deactivates this feature. The received fax image will be printed at the same size as the original image.

#### Note:

- An slight margin will be added to the printed documents, and therefore if this feature is turned OFF, the received document will be slightly longer than the original document.

#### Code #39: Changing the display contrast

LCD CONTRAST

“NORMAL” (default): For normal contrast.

“DARKER”: Used when the display contrast is too light.



### Code #41: Changing the fax activation code

#### FAX ACTIVATION

If you wish to use an extension telephone to receive faxes, activate this feature and program the activation code.

1. Press **[MENU]**.
2. Press **[#]**, then **[4][1]**.
3. Press **[SET]**.
4. Press **[+]** or **[-]** repeatedly to select "ON".
5. Press **[SET]**.
6. Enter your code (2–4 digits) using the dial keys 0–9, **[\*]** and **[#]**.
  - The default code is "\*#9".
  - Do not enter "0000".
7. Press **[SET]**.
8. Press **[MENU]**.

### Code #42 (KX-FT907 only): Setting the message alert

#### MESSAGE ALERT

To alert you when new voice messages are recorded. The unit beeps slowly until you listen to the recorded messages.

"ON": You will be alerted to new messages by a beeping sound.

"OFF" (default): Deactivates this feature.

### Code #43 (KX-FT907 only): Setting the recording time alert

#### REC. TIME ALERT

To alert you when there is less than 60 seconds of remaining recording time. The slow beeps will continue until you erase the recorded messages (page 42) or print out the documents in memory.

"ON": You will be alerted that you have reached the recording time limit by a beeping sound.

"OFF" (default): Deactivates this feature.

### Code #46: Setting friendly reception

#### FRIENDLY RCV

To receive a fax automatically when you answer a call and hear a fax calling tone (slow beep).

"ON" (default): You do not have to press

**[FAX/START]** for fax reception.

"OFF": You have to press **[FAX/START]** for fax reception.

### Code #47 (KX-FT907 only): Setting the voice guidance

#### VOICE GUIDANCE

If you wish to hear voice guidance, activate this feature.

"ON" (default): You will hear the friendly reception voice guide, pre-recorded messages and voice time/day stamp.

"OFF": Deactivates this feature.

### Code #49: Setting the auto disconnection

#### AUTO DISCONNECT

To answer a call with an extension telephone in TEL/FAX mode (page 36), activate this feature and program the code.

1. Press **[MENU]**.
2. Press **[#]**, then **[4][9]**.
3. Press **[SET]**.
4. Press **[+]** or **[-]** repeatedly to select "ON".
5. Press **[SET]**.
6. Enter your code (2–4 digits) using the dial keys 0–9 and **[\*]**.
  - The default code is "\*0".
7. Press **[SET]**.
8. Press **[MENU]**.

### Code #54 (KX-FT907 only): Changing the recording time for your TAD/FAX greeting message

#### GREETING TIME

"16s" (default): Maximum recording time is 16 seconds.

"60s": Maximum recording time is 60 seconds. See page 40 for details.

### Code #58: Setting the original mode

#### ORIGINAL

To send or copy a document with faint or dark writing, set this feature before transmission or copying.

"NORMAL" (default): Used for normal writing.

"LIGHT": Used for faint writing.

"DARKER": Used for dark writing.

### Code #59: Setting the print contrast

#### PRINT CONTRAST

To adjust the darkness of received or copied documents.

"NORMAL" (default): Normal contrast.

## 9. Programmable Features

---

“DARKER”: Darker contrast.

---

### Code #60 (KX-FT907 only): Setting the message transfer

MESSAGE TRANS.

To transfer new voice messages to another telephone (page 45), activate this feature and program the transfer telephone number.

1. Press **[MENU]**.
2. Press **[⇄]**, then **[6][0]**.
3. Press **[SET]**.
4. Press **[+]** or **[-]** repeatedly to select “ON”.
5. Press **[SET]**.
6. Enter the transfer telephone number.
7. Press **[SET]**.
8. Press **[MENU]**.

---

### Code #61 (KX-FT907 only): Checking, recording or erasing the transfer greeting message

TRNS-GREETING

See page 45 for details.

---

### Code #67 (KX-FT907 only): Setting the incoming message monitor

ICM MONITOR

To hear an incoming message (ICM) from the speaker when the answering device is recording the message.

“ON” (default): You can monitor the incoming message.

“OFF”: Deactivates this feature.

---

### Code #70: Calling your pager (KX-FT901/KX-FT903)

FAX PAGER CALL

(KX-FT907)

PAGER CALL

See page 37 for details.

---

### Code #76: Setting the connecting tone

CONNECTING TONE

If you often have trouble when sending faxes, this feature allows you to hear connecting tones; fax tone, ring back tone and busy tone. You can use these tones to confirm the status of the other party's machine.

“ON” (default): You will hear connecting tones.

“OFF”: Deactivates this feature.

### Note:

- If the ring back tone continues, the other party's machine may not be a facsimile or may have run out of paper. Check with the other party.
- The connecting tone volume cannot be adjusted.

---

### Code #80: Resetting advanced features to their default settings

SET DEFAULT

To reset the advanced features:

1. Press **[MENU]**.
2. Press **[⇄]**, then **[8][0]**.
3. Press **[SET]**.
4. Press **[+]** or **[-]** repeatedly to select “YES”.
5. Press **[SET]**.
6. Press **[SET]** again.
7. Press **[MENU]**.

### Note:

- The emergency telephone numbers stored in the dial lock feature (page 25) will be saved.

## 10.1 Error messages – Reports

If a problem occurs during fax transmission or reception, one of the following messages will be printed on the sending and journal reports (page 27).

### COMMUNICATION ERROR

(Code: 41-72, FF)

- A transmission or reception error occurred. Try again or check with the other party.

### DOCUMENT JAMMED

- The document is jammed. Remove the jammed document (page 56).

### ERROR-NOT YOUR UNIT

(Code: 53, 54, 59, 70)

- A transmission or reception error occurred because of a problem with the other party's fax machine. Check with the other party.

### MEMORY FULL

- The document was not received as a result of the memory being full.

### NO DOCUMENT

- The document was not fed into the unit properly. Re-insert it and try again.

### OTHER FAX NOT RESPONDING

- The other party's fax machine is busy or has run out of recording paper. Try again.
- The other party's fax machine rings too many times. Send the fax manually (page 27).
- The other party's machine is not a fax machine. Check with the other party.
- The number you dialed is not in service.

### PAPER JAMMED

- The recording paper is jammed. Clear the jammed paper (page 55).

### PAPER OUT

- The unit has run out of recording paper. Install recording paper (page 6).
- The cover was opened. Close it and try again.

### PRESSED THE STOP KEY

- **[STOP]** was pressed, and fax transmission or reception was cancelled.

### PRINTER OVERHEATED

- The printer overheated. Let the unit cool down.

### OK

- Fax transmission or reception was successful.

## 10.2 Error messages – Display

If the unit detects a problem, one or more of the following messages will appear on the display.

CALL SERVICE 1

CALL SERVICE 2

- There is something wrong with the unit. Contact our service personnel.

CHECK COVER



OUT OF PAPER

- The cover is open. Close it.
- The unit has run out of recording paper. Install recording paper (page 6).

CHECK DOCUMENT

- The document was not fed into the unit properly. Re-insert the document. If misfeeding occurs frequently, clean the document feeder rollers (page 57) and try again.
- Attempted to send a document longer than 600 mm. Press **[STOP]** to remove the document. Divide the document into two or more sheets and try again.

CHECK MEMORY

- The memory (telephone numbers, parameters, etc.) has been erased. Re-program.

DIRECTORY FULL

- There is no space to store new items in navigator directory. Erase unnecessary items (page 19).

FAX IN MEMORY

- The unit has a document in memory. See the other displayed message instructions to print out the document. For fax memory capacity, see page 60.

---

### MEMORY FULL

- There is no memory available to receive fax documents and record voice messages. Print out the documents in memory or erase unnecessary messages (page 42).

---

### NO RESPONSE

- The other party's fax machine is busy or has run out of recording paper. Try again.

---

### NO TAD GREETING

- Your TAD/FAX greeting message is not recorded. Record a message (page 40).
- The voice guidance feature is turned OFF. Activate feature #47 on page 49. The pre-recorded greeting message will be used.

---

### NO TRNS-GREET.

- Your transfer greeting message is not recorded. Record a message (page 45).
- The voice guidance feature is turned OFF. Activate feature #47 on page 49. The pre-recorded greeting message will be used.

---

### PAPER JAMMED

- A recording paper jam occurred. Clear the jammed paper (page 55).
- The recording paper is not installed correctly. Install the paper correctly (page 6).

---

### POLLING ERROR

- The other party's fax machine does not offer the polling function. Check with the other party.

---

### REDIAL TIME OUT

- The other party's fax machine is busy or has run out of recording paper. Try again.

---

### REMOVE DOCUMENT

- The document is jammed. Remove the jammed document (page 56).
- Press **[STOP]** to eject the jammed document.

---

### TRANSMIT ERROR

- A transmission error occurred. Try again.

---

### UNIT OVERHEATED

- The unit is too hot. Stop using the unit for a while and let the unit cool down.

## 10.3 When a function does not work, check here

### 10.3.1 Initial settings

#### I cannot hear a dial tone.

- The telephone line cord is connected to the [EXT] jack on the unit. Connect to the [LINE] jack (page 5) (KX-FT901/KX-FT903 only).
- If you used a splitter to connect the unit, remove the splitter and connect the unit to the wall jack directly. If the unit operates properly, check the splitter.
- Disconnect the unit from the telephone line and connect the line to a known working telephone. If the working telephone operates properly, contact our service personnel to have the unit repaired. If the working telephone does not operate properly, contact your telephone company.
- The power cord or telephone line cord is not connected. Check the connections.
- If you connected the fax machine through a computer modem, connect the fax machine directly to a telephone line jack.

#### I cannot make calls.

- The dialling mode setting may be wrong. Change the setting (feature #13, page 47).

#### The unit does not ring.

- The ringer volume is turned OFF. Adjust it (page 14).
- The TAD ring setting of feature #06 is set to "RINGER OFF". Change to another ring setting (page 47) (KX-FT907 only).

### 10.3.2 General

#### The other party complains they only hear a fax tone and cannot talk.

- FAX ONLY mode is set. Tell the other party the number is only used for faxes.
- Change the receiving mode:
  - KX-FT901/KX-FT903: TEL mode (page 34) or TEL/FAX mode (page 36).
  - KX-FT907: TAD/FAX mode (page 35), TEL mode (page 34) or TEL/FAX mode (page 36).
- If you use a Distinctive Ring service, make sure you have set the same ring pattern assigned by the telephone company (page 38).

#### The [REDIAL]/[PAUSE] button does not function properly.

- If this button is pressed during dialling, a pause will be inserted. If pressed immediately after a dial tone is obtained, the last number dialled will be redialled.

#### The receiving mode does not function properly.

- A Distinctive Ring of feature #31 is activated (page 38).

#### During programming, I cannot enter the code or ID number.

- All or part of the numbers are the same as another code or ID. Change the number:
  - remote operation ID: feature #11 on page 47 (KX-FT907 only).
  - fax activation code: feature #41 on page 49.
  - auto disconnection code: feature #49 on page 49.

#### The speakerphone is not working (KX-FT907 only).

- Use the speakerphone in a quiet room.
- If you have difficulty hearing the other party, adjust the volume.

### 10.3.3 Fax – sending

#### I cannot send documents.

- The telephone line cord is connected to the [EXT] jack on the unit. Connect to the [LINE] jack (page 5) (KX-FT901/KX-FT903 only).
- The other party's fax machine is busy or has run out of recording paper. Try again.
- The other party's machine is not a fax machine. Check with the other party.
- The other party's fax machine failed to answer the fax automatically. Send the fax manually (page 27).

#### I cannot send a fax overseas.

- Use the overseas transmission mode of feature #23 (page 48).
- Add two pauses at the end of the telephone number or dial manually.

#### The other party complains that letters on their received document are distorted or not clear.

- If your line has special telephone services such as call waiting, the service may have been activated during fax transmission.

Connect the unit to a line that does not have these services.

- An extension telephone on the same line is off the hook. Hang up the extension telephone and try again.
- Try copying the document. If the copied image is clear, there may be something wrong with the other party's machine.
- Adjust the original mode using feature #58 (page 49).

---

### **The other party complains that black lines, white lines or smudges appear on their received document.**

- The scanner glass or rollers are dirty with correction fluid, etc. Clean them (page 57). Please do not insert the document before correction fluid has dried completely.

### **10.3.4 Fax – receiving**

---

#### **I cannot receive documents.**

- The telephone line cord is connected to the [EXT] jack on the unit. Connect to the [LINE] jack (page 5) (KX-FT901/KX-FT903 only).

---

#### **I cannot receive documents automatically.**

- The receiving mode is set to TEL mode. Change the receiving mode:
  - KX-FT901/KX-FT903: FAX ONLY mode (page 36) or TEL/FAX mode (page 36).
  - KX-FT907: TAD/FAX mode (page 35), FAX ONLY mode (page 36) or TEL/FAX mode (page 36).
- The time taken to answer the call is too long. Decrease the number of rings in feature #06 (page 47) (KX-FT907 only), #07 (page 47), #09 (page 47) and/or #30 (page 48).
- The greeting message is too long. Record a shorter message (page 40) (KX-FT907 only).

---

#### **The display shows “CONNECTING . . . .”, but faxes are not received.**

- The receiving mode is set to FAX ONLY mode and the incoming call is not a fax. Change the receiving mode:
  - KX-FT901/KX-FT903: TEL mode (page 34) or TEL/FAX mode (page 36).
  - KX-FT907: TAD/FAX mode (page 35), TEL mode (page 34) or TEL/FAX mode (page 36).

---

#### **A blank sheet is ejected.**

- The recording paper is not installed correctly. Make sure that the shiny side of the paper is facing down and re-install the paper (page 6).

- The other party placed the document in their fax machine the wrong way. Check with the other party.

---

#### **The printing quality is poor.**

- The thermal head is dirty. Clean it (page 58).
- If documents can be copied properly, the unit is working normally. The other party may have sent a faint document or there may be something wrong with the other party's machine. Ask them to send a clearer copy of the document or to check their fax machine.
- If documents are not clear when you copy, adjust the print contrast using feature #59 (page 49).

---

#### **The other party complains that they cannot send a document.**

- The receiving mode is set to TEL mode. Receive the document manually (page 34) or change the receiving mode:
  - KX-FT901/KX-FT903: FAX ONLY mode (page 36) or TEL/FAX mode (page 36).
  - KX-FT907: TAD/FAX mode (page 35), FAX ONLY mode (page 36) or TEL/FAX mode (page 36).
- The memory is full of received documents due to a lack of recording paper or a recording paper jam. Install paper (page 6) or clear the jammed paper (page 55) (KX-FT903/KX-FT907 only).

---

#### **I cannot select the desired receiving mode.**

- If you want to set TAD/FAX mode (KX-FT907 only), FAX ONLY mode or TEL/FAX mode, set the desired mode using feature #05 (page 47), and press [AUTO ANSWER] repeatedly to select the desired mode.
- If you want to set TEL mode, press [AUTO ANSWER] repeatedly to select TEL mode.

### **10.3.5 Copying**

---

#### **The unit will not make a copy.**

- You cannot make a copy during a programming. Make the copy after programming.
- You cannot make a copy during a telephone conversation.

---

#### **A black line, a white line or smudge appears on the copied document.**

- The scanner glass or rollers are dirty with correction fluid, etc. Clean them (page 57). Please do not insert the document before correction fluid has dried completely.

**The printing quality is poor.**

- The thermal head is dirty. Clean it (page 58).
- Adjust the print contrast using feature #59 (page 49).

**The copied image is distorted.**

- Adjust the width of the document guides to fit the actual size of the document.

**The copied document is blank.**

- The recording paper is not installed correctly. Make sure that the shiny side of the paper is facing down and re-install the paper (page 6).

**10.3.6 Answering device (KX-FT907 only)****I cannot retrieve recorded messages from a remote location.**

- Press the remote operation ID correctly and firmly (page 43).

**The other party complains that they cannot leave a voice message.**

- The memory is full. Erase unnecessary messages (page 42).

**10.3.7 If a power failure occurs**

- The unit will not function.
- The unit is not designed for making emergency telephone calls when the power fails. Alternative arrangements should be made for access to emergency services.
- Fax transmission and reception will be interrupted.
- If delayed transmission (feature #25, page 48) is programmed and a power failure prevents the document from being sent at the set time, the document will be sent after power is restored.

**10.4 Recording paper jams**

- 1 Open the cover by pressing the cover open button (①).

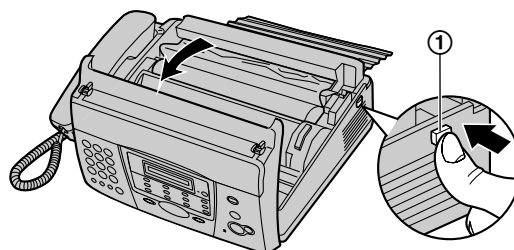

- 2 For KX-FT901:

Skip to step 3.

**For KX-FT903/KX-FT907:**

Lift the green lever.

- The paper cutter will be released.

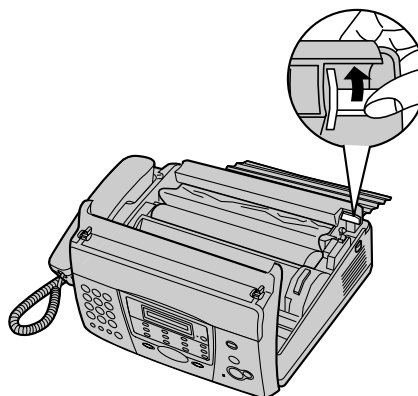

- 3 Remove the recording paper.

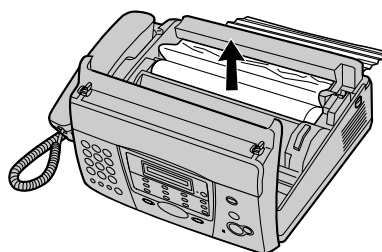

- 4 Cut off the wrinkled portion.

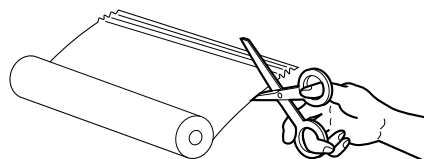

- 5 Install the recording paper and close the cover securely by pushing down on both sides (see page 6 for details).

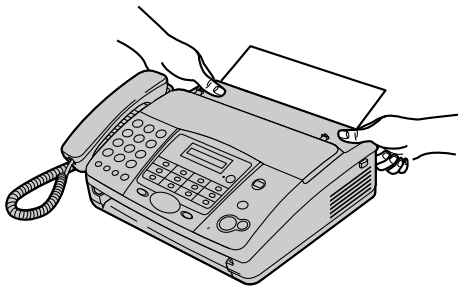

### 10.5 Document jams – sending

- 1 Open the cover by pressing the cover open button (①) and remove the jammed document carefully (②).

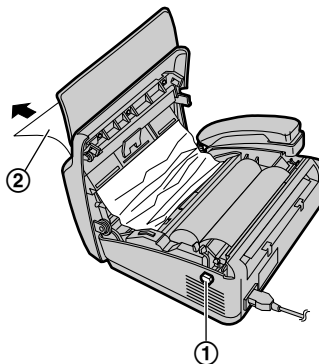

- 2 Close the cover securely by pushing down on both sides.

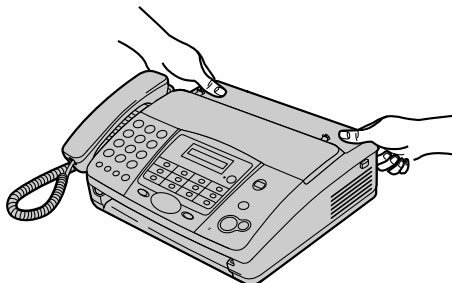

#### Note:

- Do not pull out the jammed paper forcibly before opening the cover.





## 10.6 Document feeder / scanner glass cleaning

Clean the document feeder when:

- Documents frequently misfeed.
- Smudges or black/white lines appear on the original document when sending or copying.

- 1 Disconnect the power cord and the telephone line cord.
- 2 Open the cover by pressing the cover open button (1).

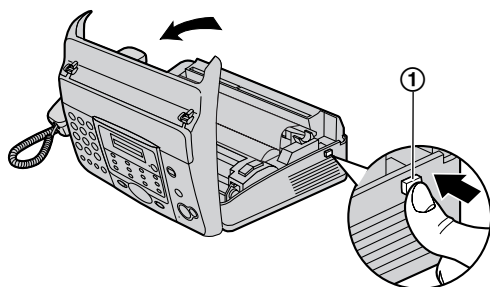

- 3 Clean the document feeder rollers (1) and rubber flap (2) with a cloth moistened with isopropyl rubbing alcohol, and let all parts dry thoroughly. Clean the white plate (3) and scanner glass (4) with a soft and dry cloth.

**Caution:**

- Do not use paper products, such as paper towels or tissues.

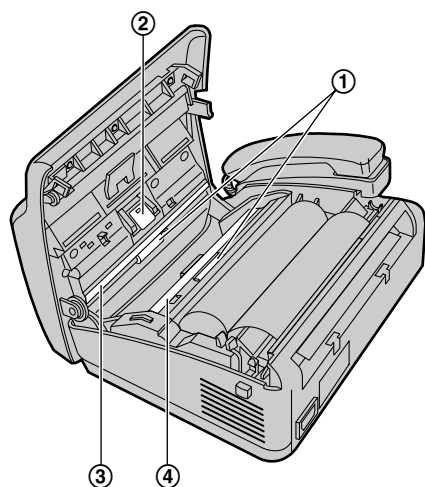

- 4 Connect the power cord and the telephone line cord.

- 5 Close the cover securely by pushing down on both sides.

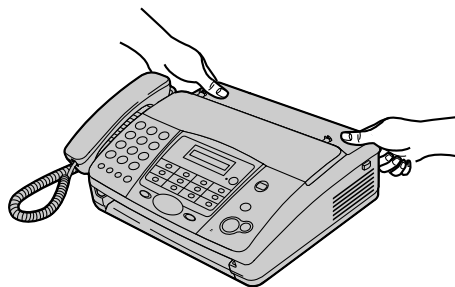

### 10.7 Thermal head / head cover cleaning

If smudges or black/white lines appear on a copied/received document, check whether there is dust on the thermal head and head cover. Clean them to remove the dust.

- 1 Disconnect the power cord and the telephone line cord.
- 2 Open the cover by pressing the cover open button (①) and remove the recording paper.

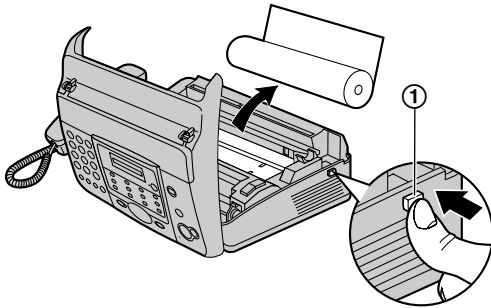

- 3 Clean the thermal head (①) and head cover (②) with a cloth moistened with isopropyl rubbing alcohol, and let all parts dry thoroughly.

**Caution:**

- To prevent a malfunction due to static electricity, do not use a dry cloth and do not touch the thermal head directly.

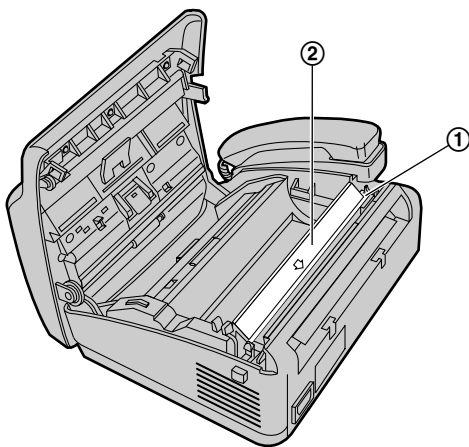

- 4 Connect the power cord and the telephone line cord.

- 5 Install the recording paper and close the cover securely by pushing down on both sides (see page 6 for details).

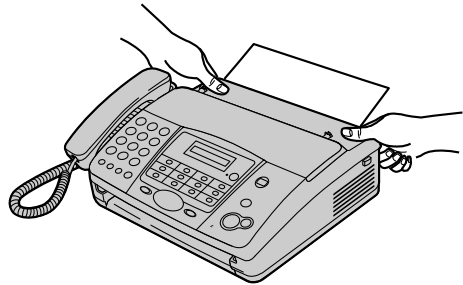

## 11.1 Reference lists and reports

You can print out the following lists and reports for your reference.

### Basic feature list:

provides you with the current settings of the basic programming features (page 47).

### Advanced feature list:

provides you with the current settings of the advanced programming features (page 48).

### Telephone number list:

provides you with names and numbers which are stored for the one-touch dial feature and navigator directory. It also provides the emergency telephone numbers stored in the dial lock feature.

### Journal report:

keeps records of fax transmission and reception. This report can be printed automatically after every 35 fax communications (feature #22, page 48).

### Caller ID list:

keeps records of the last 20 callers after subscribing to a Caller ID service. To print automatically after every 20 callers, activate feature #26 (page 48).

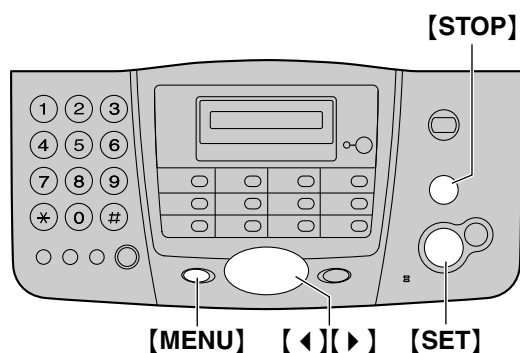

- 1 Press **[MENU]** repeatedly to display "PRINT REPORT".
- 2 Press **[SET]**.
- 3 Press **[◀]** or **[▶]** repeatedly to display the desired item.
- 4 Press **[SET]** to start printing.
  - To stop printing, press **[STOP]**.
- 5 Press **[MENU]**.

### 11.2 Specifications

**Applicable lines:**

Public Switched Telephone Network

**Document size:**

Max. 216 mm in width, Max. 600 mm in length

**Effective scanning width:**

208 mm

**Recording paper size:**

216 mm × max. 30 m roll

**Effective printing width:**

208 mm

**Transmission time<sup>\*1</sup>:**

Approx. 15 s/page<sup>\*2</sup>

**Scanning density:**

Horizontal: 8 pels/mm

Vertical: 3.85 lines/mm – in standard resolution,

7.7 lines/mm – in fine/photo resolution,

15.4 lines/mm – in super fine resolution

**Photo resolution:**

64-level

**Scanner type:**

Contact Image Sensor

**Printer type:**

Thermal Printing

**Data compression system:**

Modified Huffman (MH), Modified READ (MR)

**Modem speed:**

9,600 / 7,200 / 4,800 / 2,400 bps; Automatic  
Fallback

**Operating environment:**

5 °C – 35 °C, 20 % – 80 % RH (Relative  
Humidity)

**Dimensions:**

Approx. height 120 mm × width 347 mm × depth  
270 mm

**Mass (Weight):**

KX-FT901: Approx. 2.6 kg

KX-FT903/KX-FT907: Approx. 2.7 kg

**Power consumption:**

Standby: Approx. 3.0 W

Transmission: Approx. 25 W

Reception: Approx. 40 W (When receiving a 20  
% black document)

Copy: Approx. 40 W (When copying a 20 % black  
document)

Maximum: Approx. 125 W (When receiving a  
100 % black document)

**Power supply:**

220 V – 240 V AC, 50/60 Hz

**Fax memory capacity<sup>\*3</sup> (KX-FT903/KX-FT907  
only):**

Approx. 20 pages of document memory (Based  
on the ITU-T No. 1 Test Chart in standard  
resolution when no voice messages have been  
recorded.)

**Voice memory capacity<sup>\*4</sup> (KX-FT907 only):**

Approx. 20 minutes of recording time including  
greeting messages when no documents are in  
memory.

- \*1 Transmission speed depends upon the contents of the pages, resolution, telephone line conditions and capability of the other party's machine.
- \*2 Transmission speed is based upon the ITU-T No. 1 Test Chart and original mode. If the capability of the other party's machine is inferior to your unit, the transmission time may be longer.
- \*3 If an error occurs during fax reception, such as a paper jam or if the recording paper runs out, the fax will not be received. Subsequent faxes will be retained in memory.
- \*4 Recording time may be reduced by the calling party's background noise.

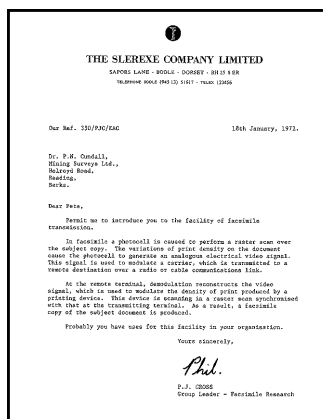
**ITU-T No. 1 Test Chart****Note:**

- Design and specifications are subject to change without notice.
- The pictures and illustrations in these instructions may vary slightly from the actual product.
- The suffix in the model number will be omitted in these instructions.
- Most figures shown in these operating instructions are based on a KX-FT901.

---

## 11.3 User record

For your future reference

Date of purchase
Serial number (found on the rear of the unit)
Dealer's name and address
Dealer's telephone number

Attach your sales receipt here.

-----

### 12.1 Index

- # #01 Date and time: 14
- # #02 Your logo: 15
- # #03 Your fax number: 17
- # #04 Sending report: 27, 47
- # #05 Auto answer: 47
- # #06 TAD ring setting: 35, 47
- # #07 FAX ring setting: 47
- # #09 TEL/FAX ring setting: 36, 47
- # #10 Recording time for an incoming message: 47
- # #11 Remote operation ID: 47
- # #13 Dialling mode: 47
- # #22 Journal report: 27, 48
- # #23 Overseas mode: 48
- # #25 Delayed transmission: 48
- # #26 Caller ID list: 48
- # #30 Silent fax ring setting: 36, 48
- # #31 Ring detection: 38, 48
- # #36 Auto reduction: 48
- # #39 Display contrast: 48
- # #41 Fax activation code: 49
- # #42 Message alert: 49
- # #43 Recording time alert: 49
- # #46 Friendly reception: 49
- # #47 Voice guidance: 49
- # #49 Auto disconnection: 49
- # #54 Greeting time: 49
- # #58 Original mode: 49
- # #59 Print contrast: 49
- # #60 Message transfer: 45, 50
- # #61 Message transfer greeting message: 45
- # #67 Incoming message monitor: 50
- # #70 Pager call: 37
- # #76 Connecting tone: 50
- # #80 Reset advanced features: 50
- A** Accessories: 4
  - Paper stacker: 5
  - Advanced features: 48
  - Auto answer setting (Feature #05): 47
  - Auto disconnection (Feature #49): 49
  - Auto reduction (Feature #36): 48
- B** Basic features: 47
  - Broadcast transmission: 29
  - Button description: 12
- C** Caller ID: 21
  - Calling back: 22, 23
  - Storing: 24
- Caller ID list (Feature #26): 22, 48
- Caller's recording time (Feature #10): 47
- Character table: 15
- Cleaning: 57, 58
- Communication messages: 51
- Connecting tone (Feature #76): 50
- Connections: 5
- Copy: 39
- D** Date and time (Feature #01): 14
  - Delayed transmission (Feature #25): 48
  - Dialling mode (Feature #13): 47
  - Dial lock: 25
  - Directory (Navigator): 16, 18, 20, 28
  - Display
    - Contrast (Feature #39): 48
    - Error messages: 51
  - Distinctive Ring service (Feature #31): 38, 48
  - Document size: 27
- E** Error messages: 51
  - Extension telephone: 34
- F** Fax activation code (Feature #41): 34, 49
  - Fax number (Feature #03): 17
  - Friendly reception (Feature #46): 49
- G** Greeting message
  - Message transfer (Feature #61): 45
    - TAD/FAX: 40
    - TEL/FAX: 40
- H** Help: 9
- I** Incoming message monitor (Feature #67): 50
- J** Jams
  - Document: 56
  - Recording paper: 55
  - Journal report (Feature #22): 27, 48
- L** Listening to recorded messages: 41
  - From a remote location: 43
  - Logo (Feature #02): 15
- M** Message alert (Feature #42): 49
  - Message transfer (Feature #60): 45, 50
- N** Navigator directory
  - Making a phone call: 20
  - Selecting characters: 16
  - Sending faxes: 28
  - Storing: 18
- O** One-touch dial
  - Making a phone call: 20
  - Sending faxes: 28
  - Storing: 18

- 
- Original mode (Feature #58): 49
  - Overseas mode (Feature #23): 48
  - P** Pager call (Feature #70): 37
  - Polling
    - Receiving: 37
    - Transmitting: 31
  - Power failure: 55
  - Print contrast (Feature #59): 49
  - Programming: 46
  - R** Receiving faxes
    - Automatically: 35
    - Manually: 34
  - Recording
    - Greeting message: 40, 45
    - Memo message: 41
    - Telephone conversation: 21
  - Recording paper: 4, 6
  - Recording paper size: 60
  - Recording time alert (Feature #43): 49
  - Recording time for TAD/FAX greeting message (Feature #54): 49
  - Redialling: 27, 28
  - Remote operation: 43
  - Remote operation ID (Feature #11): 47
  - Reports
    - Advanced feature: 59
    - Basic feature: 59
    - Broadcast sending: 30
    - Caller ID list: 48, 59
    - Journal: 27, 48, 59
    - Sending: 27, 47
    - Telephone number: 59
  - Reset (Feature #80): 50
  - Resolution: 27, 39
  - Ring detection (Feature #31): 38, 48
  - Ring setting
    - FAX ONLY (Feature #07): 47
    - Silent fax (Feature #30): 48
    - TAD/FAX (Feature #06): 47
    - TEL/FAX (Feature #09): 47
  - S** Sending faxes
    - Broadcast: 30
    - Manually: 27
    - Navigator directory: 28
    - One-touch dial: 28
  - Sending report (Feature #04): 27, 47
  - Storing
    - Broadcast: 29
    - Navigator directory: 18
    - One-touch dial: 18
  - T** Toll saver: 35
  - V** Voice contact: 26
  - Voice guidance (Feature #47): 49
  - Voice time/day stamp: 42
  - Volume: 14
-

**Manufacturer:****Panasonic Communications Co., Ltd.**

1-62, 4-chome, Minoshima, Hakata-ku, Fukuoka 812-8531, Japan

**Global web site:**<http://www.panasonic.co.jp/global/>**Copyright:**

- This manual is copyrighted by Panasonic Communications Co., Ltd. (PCC) and its licensee. Under the copyright laws, this manual may not be reproduced in any form, in whole or part, without the prior written consent of PCC and its licensee.

© 2004 Panasonic Communications Co., Ltd. All Rights Reserved.



## Free Manuals Download Website

<http://myh66.com>

<http://usermanuals.us>

<http://www.somanuals.com>

<http://www.4manuals.cc>

<http://www.manual-lib.com>

<http://www.404manual.com>

<http://www.luxmanual.com>

<http://aubethermostatmanual.com>

Golf course search by state

<http://golfingnear.com>

Email search by domain

<http://emailbydomain.com>

Auto manuals search

<http://auto.somanuals.com>

TV manuals search

<http://tv.somanuals.com>