

Facsimile

Quick Reference Guide

Model No. **KX-PW110CL**



Thank you for purchasing a Panasonic facsimile.

Table of Contents

Finding the controls	2
Installations and connections	4
Setting the date and time	7
Setting your facsimile telephone number	8
Setting your logo	8
Character input and command key table	9
Automatic dialing on the main unit.....	10
Automatic dialing on the portable handset	11
Sending faxes	12
Receiving faxes	13
Operating the built-in answering device	14
Individual e-mail services	16
Specifications.....	Back cover

- This guide explains some basic features and operations, but not all of them. For further details, see the Japanese operating instructions.
- This product is designed for use in Japan. Panasonic cannot provide service for this product if used outside Japan.
- Any details given in this guide are subject to change without notice.

Finding the controls

Main unit (control panel)

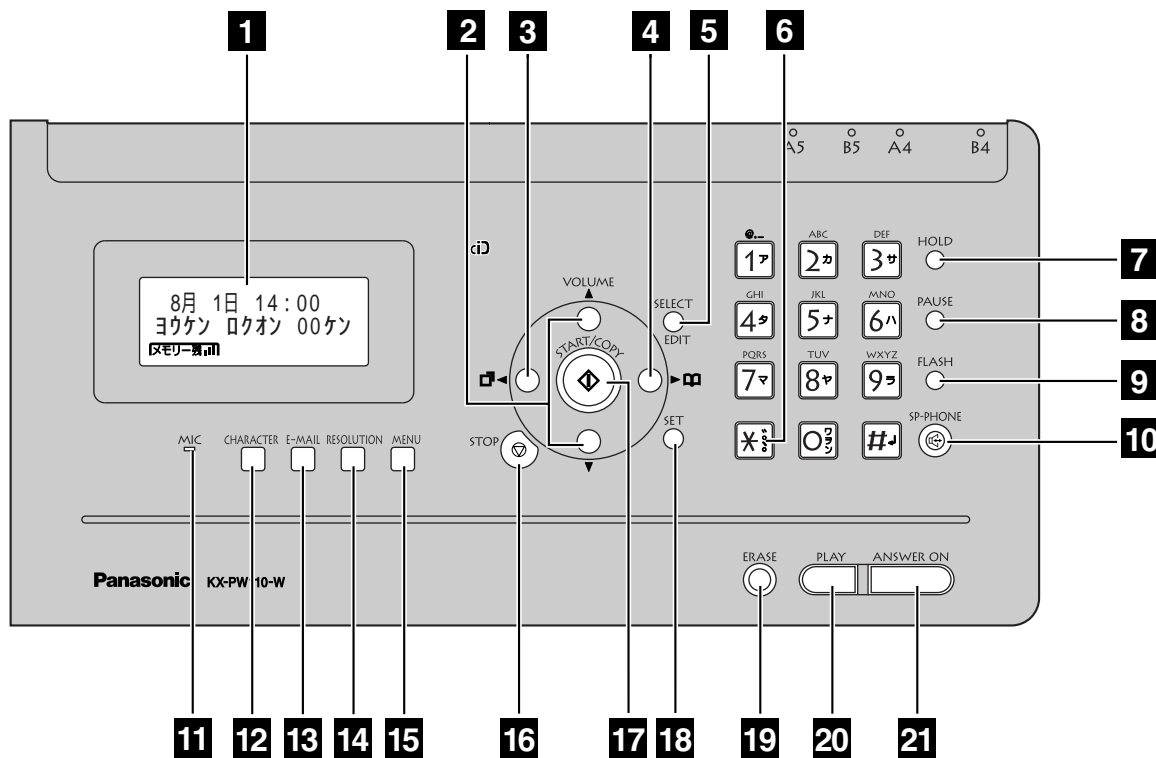

- 1** **Liquid crystal display**
- 2** **Volume** buttons adjust ringer and speaker volume.
- 3** **Redial** button
The last 10 phone numbers dialed are stored in memory.
- 4** **Phonebook/Addressbook** button
- 5** **Select** button selects a parameter.
Edit button
- 6** **Tone** button switches to tone dialing.
- 7** **Hold** button
Call Memory button starts a search in the Number Display log.
(For caller ID display service users.)
- 8** **Pause** button
- 9** **Flash** button
(For call waiting service users.)
- 10** **Speakerphone** button
- 11** **Microphone**
- 12** **Character Input Mode** button
- 13** **E-Mail** button
- 14** **Resolution** button selects the resolution when faxing or copying.
- 15** **Menu** button initiates programming.
- 16** **Stop** button
- 17** **Start/Copy** button starts faxing or copying.
- 18** **Set** button stores a parameter.
- 19** **Erase** button
- 20** **Play** button plays back recorded messages.
- 21** **Auto Answer** button & indicator
—light on: answering device activated.
—light off: used as a regular telephone.

Finding the controls

Portable handset

How to use F1 F2 buttons

F1 and F2 buttons refer to the function displayed on the bottom of the display. They function differently depending on the mode.

How to use key

- To use the phonebook.
- To redial the phone numbers in the redial list. The last 10 phone numbers dialed are stored in memory.
- To adjust the volume.

Tone button
To switch to Tone dialing mode.

- FLASH ERASE**: For call waiting service users. To erase letters/numbers.
- FAX**: To receive faxes.
- SP-PHONE**: To use the speakerphone.

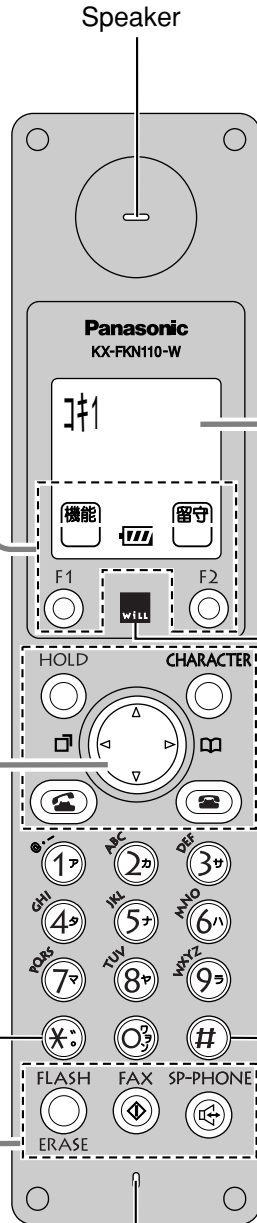

Speaker

Panasonic
KX-FKH110-W

F1 F2

HOLD CHARACTER

FLASH ERASE FAX SP-PHONE

Microphone

(Do not cover the microphone while talking.)

LCD (with back light)

Displays battery strength, telephone numbers etc.

- ① Portable handset number
- ② Function menu that is controlled by F1 or F2.
- ③ Battery strength

Charge indicator

Charging On
Full Off

- HOLD**: To put a call on hold. To start a search in the Number Display log. (For caller ID display service users.)
- CHARACTER**: To change the character input mode.
- Call button**: To make/answer calls.
- End call button**: To end a call. To end or exit from editing or other operations.

Sharp button

Installations and connections

Installing the ink film

- 1 Open the control panel.

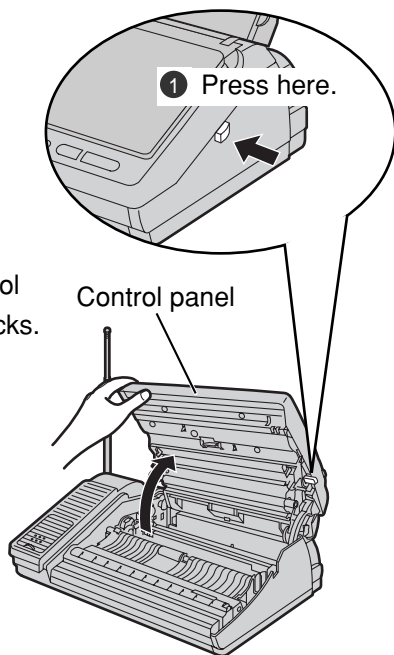

- 2 Insert the ink film.

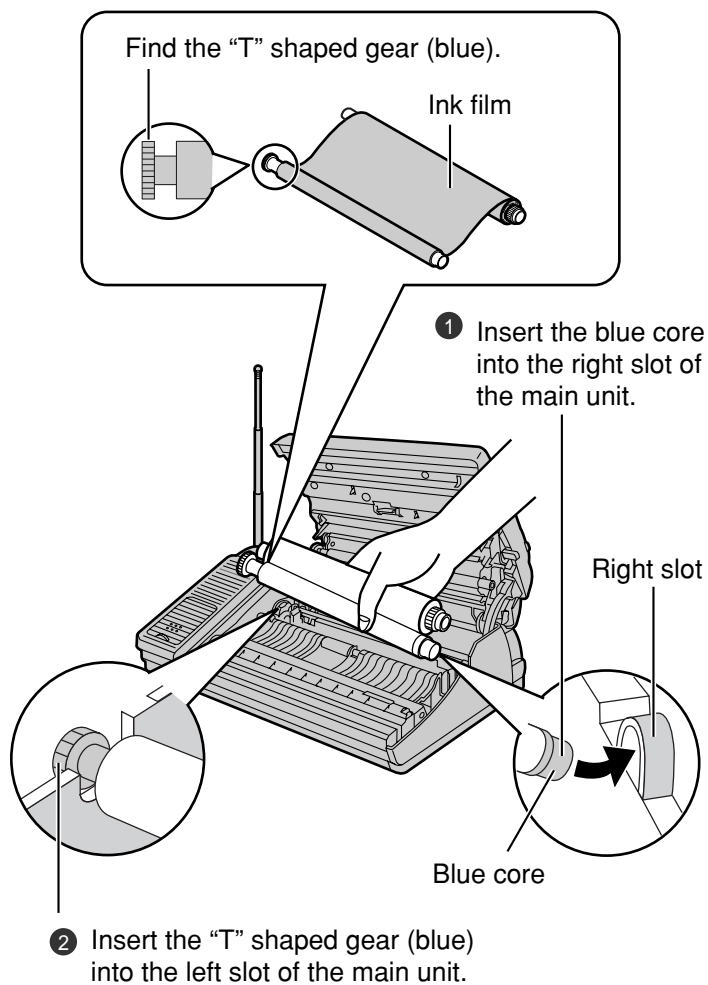

- 3 Insert the white core into the slots.

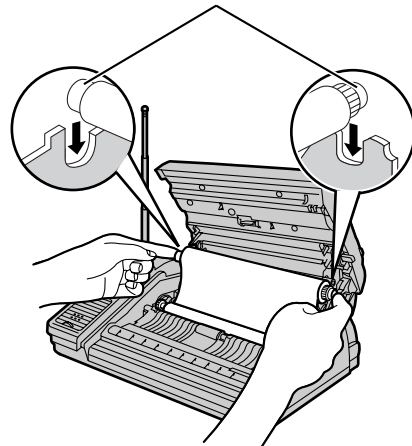

- 3 If the ink film is slack, tighten it by winding the "T" shaped gear.

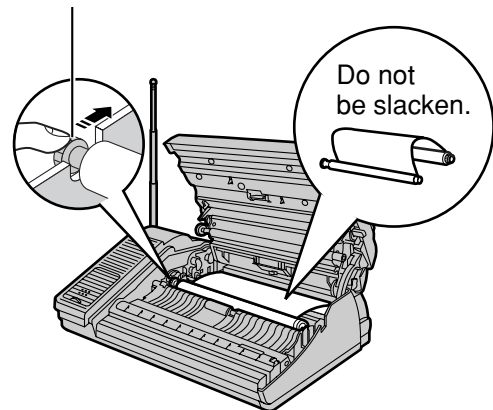

- 4 Close the control panel until it locks.

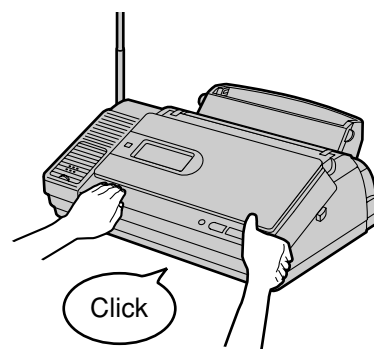

- When the unit runs out of ink film, the following message will be displayed.

フィルムガ ナクナリマシタ ユウカンシテクタ サイ U23	↔	フィルムガ ナクナリマシタ ヒンバ ン: KX-FAN141
----------------------------------	---	-----------------------------------

Install a new ink film.

Replacement ink film:
KX-FAN141 (50 m) ¥1400

· As of August 2003. · Tax not included.

Installations and connections

Installing recording paper (A4 size)

1 Install the recording paper tray.

- ① Separate the recording paper cover from the recording paper tray.

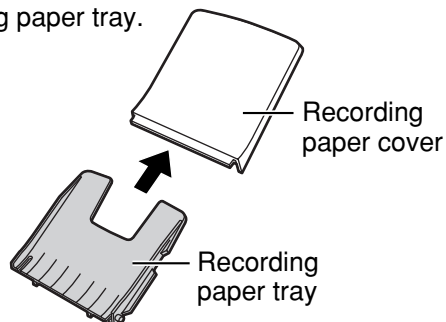

- ② Insert the left tab on the recording paper tray into the left slot of the main unit.

- ③ Insert the right tab into the right slot of the main unit.

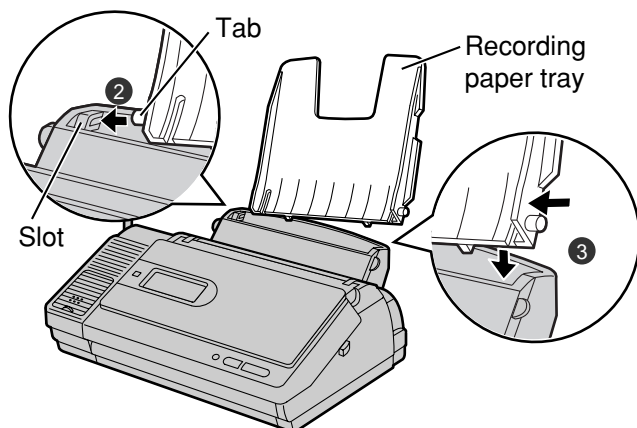

2 Insert the recording paper into the recording paper tray.

- ① Open the paper entrance cover until it locks.

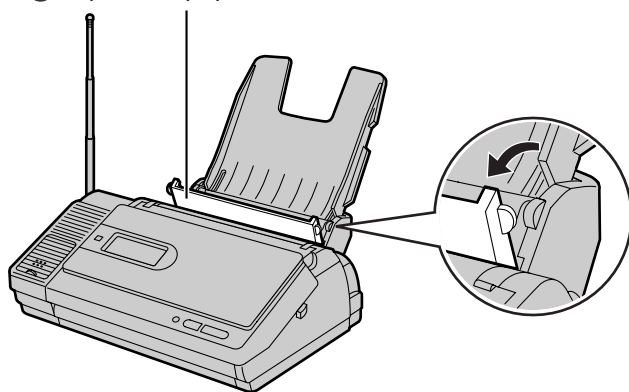

- ② Fan the stack of recording paper (A4 size).

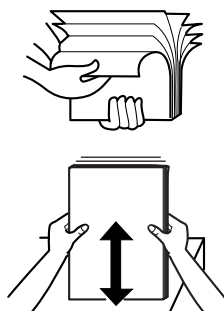

- ③ Insert the recording paper into the recording paper tray. (Up to 30 sheets)

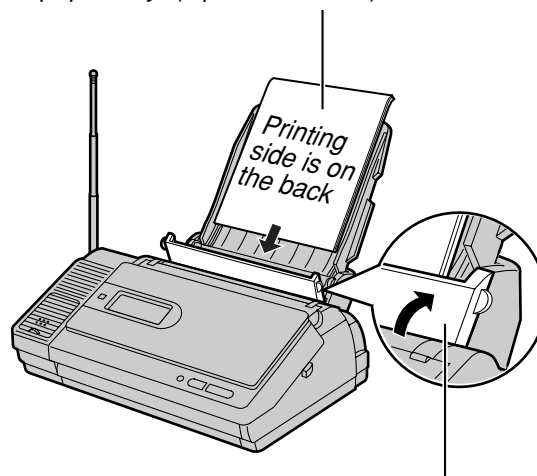

- ④ Close the paper entrance cover by leaning it back.

3 Install the recording paper cover on the recording paper tray by sliding it down from the top.

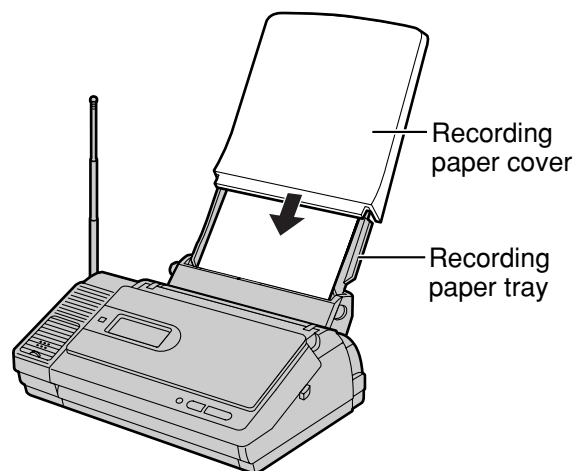

• To add paper

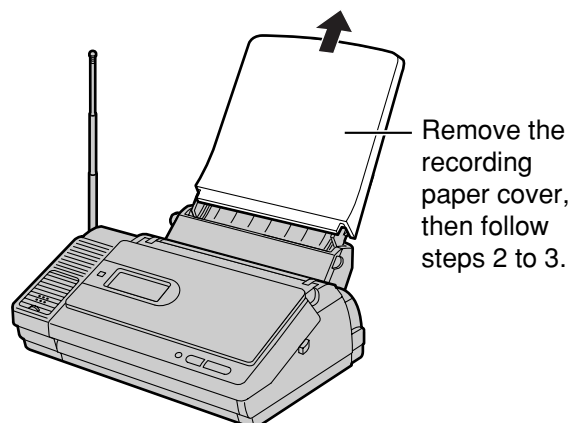

Installations and connections

Connecting the main unit

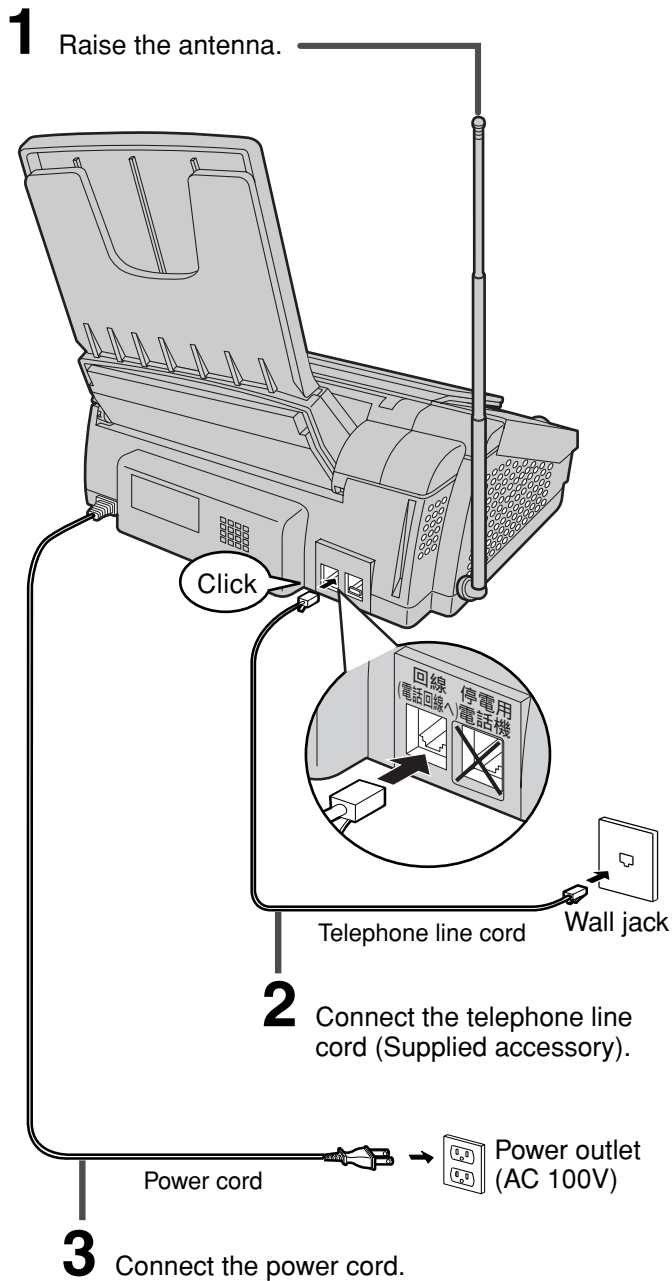

After the Power On...

This unit will automatically select the dialing mode (Tone/Pulse).

Setting up the portable handset

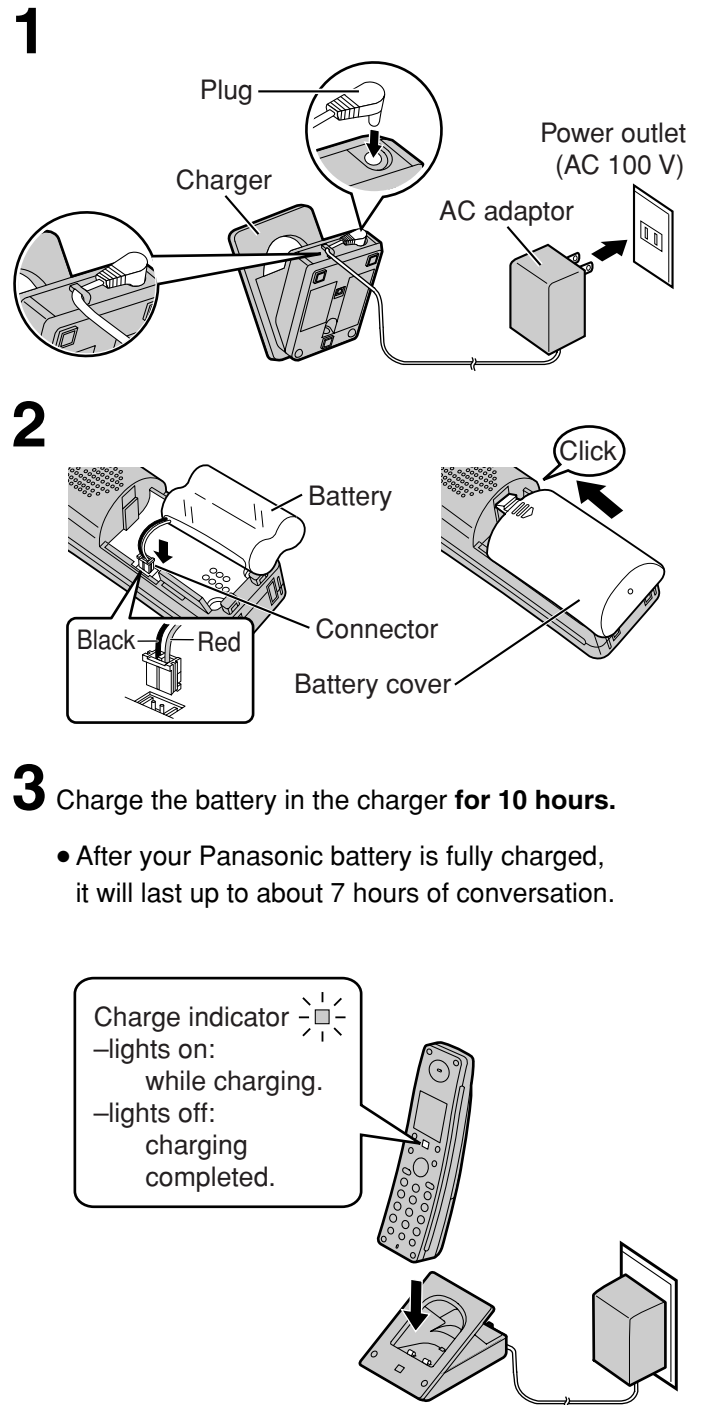

Installations and connections

• You can charge the battery in the main unit.

① Open the charger cover.

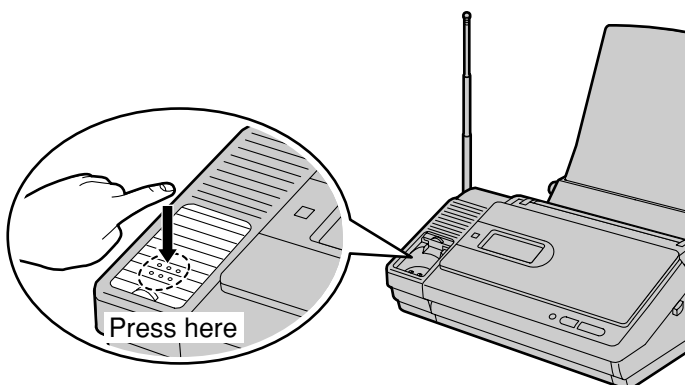

② Charge the battery for 10 hours.

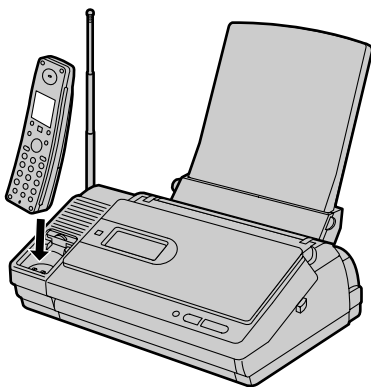

How to close the charger cover.

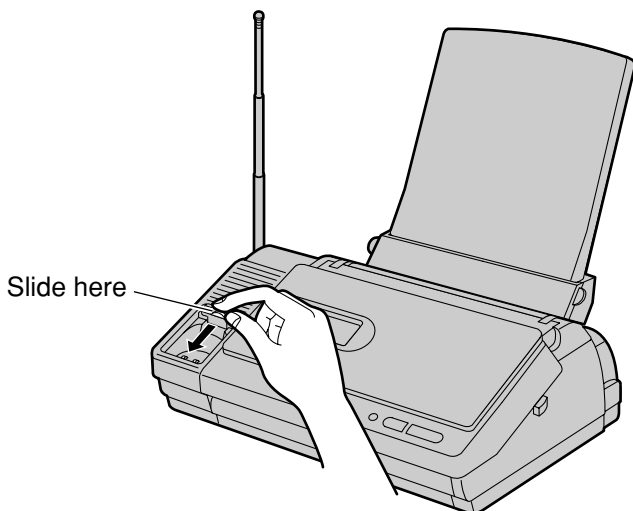

Setting the date and time

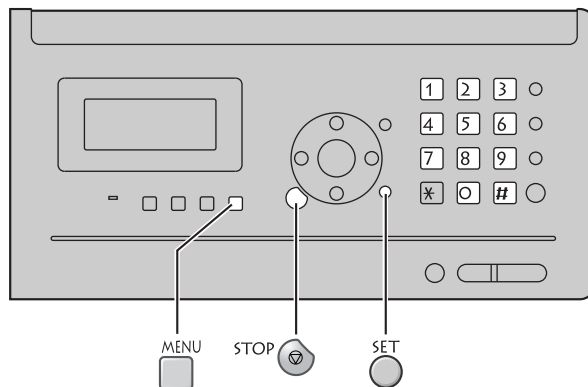

1 Press **MENU** .

キノウ トウロク モード
[] オク

2 Press **# 0 0 1** .

Example : 2003年06月01日
20:10
Cursor

3 Enter the correct year/month/day.

Example: **October 1, 2003**

Press **2 0 0 3 1 0 0 1** .

2003年10月01日
20:10

4 Enter the correct hour/minute in a 24-hour clock entry.

Example: **15:45 (3:45 PM)**

Press **1 5 4 5** .

2003年10月01日
15:45

5 Press **SET** .

トウロク シマシタ



2003年10月01日
15:45

6 Press **STOP** .

Example : 10月 1日 15:45
ヨクケン 0クワン 00ケン

Setting your facsimile telephone number

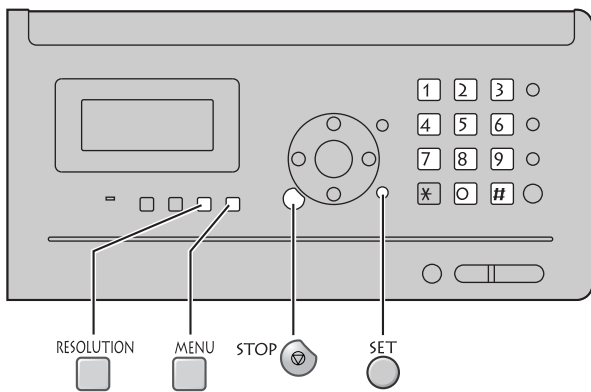

1 Press .

キノウ トウロク モード
[] 入力

2 Press .

アナタノテ`ソワハ`ソコ`ウ?
TEL=.....

Cursor

3 Enter your facsimile telephone number, up to 20 digits.

Example: 098 765 43..

アナタノテ`ソワハ`ソコ`ウ?
TEL=8 765 43 ..

RESOLUTION
The button replaces the digit with a space.

4 Press .

トウロク シマシタ



アナタノテ`ソワハ`ソコ`ウ?
TEL=098 765 43 .

5 Press .

Example : 10月 1日 15:45
ヨウケン ロクオン 00ケン

Setting your logo

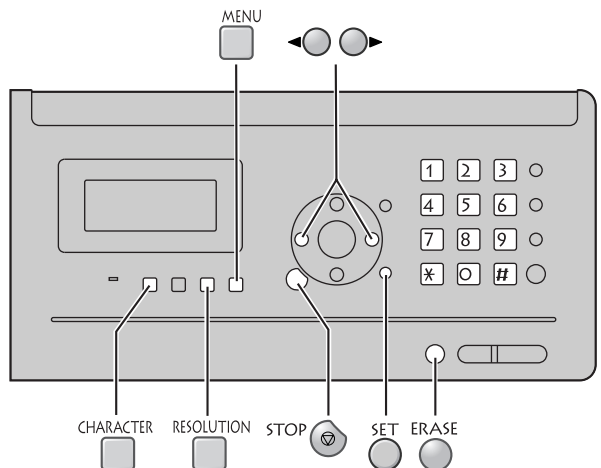

1 Press .

キノウ トウロク モード
[] 入力

2 Press .

アナタノナマイ?
[]

Cursor

3 Enter your logo, up to 30 characters, using the dial keypad.

- To enter English characters easily, press (Character input mode) repeatedly and select "英" (English and sign input mode).
- For details, see the table on page 9 for instructions.

Example: Micah

1. Press once.

アナタノナマイ?
M

Cursor

2. Press six times.

アナタノナマイ?
Mi

3. Press six times.

アナタノナマイ?
Mic

4. Press to move the cursor to the next space and press four times.

アナタノナマイ?
Mic a

5. Press five times.

アナタノナマイ?
Micah

4 Press .

トウロク シマシタ



アナタノナマイ?
Micah

5 Press .

Example : 10月 1日 15:45
ヨウケン ロクオン 00ケン

Character input and command key table

Pressing the dial keys will select a character as shown below.

Character		Katakana	English	Numbers
Display of the main unit		カナ	英	数
Display of the portable handset		[カナ]	[AB]	[12]
Dial key				
(Main unit)	(Portable handset)			
1	①	アイウエオアイウエオ	@ . _ - & \$ ¥ % + = ` ^	1
2	②	カキクケコ	A B C a b c	2
3	③	サシスセソ	D E F d e f	3
4	④	タチツテトッ	G H I g h i	4
5	⑤	ナニヌネノ	J K L j k l	5
6	⑥	ハヒフヘホ	M N O m n o	6
7	⑦	マミムメモ	P Q R S p q r s	7
8	⑧	ヤユヨヤユヨ	T U V t u v	8
9	⑨	ラリルレロ	W X Y Z w x y z	9
0	⑩	ワヲンー!? ()	! ? / - * # , ; : . ' " () [] { } 「 」	0
*	ⓧ	ゝ 〃 、 。	ゝ 。	
Command keys		CHARACTER (Main unit), CHARACTER (Portable handset)	Used to change the character input mode.	
		◀▶ (Main unit), ◀▶ (Portable handset)	Used to move the cursor to the left and right.	
		ERASE (Main unit), ERASE (Portable handset)	Used to delete a character.	
		RESOLUTION (Main unit), HOLD (Portable handset)	Used to insert a space.	

- When entering e-mail address, the small letters are displayed before the capital letters.
- When entering e-mail address, you can not enter the following symbols:
- When entering e-mail message, pressing enables you to begin the new line. (“↵” is displayed.)
- The characters on the display are somewhat different from those shown in the character input and command key table.

Automatic dialing on the main unit

Storing names and telephone numbers in the phonebook

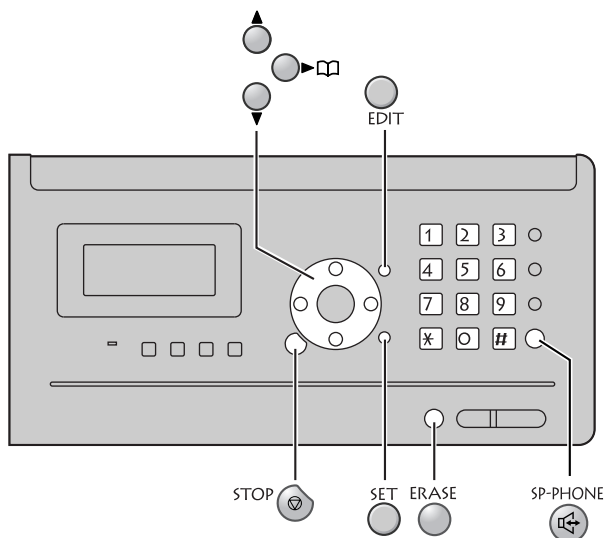

1 Press (Phonebook).

2 Press .

- “XXX” shows the remaining station numbers you can store.
- You can program up to 100 stations, including 4 pre-programmed stations.

トウロクハ [SET] オス
ケンサクハ [] オス

テ`ンワチヨウ アキxxxケン

3 Enter the name, up to 12 characters (see the table on page 9 for instructions).

4 Press .

5 Enter the telephone number, up to 24 digits.

- To correct a mistake, press .

6 Press .

7 If necessary, enter the group number (1-9).

8 Press .

- To program other items, repeat steps 3 to 8.

9 Press to exit the program.

Making a voice call using the phonebook

1 Press (Phonebook).

2 Press (Search buttons) repeatedly until the desired name is displayed.

3 Press (Speakerphone).

Editing a stored name or number in the phonebook

1 Press (Phonebook).

2 Press (Search buttons) repeatedly until the desired name is displayed.

3 Press .

4 Edit the name (see the table on page 9 for instructions).
• If you do not need to edit the name, skip to step 5.

5 Press .

6 Enter the correct telephone number.
• If you do not need to edit the telephone number, skip to step 7.

7 Press .

8 If necessary, enter the correct group number.

9 Press .

Automatic dialing on the portable handset

Storing names and telephone numbers in the phonebook

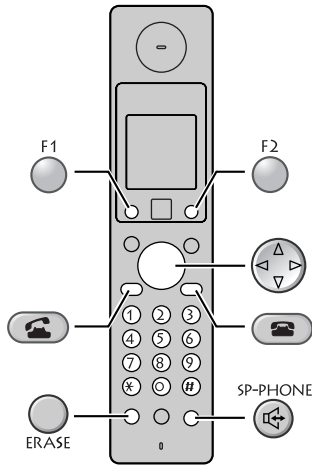

1 Press (Phonebook).

ケンサケル []オス

2 Press (Register).

- "XXX" shows the remaining station numbers you can store.
- You can program up to 100 stations, including 4 pre-programmed stations.

ナマエ? [カナ]
アキ xxxケン



ナマエ? [カナ]

3 Enter the name, up to 12 characters (see the table on page 9 for instructions).

4 Press (Register).

5 Enter the telephone number, up to 24 digits.

- To correct a mistake, press .

6 Press (Register).

7 If necessary, enter the group number (1-9).

8 Press (Register).

- To program other items, repeat steps 3 to 8.

9 Press (Off) to exit the program.

Making a voice call using the phonebook

1 Press (Phonebook).

2 Press (Search button) repeatedly until the desired name is displayed.

3 Press (Talk) or press (Speakerphone).

Editing a stored name or number in the phonebook

1 Press (Phonebook).

2 Press (Search button) repeatedly until the desired name is displayed.

3 Press (Edit).

4 Edit the name (see the table on page 9 for instructions).
• If you do not need to edit the name, skip to step 5.

5 Press (Register).

6 Enter the correct telephone number.
• If you do not need to edit the telephone number, skip to step 7.

7 Press (Register).

8 If necessary, enter the correct group number.

9 Press (Register).

Sending faxes

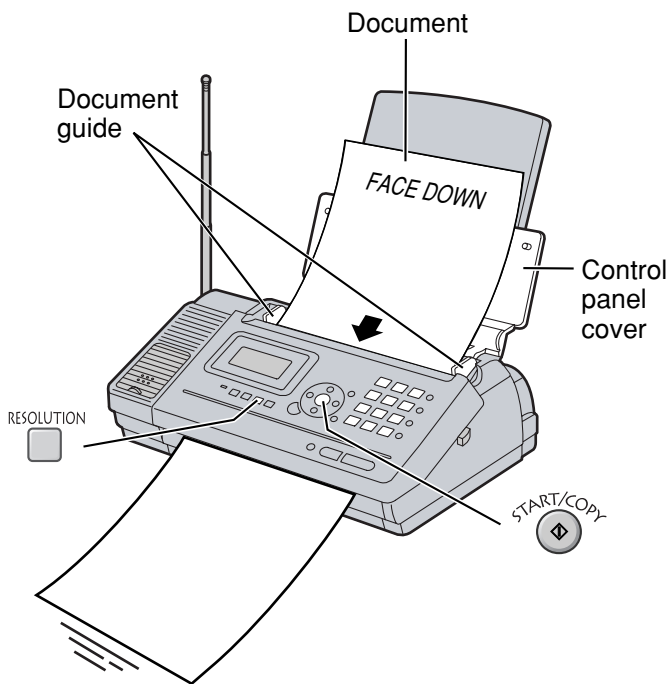

Sending a fax manually

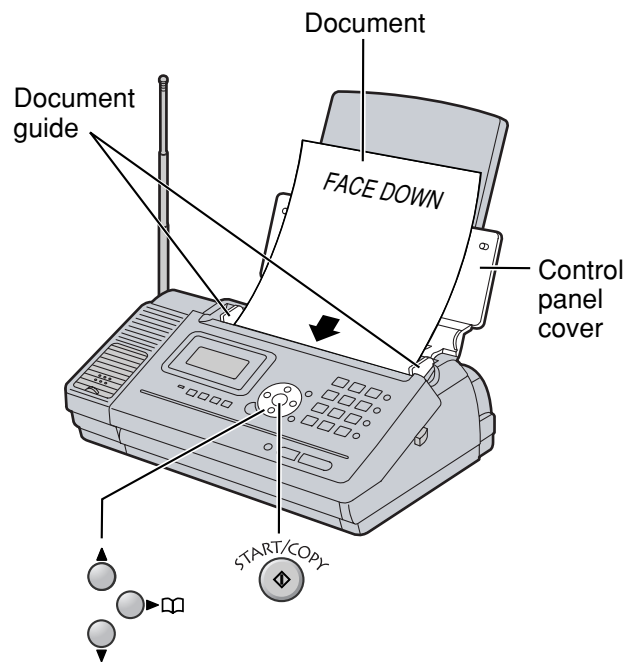

- 1 Open the control panel cover, and adjust the width of the document guides to the size of the document.
- 2 Insert the document (up to 5 pages) FACE DOWN until a single beep is heard.
- 3 If necessary, press repeatedly to select the desired setting (see below).
- 4 Dial the fax number.
- 5 Press  .
 - The unit will start fax transmission.

Sending a fax using the phonebook



- 1 Open the control panel cover, and adjust the width of the document guides to the size of the document.
- 2 Insert the document (up to 5 pages) FACE DOWN until a single beep is heard.
- 3 Press  (Phonebook).
- 4 Press  (Search buttons) repeatedly until the desired name is displayed.
- 5 Press  .
 - The unit will start fax transmission.

To select the resolution

Select the desired resolution according to the type of document, by pressing .

(Standard) for printed or typewritten originals with normal-sized characters.

(Fine) for originals with minute printing.

(Photo) for originals containing photographs.

Receiving faxes

Receiving a fax manually (AUTO ANSWER off)

Using the main unit:

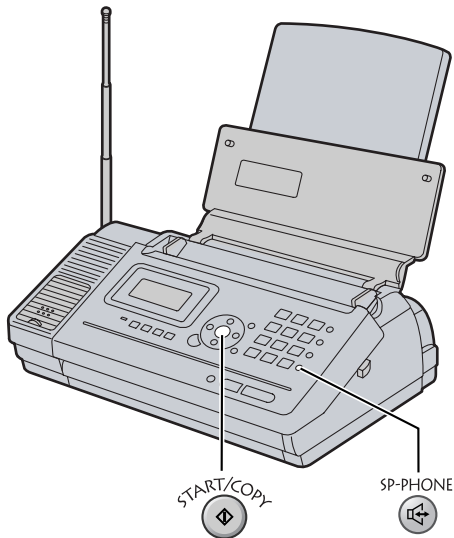

1 When you hear a ring, press  .

2 When:
– document reception is required,
– a fax calling tone (slow beep) is heard, or
– no sound is heard,

press  .

- The unit will start fax reception.

Using the portable handset:

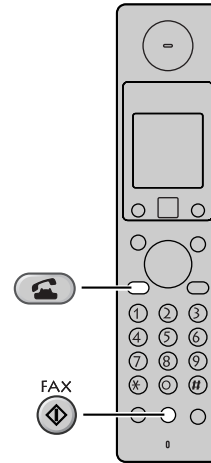



1 When you hear a ring, lift the portable handset from the charger to answer the call.
• If the portable handset is not set on the charger, press  (Talk).

2 When:
–document reception is required,
–a fax calling tone (slow beep) is heard, or
–no sound is heard,
press  (Fax reception) until a single beep is heard.
• The main unit will start fax reception.

Receiving faxes

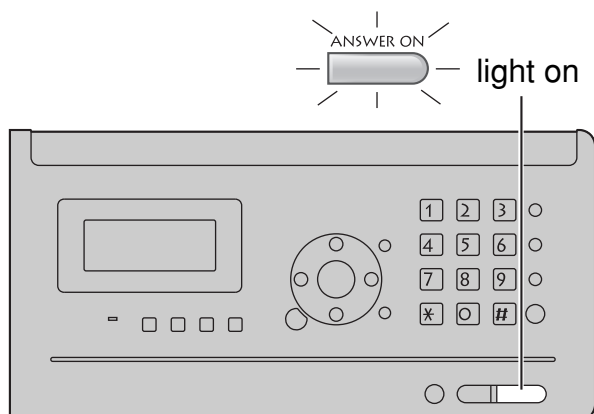
Receiving a fax automatically (AUTO ANSWER on)



1 If the  light is off, turn it on by pressing .

2 When receiving a call, the unit will receive a fax document or record a voice message automatically depending on the caller's request.

Operating the built-in answering device

Recording your own greeting message

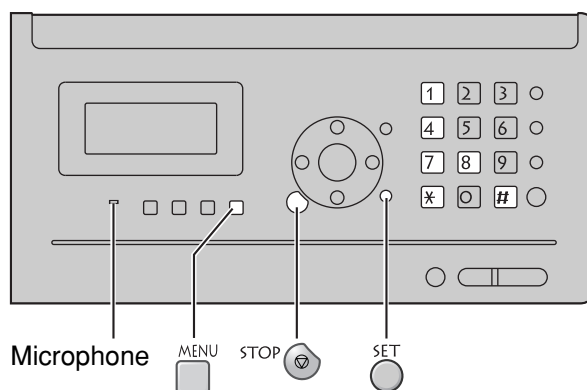

You can record your own greeting message. When receiving a call, it will be played to callers instead of the pre-recorded Japanese greeting message.

1 Press .

2 Press    .

シ^{*} サク オウトウ ロクオン
[SET] オス

3 Press .

4 Press  and speak your greeting message, up to 16 seconds, to the microphone.

5 Press .

- Your greeting message will be played back automatically.

Erasing your own greeting message

1 Press .

2 Press    .

シ^{*} サク オウトウ ショウキヨ
[SET] オス

3 Press .

4 Press .

- The pre-recorded Japanese greeting message will be played when you receive a call.

Operating the built-in answering device

Activating the answering device

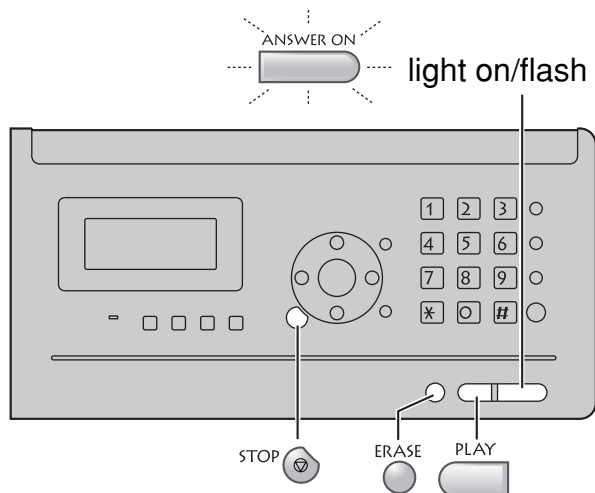

- 1 Turn the **ANSWER ON** light on by pressing **ANSWER ON**.
- 2 When receiving a call, a greeting message will be played and the unit will record a voice message.
 - To record your own greeting message, see page 14.

Listening to recorded messages

When new messages are recorded, the **ANSWER ON** light will flash.

Press **ANSWER ON** to listen to recorded messages. After the messages are played back, the following will be displayed.

- To erase the messages, push **ERASE**.
 サイセイシタ ヨウケンノ
 ショウキョル [ERASE] オス
- To save the messages, push **STOP**.

Listening to all of the recorded messages

Press **PLAY**. After the messages are played back, the following will be displayed.

- To erase the messages, push **ERASE**.
 サイセイシタ ヨウケンノ
 ショウキョル [ERASE] オス
- To save the messages, push **STOP**.

Erasing a specific message

Press **ERASE** twice while listening to the message you want to erase.

Erasing all of the recorded messages

- 1 Press **ERASE**.
 スベテ ショウキョシマスカ?
 [ERASE] オス
- 2 Press **ERASE**.

Operating the answering device from a remote location

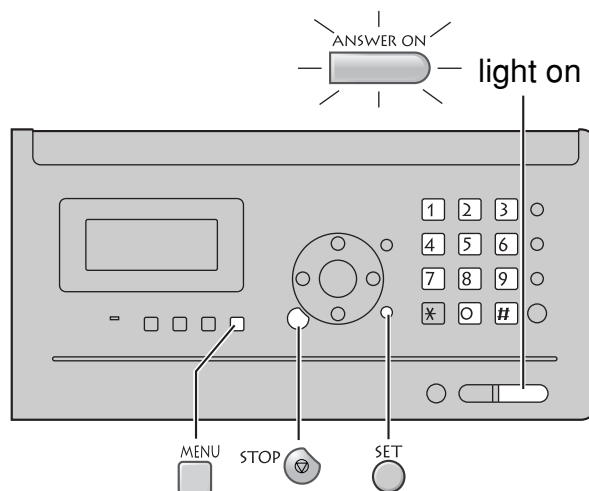

Preparation: Programming the remote operation ID

1. Press **MENU**.
2. Press **# 0 0 6**.
3. Enter any 4-digit number (remote operation ID) except * or #.

Example : アソシヨウ No. = 1234
 [4ケタ, SET] オス

4. Press **SET**.
5. Press **STOP**.

Operation: Listening to a recorded message from a remote location

Turn the **ANSWER ON** light on before you go out. Remote operations are available only from a touch tone telephone.

1. Call your unit.
2. Enter the remote operation ID during the greeting message.
3. Press **2** or wait 4 seconds.
 - Only the new recorded messages will be played back.
 - To listen to all the recorded messages, press **4** after the new messages have been played back.

Individual e-mail services

Using the e-mail services

Panasonic Communications Co., Ltd. (hereafter called "PCC") offers individual information services, such as e-mail.

Your fax machine with e-mail features will enable you to send an e-mail to another party's personal computer (PC) or another e-mail fax machine anywhere in the world through the Internet. Also, you will be able to receive an e-mail from them.

To access the Internet using your fax machine,

- you need a credit card (VISA, JCB or MASTER as of August 2003) and
- have to subscribe to individual information services offered by PCC beforehand.

The application fee including call charges will be charged to your Credit Card.

Important:

- If your fax machine is connected to a home telephone system or a private branch exchange (PBX) system, these services are not available.

Application fee and call charges

PCC information services	Registration fee	¥500
	Information Service fee (Call charge included)	¥20/minute (8 am-11 pm) ¥18.5/minute (11 pm-8 am)

- As of August 2003.
- Tax not included.

PCC information services

The following services are available with your fax machine. The information service fee including the call charge will be applied.

- E-mail reception and printing (page 17)
- Text e-mail sending (page 18)
- Fax e-mail sending (page 18)
- Others

Note:

- PCC plans to add new information services and the information service fee is subject to change. PCC will announce them by e-mail to its customers.
- For the PC user to view your fax e-mail sent from your fax machine, the following PC software will be required.
 - E-mail software that can read the MIME format
 - TIFF viewer software

Subscribing to PCC information services

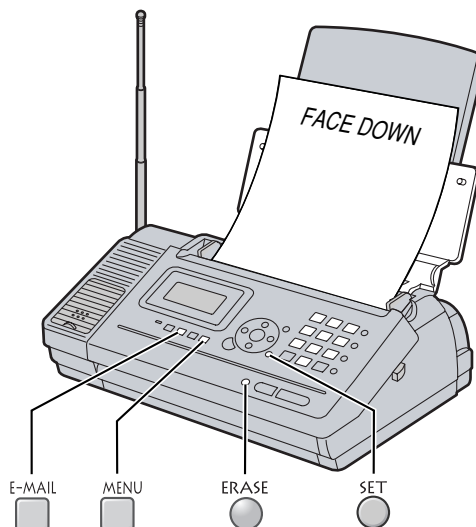

1 Fill in the included application form.

2 Press , then press .

3 Press .

4 Enter your 16-digit credit card number.

- To correct a mistake, press .

5 Press .

6 Enter your credit card number again, then press .

Individual e-mail services

7 Enter the valid date of your credit card.

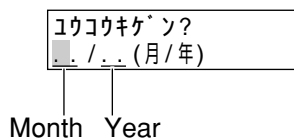

8 Press .

9 Insert the application form FACE DOWN.

10 Press .

- The unit will start fax transmission.

11 After approx. 5 minutes, the unit will ring, and a data communication will start automatically between your unit and PCC.

- If you answer this call, wait for a while until the communication is completed.

12 When the communication is completed, a user registration form will be printed.

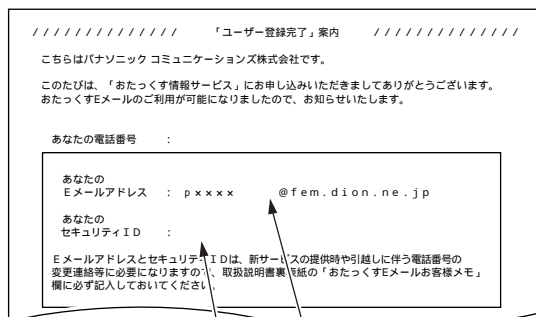

Your e-mail address
Your security ID code

- Please save the address and ID code for future reference.

13 Press .

14 Press .

- An information service guide will be printed.

Receiving and printing an e-mail

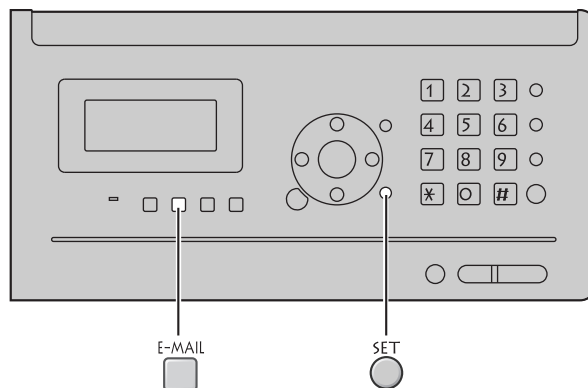

1 Press .

2 Press .

- If there is an e-mail you have not viewed yet, the unit will print the received e-mail.
- If there is no e-mail, the following will be displayed.

ミシ ュシヨメール 0ケン

The file formats recognized by your fax machine are:

- JPEG •~. doc
 - TIFF •~. xls
 - BMP •~. ppt
 - TXT •~. pdf
- (as of August 2003)

Individual e-mail services

Sending a text e-mail from the main unit

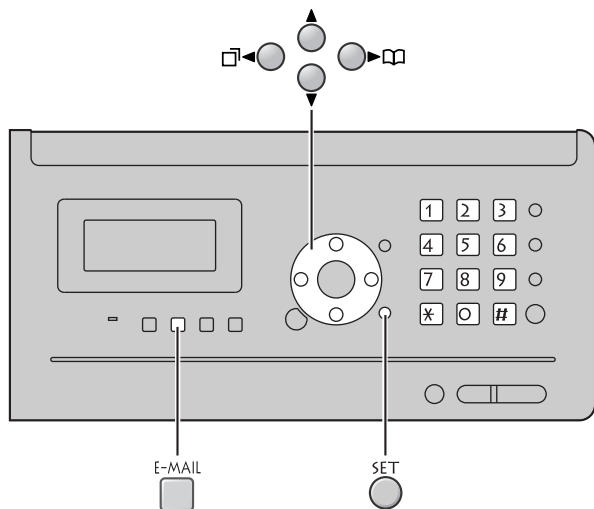

1 Press .

2 Press repeatedly until the following is displayed.

モシ Eメール ソウジン
[SET] オス

3 Press .

4 Enter the desired e-mail address (see the table on page 9 for instructions).

- You can enter the address of the last e-mail you sent by pressing .

- You can select the desired address using the addressbook.

1. Press .

2. Press repeatedly until the desired name is displayed.

3. Press .

To store an address, see page 19.

5 Press .

6 Enter the title of your e-mail, up to 32 characters (see the table on page 9 for instructions).

- You can enter the title of the last e-mail you sent by pressing .

7 Press .

8 Enter your e-mail message, up to 200 characters (see the table on page 9 for instructions).

- You can enter the message of the last e-mail you sent by pressing .

9 Press .

Sending a fax e-mail

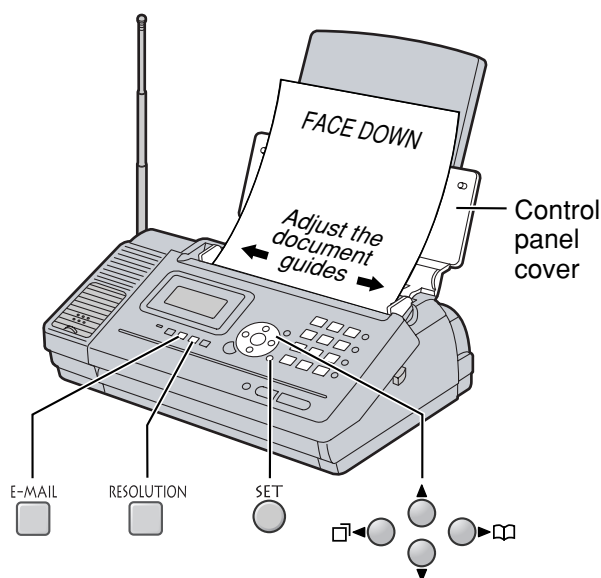

1 Open the control panel cover, and adjust the width of the document guides to the size of the document.

2 Insert the document (up to 5 pages) FACE DOWN until a single beep is heard.

3 If necessary, press repeatedly to select the desired setting (see page 12).

4 Press , then press .

5 Enter the desired e-mail address (see the table on page 9 for instructions).

- You can enter the address of the last e-mail you sent by pressing .
- You can select the desired address using the addressbook.

1. Press .

2. Press repeatedly until the desired name is displayed.

3. Press .

To store an address, see the right column of this page.

6 Press .

7 Enter the title of your fax e-mail, up to 32 characters (see the table on page 9 for instructions).

- You can enter the title of the last e-mail you sent by pressing .

8 Press .

Storing names and e-mail addresses in the addressbook

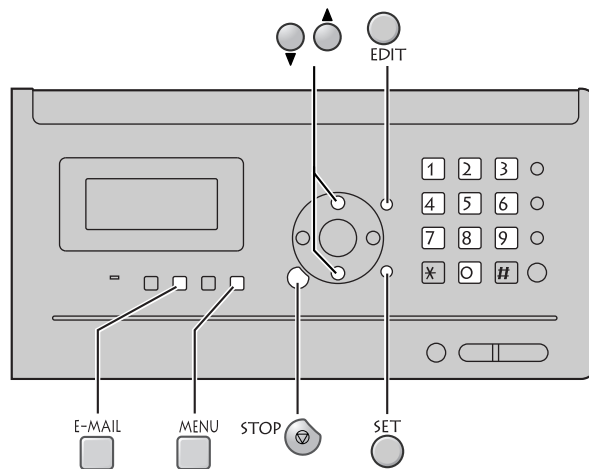

1 Press , then press .

2 Press repeatedly until the following is displayed.

アト*レス 子ヨウ
[SET] 入力

3 Press .

4 Press .

5 Enter the name, up to 12 characters (see the table on page 9 for instructions).

6 Press .

7 Enter the e-mail address, up to 60 characters (see the table on page 9 for instructions).

8 Press .

- To program other items, repeat steps 5 to 8.

9 Press to exit the program.

• To edit a stored name or e-mail address

Follow steps 1 to 3 above, then press repeatedly until the desired name is displayed.

Press , then follow steps 5 to 8.

Specifications

KX-PW110CL	Main unit	Portable handset	Battery charger
Power supply	AC 100 V (50 Hz/60 Hz)	Ni-Cd battery (Part no. KX-FAN37) DC 2.4 V, 600 mAh	AC adaptor (Part no. PFAP1009) AC 100 V (50 Hz/60 Hz) DC 7.5 V, 100 mA
Power consumption	Transmission: Approx. 17 W Reception: Approx. 22 W Copy: Approx. 22 W Stand by: Approx. 1.5 W (When the F-net service is not in use and the portable handset is on the cradle.) Approx. 0.8 W (When the F-net service is not in use and the portable handset is off the cradle.) Maximum(*1): Approx. 130 W		<ul style="list-style-type: none"> Charging: Approx. 1.3 W Stand by: Approx. 0.4 W
Dimensions (H x W x D)	Approx. 139 X 358 X 253 mm (without projections) Approx. 378 X 358 X 300 mm (recording paper tray installed, without projections)	Approx. 186 X 43 X 39 mm	Approx. 65 X 69 X 91 mm
Mass (Weight)	Approx. 3.8 kg (10 m ink film installed)	Approx. 170 g (battery installed)	Approx. 70 g
Operating environment	5 °C – 35 °C, 45 % – 85 % RH (Relative Humidity)		

KX-PW110CL	Main unit
Applicable line	Public Switch Telephone Network (Tone/Pulse), F-Net, NCC Lines
DC resistance	320 Ω (*2)
Compatibility	G3 compatible
Document size	B4-A5(Max.257 mm in width, Max. 800 mm in length)
Effective scanning size	252 mm (B4) 208 mm (A4)
Effective printing size	202 mm (A4 size plain paper)
Transmission time	Approx. 15 s/page (Original mode) (*3)
Modem speed	9,600 / 7,200 / 4,800 / 2,400 bps; Automatic fallback
Halftone level	64-level
Scanning density	Horizontal : 8 pels/mm Vertical : 7.7 lines/mm (Fine/Photo), 3.85 lines/mm (Standard)
Scanner type	Contact image sensor
Printer type	Thermal transfer printing on plain paper
Data compression system	Modified Huffman (MH), Original mode
Recording paper size	A4: 210 mm x 297 mm (Plain paper)
Answering device	Greeting message: Digital recording system (up to 16 sec) Pre-recording greeting message ICM Recording: Digital recording system (Approx. 18 min. in total) (*4)
Memory capacity	Max. Approx. 46 pages (Only receiving fax etc.) (*5) Max. Approx. 18 min. (Only Recording message) (*4)

*1 When copying a 100% black document.

*2 If you cannot make a call due to DC resistance, consult your dealer.

*3 Transmission speed is based on an A4-size document of 700 characters sent in standard resolution at 9,600 bps. The actual transmission speed depends upon the contents of the page, resolution, telephone line conditions and capability of the other party's machine.

*4 If there is a silent pause, the total recording time will be longer.

*5 The memory capacity is based on an A4-size document of 700 characters.

Free Manuals Download Website

<http://myh66.com>

<http://usermanuals.us>

<http://www.somanuals.com>

<http://www.4manuals.cc>

<http://www.manual-lib.com>

<http://www.404manual.com>

<http://www.luxmanual.com>

<http://aubethermostatmanual.com>

Golf course search by state

<http://golfingnear.com>

Email search by domain

<http://emailbydomain.com>

Auto manuals search

<http://auto.somanuals.com>

TV manuals search

<http://tv.somanuals.com>