

Facsimile

Quick Reference Guide

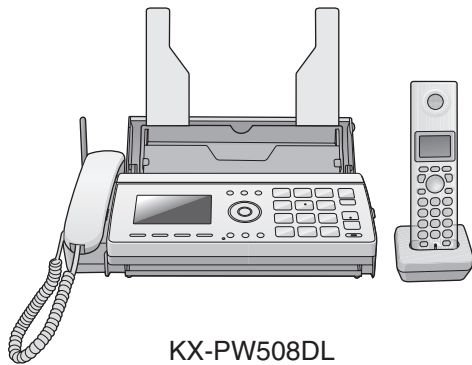

KX-PW508DL

Model No. **KX-PW508DL**
KX-PW508DW
KX-PW508D

Main unit: KX-PW508
 Portable handset: KX-FKN516

Thank you for purchasing a Panasonic facsimile.

Table of Contents

Finding the controls	2
Installations and connections	4
Setting the date and time.....	7
Setting your facsimile telephone number	7
Setting your logo	8
Character input and command key table	9
Voice guide.....	10
Automatic dialing on the main unit	11
Automatic dialing on the portable handset (KX-FKN516)	13
Intercom	14
Sending faxes	15
Receiving faxes	16
Operating the built-in answering device	17
Night mode.....	18
Call block	19
Specifications	Back cover

- This guide explains some basic features and operations, but not all of them. For further details, see the Japanese operating instructions.
- This product is designed for use in Japan.
Panasonic cannot provide service for this product if used outside Japan.
- KX-PW508DL includes 1 portable handset and 1 main unit.
KX-PW508DW includes 2 portable handsets and 1 main unit.
KX-PW508D includes 1 main unit.
- Any details given in this guide are subject to change without notice.

This unit is equipped with the voice guide features. (Japanese only)
For details about voice guide, please see page 10.

Finding the controls

Main unit

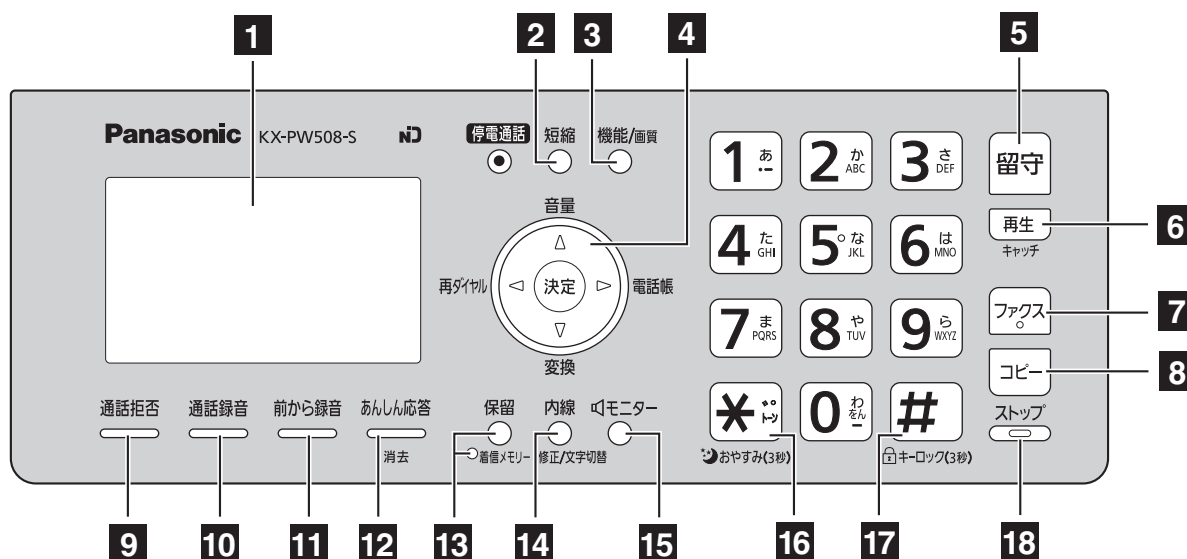

1 Liquid crystal display

2 Speed Dial button

3 Function button initiates programming.

Resolution button selects the resolution when faxing or copying.

4 Volume/Change/Redial/Phonebook key

音量



- To adjust the volume (see below).

変換

- To change Hiragana into Kanji.

■ To adjust the **ringer volume** when the unit is on stand by



(Set) → (press repeatedly) → ストップ

■ To adjust the **receiver volume** while talking, press repeatedly.

■ To adjust the **speaker volume** while listening to the recorded messages or using the monitor, press repeatedly.



To redial the phone numbers in the redial list. The last 10 phone numbers dialed are stored in memory.



To use the phonebook.



To store a parameter.

5 Auto Answer button & indicator

—light on: answering device activated.

—light off: used as a regular telephone.

6 Playback button plays back recorded messages.

Flash button (For call waiting service users.)

7 Fax button starts faxing.

8 Copy button starts copying.

9 Block button for the undesired call

10 Record button records a telephone conversation.

11 Enhanced Record button records the previous 60 seconds of telephone conversation.

12 Secure button

While the unit is ringing, press this button. The unit announces a message to the caller. The message is announced in Japanese and means “This unit is currently set to Caller Verifying mode. Could you please speak out your name?”.

■ To talk to the caller, lift the handset.

■ To hang up, press .

Erase button

13 Hold button

Call Memory button starts a search in the Number Display (Caller ID) log.

Call Memory indicator lights when a call was missed.

(For Number Display service users.)

14 Intercom/Edit/Character Input Mode button

15 Monitor button

16 Tone button switches to tone dialing.

Night mode button

17 Sharp button

Key lock button can lock the main unit so that no calls or settings can be made. To turn key lock on, press this button for about 3 seconds until a single beep is heard.

- “” is displayed.









- To turn key lock off, press this button for about 3 seconds.





18 Stop button

Finding the controls



Portable handset (KX-FKN516)

How to use key

-  ● To use the phonebook.
-  ● To redial the phone numbers in the redial list. The last 10 phone numbers dialed are stored in memory.
-  ● To change Hiragana into Kanji.
- To adjust the volume.
 - To adjust the ringer volume when the portable handset is on stand by
 (Select “呼出音量”)  (press repeatedly)  or 
 - To adjust the receiver volume while talking, press  repeatedly
 - To adjust the speaker volume while listening to the recorded messages or using the speakerphone, press  repeatedly

-  ● To make/answer calls.
-  ● To end a call.
● To end or exit from editing or other operations.
-  ● To put a call on hold.
-  ● To start a search in the Number Display log. (For Number Display service users.)
-  ● To page the main unit and/or portable handset(s).

Dial buttons

-  ● To switch to tone dialing.
-  ● Key lock button
 - To lock the portable handset so that no calls or settings can be made. To turn key lock on, press this button for about 3 seconds until a single beep is heard.
 - “” is displayed.
 - To turn key lock off, press this button for about 3 seconds until a single beep is heard.

Earpiece

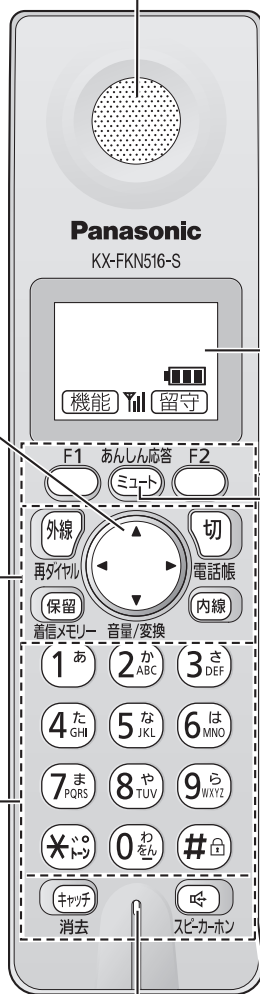



Microphone

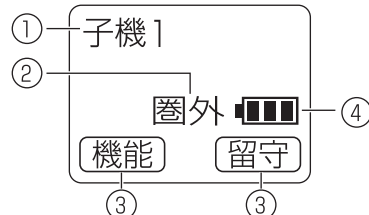

(Do not cover the microphone while talking.)

Liquid crystal display



- ① Portable handset number (and name)
- ② No link to the main unit
- ③ Function menu that is controlled by  or 
- ④ Battery strength

How to use buttons

 and  buttons refer to the function displayed on the bottom of the display. They function differently depending on the mode.

あんしん応答



Secure button

- While the portable handset is ringing, press this button. The portable handset announces a message to the caller. The message is announced in Japanese and means “This unit is currently set to Caller Verifying mode. Could you please speak out your name?”

- To talk to the caller, press .

- To hang up, press .

Mute button

- To mute your voice to the other party by pressing this button for about 2 seconds. (To release the mute, press this button again.)



消去

- For call waiting service users.
- To clear letters/numbers.



スピーカホン

- To use the speakerphone.

Installations and connections

Installing the ink film

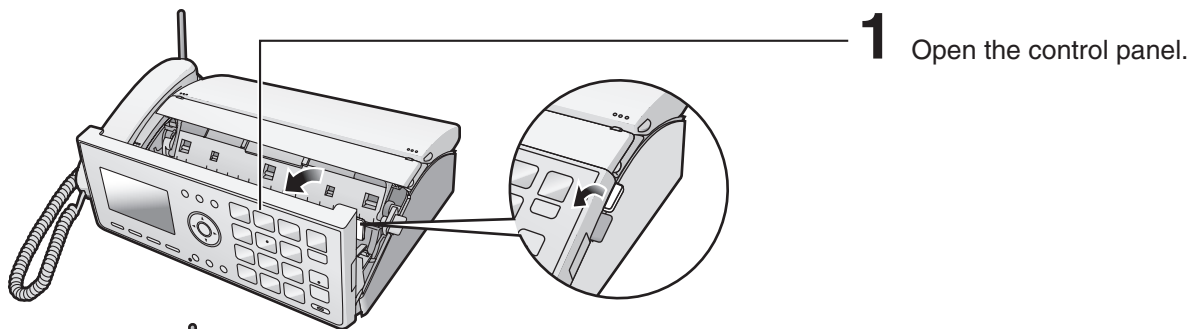

1 Open the control panel.

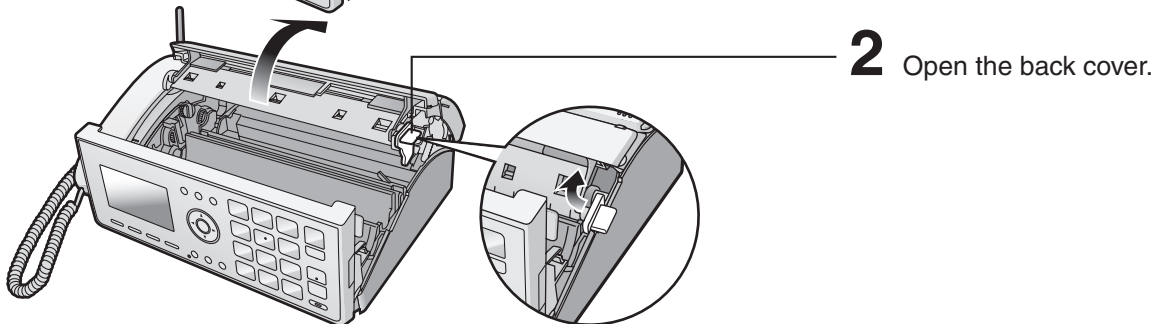

2 Open the back cover.

Insert the orange gear into the left slot of the main unit.

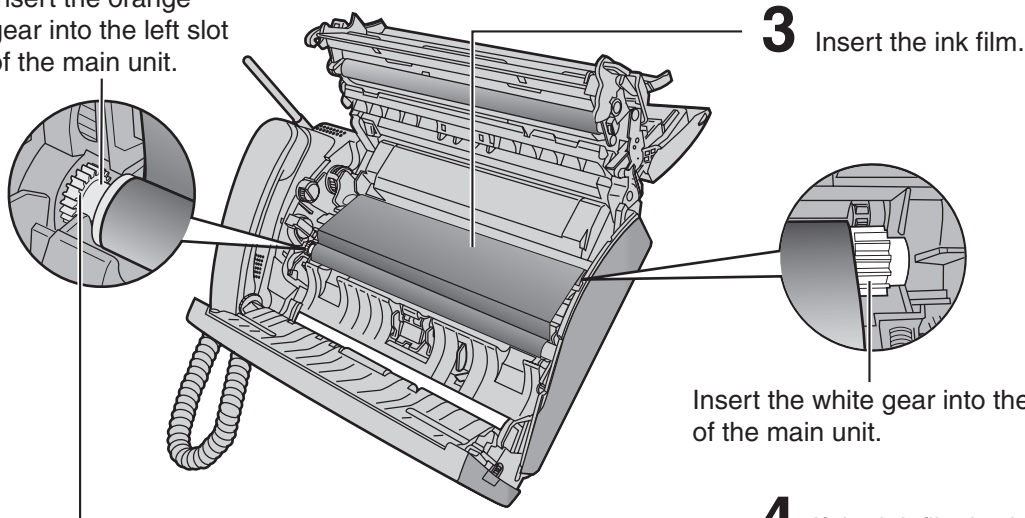

3 Insert the ink film.

Insert the white gear into the right slot of the main unit.

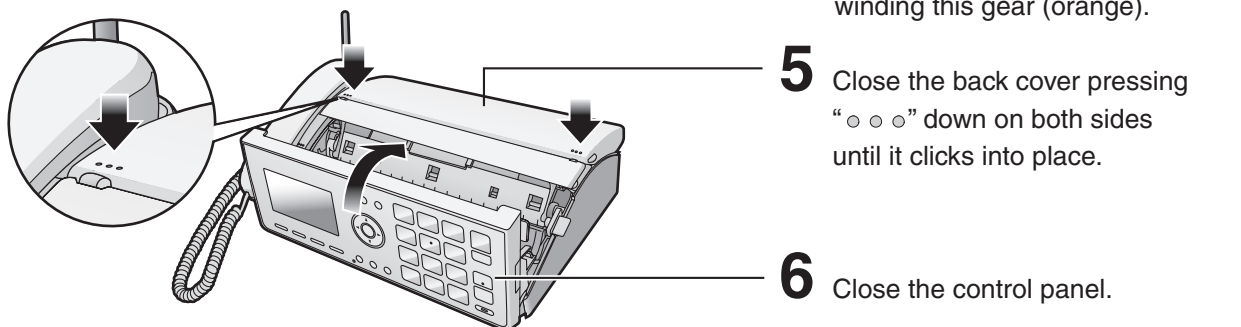

4 If the ink film is slack, tighten it by winding this gear (orange).

5 Close the back cover pressing "○○○" down on both sides until it clicks into place.

6 Close the control panel.

• When the unit runs out of ink film, the following message will be displayed.

フィルムなし U23
交換してください
品番: KX-FAN190

Install a new ink film.

Replacement ink film:	
KX-FAN190 (15 m)	¥714
KX-FAN190W (15 m X 2)	¥1,208
KX-FAN191 (15 m) (*1)	¥893
KX-FAN191W (15 m X 2) (*1)	¥1,523

*1 KX-FAN191/KX-FAN191W leaves a fainter print trail on the film than does the KX-FAN190/190W.

· As of October 2008. · Tax included.

Installations and connections

Installing recording paper (A4 size)

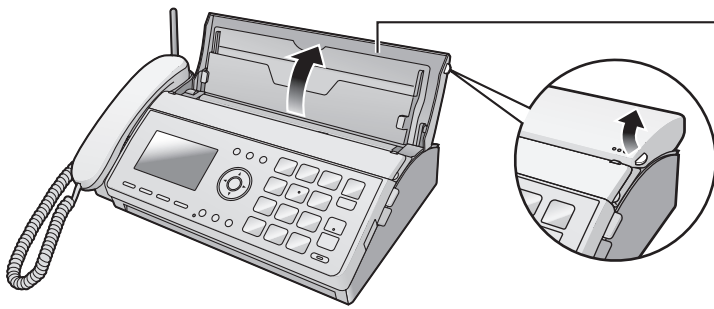

1 Open the recording paper tray.

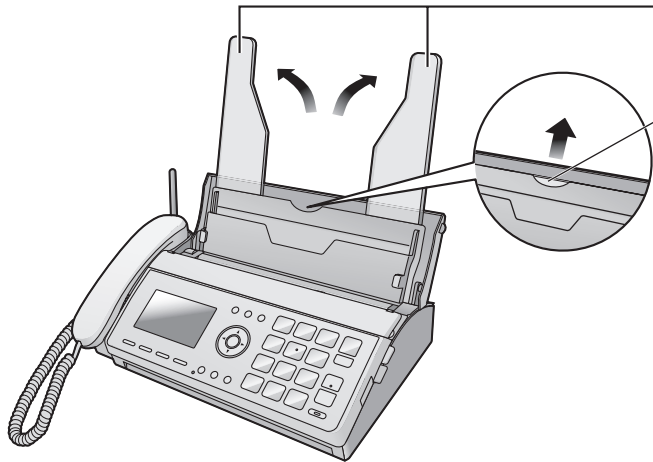

2 Set up the recording paper stands.

Pull out the front stand first.

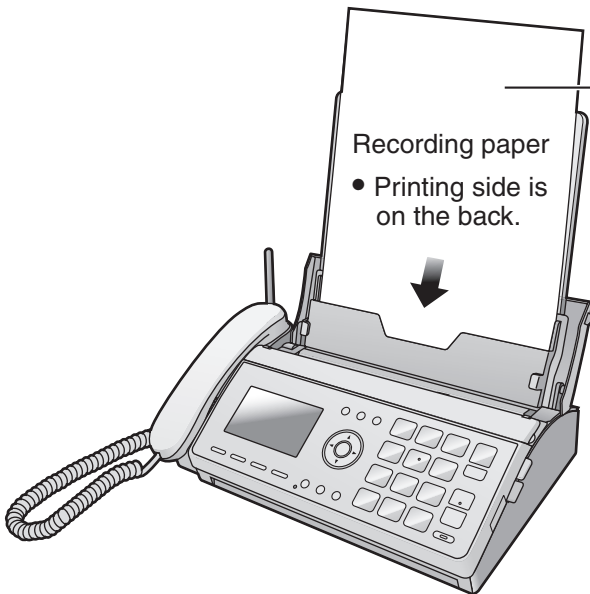

3 Insert the recording paper into the recording paper tray. (Up to 15 sheets)

- Fan the stack of recording paper.

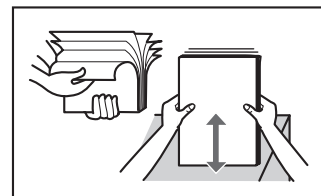

Folding the recording paper tray

① Remove the recording paper and fold the recording paper stands in.



② Close the recording paper tray.



Installations and connections

Connecting the main unit

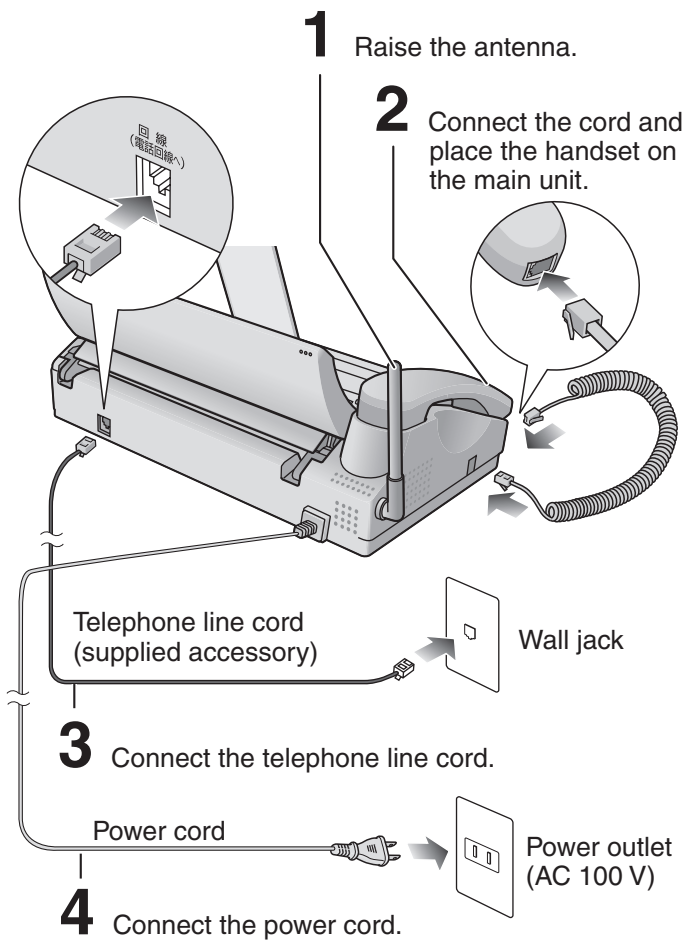

After the Power On...

- ① This unit will automatically select the dialing mode (Pulse/Tone).
- ② When the following is displayed, press **ストップ** (Stop).

選んでケータイの設定

If you cannot make a call...

Set the dialing mode with the main unit.

- 機能/画質
1. Press **○** (Function/Resolution).
 2. Press **# 0 7 9**.
 3. Press **⬇** (Search button) repeatedly until the desired setting is selected.

Example :

回線種別
自動

- アップシユ : Tone
- 20 : Pulse (20 PPS)
- 10 : Pulse (10 PPS)
- 自動 : Auto (Default)

4. Press **決定** (Set).
5. Press **ストップ** (Stop).

Setting up the portable handset (KX-FKN516)

- 1 Press **⬇** on the battery cover and slide the cover.

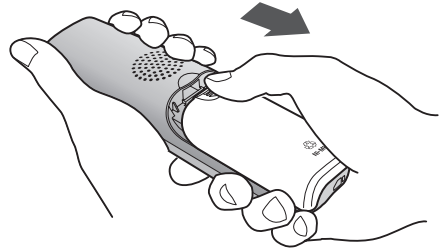

- 2 Insert the battery into the compartment and close the battery cover.

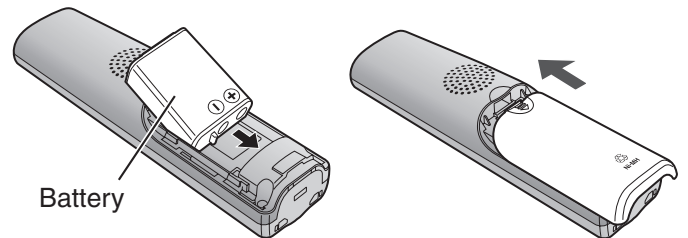

- 3 Connect the charger to the power outlet, then place the portable handset on the charger for about **10 hours**.

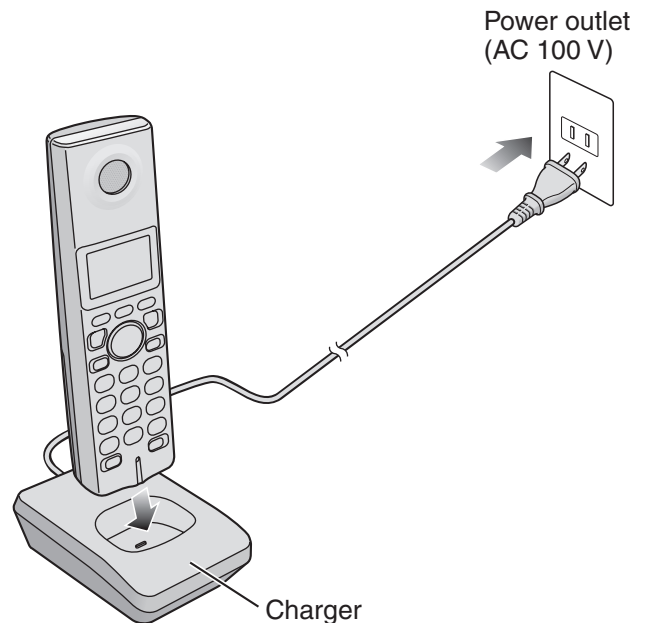

- After your Panasonic battery is fully charged, it will last up to about 5 hours of conversation.

Setting the date and time

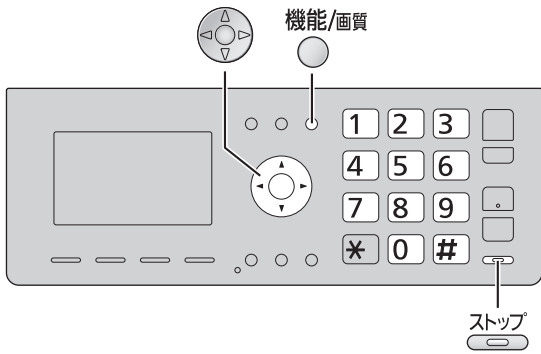

1 Press (Function/Resolution).

機能登録モード

2 Press **# 0 0 1**.

Example :

日付時刻
2008年11月30日
15:30

Cursor

3 Enter the correct year/month/day.

Example: December 1, 2008

Press **2 0 0 8 1 2 0 1**.

日付時刻
2008年12月01日
15:30

4 Enter the correct hour/minute in a 24-hour clock entry.

Example: 15:45 (3:45 PM)

Press **1 5 4 5**.

日付時刻
2008年12月01日
15:45

5 Press (Set).

登録しました



日付時刻
2008年12月01日
15:45

6 Press (Stop).

Example :

1日 15:45
録音 0件

Setting your facsimile telephone number

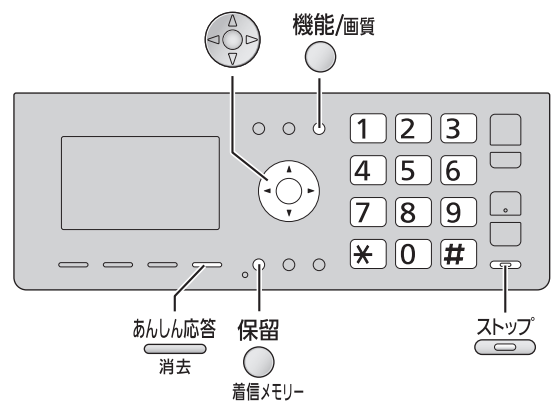

1 Press (Function/Resolution).

機能登録モード

2 Press **# 0 0 4**.

あなたの電話番号

3 Enter your facsimile telephone number, up to 20 digits.

Example: +098 7654..

あなたの電話番号
+098 7654..

- The (Tone) button replaces the digit with "+".
- The (Hold/Call memory) button replaces the digit with a space.
- To correct a mistake, press (Secure/Erase).

4 Press (Set).

登録しました



あなたの電話番号
+098 7654..

5 Press (Stop).

Example :

1日 15:45
録音 0件

Setting your logo

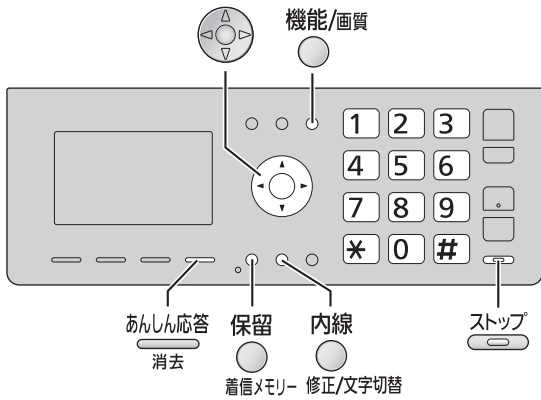

1 Press (Function/Resolution).

機能登録モード

2 Press .

名前:印刷用 [漢]
Cursor

3 Enter your logo, up to 30 characters, using the dial keypad.

- To enter English characters easily, press (Intercom/Edit/Character input mode) repeatedly and select “英” (English and sign input mode).
- For details, see the table on page 9 for instructions.

Example: Micah

1. Press once.

名前:印刷用 [英]
M
Cursor

2. Press six times.

名前:印刷用 [英]
Mi

3. Press six times.

名前:印刷用 [英]
Mic

4. Press to move the cursor to the next space and press four times.

名前:印刷用 [英]
Mica

5. Press five times.

名前:印刷用 [英]
Micah

4 Press (Set).

登録しました



名前:印刷用 [漢]
Micah
-







5 Press (Stop).

Example :

1日 15:45
録音 0件

Character input and command key table













Pressing the dial keys will select a character as shown below.

Character		Hiragana	Katakana	English	Numbers
Display of the main unit and the portable handset		[漢]	[カナ]	[英]	[数]
Dial key					
(Main unit) 1	(Portable handset KX-FKN516) 1	あいうえお あいうえお	アイウエオ アイウエオ	@ . _ - & \$ ¥ % + = ~ ^	1
2	2	かきくけこ	カキクケコ	A B C a b c	2
3	3	さしすせそ	サシスセソ	D E F d e f	3
4	4	たちつてとっ	タチツテトツ	G H I g h i	4
5	5	なにぬねの	ナニヌネノ	J K L j k l	5
6	6	はひふへほ	ハヒフヘホ	M N O m n o	6
7	7	まみむめも	マミムメモ	P Q R S p q r s	7
8	8	やゆよやゆよ	ヤユヨヤユヨ	T U V t u v	8
9	9	らりるれろ	ラリルレロ	W X Y Z w x y z	9
0	0	わをんー! ? ()	ワヲンー! ? ()	! ? / - * # , ; : . ' " () [] { } < > 「 」	0
*	*	” ° , 。		、 °	
Command keys		内線 (Main unit), F2 (Portable handset)  (Main unit),  (Portable handset)		Used to change the character input mode.	
		 (Main unit),  (Portable handset)		Used to move the cursor to the left and right.	
		あんしん応答 (Main unit), キャッチ (Portable handset) 消去 (Main unit), 消去 (Portable handset)		Used to delete a character.	
		保留 (Main unit), 保留 (Portable handset)  (Main unit),  (Portable handset)		Used to insert a space.	

- The characters on the display are somewhat different from those shown in the character input and command key table.

Operation guide

The unit starts the following voice guidance in Japanese:

Operations	To cancel the operation guide (using the main unit)
Send a fax	機能/画質 → # 0 2 1 →  (Select “なし”) →  決定 →  ストップ
Copy	
Add entries to the phonebook	
Store phonebook entries in the speed dialer	機能/画質 → # 1 6 7 →  (Select “なし”) →  決定 →  ストップ
Make a call using the phonebook/redial/ speed dialer/call memory	
Change a ink film	機能/画質 → # 1 7 3 →  (Select “なし”) →  決定 →  ストップ
Print fax documents from the main unit memory	機能/画質 → # 1 7 7 →  (Select “なし”) →  決定 →  ストップ

Reading-out dial

The unit announces the number dialed in Japanese, when you make a call with the main unit.

• To cancel the reading-out dial



Reading-out phonebook

The unit reads out stored names* when the phonebook is searched.

• To cancel the reading-out phonebook



Incoming name announcement (for Number Display service subscribers only)

The unit announces the caller's name* when a call is received from a caller whose name and phone number are stored in the phonebook.

• To cancel the incoming name announcement



* Names will only be read out when their “フリガナ” (readings) are stored in katakana in the phonebook. English, numbers and signs in “フリガナ” are not read out.

Automatic dialing on the main unit

Storing names and telephone numbers in the phonebook

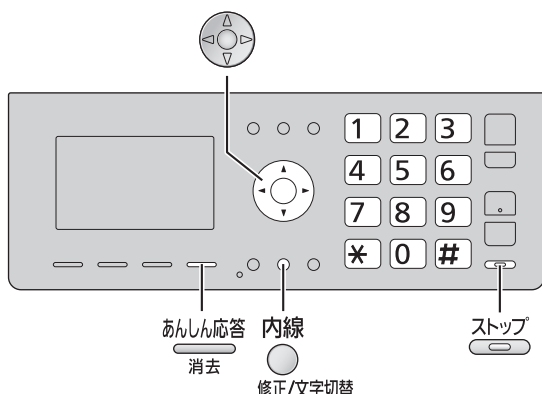

- 1 Press (Phonebook).
 - “XXX” shows the remaining station numbers you can store.
 - You can program up to 150 stations, including 4 pre-programmed stations.

電話帳空き XXX件
登録は[決定]押す
検索は[▼,▲]押す

- 2 Press (Set).

名前? [漢]
|
-

- 3 Enter the name, up to 20 characters (see the table on page 9 for instructions).

- 4 Press (Set) 2 times.

- 5 Enter the telephone number, up to 24 digits.
 - To correct a mistake, press (Secure/Erase).

- 6 Press (Set).

- 7 Enter the group number (1 to 9).

- 8 Press (Set).
 - To program other items, repeat steps 3 to 8.

- 9 Press (Stop) to exit the program.

Making a voice call using the phonebook

- 1 Press (Phonebook).
- 2 Press (Search button) repeatedly until the desired name is displayed.
- 3 Lift the handset.

Editing a stored name or number in the phonebook

- 1 Press (Phonebook).
- 2 Press (Search button) repeatedly until the desired name is displayed.
- 3 Press (Intercom/Edit/Character input mode).
- 4 Edit the name (see the table on page 9 for instructions).
 - If you do not need to edit the name, skip to step 5.
- 5 Press (Set).
- 6 Edit the kana.
 - If you do not need to edit the kana, skip to step 7.
- 7 Press (Set).
- 8 Edit the telephone number.
 - If you do not need to edit the telephone number, skip to step 9.
- 9 Press (Set).
- 10 Edit the group number.
 - If you do not need to edit the group number, skip to step 11.
- 11 Press (Set).
- 12 Press (Stop).

Automatic dialing on the main unit

Storing names and telephone numbers in the speed dialer

You can store up to 9 names and telephone numbers which are stored in the phonebook. The dialing buttons (1 to 9) function as memory stations.

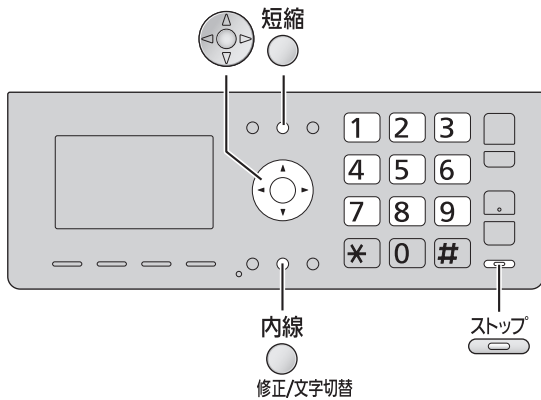

1 Press (Speed dialer).

2 Press the memory station number (1 to 9).

Example: speed dialer 1

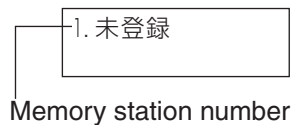

3 Press (Intercom/Edit/Character input mode).

4 Press (Search button) repeatedly until the desired name is displayed.

5 Press (Set).

• To program other items, repeat steps 2 to 5.

6 Press (Stop) to exit the program.

Making a voice call using the speed dialer

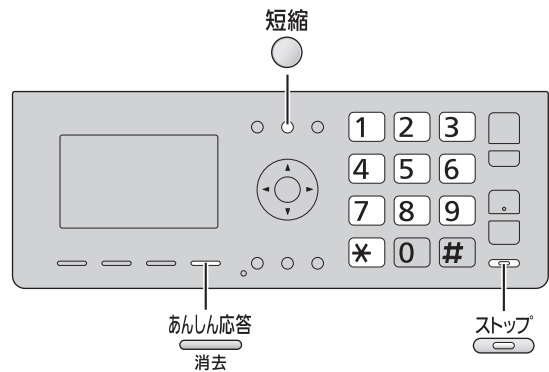

1 Press (Speed dialer).

2 Press the memory station number (1 to 9).

3 Lift the handset.

Erasing a stored name and number in the speed dialer

1 Press (Speed dialer).

2 Press the memory station number (1 to 9).

3 Press (Secure/Erase), then press .

4 Press (Stop) to exit the program.

Automatic dialing on the portable handset (KX-FKN516)

Storing names and telephone numbers in the phonebook

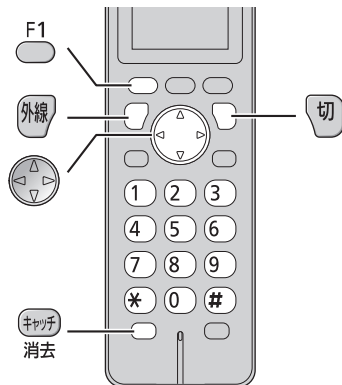

1 Press (Phonebook).

検索は
[▼,▲]を押す

2 Press .

- "XXX" shows the remaining station numbers you can store.
- You can program up to 150 stations, including 4 pre-programmed stations.

名前?
空き XXX件

3 Enter the name, up to 20 characters (see the table on page 9 for instructions).

4 Press 2 times.

5 Enter the telephone number, up to 24 digits.

- To correct a mistake, press (Flash/Erase).

6 Press .

7 Enter the group number (to .

8 Press .

- To program other items, repeat steps 3 to 8.

9 Press (Off) to exit the program.

Making a voice call using the phonebook

1 Press (Phonebook).

2 Press (Search button) repeatedly until the desired name is displayed.

3 Press (Talk).

Editing a stored name or number in the phonebook

1 Press (Phonebook).

2 Press (Search button) repeatedly until the desired name is displayed.

3 Press .

4 Edit the name (see the table on page 9 for instructions).

- If you do not need to edit the name, skip to step 5.

5 Press .

6 Edit the kana.

- If you do not need to edit the kana, skip to step 7.

7 Press .

8 Enter the correct telephone number.

- If you do not need to edit the telephone number, skip to step 9.

9 Press .

10 Edit the group number.

- If you do not need to edit the group number, skip to step 11.

11 Press .

12 Press (Off) to exit the program.

Intercom

An intercom is available between the portable handsets or between the main unit and portable handset(s).

Using the main unit:

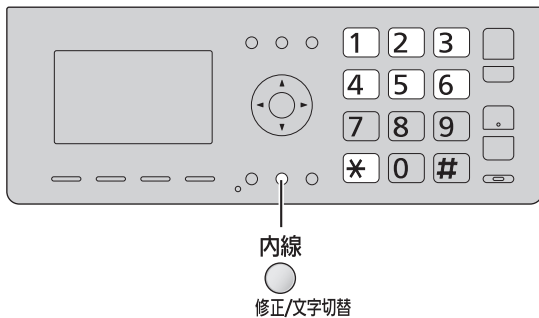

1 ■ For single portable handset users

- ① Lift the handset.

電話番号?

- ② Press  (Intercom/Edit/Character input mode).

子機1呼出中

■ For multiple portable handset users

- ① Lift the handset.

- ② Press  (Intercom/Edit/Character input mode).

- ③ Call the portable handset(s) in the following ways:
 - To call a specific portable handset, press the portable handset number (1 to 6) which you want to call.
 - To call all the portable handsets, press *.

2 Start talking.

Example : 子機1内線通話中

3 Replace the handset to end the intercom call.

Using the portable handset (KX-FKN516):

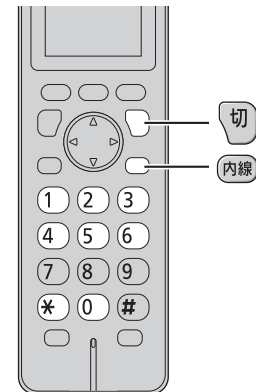

1 ■ For single portable handset users

- Press  (Intercom).

■ For multiple portable handset users

- ① Press  (Intercom).
- ② Call the main unit and/or portable handset(s) in the following ways:
 - To call a specific portable handset, press the portable handset number (1 to 6) which you want to call.
 - To call the main unit, press 0.
 - To call the main unit and all the portable handsets, press *.

2 Start talking.



内線通話中

3 Press (Off) to end the intercom call.

Sending faxes

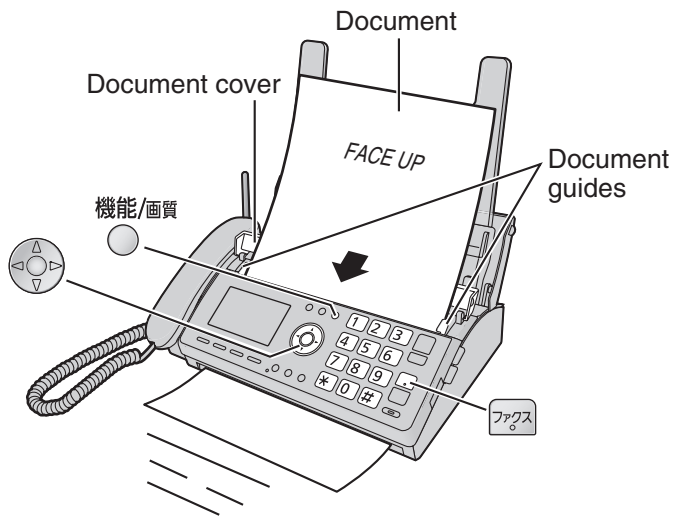
Sending a fax manually



- 1 Open the document cover, and adjust the width of the document guides to the size of the document.
- 2 Insert the document (up to 5 pages) FACE UP until a single beep is heard.
- 3 If necessary, press  repeatedly to select the desired resolution while “画質=” is displayed (see below).
- 4 Press  (Fax).
- 5 Dial the fax number.
- 6 Press  (Fax).
 - The unit will start fax transmission.

To select the resolution

Select the desired resolution according to the type of document, by pressing  repeatedly while “画質=” is displayed.



To display “画質=”, press  (Function/Resolution) once or twice.

- | | |
|---------|---|
| 画質=ふつう字 | (Standard) for printed or typewritten originals with normal-sized characters. |
| 画質=小さい字 | (Fine) for originals with minute printing. |
| 画質=写真 | (Photo) for originals containing photographs. |

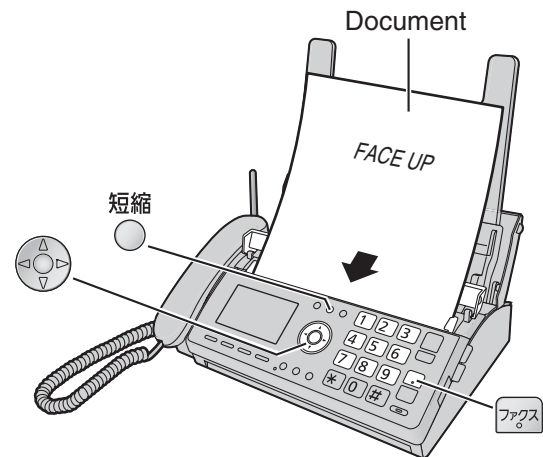



Sending a fax using automatic dialing



Using the phonebook

- 1 Insert the document (up to 5 pages) FACE UP until a single beep is heard.
- 2 Press  (Phonebook).
- 3 Press  (Search button) repeatedly until the desired name is displayed.
- 4 Press  (Fax).
 - The unit will start fax transmission.

Using the speed dialer

- 1 Insert the document (up to 5 pages) FACE UP until a single beep is heard.
- 2 Press  (Speed dialer).
- 3 Press the memory station number ( to ).
- 4 Press  (Fax).
 - The unit will start fax transmission.

Receiving faxes

Receiving a fax manually (AUTO ANSWER off)

Using the main unit:

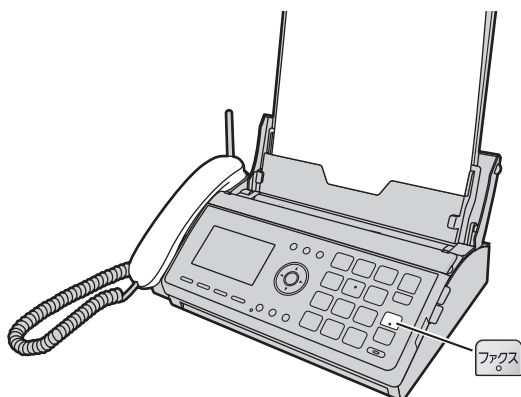

1 When you hear a ring, lift the handset to answer the call.

2 When:
– document reception is required,
– a fax calling tone (slow beep) is heard, or
– no sound is heard,
press **ファクス** (Fax), then replace the handset.

- The unit will start fax reception.

Using the portable handset (KX-FKN516):

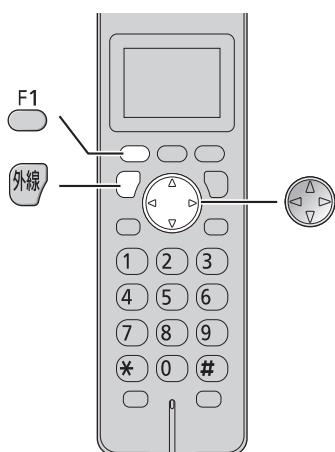

1 When you hear a ring, lift the portable handset from the charger, then press **外線** (Talk) to answer the call.

2 When:
– document reception is required,
– a fax calling tone (slow beep) is heard, or
– no sound is heard,
press **F1**.

3 Press  (Search button) repeatedly until the “ファクス受信” is displayed, then press **F1**.

4 Press **F1**.

- The main unit will start fax reception.

Receiving a fax automatically (AUTO ANSWER on)

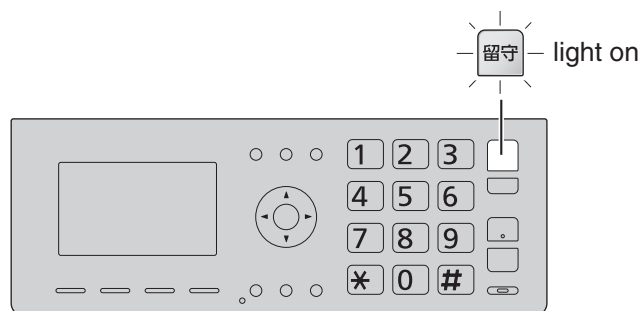

1 If the **留守** (Auto answer) light is off, turn it on by pressing **留守**.

2 When receiving a call, the unit will receive a fax document or record a voice message automatically depending on the caller's request.

Operating the built-in answering device

Recording your own greeting message

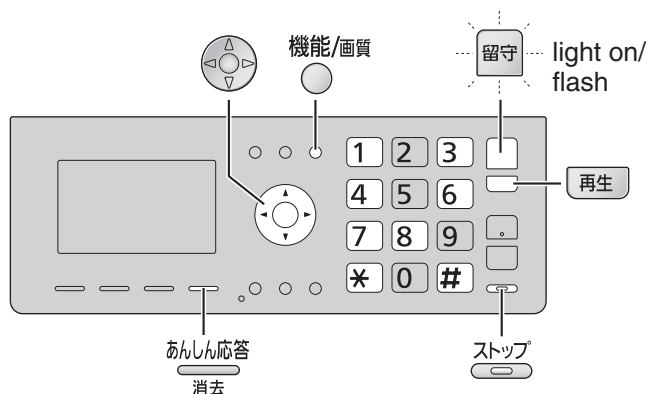

You can record your own greeting message. When receiving a call, it will be played to callers instead of the pre-recorded Japanese greeting message.

- 1 Press **機能/画質** (Function/Resolution).
- 2 Press **# 1 4 7**.

自作応答録音
[決定]押す
- 3 Press **決定** (Set).
- 4 Lift the handset.
- 5 Press **決定** (Set) and speak your greeting message after a beep, up to 16 seconds, to the handset.
- 6 Press **ストップ** (Stop) and replace the handset.
 - Your greeting message will be played back automatically.

Erasing your own greeting message

- 1 Press **機能/画質** (Function/Resolution).
- 2 Press **# 1 4 8**.

自作応答消去
[決定]押す
- 3 Press **決定** (Set).
- 4 Press *****.
 - The pre-recorded Japanese greeting message will be played when you receive a call.

Activating the answering device

- 1 Turn the **留守** (Auto answer) light on by pressing **留守**.
- 2 When receiving a call, a greeting message will be played and the unit will record a voice message.
 - To record your own greeting message, see left.

Listening to recorded messages

When new messages are recorded, the **留守** (Auto answer) light will flash.

Press **留守** to listen to recorded messages.

After the messages are played back, the following will be displayed.

- To erase the messages, press *****.

再生した用件を
消去しますか？
はい=* いいえ=#
- To save the messages, press **#**.

Listening to all of the recorded messages

Press **再生** (Playback) when new messages are not recorded.

- When new messages are recorded, only the new messages will be played back.

After all of the recorded messages are played back, the following will be displayed.

- To erase the messages, press *****.

すべて
消去しますか？
はい=* いいえ=#
- To save the messages, press **#**.

Erasing a specific message

Press **あんしん応答 消去** (Secure/Erase) while listening to the message you want to erase, then press *****.

Erasing all of the recorded messages

- 1 Press **機能/画質** (Function/Resolution).
- 2 Press **# 1 6 3**.

用件全消去
[決定]押す
- 3 Press **決定** (Set).
- 4 Press *****.

Operating the built-in answering device

Operating the answering device from a remote location

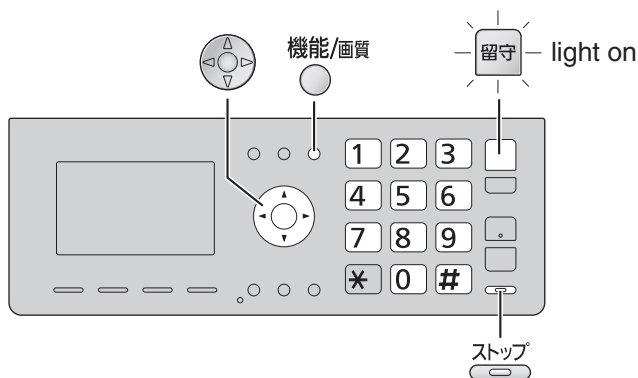

Preparation: Programming the remote operation ID

1. Press (Function/Resolution).
2. Press .
3. Enter any 4-digit number (remote operation ID) except * or #.

Example :

留守電暗証番号
1234

4. Press (Set).
5. Press (Stop).

Operation: Listening to a recorded message from a remote location

Turn the (Auto answer) light on before you go out. Remote operations are available only from a touch tone telephone.

1. Call your unit.
2. Enter the remote operation ID during the greeting message.
3. Press or wait 4 seconds.
 - Only the new recorded messages will be played back.
 - To listen to all the recorded messages, press after the new messages have been played back.

Night mode

Turn on the night mode

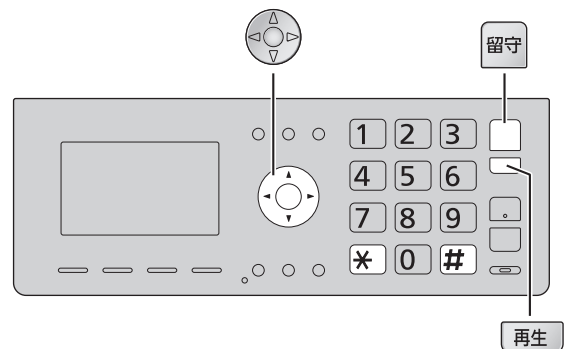

Press (Night mode) for about 3 seconds.

- “” is displayed and lights on.
- When a call is received during night mode, the unit will handle the call silently, either by storing the received fax into memory or by recording the caller's message.
- Night mode allows you to select a block of time during which the unit will not ring for outside calls or make sounds when you change the settings. This feature is useful when you do not want to be disturbed, for example, while sleeping.

Listening to recorded messages

When new messages are recorded, the following will be displayed.

新しい用件が
録音されました

Press (Playback) to listen to recorded messages.

After the messages are played back, the following will be displayed.

- To erase the messages, press .
- To save the messages, press .

再生した用件を
消去しますか？
はい=* いいえ=#

Printing received fax documents

When new faxes are received, the following will be displayed.

ファクスが
届いています
印刷は[決定]押す

Press (Set) 2 times to print fax documents.

Turn off the night mode

Press (Night mode) for about 3 seconds.

Call block

Blocking the incoming calls

Using the main unit:

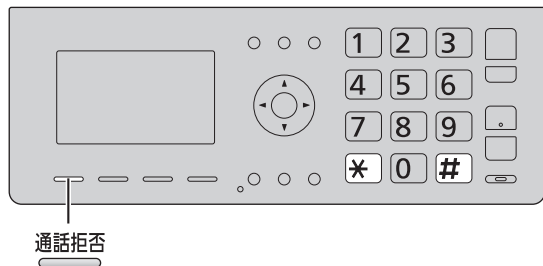

To block a call using a message

While the unit is ringing, press **通話拒否** (Block).

OR

While you are on an incoming call, press **通話拒否** (Block), then press *****.

- The unit announces a message to the caller 2 times, then hangs up automatically. The message is announced in Japanese and means "We're sorry, but your call cannot be connected."

To block a call using chimes

1 While you are on an incoming call, press **通話拒否** (Block).

2 Press **#**.

- Chimes are heard by the caller.

3 Explain to the caller that a visitor came and hang up.

Using the portable handset (KX-FKN516):

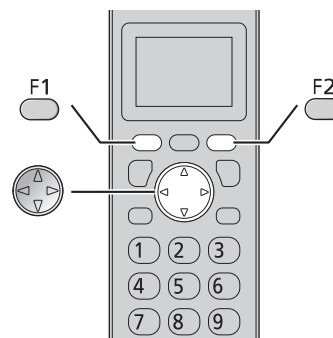

To block a call using a message

While the unit is ringing, press **F1** 2 times.

OR

While you are on an incoming call,

- 1** Press **F1**.
- 2** Press **Search** (Search button) repeatedly until "通話拒否" is displayed.
- 3** Press **F1** 2 times.
 - The unit announces a message to the caller 2 times, then hangs up automatically. The message is announced in Japanese and means "We're sorry, but your call cannot be connected."

To block a call using chimes

1 While you are on an incoming call, press **F1**.

2 Press **Search** (Search button) repeatedly until "通話拒否" is displayed, then press **F1**.

3 Press **Search** (Search button) repeatedly until "チャイム" is displayed, then press **F1**.

4 Explain to the caller that a visitor came and hang up.

For Number Display service subscribers

- If you subscribe to Number Display service, the message heard by the caller will change according to the caller's situation.

Example : If the caller requested not to send caller's information, the message heard by the caller will change to mean "Your phone number is blocked by service provider. Please call again with adding '186' to the beginning of the phone number."

- When the following is displayed after blocking an incoming call, you can set the unit to block the call from the same telephone number.

Using the main unit:

■ To block the call, press *****.

■ To cancel blocking, press **#**.

- When the following is displayed, press **#** to cancel.

迷惑設定
しますか？
はい=* いいえ=#

拒否設定
しますか？
はい=* いいえ=#

Using the portable handset:

■ To block the call, press **F1**.

■ To cancel blocking, press **F2**.

- When the following is displayed, press **F2** to cancel.

迷惑設定
しますか？

拒否設定
しますか？

Specifications

KX-PW508DL KX-PW508DW KX-PW508D	Main unit	Portable handset (KX-FKN516) (for KX-PW508DL/KX-PW508DW only)	Battery charger (for KX-PW508DL/KX-PW508DW only)
Power supply	AC 100 V (50 Hz/60 Hz)	Ni-MH battery (Part no. KX-FAN51) DC 3.6 V, 650 mAh	AC 100 V (50 Hz/60 Hz)
Power consumption	Transmission: Approx. 10 W Reception: Approx. 13 W Copy: Approx. 16 W Stand by: Approx. 0.7 W (When the F-net service is not in use.) Maximum(*1): Approx. 130 W		<ul style="list-style-type: none"> Charging: Approx. 1.2 W Stand by: Approx. 0.5 W (When the portable handset is off the charger.)
Dimensions (H x W x D)	Approx. 86 X 296 X 191 mm (without handset, projections) Approx. 265 X 296 X 231 mm (recording paper tray opened, without handset, projections)	Approx. 171 X 44.5 X 33.5 mm	Approx. 34 X 72.5 X 100.5 mm
Mass (Weight)	Approx. 2.4 kg (10 m ink film installed)	Approx. 157 g (battery installed)	Approx. 160 g
Operating environment	5 °C – 35 °C, 45 % – 85 % RH (Relative Humidity)		

KX-PW508DL / KX-PW508DW KX-PW508D	Main unit
Applicable line	Public Switch Telephone Network (Pulse/Tone), F-Net, NCC Lines
DC resistance	275 Ω
Compatibility	G3 compatible
Document size	A4–A5 (Max. 210 mm in width, Max. 600 mm in length)
Effective scanning size	208 mm (A4)
Effective printing size	202 mm (A4 size plain paper)
Transmission time	Approx. 15 s/page (Original mode) (*2)
Modem speed	9,600 / 7,200 / 4,800 / 2,400 bps; Automatic fallback
Halftone level	64-level
Scanning density	Horizontal: 8 pels/mm Vertical : 7.7 lines/mm (Fine/Photo), 3.85 lines/mm (Standard)
Scanner type	Contact image sensor
Printer type	Thermal transfer printing on plain paper
Data compression system	Modified Huffman (MH), Original mode
Recording paper size	A4: 210 mm x 297 mm (Plain paper)
Answering device	Greeting message: Digital recording system (up to 16 sec) Pre-recording greeting message ICM Recording: Digital recording system (Approx. 12 min. in total) (*3)
Memory capacity	Max. Approx. 50 pages (Only receiving fax etc.) (*4) Max. Approx. 12 min. (Only recording message) (*3)

*1 When copying a 100 % black document.

*2 Transmission speed is based on an A4-size document of 700 characters sent in standard resolution at 9,600 bps. The actual transmission speed depends upon the contents of the page, resolution, telephone line conditions and capability of the other party's machine.

*3 If there is a silent pause, the total recording time will be longer.

*4 The memory capacity is based on an A4-size document of 700 characters sent in standard resolution (8 x 3.85 lines/mm).

Free Manuals Download Website

<http://myh66.com>

<http://usermanuals.us>

<http://www.somanuals.com>

<http://www.4manuals.cc>

<http://www.manual-lib.com>

<http://www.404manual.com>

<http://www.luxmanual.com>

<http://aubethermostatmanual.com>

Golf course search by state

<http://golfingnear.com>

Email search by domain

<http://emailbydomain.com>

Auto manuals search

<http://auto.somanuals.com>

TV manuals search

<http://tv.somanuals.com>