

Quick Set-Up Guide

Please read the Operating Instructions for further details.

Step 1

Setting Up the Base Unit

Fasten the AC adaptor cord to prevent it from being disconnected.

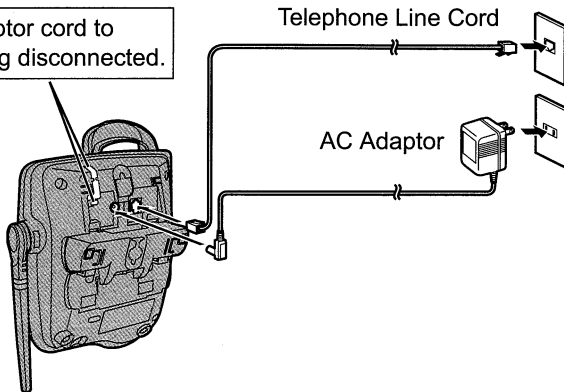

- USE ONLY WITH Panasonic AC ADAPTOR PQLV1.
- Use only the telephone line cord included in the unit.
- Make sure that the AC adaptor and telephone line cords are plugged into the unit properly.

Step 2

Setting Up the Handset

Install the battery.

Insert the battery (①), and press it down until it snaps into the compartment (②). Close the cover.

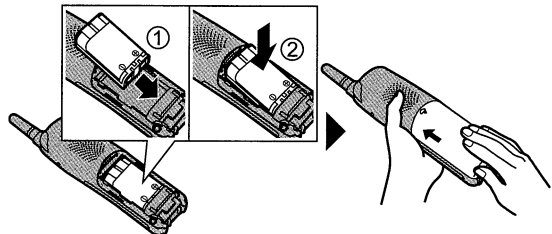

Charge the battery for 6 hours before initial use.

- The unit beeps once and the CHARGE indicator lights.

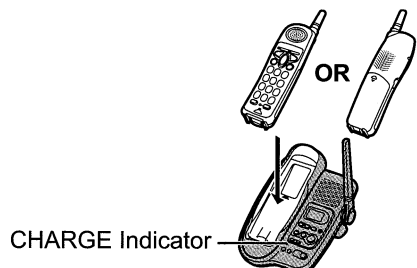

Step 3

Setting Time and Day



- 1 Press **[VOICE ENHANCER]**.
 - 2 Press **[0]**.
 - 3 Enter 4 digits for the time (hour and minute).
(Ex. To set 9:30, enter "0930".)
 - 4 Select AM or PM by pressing **[*]**.
 - 5 Select the day by pressing **[#]**.
 - 6 Press **[VOICE ENHANCER]**.
- To confirm the time and day, press **[VOICE ENHANCER]** then **[0]**.
The current day and time are announced. When finished, press **[OFF]**.

Step 4

Recording Your Own Greeting (Optional)

You can record a personal greeting message of **up to 2 minutes**. If you do not record your own message, a pre-recorded greeting will be played for callers.

For details, see pages 16–17 in the Operating Instructions.

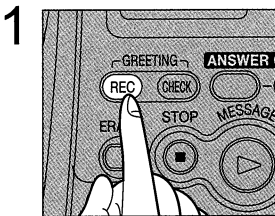

Press **[GREETING REC]** twice.

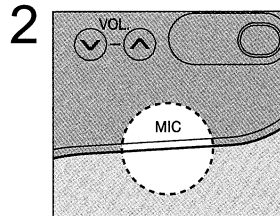

After the long beep, talk into the **MIC**.

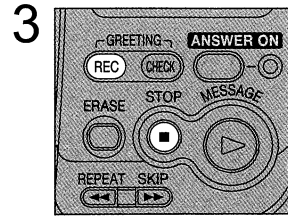

When finished, press **[GREETING REC]** or **[STOP]**.

In order to use **Call Waiting**, you must first subscribe to the service. For more information, contact your telephone company.

If you subscribe to a flat rate bundle service including Caller ID, Call Waiting, Voice Mail and unlimited local/regional/long distance calls, please read the following.

- a) To use the Voice Mail service provided by the telephone company rather than the unit's Answering System, please turn off the Answering System by pressing **[ANSWER ON]** on the base unit.
- This unit does not have an indicator to indicate if there are new messages in your mailbox service.
- b) To keep using the Answering System rather than the Voice Mail service provided by your telephone company, please contact your telephone company to deactivate the Voice Mail service in your bundle service. If the telephone company cannot do that, please set the number of rings so that the telephone answering system can answer calls prior to Voice Mail service. It is necessary to check the "Number of Rings" required to activate the Voice Mail service provided by your telephone company before changing this setting.

As an example to set Number of Rings to "2":

Press [VOICE ENHANCER] [2] [2] [VOICE ENHANCER].

(Refer to page 18 in the Operating Instructions, if you need to set to the different number.)

Location of Controls

Base unit

[GREETING CHECK]

Press to check the greeting message.

[GREETING REC]

(Record)
Press twice to record a greeting message.

[ERASE]

-Individual message:
Press during playback.
-All messages:
Press twice.
-Greeting:
Press after pressing
[GREETING CHECK].

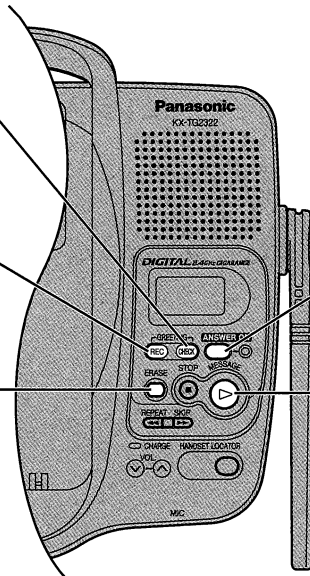

[ANSWER ON]

Press to turn on/off the Answering System.

[MESSAGE]

Press to playback messages.

Handset

[TALK]

Press to make/answer calls.

[SP-PHONE]

Press to turn on, to begin a hands-free phone conversation.

[FLASH/CALL WAIT]

Press to answer another incoming call.

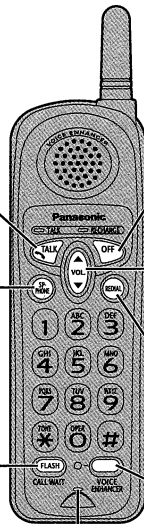

Microphone

[OFF]

Press to end calls or exit programming.

VOL. (VOLUME) Key

Press [▲] to increase or press [▼] to decrease the ringer and receiver/speaker volumes.

[REDIAL]

Press to redial.

[VOICE ENHANCER]

Press to clarify the voice of the person you are talking to, or press to enter programming mode.

Listening to Messages

a) Playing Back New Message

When the NEW MESSAGE indicator **FLASHES** on the base unit, press **[MESSAGE]**.

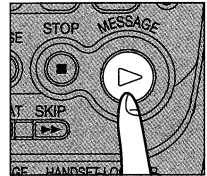

b) Playing Back Old Message

When the NEW MESSAGE indicator **DOES NOT FLASH**, press **[MESSAGE]**.

Other Operation and Information

For information on other functions, refer to the following pages in the Operating Instructions.

Adjusting Receiver/Speaker Volume	p. 20
Selecting Ringer Tone	p. 15
Answering System	p. 16, 24
Changing Number of Rings	p. 18
Remote Operation from a Touch Tone Phone	p. 28
Call Monitoring	p. 25
Voice Enhancer	p. 20

IMPORTANT!

If your product is not working properly. . .

1. Read this **Quick Set-Up Guide** or **Operating Instructions**
2. Visit our website: **<http://www.panasonic.com/support>**
3. Contact us via the web at: **<http://www.panasonic.com/contactinfo>**
4. Call us at: **1-800-211-PANA(7262)**

To order battery, 1-800-332-5368

<http://www.panasonic.com/batterystore>

Panasonic®

2.4GHz Digital Cordless Answering System

Operating Instructions

Model No. **KX-TG2322**

Pulse-or-tone dialing capability



PLEASE READ BEFORE USE AND SAVE.

Charge the battery for 6 hours before initial use.

**Panasonic World Wide Web address: <http://www.panasonic.com>
for customers in the USA or Puerto Rico**

Thank you for purchasing your new Panasonic cordless telephone.

Please read the IMPORTANT SAFETY INSTRUCTIONS on page 37 before use. Read and understand all instructions.

Attach your purchase receipt here.

Accessories (included)

For extra orders, call 1-800-332-5368.

For hearing or speech impaired TTY users, call 1-866-605-1277.

- AC Adaptor (p. 9)
Order No. PQLV1Z (PQLV1)

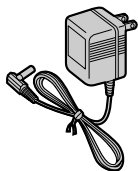

one

- Telephone Line Cord (p. 9)
Order No. PQJA10075Z



one

- Battery (p. 10)
Order No. HHR-P104

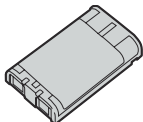

one

- Handset Cover (p. 10)
Order No. PQKK10140Z2

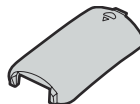

one

- Belt Clip (p. 32)
Order No. PQKE10375Z2



one

- Shoulder Rest Attachment (p. 32)
Order No. PQKE10364Z1



one

For Best Performance

Battery Charge

The handset is powered by a rechargeable Nickel-Metal Hydride (Ni-MH) battery. Charge the battery for **6 hours** before initial use (p. 10).



Base Unit Location/Noise

Calls are transmitted between the base unit and handset using wireless radio waves. **For maximum distance and noise-free operation**, the recommended base unit location is:

Away from electrical appliances such as a TV, personal computer or another cordless phone.

In a **HIGH** and **CENTRAL** location with no obstructions such as walls.

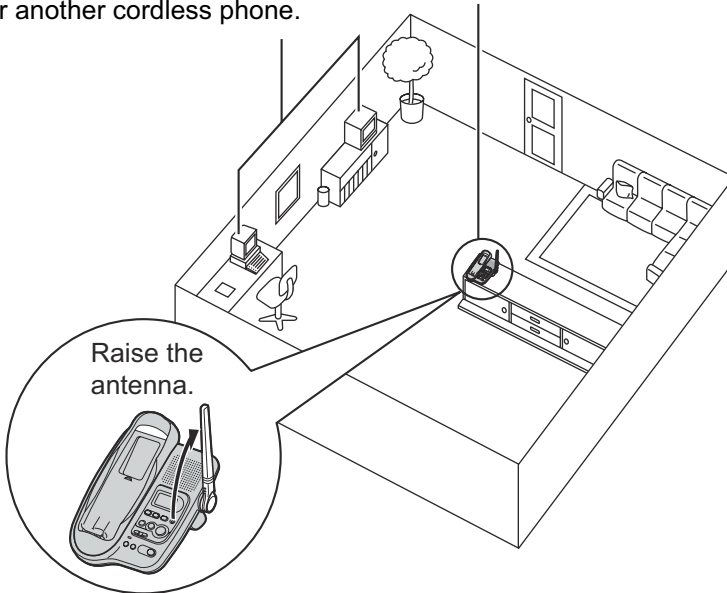

Note:

- If you use the handset near a microwave oven which is being used, noise may be heard from the receiver or the speaker. Move away from the microwave oven and closer to the base unit.
- If you use the handset near another cordless phone's base unit, noise may be heard. Move away from the other cordless phone's base unit and closer to your base unit.

Contents

Preparation

Location of Controls	6
Installation	9
Connections	9
Installing the Battery in the Handset	10
Battery Charge	10
Programmable Settings	12
Programmable Functions	12
Time and Day	13
Dialing Mode	14
Ringer Volume	14
Ringer Tone	15
Preparing the Answering System	16
Greeting Message	16
Number of Rings	18
Remote Code	18

Telephone System

Making Calls	19
Answering Calls	21
Special Features	22
Handset Locator	22
Temporary Tone Dialing (For Rotary or Pulse Service Users) ...	22
For Call Waiting Service Users	22
FLASH Button	22
Re-registering the Handset	23

Answering System

Automatic Answering Operation	24
Setting the Unit to Answer Calls	24
Monitoring Incoming Calls	25
Listening to Messages	26
Erasing Messages	27
Remote Operation from a Touch Tone Phone	28
Voice Menu	29
Direct Remote Operation	30

Useful Information

Wall Mounting	31
Belt Clip	32
Shoulder Rest Attachment	32
Optional Headset	33
Troubleshooting	34
Important Safety Instructions	37
FCC and Other Information	39
Index	42
Warranty	43
Specifications	45

Important:

Throughout these Operating Instructions, **Handset** and **Base Unit** are used to indicate with which unit an operation can be performed.

Handset : Perform with the handset.

Base Unit : Perform with the base unit.

Handset & Base Unit : Perform with the handset and base unit together.

Location of Controls

Handset

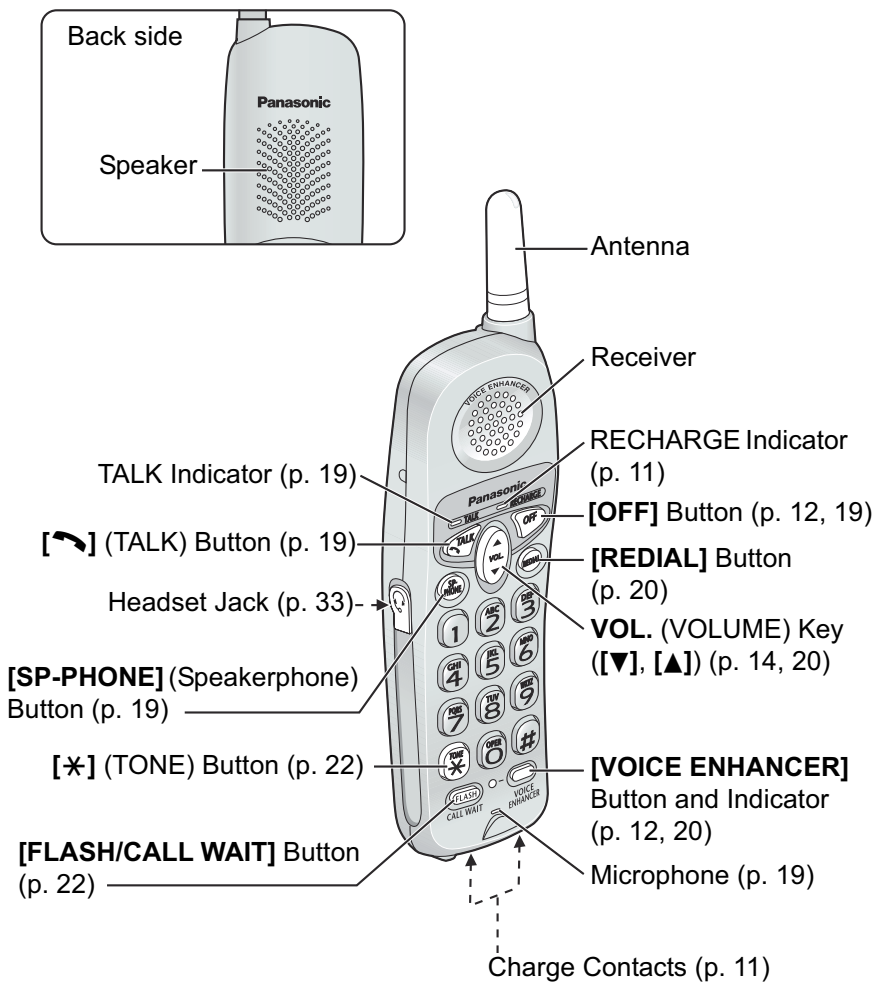

Location of Controls

Base unit

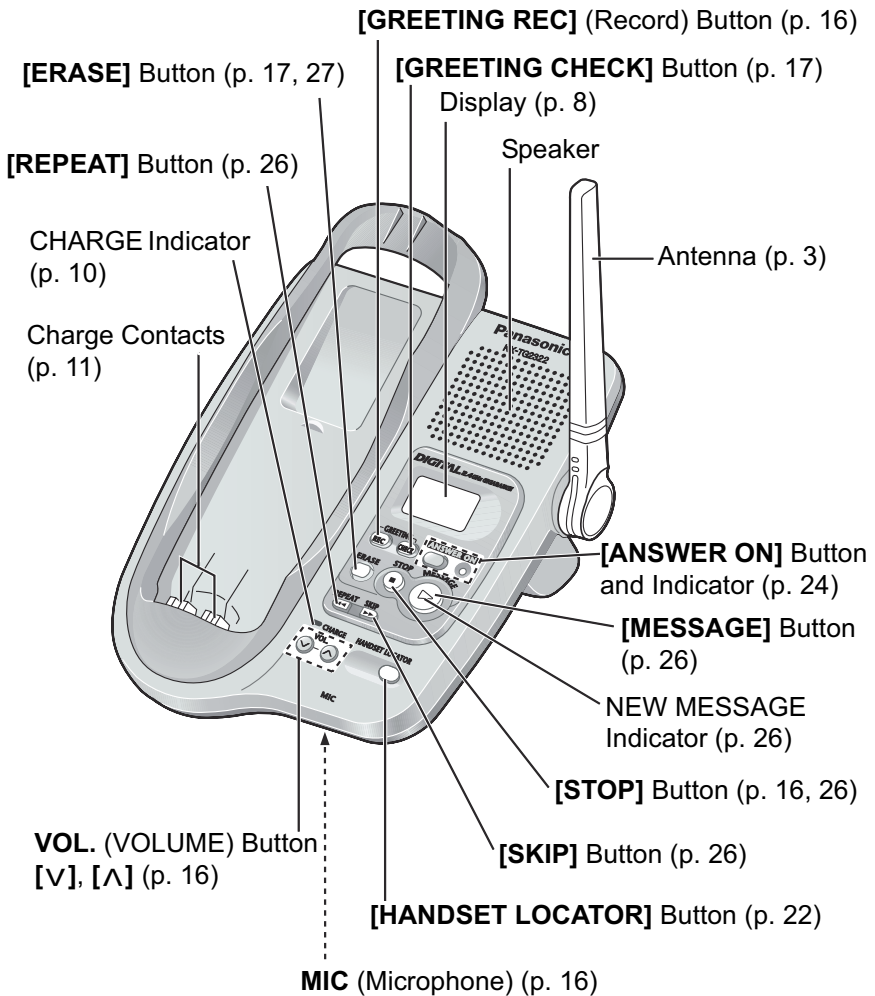

Location of Controls

Base unit display

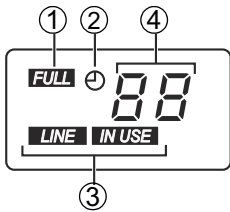

- ① “**FULL**” flashes when no new messages can be recorded. Erase unnecessary messages (p. 27).
- ② “⌚” flashes until you set the time and day, and flashes after a power failure. If it is flashing, set the time and day (p. 13).

③ “**LINE IN USE**” functions as follows.

Off (invisible)	The line is free.
On	The line is being used.
Flashing	Answering System is answering a call (p. 24).
Flashing rapidly	A call is being received.

- ④ Message counter shows:
 - the total number of recorded messages (p. 26).
 - the selected volume level while you are adjusting the speaker volume (p. 16).
 - “E” when your greeting message was not recorded correctly (p. 16).
 - “P” during programming (p. 12).
 - “P” when [0] is pressed for Toll Saver mode when selecting the number of rings (p. 18).

Installation

Connections

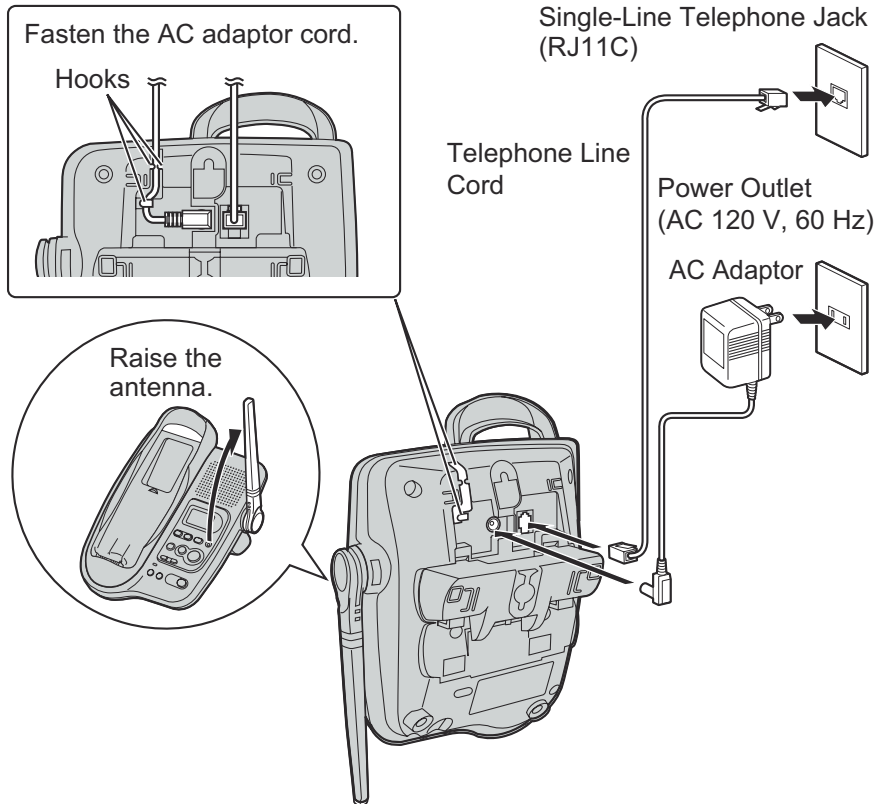

- USE ONLY WITH Panasonic AC ADAPTOR PQLV1 (Order No. PQLV1Z).
- The AC adaptor must remain connected at all times. (It is normal for the adaptor to feel warm during use.)
- The unit will not work during a power failure. We recommend connecting a standard telephone to the same telephone line or to the same telephone jack using the Panasonic KX-J66 T-adaptor.

Installation

Installing the Battery in the Handset

Insert the battery (①), and press it down until it snaps into the compartment (②). Close the cover.

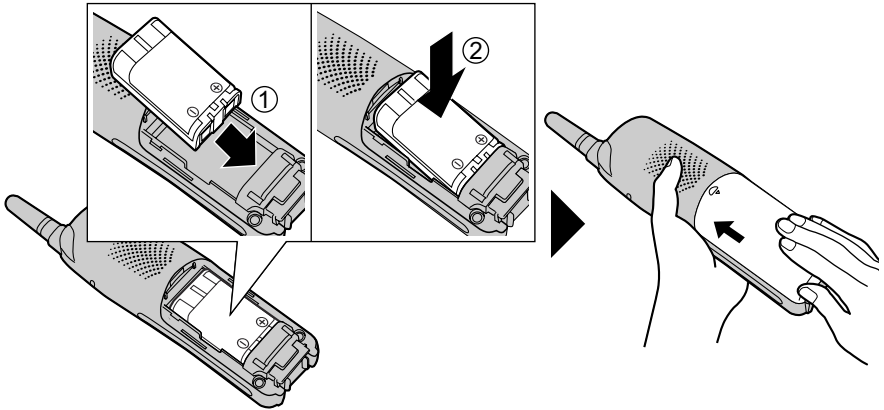

To replace the battery:

Press the notch on the cover firmly and slide it as indicated by the arrow. Replace the old battery with a new one (p. 11). Close the cover and charge the battery for 6 hours.

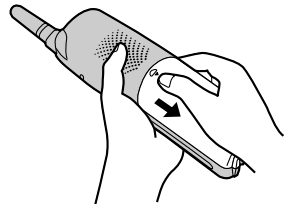

Battery Charge

Place the handset on the base unit. Charge for **6 hours** before initial use.

- The unit beeps once and the CHARGE indicator lights.

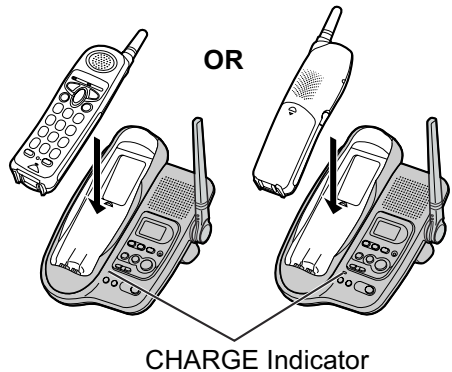

Recharge

Recharge the battery when:

- the RECHARGE indicator flashes, or
- the handset beeps intermittently while it is in use.
- The RECHARGE indicator will flash when the handset battery is charged less than 15 minutes and the handset is lifted off the base unit.

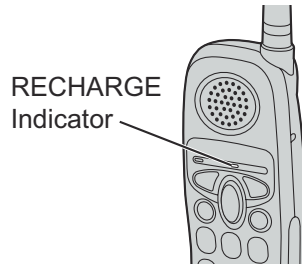

Battery replacement:

If you cleaned the charge contacts and fully charged the battery, but after a few telephone calls, the RECHARGE indicator flashes, the battery may need to be replaced. Please order a new Panasonic HHR-P104 battery at the telephone number shown on page 2. To replace the battery, see page 10.

A nickel metal hydride battery that is recyclable powers the product you have purchased. Please call 1-800-8-BATTERY for information on how to recycle this battery.



Battery information

After your Panasonic battery is fully charged, you can expect the following performance:

Operation	Operating time
While in use (TALK)	Up to 5 hours
While not in use (Standby)	Up to 11 days

- A fully charged battery will give you up to 5 hours of continuous talk time, or keep your handset in standby mode to receive incoming calls for up to 11 days (if no phone calls are made). Battery power is consumed whenever the handset is off of the base unit, even when the handset is not in use. The longer you leave the handset off of the base unit, the time you can actually talk on the handset will be shortened. Actual battery performance depends on a combination of how often the handset is in TALK mode and how often it is in Standby mode.
- If the battery is fully charged, you do not have to place the handset on the base unit until the RECHARGE indicator flashes. This will maximize the battery life.
- If you want to keep the battery fully charged at all times, place the handset on the base unit when the handset is not used. The battery cannot be overcharged.
- **Clean the charge contacts of the handset and the base unit with a soft, dry cloth once a month. Clean more often if the unit is subject to grease, dust or high humidity.** Otherwise the battery may not charge properly.

Programmable Settings

Programmable Functions **Handset**

You can use the following functions to customize your unit. See the corresponding pages for function details.

Make sure the handset and base unit are not being used. The handset must be operated near the base unit and while off the base unit.

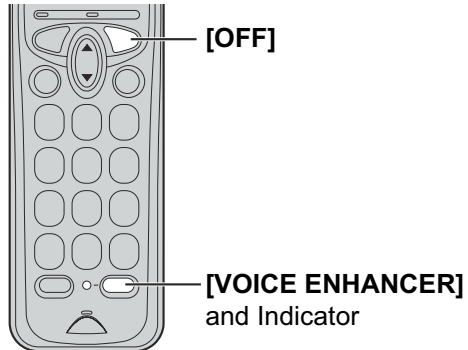

Lift the handset, then press **[VOICE ENHANCER]**.

- The indicator flashes.
- “P” is displayed on the base unit.

To set **the time and day**, press **[0]**. (See page 13.)

To set **the remote code**, press **[1]**. (See page 18.)

To select **the number of rings**, press **[2]**. (See page 18.)

To select **the dialing mode**, press **[8]**. (See page 14.)

- The display shows numbers or characters related to adjustments or settings.

Press **[VOICE ENHANCER]**.

- A confirmation tone will be heard and the setting will be saved.
- The indicator light goes out.

- If an alarm tone sounds during programming, walk closer to the base unit and start again from the beginning.
- You can exit programming mode at any time by pressing **[OFF]**.
- If you do not press any buttons for 60 seconds, the handset will exit programming mode.

Programmable Settings

Time and Day **Handset**

We recommend you set the time and day so that the unit will announce the day and time each message was recorded when you play back messages.

- 1** Press **[VOICE ENHANCER]**.
 - The indicator flashes.
- 2** Press **[0]**.
 - “Set time” is announced. If previously set, the day and time will be announced.
- 3** Enter 4 digits for the time (hour and minute). (Ex. To set 9:30, enter “0930”.)
- 4** Set the AM or PM by pressing **[*]**.
 - Each time you press **[*]**, “AM” or “PM” will be announced.
- 5** Set the day by pressing **[#]**.
 - Each time you press **[#]**, the selected day will be announced.
- 6** Press **[VOICE ENHANCER]**.
 - The unit announces the day and time, the clock is set and “⊖” disappears from the base unit display.
 - The handset beeps and the indicator light goes out.
 - If the handset beeps 3 times, the time was not set correctly. Start again from step 1.

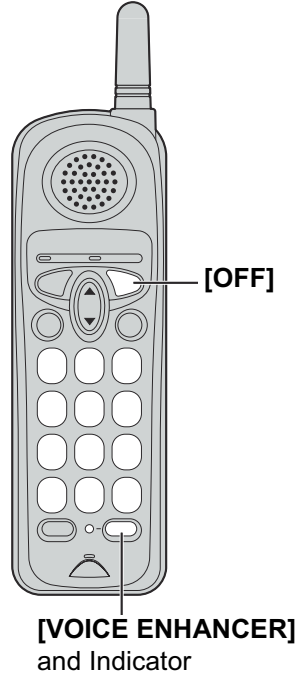

- When entering the time in step 3, you cannot enter numbers greater than 12. **Do not use military time.** (To set 13:00 hours, enter “0100”, then select PM in step 4.)

The time and day may be incorrect after a power failure. When “⊖” flashes on the display, set the time and day again.

- To confirm the time and day, press [VOICE ENHANCER] then [0].**
- The current day and time are announced. When finished, press **[OFF]**.

Programmable Settings

Dialing Mode **Handset**

If you have touch tone service, set the dialing mode to “Tone”. For rotary or pulse service, set to “Pulse”. The factory preset is “Tone”.

1 Press **[VOICE ENHANCER]**.

- The indicator flashes.

2 Press **[8]**.

- The current setting is displayed on the base unit.
1: Pulse 2: Tone

3 To select “Pulse”, press **[1]**.

To select “Tone”, press **[2]**.

4 Press **[VOICE ENHANCER]**.

- The handset beeps and the indicator light goes out.
-

Ringer Volume **Handset**

You can set the handset ringer volume to high, medium, low, or off.

The factory preset is HIGH. If the handset ringer is turned off, the handset will not ring.

To set the ringer volume to high (preset), medium or low, press **[▼]** or **[▲]**.

- To increase volume, press **[▲]**. To decrease volume, press **[▼]**.
- To stop ringing, press **[OFF]** or **[VOICE ENHANCER]**.

To turn the ringer off, press and hold **[▼]** until 2 beeps sound.

To turn the ringer on, press **[▼]** or **[▲]**.

- The handset will ring at the low level.

- You can adjust the ringer volume while a call is ringing. Press **[▼]** or **[▲]** while the handset is ringing. To turn the ringer off, press and hold **[▼]** until 2 beeps sound.

Temporary ringer off

While the handset is ringing for an outside call, you can turn the ringer off temporarily by pressing **[OFF]**. The handset will ring again as normal the next time a call is received.

Ringer Tone **Handset**

You can select the handset ringer to use one of 7 ringer patterns. There are 3 bell ringer patterns and 4 melody patterns available. The factory preset is "Bell ringer pattern 1".

- If you subscribe to a Distinctive Ring Service (such as IDENTA-RING) from your telephone company with 2 or 3 consecutive rings, select a bell ringer pattern (1 to 3). If you select a melody pattern, you will not be able to distinguish lines by their ringers.
- If you select one of the melody ringer patterns, the ringer will continue to sound for several seconds if:
 - the caller hangs up before you answer the call, or
 - another person answers the call using another phone connected on the same line.

Press **[▼]** or **[▲]**, then select the desired tone by pressing **[1]** to **[7]**.

[1] to **[3]**: Bell ringer patterns **[4]** to **[7]**: Melody patterns

- After pressing **[▼]** or **[▲]**, the handset will ring using the current ringer tone.
- The handset will ring and the ringer tone will change.
- To stop ringing, press **[OFF]** or **[VOICE ENHANCER]**.

Preparing the Answering System

Greeting Message **Base Unit**

You can record a personal greeting message of **up to 2 minutes**. If you do not record your own message, a pre-recorded greeting will be played for callers (p. 17).

The total recording time of all messages (greeting and incoming) is **about 15 minutes**.

We recommend you record a **brief greeting message** in order to leave more time for recording new messages.

To record a greeting message

Sample greeting message

“Hello, this is (your name and/or number). Sorry, I cannot take your call. Please leave a message after the beep. Thank you.”

1 Press **[GREETING REC]**.

- “To record greeting, press RECORD again” is heard.

2 Within 10 seconds, press **[GREETING REC]** again to record your greeting.

3 After the long beep, talk clearly, about 20 cm (8 inches) away from the **MIC** (microphone).

- The elapsed recording time is displayed.
- If you record for over 2 minutes, the unit will stop recording.

4 When finished, press **[GREETING REC]** or **[STOP]**.

- To change the greeting, start again from step 1.

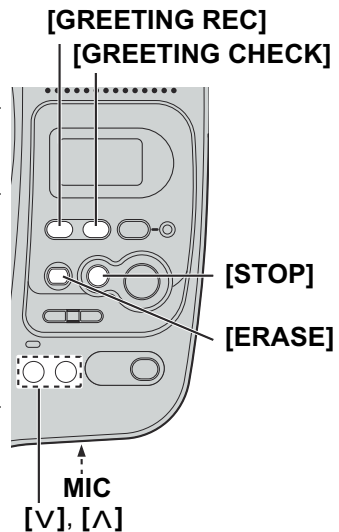

- If “E” is displayed, 6 beeps sound and “Your greeting was not recorded. Record your greeting again.” is announced, start again from step 1.

To adjust the speaker volume, press **[V]** or **[Λ]** during playback.

- 9 levels (0–8) are available while using the Answering System. The level is displayed on the base unit.

Preparing the Answering System

To review the greeting

Press [**REETING CHECK**].

To erase the greeting

Press [**REETING CHECK**], then press [**ERASE**] while the recorded message is being played.

- The unit will answer calls with a pre-recorded greeting (see below).

Pre-recorded greeting

If you do not record a greeting (p. 16), a pre-recorded greeting will be played when a call is received.

To review the pre-recorded greeting, press [**REETING CHECK**].

- A pre-recorded greeting will be played as follows:

“Hello, we are not available now. Please leave your name and phone number after the beep. We will return your call.”

- If recording time runs out, the unit will automatically announce:

“Hello, we are not available now. Please call again. Thank you for your call.” Then the unit hangs up. The unit will not record any incoming messages.

Flash Memory Message Backup (Message storage)

Messages stored in memory will not be affected by power failures. All messages are saved until you erase them.

Preparing the Answering System

Number of Rings **Handset**

You can select the number of times the unit rings before the Answering System answers a call, from “2” to “7” or “Toll saver”*. The factory preset is “4”.

- 1** Press **[VOICE ENHANCER]**.
 - The indicator flashes.
- 2** Press **[2]**.
 - The current setting is displayed on the base unit.
- 3** Select the number of rings by pressing **[0]** (Toll saver*), or **[2]** to **[7]**.
 - If **[0]** (Toll saver) is pressed, “R” is displayed.
- 4** Press **[VOICE ENHANCER]**.
 - The handset beeps and the indicator light goes out.

***Toll saver**

When you call the unit from a remote operation, the number of rings will tell you if there are any new messages. If the unit answers on the 2nd ring, there is at least one new message. If the unit answers on the 4th ring, there are no new messages. To save the toll charges for the call, hang up immediately when you hear the 3rd ring. The 3rd ring indicates that there are no new messages.

Remote Code **Handset**

The remote code prevents unauthorized people from accessing your unit and listening to your messages from any touch tone phone (see “Remote Operation from a Touch Tone Phone” on page 28).

Choose any **2-digit number (00–99)** for your remote code.

The factory preset remote code is “11”. If you do not program your own remote code, you can use “11”.

- 1** Press **[VOICE ENHANCER]**.
 - The indicator flashes.
- 2** Press **[1]**.
 - The current remote code is displayed on the base unit.
- 3** Enter a **2-digit remote code (00–99)**.
- 4** Press **[VOICE ENHANCER]**.
 - The handset beeps and the indicator light goes out.

To confirm the remote code, repeat steps 1 and 2.

- The remote code is displayed. When finished, press **[OFF]**.

Making Calls

Handset

- 1 Press [**📞**].
 - The TALK indicator lights.
- 2 Dial a phone number.
- 3 To hang up, press [**OFF**] or place the handset on the base unit.
 - The indicator light goes out.

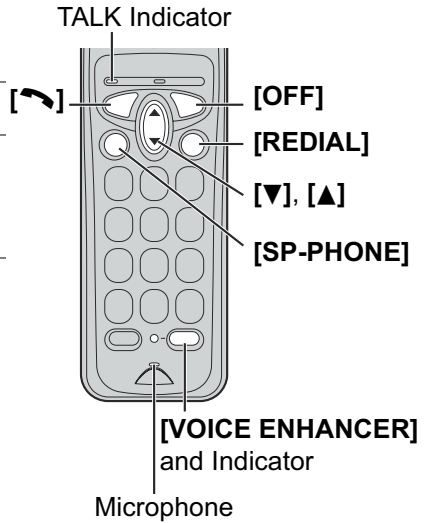

To have a hands-free phone conversation

- 1 Press [**SP-PHONE**].
 - The TALK indicator lights.
- 2 Dial a phone number.
- 3 When the other party answers, talk into the microphone.
- 4 To hang up, press [**OFF**] or place the handset on the base unit.
 - The indicator light goes out.

Hands-free Digital Duplex Speakerphone

For best performance, please note the following:

- Talk alternately with the other party in a quiet room.
- If you or the other party has difficulty hearing, press [**▼**] to decrease the speaker volume.
- While talking using [**📞**], you can switch to a hands-free phone conversation by pressing [**SP-PHONE**]. To switch back to the receiver, press [**📞**].

Making Calls

To redial the last number dialed

Press [**↶**] or [**SP-PHONE**], then press [**REDIAL**].

To adjust the receiver/speaker volume during a conversation

There are 3 volume levels for the receiver and 6 volume levels for the speaker.

To increase volume, press [**▲**].

To decrease volume, press [**▼**].

- If you try to increase/decrease volume when it is at the maximum/minimum level, the handset will beep 3 times.

Voice Enhancer Technology

Panasonic's Voice Enhancer Technology clarifies the voice of the person you are talking to, reproducing a more natural-sounding voice that is easier to hear and understand.

Voice Enhancer Technology can be turned on or off. The factory preset is OFF.

- Depending on the condition and quality of your telephone line, Voice Enhancer may emphasize existing line noise. If it becomes difficult to hear the caller, turn this feature off.

To turn this feature on, press [**VOICE ENHANCER**] during a conversation.

- The indicator lights in talk or speakerphone mode.
- The indicator light goes out after hanging up a call, but this feature still remains on.
- **To turn this feature off**, press [**VOICE ENHANCER**] again. The indicator light goes out.

Lighted handset keypad

The handset dialing buttons will light for a few seconds after pressing a button or lifting the handset off the base unit.

Answering Calls

Handset

When a call is received, the handset rings, and the TALK indicator on the handset and “**LINE IN USE**” on the base unit flash rapidly.

1 If the handset is off the base unit, press [**⏪**] or [**SP-PHONE**].

- You can also answer a call by pressing any button except [**▼**], [**▲**] or [**OFF**].

OR

If the handset is on the base unit, just lift up.

2 To hang up, press [**OFF**] or place the handset on the base unit.

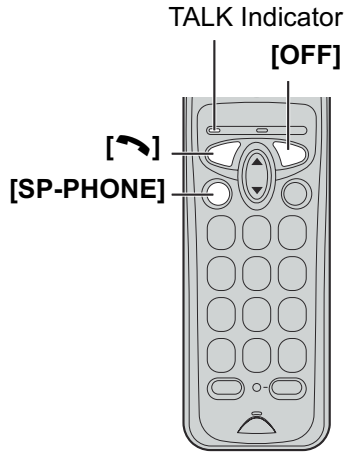

- If the ringer volume is turned off, the handset will not ring (p. 14).

Temporary ringer off

While the handset is ringing for an outside call, you can turn the ringer off temporarily by pressing [**OFF**]. The handset will ring again as normal the next time a call is received.

Special Features

Handset Locator **Base Unit**

You can locate the handset or page the handset user with beep tones from the base unit.

1 Press **[HANDSET LOCATOR]**.

- The TALK indicator on the handset and “**IN USE**” on the base unit flash rapidly and the handset beeps for 1 minute.
-

2 To stop paging, press **[HANDSET LOCATOR]** again.

OR

Press **[OFF]** on the handset.

- You can also stop paging by pressing any button except **[▼]** or **[▲]**.
-

Temporary Tone Dialing

(For Rotary or Pulse Service Users) **Handset**

Press **[*]** (TONE) before entering access numbers which require tone dialing.

- The dialing mode changes to tone. You can enter numbers to access an answering service, electronic banking service, etc. When you hang up, the dialing mode will return to pulse.

For Call Waiting Service Users **Handset**

Press **[FLASH/CALL WAIT]** if you hear a call waiting tone during a conversation.

- The first call is put on hold and you can answer the second call.
- To return to the first caller, press **[FLASH/CALL WAIT]** again.
- Call Waiting service cannot be used when the Answering System is handling a call.
- If this function does not operate properly, consult your telephone company for details.

FLASH Button **Handset**

Pressing **[FLASH/CALL WAIT]** allows you to use special features of your host PBX such as transferring an extension call, or accessing optional telephone services such as call waiting.

- Pressing **[FLASH/CALL WAIT]** cancels Temporary Tone Dialing mode.

Re-registering the Handset **Handset & Base Unit**

If an alarm tone sounds when you press [**↶**], [**SP-PHONE**] or [**VOICE ENHANCER**] even when using the handset near the base unit, the handset may have lost communication with the base unit. You need to re-register the handset to the base unit.

- **Make sure the base unit is not being used.**
- **Have both the handset and base unit nearby during registration.**
- **Follow steps 1 and 2 listed below. You have about 1 minute to complete them.**

1 *Base unit:*

Press and hold [**HANDSET LOCATOR**].

- The CHARGE indicator flashes.

2 *Handset:*

Press and hold [**FLASH/CALL WAIT**] until a beep sound.

- The VOICE ENHANCER indicator flashes.
- When registration is complete, a beep sounds from the handset and the indicator lights go out.
- **Wait for 20 seconds after registration is complete while the handset establishes communication with the base unit.**

-
- If the handset beeps 3 times in step 2, an error occurred. Try again from step 1.
 - You can stop registration by pressing [**OFF**] on the handset, and pressing [**HANDSET LOCATOR**] on the base unit.

Automatic Answering Operation

When the unit answers a call, a greeting message is played and the caller's message is recorded.

- The total recording time (including greeting message) is **about 15 minutes**. If messages are recorded in noisy rooms, the time may be shortened by up to 3 minutes.
- Each caller's recording time is up to 3 minutes.
- A maximum of 64 messages (including greeting message) can be recorded.

Setting the Unit to Answer Calls **Base Unit**

Press **[ANSWER ON]** to turn on the Answering System.

- The indicator lights and the unit announces "Answer set" and current day and time. If "Answer set. Set time" is heard, set the time and day (p. 13).
- The unit will announce the remaining recording time if it is less than 3 minutes.
- When no recording time is available, you will need to erase any unnecessary messages before new messages can be recorded (p. 27). The unit can indicate that memory is full in the following ways:
 - "**FULL**" will flash on the base unit and the ANSWER ON indicator will flash rapidly until you erase a message.
 - The unit will announce "Memory full" when you press **[ANSWER ON]** or **[GREETING REC]**, and after playing back messages or recording a message.
- If you do not want the unit to answer calls, press **[ANSWER ON]** again to turn off the Answering System. The indicator light goes out and "Answer off" is heard.
- You can also turn on the Answering System remotely from an outside phone (p. 30).

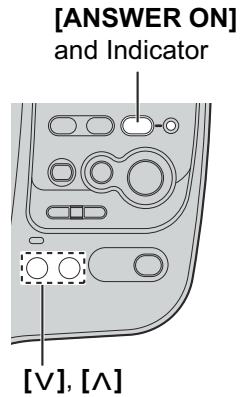

Automatic Answering Operation

Monitoring Incoming Calls **Base Unit**

While a caller is leaving a message, you can monitor the call through the base unit speaker.

- To increase the speaker volume while monitoring, press [**^**]. To decrease volume, press [**v**].

To answer a call while monitoring, lift the handset off the base unit, or press [**↶**] or [**SP-PHONE**] if the handset is off the base unit.

To turn the incoming call monitoring feature off

When the base unit is not in use, press [**GREETING CHECK**], then press [**v**] repeatedly until "0" is displayed. (Make sure the Answering System is turned on.)

OR

While monitoring, press [**v**] repeatedly until "0" is displayed.

- If the incoming call monitoring feature is turned off, it will remain off when the next call is monitored.
- If you adjust the speaker volume while playing back messages, the speaker volume for monitoring will be turned on again. To turn the speaker volume off, see "To turn the incoming call monitoring feature off" of above step.

Listening to Messages

You can see the total number of recorded messages on the base unit display. If the NEW MESSAGE indicator flashes on the base unit, new messages have been recorded.

Voice Day/Time Stamp: During playback, the unit will announce the day and time when each message was recorded (p. 13).

To play back messages **Base Unit**

Press **[MESSAGE]**.

- The unit announces the number of new messages and only new messages are played back.
- When you have no new messages, the unit announces “No new messages. All message playback” and plays back all messages.
- When you have no messages, the unit announces “No messages”.
- During playback, the display shows the message number.
- At the end of the last message, “End of final message” is heard. The unit will announce the remaining recording time if it is less than 3 minutes.
- If a call is received during playback, the handset rings and playback stops. To answer the call, lift the handset, or press **[]** or **[SP-PHONE]** if the handset is off the base unit. For playback, start again from the beginning after hanging up.

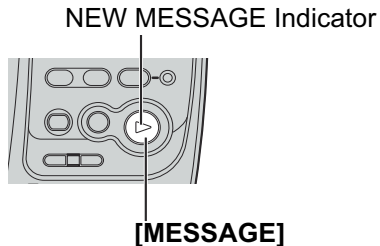

During playback **Base Unit**

To adjust the speaker volume	To increase volume, press [^] . To decrease volume, press [v] .
To repeat a message	Press [REPEAT] . • If pressed within the first 5 seconds of playback, the previous message will be played.
To skip a message	Press [SKIP] .
To stop playback	Press [STOP] . • To resume playback, press [MESSAGE] . • If you do not press any button for 60 seconds or if you press [STOP] again, playback mode will be canceled.

Erasing Messages

Base Unit

The unit will announce the remaining recording time after playback if it is less than 3 minutes.

New messages cannot be recorded when:

- “Memory full” is heard.
- “**FULL**” flashes on the base unit.
- the ANSWER ON indicator flashes rapidly (when the Answering System is on).

Erase unnecessary messages. We recommend you erase unnecessary messages after each playback.

Erasing a specific message

Press **[ERASE]** while the message you want to erase is being played.

- The unit beeps, then plays back the next message. To exit playback mode, press **[STOP]** twice.

Erasing all messages

All recorded messages, except the greeting message, can be erased at one time.

- 1 Press **[ERASE]** while the base unit is not being used.
 - “To erase all messages, press ERASE again” is heard.
- 2 Within 10 seconds, press **[ERASE]** again.
 - The unit beeps, then announces “No messages”.
 - The base unit display shows “0”.

ANSWER ON Indicator

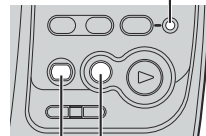

[STOP]

[ERASE]

Remote Operation from a Touch Tone Phone

While outside, you can operate the Answering System from any touch tone phone.

A synthesized voice menu will guide you through the Answering System (p. 29).

- To skip the voice menu and operate the unit directly, see page 30.

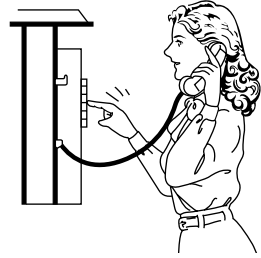

Summary of remote operation

Call your unit from a touch tone phone.



Enter your remote code (factory preset: 11, see “Remote Code” on page 18) during or after the greeting message.

- The number of new messages is heard, and the new messages will be played.*



After 3 seconds, the voice menu will start (p. 29).
Follow the menu or enter direct commands (p. 30).



To end remote operation, hang up.

- The unit will announce the remaining recording time after playback if it is less than 3 minutes.
- The messages are saved.

*If “No new messages” is announced, the unit has only old messages.
If “No messages” is announced, the unit has no messages.

Remote Operation from a Touch Tone Phone

Voice Menu

The shaded parts are voice prompts.

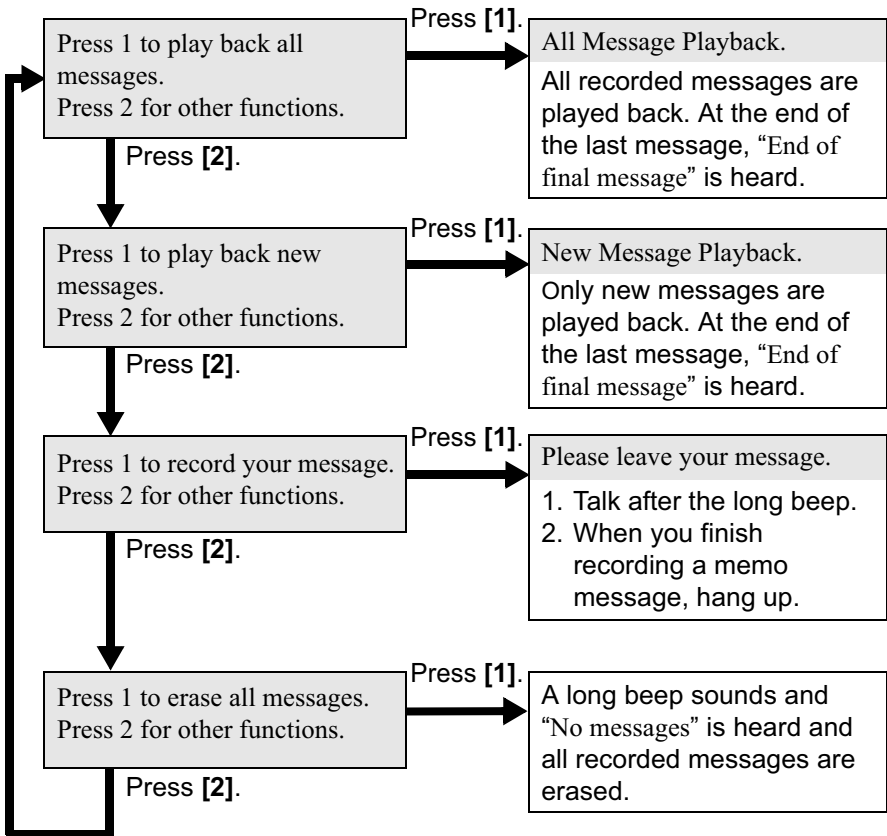

- 3 seconds after playback, the voice menu will start again from the beginning.
- The unit will announce the remaining recording time after playback if it is less than 3 minutes.
- If you hear "Memory full" after playback, erase unnecessary messages (p. 30).
- If you do not press any buttons within 10 seconds after a voice prompt, "Thank you for your call." will be heard and the call will be disconnected.

Remote Operation from a Touch Tone Phone

Direct Remote Operation

Once you have entered the remote code, you can also control your unit by direct commands instead of using the voice menu. To end remote operation, hang up at anytime.

Direct commands

[4] :	Plays back new messages.	[*] [4] :	Erases the current message. <ul style="list-style-type: none">• A short beep will sound and the next message will be played.
[5] :	Plays back all messages.	[*] [5] :	Erases all messages. <ul style="list-style-type: none">• A long beep will sound and "No messages" will be heard.
[1] :	Repeats the current message. <ul style="list-style-type: none">• If pressed within the first 5 seconds of playback, the previous message will be played.	[0] :	Turns off the Answering System. <ul style="list-style-type: none">• The unit hangs up.
[2] :	Skips the current message.		
[9] :	Stops the current operation. <ul style="list-style-type: none">• To resume, enter a direct command within 15 seconds, or the voice menu will start (p. 29).		

To turn on the Answering System

Call your unit and wait for 15 rings.

- The unit will answer and the greeting will be played.
- The Answering System will be turned on. Hang up or enter the remote code for other options.
- When turning on the Answering System using a rotary or pulse service telephone, you cannot enter the remote code for other options.

Skipping the greeting

After calling your unit, press [*] during the greeting.

- The unit skips the rest of the greeting and you can start recording your message after the long beep.

Wall Mounting

This unit can be mounted on a wall phone plate.

- 1 Press the tabs in the direction of the arrows (①), then remove the wall mounting adaptor (②).

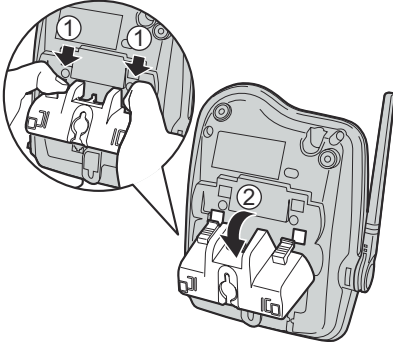

- 2 Connect the AC adaptor.
 - Fasten the AC adaptor cord to prevent it from being disconnected.

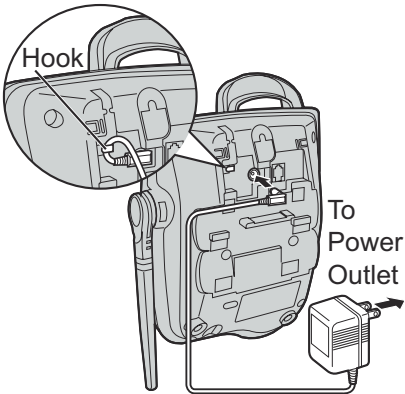

- 3 Tuck the telephone line cord inside the wall mounting adaptor, then push the adaptor in the direction of the arrows (① and ②) while pressing the tabs.
 - The word "UP WALL" should face upward.

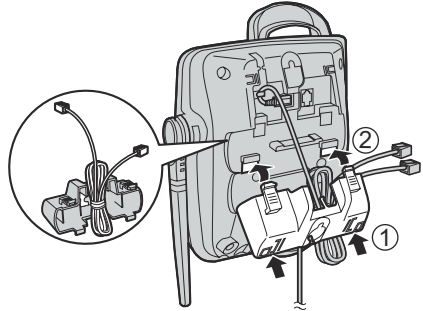

- 4 Connect the telephone line cord. Mount the unit, then slide it down.
 - Raise the antenna.

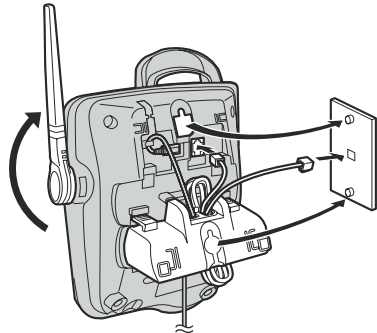

- 5 To charge the handset battery:
 - Place the handset on the base unit.
 - The unit beeps once and the CHARGE indicator lights.

Belt Clip

You can hang the handset on your belt or pocket using the included belt clip.

To attach the belt clip

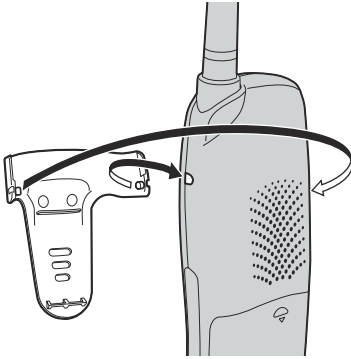

To remove the belt clip

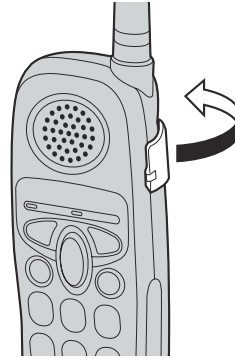

Shoulder Rest Attachment

Use the shoulder rest attachment if you need to keep your hands free during a phone conversation.

To attach the shoulder rest attachment

Attach the included belt clip to the handset (see above), then attach the shoulder rest attachment to the belt clip as shown below. You will hear a click when the shoulder rest attachment is in place.

To remove the shoulder rest attachment

Slide the base of the attachment in the direction of the arrow as shown below.

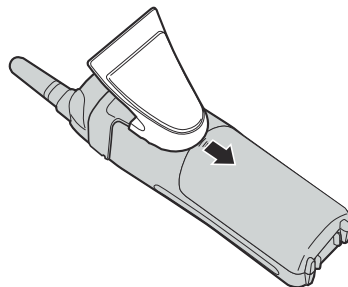
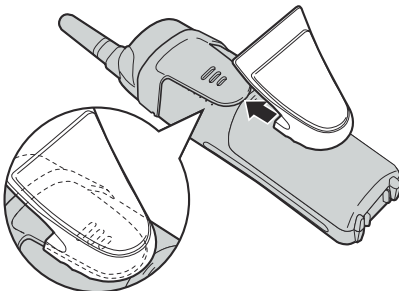

Optional Headset

Connecting an optional headset to the handset allows hands-free phone conversation. Please use only a Panasonic KX-TCA60, KX-TCA86, KX-TCA88, KX-TCA88HA, KX-TCA91, KX-TCA92, or KX-TCA98 headset. To order, call the accessories telephone number on page 2.

Connecting an optional headset

Open the headset jack cover, and insert the headset plug into the headset jack as shown below.

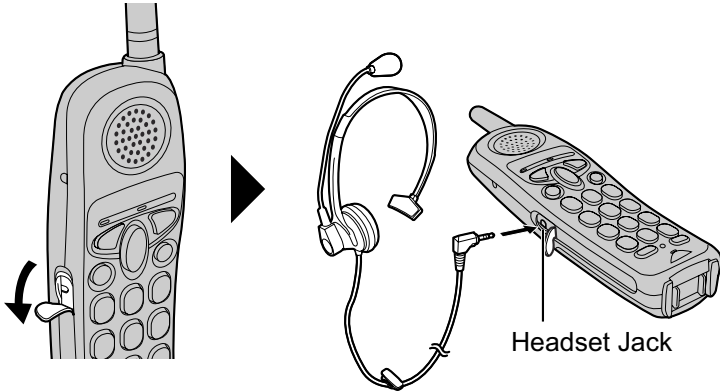



- Headset sold separately. Model shown here is KX-TCA88.

To switch to the speakerphone while using the headset:
Press [SP-PHONE]. To return to the headset, press [↶].

Troubleshooting

Telephone System

Problem	Cause & Remedy
An alarm tone sounds when you press [ , [SP-PHONE] or [VOICE ENHANCER] .	<ul style="list-style-type: none">• You are too far from the base unit. Walk closer to the base unit and try again.• Confirm the AC adaptor is plugged in.• Raise the base unit antenna.• If the above remedies do not solve the problem, the handset may have lost communication with the base unit. Register the handset again (p. 23)
Static, sound cuts in/out, fades. Interference from other electrical units.	<ul style="list-style-type: none">• Move the handset and the base unit away from other electrical appliances (p. 3).• Walk closer to the base unit.• Raise the base unit antenna.
The handset does not ring.	<ul style="list-style-type: none">• The ringer volume is turned off. Set to high, medium, or low (p. 14).
You cannot program any functions.	<ul style="list-style-type: none">• Programming is not possible while the handset is being used.• Do not pause for over 60 seconds while programming.• Walk closer to the base unit.• While another user is listening to messages or the Answering System is handling a call, you cannot program. Try again later.
While programming, the handset starts to ring and the program stops.	<ul style="list-style-type: none">• A call is coming in. To answer the call, press [, or [SP-PHONE]. Start again from the beginning after hanging up.
You cannot redial.	<ul style="list-style-type: none">• If the last number dialed was more than 48 digits long, the number will not be redialed correctly.
You cannot make long distance calls.	<ul style="list-style-type: none">• Please make sure you have long distance service.
You cannot page the handset.	<ul style="list-style-type: none">• The handset is too far from the base unit or is engaged in an outside call. Try again later.

Troubleshooting

Problem	Cause & Remedy
You cannot have a conversation using the headset.	<ul style="list-style-type: none">• Make sure the optional headset is connected properly (p. 33).• [SP-PHONE] may have been pressed. Press [↶] to switch to the headset.
[FLASH/CALL WAIT] does not work properly.	<ul style="list-style-type: none">• Set the flash time. Press [VOICE ENHANCER], [9] and [8], then press [VOICE ENHANCER] again.

Answering System

Problem	Cause & Remedy
The Answering System is on, but incoming messages are not recorded.	<ul style="list-style-type: none">• Memory is full. Erase unnecessary messages (p. 27).
" FULL " flashes and the ANSWER ON indicator flashes rapidly. No new messages are recorded.	<ul style="list-style-type: none">• Memory is full. Erase unnecessary messages (p. 27).
You cannot operate the Answering System with the base unit.	<ul style="list-style-type: none">• If another user is listening to messages or the Answering System is handling a call, you cannot operate the Answering System. Try again later.
You cannot operate the Answering System from a touch tone phone.	<ul style="list-style-type: none">• Make sure you entered the correct remote code (p. 18).• The Answering System may not respond if the tones are too short to activate the unit. Press each button firmly.• The Answering System is off. Turn it on (p. 30).
You cannot erase messages.	<ul style="list-style-type: none">• While another user is operating the Answering System or a caller is leaving a message, you cannot erase messages.

Troubleshooting

Problem	Cause & Remedy
When you play back messages or turn on the Answering System, the unit announces the wrong day and time.	<ul style="list-style-type: none">• The time and day may be set incorrectly. Set the time and day again (p. 13).

General

Problem	Cause & Remedy
The unit does not work.	<ul style="list-style-type: none">• Check the settings (p. 9–11).• Check whether the dialing mode setting is correct (p. 14).• Fully charge the battery (p. 10).• Clean the charge contacts and charge again (p. 11).• Check battery installation (p. 10).• Unplug the AC adaptor to reset it. Plug in, and try again.• Re-install the battery (p. 10) and fully charge it.
The RECHARGE indicator flashes, or the unit beeps intermittently.	<ul style="list-style-type: none">• Fully charge the battery (p. 10).
You charged the battery fully, but the RECHARGE indicator continues to flash.	<ul style="list-style-type: none">• Clean the charge contacts and charge again (p. 11).• The battery may need to be replaced. If you install a new battery, fully charge it (p. 10).
The CHARGE indicator does not go out after the battery has been charged.	<ul style="list-style-type: none">• This is normal.
If you cannot solve your problem	<ul style="list-style-type: none">• Visit our website: http://www.panasonic.com/support• Contact us via the web at: http://www.panasonic.com/contactinfo• Call our customer call center at: 1-800-211-PANA(7262)

Important Safety Instructions

When using this unit, basic safety precautions should always be followed to reduce the risk of fire, electric shock, or personal injury.

1. Read and understand all instructions.
2. Follow all warnings and instructions marked on this unit.
3. Unplug this unit from AC outlets before cleaning. Do not use liquid or aerosol cleaners. Use a damp cloth for cleaning.
4. Do not use this unit near water, for example, near a bathtub, washbowl, kitchen sink, or the like.
5. Place this unit securely on a stable surface. Serious damage and/or injury may result if the unit falls.
6. Do not cover slots and openings on the unit. They are provided for ventilation and protection against overheating. Never place the unit near radiators, or in a place where proper ventilation is not provided.
7. Use only the power source marked on the unit. If you are not sure of the type of power supplied to your home, consult your dealer or local power company.
8. Do not place objects on the power cord. Install the unit where no one can step or trip on the cord.
9. Do not overload wall outlets and extension cords. This can result in the risk of fire or electric shock.
10. Never push any objects through slots in this unit. This may result in the risk of fire or electric shock. Never spill any liquid on the unit.
11. To reduce the risk of electric shock, do not disassemble this unit. Take the unit to an authorized servicer when service is required. Opening or removing covers may expose you to dangerous voltages or other risks. Incorrect reassembly can cause electric shock when the unit is subsequently used.
12. Unplug this unit from the wall outlet and refer servicing to an authorized servicer when the following conditions occur:
 - A. When the power supply cord or plug is damaged or frayed.
 - B. If liquid has been spilled into the unit.
 - C. If the unit has been exposed to rain or water.
 - D. If the unit does not work normally by following the operating instructions. Adjust only controls covered by the operating instructions. Improper adjustment may require extensive work by an authorized servicer.
 - E. If the unit has been dropped or physically damaged.
 - F. If the unit exhibits a distinct change in performance.
13. During thunderstorms, avoid using telephones except cordless types. There may be a remote risk of an electric shock from lightning.
14. Do not use this unit to report a gas leak, when in the vicinity of the leak.

SAVE THESE INSTRUCTIONS

Important Safety Instructions

CAUTION:

To reduce the risk of fire or injury to persons, read and follow these instructions.

1. Use only the battery(ies) specified.
2. Do not dispose of the battery(ies) in a fire. They may explode. Check with local waste management codes for special disposal instructions.
3. Do not open or mutilate the battery(ies). Released electrolyte is corrosive and may cause burns or injury to the eyes or skin. The electrolyte may be toxic if swallowed.
4. Exercise care in handling batteries in order not to short the battery to conductive materials such as rings, bracelets, and keys. The battery and/or conductor may overheat and cause burns.
5. Charge the battery(ies) provided with or identified for use with this product only in accordance with the instructions and limitations specified in this manual.

WARNING:

TO PREVENT FIRE OR SHOCK HAZARD, DO NOT EXPOSE THIS PRODUCT TO RAIN OR ANY TYPE OF MOISTURE.

- The AC adaptor is used as the main disconnect device, ensure that the AC outlet is located/installed near the unit and is easily accessible.

FCC and Other Information

This equipment complies with Part 68 of the FCC rules and the requirements adopted by the ACTA. On the bottom of this equipment is a label that contains, among other information, a product identifier in the format US:ACJ-----.

If requested, this number must be provided to the telephone company.
Registration No. (found on the bottom of the unit)
Ringer Equivalence No. (REN) 0.1B

A plug and jack used to connect this equipment to the premises wiring and telephone network must comply with the applicable FCC Part 68 rules and requirements adopted by the ACTA. A compliant telephone cord and modular plug is provided with this product. It is designed to be connected to a compatible modular jack that is also compliant.

The REN is used to determine the number of devices that may be connected to a telephone line. Excessive RENs on a telephone line may result in the devices not ringing in response to an incoming call. In most but not all areas, the sum of RENs should not exceed five (5.0). To be certain of the number of devices that may be connected to a line, as determined by the total RENs, contact the local telephone company. For products approved after July 23, 2001, the REN for this product is part of the product identifier that has the format US:AAAEQ##TXXXX. The digits represented by ## are the REN without a decimal point (e.g., 03 is a REN of 0.3). If this equipment causes harm to the telephone network, the telephone company will notify you in advance that temporary discontinuance of service may be required. But if advance notice isn't practical, the telephone company will notify the customer as soon as possible. Also, you will be advised of your right to file a complaint with the FCC if you believe it is necessary.

The telephone company may make changes in its facilities, equipment, operations or procedures that could affect the operation of the equipment. If this happens the telephone company will provide advance notice in order for you to make necessary modifications to maintain uninterrupted service.

If trouble is experienced with this equipment, for repair or warranty information, please contact a Factory Servicenter or other Authorized Servicer. If the equipment is causing harm to the telephone network, the telephone company may request that you disconnect the equipment until the problem is resolved.

Connection to party line service is subject to state tariffs. Contact the state public utility commission, public service commission or corporation commission for information.

If your home has specially wired alarm equipment connected to the telephone line, ensure the installation of this equipment does not disable your alarm equipment. If you have questions about what will disable alarm equipment, consult your telephone company or a qualified installer.

This device complies with Part 15 of the FCC Rules. Operation is subject to the following two conditions: (1) This device may not cause harmful interference, and (2) this device must accept any interference received, including interference that may cause undesired operation.

Privacy of communications may not be ensured when using this phone.

FCC and Other Information

CAUTION:

Any changes or modifications not expressly approved by the party responsible for compliance could void the user's authority to operate this device.

Note:

This equipment has been tested and found to comply with the limits for a Class B digital device, pursuant to Part 15 of the FCC Rules. These limits are designed to provide reasonable protection against harmful interference in a residential installation. This equipment generates, uses, and can radiate radio frequency energy and, if not installed and used in accordance with the instructions, may cause harmful interference to radio communications. However, there is no guarantee that interference will not occur in a particular installation. If this equipment does cause harmful interference to radio or television reception, which can be determined by turning the equipment off and on, the user is encouraged to try to correct the interference by one or more of the following measures:

- Reorient or relocate the receiving antenna.
- Increase the separation between the equipment and receiver.
- Connect the equipment into an outlet on a circuit different from that to which the receiver is connected.
- Consult the dealer or an experienced radio/TV technician for help.

Some cordless telephones operate at frequencies that may cause interference to nearby TVs and VCRs. To minimize or prevent such interference, the base of the cordless telephone should not be placed near or on top of a TV or VCR. If interference is experienced, move the cordless telephone further away from the TV or VCR. This will often reduce, or eliminate, interference.

Operating near 2.4GHz electrical appliances may cause interference. Move away from the electrical appliances.

FCC RF Exposure Warning:

This product complies with FCC radiation exposure limits set forth for an uncontrolled environment. To comply with FCC RF exposure requirements the base unit must be installed and operated with its antenna located 20 cm or more between antenna and all person's body (excluding extremities of hands, wrist and feet). The handset unit may be carried and operated with only the specific provided belt-clip. Other non-tested belt-clips or similar body-worn accessories may not comply and must be avoided. The base and handset units must not be co-located or operated in conjunction with any other antenna or transmitter.

This equipment is hearing aid compatible as defined by the FCC in 47 CFR Section 68.316.

When you hold the phone to your ear, noise might be heard in your Hearing Aid. Some Hearing Aids are not adequately shielded from external RF (radio frequency) energy. If noise occurs, use an optional headset accessory or the speakerphone option (if applicable) when using this phone. Consult your audiologist or Hearing Aid manufacturer about the availability of Hearing Aids which provide adequate shielding to RF energy commonly emitted by digital devices.

A TIA/EIA-IS-968 compliant telephone cord and modular plug is provided with this equipment. This equipment is designed to be connected to the telephone network or premises wiring using a compatible modular jack that is also TIA/EIA-IS-968 compliant.

FCC and Other Information

- **Environment** — do not place the unit in a room where the temperature is less than 5°C (41°F) or greater than 40°C (104°F). Allow 10 cm (4") clearance around the unit for proper ventilation. Avoid excessive smoke, dust, mechanical vibration, shock, or direct sunlight.
- **Medical** — consult the manufacturer of any personal medical devices, such as pacemakers or hearing aids, to determine if they are adequately shielded from external RF (radio frequency) energy. (The unit operates in the frequency range of 2400MHz to 2481MHz, and the power output level can range 0.04 to 0.1 watts.) Do not use the unit in health care facilities if any regulations posted in the area instruct you not to do so. Hospitals or health care facilities may be using equipment that could be sensitive to external RF (radio frequency) energy.
- **Routine care** — wipe the unit with a soft cloth. Do not use benzine, thinner, or any abrasive powder. When you leave the unit unused for a long period of time, unplug the AC adaptor from the outlet.
- **If there is any trouble** — disconnect the unit from the telephone line and connect a known working phone. If the known working phone operates properly, have your unit repaired by one of the authorized Panasonic Factory Service Centers. If the known working phone does not operate properly, consult your telephone company.

Index

A

- Accessories 2
- Answer setting 24
- Answering calls 21

B

- Base unit location 3
- Battery charge 3, 10
- Battery information* 11
- Battery replacement 11
- Belt clip 32

C

- Call monitoring* 25
- Call waiting tone 22

D

- Dialing mode 14

E

- Erasing a message 27, 30
- Erasing all messages 27, 30

F

- FCC and other information 39
- FLASH Button 22

G

- Greeting message* 16

H

- Handset locator 22
- Headset, optional 33

I

- Installation, AC adaptor 9
- Installation, battery 10
- Installation, telephone line cord 9

L

- Lighted handset keypad 20
- Listening to messages 26
- Location of controls 6, 7

M

- Making calls 19
- Message storage 17
- Microphone, base unit 16
- Microphone, handset 19
- Monitoring incoming calls* 25

N

- Noise 3
- Number of rings 18

P

- Power failure 9, 13
- Pulse service 22

R

- Redial 20
- Registration* 23
- Remote code 18
- Remote operation,
touch tone phone 28
- Ringer off 14, 21
- Ringer tone 15
- Ringer volume 14
- Rotary service, tone dialing 22

S

- Safety instructions 37
- Shipping product
for service 46
- Shoulder rest attachment 32
- Specifications 45
- SP-phone, handset 19

T

- Time and day* 13
- Toll saver 18
- Troubleshooting,
Answering System 35
- Troubleshooting,
Telephone System 34
- Troubleshooting, general 36
- TTY 2, 44, Back Cover

V

- Voice Enhancer Technology* 20
- Voice menu 29
- Volume control, base unit 16, 26
- Volume control, handset 20

W

- Wall mounting 31
- Warranty 43

• “—” indicates important information and frequently used features.

**PANASONIC CONSUMER
ELECTRONICS COMPANY, DIVISION
OF MATSUSHITA ELECTRIC
CORPORATION OF AMERICA**
One Panasonic Way
Secaucus, New Jersey 07094

**PANASONIC SALES COMPANY,
DIVISION OF MATSUSHITA
ELECTRIC OF PUERTO RICO, INC.,**
Ave. 65 de Infanteria, Km. 9.5
San Gabriel Industrial Park
Carolina, Puerto Rico 00985

Panasonic Telephone Limited Warranty

Limited Warranty Coverage

If your telephone (identified in your Operating Instructions) does not work properly because of a defect in materials or workmanship, Panasonic Consumer Electronics Company or Panasonic Sales Company (collectively referred to as "the warrantor") will, for the length of the period indicated on the chart below, which starts with the date of original purchase ("Limited Warranty period"), at its option either (a) repair your product with new or refurbished parts, or (b) replace it with a new or a refurbished product. The decision to repair or replace will be made by the warrantor.

Parts	Labor
One (1) Year	One (1) Year

During the "Labor" Limited Warranty period there will be no charge for labor. During the "Parts" Limited Warranty period, there will be no charge for parts. You must mail-in your product during the Limited Warranty period. This Limited Warranty excludes both parts and labor for batteries, antennas, and cosmetic parts (cabinet). This Limited Warranty only applies to products purchased and serviced in the United States or Puerto Rico. This Limited Warranty is extended only to the original purchaser and only covers products purchased as new. A purchase receipt or other proof of the original purchase date is required for warranty service.

To obtain service in the USA please contact:

Panasonic Services Company, Panasonic Plus Department
20421 84th Avenue South
Kent, WA 98032
Tel: 1-800-833-9626 Fax: 1-800-237-9080

For assistance in Puerto Rico call Panasonic Sales Company (787)-750-4300 or fax (787)-768-2910.

For Limited Warranty service for headsets if a headset is included with this product please call Panasonic Plus Department at 1-800-833-9626.

When shipping the unit carefully pack, include all accessories, and send it prepaid, adequately insured and preferably in the original carton. Include a letter detailing the complaint, a return address and a day time phone number where you can be reached.

Limited Warranty Limits And Exclusions

This Limited Warranty ONLY COVERS failures due to defects in materials or workmanship, and DOES NOT COVER normal wear and tear or cosmetic damage. The Limited Warranty ALSO DOES NOT COVER damages which occurred in shipment, or failures which are caused by products not supplied by the warrantor, or failures which result from accidents, misuse, abuse, neglect, mishandling, misapplication, alteration, faulty installation, set-up adjustments, misadjustment of consumer controls, improper maintenance, power line surge, lightning damage, modification, introduction of sand, humidity or liquids, commercial use such as hotel, office, restaurant, or other business or rental use of the product, or service by anyone other than a Factory Servicenter or other Authorized Servicer, or damage that is attributable to acts of God.

THERE ARE NO EXPRESS WARRANTIES EXCEPT AS LISTED UNDER "LIMITED WARRANTY COVERAGE". THE WARRANTOR IS NOT LIABLE FOR INCIDENTAL OR CONSEQUENTIAL DAMAGES RESULTING FROM THE USE OF THIS PRODUCT, OR ARISING OUT OF ANY BREACH OF THIS LIMITED WARRANTY. (As examples, this excludes damages for lost time, lost calls or messages, cost of having someone remove or re-install an installed unit if applicable, travel to and from the servicer. The items listed are not exclusive, but are for illustration only.) **ALL EXPRESS AND IMPLIED WARRANTIES, INCLUDING THE WARRANTY OF MERCHANTABILITY, ARE LIMITED TO THE PERIOD OF THE LIMITED WARRANTY.**

Some states do not allow the exclusion or limitation of incidental or consequential damages, or limitations on how long an implied warranty lasts, so the exclusions may not apply to you.

This Limited Warranty gives you specific legal rights and you may also have other rights which vary from state to state. If a problem with this product develops during or after the Limited Warranty period, you may contact your dealer or Servicenter. If the problem is not handled to your satisfaction, then write to the warrantor's Consumer Affairs Department at the addresses listed for the warrantor.

PARTS AND SERVICE, WHICH ARE NOT COVERED BY THIS LIMITED WARRANTY, ARE YOUR RESPONSIBILITY.

Customer Services Directory

Obtain Product Information and Operating Assistance; locate your nearest Dealer or Servicenter; purchase Parts and Accessories; or make Customer Service and Literature requests by visiting our Web Site at:

<http://www.panasonic.com/support>

or, contact us via the web at:

<http://www.panasonic.com/contactinfo>

You may also contact us directly at: 1-800-211-PANA (7262),
Monday-Friday 9 am-9 pm; Saturday-Sunday 10 am-7 pm, EST.

For hearing or speech impaired TTY users, TTY : 1-877-833-8855

Accessory Purchases

Purchase Parts, Accessories and Instruction Books online for all Panasonic Products by visiting our Web Site at:

<http://www.pasc.panasonic.com>

or, send your request by E-mail to:

npcparts@panasonic.com

You may also contact us directly at:

1-800-332-5368 (Phone) 1-800-237-9080 (Fax Only)

(Monday - Friday 9 am to 8 pm, EST.)

Panasonic Services Company

20421 84th Avenue South, Kent, WA 98032

(We Accept Visa, MasterCard, Discover Card, American Express,
and Personal Checks)

For hearing or speech impaired TTY users, TTY : 1-866-605-1277

Service in Puerto Rico

***Matsushita Electric of Puerto Rico, Inc. Panasonic Sales Company
Factory Servicenter:***

***Ave. 65 de Infantería, Km. 9.5, San Gabriel Industrial Park,
Carolina, Puerto Rico 00985***

Phone (787)750-4300, Fax (787)768-2910

Specifications

■ Base unit

- Power Supply:** AC Adaptor (120 V AC, 60 Hz)
- Power Consumption:** Standby: Approx. 2.1 W
Maximum: Approx. 5.0 W
- Frequency:** 2.4 GHz – 2.48 GHz
- Dimensions (H x W x D):** Approx. 124 mm x 155 mm x 174 mm
(4 ⁷/₈" x 6 ³/₃₂" x 6 ²⁷/₃₂")
- Mass (Weight):** Approx. 390 g (0.86 lb.)

■ Handset

- Power Supply:** Ni-MH battery (3.6 V, 830 mAh)
- Frequency:** 2.4 GHz – 2.48 GHz
- Dimensions (H x W x D):** Approx. 208 mm x 52 mm x 39 mm
(8 ³/₁₆" x 2 ¹/₁₆" x 1 ¹⁷/₃₂")
- Mass (Weight):** Approx. 190 g (0.42 lb.)
- Security Codes:** 1,000,000

- **Dialing Mode:** Tone (DTMF)/Pulse

- **Operating Environment:** 5 °C – 40 °C (41 °F – 104 °F)

Specifications are subject to change without notice.

For your future reference

Serial No. _____ Date of purchase _____

(found on the bottom of the unit)

Name and address of dealer _____

For product service

- Visit our website: <http://www.panasonic.com/support>
- Contact us via the web at: <http://www.panasonic.com/contactinfo>
- Call us at: 1-800-211-PANA(7262) or 1-800-833-9626

When you ship the product

- Carefully pack your unit, preferably in the original carton.
- Attach a letter, detailing the symptom, to the outside of the carton.

Symptom

- Send the unit to an authorized servicer, prepaid and adequately insured.
- Do not send your unit to the Panasonic Consumer Electronics Company listed on the back cover or to executive or regional sales offices. These locations do not repair consumer products.

- This cordless telephone is designed for use in the United States of America. Sale or use of this product in other countries may violate local laws.
- Ce téléphone sans fil est conçu pour être utilisé aux États-Unis d'Amérique. La vente ou l'emploi de cet appareil dans certains autres pays peut constituer une infraction à la législation locale.
- Este teléfono inalámbrico fue elaborado para uso en los Estados Unidos de América. La venta o el empleo de este producto en ciertos países puede constituir violación de la legislación local.
- このコードレス電話機は、日本国外での使用を目的として設計されており、日本国内での使用は法律違反となります。従って、当社では日本国内においては原則として修理などのサービスは致しかねます。

**If you need assistance with the setup or operation,
please call 1-800-211-PANA(7262)
For hearing or speech impaired TTY users, TTY : 1-877-833-8855**

**Panasonic Consumer Electronics Company,
Division of Matsushita Electric Corporation of America**
One Panasonic Way, Secaucus, New Jersey 07094

**Panasonic Sales Company,
Division of Matsushita Electric of Puerto Rico, Inc.**
Ave. 65 de Infantería, Km. 9.5, San Gabriel Industrial Park
Carolina, Puerto Rico 00985

© 2004 Panasonic Communications Co., Ltd. All Rights Reserved.

PQQX13983YA S1203-1014

Instrucciones de funcionamiento

Gracias por la adquisición de su nuevo teléfono inalámbrico Panasonic.

- Guarde este manual para futuras consultas.

Compruebe los accesorios:

- | | |
|--|---|
| <input type="checkbox"/> Adaptador de CA 1 | <input type="checkbox"/> Cubierta de la unidad portátil . . . 1 |
| <input type="checkbox"/> Cable de línea telefónica 1 | <input type="checkbox"/> Presilla para el cinturón 1 |
| <input type="checkbox"/> Batería 1 | <input type="checkbox"/> Accesorio de ajuste al hombro . . 1 |

Instalación de la unidad

1 Conecte como se muestra.

Sujete el cable de adaptador de CA para impedir que se desconecte.

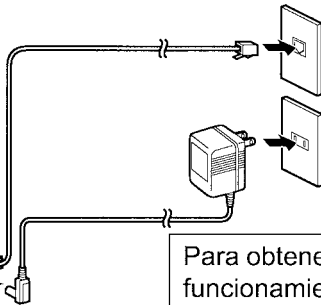
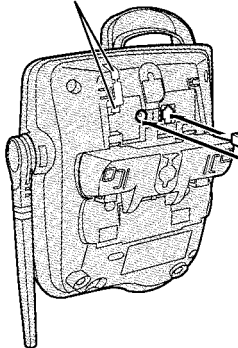

Toma telefónica de una sola línea (RJ11C)

Toma de corriente (120 V CA, 60 Hz)

Para obtener un mayor radio de acción y un funcionamiento sin ruidos, coloque la unidad base en un lugar ELEVADO y CÉNTRICO, sin obstáculos ni interferencias provenientes de aparatos eléctricos.

- El adaptador de CA debe permanecer conectado en todo momento.

2 Instale la batería en la unidad portátil.

Inserte la batería (①), y empújela hacia abajo hasta que encaje con un chasquido en el compartimento (②). Cuando termine, cierre la cubierta.

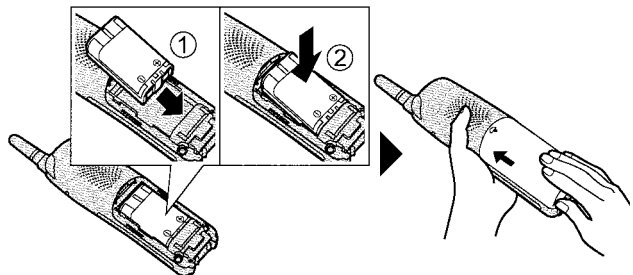

3 Cargue la batería durante 6 horas antes de empezar a usar la unidad.

Coloque la unidad portátil sobre la unidad base.

- La unidad emite un pitido y el indicador CHARGE se ilumina.

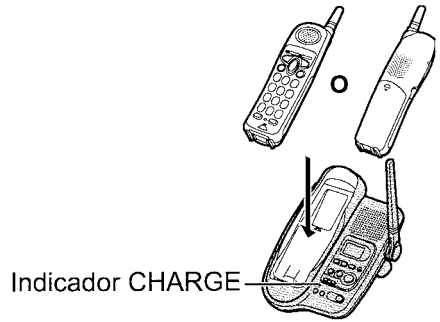

Utilización de la unidad

Levante la antena de la unidad base para obtener la mejor recepción.

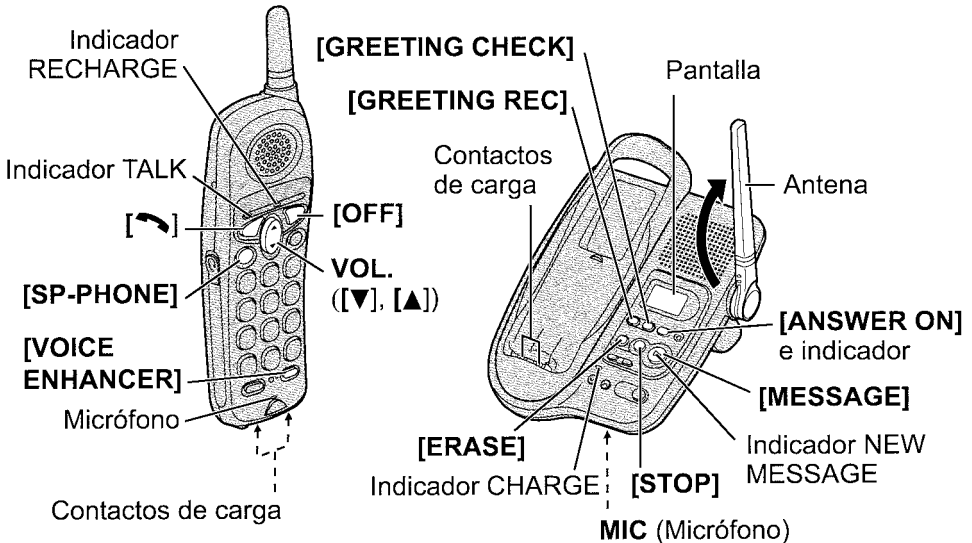

Importante: A lo largo de estas instrucciones de funcionamiento, **Unidad portátil** y **Unidad base** se usan para indicar con qué unidad se puede ejecutar una operación.

Unidad portátil: Ejecución con la unidad portátil.

Unidad base: Ejecución con la unidad base.

Atención:

- Recargue la batería cuando el indicador RECHARGE parpadee o la unidad portátil emita pitidos intermitentes durante su uso.
- **Limpie los contactos de carga de la unidad portátil y de la unidad base con un paño suave y seco una vez al mes. Límpielos más a menudo si la unidad está sometida a grasa, polvo o a humedad de nivel alta.** De lo contrario, puede que la batería no se cargue correctamente.

Para usar una presilla para el cinturón un accesorio de ajuste al hombro, o un auricular opcional (nº. de pedido KX-TCA60, KX-TCA86, KX-TCA88, KX-TCA88HA, KX-TCA91, KX-TCA92, o KX-TCA98), consulte las páginas 32 a 33 en las instrucciones de funcionamiento en inglés.

Preparativos programables

Unidad portátil

Asegúrese de que la unidad portátil y la unidad base no se están utilizando. La unidad portátil debe operarse cerca de la unidad base cuando se encuentre desconectada de la misma.

① Ajuste de la hora y la fecha

Le recomendamos que ajuste la hora y la fecha para que la unidad anuncie la fecha y la hora que se ha grabado cada mensaje cuando los reproduzca.

Presione **[VOICE ENHANCER]** ➡ **[0]** ➡

➡ **[4 dígitos para la hora (horas y minutos)]** ➡ **[*]** (para seleccionar AM/PM) ➡
Ej. Para poner las 9:30, introduzca "0930".

➡ **[#]** (para seleccionar la fecha) ➡ **[VOICE ENHANCER]**

- La fecha y la hora quedan ajustadas, y "Ⓞ" desaparece de la pantalla de la unidad base.
- La indicación horaria y de fecha se desajustará tras un fallo eléctrico. Cuando "Ⓞ" parpadee en la pantalla de la unidad base, ajuste de nuevo la hora y la fecha.
- **Para confirmar la hora y la fecha:** Presione **[VOICE ENHANCER]** y luego **[0]**. Se anuncian la hora y la fecha actuales. Cuando termine, presione **[OFF]**.

② Selección del modo de marcación

La preconfiguración de fábrica es la marcación por "Tonos". Si no puede marcar, ajústelo en "Pulsos".

Presione **[VOICE ENHANCER]** ➡ **[8]** ➡

➡ Presione **[1]** para seleccionar "Pulsos" o presione **[2]** para seleccionar "Tonos" ➡
➡ **[VOICE ENHANCER]**

③ Selección del número de veces que suena el timbre antes de que responda el contestador

Puede seleccionar el número de veces que suena la unidad antes de que el contestador contesta a la llamada: "2" a "7", o "Ahorro de tarifa".

La preconfiguración de fábrica es "4".

Presione **[VOICE ENHANCER]** ➡ **[2]** ➡



➡ Seleccione el número de timbrazos presionando **[0]** (Ahorro de tarifa), o **[2]** a **[7]** ➡ **[VOICE ENHANCER]**

Para hacer llamadas

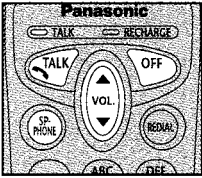
Unidad portátil





- 1 Presione [] o **[SP-PHONE]** y luego marque el número de teléfono.
- 2 Para colgar, presione **[OFF]** o ponga la unidad portátil en la unidad base.

- Para ajustar el volumen del receptor/altavoz, presione [] o [] durante una conversación. El receptor dispone de 3 niveles (Alto, Medio y Bajo) disponibles. El altavoz dispone de 6 niveles. Con cada presión, cambiará el volumen.

Para contestar llamadas

Unidad portátil

Si la unidad portátil está descolgada de la unidad base, presione [] o **[SP-PHONE]**.

- También puede contestar una llamada presionando cualquier botón excepto el [], [] u **[OFF]**.

o

Si la unidad portátil está sobre la unidad base, simplemente descuelgue.

Grabación de un mensaje de saludo

Usted puede grabar un mensaje de saludo personal de **hasta 2 minutos**. El tiempo total de grabación de todos los mensajes (de saludo y entrantes) es de **unos 15 minutos**.

Unidad Base

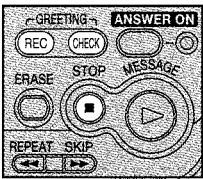

- 1 Presione **[GREETING REC]**.
 - Se oye la siguiente frase en inglés: "To record greeting, press RECORD again".
- 2 Antes de que pasen 10 segundos, presione **[GREETING REC]** de nuevo para grabar su mensaje de saludo.
- 3 Después de que suene el pitido largo, hable por **MIC**.
- 4 Cuando haya terminado, presione **[GREETING REC]** o **[STOP]**.

- Para comprobar el mensaje de saludo, presione **[GREETING CHECK]**.
- Si no graba un mensaje de saludo, cuando se reciba una llamada se reproducirá un mensaje de saludo pregrabado. (Para conocer los detalles, consulte la página 17 de las instrucciones de funcionamiento en inglés.)

Ajuste de la unidad para contestar llamadas

Unidad Base

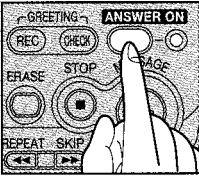

Presione **[ANSWER ON]** para activar el contestador.

- El indicador se ilumina y la unidad anuncia en inglés “Answer set” y la fecha y la hora actuales.
- La unidad anunciará el tiempo de grabación restante si es inferior a 3 minutos.

Si se oye la frase en inglés “Memory full”, “**FULL**” parpadea en la unidad base, y el indicador ANSWER ON parpadea con rapidez, borre todos los mensajes innecesarios.

Audición de los mensajes

La pantalla de la unidad base muestra el número total de mensajes grabados. Si se han grabado nuevos mensajes, el indicador NEW MESSAGE parpadea.

Unidad Base

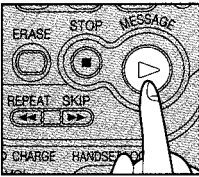

Presione **[MESSAGE]**.

- Si hay mensajes ya revisados y mensajes nuevos, solamente se reproducen los mensajes nuevos.
- Cuando no hay mensajes nuevos, la unidad anuncia en inglés “No new messages. All message playback” y reproduce todos los mensajes.
- Para borrar un mensaje**, presione **[ERASE]** durante la reproducción del mensaje que desea borrar.
- Para borrar todos los mensajes**, presione **[ERASE]** dos veces cuando la unidad base no esté en uso.

Operación remota desde un teléfono de marcación por tonos

Ajuste del código remoto **Unidad portátil**

El código remoto impide a personas no autorizadas el acceso a su unidad y a los mensajes contenidos en ella. Elija un **número de dos dígitos (00–99)** cualquiera. El código remoto preconfigurado en fábrica es "11".

Presione **[VOICE ENHANCER]** ➡ **[1]** ➡

➡ **Número de 2 dígitos (00–99)** ➡ **[VOICE ENHANCER]**

Resumen de la operación remota

Llame a su unidad desde un teléfono de marcación por tonos.



Introduzca su código remoto (ver más arriba) durante o después del mensaje de saludo.

- Se oirá el número de nuevos mensajes, y se reproducirán los mensajes nuevos.



Al cabo de 3 segundos, empieza el menú de voz. Presione **[1]** o **[2]** para seleccionar la función deseada.

○

Siga el menú o introduzca los comandos directos (ver más abajo).



Para finalizar la operación remota, cuelgue.

- Pulse los botones con firmeza.
- **Para activar el contestador**, llame a su unidad y espere a que el timbre suene 15 veces. Cuando la unidad conteste, cuelgue o introduzca el código remoto para acceder a otras opciones.

Comandos directos

[1]	Repetición de un mensaje	[9]	Detención de la operación
[2]	Salto de un mensaje	[0]	Desactivación del contestador
[4]	Reproducción de nuevos mensajes	[*] [4]	Borrado de un mensaje
[5]	Reproducción de todos los mensajes	[*] [5]	Borrado de todos los mensajes

- **Para saltar el mensaje de saludo** cuando llame a su unidad, presione **[*]** durante la reproducción del mensaje de saludo.

Free Manuals Download Website

<http://myh66.com>

<http://usermanuals.us>

<http://www.somanuals.com>

<http://www.4manuals.cc>

<http://www.manual-lib.com>

<http://www.404manual.com>

<http://www.luxmanual.com>

<http://aubethermostatmanual.com>

Golf course search by state

<http://golfingnear.com>

Email search by domain

<http://emailbydomain.com>

Auto manuals search

<http://auto.somanuals.com>

TV manuals search

<http://tv.somanuals.com>