

TOUGHBOOK

95

In this manual, descriptions are given using illustrations not featuring the hand-grip belt or handle for convenience of explanation.



CF-M34 Series



CF-17 Series

Contents

Read Me First.....	2
Key Combinations.....	4
LED Indicators.....	5
Touch Pad (Advanced).....	6
Touchscreen.....	10
Panasonic Hand Writing (Touchscreen).....	12
Suspend/Hibernation Functions.....	13
Security Measures.....	16
Computing On The Road.....	19
Battery Power.....	21
PC Cards.....	27
RAM Module.....	28
External Display.....	29
USB Devices.....	30
Modem.....	32
Port Replicator.....	33
Accessories.....	34
Hard Disk Drive.....	35
Setup Utility.....	37
Smart Boot.....	43
Technical Information.....	44
DMI Viewer.....	45
Creating BACKUP DISKS.....	46
List of Error Codes.....	48
Dealing With Problems (Advanced).....	50

Illustrations in this Reference Manual

NOTE:

NOTE provides a useful fact or helpful information.

CAUTION:

CAUTION indicates a condition that may result in minor or moderate injury.

WARNING:

WARNING indicates a hazard that may result in moderate or serious injury.



[Start]-[Shut Down]:

This illustration means to click [Start], then to click [Shut Down].

(For some applications, you may need to double-click.)

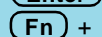

 :

This illustration means to press the [Enter] key.

 +  :

This illustration means to press and hold the [Fn] key, then press the [F5] key.

 page:

When the cursor is moved to an item under [Contents] or to  page (green display), the shape of the cursor will change to . Under this condition, if characters are tapped (or a click is made), the corresponding page in the Reference Manual will be displayed.

  :

This illustration means to refer to the Operating Instructions.

We recommend that this Reference Manual be printed.

Saving Data on the Hard Disk

- **Do not expose your computer to shock.**
Please use care when handling your computer, shock may damage your hard disk or make your software applications and data unusable.
- **Do not power off your computer while software applications are running or HDD indicator (HDD) is on.**
Properly shut Windows* down to avoid problems ([Start] - [Shut Down]).
- **Save all valuable data to disks.**
Backing up data to disks will limit damage should trouble occur to your computer or should you inadvertently change or erase data.
- **Use the security function for all important data.** ( page 16)

* This computer uses Microsoft® Windows® 95 Operating System.

Saving Data on Disks

- **Do not power off your computer or press the floppy disk drive eject button while the floppy disk drive being accessed.**
Doing so may damage the data on the disk and render the disk useless.
- **Use care when handling disks.**
To protect the data on your disks or to prevent a disk from becoming stuck in your computer, avoid the following:
 - Sliding the shutter on the disk manually.
 - Exposing the disk to a magnetic field.
 - Storing the disk in locations prone to high temperatures, low pitched noise, dampness, or dust.
 - Applying more than one label on the disk.
- **Confirm the contents of a disk before formatting it.**
Confirm that no important data is on the disk, because all data on the disk will be erased.
- **Use the write-protect tab.**
This is a must for preserving important data.
This prevents your data from being erased or overwritten.



Write Enable



Write Disable

Computer Viruses

- **Users are advised to purchase the latest versions of virus protection software and use them regularly.**

We recommend you run the software:

- When booting your computer.
- After receiving data.

We recommend that you check data received on disks or from external sources, such as data downloaded from the Internet, e-mail, etc. (For compressed files, please uncompress them before running a check).

LCD Panel

High-precision and advanced technologies are necessary in the production of color liquid crystal displays (color LCDs). Therefore, if 99.998% or more of the picture elements are functioning properly, no defect is considered to exist.

Usage Environment

● Environment

- Place the computer on a flat stable surface.
- In use: Temperature: 5 °C to 35 °C {41 °F to 95 °F}
Humidity: 30% to 80% RH (No condensation)
- Not in use: Temperature: -20 °C to 60 °C {-4 °F to 140 °F}
Humidity: 30% to 90% RH (No condensation)

● Places not to use your computer

- Such areas may result in damage to the computer.

Areas with electronic equipment

These areas may interfere with your display or cause your computer to produce strange sounds.

Areas with extremely high/low temperatures

- Do not leave things near the computer that are sensitive to heat. During operation, the computer may become warm.



Handling

- This computer has been designed so as to minimize shock to the LCD and hard disk drive, the leakage of liquid (e.g., water) from the keyboard, etc., but no warranty is provided against such trouble. Therefore, as a precision instrument, please be extremely careful in the handling.
- Do not drop or hit your computer against solid objects.
Do not stand the computer on its side or allow it to tip over. When the computer receives extremely strong shock after falling, the hard disk or floppy disk drive, etc., may become inoperable.
- Do not carry your computer when it is ON.
- Remove all cables before transporting your computer.
- We recommend preparing a fully charged battery (and optional charger, if possible). When transporting spare batteries inside a package, briefcase, etc., it is recommended that the batteries be stored in a plastic bag.
- Do not place the computer upright. When the computer receives extremely strong shock after falling, the hard disk or floppy disk drive, etc., may become inoperable.
- Do not carry the computer while the display is open, or carry it by gripping the display.
- Do not put anything (e.g., a piece of paper) between the display and keyboard.
- Always carry your computer with you. Never check it in with luggage. For use of the computer inside an aircraft, we recommend asking the airlines regarding their policy on this issue.

Maintenance

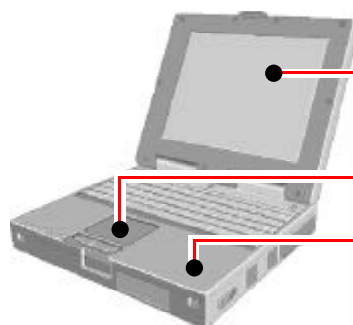

Display

Use a soft dry cloth like gauze to lightly wipe the display.

Touch Pad

 [page 9](#)

Areas excluding the display

Wipe these areas with a soft cloth, after applying water or detergent diluted with water to the soft cloth and firmly wringing out excess water.











CAUTION

- Do not use benzene or thinner, or disinfectant-type alcohol.
- Do not directly use water, liquid detergents or spray-type cleaners. If liquid enters the computer, this may cause the computer to malfunction or become defective.

Key Combinations



CAUTION















- Do not press the following key combinations repeatedly in (quick) succession.
- Do not press the following key combinations while using the touch pad (mouse) or other keys.
- When a MIDI file is playing, do not use the following key combinations. The tempo of the MIDI file may temporarily slow.

Key	Functions	Popup Window
Fn + F1	LCD brightness control (▼down)	 Is displayed when the brightness is at its maximum value.  Is displayed when the brightness is at its minimum value.
Fn + F2	LCD brightness control (▲up)	
Fn + F3	Display change	
Fn + F4	Speakers on/off switch	 OFF  ON
Fn + F5 ^{*1}	Volume control (▼down)	 Down  Up
Fn + F6 ^{*1}	Volume control (▲up) Holding down on the keys changes the sound level.	
Fn + F7 ^{*2}	Power off using the suspend function	
Fn + F8 ^{*3}	Power management enable/disable switch	 Enable  Disable
Fn + F9	Remaining capacity of the battery pack	 Remaining capacity (%) display  Battery pack is not installed.
Fn + F10 ^{*2}	ECO mode for conserving power	

CAUTION
Disabling the speakers will also disable the warning beep.

NOTE
This key combination cannot be used to adjust the volume of the warning beep and the touchscreen sound.

*1 Under the condition the sound function of Windows is not working,  or  is displayed, but the volume does not change.
 *2 When [Disable] is set for [Fn+F7/Fn+F10 key] with the Setup Utility, these key combinations become inoperable.
 *3 Depending on the state of the system, settings may be unable to be changed. In such cases, try performing the settings again.
 *4 This "mouse" indicates the touch pad, the touchscreen and an external mouse.
 Download from www.Somanuals.com. All Manuals Search And Download.

	Caps Lock	This indicator lights green when Caps Lock is pressed. Subsequent non-shifted input is capitalized.
	NumLk (Numeric key)	These indicators light green when NumLk is pressed. This causes a portion of the keyboard to function as a numeric keypad. The [Enter] key functions differently depending on the application.
	ScrLk (Scroll lock)	This indicator lights green when ScrLk is pressed. Scroll lock functions differently depending on the application.
	Hard disk status	This indicator lights when the hard disk drive is accessed.
	Battery pack status	<p> Not lit : AC adapter not connected or charging not being performed. Orange  : Charging in progress. Green  : Charging finished. Red  : Battery is low (remaining battery capacity is approx. 9% or less). Blinking red  : Battery pack or charging malfunction. Blinking orange  : Battery capacity being refreshed. Blinking orange five times after the AC adapter is connected  : Charging on standby. (The ambient temperature is outside the allowable range. Once the allowable range requirement is satisfied, charging begins automatically.) </p>
	Power status	<p> Not lit : Power off Green  : Power on Blinking green  : Suspend mode </p>

Using the Touch Pad

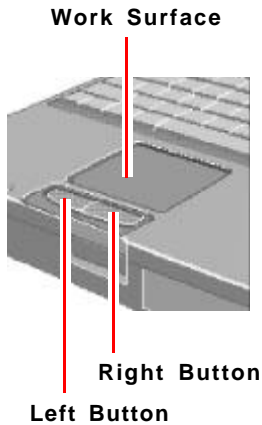

Use the touch pad to move the cursor on the display and perform normal computer operations.

For instructions on how to handle the touch pad, refer to page 9.

The touch pad has the following two modes of operation.

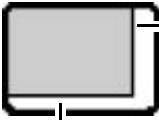
Microsoft® IntelliMouse™ Wheel Mode (Setting at the time of purchase)	Original Mode
<p>Wheel mode operations (almost identical to the case of using the Microsoft® IntelliMouse™ for scroll, zoom, etc., operations) are possible for Microsoft® wheel function-compatible applications.</p> <p>Microsoft® IntelliMouse™ is a mouse-type device that, in addition to the two conventional buttons, incorporates a wheel able to rotate forwards/backwards.</p>	<p>Only scroll operation is possible for applications not compatible with the Microsoft® wheel function.</p> <p>Even for applications compatible with the Microsoft® wheel function, there are cases where only vertical scrolling or only horizontal scrolling is possible in this mode.</p>
<p>Scrolling Area</p>  <p>For the Pan and Auto Scroll functions, the entire work surface of the touch pad can be used for scrolling.</p>	<p>Scrolling Area</p>  <p>Scrolling up/down Possible when a check mark ✓ is added for [Vertical].</p> <p>Scrolling side-to-side Possible when a check mark ✓ is added for [Horizontal].</p>

 : Typical mouse operations use this area.
When no check mark is added for [IntelliMouse Wheel mode], [Horizontal] and [Vertical] of [Scroll Configuration], the entire surface can be used for typical mouse operations.

NOTE

When you are not sure whether an application is compatible with the Microsoft® wheel function or not, try using both modes. Furthermore, depending on the application, there are cases where scrolling may not be possible with either mode.

● Changing the mode of the touch pad

- 1 Select  from the taskbar and then select [Motion] or select [Motion] in [Start] - [Settings] - [Control Panel] - [Mouse].
- 2 ● To set the Microsoft® IntelliMouse™ Wheel mode
Add the check mark ✓ for [IntelliMouse Wheel mode] of [Scroll Configuration].
● To set the original mode
Delete the check mark for [IntelliMouse Wheel mode] of [Scroll Configuration] and add the check mark ✓ for [Horizontal] and/or [Vertical] .
- 3 Press [OK].

NOTE

The touch pad has been designed to work only when a finger is used. Therefore, do not use any implement on the touch pad.

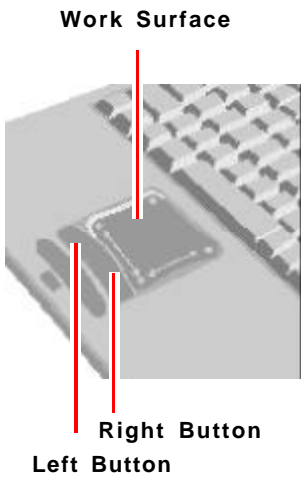

Wheel Indicates an operation applicable to the Microsoft® IntelliMouse™ Wheel mode.

Original Indicates an operation applicable to the original mode.

Basic Operation

Function	Touch Pad Operation
Moving the Cursor Wheel Original	<p>Move the tip of your finger lightly over the surface.</p>
Tapping/Clicking Wheel Original	tapping or clicking
Double-Tapping/Double-Clicking Wheel Original	double-tapping or double-clicking
Dragging Wheel Original	 or <p>Two quick taps, but on the second tap leaving your finger down (applying pressure) and moving it on the work surface. While holding down the button, moving your finger on the work surface.</p> <p>● When a check mark is added for [Drag Lock] *</p> <p>After the drag operation (above : left side), it is necessary to determine the destination (i.e., location of drop) by one tap. Under the condition no destination is selected, do not use the suspend or hibernation function. Nothing is shown on the display, even after resuming from the suspend or hibernation mode. In this case, the display will return after a tap or click is made.</p>
Scroll* Wheel Original <p>Scroll a document (rotate the wheel)</p>	Wheel Original
Auto Scroll* Wheel <p>Automatically scroll a document (move the mouse after clicking the wheel)</p>	① ② <p>Operate after pressing the two buttons simultaneously.</p> <p>● When releasing the auto scroll function: One tap on the work surface.</p>

* In [Start] - [Settings] - [Control Panel] - [Mouse] - [Tap and Buttons]

(To next page)

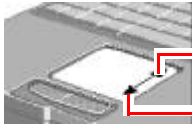
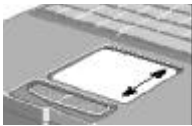
Function	Touch Pad Operation
Pan* (Wheel) Scroll in various directions of a document (move the mouse slightly while holding down the wheel)	 <p>Operate while holding down the two buttons.</p>
Zoom* (Wheel) Magnify/reduce the display of a document. (rotate the wheel while holding down Ctrl)	Ctrl +  <p>Magnify Reduce</p>
Data Zoom* (Wheel) Display or hide a document, or perform operations to return to or proceed with Internet Explorer. (rotate the wheel while holding down Shift)	Shift + 

Within the parentheses () are operations to follow when using an external Microsoft® IntelliMouse™.

* Indicates that the movements will differ depending on the application.

CAUTION

- When an external mouse or trackball with additional functions (e.g., wheel function) is connected, a part or all of the additional functions may fail to operate. To use these additional functions, install the driver or application software of the external device by following the procedure below. However, once the driver or application software is installed, touch pad functions (e.g., auto scroll) may not operate even if the touch pad is enabled (see the procedure for “When you want to re-enable the touch pad.”).

- 1 In [Control Panel] - [System] - [Device Manager], select [touch pad] in [Mouse], press [Remove] to delete it, then press [OK] to confirm the deletion.
- 2 Power off your computer and connect the external mouse or trackball device to the computer.
- 3 Turn the power on and run the Setup Utility (☛ page 37). In [Main] menu, set [Touch Pad] to [Disable] and close the Setup Utility.
- 4 Following the operating instructions for the connected external mouse, install the necessary driver.

After the installation, set [Touch Pad] to [Disable] in the Setup Utility.

Do not enter the suspend or hibernation mode when an external mouse is connected to the serial port.

When you want to re-enable the touch pad;

- 1 In [Control Panel] - [System] - [Device Manager], when an external mouse or trackball device is displayed in [Mouse], press [Remove] to delete it, and then press [OK] to confirm the deletion.
- 2 Power off your computer and remove the external mouse or trackball device.
- 3 Turn the power on and run the Setup Utility (☛ page 37). In [Main] menu, set [Touch Pad] to [Enable] and close the Setup Utility.
- 4 Confirm whether [touch pad] exists in [Mouse] (in [Control Panel] - [System] - [Device Manager]).

(To next page)

CAUTION

When [PS/2 Compatible Mouse Port] is displayed in [Mouse]:

- 1 Select [PS/2 Compatible Mouse Port] and then press [Properties].
- 2 Select [Driver] - [Update Driver] and then press [Next].
- 3 Select [Display a list of all the drivers....] and then press [Next].
- 4 Press [Next].
- 5 At the [Update Driver Warning], press [Yes] and then press [Next].
- 6 At the [Insert Disk], press [OK].
- 7 Input [c:\util\drivers\mouse] and then press [OK].
- 8 Press [Finish].
- 9 The display will ask you to restart Windows, press [Yes].

NOTE

The double-tapping speed of the touch pad cannot be changed.

Handling the Touch Pad

- When using a key combination such as **Fn** + **F5**, do not touch the touch pad. If a key combination is used while the pad is being touched, the function of the key combination will not work. In addition, it is possible that control of the cursor will be lost and the cursor will not show proper movements. In such cases, the computer has to be restarted by using the keyboard (e.g., ).
- Do not place any object on the work surface or press down forcefully with sharp-pointed objects (i.e. nails), hard objects that can leave marks (i.e. pencils and ball point pen).
- Do not allow things that could dirty the touch pad, such as oil. The cursor may not work properly in such cases.
- When the touch pad becomes dirty:
Wipe to remove dirty areas by using a dry soft cloth such as gauze or a soft cloth first applied with detergent diluted with water and then thoroughly wrung.
Do not use benzene or thinner, or disinfectant-type alcohol.

Your computer is equipped with a touchscreen display allowing you to perform the same operations as the touch pad or mouse by touching the surface of the display with your finger. (The following explanation gives one example (for the default settings). The operation settings can be changed in [Start] - [Programs] - [Updd] - [Settings].)

● Moving the cursor

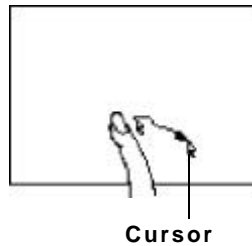

● Clicking

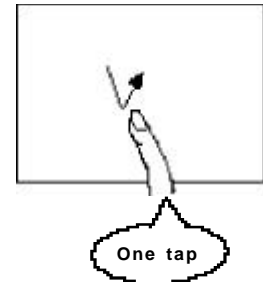

● Double-clicking

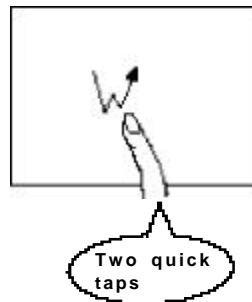

● Dragging

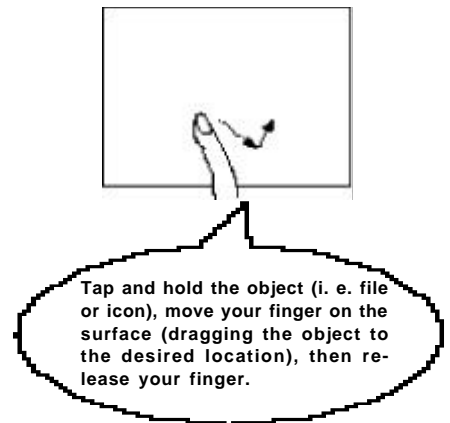

CAUTION

- The touchscreen function can not be used in the MS-DOS mode and when using the full screen in [MS-DOS prompt].
- When the operation of panning (only LCD) is performed while the screen resolution is set to [1024 x 768 dots], the touchscreen function will not work properly.
- If a change is made to the screen resolution, or the cursor can not be pointed correctly with your finger, be sure to perform [Calibrate].  page 11

Handling the Touchscreen

- Do not place any object on the surface or press down forcefully with sharp-pointed objects (i.e. nails), hard objects that can leave marks (i.e. pencils and ball point pen).
- Do not apply pressure within 5 mm of the perimeter of the display panel. The cursor may move to the edge of the display.
- Do not operate the computer when such things as dust are on the screen. Do not allow contact with substances that could dirty the touchscreen, such as oil. The cursor may not work properly in such cases.
- When the touchscreen becomes dirty:
Wipe to remove dirty areas by using a dry soft cloth such as a gauze or soft cloth first applied with detergent diluted with water and then thoroughly wrung.
Do not use benzene or thinner, or disinfectant-type alcohol.

(To next page)

Configuring the Touchscreen

When needed, the touchscreen can be configured using the following steps.

1 Select from the taskbar or select [Settings] from [Start] - [Programs] - [Updd]

The following screen will appear.

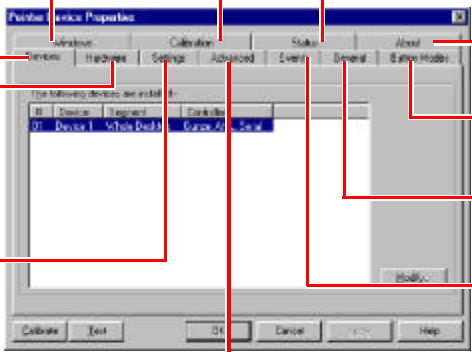

Windows
Set the "double-click" settings.

Devices
Configure the device controller.

Hardware
Set the hardware resources. Match this setting with the setting for [Touchscreen] in the Setup Utility.

Settings
Set the general protocol settings.

Calibration
Define the calibration setup. Use when the cursor can not be pointed correctly with your finger. (Needed if the alignment of the touchscreen with the visual image change or adjust the display resolution).

Status
Display the status of the controller.

About
Display the version number.

Button Modes
Set the button modes.

General
Set the general settings and functions.

Events
Set the events that can be generated by a controller.

Advanced
Set the advanced settings.

NOTE

For more information, refer to [Help].

2 Make necessary changes

3 Click [OK]

NOTE

- It is also possible to change the double-click speed in [Tap and Buttons] for [Start] - [Settings] - [Control Panel] - [Mouse]. However, when [Double Click Speed] in [Mouse] is changed, the double click time in [Windows] is also changed. In addition, the setting becomes the setting for [Tap and Buttons] in [Mouse] after the computer is restarted or enters the suspend or hibernation mode.  page 13
- Immediately run [Calibrate] when the number of points of calibration is changed.

Drawing Characters or Figures

Simple characters and figures like signatures and arrows can be made by using the work surface of the touchscreen, and can be saved to a file as a bitmap (.bmp) format.

CAUTION

- To draw, an object with a rounded tip (e.g., a pen for tablets) can be used. Do not use any of the following objects, as they may damage the work surface.
 - Objects with an extremely sharp tip, like screwdrivers and nails.
 - Objects that leave marks, like ball point pens.
- Panasonic Hand Writing does not operate properly when the Touchscreen cannot be used.

1 Select  from the taskbar or select [Panasonic Hand Writing] from [Start] - [Programs] - [Panasonic]

2 Draw a character or figure using the work surface of the touchscreen

NOTE

Data can be copied to the clipboard with [Edit] - [Copy]. Copied data can be added to other applications that support the bitmap format by using the paste function. Pasting is not possible to applications that do not support the bitmap format.

CAUTION

Do not perform a drag operation by the Touch Pad or the external mouse as the movement will be input on the display.

3 Select [Save As] or [Save] from [File]

NOTE

The file size of a bitmap image to be saved or pasted to another application can be changed with [Option] - [Window size].

CAUTION

Drawing accuracy may be degraded if another application, such as FD accessing, is being executed simultaneously. Begin drawing only after other applications have been closed.

Starting Up Your Computer Quickly







If you want to immediately start up and continue an application after shutting down your computer, you can do so by using the suspend or hibernation function.

● Differences between the suspend and hibernation functions

Function	Suspend function	Hibernation function
Where data is saved to	Memory	Hard disk
Speed	Fast	Somewhat slow
Requires power supply	Yes (if power is cut, all data is lost)	Power not required to maintain data

Setting the Suspend or Hibernation Function

[Hibernation] is factory set.

- 1 Run the Setup Utility (📖 page 37)
- 2 Using  and , select [Power]
- 3 Using  and , select [Power Switch] and press **Enter**
- 4 Using  and , select [Suspend] or [Hibernation] and press **Enter**
- 5 Press **F10**, then select [Yes]

NOTE

The Suspend or Hibernation function can be set even with [Panel Switch] in the Setup Utility. (📖 page 41)

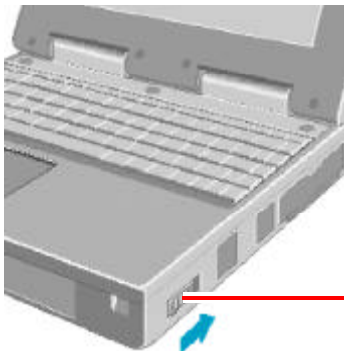

Shutting Down Using the Suspend or Hibernation Function

The computer should be set for suspend or hibernation (📖 see the above procedure).

Slide the power switch



(After releasing your finger from the power switch, do not touch the power switch, keyboard or mouse while the computer is entering in the suspend or hibernation modes.)

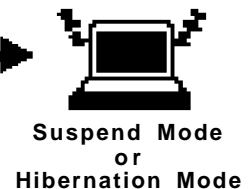

CAUTION

- At the "beep*" sound, release your finger from the power switch. If you continue to slide the switch and hold it for more than four seconds, the power will go off. Data not previously saved will be lost. Slide the power switch to power on.
- If the computer will not be operated for an extended period of time, it is recommended that hibernation mode be used instead of the suspend mode.

* When the speaker function is disabled, e.g., by setting [Disable] for [Speaker] with the Setup Utility (📖 page 38) or by the key combination **(Fn) + (F4)**, there will be no beep sound.

(To next page)

NOTE

With the method below, you can shut down the computer by using the suspend function.

- **Fn** + **F7** ( page 4)
- Select [Suspend] from the [Start] menu.

[Suspend] is deleted from the [Start] menu by unchecking [Allow Windows to manage power use on this computer.] in [Start] - [Settings] - [Control Panel] - [Power] or by unchecking [Show suspend command on Start menu] in [Advanced].

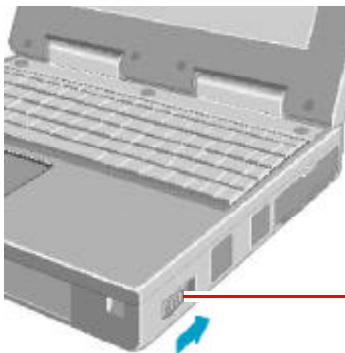

Resuming Operation

Slide the power switch

If the security indicator () is displayed, your password has been set.

CAUTION

- After the display returns, the computer needs a short period of time to reinitialize. This takes about 15 seconds. Do not shut down or restart Windows, or use the suspend or hibernation functions again during this time, as this may subsequently cause Windows to operate abnormally.
- Do not install or remove peripherals while your computer is in the suspend or hibernation mode; abnormal operation may result.
- When operation resumes, serial devices such as a mouse, modem or PC Cards may not function properly. In such cases, you will need to restart your computer or reinitialize the individual devices.

(To next page)

Precautions for Using the Suspend or Hibernation Function

- Save all data before powering off your computer.
- When restarting from or shutting down to the suspend or hibernation mode, do not touch the touch pad or touchscreen (or move the mouse (serial or PS/2 type) if one is connected). These devices may fail to operate, you will then need to restart your computer using the keyboard.
- Do not enter the suspend/hibernation mode during the following periods (you may corrupt your data or file):
 - While the floppy disk drive being accessed or HDD indicator (🔌) is on.
 - While playing/recording audio files.
 - While communications software is being used.
- Do not use the suspend or hibernation function when using an operating system other than the one that comes with your computer, the Setup Utility, or when experiencing static electricity or noise.
- If you hold down on the **Alt** , **Ctrl** or **Shift** key to enter the suspend or hibernation mode, after resuming operation, you must press the same key. For example, if you hold down on the **Shift** key while pushing the power switch, upon resuming, if you do not press the **Shift** key again, only capital letters will result from typing.
- Only when the computer stops operating or locks up should the power switch be held more than four seconds to power off the computer. Slide the power switch to power on and data not previously saved will be lost.
- In the suspend mode, power is consumed. If PC Cards (e.g., a modem card) are inserted, more of that power may be consumed. When all power has been consumed, all data at suspend is lost since it is retained in memory. We therefore recommend plugging in the AC adapter when using the suspend function.
- Repeatedly using the suspend or hibernation function will use up a lot of the system resources and the computer may not work properly. Shut down Windows ([Start]-[Shut Down]) on a regular basis, i.e. approximately once a week, without using the suspend or hibernation function. Doing so will restore the system resources.
- Do not use the suspend or hibernation function during the following periods. The suspend or hibernation function, or peripherals may not work.
 - When a file in devices such as a CD-ROM drive, external hard disk, or ATA card is opened, the suspend or hibernation function may not work. In such cases, close the file.
 - SCSI cards may not recover after entering the suspend or hibernation mode. If this occurs, restart the computer.
- After a Windows 95 USB device driver has been installed, do not use the suspend or hibernation function. If the suspend or hibernation mode is activated, the computer may not function properly. Power off, then on, using the power switch to resume proper operation.

If you want to use the suspend or hibernation function after the USB driver is installed, disable the USB device function of the computer by following the procedure below.



1 In [Start] - [Settings] - [Control Panel] - [System] - [Device Manager], select [Intel(r) 82440MX PCI to USB Universal Host Controller] in [Universal serial bus controller].

2 Add the check mark for [Disable in this hardware profile] in [Properties] - [General], press [OK], and then press [Close].

3 In [Start] - [Shut Down], select [Restart], then press [OK].

If you want to enable the USB device function again, delete the check mark for [Disable in this hardware profile] in step **2**. When the message appears asking whether to reboot the computer, select [Yes]. If the message is not displayed, go to step **3**.

To prevent unauthorized access of your computer, the various security measures are provided below.

Situation	Function to use	Reference
You do not want your computer to be used without permission	Supervisor Password User Password	 below
You want to prevent theft of your computer	User Security lock	 "Names and Functions of Parts"

When you do not want your computer to be used without permission

You can set your "Supervisor Password" and "User Password" (The User Password can only be set when the Supervisor Password has been set). Without the password, access to your computer is impossible.

● Starting up when the password is set

Upon entering your Supervisor Password or User Password and pressing **Enter** .

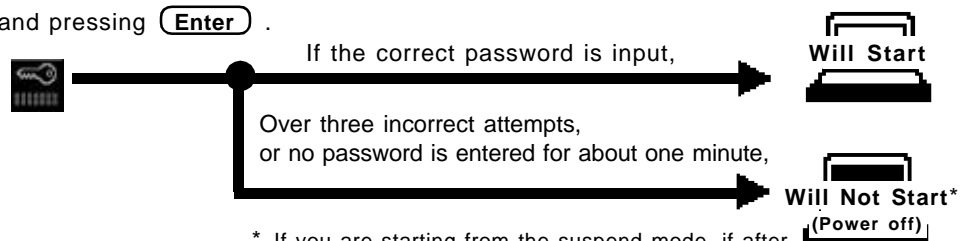

* If you are starting from the suspend mode, if after three attempts the correct password is not input, or if no password is entered for about a minute, the computer returns to the suspend mode.

● If entering the Setup Utility with Supervisor Password

You can register all items of the Setup Utility ( page 37).













● If entering the Setup Utility with User Password

- You can not register [Advanced] menu and some items in [Security] menu.
- When [User Password Protection] has been set to [Protected], you can not register the User Password.
When [User Password Protection] has been set to [No Protection], you can register the User Password ( page 40).



(To next page)

Setting the Supervisor Password

(enabling, changing, disabling)







- 1 Run the Setup Utility ( page 37)
- 2 Using  and  , select [Security]
- 3 Using  and  , select [Set Supervisor Password], then press 
- 4 <Only when the Supervisor Password has been set>
Enter your password at the [Enter Current Password], then press 
- 5 Enter your password at the [Enter New Password], then press 
- To disable the Supervisor Password
Simply press 
- 6 Re-enter your password at the [Confirm New Password] , then press 
- To disable the Supervisor Password
Simply press 
- 7 At the [Setup Notice], press 
- 8 Press  , then select [Yes]

CAUTION

- Your password will not be displayed on the screen.
- Please limit your password to seven characters. Note that there is no distinction between upper and lower case letters.
- White colored keys can be used. Note that the space bar and function keys cannot be used.
- Do not input your password while holding down on  or  .
- Use only the upper horizontal row of numeric keys to input your user password.
- Do not forget your password. If a password is forgotten you will be unable to use your computer. Please contact Panasonic Technical Support.
- When running the Setup Utility, do not leave your computer even for a short time.

NOTE

When you do not want the User Password enabled, changed, or disabled without permission,

- using  and  , select [User Password Protection] and press 
- using  and  , select [Protected] and press .

(To next page)

Setting the user password (enabling, changing, disabling)

1 Run the Setup Utility (🔧 page 37)

NOTE

Set the Supervisor Password if you have not done so. (🔧 page 17)

2 Using  and , select [Security]

3 Using  and , select [Set User Password], then press 

4 <Only when the User Password has been set>
Enter your password at the [Enter Current Password], then press 

5 Enter your password at the [Enter New Password], then press 

● To disable the User Password

Simply press 

6 Re-enter your password at the [Confirm New Password], then press 



● To disable the User Password

Simply press 

7 At the [Setup Notice], press 

8 Press , then select [Yes]

CAUTION

- Your password will not be displayed on the screen.
- Please limit your password to seven characters. Note that there is no distinction between upper and lower case letters.
- White colored keys can be used. Note that the space bar and function keys cannot be used.
- Do not input your password while holding down on  or .
- Use only the upper horizontal row of numeric keys to input your user password.
- Do not forget your password. If a password is forgotten, you will be unable to use your computer. Please contact Panasonic Technical Support.

To prevent the changing of your password without permission

- When running the Setup Utility, do not leave your computer even for a short time.
- Set the User Password Protection option (🔧 page 17).

(To next page)

Conserving Power



One of the main features of notebook-type computers is that you have the power of computing away from your home or office. In the following, information is provided on how to maximize use of the battery pack which is necessary for such computing.

● Four Important Points

- POINT 1** Be sure to charge your battery before and after use.
- POINT 2** To get the maximum use of your battery, set the power management mode.
- POINT 3** Check to see that you have your AC adapter with you before leaving your home or office.
Purchasing a spare battery (CF-VZSU15) is highly recommended.
- POINT 4** Always watch your battery level!

Things to Remember

● Leave your computer off when it is not in use

  "Starting Up/Shutting Down")

● Adjust the brightness (dark) with **Fn** + **F1**

By repeatedly pressing the keys to minimize the brightness ( will be displayed), thereby lowering the power consumption.

● Before stepping away from your computer, press **Fn** + **F10** to put your computer in the ECO mode

The ECO mode helps you conserve power by cutting off power to the LCD and turning off the hard disk motor. To resume, you may press a key unrelated to the direct triggering of a selection, like **Ctrl** key.

● Setting the timeout function (page 20)

The ECO mode / suspend or hibernation function ( page 13) allow you to save power by automatically cutting off power when the computer is idle or there is no access to individual devices.













It should be noted that for some applications, the suspend/hibernation timeout will not work properly.

NOTE

If you plan to use only the battery pack or set the power management, it is necessary to check  [Allow Windows to manage power use on this computer] in [Start] - [Settings] - [Control Panel] - [Power].

If the check is removed, the time may not be displayed properly when operation is resumed from the suspend or hibernation mode or the operating time with the battery pack may become short (the power management function of Windows does not work).

Setting Timeout Function

- 1 Run the Setup Utility ( page 37)
- 2 Using  and , select [Power]
- 3 Using  and , select [Power Switch] and press **Enter**
- 4 Using  and , select either [Suspend] or [Hibernation] and press **Enter**
- 5 Using  and , select either [Battery Operation] or [AC Adapter] and press **Enter**
- 6 Using  and , select either [ECO mode Timeout] or [Hibernation Timeout] (or [Suspend Timeout]) and press **Enter**
- 7 Using  and , select the timeout setting and press **Enter**
- 8 Press **F10**, then select [Yes]

NOTE

- When [ECO Mode Timeout] and [Suspend/Hibernation Timeout] are set to [Disable] in the Setup Utility, **Fn** + **F8** does not work.
- Even when a CD-ROM is running, the computer enters the ECO Mode with the ECO Mode Timeout.

CAUTION

When installed in a network environment.

Be sure to disable the suspend/hibernation timeout settings with the Setup Utility. After resuming operation from the suspend or hibernation mode, the network connection may be severed or the computer will not work properly.

When a device like a high-speed modem or ISDN terminal adapter is connected to the serial port, etc.

There are times when high-speed communication is adversely affected if the power management function is enabled. Please confirm that  is displayed by pressing **Fn** + **F8** to disable the power management function. After you have finished using a communications device, you can enable the power management function by pressing **Fn** + **F8**.

Key operation and music playback.

When the power management function is running, you may feel that keyboard, touch pad, or touchscreen (or mouse) operations are sluggish. Furthermore, music may not be played back correctly when entering the ECO mode during playback.

Battery Status

Use the Battery Indicator to check the battery status

Battery Indicator	Battery Status
Orange*	Charging
Green*	Fully-charged
Red	Battery charge is low (the charge is less than approx. 9% capacity)
Blinking red*	Battery pack or charger may not be working properly. Quickly remove the battery pack and disconnect the AC adapter, then connect them again. If the problem persists, contact Panasonic Technical Support.
Blinking orange	Battery capacity being refreshed.
Blinking orange five times after the AC adapter is connected*	Unable to recharge due to violation of temperature limits. (The ambient temperature is outside the allowable range. Once the allowable range requirement is satisfied, charging begins automatically.)
Not lit	Battery pack is not connected or charging not being performed.

* When the AC adapter is connected.

NOTE

This computer prevents overcharging of the battery by recharging only when the remaining power is less than approx. 95% of capacity after the battery is fully charged.

● Getting a detailed reading

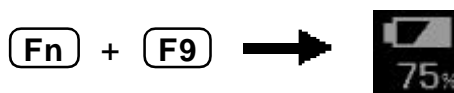

NOTE

- The actual remaining battery capacity and the displayed indication may differ.

• The battery indicator light remains red.
• The battery remaining displays 99% and the indicator light is orange for a long period of time.

➔ Perform the Battery Capacity refresh utility. (page 24)

Low battery warning appears after a short period of time. This may be caused by the use of suspend mode for long periods of time. The battery is discharging while the computer is in suspend mode when the AC adapter is not connected.

➔ Completely discharge the battery (reaches 0%).

- When the battery pack is not in the computer,  is displayed.

When the remaining battery charge becomes low

Save your data and power off your computer

Following that:

- Plug in the AC adapter, and fully charge your battery.
- Use a spare battery if you have one.
- If you have neither the AC adapter nor an extra battery, power the computer off.

● If the suspend or hibernation function is set

Red indicator lights
Beep sounds**
(at approx. 9% capacity)



Suspend Mode or Hibernation Mode
(at approx. 4% capacity)

● If the suspend or hibernation function is not set

Red indicator lights
(at approx. 9% capacity)

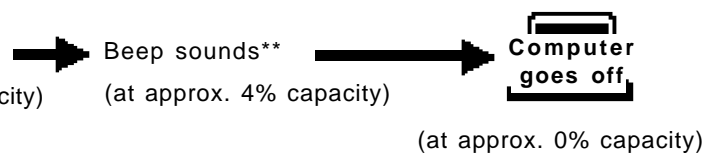

Beep sounds**
(at approx. 4% capacity)

Computer goes off
(at approx. 0% capacity)

** When disabling the speakers with the Setup Utility (or pressing **Fn** + **F4**), the warning beep is also disabled.

Panasonic Battery Monitor

It is possible to display the current battery status and the remaining battery power by running the Panasonic Battery Monitor.

- 1 Select  from the taskbar or select [Panasonic Battery Monitor] from [Start]-[Program]-[Panasonic].

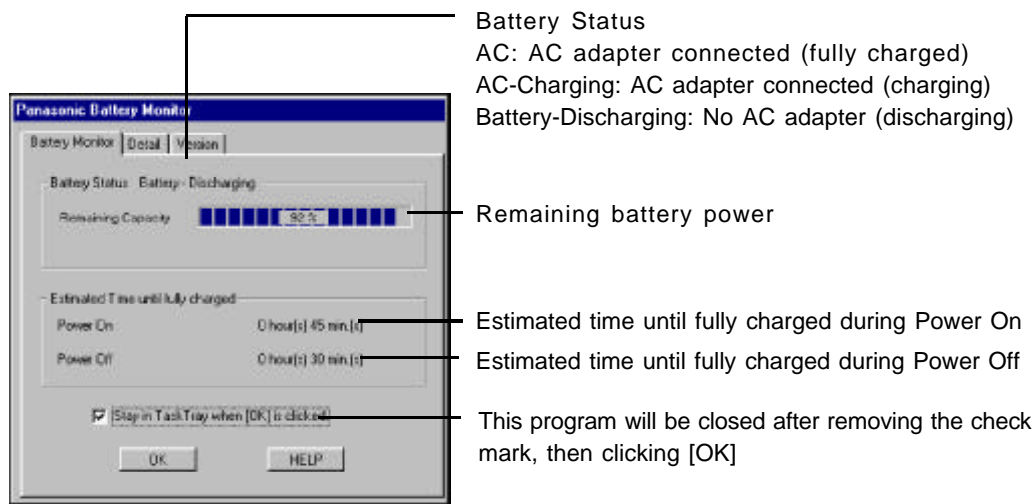

- 2 Click [Detail]

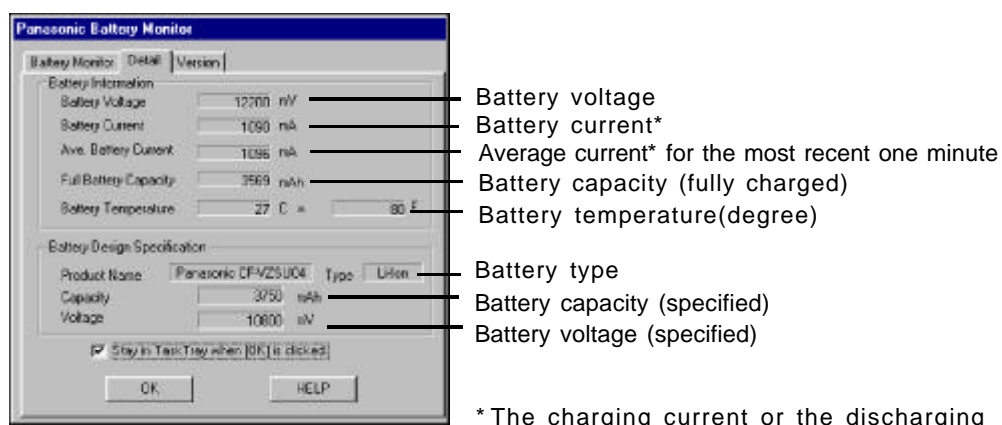

* The charging current or the discharging current is displayed.

NOTE

- The deviations for the estimated time can occur depending on the condition of the battery.
- There are cases [0] (indicating a full charge) may be shown for the [Estimated Time until fully charged] even if the remaining battery power is about 97% (e.g., when unplugging then plugging the AC adapter above 95%).

Accurately Displaying Battery Capacity

The battery pack has a function for measuring, storing, and learning about battery capacity. Using this function properly to accurately display remaining battery capacity requires that the battery pack be fully charged (charged to 100%), then fully discharged, and then fully charged again.

Use the procedure presented below to fully charge the battery pack, then discharge it, then charge it again. This procedure should be performed once after you purchase the computer. As you use the battery pack over a long period of time, the remaining capacity display may become inaccurate due to aging of the battery pack and other factors. The procedure described below should be repeated.

1 Attach the battery pack, then connect the AC adapter

Remove all peripherals (except for the battery pack and AC adapter).

2 Once the battery indicator turns green, use the Battery Capacity refresh utility to fully discharge the battery pack

1 Choose [Start]-[Shut Down]-[Restart in MS-DOS mode], and then click [OK].

2 Type the following after the MS-DOS prompt (C:\WINDOWS>).

```
c:\windows\command\battref /g 
```

3 At the confirmation message, press .

The battery indicator blinks orange, the battery pack will be discharged fully and the computer will power off automatically.

CAUTION

When the above operation is performed, do not turn the computer off. Doing so will make it impossible to measure the battery capacity.

NOTE

When the Battery Capacity refresh utility starts, it will take approximately 2.5 hours until the computer powers off automatically.

3 Charge the battery pack until the battery indicator turns green (full charge)



(Charging commences automatically.)

Replacing the Battery Pack

When the charge provided by your battery pack is supplied for only a short period of time, even after fully charging according to the instructions, it may be time to replace your battery pack. The battery pack is a consumable item and therefore will require replacement (CF-VZSU15).

CAUTION

- Do not touch the terminals on the battery pack. The battery pack may no longer function properly if the contacts are dirty or damaged.
- The battery pack is not charged when the computer is first purchased. Be sure to charge it before using it for the first time. When the AC adapter is connected to the computer, charging begins automatically.
- Use only the specified battery pack (CF-VZSU15) with your computer.

1 Power off your computer (  "Starting Up/Shutting Down")
Do not shut down using the suspend mode.

2 Remove the cover

- 1 Turn your computer over.
- 2 Unlock the latch.
- 3 Open the cover.

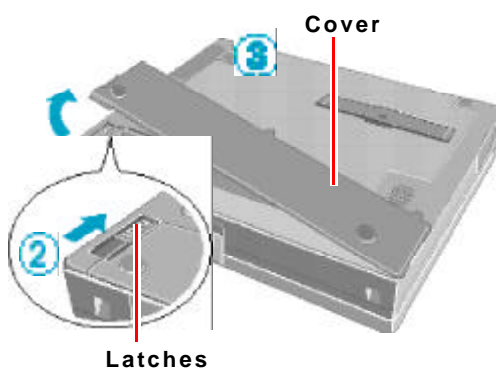

3 Remove the battery pack

Use the blue tab to lift the battery pack.

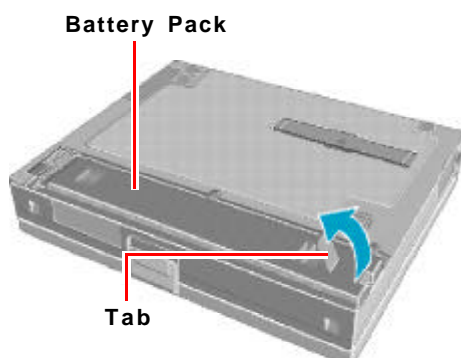

(To next page)

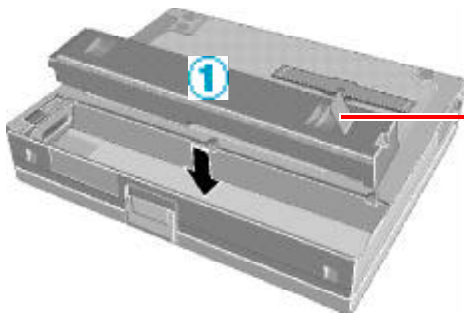

4 Put the battery pack

1 Use the blue tab to lower the battery pack into place.



2 Slide the battery pack inward until it is firmly in place.

CAUTION

Be sure the battery pack is properly connected to the connector.

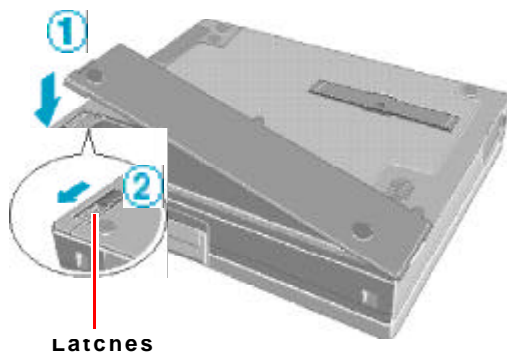

5 Put the cover back into place

1 Close the cover using the arrow as a guide.

2 Lock the latch into place.

CAUTION

Confirm that the latch lock is correctly in place. Should you decide to carry your computer without the latch lock in place, the cover may open causing the battery pack to fall out.

Latches

Your computer has one PC Card slot. This slot conforms to the PC Card Standard; therefore, communications and SCSI devices may be utilized. The slot allows you to use one Type I or Type II card.

CAUTION

- Please check the PC Cards' specifications. Be sure the total operating current does not exceed the specified limit. Damage may result otherwise.
Allowable Current : 3.3 V: 400 mA, 5 V: 400 mA
- ZV, SRAM and FLASH ROM (except for an ATA interface) cards are not supported.
- For the following cases, be sure the power has been turned off before proceeding.
 - When removing a network card
 - When replacing a CardBus type card with another card (including another CardBus type card)

Installing/Removing the PC Card

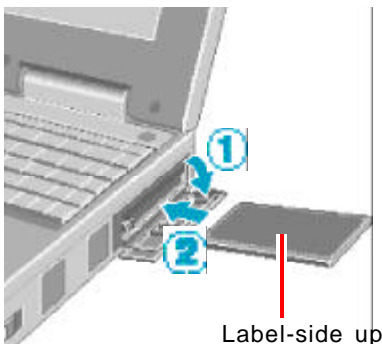

● Installing a PC Card

Simply slide the PC Card in until it snaps into place. Please refer to the manual for each card on how to install the card (insertion is typically label-side up).

CAUTION

When inserting a card, do not force the card in if difficulty is encountered. You may damage the slot, making it impossible to remove the card.

● Removing a PC Card

CAUTION

Do not remove a PC Card while your computer is in the suspend or hibernation mode.

- ① Go to [Socket Status] (in [Start] - [Settings] - [Control Panel] - [PC Card (PCMCIA)]), select the PC Card slot and press [Stop].
(When removing a PC Card after turning off the computer, this step ① is not need.)
- ② Press the button out, and then press the button again.
- ③ Slide the PC Card out.

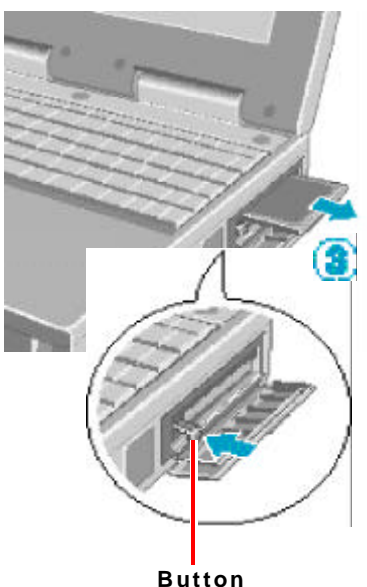

CAUTION

- Use a RAM module meeting the RAM module specifications below. If a module is used that does not meet the specifications, there are cases in which data may become unusable or the computer may not operate properly.
- RAM modules are extremely sensitive to static electricity. There are cases where static electricity generated by the human body has adversely affected such modules. In addition, it is easy to damage the RAM modules or internal components of the computer. Therefore, when installing or removing a RAM module, handle the module with extreme care.

Installing/Removing the RAM Module

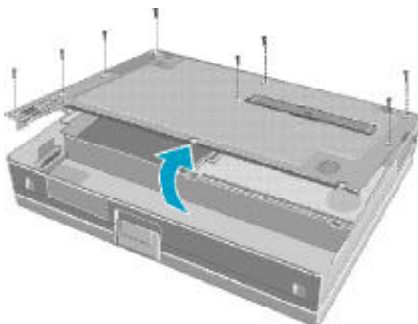

1 Power off your computer (🖥️ 📄 "Starting Up/Shutting Down")
Do not shut down using the suspend or hibernation mode.

2 Remove the battery pack (🖥️ page 25)

3 ● Remove the cover

Remove the nine screws with a screwdriver, and remove the bottom cover as shown in the illustration.

4 ● Installing the RAM module

1 Slide in the module at an angle.

2 Snap the module into place by pushing down on it.

RAM module specifications

144 pins, SO-DIMM, 3.3 V, SDRAM

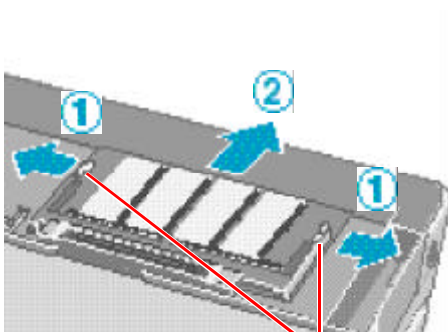
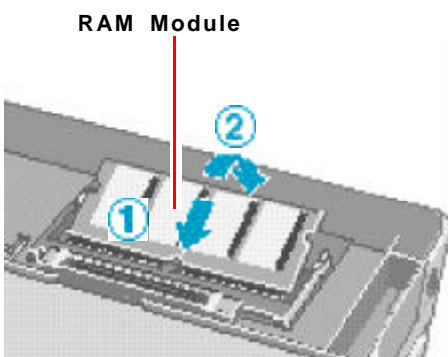

Hooks

● Removing the RAM module



1 Open the left and right hooks.

2 Gently remove the RAM module from the slot.

5 Put the cover back into place



External Display Port

- 1 Power off your computer** (  "Starting Up/Shutting Down")
Do not shut down using the suspend or hibernation mode.

- 2 Connect the external display to your computer**







NOTE

For more detailed information, please refer to the operation manual of the external display.

- 3 Turn on the external display, then turn on your computer**

You can select either an external display, LCD or simultaneous with **(Fn) + (F3)**.

In addition, you can set the display to use during start-up with the following procedure.

- 1 Run the Setup Utility. ( page 37)
- 2 Using  and , select [Main].
- 3 Using  and , select [Display] and press **(Enter)**.
- 4 Using  and , select the display to use and press **(Enter)**.
- 5 Press **(F10)**, then select [Yes].

- 6 Select your external display.

Set your external display for [Monitor] in [Start] - [Settings] - [Control Panel] - [Display] - [Settings] - [Advanced Properties].

When a monitor that does not conform to the Plug & Play standards is connected, select [Change] and make the monitor settings.

CAUTION

After a driver has been installed, do not use the suspend or hibernation function. If the suspend or hibernation mode is activated, the computer may not function properly. Power off, then on, using the power switch to resume proper operation.















If you want to use the suspend or hibernation function when the USB driver is installed, disable the USB device function of the computer.

Installing USB Devices



USB Port

1 Set the power management function to disable

- 1 Run the Setup Utility. ( page 37)
- 2 Using  and , select [Power].
- 3 Using  and , select [Power Switch] and press **Enter**.
- 4 Using  and , select [Power Off] and press **Enter**.
- 5 Using  and , select [Panel Switch] and press **Enter**.
- 6 Using  and , select [LCD Off] and press **Enter**.
- 7 Using  and , select [Fn+F7/Fn+F10] and press **Enter**.
- 8 Using  and , select [Disable] and press **Enter**.
- 9 Press **F10**, then select [Yes].

2 Install the Windows 95 USB device drivers



- 1 In [Start] - [Run], input [c:\util\msupdate\usb\usbsupp.exe], then press [OK]. At the confirmation message, press [Yes].
- 2 Read the [END-USER LICENSING AGREEMENT] and press [Yes] or [No].
 - Installation will start if [Yes] is pressed.
 - Installation will be aborted if [No] is pressed.
- 3 At the display indicating the completion of installation, press [OK]. The computer will automatically restart.
- 4 In [Start] - [Run], input [c:\util\msupdate\usb\usbcopy.bat], then press [OK].
- 5 Click at the upper right corner to close the display.
- 6 In [Start] - [Settings] - [Control Panel] - [System] - [Device Manager], select [PCI Universal Serial Bus] in [Other devices], press [Remove], then press [OK].
- 7 Press [Refresh] and press [Close] at the [System Properties],
- 8 Restart the computer.

(To next page)

NOTE

Execute the following steps if the operation of a USB device is unstable. When the steps below are implemented, however, faults such as Windows being unable to shut down exist when the USB HUB remains connected. (In such cases, remove the USB HUB.)

- 1 In [Start] - [Run], input [c:\util\msupdate\usb\usbupd2.exe], then press [OK].
- 2 When the [Version Conflict] appears, select [Yes].
- 3 In [Start] - [Shut Down], select [Restart], then press [OK].
- 4 In [Start] - [Run], input [c:\util\msupdate\usb\usbcopy.bat], then press [OK].
- 5 Click  at the upper right corner to close the display.
- 6 In [Start] - [Settings] - [Control Panel] - [System] - [Device Manager], select [Intel(r) 82440 MX USB Universal Host Controller] in [Universal serial bus controller], press [Remove], then press [OK].
- 7 Press [Refresh] and press [Close] at the [System Properties],
- 8 In [Start] - [Shut Down], select [Restart], then press [OK].

- 3 **Power off your computer**   "Starting Up/Shutting Down"
Do not shut down using the suspend or hibernation mode.

- 4 **Connect the USB device to your computer**

NOTE

For more detailed information, please refer to the operation manual that accompanies the USB device.

- 5 **Turn on the USB device, then turn on your computer**

NOTE

You may need to install drivers for your USB devices, simply follow the on-screen instructions and refer to the operation manual that accompanies the USB device.

Removing USB Devices

- 1 **Power off your computer and the USB device**
Do not shut down using the suspend or hibernation mode.

- 2 **Remove the USB device**

NOTE

<Removing the Windows 95 USB device drivers>

- 1 In [Start] - [Settings] - [Control Panel] - [Add/Remove Programs] - [Install/Uninstall], select [USB Supplement to OSR2], then press [Add/Remove].
- 2 The display will ask you to restart Windows, then select [Yes].

Connecting to a telephone line and settings



Modem Port

1 Connecting a telephone line to the internal modem

It is not possible to connect the internal modem to any of the following lines.

- Internal home phones
- Intercoms

CAUTION

Do not use the PBX internal phone lines installed in company offices. Doing so may lead to a fire or electric shock.

NOTE

There are cases telephone construction (or installation) work will be necessary depending on the shape of the connector of the telephone line.

2 Select [Dialing Properties] in [Start] - [Settings] - [Control Panel] - [Modems]

Input the necessary information (items such as the phone system) and then press [Close].



3 Performing the "Country" setting for the modem

In [Start] - [Run], input [c:\util\drivers\modem\telsel.exe] and then press [OK]. Next, set the country the modem is to be used in.

CAUTION

There are cases the modem will not work properly when this setting is incorrect.

Be sure to make separate settings to connect to network services like the Internet or to use e-mail.

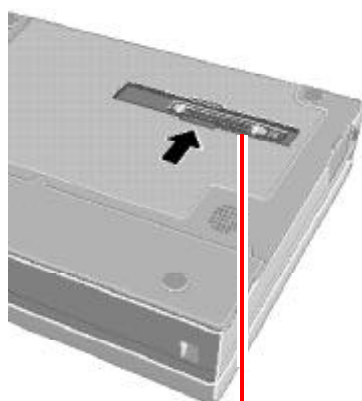

Expansion Bus Connector

A port replicator is available as an option (CF-VEB341). This device eliminates the hassles of having you connect/disconnect the various cables when carrying your computer around and allows a variety of peripherals to be connected including a head-phone or microphone, etc.

The port replicator connects to the expansion bus connector on the back of your computer.

For more detailed information, please refer to the operation manual of the port replicator.

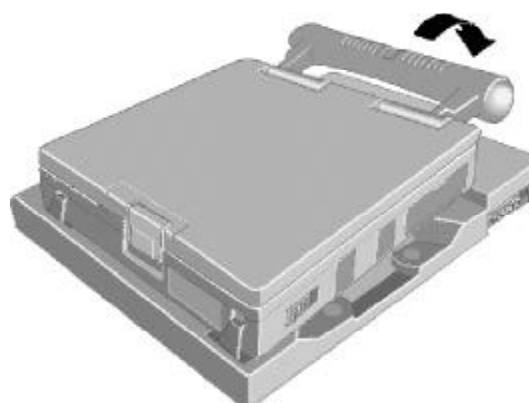
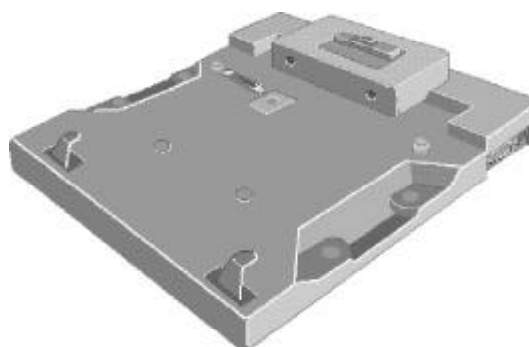

Handle



A handle is available as an option (CF-VSH341).
The handle can be used as a tilt stand as shown in the illustration.

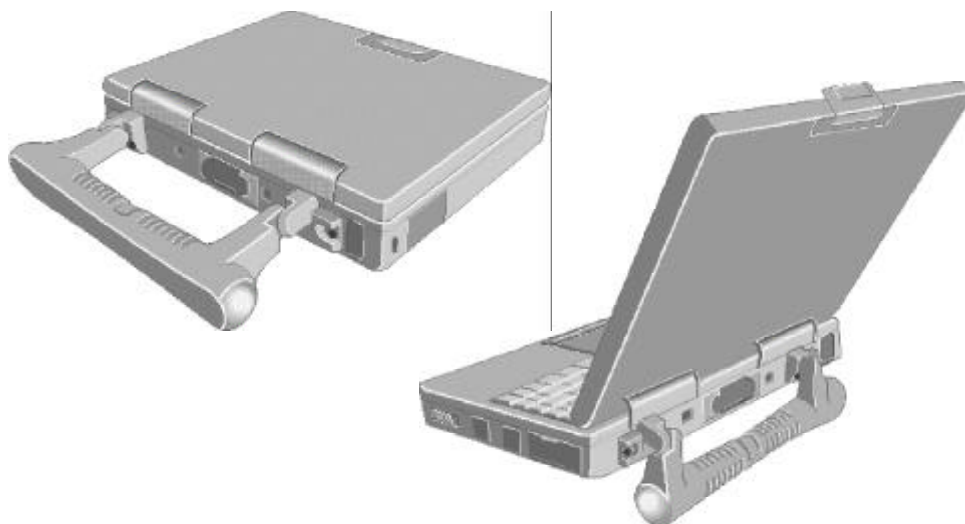

Hand-grip Belt and Shoulder Strap



A hand-grip belt and shoulder strap are available as an option (CF-VSS341).
The hand-grip belt is convenient for computing while standing.

Adjust the length of the belt so that the computer does not fall by mistake, and firmly hold the computer when using it.

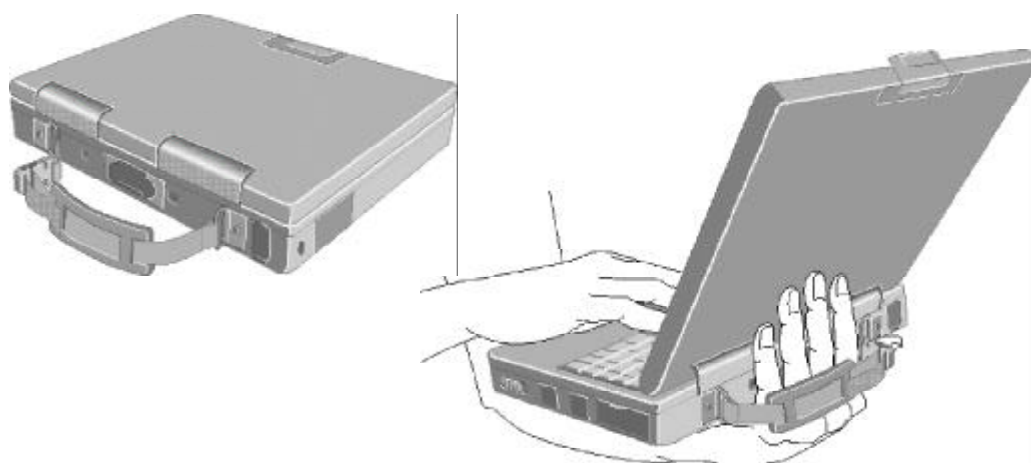

For mobile computing, a shoulder strap can be attached to the hand-grip belt.

To change your hard disk drive, contact **Panasonic Technical Support**

CAUTION

To customers:

- To change your hard disk, contact Panasonic Technical Support.
- Be sure to back up all important data before the change.

To technicians (at Panasonic Technical Support):

Be careful when replacing the hard disk. The hard disk is extremely sensitive to shock. In addition, static electricity could later affect some internal components. Do not put pressure on the top surface of the hard disk drive. When handling the drive, hold the drive from the side.

Installing/Removing the hard disk

(For technicians at Panasonic Technical Support)

1 Power off your computer (  "Starting Up/Shutting Down")

Do not shut down using the suspend or hibernation mode.

2 Remove the battery pack ( page 25)

3 Remove the cover

① Remove the nine screws with a screwdriver, and remove the bottom cover as shown in the illustration.

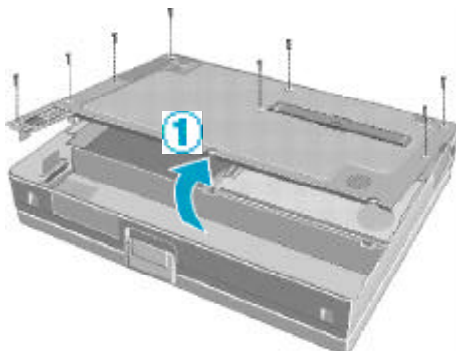

② Lift the panel to which the speaker is attached, as shown in the illustration, and flip it over.

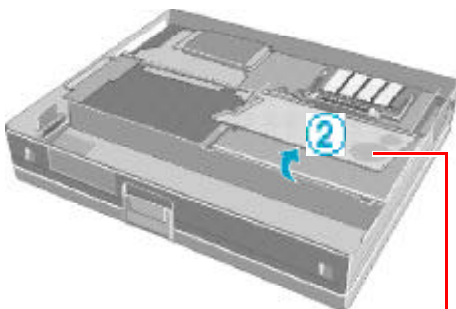

Speaker

(To next page)

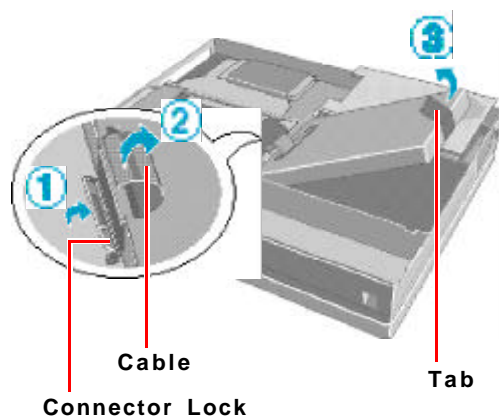

4 ● Remove the hard disk

- 1 Unlock the connector lock.
- 2 Remove the cable.
- 3 Gently lift the hard disk.

● Installing the hard disk

Perform the steps in the reverse order of the procedure to remove the hard disk.

- 1 Unlock the connector lock.
- 2 Connect the cable.
- 3 Gently insert the hard disk.

5 Put the cover back into place and insert the battery pack (page 25)

Running the Setup Utility

To run the Setup Utility, you need to restart your computer.



Upon seeing this message

Press <F2> to enter SETUP



press **F2**

NOTE

- Press **F2** while [Press <F2> to enter SETUP] is displayed.
- The Setup Utility will not run if **F2** is not pressed soon after the computer starts. In this case, you need to restart your computer.
- If [Enter Password] is displayed, enter your password.
When entering the User Password, if the [Set User Password], [Set Supervisor Password] and [User Password Protection] have been set, [Advanced] menu will not be displayed on the main screen.
To display the [Advanced] menu:
 - 1 Restart the computer and press **F2** when [Press <F2> to enter SETUP] is displayed.
 - 2 When [Enter Password] is displayed, enter the Supervisor Password.
- For more details, on-line help is available; press **F1**.

NOTE

Key Operations

- F1** :To display the "General help" file.
- Enter** :To display sub-menu.
- Esc** :To display [Exit] menu.
- Left Arrow** **Right Arrow** :To move among the menus.
- Up Arrow** **Down Arrow** :To move among the items.
- F5** **F6** :To move among the values.
- F10** :To save the settings and exit.

Closing the Setup Utility (Exit Menu)  page 42

Main Menu

BIOS Version:	Vx.xxLxx
System Time:	[xx:xx:xx]
System Date:	[xx/xx/1999]
System Memory:	xxxxxKB
Hard disk:	xxxxMB
NumLock:	[Off]
Touch Pad:	[Enable]
Speaker:	[Enable]
Display:	[External Monitor]
Expansion:	[Disable]

Parameters (_ : Default)

NumLock	On <u>Off</u>
Touch Pad	Disable <u>Enable</u>
Speaker	Disable <u>Enable</u>
Display	<u>External Monitor</u> Internal LCD Simultaneous
Text Expansion	<u>Disable</u> Enable

Advanced Menu

Plug & Play:	[Enable]
Serial Port A:	[3F8/IRQ4]
Serial Port B:	[2F8/IRQ3]
Touch Screen:	[2E8/IRQ7]
Parallel Port:	[378]
Mode:	[Bi-directional]
Internal Modem:	[Enable]
Legacy USB Support:	[Disable]
Floppy Drive Type:	[CF-VFDU01]

Parameters (_ : Default)

Plug & Play	Disable <u>Enable</u>
Serial Port A	Disable <u>3F8/IRQ4</u>
Serial Port B	Disable <u>2F8/IRQ3</u>
Touchscreen	Disable <u>2E8/IRQ3</u>
Parallel Port	Disable <u>378</u>
Mode* ¹	Uni-directional <u>Bi-directional</u> ECP EPP
Internal Modem	Disable <u>Enable</u>
Legacy USB Support	<u>Disable</u> Enable
Floppy Drive Type* ²	<u>CF-VFDU01</u> CF-VFDU03 (USB)

*¹ This item is displayed only when [Parallel Port] is set to [378].

*² Setting impossible when [Legacy USB Support] is set to [Disable].

Security Menu

Boot Up Drive:	[A:/C:]
■Set Supervisor Password:	[Enter]
User Password Protection:	[No Protection]
■Set User Password:	[Enter]

CAUTION

If starting up the Setup Utility with the User Password;

The User Password can only be set when the Supervisor Password has been set and [User Password Protection] has been set to [No Protection].

Parameters (_ : Default)

Boot Up Drive	<u>A:/C:</u> C:
Set Supervisor Password	To the sub-menu
User Password Protection	<u>No Protection</u> Protected
Set User Password*	To the sub-menu

* Setting impossible when the Supervisor Password is not set.

Power Menu

Power Switch:	[Hibernation]
Panel Switch:	[LCD Off]
Fn+F7/Fn+F10 key:	[Enable]
CD-ROM/DVD-ROM Drive Speed : [High]	
<input checked="" type="checkbox"/> Battery Operation	
<input checked="" type="checkbox"/> AC Adapter Operation	

Parameters (_ : Default)

Power Switch	Suspend <u>Hibernation</u> Power Off
Panel Switch	<u>LCD Off</u> Suspend Hibernation
Fn+F7/Fn+F10 key	Disable <u>Enable</u>
Battery Operation	
ECO Mode Timeout	Disable 1 Minute <u>2 Minutes</u> 4 Minutes 6 Minutes 8 Minutes 12 Minutes 16 Minutes
Hibernation Timeout*	Disable <u>5 Minute</u> 10 Minutes 15 Minutes 20 Minutes 30 Minutes 40 Minutes 60 Minutes
AC Adapter Operation	
ECO Mode Timeout	<u>Disable</u> 1 Minute 2 Minutes 4 Minutes 6 Minutes 8 Minutes 12 Minutes 16 Minutes
Hibernation Timeout*	<u>Disable</u> 5 Minute 10 Minutes 15 Minutes 20 Minutes 30 Minutes 40 Minutes 60 Minutes

* The [Suspend Timeout] item will be displayed when [Power Switch] is set to [Suspend].

Exit Menu

Save Values & Exit
Exit Without Saving Changes
Load Default Values
Load Previous Values
Save Current Values

NOTE

If the Supervisor Password or User Password has been set, the password must be entered before Windows can start.

Parameters

Save Values & Exit	Exit the Setup Utility and save your changes to CMOS.
Exit Without Saving Changes	Exit the Setup Utility without saving your changes to CMOS.
Get Default Values*	Set the default settings for operating system. The password remains.
Load Previous Values	Load previous values from CMOS for all Setup items.
Save Current Values	Save your changes to CMOS.

* This item may not be displayed when starting up the Setup Utility with the User Password.

By making various settings in Smart Boot, it is possible to shorten the start-up time from the computer OFF state, the go-into time to hibernation and the return-to-operation time from the hibernation mode.

1 Select [Start] - [Programs] - [Panasonic] - [Smart Boot]

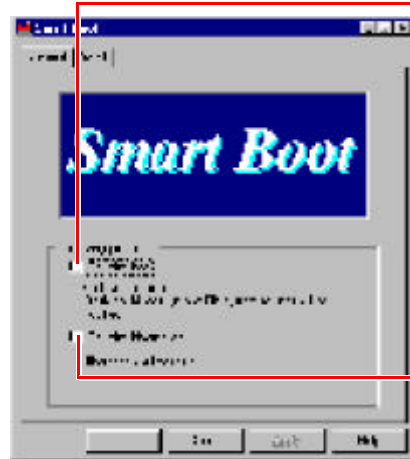

If this box is checked, the following occurs.

- The Windows Logo display (i.e., the cloud display) is not shown at start-up.
- The channel bar of Internet Explorer 4.0 is not shown.
- No background paper is displayed.
- "Welcome" of Internet Explorer 4.0 is not shown.
- To display the start-up menu by pressing the F8 key at start-up, it is necessary to press **F8** slightly faster than normal.

If this box is checked, the time to enter the hibernation mode and the time to resume from the hibernation mode are shortened.

2 Add check mark depending on your needs

3 Click [Boot Detail] if necessary

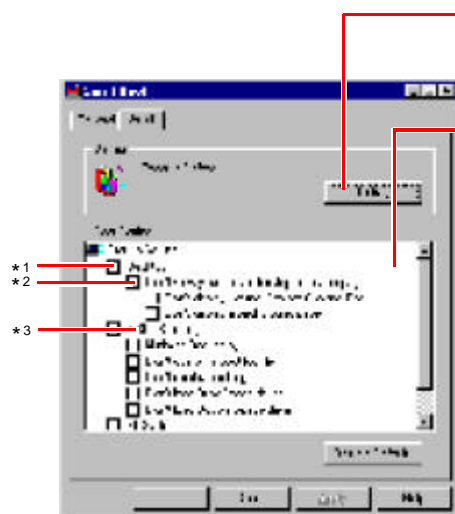

Press this button to run the Defrag command. Executing Defrag regularly prevents a reduction in the access speed to a drive.

It is possible to make individual settings to the Optimize Boot contents by adding checks to the boxes shown.

When Desktop, MS-DOS setting, and File System are checked, all of the items under each of these are also checked.

<Desktop>

It is possible to choose whether or not to display the active desktop as a web page, channel bar, background paper, and the "Welcome" of Internet Explorer 4.0.

<MS-DOS Setting>

It is possible to choose whether or not to show the Windows logo display at start-up and overwrite the boot log file. In addition, it is possible to choose whether or not to minimize the delay of the start-up menu at start-up.

<File System>

It is possible to increase the speed of the computer by changing the disk cache size, etc.

*1 When Active Desktop cannot be used, it cannot be changed (gray display).

*2 When the controls of the channel bar of Internet Explorer cannot be used, they cannot be changed (gray display).

*3 When "Welcome" of Internet Explorer 4.0 cannot be used, it is not displayed.

4 Add check mark depending on your needs

5 Click [OK]

NOTE

When the settings are changed, a display asks whether you would like to restart Windows.

Network

- The network connection may be severed when entering the ECO mode and suspend (hibernation) mode. Be sure to disable the [Suspend/Hibernation Timeout] settings with the Setup Utility if you require a network environment.
- When the power saving function is running, communications software may malfunction. For example, communications may be halted if the suspend (hibernation) mode is activated. The computer must be restarted if one of these modes is entered during data communications.
Be sure that the computer enters the ECO mode or suspend (hibernation) mode after the communications software is closed.

Internet Explorer

Internet Explorer 4.01 places a tremendous load on the system in order to execute the wide variety of functions that it provides. As a result, some unexpected faults may occur.

If any of these faults occurs, try using the software with some Internet Explorer 4.01 functions turned off. (See Internet Explorer Help for more details.)

- **It takes a long time to reboot or the computer locks up.**
Delete the check mark for [Internet Explorer Channel Bar] in [Control Panel] - [Display] - [Web], then press [OK].
- **A system module error occurs.**
Set (None) for [Wallpaper] in [Control Panel] - [Display] - [Background].
- **Performing the above steps does not solve the problem.**
Uninstall Internet Explorer 4.0 with the following step.
Select [Microsoft Internet Explorer 4.01] in [Start] - [Settings] - [Control Panel] - [Add/Remove Programs] - [Install/Uninstall] and press [Add/Remove]. Follow the on-screen instructions.
- **If a window with the message [Version Conflict] appears during the installation process (network card and application installation), select [Yes].**
Proper operation may not be possible if [NO] is selected.

This computer conforms to the specifications of the Desktop Management Interface (DMI). The DMI Viewer can be used when you want to know information on the internal systems this computer supports, starting with the CPU and memory.

Running DMI Viewer

Select [DMI Viewer] from [Start] - [Programs] - [Panasonic].

The screen shown below is displayed.

When you click on an item, detailed information on that item will be displayed.

Click to close the DMI Viewer

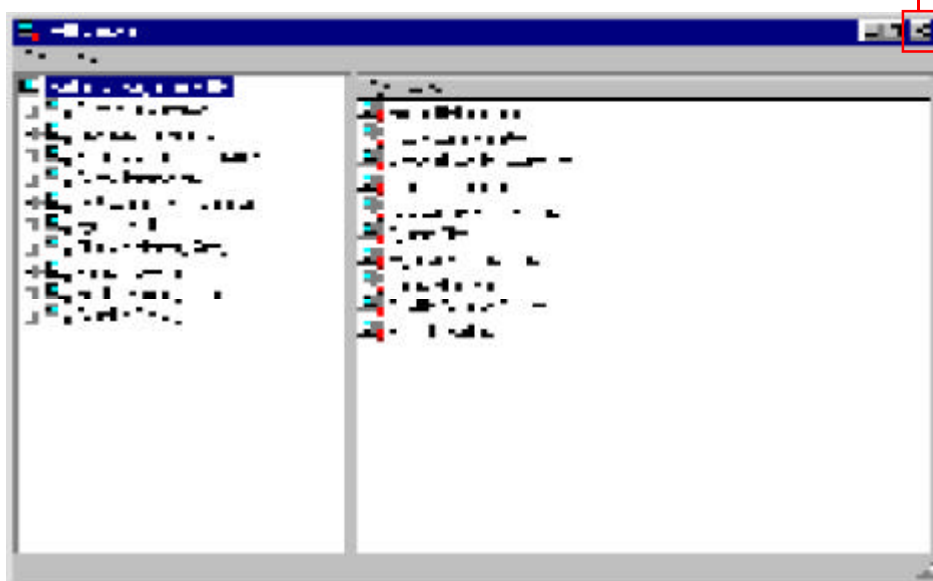

Saving information to a file

Displayed information can be saved to a text file (.txt). Run the DMI Viewer and display the information you wish to save.

- 1 ● To save the item that is displayed**
Select [Save Selected Data] from [File] menu.
- To save all items**
Select [Save All Data] from [File] menu.
- 2 Input the file name (and select the folder), then press [Save]**



When the computer fails to work properly or system files on the hard disk are deleted, the computer can be returned to factory condition by performing the "Reinstallation" procedure. Important: To perform the "Reinstallation" procedure, it is necessary to create a backup disk prior to any trouble.

A backup disk cannot be created after reinstallation becomes necessary. Therefore, be sure to create a backup disk soon after purchasing your computer, and store the disk in a safe location along with the supplied Windows 95 System Pack.



Name of created backup disk

FIRSTAID FD

(When the display for creating the UPDATE DISK is shown, create the disk by following the on-screen instructions.)

- 1 Power off your computer**   "Starting Up/Shutting Down")
Do not shut down using the suspend or hibernation mode.
- 2 Connect the external floppy disk drive to your computer**
- 3 Turn on your computer**
- 4 Set a floppy disk and make sure it is not in the write-protected state**
- 5 Select [Start] - [Programs] - [Panasonic] - [Create BACKUP DISK]**
Follow the on-screen instructions. Place a label identifying the contents on each disk.

CAUTION

- Please store the floppy disks in a safe place. They will enable you to return your computer to the condition at the time of purchase should any problems occur. When creating floppy disks, do not run any other application program.
- When creating floppy disks and the message [Insufficient files to copy] is displayed, click [OK] and then contact Panasonic Technical Support.
- While the floppy disk drive being accessed, do not remove the floppy disk, power down your computer or use the suspend or hibernation function (  "Suspend/Hibernation Functions").

(To next page)

Make a copy of the CD-ROM driver

Copy the necessary drivers, from the floppy disk included with your CD-ROM drive, to the FIRST AID FD with the method below. It will be necessary to edit the CONFIG.SYS file and AUTOEXEC.BAT file on the FIRST AID FD. When editing the AUTOEXEC.BAT file, be careful not to delete lines containing settings for CAB files to be copied to the C drive on the hard disk.

Some CD-ROM drives require card managers (card and socket service). See the manual included with your CD-ROM drive for further details.

- 1 Start Windows and insert the FIRST AID FD**
- 2 Select [Start]-[Programs]-[Accessories]-[NotePad] and open [a:\config.sys]**
- 3 Rewrite the following line and save**
Device=A:\UP\WINDOWS\COMMAND*****.SYS /D:MSCD000
 - Rewrite this driver for the driver of your CD-ROM drive. The driver for the PC Card will also be necessary. Please refer to the operation manual that accompanies the CD-ROM drive.
- 4 Copy the CD-ROM driver file (i.e., the driver file rewritten in step 3) of the CD-ROM drive below [a:\up\windows\command] of the FIRST AID FD**
- 5 Set the floppy disk to the write-protect state**

The following is a list of the messages that BIOS can display. Most of them occur during POST. Some of them display information about a hardware device, e.g., the amount of memory installed. Others may indicate a problem with a device, such as the way it has been configured. Following the list are explanations of the messages and remedies for reported problems.

If your system displays one of except the messages marked below with an asterisk (*), write down the message and contact Panasonic Technical Support. If your system fails after you make changes in the Setup menus, reset the computer, enter Setup and install Setup defaults or correct the error.

0200 Failure Fixed Disk

Fixed disk in not working or not configured properly. Check to see if fixed disk is attached properly. Run Setup. Find out if the fixed-disk type is correctly identified.

0210 Stuck key

Stuck key on keyboard.

0211 Keyboard error

Keyboard not working.

0212 Keyboard Controller Failed

Keyboard controller failed test. May require replacing keyboard controller.

0213 Keyboard locked - Unlock key switch

Unlock the system to proceed.

0230 Shadow RAM Failed at offset : *nnnn*

Shadow RAM failed at offset *nnnn* of the 64k block at which the error was detected.

0231 System RAM Failed at offset : *nnnn*

System RAM failed at offset *nnnn* of the 64k block at which the error was detected.

0232 Extended RAM Failed at offset : *nnnn*

Extended memory not working or not configured properly at offset *nnnn*.

0250 System battery is dead - Replace and run SETUP

The CMOS clock battery indicator shows the battery is dead. Replace the battery and run Setup to reconfigure the system.

***0251 System CMOS checksum bad - Default configuration used**

System CMOS has been corrupted or modified incorrectly, perhaps by an application program that changes data stored in CMOS. The BIOS installed Default SETUP Values. If you do not want these values, enter Setup and enter your own values. If the error persists, check the system battery or contact Panasonic Technical Support.

0260 System timer error

The timer test failed. Requires repair of system board.

0270 Real time clock error

Real-time clock fails BIOS test. May require board repair.

***0280 Previous boot incomplete - Default configuration used**

Previous POST did not complete successfully. POST loads default values and offers to run Setup. If the failure was caused by incorrect values and they are not corrected, the next boot will likely fail. On systems with control of **wait states**, improper Setup settings can also terminate POST and cause this error on the next boot. Run Setup and verify that the wait-state configuration is correct. This error is cleared the next time the system is booted.

0281 Memory Size found by POST differed from CMOS

Memory size found by POST differed from CMOS.

02B0 Diskette drive A error**02B1 Diskette drive B error**

Drive A: or B: is present but fails the BIOS POST diskette tests. Check to see that the drive is defined with the proper diskette type in Setup and that the diskette drive is attached correctly.

02B2 Incorrect Drive A type - run SETUP

Type of floppy drive A: not correctly identified in Setup.

02B3 Incorrect Drive B type - run SETUP

Type of floppy drive B: not correctly identified in Setup.

02D0 System cache error - Cache disabled

Contact Panasonic Technical Support.

02F0: CPU ID:

CPU socket number for Multi-Processor error.

02F4: EISA CMOS not writable

ServerBIOS2 test error: Cannot write to EISA CMOS.

02F5: DMA Test Failed

ServerBIOS2 test error: Cannot write to extended DMA (Direct Memory Access) registers.

02F6: Software NMI Failed

ServerBIOS2 test error: Cannot generate software NMI (Non-Maskable Interrupt).

02F7: Fail - Safe Timer NMI Failed

ServerBIOS2 test error: Fail-Safe Timer takes too long.

device address Conflict

Address conflict for specified *device*.

Allocation Error for: device

Run ISA or EISA Configuration Utility to resolve resource conflict for the specified *device*.

CD ROM Drive

CD ROM Drive identified.

Entering SETUP ...

Starting Setup Utility.

Failing Bits : nnnn

The hex number *nnnn* is a map of the bits at the RAM address which failed the memory test. Each 1 (one) in the map indicates a failed bit. See error 230,231 or 232 for offset address of the failure in System, Extended or Shadow memory.

Fixed Disk n

Fixed disk *n* (0-3) identified.

Invalid System Configuration Data

Problem with NVRAM (CMOS) data.

I/O device IRQ conflict

I/O device IRQ conflict error.

PS/2 Mouse Boot Summary Screen:

PS/2 Mouse installed.

nnnn kB Extended RAM Passed

Where *nnnn* is the amount of RAM in kilobytes successfully tested.

nnnn Cache SRAM Passed

Where *nnnn* is the amount of system cache in kilobytes successfully tested.

nnnn kB Shadow RAM Passed

Where *nnnn* is the amount of shadow RAM in kilobytes successfully tested.

nnnn kB System RAM Passed

Where *nnnn* is the amount of system RAM in kilobytes successfully tested.

Operating System not found

Operating system cannot be located on either drive A: or drive C:. Enter Setup and see if fixed disk and drive A: are properly identified.

Parity Check 1 nnnn

Parity error found in the system bus. BIOS attempts to locate the address and display it on the screen. If it cannot locate the address, it displays ?????. Parity is a method for checking errors in binary data. A parity error indicates that some data has been corrupted.

Parity Check 2 nnnn

Parity error found in the I/O bus. BIOS attempts to locate the address and display it on the screen. If it cannot locate the address, it displays ????.

Press <F1> to resume, <F2> to Setup, <F3> for previous

Displayed after any recoverable error message. Press <F1> to start the boot process or <F2> to enter a Setup and change the settings. Press <F3> to display the previous screen (usually an initialization error of an **Option ROM**, i.e., an add-on card). Write down and follow the information shown on the screen.

Press <F2> to enter Setup

Optional message displayed during POST. Can be turned off in Setup.

PS/2 Mouse:

PS/2 mouse identified.

System BIOS shadowed

System BIOS copied to shadow RAM.

UMB upper limit segment address : nnnn





Displays the address *nnnn* of the upper limit of **Upper Memory Blocks**, indicating released segments of the BIOS which can be reclaimed by a virtual memory manager.

Video BIOS shadowed

Video BIOS successfully copied to shadow RAM.

When a problem occurs, please refer to this page. If you still cannot troubleshoot the problem, please contact Panasonic Technical Support.



● Starting Up

<p>The power indicator or battery indicator is not lit</p>	<ul style="list-style-type: none"> ● Check the cable connection for the AC adapter. ● Check to see if a fully charged battery is properly installed. ● Remove the battery pack and disconnect the AC adapter, then connect them again.
<p> is displayed</p>	<p>Please input your password. If you have forgotten it, contact Panasonic Technical Support.</p>
<p>[POST Startup Error(s)] is displayed</p>	<p> page 48</p>
<p>Windows startup, or an operation is extremely slow</p>	<p>Press (F9) in the Setup Utility ( page 37). This will restore the Setup Utility's settings to their default values (except the password settings). Then, the Setup Utility must be run once again for you to input the appropriate operating environment settings. (The processing speed depends on the application software used, so this operation may not cause the processing speed to increase.)</p>
<p>The date and time are incorrect</p>	<ul style="list-style-type: none"> ● You can set the date and time through [Date/Time] in [Start] - [Settings] - [Control Panel]. ● When the computer is connected to a Local Area Network (LAN), please confirm the date and time of the server. ● If you continue to experience problems, the internal battery maintaining the clock may need to be replaced. Please contact Panasonic Technical Support.
<p>When the previous item is not the cause</p>	<ul style="list-style-type: none"> ● Press (F9) in the Setup Utility ( page 37). This will restore the Setup Utility's settings to their default values (except the password settings). ● In the MS-DOS mode, run SCANDISK to check the hard disk. ● At start-up, press (F8) to operate the computer in the Safe mode. ● Try removing all peripheral devices.

● Shutting Down

<p>Unable to shut down Windows 95</p>	<p>If a USB device is connected, try removing it.</p>
---------------------------------------	---

● Battery Indicator

<p>The red indicator lights. Repeated beeping sound while the computer is in use.</p>	<p>The battery level is low. Save your data and power off your computer. After connecting the AC adapter or replacing the battery pack with a fully charged one, turn your computer on.</p>
<p>The red indicator blinks</p>	<ul style="list-style-type: none"> ● The battery pack or recharging function may be defective. Quickly remove the battery pack and disconnect the AC adapter, then connect them again. ● If the problem persists, contact Panasonic Technical Support.
<p>After the AC adapter is connected, the orange indicator blinks five times</p>	<p>Unable to charge because of an improper temperature range. (  "Precautions")</p>

● Display

<p>No display after powering on</p>	<ul style="list-style-type: none"> ● At the time of purchase, the display setting is preset for an external display. If you connect an external display, the screen is displayed on the external display. ● When there is no display to an external display, <ul style="list-style-type: none"> • Check your cable connection to the external display. • Confirm your display is powered on. • Check the settings for your external display. ● Try changing the display by pressing (Fn) + (F3). ● When displaying only through an external display, if the computer is shut down by using the suspend or hibernation function, there will be no display on the LCD unless the external display is connected when operations are resumed. In this case, connect the external display.
<p>The power has not been turned off, but after a certain period of time, there is no display</p>	<ul style="list-style-type: none"> ● Has the computer been set to the power-saving mode? To resume operation of your computer from ECO mode, press any key (like (Ctrl) key). ● To save power, your computer may have automatically entered the suspend or hibernation mode. ( page 20)
<p>The resolution of the display cannot be changed</p>	<p>Set [None] for [Wallpaper] in [Start] - [Settings] - [Control Panel] - [Display] - [Background], and then press [OK]. Then, once again try changing the resolution. After the change, be sure to restart the computer.</p>
<p>An afterimage appears (i.e., green, red, and blue dots remain on the display) or there are dots not displaying the correct colors</p>	<p>If an image is displayed for a prolonged period of time, an afterimage may appear. This is not a malfunction. The afterimage will disappear when a different screen is displayed.</p> <p>High-precision and advanced technologies are necessary in the production of color liquid crystal displays (color LCDs). Therefore, if 99.998% or more of the picture elements are functioning properly, no defect is considered to exist.</p>
<p>The motion of the mouse cursor is not smooth</p>	<p>Select [Start] - [Settings] - [Control Panel] - [Mouse] - [Motion] and try to change the speed or acceleration.</p>
<p>The cursor does not move in scrolling area of the touch pad</p>	<p>When the Microsoft® IntelliMouse™ Wheel mode or the original mode is set for the touch pad, only scroll operations are possible for the right part or bottom part of the touch pad. In this case, cursor operations are possible by using the work surface excluding the right part or bottom part. When no mode is set, the entire surface of the touch pad can be used for cursor operations.</p>
<p>The cursor cannot be controlled</p>	<p>Restart the computer by using the keyboard (e.g., (H)).</p>
<p>During simultaneous display, the screen of the external display becomes disordered</p>	<p>Try changing the display by pressing (Fn) + (F3).</p>
<p>The external display no longer displays properly</p>	<p>When an external display not compatible with the power saving mode is used with the computer, the external display may no longer display properly when the computer enters the ECO mode. In such cases, turn off the power to the external display.</p>

● Touchscreen

Unable to input by touching the display	<ul style="list-style-type: none">● Has the Setup Utility been used to set [Touchscreen] to [2E8/IRQ7]? ( page 39)● Confirm that the setting for resource in [Start] - [Programs] - [Updd] - [Settings] - [Hardware] and the setting for [2E8/IRQ7] in [Touchscreen] of the Setup Utility are appropriate.● When mouse drivers are installed (i.e. Intellimouse), the touchscreen may at times be unable to be used. In such cases, reinstall the touchscreen driver.
--	--

● Reference Manual

Unable to display the Reference Manual	<p>Has Acrobat Reader been uninstalled? If Acrobat Reader has been uninstalled, select [Start] - [Run], then type "c:\util\reader\setup.exe". Follow the on-screen instructions. (Acrobat Reader can be also downloaded from "http://www.adobe.com".)</p>
---	--

● Drive Operations

Cannot read/write to a disk	<ul style="list-style-type: none">● Has the disk been correctly inserted?● Has the disk been correctly formatted?● Your disk content may be corrupted.
Unable to write to a disk	Is the disk write-protected?
How to format a disk is unclear	Select [Format] in [My Computer] - [3 1/2 Floppy] - [File]. After confirming the disk volume and format type, start formatting.
Unable to read/write to the hard disk	<ul style="list-style-type: none">● Your drive or file may not have been properly set.● Check to see if the hard disk is full. If it is full, delete unnecessary files.● Your hard disk content may be corrupted. Contact Panasonic Technical Support.
When the previous item is not the cause	Try testing another drive or media.

● Character Input

Only capital letters are being input	If CapsLock is on, the Caps Lock function is ON. To switch it OFF, press Caps Lock .
How to input European characters (ß, à, ç), symbols or Euro Currency Symbol is unclear	Select [Start] - [Programs] - [Accessories] - [Character Map]. The Character Map will be displayed. Point to the desired font name and select it.



● Setup Utility

[Enter Password] is displayed	Enter the User Password or Supervisor Password. If you have forgotten it, contact Panasonic Technical Support.
[Advanced] menu can not be registered	Restart the Setup Utility with the Supervisor Password.
All or some items in [Security] menu can not be registered	Restart the Setup Utility with the Supervisor Password.

● Application Software

Computer hangs	<ul style="list-style-type: none"> ● Press Ctrl + Alt + Del to reboot the computer. ● After cutting the power by pressing the power switch for more than four seconds, slide the power switch to power on and open the application again. If the program no longer works normally, go to [Start] - [Settings] - [Control Panel] - [Add/Remove Programs] to delete the program. Then try installing the program once again.
----------------	---

● Sound

The sound is not heard	<ul style="list-style-type: none"> ● Try changing the mute by pressing Fn + F4 . ● Has the Setup Utility been used to set [Speaker] to [Disable]? ( page 38)
The volume can not be changed by pressing Fn + F5 or Fn + F6	Under the condition the sound function of Windows is not working,  or  is displayed, but the volume does not change.
No warning sound can be heard	When a MIDI file or a WAVE file is played with another application, no warning sound is generated.



● Unusual Sound

The computer produces a strange sound	<ul style="list-style-type: none"> ● If the computer enters the ECO mode or the LCD is closed while the computer is making a sound, the computer may produce a strange sound, but this does not indicate a problem. ● If the computer has not been used for a long period of time, it may produce an unusual sound at start up. The sound may continue for a short period of time, but if the computer starts up in a normal manner, then the problem is not serious. If, however, the computer fails to start up, contact Panasonic Technical Support.
---------------------------------------	---

● Timeout Function

The timeout functions do not work	If the Panasonic Battery Monitor is being displayed, please close it.
-----------------------------------	---

● Connecting Peripherals

<p>Your peripheral does not work (An error occurs while installing the driver)</p>	<p>You need to use drivers conforming to Windows 95 Version 4.00.950B (OSR-2.1). Some earlier drivers will no longer work. For more information, please ask the manufacturer of the driver in question.</p>
<p>Unable to print</p>	<ul style="list-style-type: none"> ● Check the computer-printer connection. ● Make sure the printer is on. ● Make sure the printer is in the online state. ● Make sure paper is in the printer tray and there is no paper jam. ● Confirm that [Parallel Port] has not been set to [Disable].
<p>The cursor does not move from mouse operations</p>	<p>Check your mouse connection, then reboot the computer from the keyboard. From the keyboard, you may choose to press down on , then select [Shut Down].</p>
<p>The device connected to the serial port does not work</p>	<ul style="list-style-type: none"> ● Check the connection. ● Confirm that the device driver for the serial port works. Please refer to the reference manual of the device. ● Confirm that two mouse devices are not connected, one through the external keyboard/mouse port and the other through the serial port. ● Try setting [Touch Pad] to disable in the Setup Utility. ● Confirm that [Serial Port A] has not been set to [Disable].
<p>External mouse or trackball connected to the external keyboard/mouse port does not work</p>	<ul style="list-style-type: none"> ● Try setting [Touch Pad] to disable in the Setup Utility. ● In some circumstances, if a PS/2 external mouse with a serial interface conversion function is connected to the port, it may not operate normally. Try connecting it to the serial port.
<p>A PC Card does not work</p>	<ul style="list-style-type: none"> ● Make sure the card is properly inserted. ● Confirm that the card conforms to the PC Card Standard. ● Note that after a driver is installed, the computer must be rebooted. ● Check that the proper port settings have been made. ● Read the PC Card's manual. Or, you may need to call the manufacturer of the PC Card.
<p>You do not know the available RAM module</p>	<p> page 28</p>
<p>The RAM module has not been recognized</p>	<ul style="list-style-type: none"> ● Make sure the RAM module has been properly inserted. ● Use the RAM module that support the recommended specifications.
<p>The address map for IRQ, I/O port address, etc. is unclear</p>	<p>Check the address map by going to [View Resources] in [Start] - [Settings] - [Control Panel] - [System] - [Device Manager] - [Computer] - [Properties].</p>
<p>A USB device does not work</p>	<ul style="list-style-type: none"> ● Make sure a driver is installed. ● Contact the manufacturer of the product.

Copyright

This manual is copyrighted by Matsushita Electric Industrial Co., Ltd. with all rights reserved. No part of this manual may be reproduced in any form without the prior written permission of Matsushita Electric Industrial Co., Ltd. No patent liability is assumed with respect to the use of the information contained herein.

© Matsushita Electric Industrial Co., Ltd. 1999. All Rights Reserved.

Disclaimer

Computer specifications and manuals are subject to change without notice. Matsushita Electric Industrial Co., Ltd. assumes no liability for damage incurred directly or indirectly from errors, omissions or discrepancies between the computer and the manuals.

Trademarks

PS/2™ is a trademark of International Business Machines Corporation.

Microsoft, MS-DOS, Windows and IntelliMouse are registered trademarks of Microsoft Corporation of the United States and/or other countries.

Pentium is a registered trademark of Intel Corporation.

Acrobat is a registered trademark of Adobe Systems Incorporated.

Panasonic is a registered trademark of Matsushita Electric Industrial Co., Ltd.

PCE0005A95

Free Manuals Download Website

<http://myh66.com>

<http://usermanuals.us>

<http://www.somanuals.com>

<http://www.4manuals.cc>

<http://www.manual-lib.com>

<http://www.404manual.com>

<http://www.luxmanual.com>

<http://aubethermostatmanual.com>

Golf course search by state

<http://golfingnear.com>

Email search by domain

<http://emailbydomain.com>

Auto manuals search

<http://auto.somanuals.com>

TV manuals search

<http://tv.somanuals.com>