



Panasonic

Reference Manual

Personal Computer

Model No. **CF-31 Series**

We recommend that this Reference Manual be printed.

Descriptions

- For common procedures and screens for Windows 7 and Windows XP, this Reference Manual uses the procedures and screens of Windows 7.
- Some menus may differ for Windows XP.
- Windows XP does not require clicking operation to  of the notification area.

This manual explains using the Windows 7 or Windows XP default setting. In these instructions, the names are referred as follows.

Windows 7

- “Genuine Windows® 7 Professional” as “Windows” or “Windows 7”

Windows XP

- “Genuine Microsoft® Windows® XP Professional” as “Windows” or “Windows XP”

■ For the users of the model with Discrete Video Controller

Your computer is equipped with two graphics processing units (GPUs).

The Intel® GPU consumes less power, but reduces the graphics display performance.

The discrete GPU consumes more power, but maintains a higher graphics display performance.

- In this manual, refer to the sections preceded by the following descriptions, whenever they appear.

<When the Intel® GPU with lower power consumption is activated>

<When the discrete GPU with higher power consumption is activated>

■ For the users of the model without Discrete Video Controller

Your computer is equipped with the Intel® graphics processing unit (GPU), which is designed to save power effectively.

- In this manual, refer to the sections preceded by the following description, whenever it appears.

<When the Intel® GPU with lower power consumption is activated>

Windows Update

You can update to the latest patches and service packs for Windows with the following menus.

Click  (Start)^{*1} - [All Programs] - [Windows Update].

Do not apply “Driver Updates” even if a message to update a driver appears. If a driver update is required, contact your technical support office.

*1 Windows XP: [start]

Windows 7

Regarding Windows 7

■ Sound and video

- Sound (e.g. MP3, WMA) and video (e.g. MPG, WMV) recorded in PC Cards and SD Memory Cards may be interrupted during playback. If this happens, copy them to the hard disk drive and play back.

- Depending on the processing status on Windows, sound may be interrupted at Windows startup. You can mute the sound at startup.
 - ① Right-click the desktop and click [Personalize] - [Sounds].
 - ② Remove the check mark from [Play Windows Startup sound], and click [OK].

■ When high-frequency sound occurs

If high-frequency sound occurs around keyboard while using the computer, check the settings for the USB power saving function. A standard user needs to enter an administrator password and click [OK].

- Set [USB selective suspend setting] to [Enabled].
 - ① Click  (Start) - [Control Panel] - [System and Security] - [Power Options].
 - ② Click [Change plan settings] of the current power plan.
 - ③ In [Change settings for the plan], click [Change advanced power settings].
 - ④ In [Advanced settings], double-click [USB settings].
 - ⑤ Double-click the displayed [USB selective suspend setting].
 - ⑥ Change settings of [On battery] and [Plugged in] to [Enabled].
 - ⑦ Click [OK] and exit the [Advanced settings] screen.

■ Switching the GPU that is used

<Only for the model with Discrete Video Controller>

When you start up the computer for the first time after purchase, the Intel® GPU is activated to save power. You can manually change the GPU that is used.

1 Set [Switchable Graphics] to [Switchable].

- ① Turn on or restart the computer.
- ② Press **F2** or **Del** while [Panasonic] boot screen is displayed soon after the computer starts the startup procedure.
- ③ Select the [Main] menu and set [Switchable Graphics] to [Switchable].
- ④ Press **F10**, select [Yes], and press **Enter** to exit the Setup Utility. Computer will start.

2 Log on to Windows.

3 Click on the notification area, and click .

4 Select [Switchable Graphics].

5 To switch to the Intel® GPU, select [Power Saving Video] in [Switchable Graphics]. To switch to the discrete GPU, select [Performance Video] in [Switchable Graphics].

6 Click [OK].

Wait until the next [OK] screen appears.

7 Click [OK].

NOTE

- You cannot change the GPU that is used while operating graphics-related application programs.
- Once the GPU is switched, switching to the other GPU is not possible for a certain period of time.
- When a digital display (such as an HDMI display) is connected and the computer's display is closed, you cannot switch the GPU that is used.
- When an external display is connected and the GPU is switched, the video output destination may unexpectedly be changed.

Regarding Windows XP

You can select the Classic view of Control Panel or the Classic Start menu. You can also change the way a user logs on or off. This manual explains using the Windows XP default setting (not Classic view or Classic Start menu etc.).



- If the message "Your computer might be at risk" is displayed

Select  (red icon) on the notification area and make the appropriate settings. The Windows Security Center regularly gives you notice so that you can make the optimum settings. This is not an error message and you can use the computer. However, making appropriate measures is recommended to reduce the risk of virus and other attacks.

NOTE

- Do not repeatedly press the keys in quick succession.
- Do not use the key combinations together with touch pad (external mouse), touchscreen (only for model with touchscreen) or other key operations.
- Do not use the key combinations before you log on to Windows. Wait until the hard disk drive indicator  turns off. On the Setup Utility screen, you can use the key combinations of **Fn + F1**, **Fn + F2** and **Fn+F3**.
- The key combinations may not work with some applications.
- The pop-up icon appears after logging on to Windows. It may not appear in some application conditions.

Key	Function	Pop-up icon
<u>Fn</u> + <u>F1</u> ^{*1} <u>Fn</u> + <u>F2</u> ^{*1}	LCD brightness (<u>Fn</u> + <u>F1</u> = down / <u>Fn</u> + <u>F2</u> = up)	

Key	Function	Pop-up icon
Fn + F3	<p>Display mode switching (→ page 48) When an external display (a projector etc.) is connected, you can change the display mode.</p> <p>Windows 7</p> <ol style="list-style-type: none"> Press Fn + F3. Click the display mode. (Computer only/Duplicate/Extend/Projector only) The change you made may not be effective until Enter is pressed. <p>You can also change the operating mode by pressing Ⓢ + P. Computer only → Duplicate → Extend → Projector only</p> <p>Windows XP</p> <p>→ LCD → LCD + HDMI display (port replicator side)^{*2} → HDMI display (port replicator side)^{*2} → LCD + HDMI display (computer side) → HDMI display (computer side) → LCD + analog display → analog display → HDMI display (computer side) + analog display</p> <p>CAUTION</p> <ul style="list-style-type: none"> Do not press any keys until the display has finished switching. Do not use this function: <ul style="list-style-type: none"> When playing motion video such as DVD or MPEG. When an extended monitor is not connected. When showing a game screen such as pinball. <p>Windows XP</p> <ul style="list-style-type: none"> When using the extended desktop. 	<p>—</p>
Fn + F4^{*1}	<p>Speaker on/off</p> <p>NOTE</p> <ul style="list-style-type: none"> Beeps do not sound if you turn off the speaker sound.^{*3} 	<div style="display: flex; justify-content: space-around; align-items: center;"> <div style="text-align: center;">  <p>OFF (MUTE)</p> </div> <div style="text-align: center;">  <p>ON</p> </div> </div>

Key	Function	Pop-up icon
<u>F</u>n + <u>F</u>5^{*1} <u>F</u>n + <u>F</u>6^{*1}	Volume (<u>F</u>n + <u>F</u>5 = down / <u>F</u>n + <u>F</u>6 = up) NOTE <ul style="list-style-type: none"> When fine-tuning the sound volume, press and hold <u>F</u>n, and press <u>F</u>5 or <u>F</u>6 intermittently. This does not work on beeps or speakers connected to the USB port. 	
<u>F</u>n + <u>F</u>7	Activate sleep^{*4} (→ page 16)	—
<u>F</u>n + <u>F</u>8	Concealed Mode on/off You can select on/off of LCD Backlight, LED, Sound ^{*3} , Wireless Radio, Backlit Keyboard and Fan. NOTE <ul style="list-style-type: none"> You have to set [Concealed Mode] to [Enabled] in Setup Utility. (→ page 92) You can set the devices turned off in [Concealed Mode] with Setup Utility (→ page 92). If you press <u>F</u>n + <u>F</u>8 in succession, the Concealed Mode may not be switched. More than 4 minutes interval is necessary to switch on/off. 	—
<u>F</u>n + <u>F</u>9	Remaining battery charge	(→ page 26)
<u>F</u>n + <u>F</u>10	Activate hibernation (→ page 16)	—

*1 These key combinations are disabled when [Concealed Mode] is enabled.

*2 Only when a port replicator having an HDMI port is connected.

*3 Even if [Sound] is set to [OFF] on the [Concealed Mode Configuration] menu,  icon on the notification area and [Volume] in [Sound-MAX] display do not show mute state.
However, audio from the speaker is not heard.

*4 Windows XP: standby

Hotkey Settings

You can make 2 settings:

- **Fn key lock**
When you press **Fn**, the key is locked (pressed-down) until you press another key. Use this when pressing difficult key combinations.
- **Pop-up icon on/off**

1 Start up the Hotkey Settings.

Click  (Start)^{*5} - [All Programs] - [Panasonic] - [Hotkey Settings].

2 Make the settings.

[Use Fn key lock]

- When using an **Fn** key combination

① Press **Fn** once. (Locked)

② Press another key. (Lock released)

- When using successive **Fn** key combinations

① Press **Fn** twice. (Locked)



② Press another key.

Fn key remains locked until you press **Fn** again.

[Notification]

[Make sounds when Fn key is pressed]^{*6}

[Show status on screen]: Displays the Fn key status when  on the notification area is clicked.

- : **Fn** is locked.
- : **Fn** is not locked.

[Disable popup]

The pop-up icon will not be displayed.

3 Click [OK].

NOTE

- You can have different settings for each user.

^{*5} Windows XP: [start]

^{*6} If the speaker is muted or [Sound] is turned off in [Concealed Mode Configuration], beeps do not sound.

<Only for model with touchscreen>

You can use the touchscreen function to perform the same operation as the touch pad and mouse. Touch the screen surface with the stylus (included).

Windows 7





For further information, click  (Start) - [Control Panel] - [Hardware and Sound] - [Pen and Touch] - [Flicks] - [Practice using flicks].

● To right-click

Windows 7

- ① Touch and hold with the stylus, or touch and select the right button of “touch pointer”.

Windows XP

- ① Click  on the notification area.
 changes to .
- ② Click the object you want to right-click.
 returns to .

NOTE

- The touchscreen function does not work in the Setup Utility.

Windows XP

- You need to make the following setting for each user.
 - ① Click [start] - [All Programs] - [Fujitsu Touch Panel (USB)] - [Touch Panel Configuration].
 - ② Select the settings, and then click [OK].
 - Do not add a check mark to [Delete Cursor] since the display may be distorted.
- If you add a check mark for [Use] in [Hold [Ctrl] key down + Touch the screen] of [Touch Panel Configuration], touching the screen may always be recognized as a right-click. To return to the normal operation, press **Ctrl** on the keyboard.
- The touchscreen function does not work in the Setup Utility, in the full screen of [Command Prompt].

Operation of the touchscreen

■ Operate the touchscreen with your finger or with an approved stylus

When using the touchscreen function, use only your finger or an approved stylus on the surface. Operating the touchscreen with an object other than your fingertip or the stylus (a fingernail or metal object, or other hard or sharp objects that may leave a mark) may scar or stain the surface, causing the touchscreen to malfunction.

■ Do not apply too much pressure when operating the touchscreen

Only a light touch is required to operate the touchscreen. Applying too much pressure may damage the surface.

Maintaining the performance of the touchscreen

■ When the touchscreen becomes dirty, wipe it with an approved soft cloth

The touchscreen is specially treated to prevent dirt from adhering to the surface, so dirt can be removed easily using a dry cloth (use only the approved soft cloth). If the dirt does not come off easily, breathe on the surface and try again. Do not apply water or solvents to the soft cloth.

■ Clean the touchscreen while the computer is powered off

Cleaning the screen while the power is on may cause the computer to malfunction. Also, dirt on the touchscreen is easier to see when the computer is powered off, and so is easier to clean.

■ Wash the soft cloth when it becomes dirty

When the soft cloth becomes dirty, wash it with mild detergent. Do not use bleach or fabric conditioner (softener), or try to sterilize the cloth by boiling.

If the soft cloth is dirty, it may be ineffective in cleaning the touchscreen, and in fact may cause dirt to adhere to the touchscreen.

■ Check the following to prevent the surface of the touchscreen from being scratched

- Are you using your finger or a stylus to operate the touchscreen?
- Is the surface clean?
- Is the soft cloth clean?
- Are you using the stylus with the tip extended?
- Is the tip of the stylus clean?
- Is your finger clean?

Things to keep in mind when using the touchscreen

■ Do not touch the screen outside of the LCD display area

The touchscreen input area is defined by the LCD display screen. Touching the screen outside of the display area may result in malfunctions or damage to the touchscreen.

■ Do not apply excessive force to the touchscreen

Do not lift the computer while holding the LCD screen, or allow the screen to be twisted. Do not place any objects on the LCD screen. Any of the above may cause the touchscreen glass to break, or may damage the LCD screen.

■ Operation response may be slower in low temperature environments

The touchscreen may respond to operations more slowly when using the computer in temperatures less than 5°C, but this is not a malfunction. Response time will return to normal when the computer is returned to room temperature.

■ If the cursor jumps to a location other than where the screen was touched, or if the LCD resolution changes, recalibrate the touchscreen

Perform the procedure of “Touchscreen Calibration” (→ [below](#)).

Touchscreen Calibration

Windows 7

A standard user needs to perform the calibration as an administrator before performing the calibration for each user.

■ Calibration by an administrator

NOTE

- At first, log on to Windows as an administrator, and perform this calibration.

- 1 Run [Tablet PC Settings].**
Click  (Start) - [Control Panel] - [Hardware and Sound] - [Tablet PC Settings].
- 2 Click [Calibrate].**
- 3 Using the stylus, touch each of the “+” target marks one by one.**

■ Calibration by a standard user

NOTE

- Perform the following calibration for each user.

1 Run [Tablet PC Settings].

Click  (Start) - [Control Panel] - [Hardware and Sound] - [Tablet PC Settings].

2 Click [Calibrate].

3 Using the stylus, touch each of the “+” target marks one by one, and then click [OK].

- Perform the calibration for the orientation to be used.

Windows XP

1 Run [Touch Screen Calibration Utility].

Click [start] - [All programs] - [Fujitsu Touch Panel (USB)] - [Touch Screen Calibration Utility].

2 Using the stylus, touch each of the 12 “+” target marks one by one until it blinks, and then press **Enter**.

3 Press **Enter**.

NOTE



Perform the touchscreen calibration for each user.

You can make a bitmap file (.bmp) of a simple character and a figure such as signature by handwriting on the touch pad and the touchscreen (only for model with touchscreen).

CAUTION

- Do not use the Fast User Switching function while Panasonic Hand Writing is active.
- If you install other pointing devices (e.g., commercially available mouse driver) and overwrite the touch pad driver, Panasonic Hand Writing will not work.

NOTE

- The display of Panasonic Hand Writing may be distorted if the number of display colors is changed. Click  on the notification area and right-click , then click [Exit Panasonic Hand Writing], and then restart Panasonic Hand Writing.
- Panasonic Hand Writing may not work properly if another application software is active. In this case, close the application software and try handwriting again.

Starting Panasonic Hand Writing

- 1 Click  on the notification area, and double-click .

Alternatively you can click  (Start)^{*1} - [All Programs] - [Panasonic] - [Panasonic Hand Writing].

NOTE

- Select the image size before handwriting by clicking [Option] - [Window size]. If you change the size after handwriting, the image quality will become lower.
- You can copy the bitmap image by clicking [Edit] - [Copy], and paste it in another application software that supports bitmap format.
- The touch pad mode may not work properly when using the extended desktop.
- The touch pad mode may be canceled in the following cases.
 - Switching to another application
 - Resuming from sleep^{*2} or hibernation
 - Pressing **Alt**
 - Touching the touchscreen (only for model with touchscreen)
- An external mouse or trackball connected via the keyboard/mouse port of port replicator (optional) or the car mounter (optional) will not work during handwriting in the touch pad mode.

*1 Windows XP: [start]

*2 Windows XP: standby

Starting Up Your Computer Quickly

The sleep^{*1} or hibernation functions allow you to shut off the computer without closing programs and documents. You can quickly return to the programs and documents that you were working on before sleep^{*1} or hibernation.



Function	Data is saved to	Recovery time	Power supply
Sleep ^{*1}	Memory	Short	Required. (If power is not supplied, all data will be lost.)
Hibernation	Hard disk	Rather long	Not required. (However power is slightly consumed to keep the hibernation.)

*1 Windows XP: standby

Setting Sleep or Hibernation

Windows 7

■ Sleep

- 1 Click  or  on the notification area, and click [More power options].
- 2 Click [Change plan settings] of the power plan you want to change.
- 3 Select the setting for [Put the computer to sleep], and then click [Save changes].
 - The setting for hibernation may change unexpectedly when you change the setting for sleep. Confirm that the time to enter hibernation is 1,080 minutes (default setting) or longer (below).

■ Hibernation

- 1 After the step 2 of “Sleep” setting (above), click [Change advanced power settings].
- 2 Double-click [Sleep], and double-click [Hibernate after].
- 3 Click the item and select the setting.
- 4 Click [OK].

Windows XP

- 1 Click [start] - [Control Panel] - [Performance and Maintenance] - [Power Options] - [Advanced].
- 2 Select [Stand by] or [Hibernate] for [When I close the lid of my portable computer:] / [When I press the power button on my computer:], and then click [OK].

NOTE

- You do not need to make the setting if you use the Windows menu to enter standby or hibernation.

Precautions



- Connect the AC adaptor if the computer will be in sleep^{*2} for a long period of time. If you cannot use the AC adaptor, use hibernation instead.
- Using sleep^{*2} or hibernation repeatedly may cause malfunction of the computer. To stabilize computer operation, restart Windows regularly (about once a week) without using sleep^{*2} or hibernation.
- Save the necessary data.
- Close files you have opened from removable disks and network drives.
- The password you set in the Setup Utility is not requested at resuming. You can use the Windows password for security in sleep^{*2} or hibernation.

Windows 7

In the default setting, you are requested to enter the Windows password when the computer resumes.

Windows XP

You can use the Windows password for security in standby or hibernation.

- ① Click [start] - [Control Panel] - [User Accounts], and select the account.
 - ② Click [Create a password] and set the password.
 - ③ Click [start] - [Control Panel] - [Performance and Maintenance] - [Power Options] - [Advanced], and add the check mark in [Prompt for password when computer resumes from standby].
- Do not enter sleep^{*2} or hibernation in the conditions below, otherwise the data or file may be corrupted, sleep or hibernation may not work, or malfunction may occur in the computer or the peripheral devices.
 - When any of the hard disk drive indicator  or the SD Memory Card indicator  is on.
 - When playing/recording audio files or displaying motion video such as MPEG files.
 - When playing a DVD-Video.
 - When writing to a disc.

- When using communication software or network functions.
- When using peripheral devices.
(If peripheral devices fail to work normally, restart the computer.)

Windows XP

- When using a PC Card.
(If the card fails to work normally, restart the computer.)
- When an external mouse is connected to the serial port.

Windows 7

- It may take 1 or 2 minutes to enter hibernation. Do not touch any key though the screen becomes dark.

*2 Windows XP: standby

CAUTION

The following problems will occur when you fail the password input (failing three times or leaving the computer unattended for one minute or more) while resuming from sleep^{*3} or hibernation.

- Failing the password input while resuming from hibernation:
 - At the next resume, Panasonic boot screen will appear. At this time, do not start the Setup Utility and do not change settings. Otherwise, resume may not operate correctly.
 - Cannot resume from hibernation by the Wake Up from wired LAN function, the Task Scheduler or the operation to open the display.
- Failing the password input while resuming from sleep^{*3}:
 - Cannot resume from sleep^{*3} using the USB devices.

Entering/Resuming from Sleep or Hibernation

■ To enter sleep^{*3} or hibernation

In order to enter sleep^{*3} or hibernation by proceeding as follows, first change the power option settings (→ page 14 “Setting Sleep or Hibernation”) so that the [Power buttons and lid]^{*4} operation is set to sleep^{*3} or hibernation.

1 Close the display, or slide the power switch (A) until a beep^{*5} sounds.

Sleep^{*3}: The power indicator (B) blinks green.

Hibernation: The power indicator (B) goes off.

- You can alternatively use the Windows menu to enter sleep^{*3} or hibernation.

Windows 7

Click  (Start) -  - [Sleep] / [Hibernate].

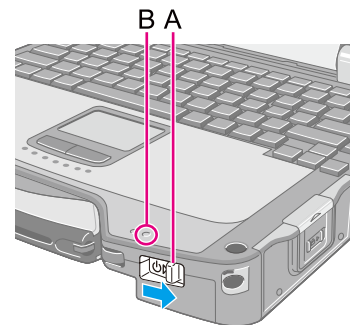

Windows XP

To enter standby, click [start] - [Turn Off Computer] - [Stand By].

To enter hibernation, click [start] - [Turn Off Computer], then press and hold **Shift** and click [Hibernate].

CAUTION

While the computer is entering sleep^{*3} or hibernation

- Do not:
 - Touch the keyboard, touch pad, touchscreen (only for model with touchscreen), or power switch.
 - Use an external mouse or other peripheral devices.
 - Connect or disconnect the AC adaptor.
 - Operate the wireless switch.
 - Close or open the display.
 - Insert and remove the SD Memory Card.

Wait until the power indicator blinks green (sleep^{*3}) or goes off (hibernation).

- It may take 1 or 2 minutes to enter sleep^{*3} or hibernation.
- At the beep^{*5}, immediately release the power switch. After releasing the switch, do not operate it until the power indicator blinks or goes off.

Windows 7

If you slide and hold the power switch for longer than 4 seconds, the computer will forcibly shut down and unsaved data will be lost even if you have set [When I press the power button] to any item in [Choose what the power button does] of [Power Options] in [Control Panel].

Windows XP

If you slide and hold the power switch for longer than 4 seconds, the computer will forcibly shut down and unsaved data will be lost even if you have set [Shut down] in [When I press the power button on my computer] (→ [page 14](#) "Setting Sleep or Hibernation").

In sleep^{*3} or hibernation

- Do not attach or remove a multimedia pocket device and peripheral devices. Doing so may cause malfunction.
- Power is consumed in sleep^{*3}. Power consumption may increase when a PC Card is inserted. When power is exhausted, the data retained in memory will be lost. Connect the AC adaptor when using the sleep^{*3} function.
- Do not turn on/off the wireless switch.

■ To resume from sleep^{*3} or hibernation

1 Open the display, or slide the power switch (A).

Windows 7

- In the default setting, the Windows password will be requested to resume.

Windows XP

- When [Stand by] or [Hibernate] is selected as the setting for [When I close the lid of my portable computer] (→ [page 15](#)), you can resume operation opening the display.

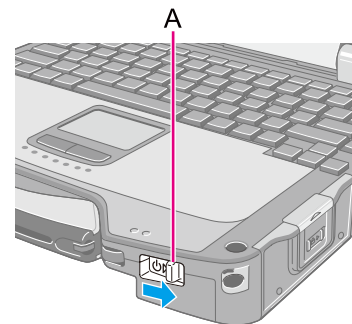

CAUTION

- Do not perform the following operations until resuming is complete. After the display is resumed, wait approximately 30 seconds (normally) or 60 seconds (when the computer is on a network).
 - Touch the keyboard (except for password input), touch pad, touchscreen (only for model with touchscreen), or power switch.
 - Use an external mouse or other peripheral devices.
 - Connect or disconnect the AC adaptor.
 - Close or open the display.
 - Shut down or restart Windows.
 - Enter sleep^{*3} or hibernation (Wait approximately 1 minute).
 - Operate the wireless switch.
 - Insert and remove the SD Memory Card.

Windows 7

- If the computer enters sleep while a USB keyboard or mouse is connected, touching the USB keyboard keys or mouse will resume the computer.

^{*3} Windows XP: standby

^{*4} Windows XP: [When I close the lid of my portable computer:] / [When I press the power button on my computer:]

^{*5} If the speaker is muted or [Sound] is turned off in [Concealed Mode Configuration], beeps do not sound.

You can extend battery life and save power also during AC adaptor usage.

Reducing Power Consumption

Use the methods below to reduce power consumption.

- **Change [Power Options]**

- Windows 7**

- Click  (Start) - [Control Panel] - [System and Security] - [Power Options] to select [Power saver].

- While [Panasonic Power Management] is selected as the factory default, selecting [Power saver] will further reduce power consumption.

- Also, to make detailed settings such as reducing the time entered in the [Turn off the display] setting, click [Change plan settings].

- Windows XP**

- Click [start] - [Control Panel] - [Performance and Maintenance] - [Power Options] to select [Max Battery] under [Power schemes]. While [Portable/Laptop] is selected under [Power Options] as the factory default, selecting [Max Battery] will further reduce power consumption.

- Also, make detailed settings such as reducing the time entered in the [Turn off monitor] setting.

- Use a related utility

- The following utilities provide additional power saving functions not available in [Power Options].

- Use Catalyst™ Control Center Utility (→ [page 22](#))

- Windows 7**

- Use Panasonic Power Plan Extension Utility (→ [page 20](#))

- Windows XP**

- Use Power Saving Utility (→ [page 20](#))

- **Press Fn + F1 to reduce LCD brightness**

- Reducing internal LCD brightness will reduce power consumption.

- **Turn off the computer when it is not in use**

- You can also turn off only the wireless LAN or wireless WAN power.

- **Disconnect external devices (USB devices, PC cards, external mice, etc.) that are not being used**

- **Use Sleep^{*1}/Hibernation**

- Press Fn + F7 to set the computer to sleep^{*1} or Fn + F10 to set it to hibernation when you have to leave the computer.

- This shuts down computer operation to reduce power consumption.

- Disable Wake Up from wired LAN function when it is not needed. This reduces power consumption in Sleep^{*1}/Hibernation.

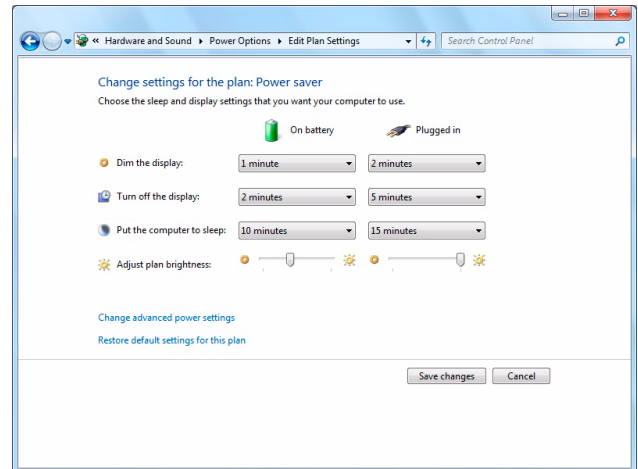

To confirm current settings, **Windows 7** click  (Start) - [All Programs] - [Panasonic] - [Power Saving Utility] - [Advanced] to view [Wired LAN standby power saving function] or [Wireless LAN standby power saving function].

Windows XP click [start] - [All Programs] - [Panasonic] - [Power Saving Utility] to view [Wired LAN standby power saving function].

Windows 7

- Use [Switchable Graphics] to select [Low speed] in [Fan control] (→ [page 3](#))

*1 Windows XP: standby

Windows 7

Using Panasonic Power Plan Extension Utility

<When the Intel® GPU with lower power consumption is activated>

You can adjust the power plan to change power saving features as required.

■ Setup

1 Click  (Start) - [All Programs] - [Panasonic] - [Panasonic Power Plan Extension].

2 Select the desired power plan under [Power Plan].

At the default, [Panasonic Power Management (Active)] is selected.

To save power more effectively, select [Panasonic Power Management (Power Saving)] or [Power saver].

For the computer's behavior in each power plan, see the descriptions located below.

You can also change the settings item by item.

3 Click [Apply].

4 Click [OK].

Windows XP

Using Power Saving Utility

<When the Intel® GPU with lower power consumption is activated>

A single setting allows you to enable all the following power saving features. Enable each of these functions to prolong battery operation time.

- **Intel video driver power saving function (Intel(R) Display Power Saving Technology)**

During battery operation, this function adjusts video contrast, color and other factors to lower internal LCD power consumption while retaining adequate image quality.

Disable this function for work that requires subtle image and color nuances or in video editing using video editing applications.

- **Wired LAN standby power saving function**
Enabling this function disables the Wake Up from wired LAN function to save power in standby/hibernation. Disable this function if you want to use the Wake Up from wired LAN function.
- **Fan control**
Select [Low speed] to save power. ([Standard] is selected at the time of purchase.)

■ Setup

1 Click [start] - [All Programs] - [Panasonic] - [Power Saving Utility].

2 Click [Enable] for each function.

Click [OK] in the confirmation screen that appears.

- **To enable “Intel video driver power saving function”**

Select [Enable], and slide the slide bar to the “Maximum Battery” end.

3 Click [OK].

Click [Restore initial settings] to return to the factory default settings, and click [OK].

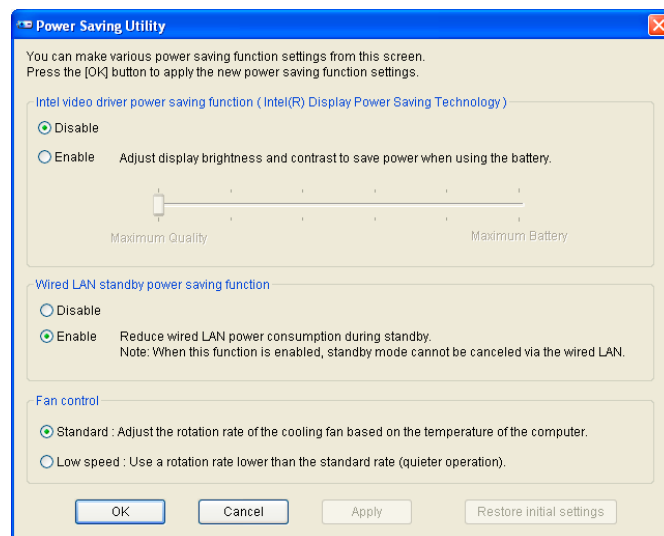

NOTE

- Even if you can enable each function using power saving utility, you can also enable them as follows.
<When the Intel® GPU with lower power consumption is activated>
 - For how to enable the Intel video driver power saving function.
 - ① Click [start] - [Control Panel] and click [Other Control Panel Options] under [See Also] on the left side of the screen and select [Intel(R) Graphics and Media].
 - ② Click [Power].
 - ③ Click [Maximum Battery Life].
 - ④ Click [Apply].
 - ⑤ Click [OK].
 - For how to enable/disable the Wake Up from wired LAN function (→ [page 73](#))

Using Catalyst™ Control Center Utility

<When the discrete GPU with higher power consumption is activated>

■ Setup

- 1 Click  (Start)^{*2} - [All Programs] - [Catalyst Control Center] - [CCC – Advanced].
- 2 **Windows 7**
Click [Power Play™].
Windows XP
Click [Graphics] - [PowerPlay™].
- 3 Select [Maximize Battery Life] in [Plugged In:] and [Battery:].
- 4 Click [OK].

^{*2} Windows XP: [start]

NOTE

- When [Maximum Battery Life] is selected in [PowerPlay™], the computer's performance will be reduced.

Use these features to protect your data.

- Another security measure
 - Embedded Security (TPM) (→ [page 97](#)): For further information, refer to the *Installation Manual* of “Trusted Platform Module (TPM)”.

Setting the Supervisor Password/User Password

Set the Supervisor Password before setting the User Password.

- 1 Start up the Setup Utility (→ [page 88](#)).**
- 2 Select [Security].**
- 3 Select [Set Supervisor Password] or [Set User Password], and press Enter.**
- 4 Enter your password in [Create New Password] and press Enter.**
 - When the password has been set, you need to enter your password in [Enter Current Password] and press Enter.
 - To disable the password, leave the input field empty and press Enter.
- 5 Enter your password again in [Confirm New Password] and press Enter.**
- 6 Press F10, and then select [Yes] and press Enter.**

CAUTION

- Do not forget your password. If you forget your Supervisor Password, you will not be able to use your computer. Contact Panasonic Technical Support.
- When running the Setup Utility, do not leave and go away from your computer even for a short time, since other people may set or change the password.

NOTE

- The password will not be displayed on the screen.
- You can use up to 32 alphanumeric characters (including spaces).
 - The case (upper/lower) is ignored.
 - Use only the upper horizontal row of numeric keys to input your password.
 - You cannot use **Shift** and **Ctrl** to input a password.
- Disabling the Supervisor Password also disables the User Password.

Preventing Your Computer from Unauthorized Use

You can set a start-up password to protect your computer from unauthorized use.

- 1 Set the password (→ [page 23](#)), and select **[Enabled]** in **[Password On Boot]** and/or **[Password On Resume]** in the **[Security]** menu of the Setup Utility (→ [page 97](#)).

NOTE

- If the Supervisor Password or User Password has been set, the password input screen will be displayed on starting-up of the Setup Utility even though **[Password On Boot]** and/or **[Password On Resume]** is set to **[Disabled]**.

Preventing Your Hard Disk Data from Being Read or Written

The hard disk lock function protects the hard disk data from being read or written when the hard disk is attached to another computer. The data can be read/written when the hard disk is returned to the original computer. (Note that the hard disk lock does not guarantee complete protection of the data.)

- 1 Select **[Enabled]** in **[Hard Disk Lock]** in the **[Security]** menu of the Setup Utility (→ [page 97](#)).

CAUTION

- For the data being read/written on the original computer, the Setup Utility settings must be the same as when the hard disk was removed.
- You cannot use the hard disk lock function without setting the Supervisor Password. Set the Supervisor Password beforehand (→ [page 23](#)).
- When you have your hard disk drive repaired
 - Contact Panasonic Technical Support.
 - Before sending back the hard disk drive, be sure to set the **[Hard Disk Lock]** to **[Disabled]**.

NOTE

- The hard disk lock function works with the built-in hard disk. It does not work with the external hard disk.
- We recommend you to set **[Password on boot]** to **[Enabled]** to ensure security though it is not required to enable the hard disk lock.

Battery Indicator

Battery indicator: 

Battery indicator	Battery status
Not lit	The battery pack is not inserted or not being charged.
Orange	Charging is in progress.
Green	The battery is fully-charged.
Blinking green	In high temperature mode, the battery pack is discharging the power to 80% ^{*1} of normal temperature mode (→ page 26). Do not remove the battery pack in this status.
Red	The remaining battery is approximately 9% or less.
Blinking red	The battery pack or the charging circuit is not operating properly.
Blinking orange	The battery cannot be charged temporarily due to the following reasons: <ul style="list-style-type: none">• Its internal temperature is out of the acceptable range.• The power supply is not enough because software applications or peripheral devices are consuming a large amount of power.
Blinking green and orange alternately	The temperature is low and the computer is warming up to prevent the hard disk drive from malfunctioning. The computer will start automatically after warming-up.
Blinking orange slowly	When you set [Battery Charging Indicator] to [Flashing] on the [Main Menu] of [Setup Utility].

*1 In high temperature mode, the 100% battery level is equivalent to 80% level of the normal temperature mode.

NOTE

- Once the battery is fully charged, the computer performs recharging only when the battery level becomes less than approximately 95%, so overcharging is avoided.
- When [LED] is set to [OFF] on the [Concealed Mode Configuration] menu, LED disappears (→ page 92).

Checking the Remaining Battery Charge

You can check the remaining battery charge on the screen.

(After logging on to Windows)

1 Press **Fn** + **F9**.

- When the battery pack is inserted (example)



: Normal temperature mode



: High temperature mode (→ below)

- When the battery pack is not inserted



NOTE

- The battery display may not correspond to the actual remaining battery charge in the cases as below. To correct the display, perform the Battery Recalibration (→ [page 29](#)).
 - The battery indicator remains red.
 - The indicator lights orange and the display shows 99% for a long time.
 - Low battery warning appears soon after a short time of use.This can occur when the computer is in sleep^{*2} for a long time without power supply from the AC adaptor.
- The battery display may not be the same as that of notification area^{*3}. This is not a malfunction.

^{*2} Windows XP: standby

^{*3} Windows XP: or of [Power Meter] in [Power Options Properties]

High temperature mode

The high temperature mode can prevent the battery from deteriorating when the computer is used in high-temperature environment or used for a long time with its battery fully charged.

Select [Auto] (default) or [High Temperature] in [Environment] of the [Main] menu of the Setup Utility (→ [page 92](#)).

NOTE

- Note that a level corresponding to a 100% charge for high temperature mode is approximately equivalent to an 80% charge level for normal temperature mode.
- After switching from [Normal Temperature] to [High Temperature] or vice versa, the remaining battery capacity will not be displayed correctly until the battery pack is completely discharged or fully charged.
- In the [Auto] mode:
Once the computer has automatically switched from the normal temperature mode to the high temperature mode, the computer will not switch back to the normal temperature mode until the battery has been used and recharged to a total charge level of about 5 times as much as that of the fully-charged state. This is to avoid battery deterioration.

Computer behavior with low battery

The default settings are as follows.

When the battery level becomes 10% [Low battery alarm]	When the battery level becomes 5% [Critical battery alarm]
<ul style="list-style-type: none"> ● Displays a message that the battery level is low. <p style="text-align: center;">↓</p>	<p>Windows 7</p> <ul style="list-style-type: none"> ● The computer enters hibernation. <p>Windows XP</p> <ul style="list-style-type: none"> ● Displays a message that the battery level is low, and then the computer enters hibernation. <p style="text-align: center;">↓</p>
<p>Charge the battery.</p>	<p>Connect the AC adaptor or replace the battery to start up the computer.</p>
<ul style="list-style-type: none"> ● Connect the AC adaptor immediately. If you do not have the AC adaptor, exit the running programs and Windows, then confirm that the power indicator is off. ● If you have a fully charged spare battery, turn off the computer, replace the battery and turn the computer on again. 	<ul style="list-style-type: none"> ● Connect the AC adaptor and charge the battery. ● If you have a fully charged spare battery, turn off the computer, replace the battery and turn the computer on again. <p>Windows 7</p> <p>When the computer enters hibernation with the battery down and you resume the operation without charging the battery, the Windows Resume Loader starts up. Follow the on-screen instructions. After that, however, Windows may not start up normally, or the [Low battery level]/[Critical battery level] function may not work normally.</p> <p>Windows XP</p> <p>When the computer enters hibernation with the battery down and you resume the operation without charging the battery, Windows may not start up normally or the alarm function may not operate normally from then on.</p>

Correcting the Battery Display (Battery Recalibration)

The “Battery Recalibration” function measures and memorizes the battery capacity. To correct the battery display, use this function to fill the battery and then discharge it completely. Perform the procedure at least once immediately after purchasing the computer. Normally the interval of battery recalibration is 3 months. The battery display may not be correct when the battery pack deteriorates after a long time use. In this case, perform the procedure again.

1 Connect the AC adaptor.

2 Close all the applications.

3 Perform “Battery Recalibration”.

① Click  (Start)^{*4} - [All Programs] - [Panasonic] - [Battery] - [Battery Recalibration].

② When the confirmation message appears, click [Start].

- Frequent recalibration of the battery can degrade the battery. A caution message appears when the battery recalibration is performed at the shorter interval than approximately a month. In this case, cancel the battery recalibration.

③ When the message requests shut down of Windows, click [Yes].

The battery recalibration starts.

After the battery pack is fully charged, discharging starts. When the discharging is completed, the power goes off automatically.

After the battery recalibration is finished, normal charging starts.

^{*4} Windows XP: [start]

NOTE

- The temperature range should be 10°C to 30°C {50°F to 86°F}.
- The battery recalibration does not work correctly if a port replicator other than the CF-VEB311 is connected. (The battery recalibration will not end.) If you are using a port replicator other than the CF-VEB311, disconnect it before starting the battery recalibration.
- The battery recalibration may take a long time due to the large battery capacity. This is not a malfunction.
 - Full charge: Approximately 3.5 hours (max.)
 - Complete discharge: Approximately 2.5 hours (when [Switchable Graphics] in the main menu of the Setup Utility is set to [Switchable] or [Performance Video] for the model with Discrete Video Controller)
Approximately 3 hours (when [Switchable Graphics] in the main menu of the Setup Utility is set to [Power Saving Video] for the model with Discrete Video Controller, or for the model without Discrete Video Controller)
- If the computer is turned off during the battery recalibration (e.g., due to power failure, or accidental removal of the AC adaptor and battery pack), the battery recalibration will not be completed.
- You can also perform the battery recalibration with the following procedure.

- ① Restart the computer.
- ② Press and hold **F9** while the [Panasonic] boot screen is displayed just after the computer starts the startup procedure.
- ③ When the remaining battery capacity is displayed, press **Enter**.
- ④ Follow the on-screen instructions.

Replacing the Battery Pack

The battery pack is a consumable item so the replacement will be necessary. If the battery operation time becomes noticeably short and not recovered even after recalibrating the battery, replace with a new battery.

CAUTION

- The battery pack is not charged when you first purchase it. Be sure to charge it before using for the first time. Charging starts automatically when the AC adaptor is connected to the computer.
- Use only the specified battery pack with your computer.
- In sleep^{*5}, do not remove/replace the battery pack. Otherwise your data will be lost and the computer may be damaged.

1 Turn off the computer.

- Do not use the sleep^{*5} function.

2 Remove/Insert the battery pack.

- To remove

- ① Slide the latch (A) to the right to unlock the cover.

*5 Windows XP: standby

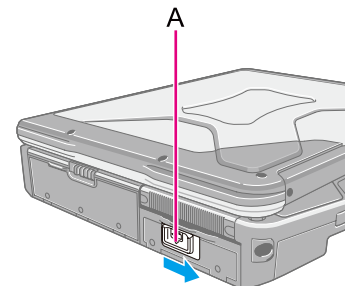

- Slide the latch (A) down, and open the cover.

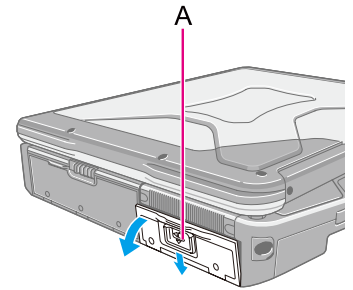

- Pull the tab (B) of the battery pack.

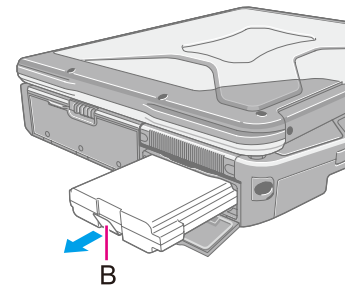

- To insert
 - Insert the battery pack until it securely fits the connector.
 - Close the cover until it clicks.

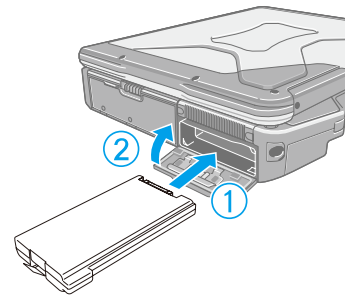

- Slide the latch (C) to the left to lock the cover.

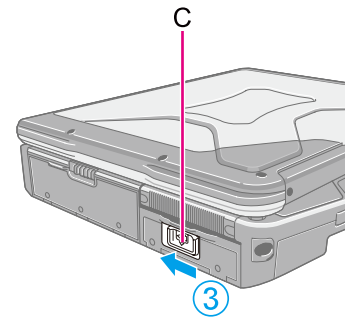



CAUTION

- Make sure the latch is securely locked, otherwise the battery pack may fall when you carry the computer.



Windows 7

You can choose the optimum power setting for your operating condition by selecting a power plan. You can also create your own power plan.



Changing the Power Plan Setting

- 1 Click  or  on the notification area and click [More power options].
- 2 Click [Change plan settings] of the power plan you want to change.
- 3 Change the settings.
 - [Change advanced power settings]: You can make more detailed settings.
- 4 Click [Save changes].

Creating Your Own Power Setting

- 1 Click  or  on the notification area and click [More power options].
- 2 Click [Create a power plan], click the basic plan and input the name of power plan.
- 3 Click [Next].
- 4 Change the settings and click [Create].
 - To change the settings or to make more detailed settings. (above “Changing the Power Plan Setting”)

Deleting the Power Plan

- 1 Click  or  on the notification area and click [More power options].
- 2 Click the power plan other than the power plan to be deleted.
- 3 Click [Change plan settings] displayed under the power plan that you want to delete.
- 4 Click [Delete this plan], and then click [OK] on the confirmation screen.

You can attach the following devices. (refer to recent catalogs and other sources for information about the products available)

- DVD MULTI drive (optional)

CAUTION

- Do not insert/remove the multimedia pocket device in sleep^{*1} or hibernation, or when the multimedia pocket device indicator or the hard disk drive indicator  is on.

NOTE



- Refer to the catalogs etc. for the latest information about optional devices.
- Read the instruction manuals of the devices carefully.

^{*1} Windows XP: standby



Replacing the Multimedia Pocket Device

1 Disable the multimedia pocket device function.

Windows 7

- ① Click  on the notification area and click .
- ② Click [Eject TEAC DV-W28S-V].
- ③ Confirm that the multimedia pocket device indicator and the hard disk drive indicator  are not lit.

Windows XP

- ① Double-click  on the notification area.
 - ② Select [TEAC DV-28XXX] and then click [Stop].
 - ③ Follow the on-screen instructions.
 - ④ Confirm that the multimedia pocket device indicator and the hard disk drive indicator  are not lit.
- This step is not necessary when:
 - Removing the device after turning off the computer.
 -  is not displayed^{*2}.
 - The device does not appear in the list in step ②.

2 Slide the latch (A) and open the cover.

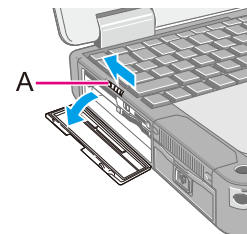

3 Press the release handle (B).

The release handle pops out.

4 Pull the release handle (B) to draw out the device partway, and hold the device on its both sides to remove.

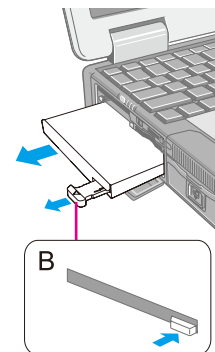

5 Carefully insert the device into the multimedia pocket by pushing both corners until it surely fits in the slot.

- Press the release handle (C) to set in.
- Insert the device with the label side up.

6 Close the cover until it clicks.

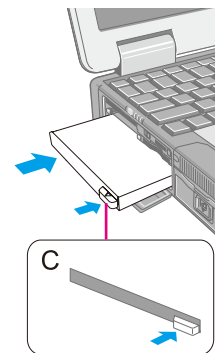

CAUTION

- Hold the device by both sides. Otherwise the device may be damaged.
- When raising the slot side upward and inserting the device, be careful not to apply any impact to the device.

NOTE

- You can see that the device is recognized or not by double-clicking *³, or checking the [Information] menu in the Setup Utility (→ [page 89](#)). If the device is not recognized (or if the media cannot be accessed), turn off the computer and reinsert the device.

*² Windows XP:  is not displayed

*³ Windows XP: by double-clicking  on the notification area

You can insert the following cards.

- ExpressCard/34 or ExpressCard/54 to the ExpressCard slot (A)
- PC Card Type I (3.3 mm) or II (5.0 mm) to the PC Card slot (B)
- For model with Smart Card slot (→ [page 43](#))

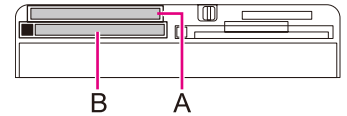

NOTE

- The following types of card are not supported:
PC Card Type III (10.5 mm), ZV card, SRAM card, FLASH ROM card (excluding ATA interface type), and other cards that require 12 V of operating voltage.
- Do not start up Windows with a storage type of CardBus PC card attached. An error may occur.

Inserting/Removing the Card

Preparation

Attach the device for the media containing the card driver (e.g., CD-ROM). Equipment connected to the multimedia pocket cannot be recognized if connected after the card driver installation screen appears.

■ To insert the card

- 1 Slide the latch (C) and open the cover.

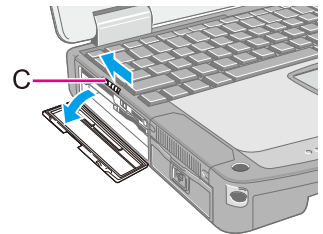

2 Insert the ExpressCard (upper slot) (D) or the PC Card (lower slot) (E) with the label side up until it securely fits in to the slot.

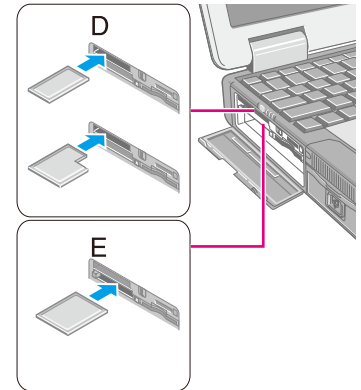

- For further information, refer to the instruction manual of the card.



■ To remove the card

1 Disable the card function.

Windows 7

- ① Click  on the notification area and click .
- ② Select the card.

Windows XP

- ① Double-click  on the notification area and select the card, then click [Stop].
 - ② Follow the on-screen instructions.
- These steps are not necessary when removing the card after turning off the computer.

2 Open the cover and remove the card.

- ExpressCard (F)
 - ① Press the card so it comes out of the slot.
 - ② Draw the card straight out.
- PC Card (G)
 - ① Press the eject button so the card comes out of the slot.
 - ② Draw the card straight out.

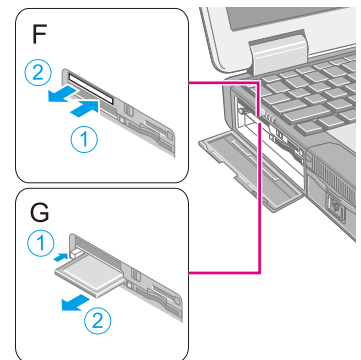

NOTE

- Check the card's specification to prevent the total operating current from exceeding the allowable limit. Otherwise malfunction may occur.
Allowable Current: 3.3 V: 400 mA, 5 V: 400 mA
- Some types of cards cannot be used simultaneously.
- After repeating insertion and removal, some types of card will not be recognized. In this case, restart the computer.
- If the computer freezes after resuming from sleep^{*1} or hibernation, remove and reinsert the card. If the problem persists, restart the computer.
- When a card is inserted, power consumption increases. Remove the card when it is not in use, especially when operating by battery power.
- To connect peripheral devices (SCSI, IEEE 1394, etc.) using a PC Card or an ExpressCard, follow the steps below (one example).
 - ① Connect the peripheral device to the card.
 - ② Turn on the power of device.
 - ③ Insert the card until it surely fits in the slot.

^{*1} Windows XP: standby

SD Memory Card Information

- This computer supports SDHC Memory Cards (SD Memory Cards with a capacity more than 2 GB).
- When you use a miniSD Card or a microSD Card, set the card to a miniSD Card adaptor or a microSD Card adaptor, and insert/remove the card with the adaptor. Be sure not to leave the adaptor in the card slot.
- The SD Memory Card has a copyright protection function which is compatible with content on-demand services on the Internet, etc.
- To format the SD Memory Card on this computer, do not use [Format] of Windows, but use the SD Memory Card format software.
You can download the software from the web site below.
http://panasonic.jp/support/global/cs/sd/download/sd_formatter.html
- To use the SD Memory Card on other devices, format the card on the devices. For further information, refer to the instruction manual of the devices.

Inserting/Removing the SD Memory Card

CAUTION

- Do not remove or insert the SD Memory Card until Windows has completed loading.
- Do not remove the card or turn off the computer in the following cases, otherwise the data may be corrupted.
 - While the computer is in sleep^{*1} or hibernation.
 - While the SD Memory Card indicator  is on.
 - While data is being read from or written to the card.
 - Immediately after the writing operation.

The computer may still continue the access to the card just after writing operation. If you remove the card before the operation is completed, the data may be damaged or the card access may no longer be performed normally.

- Note that Panasonic assumes absolutely no liability for any loss of data recorded by the user, or any other damages, direct or indirect.
- Do not forcibly draw out the card, otherwise the slot may be damaged.
- Insert the card in the correct direction, otherwise the card and the slot may be damaged.
- After resuming from sleep^{*1} or hibernation, do not access the SD Memory Card for approximately 30 seconds.

*1 Windows XP: standby

■ To insert the card

- 1** Slide the latch (A) and open the cover, and insert the SD Memory Card with the label side facing up and with the cut corner facing in (B).

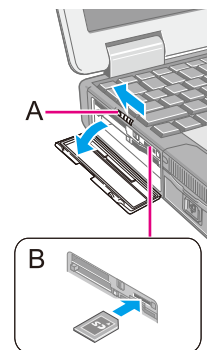



■ To remove the card

Preparation

- Save the data and close all applications.
- Open the cover and confirm the SD Memory Card indicator is off.

1 Disable the card function.

Windows 7

- ① Click  on the notification area and click .
- ② Select the card.

Windows XP

- ① Double-click  on the notification area and click [Secure Digital Storage Device], then click [Stop].
 - ② Follow the on-screen instructions.
- These steps are not necessary when removing the card after turning off the computer.

2 Remove the card.

- ① Press the card so it comes out of the slot.
- ② Draw it straight out.

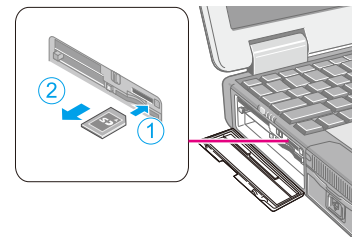
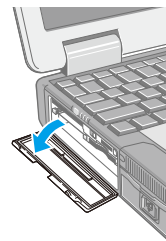

<Only for model with Smart card slot>

You need software and a driver to use a Smart card.

CAUTION

- Do not:
 - Hit, bend, or drop the card.
 - Touch the contact part with fingers or metal object.
 - Place the card in very hot location for a long time.
 - Remove the card immediately after inserting it.

Inserting/Removing the Smart Card

■ To insert the card

- 1 Slide the latch (A) and open the cover, and insert the Smart card with the contact part (B) in front.**

- Insert the card until it surely fits in the slot.

■ To remove the card

- 1 Press the eject button (C).**

The Smart card pops out.

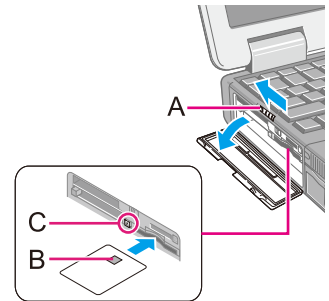

CAUTION

- Use the eject button to remove the card, otherwise the reading contact may be damaged.

Use RAM modules that comply with the specifications below. Using any other module may cause malfunction or result in computer failure.

RAM module specifications:

204 pins, SO-DIMM, 1.5 V, DDR3 SDRAM, PC3-8500

(For information of RAM module compatibility, contact Panasonic Technical Support.)

CAUTION

- RAM modules are extremely sensitive to static electricity and can be affected even by static electricity from the human body. When inserting and removing RAM modules, do not touch the terminals or internal components, and do not allow foreign particles to enter the slots. Doing so may cause damage, fire, or electric shock.

Inserting/Removing the RAM Module

1 Turn off the computer.

- Do not use sleep^{*1} or hibernation.

^{*1} Windows XP: standby

2 Disconnect the AC adaptor and remove the battery pack (→ [page 30](#)).

3 Remove the screws (A) and the cover (B) on the bottom of the computer.

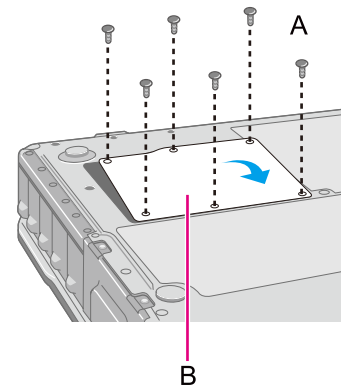

4 Insert/Remove the RAM module.

- To insert
 - ① Tilt the module slightly and insert it in the slot.
 - ② Align the cutout (C) with the projection, and press down the module so that the right and left hooks (D) are locked.

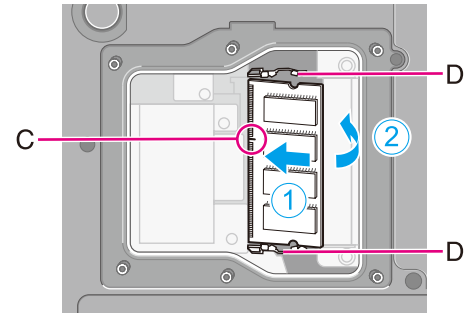

- To remove
 - ① Carefully open the right and left hooks (D). The module will rise.
 - ② Carefully remove the module from the slot.

5 Set the cover and battery pack.

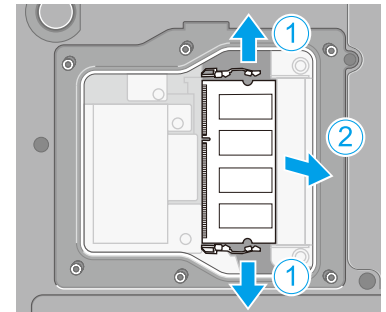

CAUTION

- Set the cover and battery pack correctly so that they do not fall when you carry the computer.

NOTE

- If it is hard to insert or to press down the RAM module, do not try forcibly but check the module's direction.
 - Use the appropriate screw driver so as not to strip the thread of screw.
 - If the RAM module is recognized correctly, the total size of the RAM module memory is displayed on the [Information] menu of the Setup Utility (→ [page 89](#)).
- If the RAM module is not recognized, power off the computer and insert it again.

Port Replicator / Car Mounter

You can use an optional port replicator and a car mounter. These devices free you from being bothered by a lot of cable connections when you carry the computer. They also allow you to connect various peripherals.

Connect the port replicator or the car mounter to the expansion bus connector (A) on the rear side of the computer.

For further information, refer to the instruction manual of the port replicator or the car mounter.

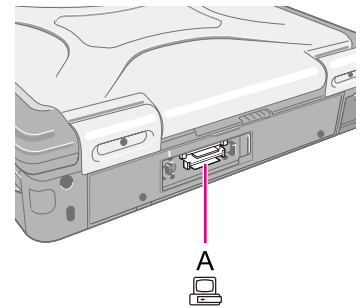

CAUTION

- Make sure the slide cover is completely open.
 - Hot or warm docking/undocking is not possible with the port replicator or the car mounter.
 - When an external display is connected to the port replicator or the car mounter and the 1280 x 1024, 1440 x 900*¹ or higher resolution is selected, the characters may be blurred on the external display. In this case, select the lower resolution.
 - To boot the computer from a USB floppy disk drive or a USB CD/DVD drive, be sure to connect the USB drive to the USB port on the computer, not to the USB port on the port replicator or the car mounter.
 - You cannot use the AC adaptor (CF-AA1653A) included with this computer for the port replicator or the car mounter. Contact Panasonic Technical Support.
 - When using a conventional port replicator (such as the CF-VEB272AW / CF-VEB272A2W), power consumption will automatically be lowered to match the port replicator's specification using one or more of the following measures.
 - The CPU clock rate is lowered.
 - The battery is not charged while the computer is turned on. (The battery indicator blinks in orange.)<When the discrete GPU with higher power consumption is activated>
 - The discrete GPU will be forcibly deactivated, and the Intel[®] GPU with lower power consumption will be activated.<When the discrete GPU with higher power consumption is activated>
 - If you connect a conventional port replicator (such as the CF-VEB272AW / CF-VEB272A2W) to the computer while the computer is turned on, a message that prompts you to restart the computer will appear. Follow the instructions, and restart the computer.
- <Only for CF-VEB272AW>
- To connect a USB 2.0 device, use the USB port of the computer.

*¹ Windows 7 only

NOTE

- When you do not use the expansion bus connector, close the slide cover so that portion (B) matches the mark (C).

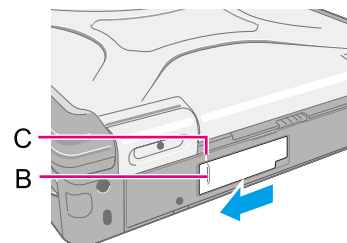

External Display

You can switch the output destination to an external analog display.
First slide the latch on the cover and open the cover.
Connect the external display to the external display port (A).

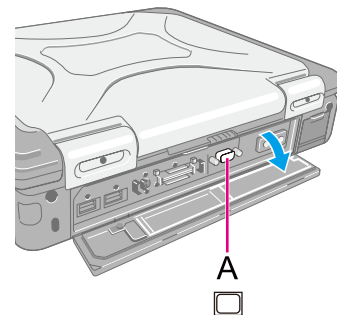

You can also switch the output destination to an external HDMI display.
First slide downward and open the cover.
Connect the HDMI display to the HDMI display port (B).

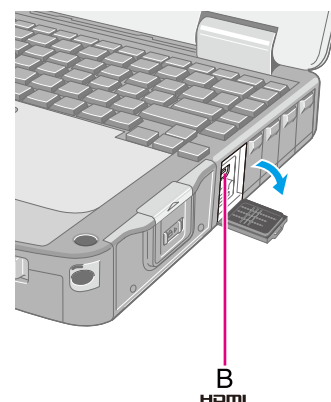

Switching the Display Mode

Windows 7

- 1 Press **⊞ + P** or **Fn + F3**.
- 2 Click the Display mode.

Windows XP

- 1 Press **Fn + F3**.

Each time you press the key combination:

→ LCD → LCD + HDMI display (port replicator side) → HDMI display (port replicator side) →
LCD + HDMI display (computer side) → HDMI display (computer side) → LCD + analog display →
analog display → HDMI display (computer side) + analog display

NOTE

- Until Windows startup is completed (during Setup Utility, etc.), the simultaneous display cannot be used and pressing **Fn + F3** switches the display between the internal LCD and the external display.
- After resuming from sleep^{*1} or hibernation, or restarting the computer, the output destination may not be the same as the selected in the previous status.
- When you change the display after Windows starts up, do not press any key until switching is complete.
- Display switching by pressing **Fn + P**^{*2} or **Fn + F3** may not work when you use the Fast User Switching function to switch the user. In this case, log off all users and restart the computer.
- Do not connect or remove the external display during sleep^{*1} or hibernation.
- It may take some time to switch between displays depending on the displays used.
- When you use the external display only, set the suitable number of colors, resolution, or refresh rate separately from when you use the internal LCD only or when you use the simultaneous display. Depending on the settings, some external displays may be distorted or may not display the mouse cursor correctly. In this case, set the settings to lower value.
- When you use the simultaneous display, DVD-Video, MPEG files and other motion image files may not be played back smoothly.
- Carefully read the instruction manual of the external display.
When connecting an external analog display that does not conform to the Plug & Play standards, select the display driver accordingly in the following menu, or use the driver disc supplied with the monitor.

Windows 7

- ①  (Start) - [Control Panel] - [Adjust screen resolution] - [Advanced Settings] - [Monitor] - [Properties].
 - A standard user needs to enter an administrator password.
- ② Click [Driver] - [Update Driver].

Windows XP

Click [start] - [Control Panel] - [Appearance and Themes] - [Display] - [Settings] - [Advanced] - [Monitor] - [Properties] - [Driver] - [Update Driver].

Windows XP

- Display switching does not work when [Command Prompt] screen is set to "Full Screen".

CAUTION

- Before disconnecting the external display, switch to the internal LCD by pressing **Fn + P**^{*2} or **Fn + F3**. Otherwise the displayed image quality may become different after disconnection (e.g., wrong resolution). In this case, press **Fn + P**^{*2} or **Fn + F3** to reset the image quality.
- The screen may become distorted due to the following operations. In this case, restart the computer.
 - Disconnecting an external display for which you have set high resolution or high refresh rate.
 - Connecting/disconnecting an external display during computer operations.

*1 Windows XP: standby

*2 Windows 7 only

Display Selector

You can connect up to four external displays when using a port replicator.

When an external display is connected, you can use the simultaneous display function and the extended desktop function. The extended desktop function allows you to use the working area across both the internal LCD and the external display. You can drag an object from the internal LCD to the external display and vice versa.

The Display Selector utility allows you to easily activate/deactivate the simultaneous display function and the extended desktop function.

It also allows you to set the scaling rate of an external HDMI display.

- 1 Click  (Start)^{*3} - [All Programs] - [Panasonic] - [Display Selector].
- 2 Make the required settings.

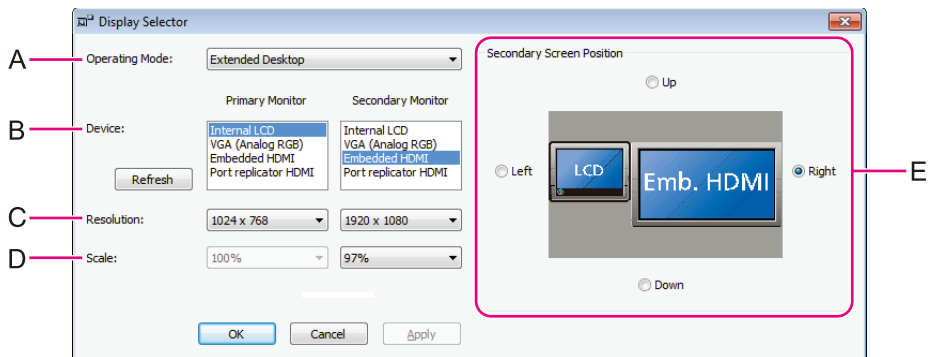

[Operating Mode] (A)

Select [Single Display] to activate only one display.

Select [Extended Desktop] to activate the extended desktop function.

Select [Clone Displays] to activate two displays.

After making a selection, click [Apply]. The following settings can then be made.

[Device] (B)

When [Extended Display] or [Clone Displays] is selected in [Operating Mode], select the displays to be used as the primary device and the secondary device.

When [Single Display] is selected, you can select only the primary device.

Internal LCD: Internal LCD

Embedded HDMI: HDMI display connected to the computer^{*4}

Port Replicator HDMI: HDMI display connected to the port replicator^{*4}

VGA (Analog RGB): Analog display connected to either the computer or the port replicator

[Resolution] (C)

Select the resolution of the display.

When [Extended Desktop] is selected in [Operating Mode], the resolution can be selected for the primary device and the secondary device independently.

[Scale] (D)

Set the scale rate of the display to 90%, 95%, 97% or 100%.

<For the model with Discrete Video Controller>

You can change the scale rate when [Single] or [Extended Desktop] is selected in [Operating Mode] and the discrete GPU is activated.

When the Intel[®] GPU is activated, you can change the settings when [Single] is selected.

<For the model without Discrete Video Controller>

You can change the scale rate when [Single] is selected in [Operating Mode].

[Secondary Screen Position] (E)

When [Extended Desktop] is selected in [Operating Mode], specify the position of the secondary monitor by selecting [Up], [Down], [Left] or [Right].

The display image with the black frame and the taskbar indicates the primary device, and the other indicates the secondary device.

3 Click [Apply] to enable the settings.

4 Click [OK].

^{*3} Windows XP: [start]

^{*4} [Embedded HDMI] and [Port Replicator HDMI] are available only for the model with Discrete Video Controller and when the discrete GPU is activated.

[HDMI] is displayed for the model without Discrete Video Controller or when the Intel[®] GPU is activated, and when only one HDMI display is connected to the computer or the port replicator.

NOTE

- It may not be possible to use the extended desktop with some software applications.
- When using the extended desktop, if you click the maximize button, the window is displayed on one of the displays. You cannot move the maximized window to the other display.
- When both an analog display and an HDMI display are connected, and if you select [Extended Desktop] or [Clone Displays], three output destinations (internal LCD, external analog display, and external HDMI display) can be selectable at both primary device and secondary device. In this case, the external analog monitor is referred to as “PC monitor” and the HDMI display is referred to as “Digital Television”.

- The pop-up icon displayed by **Fn** key combination appears only on the primary device.
- <Only for model with touchscreen>
Set the internal LCD to the primary device when using the touchscreen. The cursor will move on the primary device when you touch the internal LCD.

Windows XP

<When the Intel® GPU is activated and the extended desktop function is used>

- You cannot switch the display by pressing **Fn** + **F3**.
-

Various Ways to Change the Display Settings

In addition to the Display Selector utility, the following methods are available for changing display settings.

Windows XP

■ To switch to the extended desktop

- 1 Click [start] - [Control Panel] - [Other Control Panel Options] - [Intel(R) Graphics and Media] - [Display Devices].
- 2 Click [Extended Desktop], and make the settings for [Primary Device] and [Secondary Device].
- 3 Click [OK].
At the confirmation message, click [OK].

■ Using Catalyst™ Control Center utility

<When the discrete GPU with higher power consumption is activated>

- 1 Click  (Start) - [All Programs] - [Catalyst Control Center] - [CCC – Advanced].
- 2

Windows 7

Click [Graphics] - [Desktops & Displays].

Windows XP

Click [Display Manager].
- 3 Make the settings for the primary and secondary devices.
- 4 Click [OK].

Changing the Sound Output Destination

When an HDMI display is connected, you can specify sound to be output via the speakers of the personal computer or via the speakers of the HDMI display.

Make sure your HDMI display is equipped with speakers.

Windows 7

- 1 Click  (Start) - [Control Panel] - [Hardware and Sound] - [Sound Playback].
- 2 Select the sound output destination.
- 3 Click [Set Default], and then click [OK].

Windows XP

- 1 Click [start] - [Control Panel] - [Sound, Speech, and Audio Devices] - [Audio].
- 2 Select the sound output destination in [Default Device].
- 3 Click [OK].

Connecting/Removing USB Devices

Preparation

Attach the device for the media containing the device driver (e.g., CD-ROM). Equipment connected to the multimedia pocket cannot be recognized if connected after the USB device driver installation screen appears.

■ To connect the USB device

- 1 **Open the cover and connect the USB device to one of the USB ports (A, B, C or D).**

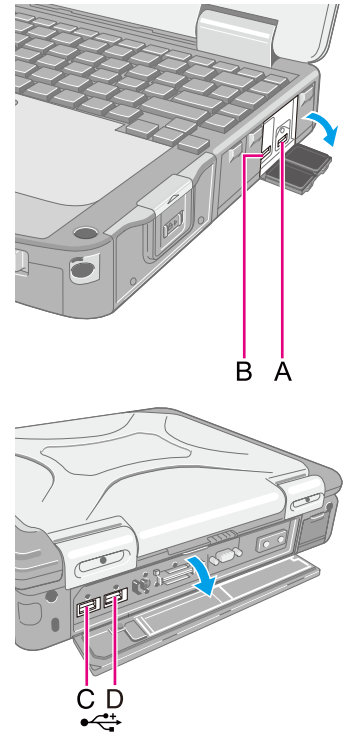

For further information, refer to the instruction manual of the USB device.





■ To remove the USB device

- 1 **Disable the USB device.**

Windows 7

- ① Click  on the notification area and click .
- ② Select the USB device.



Windows XP

- ① Double-click  on the notification area and select the USB device, then click [Stop].
 - ② Follow the on-screen instructions.
- These steps are not necessary when;
 - Removing the device after turning off the computer.
 -  or  is not displayed.
 - The device does not appear in the list in step ①.



2 Remove the USB device.

CAUTION

<Only for model with Smart card slot>

- If you double-click  or , [USB Smart Card Reader] is displayed in the list, but do not select this item. Removing this item is not possible. Restart the computer in case you select this.

NOTE

- You may need to install the driver for the USB device. Follow the on-screen instructions or refer to the instruction manual of the USB device.
- You may need to install the driver again when connecting the device to another port.
- When a USB device is connected, sleep^{*1} and hibernation may not function normally. If the computer does not start up normally, remove the USB device and restart the computer.
- When the USB device is removed and then inserted while the computer is on,  or  may appear in the Device Manager and the device may not be correctly recognized. In this case, remove and connect the device again, or restart the computer.
- When the USB device is connected, power consumption increases. Remove the USB device when it is not in use, especially when operating by battery power.

Windows 7

- If the computer enters sleep or hibernation while a USB keyboard or mouse is connected, touching the USB keyboard keys or mouse will resume the computer.

*1 Windows XP: standby

<Only for the model with IEEE 1394 interface>

You can connect a digital video camcorder or other IEEE 1394 standard device to the computer.

■ To connect IEEE 1394 device

Preparation

Attach the device for the media containing the driver (e.g., CD-ROM). Equipment connected to the multimedia pocket cannot be recognized if connected after the IEEE 1394 device driver installation screen appears.

- 1 Turn on the computer and the IEEE 1394 device.**
- 2 Slide downward and open the cover, and connect the IEEE 1394 device to the IEEE 1394 interface connector (A).**

For further information, refer to the instruction manual of the IEEE 1394 device.

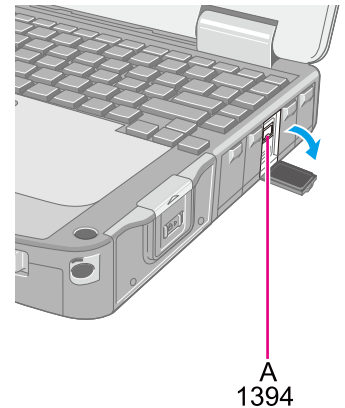

NOTE

- You may need to install the driver for the IEEE 1394 device. Follow the on-screen instructions or refer to the instruction manual of the IEEE 1394 device.

■ To remove IEEE 1394 device

CAUTION

- Turn off the IEEE 1394 device only after turning off the computer.

- 1 Turn off the computer and disconnect the cable from the IEEE 1394 interface connector.**
- 2 Turn off the IEEE 1394 device and remove the cable.**

<Only for model with Fingerprint Reader>

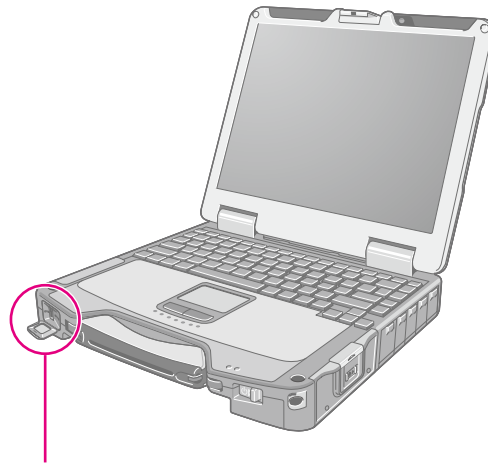

Fingerprint Reader

NOTE

- Enrollment and authentication is unavailable to an extremely minority of people including those whose fingerprints give little data for personal identification.

How to Use the Fingerprint Reader

This section explains how your fingerprints are enrolled and authenticated.

1 Slide your finger to the right or left.

- To prevent a reading error.
 - ① Set the first joint of your finger on the sensor as illustrated to the right.
 - ② Slide your finger to the right or left while keeping it in contact with the fingerprint sensor.
 - ③ Slide your finger to the right or left until the sensor is visible.
 - When the fingerprint sensor does not enroll or authenticate your fingerprint properly:
 - You slid your finger too fast or too slow.
 - Your finger was soiled or it has a scar on the surface.
 - Your finger was wet or extremely dry.
 - Your fingerprint does not have sufficient data for personal identification.
- For further information, refer to “Fingerprint Reader” (→ [page 121](#)).

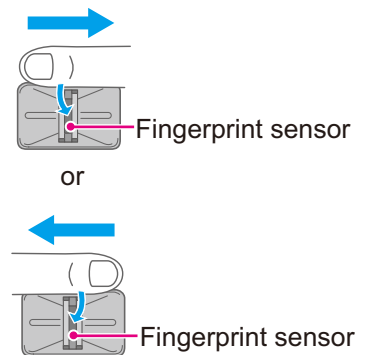

CAUTION

- To protect the fingerprint sensor, be sure to close the cover when not using the fingerprint reader.
- We shall not be liable for any loss or damage whatsoever resulting from your Fingerprint device or neglect of Fingerprint device use, or any data loss resulting from such developments as Fingerprint authentication device malfunctioning.

Overview

Fingerprint's Outline

The conventional security systems use ID/passwords and token devices such as IC cards to authenticate users. Therefore the passwords and token devices are exposed to the risk of being lost, stolen and hacking. The Fingerprint authentication method uses user's fingerprints instead of passwords for security authentication. You can use your fingerprints to start up your computer and log on Windows. We recommend you use the Fingerprint Reader in combination with the TPM (Trusted Platform Module) to increase the security level of your computer.

Recommended Installation Procedure

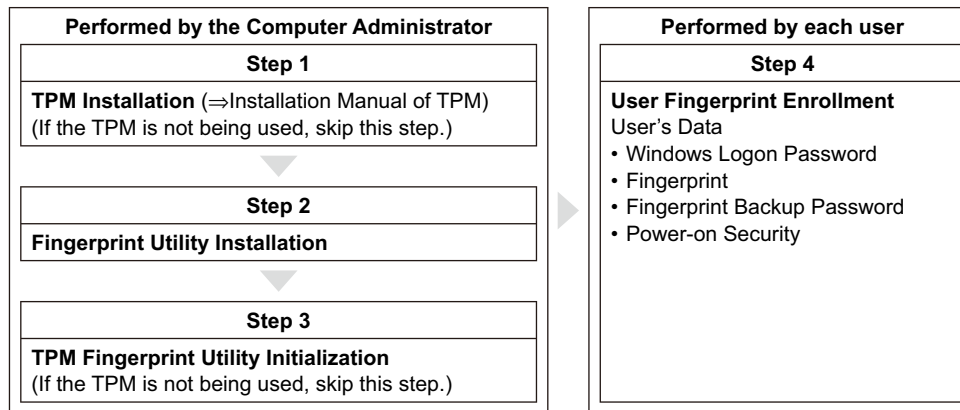

■ To access the online manual

This manual describes Step 2, 3 and the initial part of Step 4.
For further steps, refer to the Protector Suite Help menu.

- Click  (Start)^{*1} - [All Programs] - [Protector Suite] - [Control Center] - [Help] - [Help].

^{*1} Windows XP: [start]

Precautions

■ Security Functions

- Fingerprint Authentication Technology does not guarantee complete authentication and individual identification. Please acknowledge we shall not be liable for any loss or damage whatsoever resulting from the use of, or inability to use your Fingerprint device.
- The Fingerprint authentication method uses multiple fingerprints, encryption keys, credentials data and passwords. You might not be able to use your data if you lose fingerprints, keys, credentials and passwords. Back up the Fingerprint authentication data in a safe place. For further information, refer to “Backup” (→ [page 64](#)).
- General interaction with third-party applications: There is no guarantee that there will not be any negative interaction with any third-party software, and will not accept any responsibility for such an interaction.

Installation

1 TPM Installation

Refer to the *Installation Manual* of “Trusted Platform Module (TPM)”.

Windows 7

Click  (Start), input “c:\util\drivers\tpm\readme.pdf” in [Search programs and files], and press **Enter**.

Windows XP

Click [start] - [Run] and input “c:\util\drivers\tpm\readme.pdf”, and click [OK].

2 Fingerprint Utility Installation

Performed by the Computer Administrator.

- ① Log on to Windows as an Administrator.
- ② Close all other programs.



③ Windows 7

Click  (Start), input “c:\util\drivers\fngprint\install\32-bit\Setup.exe” in [Search programs and files], and press **Enter**.

Windows XP

Click [start] - [Run] and input “c:\util\drivers\fngprint\install\32-bit\Setup.exe”, and click [OK].

- ④ Click [Next].
Installation starts. Follow the on-screen instructions.
- ⑤ When the “Protector Suite *.* has been successfully installed.” message appears, click [Finish].
At the confirmation message, click [Yes].
The computer restarts.

- ⑥ Log on to Windows as an Administrator.
The “Fingerprint software Icon”  appears in the notification area.
 - If the icon does not appear, click .



3 TPM Fingerprint Utility Initialization

Performed by the Computer Administrator.

The “Invalid TPM status” message is displayed by the “Fingerprint software Icon”  in the notification area.

- If the icon does not appear, click .
- If the TPM is not being used, skip this step.
 - ① Click on the “Invalid TPM status” message and then click [Initialize].
Follow the on-screen instructions.

NOTE



- If the “Invalid TPM status” message is not displayed
Click  (Start)² - [All Programs] - [Protector Suite] - [Control Center] - [Settings] - [Advanced Settings] - [Trusted Platform Module (TPM)] - [Initialize]. And then click  (Start)² - [All Programs] - [Protector Suite] - [Control Center] - [Identity] - [Multifactor], and choose a method of authentication.

4 User Fingerprint Enrollment

Performed by each user.

- ① Double-click the “Fingerprint software Icon” .
- ② Carefully read the License Agreement, and then click [Accept].
- ③ Select an enrollment mode, and click [Apply].
 - Enrollment mode
You can make the configuration for the enrollment only once during this initialization phase.
 - Enrollment to the biometric device
All enrolled fingerprints are stored directly in the fingerprint sensor. The user data will be secured by the hardware protection keys obtained by the fingerprint sensor. This mode allows up to about 15 fingerprints to be enrolled.
 - Enrollment to the hard disk
All enrolled fingerprints are stored on the hard disk. Hardware protection of the user data is not possible, but multiple users can enroll their fingerprints.
 - Follow the on-screen instructions.

NOTE

- Enroll at least two fingers. Even if one of them is injured, you can use another one to access your account and secret data. For further information about the enrollment, refer to “How to Use the Fingerprint Reader” (→ [page 58](#)) and [Tutorial].
 - Click  (Start)^{*2} - [All Programs] - [Protector Suite] - [Control Center] - [Help] - [Tutorial].
- We recommend you use the Power-on Security feature. This feature prevents unauthorized access to the user's computer at the BIOS level.
 - ① Click  (Start)^{*2} - [All Programs] - [Protector Suite] - [Control Center].
 - ② Click [Identity] - [Status].
 - ③ Click [Power-on security status] - [Change].
 - ④ Click [Edit], and Add the check mark to [Enable power-on security], and then click [Apply].
 - ⑤ Click [Identity] - [Power-on Password].
 - ⑥ When the “Power-on Security” screen appears, click [Manage Passwords...].
 - ⑦ Select [Power-On] in [Password Types], and click [Set password...].
 - ⑧ Enter the Power-On password, and click [OK].
 - ⑨ Click [Close].
 - ⑩ Add a check mark for [Power-On] in [Password Types].
 - ⑪ Enter the Power-On password, and click [OK].
 - ⑫ Click [Apply].

^{*2} Windows XP: [start]

More Advanced Security

You can increase your computer's security level by setting the BIOS level described in this section. Performed by the Computer Administrator.

1 Register the Supervisor Password.

You have to register the Supervisor Password to proceed to the next step.

If you have already registered the Supervisor Password, you can skip this step, and move on to step 2.

If you have not done this, have enrolled your fingerprint using Protector Suite, and have already made Power-on Security effective, after step 2, your fingerprint authentication will be necessary.

- ① Turn on or restart the computer.
- ② Press **F2** or **Del** while [Panasonic] boot screen is displayed soon after the computer starts the startup procedure.
- ③ Select the [Security] menu.
- ④ Select [Setup Supervisor Password], and press **Enter**.
- ⑤ Enter your password in the [Create New Password], and press **Enter**.
 - The password will not be displayed on the screen.
 - You can use up to 32 alphanumeric characters (including spaces).
 - The case (upper/lower) is ignored.
 - Use only the upper horizontal row of numeric keys to input your password.
 - You cannot use **Shift** and **Ctrl** to input a password.
- ⑥ Enter your password again in [Confirm New Password], and press **Enter**.

2 Set the High Security Level.

- ① Select [Fingerprint Security], and press **Enter**.
- ② Select [Security mode], and select [High].
 - Default setting: Simple
- ③ Press **Esc** to close the sub-menu.
- ④ Press **F10**, select [Yes], and press **Enter** to exit the Setup Utility.

NOTE

- In the [High] security mode, you have to enter the Supervisor or User Password even after fingerprint authentication. In the [Simple] security mode, you do not have to enter the Supervisor or User password after fingerprint authentication.
- To use the Power-on Security feature, enable it in [Control Center] (→ [page 62](#)). Change the setting of [Power-on Security] in the Setup Utility only in the specific case such as the Finger print device cannot be used.

Useful Information



Backup

The file described below is necessary for recovering the Fingerprint authentication data. Back up this file periodically in a safe location such as removable disk to avoid data loss resulting from some accidents. We recommend you to store the file in a removable disk or network drive because the benefit of Fingerprint authentication security can be reduced if you keep the file in the internal hard disk drive.

The backup password described below is necessary for bypassing the Fingerprint authentication. We recommend you set the backup password using the [User Enrollment] wizard. If you do not define the backup password, you may lose your data in case of authentication hardware failure.

- File used by each user
 - Backup user passport data
(Default name: <UserAccount>.vtp)
You need this file when you replace the embedded fingerprint chip, or the hard disk drive, or when reinstalling Windows. This file contains the fingerprints, encryption keys, and logon authentication data.

NOTE

- How to Backup:
Select [Identity] in [Account Operation] to save the user data.
 - Click  (Start)^{*3} - [All Programs] - [Protector Suite] - [Control Center] - [Identity] - [Account Operation].
For further information, refer to the Protector Suite Help menu.
 - Click  (Start)^{*3} - [All Programs] - [Protector Suite] - [Control Center] - [Help] - [Help].
- Password used by each user
 - Backup Password for Enrollment
This backup password can be used in case of hardware failure to bypass the fingerprint authentication.

CAUTION

- The passwords other than those explained above are also used for security, so do not lose them.
For further information, refer to the Protector Suite Help menu.
 - Click  (Start)^{*3} - [All Programs] - [Protector Suite] - [Control Center] - [Help] - [Help].

^{*3} Windows XP: [start]

Limitations in Use

- Password Bank^{*4} limitations: The following web pages cannot be supported.
Web pages which are created by the following technologies:
 - Web forms created on the fly using JavaScript.
 - Web forms which looks as one form (e.g. login field, password field), but internally created with two independent forms.
 - There can be auto submit problems with web forms which do not have Submit button. All forms that you cannot submit with **Enter** will be entered by Password Bank, but not submitted.
- Password Bank^{*4} limitations: The following Windows applications cannot be supported.
 - Applications which do not use standard Windows controls and draw controls by their own.
 - This includes any Java based application.

^{*4} For further information, refer to the Protector Suite Help menu.

- Click  (Start)^{*5} - [All Programs] - [Protector Suite] - [Control Center] - [Help] - [Help].

- “Sensor Scrolling Feature” is not supported.

^{*5} Windows XP: [start]

Handling & Maintenance

- The enrolling and authentication sensitivity may decline under the conditions below. Wipe off stains or moisture on the sensor surface with a soft cloth.
 - The surface of the fingerprint sensor is soiled with dust, skin oil, or sweat.
 - The surface of the fingerprint sensor is wet as a result of moisture or condensation.
- Static electricity may also cause the sensor to malfunction. To make your finger static-free, touch a metal surface before placing it on the fingerprint sensor. Exercise caution against static electricity in winter and other dry conditions.
- Malfunction or damage may occur when:
 - The fingerprint sensor surface was damaged by the strong rubbing of a solid material, scratches, or being pecked with a pointed item.
 - The sensor was touched with a finger soiled with mud, damaging the sensor surface with a tiny substance, and staining the surface.
 - The sensor surface was covered with a seal, or soiled with ink.

Deleting (Initializing) Owner's Data

When you dispose of the computer or transfer the ownership, delete (initialize) the owner's data to avoid unauthorized access.

NOTE

- The data enrolled in the fingerprint sensor is not image data. You cannot restore fingerprint image data from the data enrolled in the fingerprint sensor.

1 Disable Power-on Security

- ① Log on to Windows as an Administrator.
- ② Click  (Start)^{*6} - [All Programs] - [Protector Suite] - [Control Center].
- ③ Click [Identity] - [Status] - [Power-on security status].
- ④ Click [Edit], and remove the check mark from [Enable power-on security], and click [Apply].
- ⑤ Click [Identity] - [Power-on Password].
- ⑥ Click [Manage Passwords...].
- ⑦ Select [Power-On] in [Password Types], and click [Unset password...].
- ⑧ Enter the Power-On password, and click [OK].
- ⑨ Click [Close].
 - Confirm that fingerprint data is not registered.

2 Delete Fingerprint Data.

Performed by each user.

- ① Click  (Start)^{*6} - [All Programs] - [Protector Suite] - [Control Center].
- ② Click [Identity] - [Account Operation].
- ③ Click [Delete user data].
 - At the confirmation message, click [Yes].
- ④ Enter Windows log on password then, click [Submit].
 - Confirm that there is no item in [Password Types].

3 Uninstall Protector Suite

Performed by the Computer Administrator.

- ① Log on to Windows as an Administrator.
- ② Close all programs.
- ③ Click  (Start)^{*6} - [Control Panel] - [Uninstall a program].
- ④ Double-click [Protector Suite *.*], and select [Remove].
- ⑤ Select [Remove all Protector Suite *.* data], and click [Next].
 - Uninstallation starts. Follow the on-screen instructions.
- ⑥ When the "Protector Suite *.* has been successfully uninstalled." Message appears, click [Finish].
 - If the confirmation message appears, click [Yes].

- The computer restarts.

*6 Windows XP: [start]

Starting Over

If the specific solutions for your problem in Fingerprint Reader (→ [page 121](#)) do not work, you can use these instructions as the last measure and start over. However, please note that you can lose your data - passwords, secret keys and fingerprints.

- ① Log on to Windows as an Administrator.
 - You can always access the computer by using your Windows log on password.
- ② Try to export your passport to a file if you are planning to use your passwords, secret keys or enrolled fingers in the future.
 - If you exported your passport recently, this step is not required.
 - If biometrics authorization works and your finger is recognized, use [Account Operation] wizard, swipe your finger and continue according to wizard's instructions.
 - If biometrics authorization works, but your finger is not recognized, you can start the [Account Operation] wizard and export the passport even without using your fingerprint. You need to cancel fingerprint dialog, and you will be prompted for a password. If you do not use backup password, enter your Windows log on password. Otherwise, enter your backup password.

CAUTION

- We recommend you set the backup password.
 - If biometrics authorization does not work, there is no way to backup your data.
- ③ Deleting the passport.
 - Use the [Delete your data] wizard. Please note that all your stored secret data (passwords, [File Safe] encryption keys [Personal Safe] data) will be lost. If you backed up the data, you can restore it in the next step; otherwise it will be lost permanently. To perform the delete operation it is necessary to cancel the fingerprint verification operation to get to the password dialog, then enter your Windows log on password or backup password.
 - ④ Make sure your fingerprint sensor is working.
 - Use the Tutorial wizard to verify that the fingerprint sensor works. If not, reboot and try again. If it still does not work, please contact Panasonic Technical Support.
 - ⑤ Restore or create passport.
 - If you have a backup of your data, you can now use [Account Operation] wizard to restore your data. Otherwise you can create a new passport by using the [Manage Fingerprints] wizard.

<Only for model with modem>

Connecting the Internal Modem with a Telephone Jack

CAUTION

- You cannot connect the modem to the following lines.
 - Interphone
 - Intercoms
 - ISDN
- Be sure to connect the telephone cable into the modem port, not into the LAN port.
- Use a surge protector since the modem may be damaged by a sudden high voltage surge that may occur in the event of a lightning strike.

1 Slide downward and open the cover and connect the telephone jack (A) to the computer by using the telephone cable (B).

- Hold the cable so that the shape of the connector (C) matches the port, and insert fully until it clicks.

2 **Windows 7**

Click  (Start) - [Control Panel] - [Connect to the Internet] - [Dial-up] and change the settings as necessary.

Windows XP

Click [start] - [Control Panel] - [Printers and Other Hardware] - [Phone and Modem Options] and change the settings as necessary.

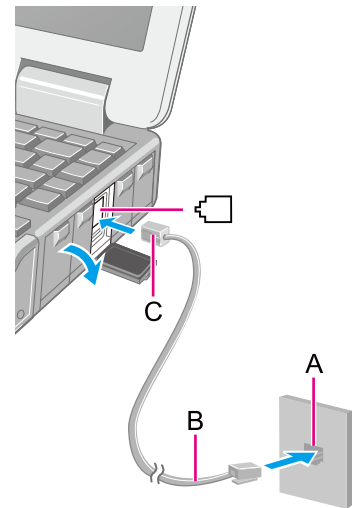

NOTE

- Do not enter sleep^{*1} or hibernation during communications.
- To remove the cable, press and hold the lever and pull out.



*1 Windows XP: standby

Ring Resume Function

The computer automatically resumes from sleep*² when the telephone connected to the modem rings. You will need software to keep the computer in idle state waiting for a phone call, and if you prefer, to turn the computer to sleep*² again afterward. For further information, refer to the instruction manual of the software application.

■ To enable this function

Windows 7

- 1 Click  (Start) - [All Programs] - [Windows Fax and Scan].
- 2 Click [Tools] - [Fax Settings].
 - A standard user needs to enter an administrator password.
 - Check whether the modem you are using is displayed in Device name. If not, click [Select fax device] and select the correct modem.
- 3 Add a check mark for [Allow the device to receive fax calls] and click [OK].
- 4 Click  (Start) - [Computer] - [System properties] - [Device Manager].
 - A standard user needs to enter an administrator password.
- 5 Double-click [Modems], and then double-click the internal modem.
- 6 Click [Power Management] and add a check mark for [Allow this device to wake the computer], and then click [OK].



Windows XP

- 1 Click [start] - [Control Panel] - [Performance and Maintenance] - [System] - [Hardware] - [Device Manager] - [Modems], and double-click the internal modem.
- 2 Click [Power Management], add the check mark for [Allow this device to bring the computer out of standby.], and click [OK].

■ To set the time to return the computer to sleep*²

The computer will enter sleep*² after the set time even when the communication is not completed. You can avoid such uncompleted communication if you select [Never], but the computer does not return to sleep*² after resuming by a phone call.

① Windows 7

Click  or  on the notification area and click [More power options] - [Change when the computer sleeps].

Windows XP

Click [start] - [Control Panel] - [Performance and Maintenance] - [Power Options] - [Power Schemes].

② Set the expected communication time for the sleep^{*2} setting.

NOTE

- This function does not work when the computer is off or in hibernation.
- Connect the AC adaptor.
- The screen remains dark after the computer resumes from sleep^{*2}. The previous screen display will be restored when you touch the keyboard, touch pad or touchscreen (only for model with touchscreen).
- The computer cannot resume if the telephone is not connected to the internal modem. (e.g., you cannot use a PC Card modem.)
- The computer needs some time to respond, so set the calling time longer than normal. If this is not possible on the transmission side, reduce the number of rings before answering on the software that you are using to keep the computer in idle waiting for the call.

^{*2} Windows XP: standby

Connecting LAN

CAUTION

- Do not connect the telephone cable to the LAN port.

1 Turn off the computer.

- Do not use sleep^{*1} or hibernation.

2 Slide downward and open the cover, and connect the cable.

Connect the LAN port (A) and the network system (server, HUB, etc.) using a LAN cable.

3 Turn on the computer.

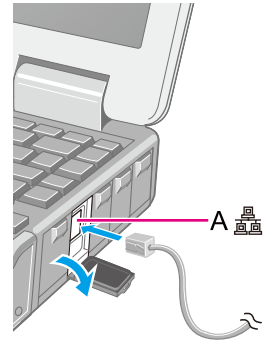

<Only for model with 2nd LAN>

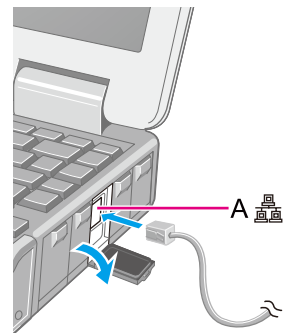

NOTE

- The communication speed using the 2nd LAN port is lower than that of the other LAN port.

Power On by LAN/Wake Up from Wired LAN

NOTE

- With this function enabled, power is consumed even if the computer is in sleep^{*1}, hibernation, or powered off. Be sure to use the AC adaptor.
- Even when a password is set in the Setup Utility and [Password On Boot] or [Password On Resume] is set to [Enabled], entering the password is unnecessary for turning on or resuming the computer.
- Connect the AC adaptor.
- The Power On by LAN function is off under the following conditions:
 - When you turn the computer off by sliding the power switch for 4 seconds or longer (e.g., after a hung-up).
 - When you reattach the AC adaptor and battery pack to the computer after removing them.
- The screen remains dark when the computer resumes from sleep^{*1}. The previous screen display will be restored when you touch the keyboard, touch pad or touchscreen (only for model with touchscreen).

^{*1} Windows XP: standby

Enabling the Power On by LAN function

The computer automatically turns from off to on when the computer is accessed from the network server via the internal LAN port.

- 1** Select [Allow] in [Power On by LAN] in the [Advanced] menu of the Setup Utility (→ [page 93](#)).
- 2** In [Caution], press **Enter**.
- 3** Press **F10**, and then select [Yes] and press **Enter**.
- 4** Log on to Windows as an administrator.
- 5** **Windows 7**
Click  (Start) - [Computer] - [System properties] - [Device Manager], and double-click [Network adapters] - [Intel(R) 82577LM Gigabit Network Connection], and then click [Advanced].

Windows XP

Click [start] - [Control Panel] - [Performance and Maintenance] - [System] - [Hardware] - [Device Manager] - [Network adapters] and double-click [Intel(R) 82577LM Gigabit Network Connection], and then click [Advanced].

6 Click [Enable PME] in [Property] and select [Enabled] in [Value], and then click [OK].

NOTE

- The computer may accidentally turn on if the linkage status is changed. To prevent the accidental startup, make the setting by the following steps.

① Windows 7

Click  (Start) - [Computer] - [System properties] - [Device Manager].

- A standard user needs to enter an administrator password.

Windows XP

Click [start] - [Control Panel] - [Performance and Maintenance] - [System] - [Hardware] - [Device Manager] - [Network adapters].

② Double-click [Network adapters] - [Intel(R) 82577LM Gigabit Network Connection], and click [Advanced].

③ Click [Wake on Settings] in [Property] and select [Wake on Magic Packet] in [Value], and then click [OK].

- If you forcibly shut down Windows, the Power On by LAN function will not work.

<Only for the model with 2nd LAN>

- The 2nd LAN port does not support the Power On by LAN function.

Enabling/Disabling the Wake Up from wired LAN function

When the Wake Up from wired LAN function is enabled, the computer automatically resumes from sleep^{*2} or hibernation when the computer is accessed from the network server via the internal LAN port. (Default setting)

The Wake Up from wired LAN function can be switched to enable/disable by performing the following procedure.

1 Windows 7

Click  (Start) - [Computer] - [System properties] - [Device Manager].

- A standard user needs to enter an administrator password.

Windows XP

Click [start] - [Control Panel] - [Performance and Maintenance] - [System] - [Hardware] - [Device Manager].

2 Double-click [Network adapters]- [Intel(R) 82577LM Gigabit Network Connection].

- 3** Click [Power Management], add (to enable) or remove (to disable) check marks of [Allow the computer to turn off this device to save power] and [Allow this device to wake the computer]^{*3}, and then click [OK].

- We recommend you to make the above 2 settings ON/OFF simultaneously.

NOTE

- The computer may start up if accessed by another computer on the network. The following procedure can be used to prevent startup due to unintentional access by a computer.
 - ① **Windows 7**
Click [Start] - [Computer] - [System properties] - [Device Manager].
 - A standard user needs to enter an administrator password.
 - ② **Windows XP**
Click [start] - [Control Panel] - [Performance and Maintenance] - [System] - [Hardware] - [Device Manager].
 - ③ Double-click [Network adapters] - [Intel(R) 82577LM Gigabit Network Connection].
 - ③ Click [Power Management], add a check mark for [Only allow a magic packet to wake the computer]^{*4}, and then click [OK].

*2 Windows XP: standby

*3 Windows XP: [Allow this device to bring the computer out of standby.]

*4 Windows XP: [Only allow management stations to bring the computer out of standby.]

<Only for model with wireless LAN, wireless WAN, and/or Bluetooth>

There are several ways of disabling and enabling wireless communication.

- The wireless switch on the left side of the computer (below)
- Wireless Switch Utility (→ [page 76](#))
- Settings in the [Advanced] menu of the Setup Utility (→ [page 94](#))
- Setting in the Wireless Connection Disable Utility (→ [page 77](#))

Windows 7

- Settings in the Network and Sharing Center (→ [page 80](#))

NOTE

- For further information about Wireless LAN: (→ [page 80](#))
- For further information about Bluetooth: (→ [page 85](#))
- For further information about Wireless WAN: Refer to the instruction manual of the wireless device.
- The wireless communication can be enabled or disabled by connecting or disconnecting the LAN cable. (→ [page 77](#))

The Wireless Switch

■ To disable all wireless communication

- 1 Slide the latch (A), open the cover and slide the switch (B) to OFF.

■ To enable wireless communication

- 1 Slide the latch (A), open the cover and slide the switch (B) to ON.
 - In the default setting, the wireless switch enables all wireless devices when it is set to ON.

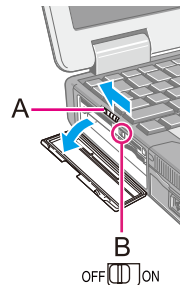

■ To check the wireless communication status

Windows 7

- 1 Click  on the notification area and place the cursor over the Wireless Switch Utility icon ( or ).

A tool tip appears.

Windows XP

- 1 Perform either of the following procedures.

- Double-click , , , or  on the notification area.
- Click [start] - [All Programs] - [Intel PROSet Wireless] - [WiFi Connection Utility].

NOTE

- If you uninstall the Wireless Switch Utility, set the wireless switch to ON beforehand.
- Do not turn on/off the switch repeatedly at too short intervals.
- Do not restart, log off, or enter sleep*¹ or hibernation immediately after turning on/off the switch.
- Do not turn on/off the switch while Windows is starting up.
- To use wireless communication, set the wireless devices ([Wireless LAN] / [Bluetooth] / [Wireless WAN]) to [Enabled] (default) in the [Advanced] menu of the Setup Utility (→ [page 94](#)).
- When you set [Wireless Switch] to [Disabled] in the [Advanced] menu of the Setup Utility (→ [page 94](#)), the Wireless Switch Utility icon will not appear in the notification area. All wireless equipment (wireless LAN, Bluetooth, wireless WAN) will remain ready irrespective of the wireless switch setting.
- It may take some time to turn off wireless communication after switching the wireless switch off.
- If the IEEE802.11a setting is changed in [Device Manager] (→ [page 83](#)), the display will be changed accordingly.



*1 Windows XP: standby

Wireless Switch Utility

This utility allows you to control the function of the wireless switch. This utility also allows you to enable or disable wireless devices from a pop-up menu. In the default setting, all wireless devices are enabled.

■ The Wireless Switch Utility icon

The icon appears when click  on the notification area. It shows the status of wireless devices.

-  : Indicates that the wireless devices are enabled.
-  : Indicates that the wireless devices are off.
-  : Indicates that the wireless devices have been disabled in the Setup Utility.

■ To enable or disable particular wireless devices

- 1** Click the Wireless Switch Utility icon to show the pop-up menu.
- 2** Select ON or OFF for the device you want to enable or disable.

■ To change the function of the wireless switch

In the default setting, the wireless switch enables devices that you select turning the wireless switch off last time. You can change this function.

[Selects the device for which to turn the device status on each time with the dialog box.]



Display a dialog each time you set the wireless switch to ON so you can choose which wireless device to enable.

[Turns on the following device.]

Only selected devices are enabled when you set the wireless switch to ON.

[Turns on the device that was on immediately before the wireless switch was turned off the last time.] (default)

When you turn on the wireless switch, the on/off settings that were selected when you last turned off the wireless switch will be restored.

- 1 Click  on the notification area and click the Wireless Switch Utility icon ( or ).
- 2 Click [Settings].
- 3 Select the setting you want to assign to the wireless switch.
- 4 Click [OK].

Wireless Connection Disable Utility

You can automatically disable the wireless LAN/wireless WAN connection when a LAN cable is connected to your computer. You need to install the Wireless Connection Disable Utility to use this function.

Installing the utility

- 1 Log on to Windows as an administrator.
- 2 **Windows 7**
Click  (Start) and input [c:\util\wdisable\setup.exe] in [Search programs and files], and press **Enter**.
Windows XP
Click [start] - [Run] and input “c:\util\wdisable\setup.exe”, and click [OK].
- 3 Follow the on-screen instructions to install the Wireless Connection Disable Utility.

Checking the status of the wireless connection

NOTE

- The Wireless Switch Utility should also be installed so that the Wireless Connection Disable Utility works. The Wireless Switch Utility has already been installed at the factory.
 - To use the utility, set [Wireless Switch] to [Enabled] in the [Advanced] menu of the Setup Utility (→ [page 94](#)).
 - The utility does not automatically disable the Bluetooth connection.
-

■ Status indication

After installation, the Wireless Connection Disable Utility is automatically started after a user is logged in. An icon appears on the notification area.



: Indicates that

- the utility is enabled, and
- the wireless connection is disabled since a LAN cable is connected.



: Indicates that

- the utility is enabled, and
- the wireless connection is enabled since no LAN cable is connected.



: Indicates one of the following statuses;

- the utility does not monitor the LAN port status,
- the Wireless Switch Utility has not been started, or
- [LAN] is disabled in the [Advanced] menu of the Setup Utility or in the device manager.

■ Menu

Right-clicking the utility icon opens a menu as follows.

Clicking the menu item causes the following utility action.

Monitoring LAN Cable: ON

Enables the Wireless Connection Disable Utility to monitor the LAN port and disable wireless connection when a LAN cable is connected.

Monitoring LAN Cable: OFF

Disables the Wireless Connection Disable Utility, and enables wireless connection regardless of whether a LAN cable is connected or not.

Exit

Exits the Wireless Connection Disable Utility and enables wireless connection.

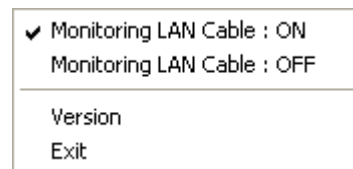

<Only for model with wireless LAN>

CAUTION

- **Do not use wireless LAN on airplanes, in hospitals, or in other locations where wireless LAN signals may affect devices.**
Follow the instructions of airline companies and hospitals. If you use the computer in these locations, turn off the wireless LAN.
- **To avoid unauthorized access to the computer through wireless LAN**
We recommend you to make security settings such as encryption before using wireless LAN. Otherwise the hard disk data such as the shared files can be exposed to the risk of unauthorized access.

NOTE

- Communication is established through the wireless LAN antenna (A). Do not block the antenna area with your hand or body.
- You cannot use the wireless LAN function together with the Fast User Switching function.
- The transmission rate will be lower when a microwave oven is used near by.
- To use wireless LAN, set [Wireless LAN] to [Enabled] (default) in the [Advanced] menu of the Setup Utility (→ [page 94](#)).

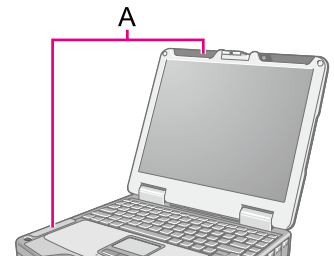



Using the Wireless LAN Function

Before using a wireless LAN, turn the wireless LAN communication on.

Turning on/off the wireless LAN communication

1 Slide the wireless switch to turn on/off wireless LAN. (→ [page 75](#))

Windows 7

- When turning on wireless LAN
If you cannot turn on wireless LAN using the wireless switch, confirm the Wireless Switch Utility setting (→ [page 76](#)). If you cannot turn on wireless LAN in the Wireless Switch Utility, try the following procedure.
- ① Click  or  on the notification area and click [Open Network and Sharing Center].
 - ② Click [Change adapter settings].
 - ③ Right-click [Wireless Network Connection] and click [Enable].
 - A standard user needs to enter an administrator password.
 - When [Disable] is displayed, [Wireless Network Connection] is already enabled.

- ④ Turn on wireless LAN in the Wireless Switch Utility (→ [page 76](#)).

NOTE



- You can use the following procedure instead of turning on wireless LAN in the Wireless Switch Utility.
 - ① Click  (Start) - [Control Panel] - [Adjust commonly used mobility settings].
 - ② Click [Turn wireless on] in [Wireless Network].
 - When [Turn wireless off] is displayed, the wireless network is already on.
 - If you cannot select [Turn wireless on], the wireless switch is turned off.

Windows 7

Setting the wireless LAN access point

Preparation

Follow the instruction manual of the wireless LAN access point to make settings for the access point to recognize the computer.

- 1 Turn the wireless LAN on.**
- 2 Click  or  on the notification area.**
- 3 Select an access point, and click [Connect].**
- 4 Input the key you set for the access point to recognize the computer, and click [OK].**



Wait for the computer to connect to the wireless LAN access point.

When the icon on the notification area is changed to , the wireless LAN setting is complete.
- 5 Click [Close].**

NOTE

- The settings depend on the network environment. For further information, ask the system administrator or the person in charge of the network.
- If you use the stealth type wireless LAN access point which restricts automatic detection of the wireless LAN access point, take the following procedure.







If you do not perform the procedure below, you may not be able to access the wireless LAN access point automatically or the wireless LAN access point may not be displayed on the [Connect to a network] screen.

 - ① Click , , or  on the notification area, click [Open Network and Sharing Center] - [Set up a connection or network] - [Manually connect to a wireless network] and click [Next].

- Input necessary information and add check marks for [Start this connection automatically] and [Connect even if the network is not broadcasting] and click [Next].

Windows XP



Setting the Profiles

- Double-click  /  /  on the notification area.**
The [Intel® PROSet/Wireless] screen appears.
 - When  or  is displayed, skip step 2.
- When you double-clicked  in step 1, slide the wireless switch to turn on.**
- Click [Profiles...] at the lower right corner of the window, and click [Add...].**
- Enter the profile name and wireless network name (SSID), and make other necessary changes, then click [Next].**
- Make necessary settings and click [OK].**
- Select the profile you set and click [Connect].**
- Click [Close].**

NOTE

- You need to set the profile for each user.
- The settings depend on the network environment. For further information, ask the system administrator or the person in charge of the network.
- For further information of Intel® PROSet/Wireless Software, refer to [Help] in the menu bar.



Enabling/Disabling the Wireless LAN Standard IEEE802.11a (802.11a)

- 1 Click  on the notification area and click  or .
- 2 Click [802.11a Enabled] or [802.11a Disabled].

Windows 7

- A standard user needs to enter an administrator password.

NOTE

- In some countries, communication using IEEE802.11a (5 GHz wireless LAN) standard is restricted by law.
- The Wireless Switch Utility icon ( or ) indicates the on/off status of wireless LAN and/or wireless WAN, not the setting of IEEE802.11a.
- If IEEE802.11a is enabled or disabled while the computer is connected to an IEEE802.11b/g access point, the connection will be temporarily interrupted.
- You can also change the IEEE802.11a setting in [Device Manager].

Windows 7

- ① Click  (Start) - [Computer] - [System properties] - [Device Manager].
 - A standard user needs to enter an administrator password.
- ② Double-click [Network adapters] and double-click [Intel(R) Centrino(R) Advanced-N 6200 AGN].
- ③ Click [Advanced], and then select [Wireless Mode] in [Property].
- ④ Select the settings in [Value] (e.g., [5. 802.11a/g]).
- ⑤ Click [OK].

Windows XP

- ① Click [start] - [Control Panel] - [Performance and Maintenance] - [System] - [Hardware] - [Device Manager].
- ② Double-click [Network adapters] and double-click [Intel(R) Centrino(R) Advanced-N 6200 AGN].
- ③ Click [Advanced], and then click [Wireless Mode] in [Property].
- ④ Remove the check mark from [Use default value] in [Value], and select the settings (e.g., [802.11a and 802.11g]).
- ⑤ Click [OK].

If you enable or disable 802.11a using the pop-up menu of Wireless Switch Utility, the setting in [Device Manager] will be accordingly changed as below.

Settings in Device Manager		Settings in Wireless Switch Utility	
Windows 7	Windows XP	When 802.11a is enabled	When 802.11a is disabled
[6. 802.11a/b/g] [4. 802.11b/g]	[802.11a, 802.11b and 802.11g] [802.11b and 802.11g]	a+b+g is enabled	b+g is enabled
[3. 802.11g] [5. 802.11a/g]	[802.11g only] [802.11a and 802.11g]	a+g is enabled	g is enabled
[1. 802.11a] [2. 802.11b]	[802.11a only] [802.11b only]	a is enabled	b is enabled

<Only for model with Bluetooth>

You can access internet and other Bluetooth devices without connecting cables.

NOTE

- Communication is established through the Bluetooth antenna (A). Do not block the antenna area with your hand or body.
- To use Bluetooth, set [Bluetooth] to [Enabled] (default) in the [Advanced] menu of the Setup Utility (→ [page 94](#)).
- The transmission rate will be lower when a microwave oven is used near by.
- When you uninstall the Bluetooth Driver, turn Bluetooth off.

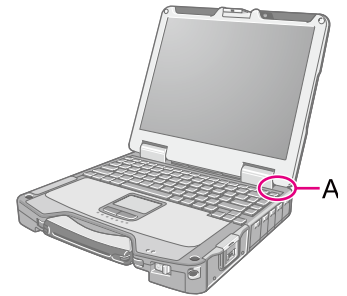



Using the Bluetooth Function

Before using a Bluetooth, turn the Bluetooth communication on.

Turning on/off the Bluetooth communication

- 1 Slide the wireless switch to turn ON / OFF Bluetooth (→ [page 75](#)).

To check the Bluetooth communication status

- 1 Click  on the notification area and place the cursor over the Wireless Switch Utility icon ( or ) on the notification area.
A tooltip appears.

■ To access the online manual

- ① Click  (Start)^{*1} - [All Programs] - [Bluetooth] - [User's Guide].

^{*1} Windows XP: [start]

Inserting/Removing the Hard Disk Drive

To change your hard disk drive, contact Panasonic Technical Support.

CAUTION

- Back up all the important data before removing the hard disk drive.
- If you need to read the hard disk data on another computer for repair or any other purpose, set [Hard Disk Lock] to [Disabled] in the [Security] menu of the Setup Utility (→ [page 97](#)) before removing the hard disk drive.
- Carefully remove/insert the hard disk drive since the hard disk drive is extremely sensitive to shock. Note that static electricity may affect some internal components.

1 Turn off the computer and disconnect the AC adaptor.

- Do not use sleep^{*1} or hibernation.

2 Remove the battery pack (→ [page 30](#)).

3 Insert/Remove the hard disk drive.

- To remove
 - ① Slide the latch (A) to the left to unlock the cover.
 - ② Slide the latch (B) up, and open the cover.

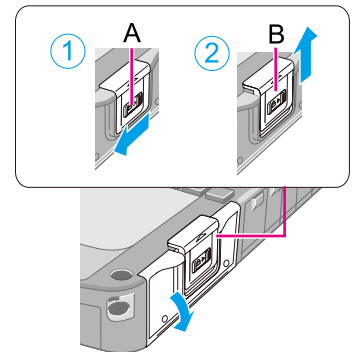

③ Pull the tab (C) of the hard disk drive and slide it out of the slot.

● To insert

① Insert the hard disk drive until it surely fits in the slot.

② Close the cover and slide the latches (D and E) back to lock the cover.

4 Insert the battery pack (→ page 30).

*1 Windows XP: standby

CAUTION

- Confirm that the latches are surely locked so that it does not fall when you carry the computer.

NOTE

- You can erase the data before changing the hard disk drive (→ page 108).
- You can check that the hard disk is recognized or not in the [Information] menu of the Setup Utility (→ page 89). If the hard disk is not recognized, turn off the computer and insert it again.

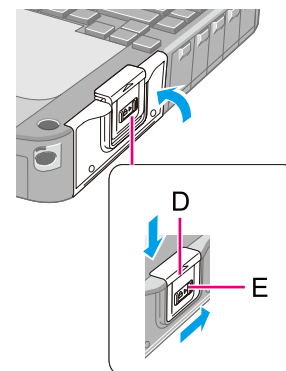
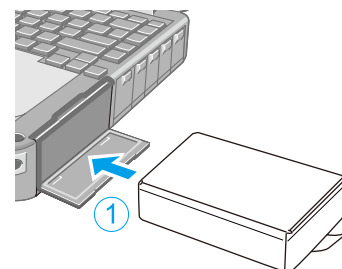
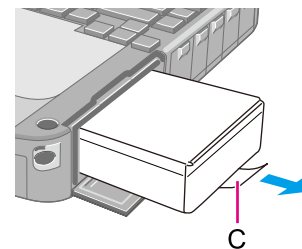

You can make the settings of the computer's operating environment (password settings, startup drive selection, etc.)

Starting the Setup Utility

- 1 Turn on or restart the computer.
- 2 Press **F2** or **Del** while [Panasonic] boot screen is displayed soon after the computer starts the startup procedure.

When [Enter Password] is displayed, enter your password.

When you start the Setup Utility with Supervisor Password

- You can make the settings of all items of the Setup Utility.

When you start the Setup Utility with User Password

- Note the following:
 - In the [Advanced] and [Boot] menus, you cannot make the settings of all items.
 - In the [Security] menu, you can change only the User Password when [User Password Protection] is set to [No Protection]. You cannot delete the User Password.
 - In the [Exit] menu, you cannot make the setting of [Load Default Values] and [Boot Override].
 - **F9** (Setup Defaults) does not function.

Information Menu

Underlined items are the factory presets.

Language	<u>English</u> Japanese
----------	----------------------------

Product Information

Model No. Serial No.	Computer information (cannot be changed.)
-------------------------	--

System Information

Processor Type Processor Speed Memory Size Available Memory* ¹ Hard Disk Optical Drive	Computer information (cannot be changed.)
--	--

BIOS Information

BIOS Embedded Controller Intel(R) ME firmware Accumulative Operating Time Access Level	Computer information (cannot be changed.)
--	--

*¹ When the mounted memory capacity is 4 GB or less, Available Memory is 2 GB.
When the mounted memory capacity is more than 4 GB, Available Memory is 8 GB (3.25 GB for 32bit OS).

Main Menu

Underlined items are the factory presets.

System Date <ul style="list-style-type: none"> Day of the Week/Month/Day/Year. You can use <u>Tab</u> to move the cursor. 	[xxx xx/xx/xxxx]
System Time <ul style="list-style-type: none"> 24-hr. style. You can use <u>Tab</u> to move the cursor. 	[xx:xx:xx]

Main Configuration

Touch Pad	Disabled <u>Enabled</u>
Touchscreen Mode <ul style="list-style-type: none"> Only for model with touchscreen 	Touchscreen Mode Tablet Mode <u>Auto</u>
Current Status <ul style="list-style-type: none"> Only when [Touchscreen Mode] is set to [Auto]. 	Depending on the current status, either "Touchscreen Mode" or "Tablet Mode" is displayed.
10-Key Mode <ul style="list-style-type: none"> Select the behavior of the ten-key area of the keyboard. When [NumLock] is selected, the NumLock LED lights and the ten-key area works as a number pad. When [Fn Key] is selected, the ten-key area works as a number pad when the <u>Fn</u> key is held. 	<u>NumLock</u> Fn Key
Display <ul style="list-style-type: none"> The display during the Windows start-up process. When an external display is not connected, the information appears on the internal LCD even though the [External Monitor] is selected. 	<u>External Monitor</u> Internal LCD

<p><Only for the model with Discrete Video Controller> Switchable Graphics</p> <ul style="list-style-type: none"> • Select which one of the two graphics processing units (GPUs) is used. • When [Switchable] is selected (default value), [Power Saving Video] is automatically enabled when the computer starts up. • When [Power Saving Video] is enabled, the Intel® GPU, which consumes less power, is always used. The graphics display performance will be reduced. (→ page 113) • Select [Performance Video] to use the discrete GPU, which maintains a higher graphics display performance. This GPU consumes more power. <p>Windows 7</p> <ul style="list-style-type: none"> • When [Switchable] is selected, you can change the GPU that is used after starting up the computer. (→ page 3) 	<p>Switchable <u>Power Saving Video</u> Performance Video</p>
<p>LCD Brightness Mode</p> <ul style="list-style-type: none"> • When [High Brightness] is selected, the brightness of the LCD is about twice that of [Normal Brightness] mode, and power consumption is also higher. 	<p>Normal Brightness <u>High Brightness</u></p>
<p>Battery Charging Indicator</p>	<p><u>On Continuous</u> Flashing</p>
<p>Power on AC</p>	<p><u>Disabled</u> Enabled</p>
<p>LID Switch</p>	<p>Disabled <u>Enabled</u></p>

Environment	Normal Temperature High Temperature <u>Auto</u>
Current Status <ul style="list-style-type: none"> Only when [Environment] is set to [Auto]. 	Depending on the battery status, either “Normal Temperature” or “High Temperature” is displayed.
► Concealed Mode Configuration	Enter the sub-menu. *1

*1 The submenu that appears when [Concealed Mode Configuration] is selected:

Concealed Mode	<u>Disabled</u> Enabled
LCD Backlight <ul style="list-style-type: none"> Can be changed only when [Concealed Mode] is set to [Enabled]. 	<u>ON</u> Minimum OFF
LED <ul style="list-style-type: none"> Can be changed only when [Concealed Mode] is set to [Enabled]. Except for the LED of external devices. 	<u>ON</u> OFF
Sound <ul style="list-style-type: none"> Can be changed only when [Concealed Mode] is set to [Enabled]. 	<u>ON</u> OFF
Wireless Radio <ul style="list-style-type: none"> Can be changed only when [Concealed Mode] is set to [Enabled]. 	<u>ON</u> OFF
Backlit Keyboard <ul style="list-style-type: none"> Only for model with Backlit Keyboard Can be changed only when [Concealed Mode] is set to [Enabled]. 	<u>ON</u> OFF
Fan <ul style="list-style-type: none"> Can be changed only when [Concealed Mode] is set to [Enabled]. To set [Fan] to [OFF], first set [LCD Backlight] to either [Minimum] or [OFF], and all of the [LED], [Sound], [Wireless Radio] and [Backlit Keyboard] to [OFF]. You cannot change this setting when [Switchable Graphics] in the main menu of the Setup Utility is set to [Switchable] or [Performance Video]. 	<u>ON</u> OFF

Advanced Menu

Underlined items are the factory presets.

▶ CPU Configuration	Enters the sub-menu ^{*2} .
---------------------	-------------------------------------

^{*2} The submenu that appears when [CPU Configuration] is selected:

Execute-Disable Bit Capability • [Enabled] indicates that this computer supports hardware-based Data Execution Prevention (DEP).	Disabled <u>Enabled</u>
Hyper Threading Technology	Disabled <u>Enabled</u>
Core Multi-Processing	Disabled <u>Enabled</u>
Intel (R) Virtualization Technology	Disabled <u>Enabled</u>
Intel (R) Trusted Execution Technology	<u>Disabled</u> Enabled

Peripheral Configuration

▶ Serial Port Settings • Used to configure the serial port A/B and GPS.	Enter the sub-menu ^{*3} .
HDD Controller Setting • <Important> Do not change this setting. If you do, the operating system will not function correctly.	<u>AHCI</u> Compatible
Optical Drive	Disabled <u>Enabled</u>
LAN	Disabled <u>Enabled</u>
Power On by LAN • Can be changed only when [LAN] is set to [Enabled]. • To use [Power On by LAN], make additional settings in [Device Manager] (→ page 72).	<u>Deny</u> Allow
LAN (2nd) • Only for model with 2nd LAN	Disabled <u>Enabled</u>

*3 The submenu that appears when [Serial Port Settings] is selected:

Serial Port A	Disabled Enabled <u>Auto</u>
I/O IRQ • Can be changed only when [Serial Port A] is set to [Enabled].	<u>3F8/IRQ4</u> 2F8/IRQ3 3E8/IRQ7 2E8/IRQ5
Serial Port B	Disabled Enabled <u>Auto</u>
I/O IRQ • Can be changed only when [Serial Port B] is set to [Enabled].	3F8/IRQ4 <u>2F8/IRQ3</u> 3E8/IRQ7 2E8/IRQ5
GPS • Only for model with GPS	Disabled Enabled <u>Auto</u>
I/O IRQ • Only for model with GPS • Can be changed only when [GPS] is set to [Enabled].	3F8/IRQ4 2F8/IRQ3 <u>3E8/IRQ7</u> 2E8/IRQ5

▶ Wireless Configuration	Enters the submenu *4.
--------------------------	------------------------

*4 The submenu that appears when [Wireless Configuration] is selected:

Wireless Switch	Disabled <u>Enabled</u>
Wireless LAN • Only for model with wireless LAN • [Wireless LAN/WiMAX] is displayed for the model with WiMAX.	Disabled <u>Enabled</u>
Wireless WAN • Only for model with wireless WAN	Disabled <u>Enabled</u>
Bluetooth • Only for model with Bluetooth	Disabled <u>Enabled</u>

Modem • Only for model with internal modem	Disabled <u>Enabled</u>
ExpressCard Slot	Disabled <u>Enabled</u>
PC Card Slot	Disabled <u>Enabled</u>
SD Slot	Disabled <u>Enabled</u>
IEEE1394 Port • Only for model with IEEE 1394 interface	Disabled <u>Enabled</u>
Smart Card • Only for model with Smart Card slot	Disabled <u>Enabled</u>
USB Port	Disabled <u>Enabled</u>
Port Replicator USB Port • If [Port Replicator USB Port] is set to [Disabled], the LAN port of port replicator or the car mounter is also disabled.	Disabled <u>Enabled</u>
Legacy USB Support	Disabled <u>Enabled</u>

Boot Menu

Boot Mode	Normal Fast
-----------	----------------

Boot Option Priorities

Boot Option #1	USB Floppy Disk* ⁵
Boot Option #2	Hard Disk
Boot Option #3	CD/DVD Drive
Boot Option #4	LAN
Boot Option #5	USB Hard Disk
Boot Option #6	USB CD/DVD Drive

■ To change the boot order

The default order is [USB Floppy Disk*⁵] → [Hard Disk] → [CD/DVD Drive] → [LAN] → [USB Hard Disk] → [USB CD/DVD Drive].

- Press **Enter** on the boot device you want to change and select the boot device from the following menu.
 - When a selected boot device in the following menu already exists in either of the [Boot Option (#1 to #6)], the boot device appears at the newly selected position by switching the positions with the original boot device that existed before at the position.
 - When you select [Disabled] in the following menu, the disabled [Boot Option] is ignored and the boot device in the next [Boot Option] operates.

Hard Disk CD/DVD Drive LAN USB Floppy Disk* ⁵ USB Hard Disk USB CD/DVD Drive Disabled
--

*⁵ Use the Panasonic USB floppy disk drive (optional: CF-VFDU03U)

Security Menu

Boot Prompt Configuration

Underlined items are the factory presets.

Setup Utility Prompt <ul style="list-style-type: none"> When [Setup Utility Prompt] is set to [Disabled], the message “Press F2 for Setup / F12 for LAN” is not displayed on [Panasonic] boot screen. However, F2 and F12 will work even if the message is not displayed. 	Disabled <u>Enabled</u>
Boot Popup Menu	Enabled <u>Disabled</u>
Password On Boot	Disabled <u>Enabled</u>
Password On Resume	<u>Disabled</u> Enabled
Boot Device on Hibernation Resume	Try prior devices <u>Hard Disk only</u>
Set Supervisor Password	Enter the sub-menu.
Hard Disk Lock <ul style="list-style-type: none"> Can be changed only when [Set Supervisor Password] is set. 	<u>Disabled</u> Enabled
User Password Protection	<u>No Protection</u> Protected
Set User Password <ul style="list-style-type: none"> Can be changed only when [Set Supervisor Password] is set. 	Enter the sub-menu.
▶ Embedded Security(TPM) <ul style="list-style-type: none"> Only for model that supports TPM For information on TPM, refer to the <i>Installation Manual</i> of “Trusted Platform Module (TPM)”. <p>Windows 7</p> Click  (Start), input “c:\util\drivers\tpm\readme.pdf” in [Search programs and files], and press Enter . <p>Windows XP</p> Click [start] - [Run], enter “c:\util\drivers\tpm\readme.pdf”, and click [OK].	Enter the sub-menu.
▶ Fingerprint Security <ul style="list-style-type: none"> Only for model with Fingerprint Reader 	Enter the sub-menu.
▶ AMT Configuration	Enter the sub-menu.

Exit Menu

Save Values and Reboot	To reboot the system after saving the changes.
Reboot Without Saving Changes	To reboot the system without saving the changes.

Save Options

Save Current Values	To save the changes for all Setup options.
Load Previous Values	To load previous values for all Setup options.
Load Default Values	To return the settings to the default values.

Boot Override

(Device Information)	To select a boot device which operates only in the next booting.
▶ Diagnostic Utility	Execute Diagnostic Utility.

Windows XP

Enlarging the screen items

You can enlarge the screen items such as characters, icons, title bars and cursor.

CAUTION

- “Icon Enlarger” will not start up if the display resolution is set lower than 1024 × 768 dots.

NOTE

- A part of the enlarged menu or some screen items may be hidden. In this case, overlay the cursor to display pop-ups, scroll the screen, or use other functions to display the hidden items.
- The Icon Enlarger setting affects the website characters displayed by Internet Explorer and the e-mail characters in Outlook Express. Some characters of website and e-mail may not be enlarged.

Preparation

Close all of the applications before using “Icon Enlarger”.



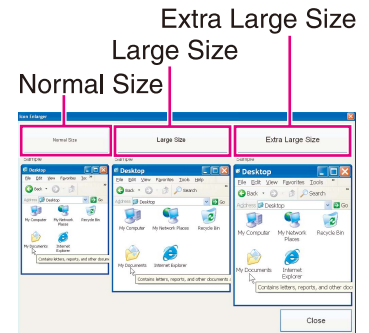

- 1** Click [start] - [All Programs] - [Panasonic] - [Icon Enlarger].
- 2** Select the size.
- 3** Click [OK].

The screen will be displayed in the selected size.





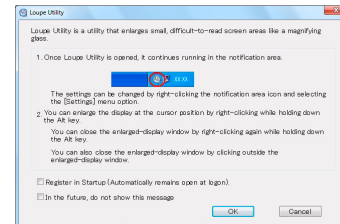

You can magnify the specific part of the screen.

Activating the Loupe Utility

- 1 Click  (Start) - [All Programs] - [Panasonic] - [Loupe Utility].
- 2 Click [OK].
 -  appears on the notification area. If  does not appear on the area, click .



Using the Loupe Utility

- 1 Point the cursor  at the part of the screen you want to magnify.
- 2 Press and hold **Alt**, and right-click.
 - The part pointed by the cursor is magnified.
 - Alternatively you can double-click , or right-click  and click [Show Loupe].
- 3 Drag the loupe window (A) to move the magnified part.
 - To hide the loupe window, click the Hide button  (B).
Alternatively you can click any part out of the loupe window, or press and hold **Alt** and right-click.
 - To change the loupe window size, drag the bottom-right corner (C).
The size range you can enlarge/shrink depends on the screen's resolution.

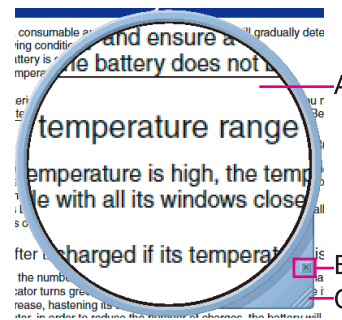

NOTE

- The magnified text or image in the loupe window is fixed at the moment that the part is magnified (e.g., at the moment you press and hold **Alt** and right-click). To reflect the change you made on the original screen to the loupe window, click the loupe window.
- The Loupe Utility does not work with some applications.

Setting the Loupe Utility

1 Click  on the notification area and right-click .

2 Click [Settings].

[Show/hide shortcuts assignment]

- When using the external mouse/touch pad

① Click [Mouse/Touch pad]

② Click a combination of **Alt**, **Ctrl**, and **Shift**, and add the check mark. (Multiple keys can be combined; for example, **Ctrl + Alt**)

③ Click either [Right click] or [Left click] to use in combination with the key(s) selected in step ② above.

- When using the keyboard

① Click [Keyboard].

② Click the text box and then press the key used for the shortcut.
(e.g., **Alt + Z**, **Ctrl + Alt + Z**, etc.)

[Window shape]

Select the shape of the loupe window.

[Autorun]

You can turn on/off autorun of the Loupe Utility and the explanation window.

[Restore Defaults]

Click to restore the default settings.

3 Click [OK].

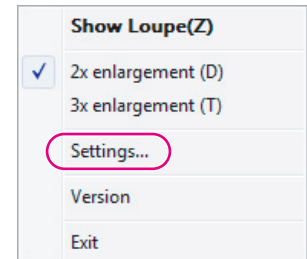

If it appears that the hardware installed in this computer is not operating properly, you can use the PC-Diagnostic Utility to determine whether or not there is a problem.

If the utility discovers a problem in the hardware, contact Panasonic Technical Support.

Software cannot be checked using this utility.

Hardware that can be checked using the PC-Diagnostic Utility

- CPU/Systems (check CPU)
- RAM XXX MB (check Memory)
- HDD XXX GB (check Hard Disk)
- DVD-ROM (check CD/DVD Drive)*¹
- Video (check Video Controller)
- Sound*²
- Modem*³
- LAN
- Wireless LAN*⁴
- Wireless WAN*⁵
- Bluetooth*⁶
- GPS*⁷
- USB
- IEEE 1394*⁸
- PC Card (check PC Card Controller)
- SD (check SD Card Controller)
- Express Card
- Smart Card*⁹
- Serial Port
- Keyboard
- Touch Pad
- Touchscreen*¹⁰

*¹ Only when the optional CD/DVD drive is inserted.

*² When the PC-Diagnostics Utility is running a loud beep will sound, so do not use headphones as this time. (The beep will not sound if mute is using Windows or [Sound] is turned off in [Concealed Mode Configuration].)

*³ Only for model with internal modem

*⁴ Only for model with wireless LAN

*⁵ Only for model with wireless WAN

*⁶ Only for model with Bluetooth

*⁷ Only for model with GPS

*⁸ Only for model with IEEE 1394 interface

*⁹ Only for model with Smart Card slot

*10 Only for model with Touchscreen

- When the video diagnostic check is running, the display may be distorted, and when the audio diagnostic check is running, sounds may be generated from the speaker. There are not malfunctions.

Regarding the PC-Diagnostic Utility

NOTE

- For the hard disk and memory only, you can select standard diagnostic check or extended diagnostic check. When the PC-Diagnostic Utility starts up, it will run the standard diagnostic check.
- We recommend that you use the touch pad for operations. When not using the touch pad, you can operate using the internal keyboard instead. Do not use the touchscreen.

Operations	Touch pad operations	Internal keyboard operations
Select icon	Place the cursor above the icon	Press Space , and then press → ← ↑ ↓ (☒ (close) cannot be selected)
Click the icon	Tap or click (right click cannot be used)	Press Space above the icon
Complete the PC-Diagnostics Utility and then restart the computer	Click ☒ (close)	Press Ctrl + Alt + Del

- If the touch pad does not operate properly, press **Ctrl** + **Alt** + **Del** to restart the computer, or press the power switch to turn the power off, and then restart the PC-Diagnostic Utility.

Running the Diagnostic Check

Run this utility using the default settings in the Setup Utility.

If the Setup Utility or other settings will not allow hardware to be executed, the hardware icon will be displayed in gray. You can also start the Diagnostic Check from [Diagnostic Utility] on the [Exit] menu of Setup Utility besides the following method. (→ [page 98](#))

1 Connect the AC adaptor, and turn on the wireless switch (→ [page 75](#)).

During the diagnostic check, do not remove the AC adaptor, or attach any peripheral devices.

2 Turn on or restart the computer, and press **F2** or **Del** while [Panasonic] boot screen is displayed.

The Setup Utility starts up.

- If the password is requested, enter the Supervisor Password.
- If you are using the computer after changing the settings from the status at the time of purchase, we recommend that you make a note of the settings that are changed.

3 Press **F9**.





At the confirmation message, select [Yes] and press **Enter**.

4 Press **F10**.

At the confirmation message, select [Yes] and press **Enter**.
The computer will restart.

5 While [Panasonic] boot screen is displayed, press and hold **Ctrl + F7** until “Please Wait” appears at the bottom of the display.

When the PC-Diagnostic Utility starts up, it will automatically begin the diagnostic check for all hardware components.

- If the password is requested, enter the password.
- The touch pad and the internal keyboard may not be used when each hardware checking is running. While checking, blue and yellow colors are displayed on the left side of the hardware icon (A).
- By clicking the icon, you can execute the following operations:
 -  : Start the diagnostic check from the beginning
 -  : Stop the diagnostic check (You cannot restart the check partway through by clicking )
 -  : Display help (click the screen or press **Space** to return to the original diagnostic check screen)
- You can check the status of the diagnostic check by the display color on the left side of the hardware icon (A).
 - Aqua: Not running diagnostic check
 - Alternating blue and yellow: Currently running diagnostic check. The interval of the alternating colors differs depending on the type of diagnostic check currently running.
During memory diagnostic check, the display may freeze for a long period of time. Wait until the process is complete.
 - Green: No problems discovered
 - Red: Problems discovered

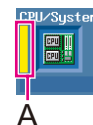

NOTE

- Using the following procedure, you can run a diagnostic check on a specified hardware component, or run an extended diagnostic check on the memory or the hard disk (The extended diagnostic check is only for the memory and the hard disk). The extended diagnostic check is more detailed, and so requires a longer period of time to run.
 - ① Click  to stop the diagnostic check.

- ② Click the icon for the hardware that is not to be checked, so that the icon is displayed in gray (B). When running a check on the memory or the hard disk, clicking the icon once will turn on the extended diagnostic check (“FULL” (C) will be displayed below the icon); click again, and the icon will be displayed in gray (D).
- ③ Click  to start the diagnostic check.

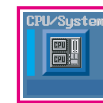

B

e.g. hard disk

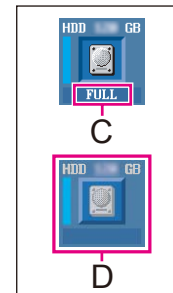

6 When all the hardware has been checked, confirm the diagnostic check results.

If the display is red and the message “Check Result TEST FAILED” is displayed, you can assume that there is a problem with the computer’s hardware. Confirm which hardware component is displayed as red, and contact Panasonic Technical Support.

If the display is green and the message “Check Result TEST PASSED” is displayed, the computer’s hardware is operating normally. Continue using the computer as it is. If the computer still does not operate properly, reinstall the software (⇒ *OPERATING INSTRUCTIONS* “Reinstalling Software”).

NOTE

- If you run a memory diagnostic check after installing a new RAM module (sold separately) and the message “Check Result TEST FAILED” is displayed:
Remove the additional RAM module and run the diagnostic check again. If the message “Check Result TEST FAILED” is still displayed, you can assume that there is a problem with the internal RAM module.

7 After the diagnostic check is complete, click (close), or press **Ctrl + Alt + Del** to restart the computer.

Windows 7

[Backup and Restore Center] and [System Recovery Options] allow you create a backup of the entire hard disk data, which can be used to recover from hardware failure.

Panasonic Corporation will bear no responsibility for any damage suffered (including loss of data) as a result of the use of this function.

Creating a Backup of the Hard Disk Data

To create a backup of the entire hard disk to another storage media (e.g., external hard disk): Use [Back up computer].
To create a backup of a file or a folder: Use [Back up files].

For further information, click  (Start) - [Control Panel] - [Back up your computer].

NOTE

- Connect the AC adaptor and do not remove it until backup is complete.

Restoring the Hard Disk Data

NOTE

- This function does not work when you turn on the computer for the first time or just after you reinstall Windows. Start and shut down Windows 7, and then you can use the function.
- Connect the AC adaptor and do not remove it until restoration is complete.

- 1 Turn on the computer, and when [Panasonic] boot screen disappears, press and hold **F8**.**
 - If [Enter Password] is displayed during the following procedure, input the Supervisor Password or the User Password.
- 2 Release your finger when [Advanced Boot Options] is displayed.**
- 3 Press **↑** **↓** to select [Repair Your Computer] and press **Enter**.**
[System Recovery Options] appears.
- 4 Select the keyboard layout and click [Next].**
- 5 Select [User name] and input [Password], then click [OK].**
- 6 Click [System Restore] and follow the on-screen instructions.**

NOTE

- If pressing **F8** does not display [System Recovery Options], use the Product Recovery DVD-ROM for Windows 7.
 - ① Turn off the computer and insert the CD/DVD drive into the multimedia pocket (→ [page 34](#)).
 - ② Turn on the computer, and press **F2** or **Del** while [Panasonic] boot screen is displayed.
 - The Setup Utility starts up.
 - If the password is requested, enter the Supervisor Password.
 - ③ Write down all of the contents of the Setup Utility and press **F9**.
 - At the confirmation message, select [Yes] and press **Enter**.
 - ④ Press **F10**.
 - At the confirmation message, select [Yes] and press **Enter**.
 - The computer will restart.
 - ⑤ Press **F2** or **Del** while [Panasonic] boot screen is displayed.
 - The Setup Utility starts up.
 - If the password is requested, enter the Supervisor Password.
 - ⑥ Set the Product Recovery DVD-ROM for Windows 7 into the CD/DVD drive.
 - ⑦ Select the [Exit] menu, then select [TEAC-DV-W28S-V] in [Boot Override].
 - ⑧ Press **Enter**.
 - The computer will restart.
 - ⑨ Click [Run “System Recovery Options”] and click [Next].
 - ⑩ Follow the on-screen instructions.

When disposing the computer or transferring the ownership, erase all hard disk data in order to avoid data leakage. Even if you erase the data or initialize the hard disk using normal Windows commands, the data can be read with some special software. Use the hard disk data erase utility to erase the data completely.

Note that transferring of the ownership without uninstalling the commercial software will be a violation of the software's license agreement.

The hard disk data erase utility erases data using an overwriting method, but there is a possibility that due to malfunctions or other operational errors, data may not be completely erased. There are also specialized devices that may be able to read data that has been erased using this method. If you need to erase highly confidential data, we recommend that you contact a company that specializes in this process. Panasonic Corporation will bear no responsibility for losses or damages suffered as a result of the use of this utility.

NOTE

- Even if hard disk data erase is performed, the number of times of DVD's region code setting will not be reset.
- **Windows 7**
This utility cannot erase data for specific partitions. However, the entire hard disk data including the data of the partition with recovery tools will be erased.
- **Windows XP**
This utility cannot erase data for specific partitions.

Preparation

- Prepare the following items:
 - The Product Recovery DVD-ROM (included)
 - Panasonic CD/DVD drive (included)
 - Remove all peripherals (except for the CD/DVD drive).
 - Connect the AC adaptor and do not remove it until hard disk data erase is complete.
- 1 Turn off the computer and insert the CD/DVD drive into the multimedia pocket (→ page 34).**
 - 2 Turn on the computer, and press F2 or Del while [Panasonic] boot screen is displayed.**
The Setup Utility starts up.
 - If the password is requested, enter the Supervisor Password.
 - 3 Press F9.**
At the confirmation message, select [Yes] and press Enter.
 - 4 Press F10.**
At the confirmation message, select [Yes] and press Enter.
The computer will restart.
 - 5 Press F2 or Del while [Panasonic] boot screen is displayed.**
The Setup Utility starts up.

- If the password is requested, enter the Supervisor Password.

- 6** Set the Product Recovery DVD-ROM into the CD/DVD drive.
- 7** Select the [Exit] menu, then select [TEAC DV-W28XXX] in [Boot Override].
- 8** Press **Enter**.

The computer restarts.

- If [Enter Password] is displayed during the following procedures, input the Supervisor Password or the User Password.

Windows 7

- 9** Click [Erase the whole data on the Hard Disk for security] and click [Next].
- 10** At the confirmation message, click [YES].
- 11** Click [Continue].
- 12** Click [Continue] again.
- 13** Click [YES].
Erasing the hard disk data starts.
- 14** After erasing is completed, remove the Product Recovery DVD-ROM and click [OK].

Windows XP

- 9** Press **2** to execute [2. [Erase HDD]].
 - To cancel this operation, press **0**.
- 10** At the confirmation message, press **Y**.
- 11** When [<<< Start menu >>>] is displayed, press **Enter**.
The approximate time required for erasing data will be displayed.
- 12** Press **Space**.
At the confirmation message, press **Enter**.
The hard disk erase process starts. When the operation is completed, the [Hard disk data has been deleted] message will appear. If a problem has occurred during the operation, an error message will appear.
 - To cancel partway, press **Ctrl** + **C**. The data erasure will be up to that point.
- 13** Remove the Product Recovery DVD-ROM, and then press any key to turn off the computer.

Network Connections and Communications Software

Close the communications software before using the power saving function.

- If the power saving function (sleep^{*1} or hibernation) is activated while communications software is used, the network connection may be interrupted, or the performance may be adversely affected. In this case, restart the computer.

- **Windows 7**

In a network environment, set [Never] for [Put the computer to sleep] and [Hibernate after] (→ [page 14](#)).

- **Windows XP**

In a network environment, set the [System standby] and [System hibernates] settings to [Never].

Click [start] - [Control Panel] - [Performance and Maintenance] - [Power Options] - [Power Schemes].

*1 Windows XP: standby

Computrace[®] software

Computrace[®] software tracks your stolen computer.

- Computrace[®] software is not included in this computer.
- Refer to the following URL for Computrace[®] software for installation and available service regions. Note that this service is only available in certain regions.
<http://www.absolute.com>

NOTE

- Consult Absolute Software Corp. before disposal.

About Windows-related files

The Windows files included in the Windows DVD-ROM are contained in the following folders:

- **Windows 7**

c:\windows\support\migwiz, c:\windows\support\tools, c:\windows\support\logging

- **Windows XP**

c:\windows\docs, c:\windows\dotnetfx, c:\windows\i386, c:\windows\support, c:\windows\valueadd

Serial Devices

The COM ports of the computer are assigned as below.

- COM1 : Serial Port A
- COM2 : Serial Port B (Port replicator^{*2}/Car mounter^{*2})
- COM3 : GPS^{*2}

^{*2} Optional

If you change the assignment, the serial devices may not work properly.

Follow the instructions below when an error message appears. If the problem persists or if the error message is not shown here, contact Panasonic Technical Support.

Error Message	Solution
Bad System CMOS	An error has occurred in the memory of system settings. This occurs when the memory content is changed by an unexpected program operation, etc. <ul style="list-style-type: none">● Start the Setup Utility and return the settings to the default values, and then change the settings as necessary.● If the problem persists, the internal clock battery may need to be replaced. Contact Panasonic Technical Support.
System CMOS Checksum Error	
Invalid Year. System date restored to 01/01/2010	The date and time settings are not correct. <ul style="list-style-type: none">● Start the Setup Utility and set the correct date and time.● If the problem persists, the internal clock battery may need to be replaced. Contact Panasonic Technical Support.
Press <F2> to enter setup	<ul style="list-style-type: none">● Write down the error details and press F2 or Del to start the Setup Utility. Change the settings if necessary.
RAM Module Failed	When the RAM module is not inserted correctly or the RAM module is not conforming to the computer's specifications, a beep will sound and the "RAM Module Failed" message will be displayed when you turn the power on. <ul style="list-style-type: none">● Press the power switch for 4 seconds or longer to turn off the computer, confirm that the RAM module conforms to the specifications, and reinsert it.



Refer to the following instructions when a problem occurs. If the remedies indicated in the chart do not solve the problem, contact Panasonic Technical Support. For a software problem, refer to the instruction manual of the software.

- To check the computer's usage status (→ [page 127](#)).

■ Shut Down

Cannot shut down or restart Windows.	<ul style="list-style-type: none">• Remove USB devices.• It may take 1 or 2 minutes to shut down.
--------------------------------------	--

■ Display

The screen does not become bright even if pressing Fn + F2 .	<ul style="list-style-type: none">• The brightness is set low to avoid malfunction where surrounding temperature is high. Use it in an environment of between 5°C and 35°C.
Windows 7 Takes time to display [Power Options] screen.	<ul style="list-style-type: none">• With the following steps, confirm whether [Copy of Panasonic Power Management] created when the Power Saving Utility is made has become 100 and more or not.<ol style="list-style-type: none">① Click  or  on the notification area and click [More power options].② Click [Show additional plans].When more than one [Copy of Panasonic Power Management] is displayed, click [Change plan settings] in the power plan to be deleted and click [Delete this plan] to delete.
Graphics display performance is low.	<ul style="list-style-type: none">• When you start up the computer for the first time after purchase, the Intel® GPU is activated to save power. Restart the computer, and set [Switchable Graphics] in the [Main] menu of the Setup Utility to [Performance Video]. This activates the discrete GPU, which maintains a higher graphics display performance, after the computer starts.• Windows 7 When [Switchable Graphics] in the main menu of the Setup Utility is set to [Switchable], activate the discrete GPU, which maintains a higher graphics display performance. (→ page 3)

■ Sleep*¹ or Hibernation

Cannot enter sleep* ¹ or hibernation.	<ul style="list-style-type: none">• Remove USB devices temporarily. If the problem persists, restart the computer.• It may take 1 or 2 minutes to enter sleep*¹ or hibernation.• The computer may not enter sleep*¹ when the computer is communicating via modem.• The computer does not enter sleep*¹ or hibernation immediately after resuming. Wait approximately 1 minute.
--	--

■ Sleep*¹ or Hibernation



<p>Cannot enter sleep*¹ or hibernation automatically.</p>	<ul style="list-style-type: none"> ● Disconnect peripheral devices. ● If you connect to a network using wireless LAN function, select the profile and connect to the access point (→ page 81). ● If you do not use wireless LAN function, turn off wireless LAN function (→ page 76). ● Make sure that you are not using any software that regularly accesses the hard disk.
<p>The computer does not resume.</p>	<ul style="list-style-type: none"> ● If you slide and hold the power switch for 4 seconds or longer, the power will be turned off forcibly and the computer will not resume. In this case, all unsaved data will be lost. ● You disconnected the AC adaptor and the battery pack while the computer was in sleep*¹. If the computer's power supply is disconnected in sleep*¹, unsaved data will be lost and the computer will not resume. ● The battery is exhausted. Sleep*¹ and hibernation consume some power.

*¹ Windows XP: standby

■ Sound

<p>No sound.</p>	<ul style="list-style-type: none"> ● Press Fn + F4 or Fn + F6 to cancel mute. ● Press Fn + F8 to turn off the concealed mode. ● Restart the computer.
<p>Distorted sound.</p>	<ul style="list-style-type: none"> ● Performing Fn key combinations sometimes causes sound distortion. Stop and restart playback.
<p>Cannot change the volume by pressing Fn + F5 or Fn + F6.</p>	<ul style="list-style-type: none"> ● Activate the Windows sound function. When it is not active, the volume does not change even if  is displayed.
<p>Windows 7 When logging on (e.g., resuming the computer), audio is distorted.</p>	<ul style="list-style-type: none"> ● Perform the following steps to change the audio settings to prevent audio output. <ol style="list-style-type: none"> ① Right-click the desktop and click [Personalize] - [Sounds]. ② Remove the check mark from [Play Windows Startup sound].
<p>Windows XP “There was an error updating the registry” appears when Sound Recorder is started.</p>	<ul style="list-style-type: none"> ● Sound Recorder is started by a limited account user whose language setting is not the same as the administrator user who last started Sound Recorder. This does not affect the operation.

■ Keyboard

Only numbers can be input.	<ul style="list-style-type: none"> When the indicator  is on, the keyboard is in ten-key mode. Press NumLk to cancel.
Only capital letters can be input.	<ul style="list-style-type: none"> When the indicator  is on, the keyboard is in Caps Lock mode. Press Caps Lock to cancel.
Cannot enter special characters (ß, à, ç, etc.) and symbols.	<ul style="list-style-type: none"> Use the character map. Click  (Start)^{*2} - [All Programs] - [Accessories] - [System Tools] - [Character Map].

*2 Windows XP: [start]

■ Network







Cannot connect to a network.	<ul style="list-style-type: none"> Set [LAN], or [LAN] and [Modem] to [Enabled] in the [Advanced] menu of the Setup Utility (→ page 93).
Cannot check the computer's MAC address.	<ul style="list-style-type: none"> Follow the steps below. <ol style="list-style-type: none"> Click  (Start)^{*3} - [All Programs] - [Accessories] - [Command Prompt]. <p>Windows 7</p> <p>Input "getmac/fo list /v", and press Enter.</p> <ul style="list-style-type: none"> Insert a space between "fo" and "list", and between "list" and "/v". <p>Windows XP</p> <p>Input "ipconfig/all", and press Enter.</p> Wireless LAN's MAC address: Make a note of the 12-digit string of alphanumeric displayed on "Physical Address" line of "Intel(R) WiFi Link 5100 AGN". Wired LAN's MAC address: Make a note of the 12-digit string of alphanumeric displayed on "Physical Address" line of "Intel(R) 82577LM Gigabit Network Connection". Input "exit", and press Enter.

*3 Windows XP: [start]

■ Wireless Communication (only for model with wireless LAN/wireless WAN)

Cannot connect to a network.	<ul style="list-style-type: none"> Slide the wireless switch to turn on the wireless devices. Set the devices ([Wireless LAN] / [Wireless WAN]) to [Enabled] in the [Advanced] menu of the Setup Utility (→ page 94). Restart the computer. Disable the Wireless Connection Disable Utility (→ page 77) Restart the computer.
------------------------------	---



■ Wireless Communication (only for model with wireless LAN/wireless WAN)

<p>Access point is not detected.</p>	<ul style="list-style-type: none">● Shorten the distance between the computer and the access point, and try the detection again.● Windows 7 Confirm the following settings:<ul style="list-style-type: none">• [Wireless LAN] in the [Advanced] menu of the Setup Utility Confirm that [Wireless LAN] is set to [Enabled] (→ page 94).• Wireless Switch Slide the wireless switch to ON.• Wireless Switch Utility Confirm that Wireless LAN is ON (→ page 76).● Windows XP Confirm that  /  /  is displayed on the notification area. If  /  /  is not displayed on the notification area, turn on the wireless communication (→ page 75).● This computer uses channels 1 through 11*⁴ when using IEEE802.11b/g. <p>*⁴ In the case of wireless communications, the frequency band being used can be divided into segments, so that different communications can be conducted on each band segment. A "Channel" refers to the individual frequency bandwidth divisions.</p>
--------------------------------------	---

■ Connecting Peripherals

<p>An error occurs while installing the driver.</p>	<ul style="list-style-type: none">● When you install a driver of card or peripheral device, make sure that the driver is compatible with the operating system. If it is not compatible, malfunction may occur. For information about the driver, contact the manufacturer of the peripheral device.● Before connecting peripheral equipment, first determine the media that contains the peripheral device's driver (e.g., CD-ROM), then attach the device for that media to the multimedia pocket. Once the installation screen for the device's driver appears, equipment you then connect to the multimedia pocket will not be recognized.
---	--

■ Connecting Peripherals

<p>A peripheral device does not work.</p>	<ul style="list-style-type: none"> ● Install the driver. ● Contact the manufacturer of the device. ● When operation resumes from sleep^{*5} or hibernation, devices such as a mouse, modem and cards may not function properly. In this case, restart the computer or reinitialize the device. ● When  is displayed in the Device Manager, remove and insert the device. If the problem persists, restart the computer. ● When you set [USB Port] to [Disabled] in the [Advanced] menu of the Setup Utility (→ page 95), USB ports of port replicator are also disabled. ● The computer may not recognize the connection/removal of some devices, or may not operate normally with some devices. <p>① Windows 7</p> <p>Click  (Start) - [Computer] - [System properties] - [Device Manager].</p> <ul style="list-style-type: none"> ● A standard user needs to enter an administrator password. <p>Windows XP</p> <p>Click [start] - [Control Panel] - [Performance and Maintenance] - [System] - [Hardware] - [Device Manager].</p> <p>② Select the applied device, and remove the check mark for [Allow the computer to turn off this device to save power] in [Power Management]. (This item may be unavailable for some types of devices.)</p> <ul style="list-style-type: none"> ● In the case that a USB device does not work, remove the USB device and connect it again or connect the USB device to another port.
<p>The connected mouse does not work.</p>	<ul style="list-style-type: none"> ● Check the mouse connection. ● Install the driver compatible with the connected mouse. <p>If the mouse does not work even after installing the driver, set [Touch Pad] to [Disabled] in the [Main] menu of the Setup Utility (→ page 90).</p>
<p>USB floppy disk drive does not work as a boot drive.</p>	<ul style="list-style-type: none"> ● You can use only the Panasonic CF-VF DU03U USB floppy disk drive (optional). ● Connect the floppy disk drive directly to a USB port of the computer. Do not connect it via a USB hub or USB connector of the port replicator or the car mounter. If you have connected to a USB port on the computer, try connecting it to one of the other USB ports. ● Set [USB Port] and [Legacy USB Support] to [Enabled] in the [Advanced] menu of the Setup Utility (→ page 95). ● Set [Boot Option #1] to [USB Floppy Disk] in the [Boot] menu of the Setup Utility (→ page 96). ● Turn off the computer and connect the USB floppy disk drive, and then restart the computer.

■ Connecting Peripherals

The RAM module is not recognized.	<ul style="list-style-type: none"> ● Insert the RAM module correctly. ● Use the compatible RAM module (→ page 44). ● Check the [Information] menu in the Setup Utility (→ page 89). If the RAM module is not recognized, turn off the computer and reinsert the RAM module.
You do not know the address map for IRQ, I/O port address, etc.	<ul style="list-style-type: none"> ● Windows 7 You can check with the following procedure. <ol style="list-style-type: none"> ① Click  (Start) - [Computer] - [System properties] - [Device Manager]. <ul style="list-style-type: none"> ● A standard user needs to enter an administrator password. ② Click [View] - [Resources by type]. ● Windows XP To check the current address map, click [start] - [Control Panel] - [Performance and Maintenance] - [System] - [Hardware] - [Device Manager] - [View] - [Resources by type].
The device connected to the serial port does not work.	<ul style="list-style-type: none"> ● Check the connection. ● The device driver may not work. Refer to the instruction manual of the device. ● Do not connect 2 mouse devices simultaneously. ● Set [Touch Pad] to [Disabled] in the [Main] menu of the Setup Utility (→ page 90). ● Set [Serial Port A] or [Serial Port B] to [Auto] in the sub-menu of [Serial Port Settings] in the [Advanced] menu of the Setup Utility (→ page 93). ● The I/O and IRQ you can use vary depending on the device. If the setting does not work, try other settings in the Setup Utility.
The Serial Port B of the port replicator or the car mounter does not work.	<ul style="list-style-type: none"> ● Set [Serial Port B] to [Auto] in the sub-menu of [Serial Port Settings] in the [Advanced] menu of the Setup Utility (→ page 93).
Cannot print.	<ul style="list-style-type: none"> ● Check the printer connection. ● Turn on the printer. ● The printer is not online. ● No paper is in the printer tray or there is a paper jam. ● Turn on the printer and connect it to the computer, and then restart the computer. ● Check the network connection if the printer is connected via network.

■ Connecting Peripherals

LAN transmission speed slows down noticeably.

Poor performance during data transmission via a PC Card (e.g., distorted video image when writing to a DV camera using an IEEE1394 PC Card).
<Only for model with wireless LAN>
Wireless LAN connection is cut.

Windows 7

- Try the following settings.
Click  (Start) - [Control Panel] - [System and Security] - [Power Options], and select [High performance], then close the window.

Windows XP

- These problems may occur due to performance loss that results from the CPU power-saving function. Log on to Windows as an administrator and follow the steps below.
 - ① Click [start] - [Run] and input [c:\util\cpupower\setup.exe], and click [OK].
Follow the on-screen instructions.
 - ② Click [start] - [All Programs] - [Panasonic] - [CPU Idle Setting].
 - ③ Click [Performance] and click [OK], then click [Yes].
The computer will restart.
 - If the problem persists, click [start] - [Control Panel] - [Performance and Maintenance] - [Power Options] - [Power Schemes], select [Always On] in [Power schemes], and click [OK].
- The above remedy is effective for performance loss resulting from the CPU power saving function, but not for other causes (e.g., noise generated by high CPU load such as video playback).
- The above remedy slightly reduces the battery operation time. Normally it is recommended to select [Battery (Windows XP Standard)] in [CPU Idle Setting] and to select [Portable/Laptop] in [Power schemes].



*5 Windows XP: standby

■ Touch Pad / Touchscreen (only for model with touchscreen)

The cursor does not work.

- Connect the external mouse correctly.
- Restart the computer using the keyboard.

Windows 7

Press  and press  2 times, and press  to select [Restart] and press **Enter**.

Windows XP

Press , **U**, and **R** to select [Restart].

- If the computer does not respond to keyboard commands, read “No response.” (→ page 126).

■ Touch Pad / Touchscreen (only for model with touchscreen)

Cannot input using the touch pad.	<ul style="list-style-type: none"> ● Set [Touch Pad] to [Enabled] in the [Main] menu of the Setup Utility (→ page 90). ● The touch pad may be disabled by some mouse drivers. Check your mouse's operating instructions.
<Only for model with touchscreen> Cannot point the correct position using the included stylus.	<ul style="list-style-type: none"> ● Perform the touchscreen calibration (→ page 11).
<Only for model with touchscreen> Cannot input using the touchscreen	<ul style="list-style-type: none"> ● Set [Touchscreen Mode] to [Auto] or [Tablet] in the [Main] menu of the Setup Utility (→ page 90).
Cannot use scroll function of touch pad on Internet Explorer.	<ul style="list-style-type: none"> ● Use Touchscreen. ● Move the mouse cursor to outside of Internet Explorer, and return to Internet Explorer.
Cannot use horizontal scroll function of touchpad on Adobe Reader.	<ul style="list-style-type: none"> ● Make sure [Scroll Configuration] of the touchpad. Click  (Start)^{*6} - [Control Panel] - [Mouse] - [Touch Pad], and add a check mark for [IntelliMouse Wheel mode] in [Scroll Configuration].

*6 Windows XP: standby

■ PC Card / ExpressCard

A card does not work.	<ul style="list-style-type: none"> ● Insert the card correctly. ● The card does not conform to the card standard. ● Restart the computer after installing a driver (of card or other device). ● Set [PC Card Slot] and [ExpressCard Slot] to [Enabled] in the [Advanced] menu of the Setup Utility (→ page 95). ● The port settings are not correct. ● Read the instruction manual of the card or contact the manufacturer of the card. ● Remove the card and insert it again (→ page 37). ● The driver is not compatible with the operating system.
-----------------------	--

■ SD Memory Card

Cannot use an SD Memory Card.	<ul style="list-style-type: none"> ● Set [SD Slot] to [Enabled] in the [Advanced] menu of the Setup Utility (→ page 95).
-------------------------------	---

■ Smart Card (only for model with Smart Card slot)

Cannot use a Smart Card.	<ul style="list-style-type: none">● Insert the Smart Card correctly.● Set [Smart Card] to [Auto] in the [Advanced] menu of the Setup Utility (→ page 95).● To use a Smart Card, you need a specified software and driver.
--------------------------	---

■ Fingerprint Reader (only for model with Fingerprint Reader)

The sensor does not enroll or authenticate my fingerprint.	<ul style="list-style-type: none">● Slide your finger correctly. For further information about enrollment and authentication, refer to “How to Use the Fingerprint Reader” (→ page 58) and [Fingerprint Tutorial].<ul style="list-style-type: none">• Click  (Start)^{*7} - [All Programs] - [Protector Suite] - [Control Center] - [Help] - [Tutorial].● The sensor enrolls or authenticates no fingerprint, or performs authentication poorly, despite the correct way of finger sliding when your finger is in any of the conditions stated below:<ul style="list-style-type: none">• Rough skin, or injured finger (with a cut or a skin inflammation)• Extremely dry• Soiled with mud or oil• Fingerprint has been worn and has faded• Wet with water or sweat<You can improve enrolling and authentication sensitivity by taking the following steps when any of the conditions described above exists><ul style="list-style-type: none">• Wash your hands or wipe them dry.• Use a different finger for registration or authentication.• Treat your finger with a hand cream when it is rough skin or dry.● Clean the fingerprint sensor. For further information, refer to “Handling & Maintenance” (→ page 65).● The fingerprint sensor may be malfunctioning when it continues to perform poorly after the steps described above have been performed. Contact Panasonic Technical Support.
--	--

■ Fingerprint Reader (only for model with Fingerprint Reader)

Sensor does not work.

- Exported passport can help you if you need to replace the sensor.
 - Log on to Windows as an Administrator.
You can always access the computer by using your Windows log on password. In convenient mode, any user can access the computer by using your Windows log on password.
 - To access [File Safe], [Personal Safe]
[File Safe] can be always accessed by using the [File Safe] backup password. [Personal Safe] can be always accessed by using the [Personal Safe] backup password.
 - Other functions
Replace/Repair the sensor, then follow the instructions in section “Replacing sensor.” (→ [page 124](#)).
Some limited functions (e.g. deleting passport) are available without a functional sensor. In case of deleted operation, it is necessary to cancel the fingerprint verification operation to get to the password dialog.



■ Fingerprint Reader (only for model with Fingerprint Reader)

<p>User cannot use enrolled finger. (e.g. injury)</p>	<ul style="list-style-type: none"> ● It is strongly recommended to enroll at least two fingers to avoid this problem. If you enrolled multiple fingers, simply use other finger. If you only enrolled one finger that can be used, we recommend to use the [Manage Fingerprints] wizard and enroll additional fingerprints. <p>If none of your enrolled fingers can be used, follow this procedure:</p> <ol style="list-style-type: none"> ① Log on to Windows as an Administrator. You can always access the computer by using your Windows log on password. In convenient mode, any user can access the computer by using your Windows log on password. ② Update the enrolled fingerprints. To be able to fully use Protector Suite, you need to have usable enrolled fingerprints. Enter the [Manage Fingerprints] wizard. <ul style="list-style-type: none"> • If you do not use backup password, you can still enter using the Windows password. • If you use backup password, you can enter using the backup password. • If you do not use backup password, there is no other way to add a different fingerprint. In this case we recommend either to wait until your finger is usable again (e.g. the injury heals), or to delete the passport (Use [Delete user data] wizard) and then reenroll new fingerprints. Please note that in the latter case all your stored secret data (passwords, [File Safe] encryption keys [Personal Safe] data) will be lost. To perform the delete operation it is necessary to cancel the fingerprint verification operation to get to the password dialog, then enter your Windows log on password. • To access [File Safe], [Personal Safe] If you did not perform the procedure in step ② or it did not work, you can still access [File Safe] by using the [File Safe] backup password, [Personal Safe] by using the [Personal Safe] backup password.
<p>TPM failure.</p>	<ul style="list-style-type: none"> ● If you use fingerprint authentication with TPM (Trusted Platform Module) and TPM is broken, erased or disabled, the [Multifactor] will not work anymore. If you do not use the [Multifactor] backup password, refer to “Starting Over” (→ page 67). Otherwise, if you use backup password, you can follow these steps: <ol style="list-style-type: none"> ① Click  (Start)*7 - [All Programs] - [Protector Suite] - [Control Center]. ② Click [Identity] - [Multifactor]. ③ Set the method of authentication except for “fingerprint + TPM **”.

■ Fingerprint Reader (only for model with Fingerprint Reader)

Replacing sensor.	<ul style="list-style-type: none"> ● If you need to replace a non-functioning fingerprint reader, follow this procedure. Enrollment to the hard disk: If enrollment to hard disk is used, "Protector Suite" has not stored any data on the device and therefore has no problem to continue after you replaced the sensor. However, in case you use the Power-on security (Preboot Authentication), you may need to use the [Manage Fingerprints] wizard to update the related data. Enrollment to the device: If the fingerprint has been enrolled to the device, a new passport will be required. Follow the procedure in the section "Starting Over" (→ page 67).
Protector Suite reinstallation.	<ul style="list-style-type: none"> ● Uninstall Protector Suite (→ page 66) before reinstalling it. After uninstallation, reinstall Protector Suite (→ page 60). ● During Protector Suite uninstallation, you can select whether to delete the Protector Suite Data - including passports. ● To use password data or "Password Bank" data after reinstalling Protector Suite, select [Leave Protector Suite *.* data for later use]. After the new installation, you will be able to use your data again. ● If you select [Remove all Protector Suite *.* data], you need to enroll fingerprint data again after reinstalling Protector Suite. In case of changing the Enrollment mode, reinstalling Protector Suite is necessary.
Lost [File Safe] backup password.	<ul style="list-style-type: none"> ● It is necessary to change the backup password for [File Safe], refer to the Protector Suite Help menu. <ul style="list-style-type: none"> • Click  (Start)^{*7} - [All Programs] - [Protector Suite] - [Control Center] - [Help] - [Help].
Accessing [File Safe] after Protector Suite uninstallation.	<ul style="list-style-type: none"> ● [File Safe] data can be accessed only using Protector Suite. If you accidentally uninstalled Protector Suite, you have to reinstall it. If passport data was not removed during uninstallation, everything will work automatically including [File Safe]. If the passport data was removed during uninstallation the [File Safe] will recognize that the installation was changed and will offer to use the backup password, instead.
Accessing [File Safe] after computer crash.	<ul style="list-style-type: none"> ● If you have an exported passport, import it now so you can access [File Safe] directly using fingerprints. Otherwise you can access [File Safe] using the [File Safe] backup password: [File Safe] will recognize that the installation was changed and will offer to use the backup password, instead.

■ Fingerprint Reader (only for model with Fingerprint Reader)

Removing data from the reader.	<ul style="list-style-type: none">● When enrollment to the device is used, passport data is stored to the device. To remove it, go to the [Delete user data] passport wizard and delete existing passports.
“Lift Finger” is displayed during operation.	<ul style="list-style-type: none">● You can temporarily disable the fingerprint sensor with the following procedure.<ol style="list-style-type: none">① Click  on the notification area and then right-click the “Fingerprint software” icon .② Select [Don't Use Sensor].● The icon turns gray.● To enable the fingerprint sensor, proceed as follows.<ol style="list-style-type: none">① Right-click the “Fingerprint software” icon .② Select [Use Sensor].

*7 Windows XP: [start]

■ Fast User Switching Function

Some applications do not work properly.	<ul style="list-style-type: none">● When switching to a different user with the Fast User Switching function, the following problems may occur.<ul style="list-style-type: none">• Some applications may not work properly.• Key combination with Fn may not work.• The display settings may not be possible.• A serial mouse may not work.• <Only for models with TPM> Personal Secure Drive function Security Platform (TPM) may not work.• <Only for model with wireless LAN> Wireless LAN cannot be used. <p>In these cases, log off all users without using Fast User Switching function and perform the operation once more. If the problem persists, restart the computer.</p>
---	---

■ Others

No response.	<ul style="list-style-type: none">● Press Ctrl + Shift + Esc to open Task Manager and close the software application.● An input screen (e.g., password input screen at startup) may be hidden behind another window. Use Alt + Tab to check.● Shut down by sliding and holding the power switch for 4 seconds or longer, and turn on the computer and open the application again. If Windows runs correctly, but the application software does not start, click  (Start)^{*8} - [Control Panel] - [Uninstall a program] and remove the failing application software, then reinstall the application software.
--------------	---

*8 Windows XP: [start]

Checking the Computer's Usage Status

You can check the computer's usage status in the PC Information Viewer. You may need this information when calling Panasonic Technical Support for advice.

NOTE

- This computer periodically records the management information of the hard disk etc. The maximum data volume for each record is 1024 bytes. The information is only used for estimating the cause when the hard disk goes down by any possibility. They are never sent to outside via network nor used for any other purpose except for the purpose described the above.

To disable the function, add the check mark for [Disable the automatic save function for management information history] in [Hard Disk Status] of PC Information Viewer, and click [OK].

Windows 7

- A standard user needs to enter an administrator password.
- As long as it is activated, the PC Information Viewer will appear in front of all other screens.
- Depending on your network environment, it may take 1 minute to start the PC Information Viewer.
- If you use a guest account to log in^{*9}, some items may displayed as "Not Found".

1 Click  (Start)^{*10} - [All Programs] - [Panasonic] - [PC Information Viewer] - [PC Information Viewer].

2 Select the item to display the detailed information.

■ To save the information as a text file

1 Display the information you want to save.

2 Click [Save].

3 Select the file save range option and click [OK].

4 Select the folder to save the information, input the file name, and click [Save].

- If you do not add the check mark for [Disable the automatic save function for management information history], the records already recorded are also saved.

■ To save a copy of the screen as an image file

1 Display the screen you want to save.

2 Press **Ctrl + Alt + F7**.

3 When the screen copy message appears, click [OK].

The screen image is saved in [Documents]^{*11} folder.

- Alternatively you can save a copy of the screen in the following procedure.
Click  (Start)^{*10} - [All Programs] - [Panasonic] - [PC Information Viewer] - [Screen Copy].

NOTE

- The image is a bitmap file in 256 colors.
- When using the extended desktop (→ [page 50](#)), a copy of the primary device screen is saved.
- The default key combination to copy is **Ctrl + Alt + F7**. You can change it in the following procedure.
 - ① Log on to Windows as an administrator.
 - ② Click  (Start)^{*10} - [All Programs] - [Panasonic] - [PC Information Viewer].
 - ③ Right-click [Screen Copy] and click [Properties] - [Shortcut].
 - ④ Move the cursor to [Shortcut key] and press the key(s) you want to use for the shortcut.
 - ⑤ Click [OK].

^{*9} Windows XP: If you log in not as an administrator

^{*10} Windows XP: [start]

^{*11} Windows XP: [My Documents]

- **Disclaimer**

Computer specifications and manuals are subject to change without notice. Panasonic Corporation assumes no liability for damage incurred directly or indirectly from errors, omissions or discrepancies between the computer and the manuals.

- **Trademarks**

- Microsoft, Windows, Windows 7, the Windows logo, and IntelliMouse are registered trademarks or trademarks of Microsoft Corporation of the United States and/or other countries.
- Intel, Core, and Centrino are either registered trademarks or trademarks of Intel Corporation.

- SDHC Logo is a trademark.



- Adobe, the Adobe logo and Adobe Reader are either registered trademarks or trademarks of Adobe Systems Incorporated in the United States and/or other countries.
- PS/2® is a registered trademark of International Business Machines Corporation.
- Names of products, brands, etc., appearing in this manual are trademarks or registered trademarks of their respective own companies.

© Panasonic Corporation 2010

PCE0301A_XP/7

Free Manuals Download Website

<http://myh66.com>

<http://usermanuals.us>

<http://www.somanuals.com>

<http://www.4manuals.cc>

<http://www.manual-lib.com>

<http://www.404manual.com>

<http://www.luxmanual.com>

<http://aubethermostatmanual.com>

Golf course search by state

<http://golfingnear.com>

Email search by domain

<http://emailbydomain.com>

Auto manuals search

<http://auto.somanuals.com>

TV manuals search

<http://tv.somanuals.com>