







TOUGHBOOK

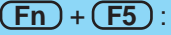

Contents

Key Combinations	2
LED Indicators	3
Panasonic Hand Writing (Touch Pad)	4
Suspend/Hibernation Functions	6
Security Measures	9
Computing On the Road	14
Battery Power	17
Using a Multimedia Pocket Device.....	21
Using PC Cards	23
Adding Memory	25
Port Replicator	26
Using a Printer	27
Using an External Display	28
Using USB Devices	29
Infrared Data Communications	31
Hard Disk Drive	32
Setup Utility	34
Technical Information	39
List of Error Codes	42
DMI Viewer	43
Dealing With Problems.....	44

Illustrations in this Reference Manual













NOTE:	NOTE provides a useful fact or helpful information.
CAUTION:	CAUTION indicates a condition that may result in minor or moderate injury.
WARNING:	WARNING indicates a hazard that may result in moderate or serious injury.
[Start]-[Shut Down]:	This illustration means to click [Start], then to click [Shut Down]. (For some applications, you may need to double-click.)
 :	This illustration means to press the [Enter] key.
 :	This illustration means to press and hold the [Fn] key, then press the [F5] key.
 page:	When the cursor is moved to an item under [Contents] or to  page (green display), the shape of the cursor will change to  . Under this condition, if characters are tapped (or a click is made), the corresponding page in the Reference Manual will be displayed.
  :	This illustration means to refer to the Operating Instructions.

We recommend that this Reference Manual be printed.













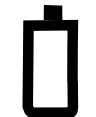

Key Combinations

CAUTION

- Do not press the following key combinations repeatedly in (quick) succession.
- Do not press the following key combinations while using the touch pad (mouse) or other keys.

Key	Functions	Popup Window
Fn + F2	LCD brightness control	Hold down the Fn key and press F2 to change the brightness.  When the brightness is at its maximum value.
Fn + F3	Display change	By pressing this key combination when the external display is connected, you can select either an external display, LCD or simultaneous. Powering the computer off and then back on enables the display setting of the Setup Utility.
Fn + F4	Speakers on/off switch	Pressing this key combination turns off audio from the internal speakers and headphone jack. Pressing it again or restarting the computer turns audio back on. Pressing it again, or powering the computer off and then back on enables the speaker setting of the Setup Utility.  OFF  ON CAUTION When disabling the speakers with this key combination, the warning beep is also disabled.
Fn + F5 Fn + F6	Volume control (▼down) Volume control (▲up) Holding down on the keys changes the sound level.	Pressing this key combination adjusts the volume of the internal speakers and headphone jack.  Down  Up NOTE ● This key combination cannot be used to adjust the volume of the warning beep. ● A dull elongated sound may be heard while adjusting the volume.
Fn + F7 *	Power off using the suspend function	Pressing this key combination causes the current screen on the display to be saved to memory, and powers off the computer. When the computer is powered on again by sliding the power switch or pressing the sleep switch, this save screen will be displayed. (The computer must be plugged into the AC adapter or have a battery pack with sufficient remaining power installed.)
Fn + F8	Power management enable/disable switch	Pressing this key combination temporarily disables the power management feature of the Setup Utility. Pressing it again, or powering the computer off and then back on enables the power management setting of the Setup Utility.  page 16  Enable (Advanced)  Enable (Standard)  Disable (OFF)
Fn + F9	Remaining capacity of the battery pack	Pressing this key combination displays the remaining battery capacity on the screen.  page 17  Remaining capacity (%) display  Battery pack is not installed.
Fn + F10 *	ECO mode for conserving power	Pressing this key combination cuts off power to the LCD and turns off the hard disk motor until operation is resumed by pressing any key.

* When [Disable] is set for [Fn+F7/Fn+F10] with the Setup Utility, these key combinations become inoperable.

	Caps Lock	This indicator lights green when Caps Lock is pressed. Subsequent non-shifted input is capitalized.
	NumLk (Numeric key)	These indicators light green when NumLk is pressed and then Key Pad is pressed while holding down the Fn key. This causes a portion of the keyboard to function as a numeric keypad. The [Enter] key functions differently depending on the application.
	ScrLk (Scroll lock)	This indicator lights green when ScrLk is pressed. Scroll lock functions differently depending on the application.
	KeyPad (Arrow key)	This indicator lights green when Key Pad is pressed while holding down the Fn key. When the indicator is not lit, a portion of the keyboard functions as arrow keys. The [Enter] key functions differently depending on the application.
	Multimedia pocket device status	This indicator lights when the multimedia pocket device (floppy disk drive, CD-ROM drive or Superdisk™ drive) is accessed. (When using the floppy disk drive as an external floppy disk drive, only the access lamp on the side of the floppy disk drive is lit.)
	Hard disk status	This indicator lights when the hard disk drive is accessed.
	Battery pack status	<p>Not lit : AC adapter not connected or charging not being performed.</p> <p>Orange  : Charging in progress.</p> <p>Green  : Charging finished.</p> <p>Red  : Battery is low (remaining battery capacity is approx. 9% or less).</p> <p>Flashing red  : Battery pack or charging malfunction.</p> <p>Flashing orange five times after the AC adapter is connected  : Charging on standby. (The ambient temperature is outside the allowable range. Once the allowable range requirement is satisfied, charging begins automatically.)</p>
	Power status	<p>Not lit : Power off</p> <p>Green  : Power on</p> <p>Flashing green  : Suspend mode</p>

Drawing Characters or Figures

Simple characters and figures like signatures and arrows can be made by using the work surface of the touch pad, and can be saved to a file as a bitmap (.bmp) format. Positions on the work surface of the touch pad have corresponding positions in the Panasonic Hand Writing window. For example, a character or figure made in the top-left part of the work surface of the touch pad will be displayed in the top-left part of the Panasonic Hand Writing window.

CAUTION

- To draw, an object with a rounded tip (e.g., a pen for tablets) can be used. Do not use any of the following objects, as they may damage the work surface.
 - Objects with an extremely sharp tip, like screwdrivers and nails.
 - Objects that leave marks, like ball-point pens.
- In the Hand Writing mode, an external mouse or trackball connected to the external keyboard/mouse port will not operate. Therefore, before switching over to the Hand Writing mode, remove the external device that is connected. If a switch is made to the Hand Writing mode without disconnecting the external device and the external device stops working, reconnect the device after quitting the Hand Writing mode. If the device still does not work, try restarting the computer.

1 Select  from the taskbar or select [Panasonic Hand Writing] from [Start] - [Program] - [Panasonic]

2 Change to the Hand Writing mode

The following two methods are available.

- Select  from the tool bar.
- Select [Hand writing mode] in [Option].

3 Draw a character or figure using the work surface of the touch pad

NOTE

- **Determine the position to begin drawing:**
Determine the position to begin drawing while pressing down on the right button of the touch pad. After determining this position, release your finger from the button and draw. Drawing is not possible while the right button of the touch pad is being pressed.
- Data can be copied to the clipboard with [Edit] - [Copy]. Copied data can be added to other applications that support the bitmap format by using the paste function. Pasting is not possible to applications that do not support the bitmap format.

(To next page)

4 Close the Hand Writing mode

Confirm that the [Panasonic Hand Writing] window is active, and then press the left button of the touch pad.

NOTE

In the following cases, the Hand Writing mode is automatically cancelled.

- When a switch is made to another application
- When the computer resumes operation from the suspend or hibernation mode
- When the settings window for [Panasonic Hand Writing] is shown.

5 Select [Save As] or [Save] from [File].

NOTE

The file size of a bitmap image to be saved or pasted to another application can be changed with [Option] - [Window size].

Starting Up Your Computer Quickly

If you want to immediately start up and continue an application after shutting down your computer, you can do so by using the suspend or hibernation function.

● Differences between the suspend function and hibernation function

Function	Suspend function	Hibernation function
Where data is saved to	Memory	Hard disk
Speed	Fast	Somewhat slow
Requires power supply	Yes (if power is cut, all data is lost)	Power not required to maintain data

Setting the Suspend or Hibernation Function

[Hibernation] is factory set.

- 1 Run the Setup Utility (👉 page 34)
- 2 Using **↑** and **↓**, select **[Power Management]**, then press **Enter**
- 3 Using **↑** and **↓**, select **[Sleep Switch]**, set **[Suspend]** or **[Hibernation]** with **→**, then press **Esc**
- 4 Close the Setup Utility (👉 page 34)

Shutting Down Using the Suspend or Hibernation Function

The computer should be set for suspend or hibernation (👉 see the above procedure).

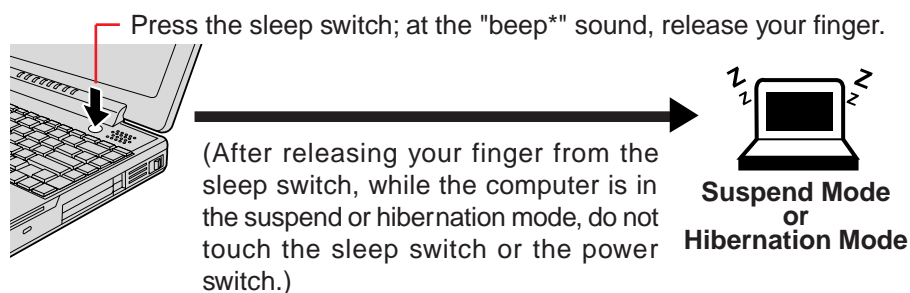

CAUTION

- At the "beep*" sound, release your finger from the sleep switch. If you continue to press down on the switch and hold it for more than four seconds, the "beep*" sound will come out again and the power will go off. Data not previously saved will be lost.
Slide the power switch to power on. The power will not go on by pressing the sleep switch.
Even when [Sleep Switch] is set to [No Action] with the Setup Utility, if the sleep switch is pressed, a beep will sound and the power will go off if the button is pressed for more than four seconds.
- If the computer will not be operated for an extended period of time, it is recommended that hibernation mode is used instead of suspend mode.

* When the speaker function is disabled, e.g., by setting [Disable] for [Speaker] with the Setup Utility (👉 page 34) or by the key combination **Fn** + **F4**, there will be no beep sound.

NOTE

With the method below, you can shut down the computer by using the suspend function.

- **Fn** + **F7** ( page 2)
- Select [Suspend] from the [Start] menu.

[Suspend] is deleted from the [Start] menu by unchecking [Allow Windows to manage power use on this computer.] in [Start] - [Settings] - [Control Panel] - [Power] or by unchecking [Show suspend command on Start menu] in [Advanced].

Resuming Operation

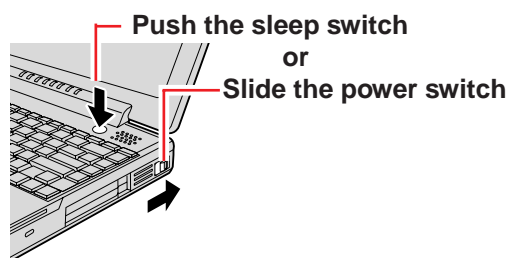

If the security indicator () is displayed, your password has been set.

CAUTION

- After the display returns, the computer needs a short period of time to reinitialize. This takes about 15 seconds. Do not shut down or restart Windows, or use suspend or hibernation function again during this time, as this may subsequently cause Windows to operate abnormally.
- Do not install or remove peripherals while your computer is in the suspend or hibernation mode; abnormal operation may result.
- When operation resumes, serial devices such as a mouse or modem, or your PC Cards may not work. In such cases, you will need to restart your computer or reinitialize the individual devices.

Precautions for Using the Suspend or Hibernation Function

- Save all data before powering off your computer.
- When restarting from or shutting down to the suspend or hibernation mode, do not touch the touch pad (or move the mouse (serial or PS/2 type) if one is connected). These devices may fail to operate, you will then need to restart your computer using the keyboard.
- Do not power off during the following periods (you may corrupt your data or file):
 - While the MP indicator (MP) or HDD indicator (HDD) is on.
 - While playing/recording audio files.
 - While communications software is being used.
- Do not use the suspend or hibernation function when using an operating system other than the one that comes with your computer, the Setup Utility, or when experiencing static electricity or noise.
- If you hold down on the **Alt**, **Ctrl** or **Shift** key to enter the suspend or hibernation mode, after resuming operation, you must press the same key. For example, if you hold down on the **Shift** key while pushing the sleep switch, upon resuming, if you do not press the **Shift** key again, only capital letters will result from typing.
- Only when the computer stops operating or locks up should the sleep switch be held more than four seconds to power off the computer. Slide the power switch to power on and data not previously saved will be lost.
- In the suspend mode, power is consumed. If PC Cards (e.g., a modem card) are inserted, more of that power is consumed. When all power has been consumed, all data at shut down is lost since it is retained in memory. We therefore recommend plugging in the AC adapter when using the suspend function.
- Repeatedly using the suspend or hibernation function will use up a lot of the system resources and the computer may not work properly. Shut down Windows ([Start]-[Shut Down]) on a regular basis, e.g., about one time a week, without using the suspend or hibernation function. Doing so will restore the system resources.
- Do not use the suspend or hibernation function during the following periods. The suspend or hibernation function, or peripherals may not work.
 - When a file in external devices such as a CD-ROM drive, external hard disk, or ATA card is opened, the suspend or hibernation function may not work. In such cases, close the file.
 - SCSI cards may not recover after entering the suspend or hibernation mode. If this occurs, restart the computer.
- After a Windows 95 USB device driver has been installed, do not use the suspend or hibernation function. If the suspend or hibernation mode is activated, the computer may not function properly. Power off, then on, using the power switch to resume proper operation.

If you want to use the suspend or hibernation function after the USB driver is installed, disable the USB device function of the computer by following the procedure below.







1 In [Start] - [Settings] - [Control Panel] - [System] - [Device Manager], select [Intel 82371AB/EB PCI to USB Universal Host Controller] in [Universal serial bus controller].

2 Add the check mark ✓ for [Disable in this hardware profile] in [Properties] - [General], press [OK], and then press [Close].

3 In [Start] - [Shut Down], select [Restart], then press [OK].

If you want to enable the USB device function again, delete the check mark for [Disable in this hardware profile] in step **2**. When the message appears asking whether to reboot the computer, select [Yes]. If the message is not displayed, go to step **3**.

To prevent unauthorized access of your computer, the various security measures are provided below.

Situation	Function to use	Reference
You do not want your computer to be used without permission	User Password	 below
Same as above, but while you're away temporarily	Coffee break Password	 page 10
You want to prevent theft or damage to data by using a floppy disk	Prevent operation by using a floppy disk	 page 12
You do not want your Supervisor Setup changed without permission	Supervisor Password	 page 12
You want to prevent theft of your computer	Use security locks	  "Names and Functions of Parts"

When you do not want your computer to be used without permission

Set the User Password.
Without the password, access to your computer is impossible.

● When the User Password is set

Upon entering your User Password and pressing **Enter**.

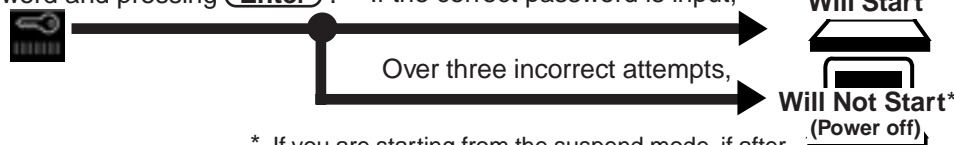

* If you are starting from the suspend mode, if after three attempts the correct password is not input, or if no password is entered for about a minute, the computer returns to the suspend mode.

Setting the user password (enabling, changing, disabling)

- 1 Run the Setup Utility ( page 34)
- 2 Using **↑** and **↓**, select [System Setup], then press **Enter**
- 3 Using **↑** and **↓**, select [User Password], then press **Enter**
- 4 ● To enable or change your password
Enter your password at the [Enter User Password], then press **↓**.

CAUTION

- Your password will not be displayed on the screen.
- Please limit your password to seven characters. Note that there is no distinction between upper and lower case letters.
- White colored keys can be used. Note that the space bar and function keys cannot be used.
- Do not input your password while holding down on **Shift** or **Ctrl**.
- Use only the upper horizontal row of numeric keys to input your user password.
- Do not forget your password. If a password is forgotten, you will be unable to use your computer. Please contact Panasonic Technical Support.

(To next page)

● To disable your password

Using the **↑** and **↓**, keys, select [Delete User Password], then press **Enter**. Go to step 7.

5 Re-enter your password at the [Enter User Password Again] (This is for confirmation purposes.)

6 Using **↑** and **↓**, select [Set User Password], then press **Enter**

7 At the confirmation screen, press **Enter**

8 Press **Esc** to end the password setting procedure

9 Close the Setup Utility (👉 page 34)

CAUTION

To prevent the changing of your password without permission

- When running the Setup Utility, do not leave your computer even for a short time.
- Set the User Password Protection option (👉 page 13).

When you do not want your computer to be used without permission while away temporarily

You should set the “Coffee break Password” (Note that you must first set the User Password). When you input your selected key combination, the computer locks (key input, use of the touch pad and use of an external mouse are no longer possible).

● When the coffee break password is set

When leaving your desk

Alt + **Ctrl** + **F9** (Example of a selected key combination)

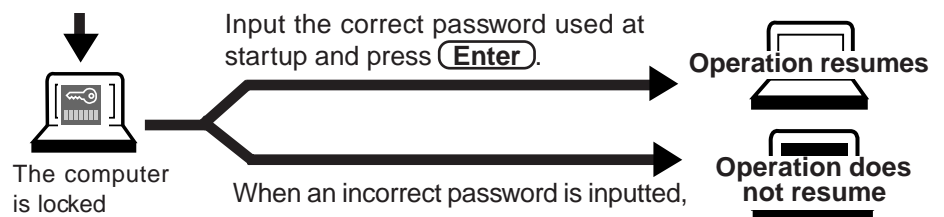

In the case of the coffee break password, the password key indicator will not change even if the password is inputted.



CAUTION

- Do not leave your computer just after sensitive data had been shown on the screen.
- It is impossible to lock your computer from an external device, such as a mouse connected through the serial port or the USB keyboard.

Setting the Coffee break Password (enabling or disabling)

- 1** Set the User Password (☞ page 9 to 10 step 1 to 7)
- 2** ● **To enable the Coffee break Password**
Using **↑** and **↓**, select [Coffee break Password], then set [Enable] with **→**.
- **To disable the Coffee break Password**
Using **↑** and **↓**, select [Coffee break Password], then set [Disable] with **→**. Go to step 4.
- 3** Using **↑** and **↓**, select [Key Combination for Coffee break], then set your combination of keys with **→**
- 4** Press **Esc** to end the password setting procedure
- 5** Close the Setup Utility (☞ page 34)

Preventing theft of damage to data using a floppy disk

You may choose to protect the data on your computer from being accessed illegally or overwritten accidentally by using a floppy disk. You can also set your computer to be unbootable from a floppy disk.

● Preventing the use of a floppy disk

This error message is displayed when access to the floppy disk drive is attempted.

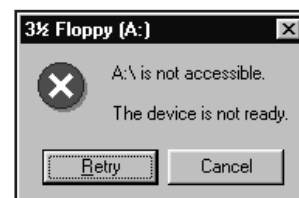

Procedure

- 1 Run the Setup Utility (👉 page 34)
- 2 Using **↑** and **↓**, select [Supervisor Setup], then press **Enter**
- 3 Using **↑** and **↓**, select [Boot Up Drive], then set either [HDD → FDD] or [CDD → FDD → HDD] with **→**
- 4 Using the **↑** and **↓**, select [Floppy Operation], set [Disable] with **→**, then press **Esc**
- 5 Close the Setup Utility (👉 page 34)

When you do not want your Supervisor Setup changed without permission

Set the Supervisor Password. After it has been set, no changes can be made to the Supervisor settings unless the password is entered.

● When the supervisor password is set

When changing the Supervisor Setup, if  is displayed after the power has been turned on, or if [Enter supervisor password] is displayed in the Setup Utility (👉 page 34),

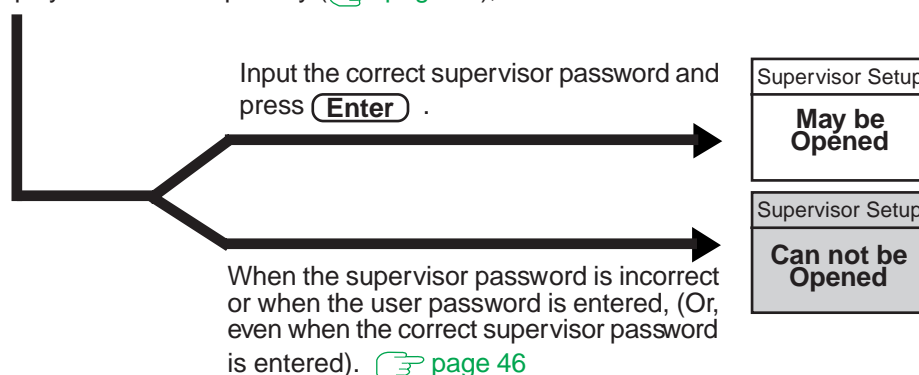

(There are cases in which the Supervisor Setup does not appear on the main screen). (👉 page 34)

Setting the Supervisor Password

(enabling, changing, disabling)

- 1 Run the Setup Utility (👉 page 34)
- 2 Using **↑** and **↓**, select [Supervisor Setup], then press **Enter**
- 3 Using **↑** and **↓**, select [Supervisor Password], then press **Enter**
- 4 ● **To enable or change your supervisor password**
Enter your password at the [Enter Supervisor Password], then press **↓**.

CAUTION

- Your password will not be displayed on the screen.
- Please limit your password to seven characters. Note that there is no distinction between upper and lower case letters.
- White colored keys can be used. Note that the space bar and function keys cannot be used.
- Do not input your password while holding down on **Shift** or **Ctrl**.
- Use only the upper horizontal row of numeric keys to input your user password.
- Do not forget your password. If a password is forgotten you will be unable to use your computer. Please contact Panasonic Technical Support.

● To disable your supervisor password

Using **↑** and **↓**, select [Delete Supervisor Password], then press **Enter**.
Go to step 7.

- 5 **Re-enter your password at the [Enter Supervisor Password Again]**

(This is for confirmation purposes.)

NOTE

When you do not want the User Password enabled, changed, or disabled without permission,

use **↑** and **↓**, to select [User Password Protection], then set [Enable] with **→**.

- 6 Using **↑** and **↓**, select [Set Supervisor Password], then press **Enter**
- 7 At the confirmation screen, press **Enter**
- 8 Press **Esc** to end the password setting procedure
- 9 Close the Setup Utility (👉 page 34)

Conserving Power

One of the main features of notebook-type computers is that you have the power of computing away from your home or office. In the following, information is provided on how to maximize use of the battery pack which is necessary for such computing.

● Four Important Points

POINT 1 Be sure to charge your battery before and after use.

POINT 2 To get the maximum use of your battery, set the power management mode.

POINT 3 Check to see that you have your AC adapter with you before leaving your home or office.

Purchasing an extra battery (CF-VZS351A) and the optional battery charger* is highly recommended.

* for U.S.A. and Canada: CF-VCB252 (with AC adapter)
for Europe: CF-VCB251A

POINT 4 Always watch your battery level!

Things to Remember

● Leave your computer off when it is not in use

 "Starting Up/Shutting Down"

● Adjust the brightness (dark) with **Fn** + **F2**

By repeatedly pressing the keys to maximize the brightness ( will be displayed), following this, if the keys are pressed again, the brightness will be minimized, thereby lowering the power consumption.

● Before stepping away from your computer, press **Fn** + **F10** to put your computer in the ECO mode

The ECO mode helps you conserve power by cutting off power to the LCD and turning off the hard disk motor. To resume, you may press any key.

● In the power management mode, the setting of [Advanced] is recommended (page 15)

With the Setup Utility, you can set the [Advanced] mode. This mode allows you to maximize power save regardless of whether you are using only the battery pack or the AC adapter.

● Setting the suspend/hibernation timeout (page 15)

The suspend or hibernation function ( page 6) allows you to save power by automatically cutting off power when the computer is idle or there is no access to individual devices for 4 or 16 minutes. If [Advanced] or [Standard (Battery/AC Adapter)] is selected for [Power Saving], the suspend/hibernation timeout function will go into effect for both the battery pack and the AC adapter. If, however, [Standard (Battery)] is selected for [Power Saving], it will go into effect only during operation by the battery. The ECO mode timeout function is automatically set when [Advanced] or [Standard] is set. Note that the ECO mode timeout precedes the suspend/hibernation timeout.

It should be noted that for some applications, the suspend/hibernation timeout will not work properly.

NOTE

If you plan to use only the battery pack or set the power management, it is necessary to check ✓ [Allow Windows to manage power use on this computer] in [Start] - [Settings] - [Control Panel] - [Power].





If the check is removed, the time may not be displayed properly when operation is resumed from the suspend or hibernation mode or the operating time with the battery pack may become short (the power management function of Windows does not work).

Setting Power Management

(How to set [Advanced] and the suspend/hibernation timeout)

- 1** Run the Setup Utility (👉 page 34)
- 2** Using **↑** and **↓**, select [Power Management], then press **Enter**
- 3** Using **↑** and **↓**, select [Power Saving], then set [Advanced] with **→**
(To avoid setting the suspend/hibernation timeout, press **Esc** and proceed on to step 6.)
- 4** Using **↑** and **↓**, select [Sleep Switch], then set [Suspend] or [Hibernation] with **→**
- 5** Using **↑** and **↓**, select [Suspend/Hibernation Timeout], set either [4 min] or [16 min] with **→**, then press **Esc**
- 6** Close the Setup Utility (👉 page 34)

● Power Management settings

Power Management Functions automatically set	Advanced	Standard (Battery/AC Adapter) (Setting at the time of purchase)	Standard (Battery)*	OFF
HDD Motor Timeout	1 min	1 min	1 min	Never
ECO Mode Timeout	1 min	2 min	2 min	Never
Power Conservation (AC Adapter Connected)	Enable	Enable	Disable	Disable
Popup window display by pressing (Fn) + (F8)**				

* Enabled only when the battery itself is being used.

**  is displayed by pressing (Fn) + (F8) to disable the power management function.

- **HDD Motor Timeout:** When the hard disk drive is not accessed for more than a minute, the hard disk motor is turned off.
- **ECO Mode Timeout:** If there is no input from a key, the touch pad, or the mouse for more than two minutes, the power to the LCD is cut and the hard disk motor is turned off. Even when an application software is being installed, the computer may enter the ECO mode.

CAUTION

When installed in a network environment.

Be sure to disable the suspend/hibernation timeout settings with the Setup Utility. After resuming operation from the suspend or hibernation mode, the network connection may be severed or the computer will not work properly.

When a device like a high-speed modem or ISDN terminal adapter is connected to the serial port, etc.

There are times when high-speed communication is adversely affected if the power management function is enabled. Please confirm that  is displayed by pressing (Fn) + (F8) to disable the power management function. After you have finished using a communications device, you can enable the power management function by pressing (Fn) + (F8).

Key operation and music playback.

When the power management function is running, you may feel that key or touch pad (or mouse) operations are sluggish. Furthermore, music may not be played back correctly when entering the ECO mode during playback.

Battery Status

Use the Battery Indicator to Check on the Battery Status

Battery Indicator	Battery Status
Orange*	Charging
Green*	Fully-charged
Red	Battery charge is low (the charge is less than approx. 9% capacity)
Blinking red*	Battery pack or charger may not be working properly. Quickly remove the battery pack and disconnect the AC adapter, then connect them again. If the problem persists, contact Panasonic Technical Support.
Blinking orange five times after the AC adapter is connected*	Unable to recharge due to violation of temperature limits. (The ambient temperature is outside the allowable range. Once the allowable range requirement is satisfied, charging begins automatically.)
Not lit	Battery pack is not connected or charging not being performed.

* When the AC adapter is connected.

NOTE

This computer prevents overcharging of the battery by recharging only when the remaining power is less than approx. 95% of capacity after the battery is fully charged.

● Getting a detailed reading



NOTE

- The actual remaining battery capacity and the displayed indication may differ.

- The battery indicator light remains red.
- The battery remaining displays 99% and the indicator light is orange for a long period of time. → Charge the battery until the indicator is green, then completely discharge the battery.

- Low battery warning appears after a short period of time. This may be caused by the use of suspend mode for long periods of time. The battery is discharging while the computer is in suspend mode when the AC adapter is not connected. → Completely discharge the battery (reaches 0%).

- When the battery pack is not in the computer,  is displayed.

When the Remaining Battery Charge Becomes Low

save your data and power off your computer

Following that:

- Plug in the AC adapter, and fully charge your battery.
- Use a spare battery if you have one.
- If you have neither the AC adapter nor an extra battery, power the computer off.

● If the suspend or hibernation function is set



● If the suspend or hibernation function is not set

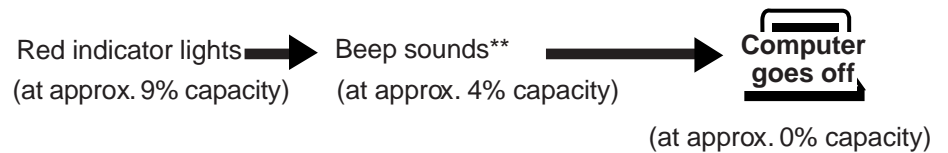

** When disabling the speakers with the Setup Utility (or pressing **Fn** + **F4**), the warning beep is also disabled.

Replacing the Battery Pack

When the charge provided by your battery pack is supplied for only a short period of time, even after fully charging according to the instructions, it may be time to replace your battery pack. The battery pack is a consumable item and therefore will require replacement (CF-VZS351A).

CAUTION

- Do not touch the terminals on the battery pack. The battery pack may no longer function properly if the contacts are dirty or damaged.
- The battery pack is not charged when the computer is first purchased. Be sure to charge it before using it for the first time. When the AC adapter is connected to the computer, charging begins automatically.
- Use only the specified battery pack (CF-VZS351A) with your computer.

1 Power off your computer (👉📖 "Starting Up/Shutting Down")

Do not shut down using the suspend mode.

CAUTION

In the suspend mode, do not remove/change the battery pack. Removing the pack in the suspend mode will erase your data and may damage the computer.

2 Open the display

Slide the latch located at the front and lift open the display.

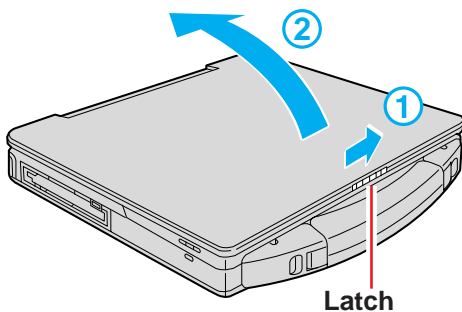

3 Open the cover

① Insert a thin, flat object, like a ruler into the open slot on the left side of the computer to release a latch.

② Open the cover.

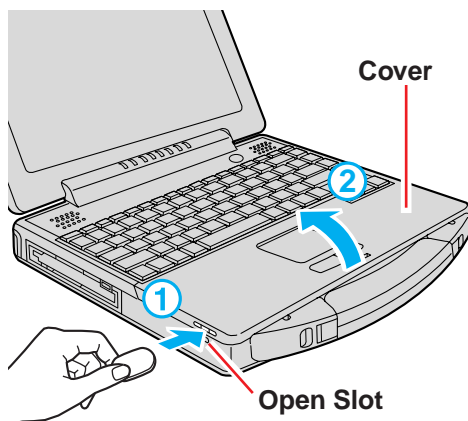

4 Remove the battery pack

① Lift the battery pack slightly by pulling the tab.

② Hold the battery pack and remove it from the connector of the computer.

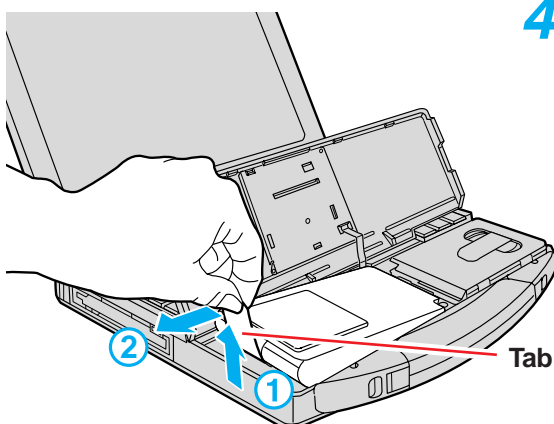

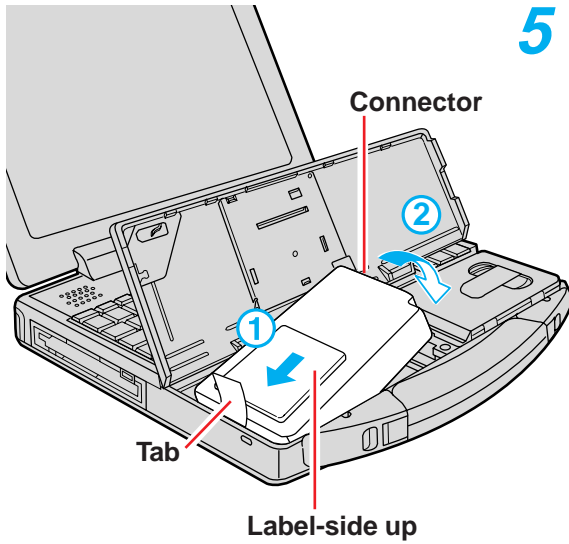

5 Connect the battery pack

- 1 Pull the tab outside the frame of the computer, and insert the non-connector-side of the battery pack into the computer with the label-side up.
- 2 Insert the connector-side of the battery pack into the computer to secure the connector.

CAUTION

- Be sure the battery pack is properly connected to the connector.
- If the tab is set under the battery pack, the battery pack will be difficult to remove later.
- Do not touch the battery connector on the computer and flat cable. The computer may not operate properly.

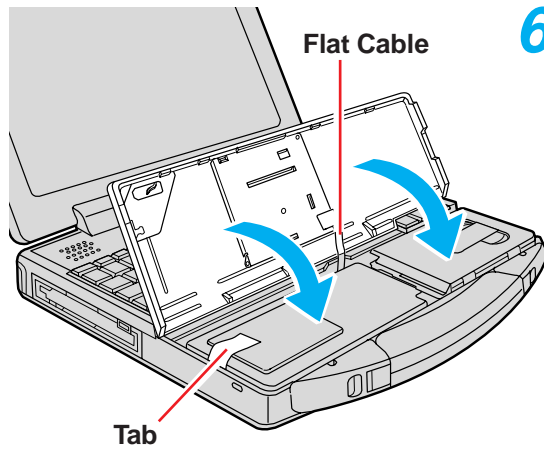

6 Close the cover

Close the cover until it clicks into place; be sure the tab does not get caught when closing the cover.

CAUTION

When closing the cover;

- Be careful not to get your fingers caught in the cover.
- There are instances the right side of the cover will float. In such cases, attempt to close the cover again by putting the projection on the right side of the cover below the keyboard.

Press down on these areas firmly.

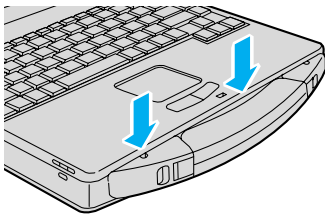

You may use an optional CD-ROM pack (CF-VCD711) or Superdisk drive pack (CF-VFS711) by removing your floppy disk drive from the multimedia pocket. For more information, please read the manual that accompanies the CD-ROM pack or Superdisk drive pack.

Installing/Removing a Multimedia Pocket Device

- 1 Power off your computer** (☞📖 "Starting Up/Shutting Down")
Do not shut down using the suspend or hibernation mode.

CAUTION

Do not install or remove peripherals while your computer is in the suspend or hibernation mode; abnormal operation may result.

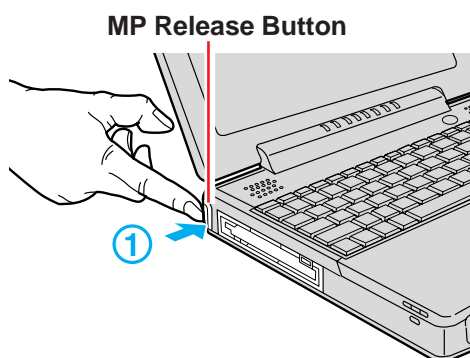

- 2 Removing the device**
 - 1** Press the MP release button firmly. The device will eject slightly.

- 2** Remove the device by holding both sides of the device.

CAUTION

- Please handle the device as shown (holding both sides). Otherwise, the device may be damaged. Also, do not apply excessive downward force on the device. The projections at the bottom of a device become deformed.
- Be sure the shape of the lock at the bottom of a device does not become deformed. Do not insert a device that has become deformed into the multimedia pocket. The device may become impossible to remove later.

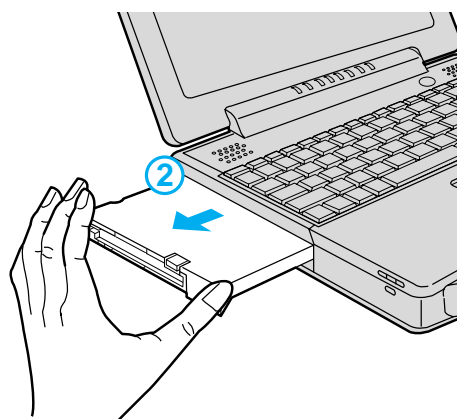
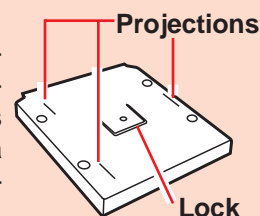
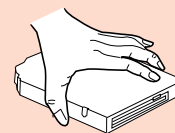

- 2 Installing the device**

Gently insert the device into the multimedia pocket by pushing on both corners until it clicks into place.

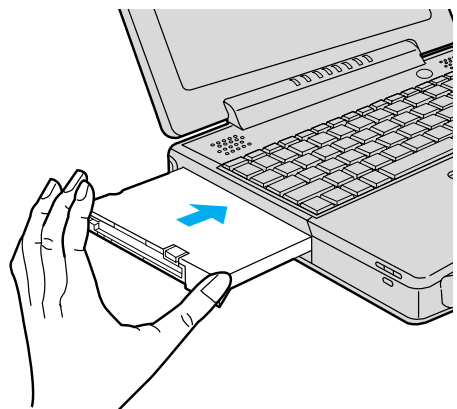

- 3 Turn your computer on**

NOTE

When the CD-ROM pack is installed:

- [Removable Disk (A:)] is displayed in [My Computer], but access is not possible. Select [Cancel].
- If the vibration of the CD-ROM drive is excessive, set the [CD-ROM Drive Speed (Max)] to [12x speed] in the Setup Utility.

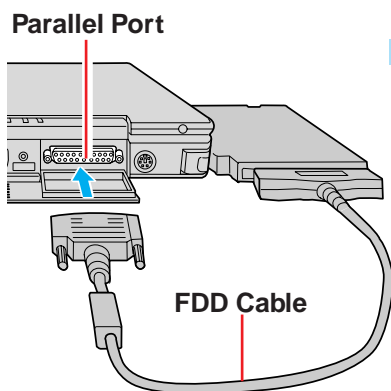

Using the Floppy Disk Drive as an External Drive

You may use the floppy disk drive as an external drive that is connected through the parallel port, by using an optional FDD cable (CF-VCF351).

In the operating instructions for the FDD cable (CF-VCF351), directions are given to turn the power off before connecting the floppy disk drive by using the cable, but with this computer, the floppy disk drive can be attached or removed while the power is on.

CAUTION

- Do not move the drive while accessing data on the floppy disk.
- Firmly hold both sides of the drive when removing a disk. Excessive force on top should be avoided.

NOTE

- When the computer is on or in the suspend or hibernation mode, if the floppy disk drive is accessed after it had earlier been disconnected, there are instances where the contents of the floppy disk set prior to the drive removal are displayed. Do not try to access any of the files. If an attempt is made, an error message may be displayed or the display prompting you to format the disk may appear. (When such a display appears, press the [Cancel] or [No] to close the display.) The above contents will no longer be displayed when the drive is re-connected or when the computer is restarted.
- When the Superdisk drive pack is installed in the multimedia pocket, the floppy disk drive cannot be used as an external floppy disk drive.
- The CD-ROM pack and Superdisk drive pack cannot be used as an external device.

PC Card

Your computer has two PC Card slots. These slots conform to the PC Card Standard; therefore, communications or SCSI devices, etc., may be utilized. The slots allow you to use two Type I or Type II cards (or one Type I and one Type II), or one Type III card.

● Type I or II

Two cards can be used simultaneously.



● Type III

One card can be used only in the slot 1.

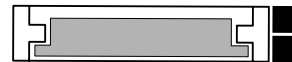

CAUTION

- Please check the PC Cards' specifications. Be sure the total operating current does not exceed the specified limit. Damage may result otherwise.
Allowable Current (total for two slots) : 3.3V: 400 mA, 5 V: 400 mA, 12 V: 120 mA
- There are times when both a Type I card and a Type II card will not work at the same time.
- SRAM and FLASH ROM (except for an ATA interface) cards are not supported.
- Do not use a CardBus type card and a non-CardBus type card at the same time.
- For the following cases, be sure the power has been turned off before proceeding.
 - When removing a network card
 - When replacing a CardBus type card with another card (including another CardBus type card)
 - When inserting one more CardBus type card with one already inserted

Installing/Removing the PC Card

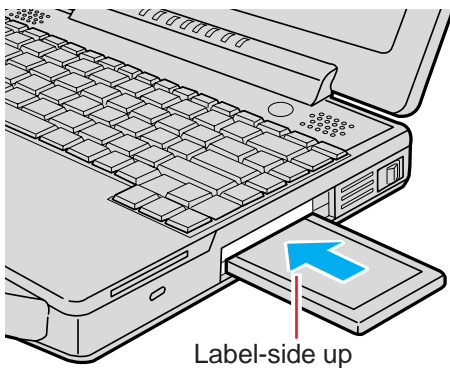

● Installing a PC Card

Simply slide the PC Card in until it snaps into place. Please refer to the manual for each card on how to install the card (insertion is typically label-side up).

CAUTION

When inserting a card, do not force the card in if difficulty is encountered. You may damage the slot, making it impossible to remove the card.

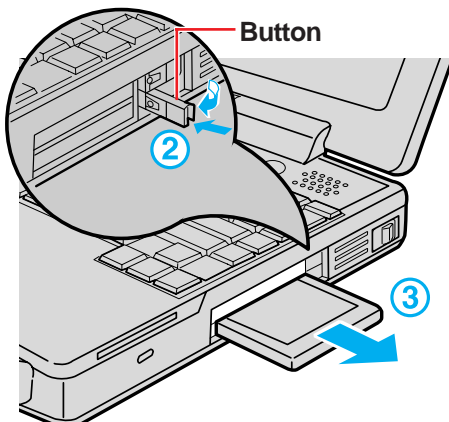

● Removing a PC Card

CAUTION

Do not remove a PC Card while your computer is in the suspend or hibernation mode.

- ① Go to [Socket Status] (in [Start] - [Settings] - [Control Panel] - [PC Card (PCMCIA)]), select the PC Card slot and press [Stop].
(When removing a PC Card after turning off the computer, this step ① is not need.)
- ② Pull the button out and press it.
- ③ Slide the PC Card out.

PC Card Utility Program

About PhoenixCard Manager™ for Windows® 95

CAUTION

If a ZV card does not operate properly, install PhoenixCard Manager™ for Windows® 95 by following the procedure below, after uninstalling the driver or the application software for the card. Otherwise, do not perform the installation; abnormal operation may result.

● Installing (only if the ZV card does not operate properly)

- 1 Set [Sound Controller] to [Automatic (PnP)] in the Setup Utility.
- 2 Select [Start] - [Run].
- 3 Type [c:\util\drivers\pccard\setup.exe], press [OK], then follow the on-screen instructions.

CAUTION

After PhoenixCard Manager™ for Windows® 95 has been installed, make sure to power off the computer before installing or removing the card. Also, do not use the suspend or hibernation functions if the card is installed.

NOTE

When running the power conservation function with the sound chip set, there may be no sound output. In this case, the following setting needs to be made.

In [Control Panel] - [Power] - [OPL3-SAx power management], set [Non Power Save mode] then press [Apply]. Then press [OK]. (→ page 41)

● Uninstalling

When you decide not to use the ZV card, be sure to perform the uninstall procedure.

- 1 Uninstall PhoenixCard Manager™ for Windows® 95 in [Start] - [Settings] - [Control Panel] - [Add/Remove Programs].
- 2 Restart the computer.
- 3 Select [PC Card (PCMCIA)] in [Start] - [Settings] - [Control Panel].
- 4 Press [Next] at the display for the [Display Driver Wizard for PC Cards (PCMCIA)], press [Next] again and then press [Finish].
- 5 Shut down the computer by following the on-screen instructions.

RAM Module

CAUTION

- Use a RAM module meeting the RAM module specifications below. If a module is used that does not meet the specifications, there are cases in which data may become unusable or the computer may not operate properly.
- RAM modules are extremely sensitive to static electricity. There are cases where static electricity generated by the human body has adversely affected such modules. In addition, it is easy to damage the RAM modules or internal components of the computer. Therefore, when installing or removing a RAM module, handle the module with extreme care.

Installing/Removing the RAM Module

- 1 Power off your computer** (👉📖 "Starting Up/Shutting Down")
Do not shut down using the suspend or hibernation mode.

CAUTION

Do not install or remove peripherals while your computer is in the suspend or hibernation mode; abnormal operation may result.

- 2 Remove the memory cover after removing the screw holding it in place**

Turn the computer over and use a screwdriver to remove the screw.

CAUTION

Do not touch the terminals or internal components, insert objects other than the module, or allow foreign particles to enter. Doing so has been known to cause damage, fire or electric shock.

- 3 ● Installing the RAM module**

Slide in the module at an angle and snap the module into place by pushing down on it.

RAM module specifications

144 pins, SO-DIMM, 3.3 V, SDRAM

- Removing the RAM module**

- 1** Open the left and right hooks.
- 2** Gently remove the RAM module from the slot.

- 4 Put the cover back into place, then fasten the screw**

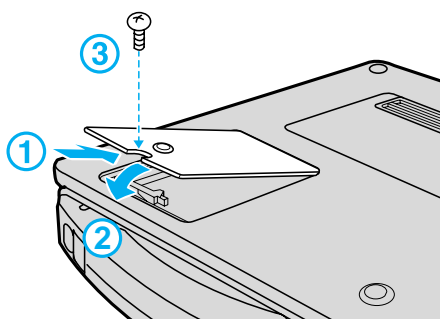
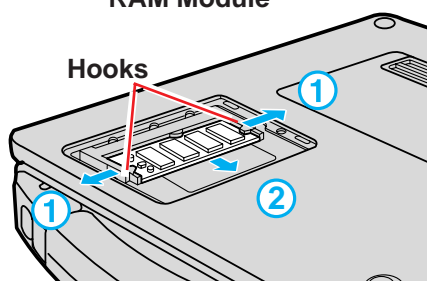
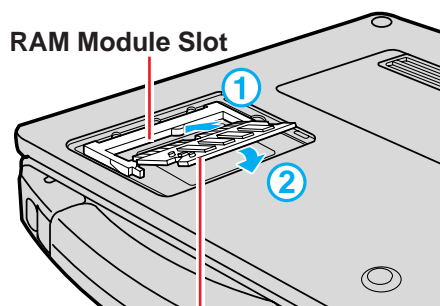
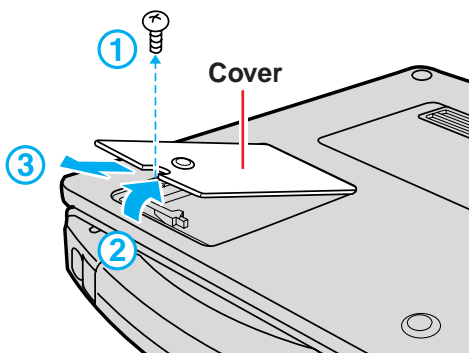

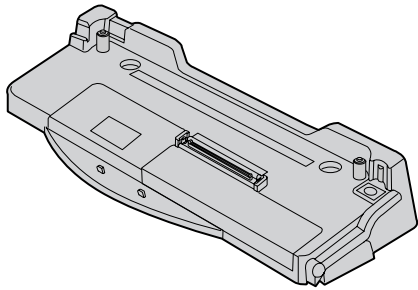

A port replicator is available as an option (CF-VEB711). This device eliminates the hassles of having you connect/disconnect the various cables when carrying your computer around and allows a variety of peripherals to be connected including a headphone or microphone, etc.

The port replicator connects to the expansion bus connector on the bottom of your computer.

For more detailed information, please refer to the operation manual of the port replicator.

CAUTION

When the computer and the port replicator are connected, both PC Card slots (total of four slots) cannot be used simultaneously. Before connecting the port replicator, set [Disable] for [Internal CardBus Controller] with the Setup Utility to disable the PC Card slots on the computer side.

- 1 Power off your computer** (👉📖 "Starting Up/Shutting Down")
Do not shut down using the suspend or hibernation mode.

CAUTION

Do not install or remove peripherals while your computer is in the suspend or hibernation mode; abnormal operation may result.

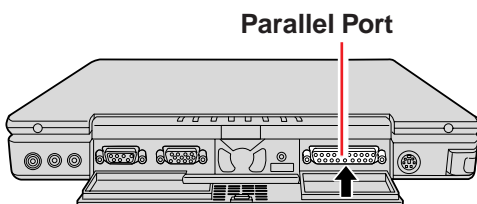
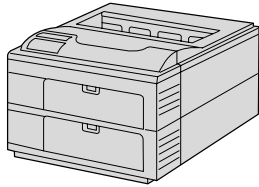

- 2 Connect the printer to your computer**

- 3 Turn on the printer, then turn on your computer with the LCD panel opened**

- 4 Setting your printer**

Go to [My Computer] - [Printers]. Find your printer's icon, double-click on it, and click [File] - [Set As Default]. If no icon is available, select [Add Printer] and then follow the on-screen instructions.

NOTE

You may need to install a driver for your printer. Simply follow the on-screen instructions and refer to the operation manual of the printer on how to install the driver.

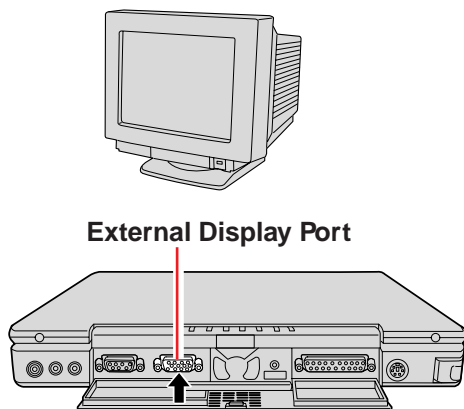

- 1 Power off your computer** (👉 📖 "Starting Up/Shutting Down")
Do not shut down using the suspend or hibernation mode.

CAUTION

Do not install or remove peripherals while your computer is in the suspend or hibernation mode; abnormal operation may result.

- 2 Connect the external display to your computer**

NOTE

For more detailed information, please refer to the operation manual of the external display.

- 3 Turn on the external display, then turn on your computer with the display opened**

You can select either an external display, LCD or simultaneous with **(Fn) + (F3)**.

In addition, you can set the display to use during start-up with the following procedure.

- 1 Run the Setup Utility** (👉 page 34)

- 2 Using (↑) and (↓), select [System Setup], then press (Enter)**

- 3 Using (↑) and (↓), select [Display], select the display to use with (→), then press (Esc)**

- 4 Close the Setup Utility** (👉 page 34)

- 4 Select your external display**

Set your external display for [Monitor] in [Start] - [Settings] - [Control Panel] - [Display] - [Settings] - [Advanced Properties].

When a monitor that does not conform to the Plug & Play standards is connected, select [Change] and make the monitor settings.

- 1 Run the Setup Utility (☞ page 34)
- 2 Using **↑** and **↓**, select [Power Management], then press **Enter**
- 3 Using **↑** and **↓**, select [Power Saving], set [OFF] with **→**
- 4 Using **↑** and **↓**, select [Sleep Switch], set [No Action] with **→**
- 5 Using **↑** and **↓**, select [Fn+F7/Fn+F10], set [Disable] with **→**, then press **Esc**
- 6 Close the Setup Utility (☞ page 34)
- 7 Install the Windows 95 USB device drivers
 - 1 In [Start] - [Run], input [c:\util\msupdate\usbsupp.exe]*, then press [OK]. At the confirmation message, press [Yes].
* After reinstalling the hard disk, set the Windows 95 CD-ROM included in the Windows 95 System Pack and input [L:\other\updates\usb\usbsupp.exe].
 - 2 Read the [END-USER LICENSING AGREEMENT] and press [Yes] or [No].
 - Installation will start if [Yes] is pressed. A message will appear asking whether to restart the computer; press [OK].
 - Installation will be aborted if [No] is pressed.
 - 3 At the display indicating the completion of installation, press [OK]. The computer will automatically restart.
 - 4 In [Start] - [Run], input [c:\util\msupdate\usbupd2.exe]**, then press [OK].
** After reinstalling the hard disk, set the Windows 95 CD-ROM included in the Windows 95 System Pack and input [L:\other\updates\usb\usbupd2.exe].
 - 5 In [Start] - [Shut Down], select [Restart], then press [OK].
 - 6 In [Start] - [Run], input [c:\util\msupdate\usbcopy.bat], then press [Yes].
 - 7 Click at the upper right corner to close the display.
 - 8 In [Start] - [Settings] - [Control Panel] - [System] - [Device Manager], select [PCI Universal Serial Bus] in [Other devices], press [Remove], then press [OK].
 - 9 Press [Refresh] and press [Close] at the [System Properties],

CAUTION

After a driver has been installed, do not use the suspend or hibernation function. If the suspend or hibernation mode is activated, the computer may not function properly. Power off, then on, using the power switch to resume proper operation.

If you want to use the suspend or hibernation function when the USB driver is installed, disable the USB device function of the computer. (☞ page 8)

(To next page)

- 8 Power off your computer** (👉📖 "Starting Up/Shutting Down")
Do not shut down using the suspend or hibernation mode.

CAUTION

Do not install or remove peripherals while your computer is in the suspend or hibernation mode; abnormal operation may result.

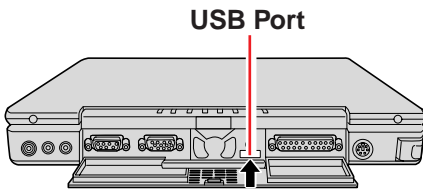

- 9 Connect the USB device to your computer**

NOTE

For more detailed information, please refer to the operation manual that accompanies the USB device.

- 10 Turn on the USB device, then turn on your computer**

NOTE

You may need to install drivers for your USB devices, simply follow the on-screen instructions and refer to the operation manual that accompanies the USB device.

Your computer is equipped with an infrared communications port enabling you to transfer data without a cable.

Preparations for Infrared Data Communications

- Set the address of your infrared communications port to enable. (☞ below)
- Position your computer so that the port is face-to-face with the port of another computer.
- Be sure the computers are not in direct contact with one another.
- A port-to-port distance of 20 to 50 cm (8 to 20 inches) is recommended.

Problems with infrared data communications

- An object is located between both ports.
- There are other electronic devices nearby causing interference, such as a television, VCR, wireless headphone, etc.
- Direct sunlight or white glowing light, such as fluorescent lighting; can cause interference with communications between the ports.
- When moving your computer while it is transmitting/receiving data.

Setting for Infrared Data Communications

- 1 Run the Setup Utility (☞ page 34)
- 2 Using **↑** and **↓**, select **[Supervisor Setup]**, then press **[Enter]**
- 3 Using **↑** and **↓**, select **[IrDA]**, set **[Automatic (PnP)]** with **→**, then press **[Esc]**
- 4 Close the Setup Utility (☞ page 34)

Data Communications

NOTE

Before data communications, please do the following.

- Add the check mark for [Dial-Up Networking] in [Communications] with [Windows Setup] in [Control Panel] - [Add/Remove Programs].
- Select [Microsoft] for [Manufacturers:] and [File and printer sharing for Microsoft Networks] for [Network Services:] in [Control Panel] - [Network] - [Add] - [Service].
- Use Windows Explorer to set the folders for sharing on the host side.

- 1 Select **[Start] - [Programs] - [Accessories] - [Direct Cable Connection]**
- 2 Select **[Host]** or **[Guest]**, then press **[Next]**
- 3 Select **[Serial cable on COM4]**, then press **[Next]**
If [Serial cable on COM4] is not displayed, select [Install New Ports].
- 4 Press **[Finish]**
Infrared data communications will begin.

NOTE

- To process at a transfer speed of 4 Mbps, separate application software is necessary.
- When you select [Start] - [Settings] - [Control Panel], and then select [Infrared], this will give you the conditions for infrared data communications.
- Please refer to Windows help on how to use Direct Cable Connection.

To change your hard disk drive, contact Panasonic Technical Support

For information on FAT32, refer to "Technical Information" (👉 page 40).

CAUTION

To customers:

- To change your hard disk, contact Panasonic Technical Support.
- Be sure to back up all important data before the change.

To technicians (at Panasonic Technical Support):

Be careful when replacing the hard disk. The hard disk is extremely sensitive to shock. In addition, static electricity could later affect some internal components.

Installing/Removing the hard disk

(For technicians at Panasonic Technical Support)

- 1 Power off your computer** (👉 📖 "Starting Up/Shutting Down")
Do not shut down using the suspend or hibernation mode.

CAUTION

Do not install or remove peripherals while your computer is in the suspend or hibernation mode; abnormal operation may result.

- 2 Open the display**
Slide the latch located at the front and lift open the display.

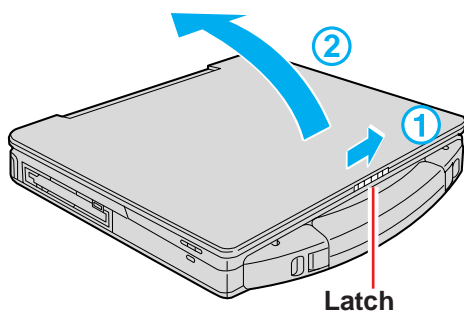

- 3 Open the cover**

- 1** Insert a thin, flat object, like a ruler into the open slot on the left side of the computer to release a lock.
- 2** Open the cover.

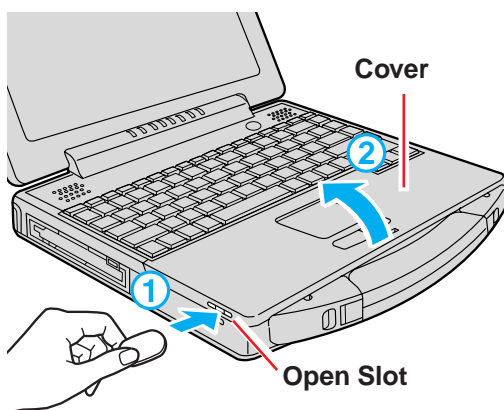

- 4 Removing/Installing the hard disk**

- 1** Pull the tab of hard disk according to the arrow, and slightly lift the hard disk drive.

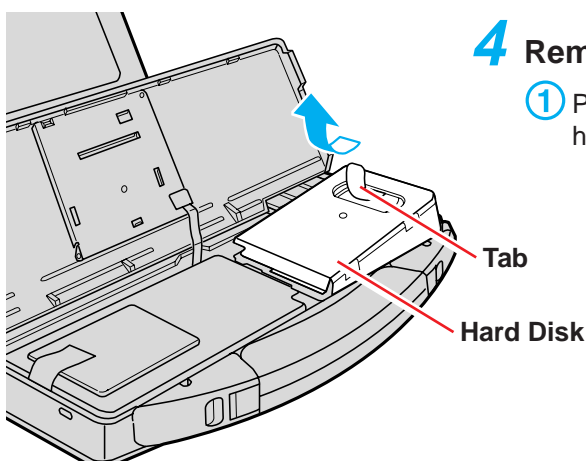

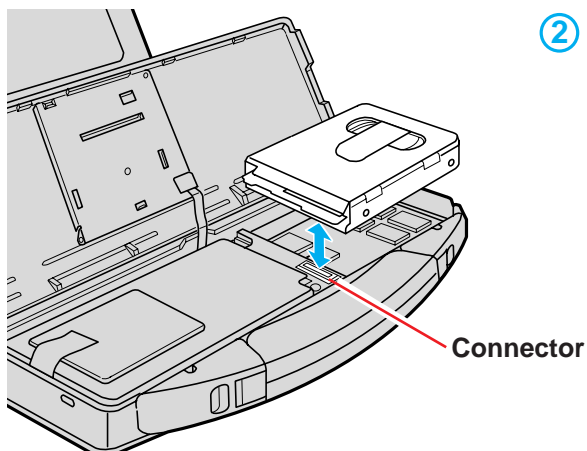

② Lift the hard disk drive to remove it from the connector and gently set a new hard disk drive on to the connector.

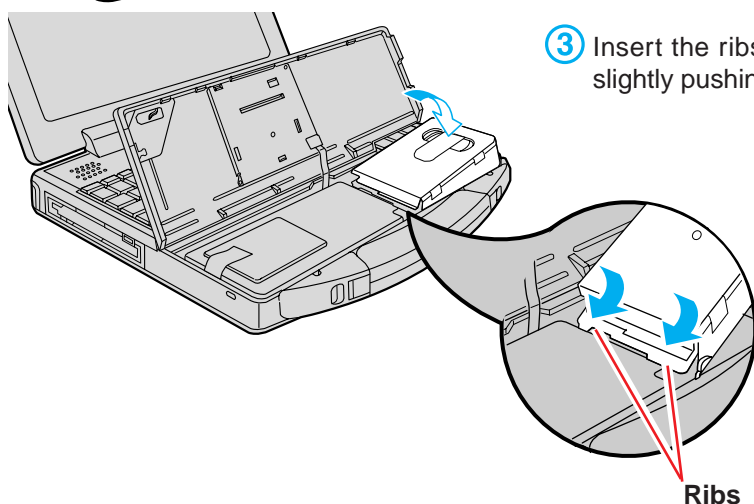

③ Insert the ribs of the hard disk as shown in the figure, and while slightly pushing the hard disk to the left put the hard disk in place.

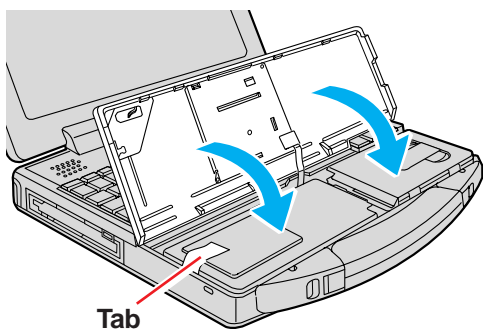

5 Close the cover

Close the cover until it clicks into place; be sure the tab does not get caught when closing the cover.

CAUTION

When closing the cover;

- Be careful not to get your fingers caught in the cover.
- There are instances the right side of the cover will float. In such cases, attempt to close the cover again by putting the projection on the right side of the cover below the keyboard.

Press down on these areas firmly.

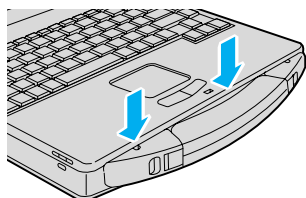

Running the Setup Utility

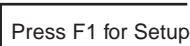
To run the Setup Utility, you need to restart your computer. → Upon seeing this message  → press **F1**

NOTE

- The Setup Utility will not be run if **F1** is not pressed soon after the computer restarts. In this case, you need to restart your computer again.

- If  is displayed, enter your password.

If both the [User Password] and [Supervisor Password] have been set, after entering the User Password, [Supervisor Setup] and [Load Default Setting...] will not be displayed on the main screen.

To display the [Supervisor Setup]:

- 1 Restart the computer and press **F1** when [Press F1 for Setup] is displayed.
- 2 When  is displayed, enter the Supervisor Password.

- For more details, on-line help is available; press **F1**.

<Main Screen>

Setup Utility
•System Setup •Power Management •Supervisor Setup
Save Settings
Restore Settings
Load Default Settings (PnP)
Load Default Settings (Non-PnP)
Exit Setup

Return to the state existing at the time of Setup Utility startup, or to the settings saved with [Save Settings].

Set default settings.

- (PnP) is for operating system that is compatible with the Plug & Play.
- (Non-PnP) is for operating system that is not compatible with the Plug & Play.
- When the Supervisor Password has been set, input of the password is necessary.

NOTE

Key Operations

F1 : To display the corresponding "help" file.

Enter : To make a selection.

Esc : To display previous screen (To exit the program at the main screen).

↑ **↓** : To move among the items.

← **→** : To move among the values of each item.

F9 : To return to the setting before a change.

F10 : To set the default values.

Closing the Program

Select one of the items and press **Enter**.

Exit Setup
Settings were changed. Do you want to save them?
Yes, save and exit the Setup Utility.
No, exit the Setup Utility without saving.
No, return to the Setup Utility.

NOTE

If the User Password has been set, the password must be entered before Windows can start.

(The display may be different if no changes to the settings are made.)

System Setup

System Setup	
NumLk	[ON]
Touch Pad	[Enable]
Speaker	[Enable]
Display	[External Monitor]
•User Password	
Coffee break Password	Disable
Key Combination for Coffee break	Disable

Parameters

(__ : Default)

NumLk	<u>ON</u> OFF
Touch Pad	<u>Enable</u> Disable
Speaker	<u>Enable</u> Disable
Display	Internal LCD <u>External Monitor</u> Simultaneous
User Password	Enter displays the user password menu.
Coffee break Password*	Enable <u>Disable</u>
Key Combination for Coffee break**	<u>Alt + Ctrl + F9</u> Alt + Ctrl + F10 Alt + Ctrl + F11 Alt + Ctrl + F12

* Setting impossible when [User Password Protection] is set to [Enable].

** Setting impossible when the [Coffee break Password] is set to [Disable].

Power Management

Power Management	
Power Saving	[Standard (Battery/AC Adapter)]
HDD Motor Timeout	1 min
ECO Mode Timeout	2 min
CD-ROM Drive Speed (Max)	[24x speed]
Sleep Switch	[Hibernation]
Suspend/Hibernation Timeout	[4 min]
Fn+F7/Fn+F10	[Enable]

Parameters

(_ : Default)

Power Saving	Advanced <u>Standard (Battery/AC Adapter)</u> Standard (Battery) OFF
HDD Motor Timeout	Automatically set through setting of Power Saving (<u>1 min</u> / Never)
ECO Mode Timeout	Automatically set through setting of Power Saving (1 min / <u>2 min</u> / Never)
CD-ROM Drive Speed (Max)	12x speed <u>24x speed</u>
Sleep Switch	<u>Hibernation</u> Suspend No Action
Suspend/Hibernation Timeout	Never* <u>4 min</u> 16 min
Fn+F7/Fn+F10	<u>Enable</u> Disable

* Set automatically when [Sleep Switch] is set to [No Action].

Power Management Settings

Power Management Functions automatically set	Advanced	Standard (Battery/AC Adapter) (Setting at the time of purchase)	Standard (Battery)	OFF
HDD Motor Timeout	1 min	1 min	1 min	Never
ECO Mode Timeout	1 min	2 min	2 min	Never
Power Conservation (AC Adapter Connected)	Enable	Enable	Disable	Disable

Supervisor Setup

Supervisor Setup	
Parallel Port (Address)	[Automatic (PnP)]
Parallel Port Mode	[Bidirectional]
Serial Port	[Automatic (PnP)]
Sound Controller	[Enable]
Sound Blaster Compatible I/O	[Automatic (PnP)]
WSS CODEC I/O	[Automatic (PnP)]
Sound IRQ-A	[Automatic (PnP)]
Sound IRQ-B	[Automatic (PnP)]
Sound DMA-A	[Automatic (PnP)]
Sound DMA-B	[Automatic (PnP)]
IrDA	[Automatic (PnP)]
Floppy Operation	[Enable]
Boot Up Drive	[FDD → HDD]
• Supervisor Password	
User Password Protection	[Disable]
Internal CardBus Controller	[Enable]

Parameters

(_ : Default)

Depending on the item, the default value changes when (PnP) is selected and when (Non-PnP) is selected.

Parallel Port (Address)	Automatic (PnP) (PnP Selected) 378 (Non-PnP Selected) 3BC OFF
Parallel Port Mode**	Bidirectional Unidirectional ECP
Serial Port	Automatic (PnP) (PnP Selected) 3F8 (Non-PnP Selected) OFF
Sound Controller	Enable Disable
Sound Blaster Compatible I/O	Automatic (PnP) (PnP Selected) 220 (Non-PnP Selected) 240 OFF*
WSS CODEC I/O	Automatic (PnP) (PnP Selected) 530 (Non-PnP Selected) F40 OFF*

* Set automatically when [Sound Controller] is set to [Disable].

** Setting impossible when [Parallel Port (Address)] is set to [OFF].

Sound IRQ-A	Automatic (PnP) <input checked="" type="radio"/> PnP Selected IRQ 5 <input type="radio"/> Non-PnP Selected IRQ 9 IRQ 10 OFF*
Sound IRQ-B	Automatic (PnP) <input checked="" type="radio"/> PnP Selected Not Use <input type="radio"/> Non-PnP Selected IRQ 9 IRQ 10 OFF*
Sound DMA-A	Automatic (PnP) <input checked="" type="radio"/> PnP Selected DMA 0 <input type="radio"/> Non-PnP Selected DMA 1 OFF*
Sound DMA-B	Automatic (PnP) <input checked="" type="radio"/> PnP Selected Not Use <input type="radio"/> Non-PnP Selected DMA 7 OFF*
IrDA	Automatic (PnP) <input checked="" type="radio"/> PnP Selected <u>2F8</u> <input type="radio"/> Non-PnP Selected OFF
Floppy Operation**	<u>Enable</u> Disable
Boot Up Drive	<u>FDD -> HDD</u> HDD -> FDD CDD -> FDD -> HDD
Supervisor Password	<input checked="" type="radio"/> Enter displays the supervisor password menu.
User Password Protection***	<u>Enable</u> Disable
Internal CardBus Controller	<u>Enable</u> Disable

- * Set automatically when [Sound Controller] is set to [Disable]
- ** Setting impossible when [Boot Up Drive] is set to [FDD -> HDD].
- *** Setting impossible when both [User Password] and [Supervisor Password] are the same.

Network

- The network connection may be severed when entering the ECO mode and suspend (hibernation) mode. Be sure to disable the [Suspend/Hibernation Timeout] settings with the Setup Utility if you require a network environment.
- When the power saving function is running, communications software may malfunction. For example, communications may be halted if the suspend (hibernation) mode is activated. The computer must be restarted if one of these modes is entered during data communications.
Be sure that the computer enters the ECO mode or suspend (hibernation) mode after the communications software is closed.

Hard Disk

FAT32

This computer uses a new, highly efficient file system called FAT32. Please note the following regarding FAT32.

- **Some software will not run normally:**

Do not run disk utilities and other software not compatible with FAT32. Doing so could cause incorrect information such as hard disk capacity to be shown or could destroy hard disk data.

Contact Panasonic Technical Support or other outlet for the software and obtain the latest version.

- **Non-recognition from other operating systems:**

You will not be able to view the contents of your hard disk from other operating systems. (For example, you will not be able to view the contents of your hard disk even when starting up using a floppy disk created with another computer.)

Other operating systems cannot therefore be installed. To install the operating system, please refer to the method listed below. If you are unsure about this explanation, do not proceed with installation of operating system.

- 1 Back up the contents of your hard disk.
- 2 Insert the FIRSTAID FD, and restart the computer.
- 3 When the [Windows 95 Startup Menu] appears, select [1. Boot].
- 4 Input [FDISK], then press **Enter** .
When [Do you wish to enable large disk support (Y/N)...?] appears on the screen, press **N** , then **Enter** .
- 5 Select [3. Delete partition or Logical DOS Drive].
- 6 Select [1. Delete Primary DOS Partition].
- 7 Start up again following the on-screen instructions.

These steps will allow you to install most operating systems.

The contents of the hard disk will be deleted. Always make sure to back up the hard disk beforehand.

The following steps will normally be unnecessary, however, if installation is not possible, try performing them.

- 8 Start up again using the FIRSTAID FD to open FDISK in the same way.
- 9 When [Do you wish to enable large disk support (Y/N)...?] appears on the first screen, press **N** , then **Enter** .
- 10 Select [1. Create DOS partition or Logical DOS Drive].
- 11 Set the partition following the on-screen instructions and activate it.
- 12 Start up again following the on-screen instructions.

Internet Explorer

Internet Explorer 4.01 places a tremendous load on the system in order to execute the wide variety of functions that it provides. As a result, some unexpected faults may occur.

If any of these faults occurs, try using the software with some Internet Explorer 4.01 functions turned off. (See Internet Explorer Help for more details.)

- **It takes a long time to reboot or the computer locks up.**

Delete the check mark ✓ for [Internet Explorer Channel Bar] in [Control Panel] - [Display] - [Web], then press [OK].

- **A system module error occurs.**

Set [⊘ (None)] for [Wallpaper] in [Control Panel] - [Display] - [Background].

- **Performing the above steps does not solve the problem.**

Uninstall Internet Explorer 4.0 with the following step.

Select [Microsoft Internet Explorer 4.01] in [Start] - [Settings] - [Control Panel] - [Add/Remove Programs] - [Install/Uninstall] and press [Add/Remove]. Follow the on-screen instructions.

- **If a window with the message [Version Conflict] appears during the installation process (network card and application installation), select [Yes].**

Proper operation may not be possible if [NO] is selected.

Reinstallation

When Windows is started up while pressing (F8), the [Microsoft Windows 95 Startup Menu] is displayed. After reinstalling Windows, [Previous version of MS-DOS] also appears in this menu, however, do not select this item as MS-DOS is not installed.

Power Saving Function in the Sound Chip

The sound chip has its own power saving function. You can enable this function in the [OPL3-SAx power management] tab (select [Start] - [Settings] - [Control Panel] - [Power] - [OPL3-SAx power management]).

In [Non Power Save mode], the power saving function is disabled.

(When a ZV card is used, set [Non Power Save mode] to enable sound to be normally produced. This is the default setting.)

In [Minimum level of power save], the power saving function is enabled. You may encounter problems, such as no sound from music CDs.

Do not select [Intermediate level of power save] or [Maximum level of power save] because noise is likely.

If a problem occurs with your hardware, and [POST Startup Error(s)] is displayed along with the error code(s), follow the on-screen instructions.

Setup: Setup Utility (👉 [page 34](#)) is started. Run [Load Default Settings (PnP)]. Rerun the Setup Utility to input the appropriate operating environment settings.

Exit: Ignore the error message(s), and restart the computer.

Code	Description
062	Boot failure--default configuration used
101	System Board Failure
102	System Board Failure
106	System Board Failure
114	Adapter ROM Error
151	System Board Failure
161	Bad CMOS Battery
162	Configuration Change Has Occurred
162	Configuration Error
163	Date and Time Incorrect
173	Configuration Change Has Occurred
201	Memory Size Error
301	Keyboard Error
303	Keyboard Error
604	Diskette Drive Error
605	Diskette Drive Error
1780	Hard Disk Error
1800	PCI Error
1801	PCI Error
1802	PCI Error
1803	PCI Error
1804	PCI Error
1805	PCI Error
1962	
8603	Pointing Device Error
I9990301	
I9990305	

This computer conforms to the specifications of the Desktop Management Interface (DMI). The DMI Viewer can be used when you want to know information on the internal systems this computer supports, starting with the CPU and memory.

Running DMI Viewer

Select [DMI Viewer] from [Start] - [Programs] - [Panasonic].

The screen shown below is displayed.

When you click on an item, detailed information on that item will be displayed.

Click to close the DMI Viewer

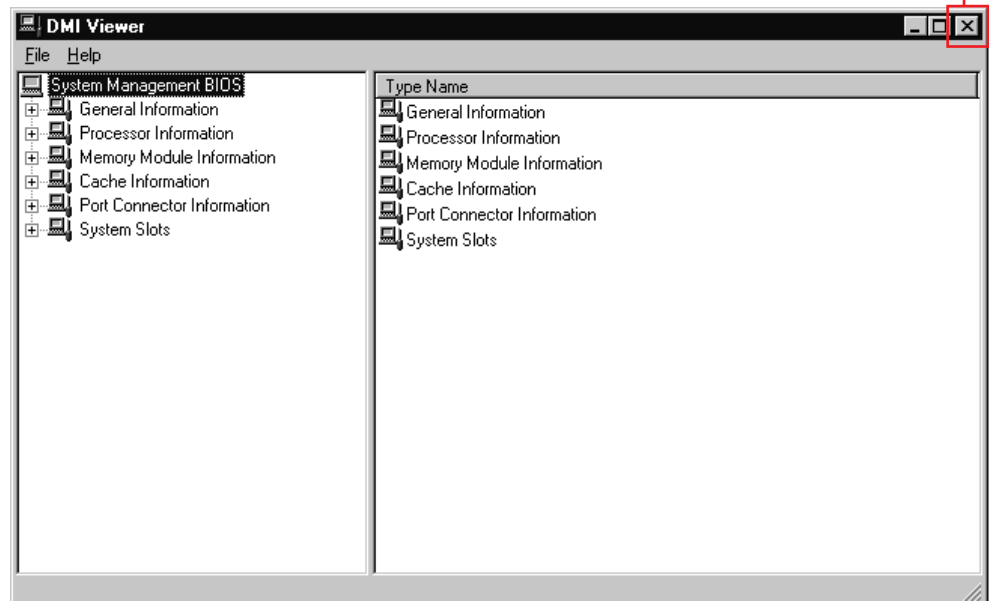

Saving information to a file

Displayed information can be saved to a text file (.txt). Run the DMI Viewer and display the information you wish to save.





1 ● **To save the item that is displayed**
Select [Save Selected Data] from [File] menu.

● **To save all items**
Select [Save All Data] from [File] menu.



2 Input the file name (and select the folder), then press [Save]

When a problem occurs, please refer to this page. If you still cannot troubleshoot the problem, please contact Panasonic Technical Support.

● Starting Up

<p>The power indicator or battery indicator is not lit</p>	<ul style="list-style-type: none"> ● Check the cable connection for the AC adapter. ● Check to see if a fully charged battery is properly installed. ● Remove the battery pack and disconnect the AC adapter, then connect them again.
<p> is displayed</p>	<p>Please input your password. If you have forgotten it, contact Panasonic Technical Support.</p>
<p>[POST Startup Error(s)] is displayed</p>	<p> page 42</p>
<p>The pre-memory count, Windows startup, or an operation is extremely slow</p>	<p>Run [Load Default Settings (PnP)] in the Setup Utility ( page 34). This will restore the Setup Utility's settings to their default values (except the password settings). Then, the Setup Utility must be run once again for you to input the appropriate operating environment settings. (The processing speed depends on the application software used, so this operation may not cause the processing speed to increase.)</p>
<p>The date and time are incorrect</p>	<p>You can set the date and time through [Date/Time] in [Start] - [Settings] - [Control Panel]. If you continue to experience problems, the internal battery maintaining the clock may need to be replaced. Please contact Panasonic Technical Support.</p>
<p>When the previous item is not the cause</p>	<ul style="list-style-type: none"> ● Run [Load Default Settings (PnP)] in the Setup Utility ( page 34). This will restore the Setup Utility's settings to their default values (except the password settings). ● Try removing all peripheral devices. ● In the MS-DOS mode, run SCANDISK to check the hard disk. ● At start-up, press (F8) to operate the computer in the Safe mode.

● Battery Indicator

<p>The red indicator lights. Repeated beeping sound while the computer is in use.</p>	<p>The battery level is low. Save your data and power off your computer. After connecting the AC adapter or replacing the battery pack with a fully charged one, turn your computer on.</p>
<p>The red indicator blinks</p>	<ul style="list-style-type: none"> ● The battery pack or recharging function may be defective. Quickly remove the battery pack and disconnect the AC adapter, then connect them again. ● If the problem persists, contact Panasonic Technical Support.
<p>After the AC adapter is connected, the orange indicator blinks five times</p>	<p>Unable to charge because of an improper temperature range. (  "Precautions")</p>

● Display

No display after powering on	<ul style="list-style-type: none"> ● At the time of purchase, the display setting is preset for an external display. If you connect an external display, the screen is displayed on the external display. ● When there is no display to an external display, <ul style="list-style-type: none"> • Check your cable connection to the external display. • Confirm your display is powered on. • Check the settings for your external display. ● Try changing the display by pressing (Fn) + (F3). ● When displaying only through an external display, if the computer is shut down by using the suspend or hibernation function, there will be no display on the LCD unless the external display is connected when operations are resumed. In this case, connect the external display.
The power has not been cut, but after a certain period of time, there is no display	<ul style="list-style-type: none"> ● Has the computer been set to the power-saving mode? To resume operation of your computer from ECO mode, press any key. ● To save power, your computer may have automatically entered the suspend or hibernation mode. (👉 page 15)
The resolution of the display cannot be changed	Set [None] for [Wallpaper] in [Start] - [Settings] - [Control Panel] - [Display] - [Background], and then press [OK]. Then, once again try changing the resolution. After the change, be sure to restart the computer.
An afterimage appears	If an image is displayed for a prolonged period of time, an afterimage may appear. This is not a malfunction. The afterimage will disappear when a different screen is displayed.
The motion of the mouse cursor is not smooth	Select [Start] - [Settings] - [Control Panel] - [Mouse] - [Motion] and add the check mark ✓ for [Show trails].
The cursor does not move in scrolling area of the touch pad	When the Microsoft® IntelliMouse™ wheel mode or the original mode is set for the touch pad, only scroll operations are possible for the right part or bottom part of the touch pad. In this case, cursor operations are possible by using the work surface excluding the right part or bottom part. When no mode is set, the entire surface of the touch pad can be used for cursor operations.



● Disk Operations

Cannot read/write to a floppy disk	<ul style="list-style-type: none"> ● Has the floppy disk been correctly inserted? ● Has the floppy disk been correctly formatted? ● Has the Setup Utility been used to set [Floppy Operation] to [Enable]? (👉 page 34) ● Your floppy disk content may be corrupted.
Unable to write to a floppy disk	Is the floppy disk write-protected?
How to format a floppy disk is unclear	Select [Format] in [My Computer] - [3 1/2 Floppy (A:)] - [File]. After confirming the disk volume and format type, start formatting.
Unable to read/write to the hard disk	<ul style="list-style-type: none"> ● Your drive or file may not have been properly set. ● Check to see if the hard disk is full. If it is full, delete unnecessary files. ● Your hard disk content may be corrupted. Contact Panasonic Technical Support.
When the previous item is not the cause	Try testing another drive or media.

● Character Input

Unable to input anything but numerals	If NumLk and Key Pad are on, the Numeric Key Pad is ON. To switch it OFF, press (Fn) + (Key Pad) .
Only capital letters are being input	If CapsLock is on, the Caps Lock function is ON. To switch it OFF, press (Caps Lock) .
How to input European characters (ß, à, ç) or symbols is unclear	Select [Start] - [Programs] - [Accessories] - [Character Map]. The Character Map will be displayed. Point to the desired font name and select it.

● Setup Utility

 is displayed	Enter the User Password or Supervisor Password. If you have forgotten it, contact Panasonic Technical Support.
[Supervisor Setup] is not displayed in the menu	At the start of the computer when  is displayed, you have to enter the Supervisor Password. When both the User Password and Supervisor Password have been set, if you enter the User Password, [Supervisor Setup] will not be displayed. If [Supervisor Setup] is not displayed even after entering the Supervisor Password, you have to delete the User Password. Run the Setup Utility again, and input the Supervisor Password.
[User Password] cannot be selected	[User Password Protection] in [Supervisor Setup] may be enabled.
[Coffee break Password] or [Key Combination for Coffee break] cannot be selected	You need to set the User Password.
[Supervisor Password] cannot be set	If the User Password has been set first, the Supervisor Password can not be the same as the User Password. Another password needs to be entered.





● Application Software

Computer hangs	<ul style="list-style-type: none"> ● Press (Ctrl) + (Alt) + (Del) to reboot the computer. ● After cutting the power by pressing the sleep switch for more than four seconds, slide the power switch to power on and open the application again. If the program no longer works normally, go to [Start] - [Settings] - [Control Panel] - [Add/Remove Programs] to delete the program. Then, try installing the program once again.
----------------	--

● Network

Unable to connect to a network	When using the computer as a network computer, some additional settings may have to be made depending on the usage conditions. We recommend asking your system administrator or the person in charge of the network.
--------------------------------	--

● Connecting Peripherals

Your peripheral does not work (An error occurs while installing the driver)	You need to use drivers conforming to Windows 95 Version 4.00.950C (OSR-2.5). Some earlier drivers will no longer work. For more information, please ask the manufacturer of the driver in question.
Unable to print	<ul style="list-style-type: none"> ● Check the computer-printer connection. ● Make sure the printer is on. ● Make sure the printer is in the online state. ● Make sure paper is in the printer tray and there is no paper jam. ● Has the Setup Utility been used to set [Parallel Port (Address)] to [Automatic (PnP)], [378] or [3BC]?
The cursor does not move from mouse operations	<ul style="list-style-type: none"> ● The Coffee break Password may be set; check if  is displayed. If this is the case, input the Coffee break Password. ● Check your mouse connection, then reboot the computer from the keyboard. From the keyboard, you may choose to press down on , then select [Shut Down].
The device connected to the serial port does not work	<ul style="list-style-type: none"> ● Check the connection. ● Confirm that the device driver for the serial port works. Please refer to the reference manual of the device. ● Confirm that two mouse devices are not connected, one through the external keyboard/mouse port and the other through the serial port. ● Try setting [Touch Pad] to disable in the Setup Utility. ● Has the Setup Utility been used to set [Serial Port] to [Automatic (PnP)] or [3F8]?
External mouse or trackball connected to the external keyboard/mouse port does not work	<ul style="list-style-type: none"> ● Try setting [Touch Pad] to disable in the Setup Utility. ● In some circumstances, if a PS/2 external mouse with a serial interface conversion function is connected to the port, it may not operate normally. Try connecting it to the serial port. ● If a switch is made to the Hand Written mode in Panasonic Hand Writing, any external mouse or trackball connecting to the external keyboard/mouse port will not operate. Reconnect the device after quitting the Hand Written mode. If the device still does not work, try restarting the computer.
A PC Card does not work	<ul style="list-style-type: none"> ● Make sure the card is properly inserted. ● Confirm that the card conforms to the PC Card Standard. ● Note that after a driver is installed, the computer must be rebooted. ● Check that the proper port settings have been made. ● Read the PC Card's manual. Or, you may need to call the manufacturer of the PC Card. ● If the ZV card does not operate properly, install PhoenixCard Manager™ for Windows® 95. ( page 24)
You do not know the available RAM module	 page 25
The RAM module has not been recognized	<ul style="list-style-type: none"> ● Make sure the RAM module has been properly inserted. ● Use the RAM module that support the recommended specifications.
The address map for IRQ, I/O port address, etc. is unclear	Check the address map by going to [View Resources] in [Start] - [Settings] - [Control Panel] - [System] - [Device Manager] - [Computer] - [Properties].
A USB device does not work	<ul style="list-style-type: none"> ● Make sure a driver is installed. ● Contact the manufacturer of the product.

Copyright

This manual is copyrighted by Matsushita Electric Industrial Co., Ltd. with all rights reserved. No part of this manual may be reproduced in any form without the prior written permission of Matsushita Electric Industrial Co., Ltd. No patent liability is assumed with respect to the use of the information contained herein.

© Matsushita Electric Industrial Co., Ltd. 1998. All Rights Reserved.

Disclaimer

Computer specifications and manuals are subject to change without notice. Matsushita Electric Industrial Co., Ltd. assumes no liability for damage incurred directly or indirectly from errors, omissions or discrepancies between the computer and the manuals.

Trademarks

PS/2™ is a trademark of International Business Machines Corporation.

Microsoft, MS-DOS, Windows and IntelliMouse are registered trademarks of Microsoft Corporation of the United States and/or other countries.

Pentium is a registered trademark of Intel Corporation.

PhoenixCard Manager is a trademark of Phoenix Technologies Ltd.

Imation, the Imation Logo, the circle-pyramid logo, SuperDisk and SuperDisk logo are trademarks of Imation Corp.

Acrobat is a registered trademark of Adobe Systems Incorporated.

Panasonic is a registered trademark of Matsushita Electric Industrial Co., Ltd.

A

Free Manuals Download Website

<http://myh66.com>

<http://usermanuals.us>

<http://www.somanuals.com>

<http://www.4manuals.cc>

<http://www.manual-lib.com>

<http://www.404manual.com>

<http://www.luxmanual.com>

<http://aubethermostatmanual.com>

Golf course search by state

<http://golfingnear.com>

Email search by domain

<http://emailbydomain.com>

Auto manuals search

<http://auto.somanuals.com>

TV manuals search

<http://tv.somanuals.com>