



Panasonic®

OPERATING INSTRUCTIONS

Personal Computer

Model No. **CF-74** series

Contents

Getting Started

Introduction	2
Read Me First	3
Description of Parts	9
First-time Operation	11

Getting Started

Useful Information

On-screen Manual	13
Handling and Maintenance	14
Hard Disk Backup Function	16
Hard Disk Data Erase Utility	19
Reinstalling Software	20

Useful Information

Troubleshooting

Error Code/Message	22
Troubleshooting (Basic)	23

Troubleshooting

Appendix

LIMITED USE LICENSE AGREEMENT	26
Contrat de licence d'usage limité	27
Specifications	28
LIMITED WARRANTY	30

Appendix

For further information about the computer, you can refer to the on-screen manual.

To access the on-screen manual
→ page 13 "On-screen Manual"

Please read these instructions carefully before using this product and save this manual for future use.

Introduction

Thank you for purchasing this Panasonic computer. For optimum performance and safety, please read these instructions carefully.

■ Terms and illustrations in these instructions

CAUTION	:	Conditions that may result in minor or moderate injury.
NOTE	:	Useful and helpful information.
Enter	:	Press [Enter] key.
Fn + F5	:	Press and hold [Fn] key, and then press [F5] key.
[start] - [Run]	:	Click [start], and then click [Run]. You may need to double-click in some cases.
→	:	Page in these Operating Instructions or in the Reference Manual.
	:	Reference to the on-screen manuals.

- Some illustrations are simplified to help your understanding and may look different from the actual unit.
- If you do not log on as an administrator, you cannot use some functions or cannot display some screens.
- Refer for the latest information about optional products to the catalogs, etc.
- In these instructions, the names and terms are referred as follows.
 - “Microsoft® Windows® XP Professional Service Pack 2 with Advanced Security Technologies” as “Windows” or “Windows XP”
 - “WinDVD™ 5 (OEM Version)” as “WinDVD”
 - “B’s Recorder GOLD8 BASIC” as “B’s Recorder”
 - “B’s CLiP 6” as “B’s CLiP”
 - DVD-ROM & CD-R/RW drive, and DVD MULTI drive as “CD/DVD drive”
 - Circular media including DVD-ROM and CD-ROM as “discs”
- The display modes are referred as follows. () indicates the terms in [Intel® 82852/82855 GM/GME Graphics Controller Properties] screen. To display the screen, select [start] - [Control Panel] - [Other Control Panel Options] - [Intel(R) Extreme Graphics 2 M].
 - Internal LCD (Notebook): The computer’s display
 - External display (Monitor): External display
 - Simultaneous display (Intel® Dual Display Clone): The same screen is displayed on the internal LCD and the external display.
 - Extended desktop: The extended working area across the internal LCD and the external display.

■ Copyright

This manual is copyrighted by Matsushita Electric Industrial Co., Ltd. with all rights reserved. No part of this manual may be reproduced in any form without the prior written permission of Matsushita Electric Industrial Co., Ltd. No patent liability is assumed with respect to the use of the information contained herein.
© 2006 Matsushita Electric Industrial Co., Ltd. All Rights Reserved.

■ Disclaimer

Computer specifications and manuals are subject to change without notice. Matsushita Electric Industrial Co., Ltd. assumes no liability for damage incurred directly or indirectly from errors, omissions or discrepancies between the computer and the manuals.

■ Trademarks

Microsoft®, Windows®, the Windows logo and IntelliMouse are registered trademarks of Microsoft Corporation of the United States and/or other countries.

Intel, Core, Centrino and PROSet are either registered trademarks or trademarks of Intel Corporation.

SD Logo is a trademark.



Adobe, the Adobe logo and Adobe Reader are either registered trademarks or trademarks of Adobe Systems Incorporated in the United States and/or other countries.

Bluetooth™ is a trademark owned by Bluetooth SIG, Inc., U.S.A. and licensed to Matsushita Electric Industrial Co., Ltd. WinDVD™ is a trademark of InterVideo, Inc.

Panasonic® is a registered trademark of Matsushita Electric Industrial Co., Ltd.

Names of products, brands, etc., appearing in this manual are trademarks or registered trademarks of their respective own companies.

Read Me First

Models for U.S.A.

Federal Communications Commission Radio Frequency Interference Statement

Note: This equipment has been tested and found to comply with the limits for a Class B digital device, pursuant to Part 15 of the FCC Rules. These limits are designed to provide reasonable protection against harmful interference in a residential installation. This equipment generates, uses and can radiate radio frequency energy and, if not installed and used in accordance with the instructions, may cause harmful interference to radio communications. However, there is no guarantee that interference will not occur in a particular installation. If this equipment does cause harmful interference to radio or television reception, which can be determined by turning the equipment off and on, the user is encouraged to try to correct the interference by one or more of the following measures:

- Reorient or relocate the receiving antenna.
- Increase the separation between the equipment and receiver.
- Connect the equipment into an outlet on a circuit different from that to which the receiver is connected.
- Consult the Panasonic Service Center or an experienced radio/TV technician for help.

Warning

To assure continued compliance, use only shielded interface cables when connecting to a computer or peripheral. Also, any changes or modifications not expressly approved by the party responsible for compliance could void the user's authority to operate this equipment.

FCC RF Exposure Warning:

- This equipment is provided with PC Card slot that could be used with wireless transmitters, which will be specifically recommended when they become available. Other third-party wireless transmitters have not been RF exposure evaluated for use with this computer and may not comply with FCC RF exposure requirements.

<Only for models with wireless LAN/Bluetooth>

- This equipment complies with FCC radiation exposure limits set forth for an uncontrolled environment.
- This equipment has been approved for mobile operation, and unless otherwise advised in separate supplemental instructions for individual wireless transmitter(s), requires minimum 20 cm spacing be provided between antenna(s) and all person's body (excluding extremities of hands, wrist and feet) during wireless modes of operation.
- This equipment may use multiple installed transmitters, which may be capable of simultaneous transmission.

<Only for models with wireless LAN>

This product is restricted to indoor use due to its operation in the 5.15 to 5.25 GHz frequency range.

FCC requires this product to be used indoors for the frequency range 5.15 to 5.25 GHz to reduce the potential for harmful interference to co-channel Mobile Satellite systems. High power radars are allocated as primary users of the 5.25 to 5.35 GHz and 5.65 to 5.85 GHz bands. These radar stations can cause interference with and/or damage this product.

This device complies with Part 15 of the FCC Rules.

Operation is subject to the following two conditions:

- (1) This device may not cause harmful interference, and
- (2) This device must accept any interference received, including interference that may cause undesired operation.

Responsible Party: Panasonic Corporation of North America
One Panasonic Way
Secaucus, NJ 07094
Tel No: 1-800-LAPTOP5 (1-800-527-8675)

FCC Regulation Notice for modem

This equipment contains a FCC approved modem.

FC Tested To Comply
With FCC Standards
FOR HOME OR OFFICE USE

1. This equipment complies with CFR47 Part 68 rules. On the computer is a label that contains, among other information, the FCC registration number and ringer equivalence number (REN) for this equipment. If required, this information must be provided to the telephone company.
2. An FCC compliant telephone cord and modular plug is provided with this equipment. This equipment is designed to be connected to the telephone network or premises wiring using a compatible modular jack which is Part 68 compliant. See Installation Instructions for details.
3. The REN is used to determine the quantity of devices which may be connected to the telephone line. Excessive RENs on the telephone line may result in the devices not ringing in response to an incoming call. In most, but not all area, the sum of RENs should not exceed five (5.0). To be certain of the number of devices that may be connected to a line, as determined by the total RENs, contact the local telephone company.
4. If your telephone equipment cause harm to the telephone network, the telephone company will notify you in advance that temporary discontinuance of service may be required. But if advance notice isn't practical, the telephone company will notify the customer as soon as possible. Also, you will be advised of your right to file a complaint with the FCC if you believe it is necessary.
5. The telephone company may take changes in its facilities, equipment, operations or procedures that could affect the operation of the equipment. If this happens the telephone company will provide advance notice in order for you to make necessary modifications to maintain uninterrupted service.
6. If trouble is experienced with this equipment, for repair or warranty information, please contact Panasonic Corporation of North America at DIAL TOLL FREE 1-800-LAPTOP5 (1-800-527-8675). If the equipment is causing harm to the telephone network, the telephone company may request that you disconnect the equipment until the problem is resolved.
7. There are no user serviceable parts contained in this equipment.
8. This equipment may not be used on coin service provided by the telephone company. Connection to party lines is subject to state tariffs.

9. The Telephone Consumer Protection Act of 1991 makes it unlawful for any person to use a computer or other electronic device to send any message via a telephone fax machine unless such message clearly contains in a margin at the top or bottom of each transmitted page or on the first page of the transmission, the date and time it is sent and an identification of the business or other entry, or other individual sending the message and the telephone number of the sending machine or such business, other entity, or individual. In order to program this information into your fax software, you should refer to the manual of the Fax software being used.
10. According to the FCC's electrical safety advisory, we recommend that you may install an AC surge arrester in the AC outlet to which this equipment is connected. Telephone companies report that electrical surges, typically lightning transients, are very destructive to customer terminal equipment connected to AC power sources and that this is a major nationwide problem.

“Caution : To reduce the risk of fire, use only No.26 AWG or larger telecommunication line cord.”

“ATTENTION : Pour réduire le risque d'incendie, utiliser uniquement des conducteurs de télécommunications 26 AWG ou de section supérieure.”

Notice for the products using LCD

This product uses one or more fluorescent lamps containing a small amount of mercury. It also contains lead in some components. Disposal of these materials may be regulated in your community due to environmental considerations.

For disposal or recycling information please contact your local authorities, or the Electronics Industries Alliance: <<http://www.eiae.org/>>

For U.S.A.-California Only

This product contains a CR Coin Cell Lithium Battery which contains Perchlorate Material - special handling may apply. See <http://www.dtsc.ca.gov/hazardouswaste/perchlorate/>

Models for Canada

Industry Canada (IC) Notice for modem

This equipment contains an Industry Canada approved modem unit.

The Industry Canada label is affixed on the modem unit.

EQUIPMENT ATTACHEMENT LIMITATIONS

“NOTICE: The Industry Canada label identifies certified equipment. This certification means that the equipment meets telecommunications network protective, operational and safety requirements as prescribed in the appropriate Terminal Equipment Technical Requirements document(s). The Department does not guarantee the equipment will operate to the user's satisfaction.

Before installing this equipment, users should ensure that it is permissible to be connected to the facilities of the local telecommunications company. The equipment must also be installed using an acceptable method of connection. The customer should be aware that compliance with the above conditions may not prevent degradation of service in some situations.

Repairs to certified equipment should be coordinated by a representative designated by the supplier. Any repairs or alterations made by the user to this equipment, or equipment malfunctions, may give the telecommunications company cause to request the user to disconnect the equipment.

Users should ensure for their own protection that the electrical ground connections of the power utility, telephone lines and internal metallic water pipe system, if present, are connected together. This precaution may be particularly important in rural areas. Caution: Users should not attempt to make such connections themselves, but should contact the appropriate electric inspection authority, or electrician, as appropriate.”

“NOTICE: The Ringer Equivalence Number (REN) assigned to each terminal device provides an indication of the maximum number of terminals allowed to be connected to a telephone interface. The termination on an interface may consist of any combination of devices subject only to the requirement that the sum of the Ringer Equivalence Numbers of all the devices does not exceed 5.”

REN: See bottom of the computer

RESTRICTIONS CONCERNANT LE RACCORDEMENT DE MATÉRIEL

“AVIS: L'étiquette d'Industrie Canada identifie le matériel homologué. Cette étiquette certifie que le matériel est conforme aux normes de protection, d'exploitation et de sécurité des réseaux de télécommunications, comme le prescrivent les documents concernant les exigences techniques relatives au matériel terminal. Le Ministère n'assure toutefois pas que le matériel fonctionnera à la satisfaction de l'utilisateur.

Avant d'installer ce matériel, l'utilisateur doit s'assurer qu'il est permis de le raccorder aux installations de l'entreprise locale de télécommunication. Le matériel doit également être installé en suivant une méthode acceptée de raccordement.

L'abonné ne doit pas oublier qu'il est possible que la conformité aux conditions énoncées ci-dessus n'empêche pas la dégradation du service dans certaines situations.

Les réparations de matériel homologué doivent être coordonnées par un représentant désigné par le fournisseur.

L'entreprise de télécommunications peut demander à l'utilisateur de débrancher un appareil à la suite de réparations ou de modifications effectuées par l'utilisateur ou à cause de mauvais fonctionnement.

Pour sa propre protection, l'utilisateur doit s'assurer que tous les fils de mise à la terre de la source d'énergie électrique, des lignes téléphoniques et des canalisations d'eau métalliques, s'il y en a, sont raccordés ensemble.

Cette précaution est particulièrement importante dans les régions rurales. Avertissement: L'utilisateur ne doit pas tenter de faire ces raccordements lui-même; il doit avoir recours à un service d'inspection des installations électriques, ou à un électricien, selon le cas.”

“AVIS: L'indice d'équivalence de la sonnerie (IES) assigné à chaque dispositif terminal indique le nombre maximal de terminaux qui peuvent être raccordés à une interface. La terminaison d'une interface téléphonique peut consister en une combinaison de quelques dispositifs, à la seule condition que la somme d'indices d'équivalence de la sonnerie de tous les dispositifs n'excède pas 5.”

IES: Voir sous le fond de l'ordinateur

<Only for models with wireless LAN/Bluetooth>

Industry Canada

This product complies with RSS210 Industry Canada.

Operation is subject to the following two conditions;

- (1) this device may not cause interference, and
- (2) this device must accept any interference, including interference that may cause undesired operation of the device.

<Only for models with wireless LAN>

This product (local network devices) for the band 5150-5250 MHz is only indoor usage to reduce potential for harmful interference to co-channel Mobile Satellite systems.

High power radars are allocated as primary users (meaning they have priority) of 5250-5350 MHz and 5650-5850 MHz and these radars could cause interference and/or damage to LELAN devices.

<Only for models with wireless LAN>

RF Exposure Warning

This equipment has been approved for mobile operation, and unless otherwise advised in separate supplemental instructions for individual wireless transmitter(s), requires minimum 20cm spacing be proved between antenna(s) and all person's body (excluding extremities of hands, wrist and feet) during wireless modes of operation.

<Pour modèles LAN sans fil uniquement>

Mise en garde concernant l'exposition à l'énergie radiofréquence

Cet équipement a été homologué pour un fonctionnement sans fil et, sauf avis contraire inclus dans la notice d'utilisation d'un autre émetteur sans fil, une distance minimale de 20 cm doit être assurée entre l'antenne et le corps de toute personne (à l'exclusion des mains, poignets et pieds) pendant le fonctionnement sans fil.

Models for Europe

<Only for model with a "CE" mark on the bottom of the computer>



Declaration of Conformity (DoC)

"Hereby, we declare that this Personal Computer is in compliance with the essential requirements and other relevant provisions of the Directive 1999/5/EC."

Hint:

If you want to get a copy of the original DoC of our products which relates to the R&TTE, please contact our web address: <http://www.doc.panasonic.de>

Contact:

Panasonic Services Europe
A Division of Panasonic Marketing Europe GmbH
Panasonic Testing Centre

Network connection.

The terminal equipment is intended for connection to the following public network;

In all the countries of European Economical Area;
- Public Switched Telephony Networks

Technical Features.

The terminal equipment includes the following features;

- DTMF dialing
- Maximum bitrate receiving mode: 56 kbit/s
- Maximum bitrate sending mode: 33.6 kbit/s

This product is designed to interwork with the Public Switched Telecommunication Networks in UK, Ireland, Netherlands, Sweden, Denmark, Finland, Switzerland, Luxembourg, Belgium, France, Germany, Spain, Portugal, Iceland, Greece, Italy, Norway and Austria.

Compliance Notice - CE Mark

This equipment is in conformance with the requirements of the European Council Directive listed below:

73/23/EEC Low Voltage Directive with amendment 93/68/EEC

89/336/EEC EMC Directive with amendments 92/31/EEC and 93/68/EEC

1999/5/EC R&TTE

Important Safety Instructions / Importantes Mesures De Sécurité

When using your telephone equipment, basic safety precautions should always be followed to reduce the risk of fire, electric shock and injury to persons, including the following:

1. Do not use this product near water, for example, near a bath tub, wash bowl, kitchen sink or laundry tub, in a wet basement or near a swimming pool.
2. Avoid using a telephone (other than a cordless type) during an electrical storm. There may be a remote risk of electric shock from lightning.
3. Do not use the telephone to report a gas leak in the vicinity of the leak.
4. Use only the power cord and batteries indicated in this manual. Do not dispose of batteries in a fire. They may explode. Check with local codes for possible special disposal instructions.

SAVE THESE INSTRUCTIONS

Certaines mesures de sécurité doivent être prises pendant l'utilisation de matériel téléphonique afin de réduire les risques d'incendie, de choc électrique et de blessures. En voici quelquesunes:

1. Ne pas utiliser l'appareil près de l'eau, p.ex., près d'une baignoire, d'un lavabo, d'un évier de cuisine, d'un bac à laver, dans un sous-sol humide ou près d'une piscine.
2. Éviter d'utiliser le téléphone (sauf s'il s'agit d'un appareil sans fil) pendant un orage électrique. Ceci peut présenter un risque de choc électrique causé par la foudre.
3. Ne pas utiliser l'appareil téléphonique pour signaler une fuite de gaz s'il est situé près de la fuite.
4. Utiliser seulement le cordon d'alimentation et le type de piles indiqués dans ce manuel. Ne pas jeter les piles dans le feu: elles peuvent exploser. Se conformer aux règlements pertinents quant à l'élimination des piles.

CONSERVER CES INSTRUCTIONS

Read Me First

Information to the User

<Only for model with wireless LAN and/or Bluetooth>

This product and your Health

This product, like other radio devices, emits radio frequency electromagnetic energy. The level of energy emitted by this product however is far much less than the electromagnetic energy emitted by wireless devices like for example mobile phones.

Because this product operates within the guidelines found in radio frequency safety standards and recommendations, we believe this product is safe for use by consumers. These standards and recommendations reflect the consensus of the scientific community and result from deliberations of panels and committees of scientists who continually review and interpret the extensive research literature.

In some situations or environments, the use of this product may be restricted by the proprietor of the building or responsible representatives of the organization. These situations may for example include:

- Using this product on board of airplanes, or
- In any other environment where the risk of interference to other devices or services is perceived or identified as harmful.

If you are uncertain of the policy that applies on the use of wireless devices in a specific organization or environment (e.g. airports), you are encouraged to ask for authorization to use this product prior to turning on the product.

Regulatory Information

We are not responsible for any radio or television interference caused by unauthorized modification of this product. The correction of interference caused by such unauthorized modification will be the responsibility of the user. We and its authorized resellers or distributors are not liable for damage or violation of government regulations that may arise from failing to comply with these guidelines.

Lithium Battery / Pile au lithium

Lithium Battery!

This computer contains a lithium battery to enable the date, time, and other data to be stored. The battery should only be exchanged by authorized service personnel.

Warning!

A risk of explosion from incorrect installation or misapplication may possibly occur.

Pile au lithium!

Le micro-ordinateur renferme une pile au lithium qui permet de sauvegarder certaines données, notamment la date et l'heure. La pile ne doit être remplacée que par un technicien qualifié.

Danger ! Risque d'explosion en cas de non respect de cette mise en garde!

CD/DVD Drive Caution

CAUTION!

THIS PRODUCT UTILIZES A LASER. USE OF CONTROLS, ADJUSTMENTS OR PERFORMANCE OF PROCEDURES OTHER THAN THOSE SPECIFIED HEREIN MAY RESULT IN HAZARDOUS RADIATION EXPOSURE. DO NOT OPEN COVERS AND DO NOT REPAIR YOURSELF. REFER SERVICING TO QUALIFIED PERSONNEL.

AVERTISSEMENT!

CET APPAREIL UTILISE UN LASER. L'UTILISATION DE COMMANDES OU DE RÉGLAGES OU L'EXÉCUTION DE PROCÉDURES AUTRES QUE CELLES SPÉCIFIÉES ICI PEUVENT PROVOQUER UNE EXPOSITION À DES RADIATIONS DANGEREUSES. NE PAS OUVRIR LES COUVERCLES NI ESSAYER DE RÉPARER SOIMÊME. CONFIER TOUT TRAVAIL D'ENTRETIEN À UN PERSONNEL QUALIFIÉ.

Laser safety information is appropriate only when drive with laser is installed.

Les mesures de sécurité relatives au laser ne s'appliquent que lors de l'installation d'une unité avec laser.

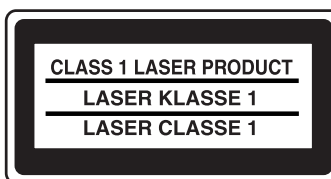

Bottom

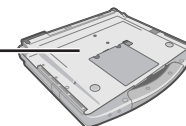

Information on Disposal for Users of Waste Electrical & Electronic Equipment (private households)



This symbol on the products and/or accompanying documents means that used electrical and electronic products should not be mixed with general household waste.

Please dispose of this item only in designated national waste electronic collection schemes, and not in the ordinary dust bin.

For business users in the European Union

If you wish to discard electrical and electronic equipment, please contact your dealer or supplier for further information.

Information on Disposal in other Countries outside the European Union

This symbol is only valid in the European Union. If you wish to discard this product, please contact your local authorities or dealer and ask for the correct method of disposal.

Precautions

THIS PRODUCT IS NOT INTENDED FOR USE AS, OR AS PART OF, NUCLEAR EQUIPMENT/SYSTEMS, AIR TRAFFIC CONTROL EQUIPMENT/SYSTEMS, OR AIRCRAFT COCKPIT EQUIPMENT/SYSTEMS*¹. PANASONIC WILL NOT BE RESPONSIBLE FOR ANY LIABILITY RESULTING FROM THE USE OF THIS PRODUCT ARISING OUT OF THE FOREGOING USES.

*¹ AIRCRAFT COCKPIT EQUIPMENT/SYSTEMS include Class2 Electrical Flight Bag (EFB) Systems and Class1 EFB Systems when used during critical phases of flight (e.g., during take-off and landing) and/or mounted on to the aircraft. Class1 EFB Systems and 2 EFB Systems are defined by FAA: AC (Advisory Circular) 120-76A or JAA: JAA TGL (Temporary Guidance Leaflets) No.36. Panasonic cannot guarantee any specifications, technologies, reliability, safety (e.g. Flammability/Smoke/ Toxicity/Radio Frequency Emission, etc) requirements related to aviation standards that exceed the specifications of our COTS (Commercial-Off-The-Shelf) products.

This computer is not intended for use in medical equipment including life-support systems, air traffic control systems, or other equipment, devices or systems that are involved with ensuring human life or safety. Panasonic cannot be held responsible in any way for any damages or loss resulting from the use of this computer in these types of equipment, devices or systems, etc.

This computer has been designed so as to minimize shock to the LCD and hard disk drive, the leakage of liquid (e.g., water) on to the keyboard, etc., but no warranty is provided against such trouble. Therefore, as a precision instrument, be extremely careful in the handling.

If a Malfunction Occurs, Immediately Unplug the AC Cord and the Battery Pack

- Computer is damaged
- Foreign object inside computer
- Smoke emitted
- Unusual smell emitted
- Unusually hot

Continuing to use the computer while any of the above conditions are present may result in fire or electric shock.

- If a malfunction occurs, immediately turn the power off and unplug the AC cord, and then remove the battery pack.

Do Not Touch the Computer and Cable When It Starts Thundering
Electric shock may result.

Do Not Connect the AC Adaptor to a Power Source Other Than a Standard Household AC Outlet

Otherwise, a fire due to overheating may result. Connecting to a DC/AC converter (inverter) may damage the AC adaptor. On an airplane, only connect the AC adaptor/charger to an AC outlet specifically approved for such use.

Do Not Do Anything That May Damage the AC Cord, the DC Plug, or the AC Adaptor

Do not damage or modify the cord, place it near hot tools, bend, twist, or pull it forcefully, place heavy objects on it, or bundle it tightly.

Continuing to use a damaged cord may result in fire, short circuit, or electric shock.

Do Not Pull or Insert the DC Plug If Your Hands Are Wet
Electric shock may result.

Clean the DC Plug of Dust and Other Debris Regularly

If dust or other debris accumulates on the plug, humidity, etc. may cause a defect in the insulation, which may result in a fire.

- Pull the plug, and wipe it with a dry cloth.
Pull the plug if the computer is not being used for a long period of time.

Insert the AC Plug Completely

If the plug is not inserted completely, fire due to overheating or electric shock may result.

- Do not use a damaged plug or loose AC outlet.

Do Not Place Containers of Liquid or Metal Objects on Top of the Computer

If water or other liquid spills, or if paper clips, coins, or foreign matter get inside the computer, fire or electric shock may result.

- If foreign matter has found its way inside, immediately turn the power off and unplug the AC cord, and then remove the battery pack. Then contact your technical support office.

Do Not Disassemble the Computer

There are high-voltage areas inside which may give you an electric shock if you should touch them. Do not touch the pins and circuit boards inside, and do not allow foreign matter to enter inside.

Also, remodeling or disassembly may cause a fire.

Keep SD Memory Cards Away from Infants and Small Children

Accidental swallowing will result in bodily injury.

In the event of accidental swallowing, see a doctor immediately.

Do Not Place the Computer on Unstable Surfaces

If balance is lost, the computer may fall over or drop, resulting in an injury.

Avoid Stacking

If balance is lost, the computer may fall over or drop, resulting in an injury.

Do Not Keep the Computer Wherever There is a Lot of Water, Moisture, Steam, Dust, Oily Vapors, etc.

Otherwise, possibly resulting in fire or electric shock.

Do Not Leave the Computer in High Temperature Environment Such as in a Sun-Heated Car, for a Long Period of Time

Leaving the computer where it will be exposed to extremely high temperatures such as in a sun-heated car or in direct sunlight may deform the cabinet and/or cause trouble in the internal parts. Continued use in such a resulting condition may lead to short-circuiting or insulation defects, etc. which may in turn lead to a fire or electric shocks.

Do Not Block the Ventilation Hole

Otherwise, heat will build up inside, possibly resulting in a fire.

Hold the Plug When Unplugging the AC Cord

Pulling on the cord may damage the cord, resulting in a fire or electric shock.

Do Not Move the Computer While the DC Plug Is Connected

The AC cord may be damaged, resulting in fire or electric shock.

- If the AC cord is damaged, unplug the DC plug immediately.

Use Only the Specified AC Adaptor With Your Computer

Using an AC adaptor other than the one supplied (attached to your computer or supplied by Panasonic) may result in a fire.

Do Not Subject the AC Adaptor to Any Strong Impact

Using the AC adaptor after a strong impact such as being dropped may result in electric shock, short circuit, or fire.

Take a Break of 10-15 Minutes Every Hour

Using the computer for long periods of time may have detrimental health effects on the eyes or hands.

Do Not Look into the CD/DVD Drive

Looking directly at the internal laser light source may result in damage to eyesight.

Do Not Use Disks That Are Cracked or Deformed

Because the disks rotate at high speeds, damaged disks may break apart causing injury.

- Disks that are not round and disks that have been repaired using adhesives are similarly dangerous, and so should not be used.

Do Not Turn the Volume Up to Loud When Using Headphones

Listening at high volumes that overstimulate the ear for long periods of time may result in loss of hearing.

Read Me First

Use the Modem with a Regular Telephone Line

Connection to an internal phone line (on-premise switches) of a company or business office, etc. or to a digital public phone or use in a country or area not supported by the computer may result in a fire or electric shocks.

Do Not Connect a Telephone Line, or a Network Cable Other Than the One Specified, into the LAN Port

If the LAN port is connected to a network such as the ones listed below, a fire or electric shock may result.

- Networks other than 100BASE-TX or 10BASE-T
- Phone lines (Telephone lines, internal phone lines (on-premise switches), digital public phones, etc.)

Do Not Use with Exposing the Skin to the Computer for a Long Period of Time

Using the computer with exposing the skin to the heat source of the computer or AC adaptor for a long period of time can cause a low-temperature burn.

- Do not place the computer near a television or radio receiver.
- Keep the computer away from magnets. Data stored on the hard disk may be lost.

Precautions (Battery Pack)

Do Not Use with Any Other Computer

The battery pack is rechargeable and was intended for the specified computer or charger. If it is used with a computer other than the one for which it was designed, electrolyte leakage, generation of heat, ignition or rupture may result.

Do Not Charge the Battery Using the Methods Other Than Indicated in This Manual

If the battery pack is not charged using one of the methods indicated in this manual, electrolyte leakage, generation of heat, ignition or rupture may result.

Do Not Throw the Battery Pack into a Fire or Expose It to Excessive Heat

Generation of heat, ignition or rupture may result.

Avoid Extreme Heat (Near the Fire, in Direct Sunlight, for Example)

Electrolyte leakage, generation of heat, ignition or rupture may result.

Do Not Insert Sharp Objects into the Battery Pack, Expose It to Bumps or Shocks, Disassemble, or Modify It

Electrolyte leakage, generation of heat, ignition or rupture may result.

Do Not Short the Positive (+) and Negative (-) Contacts

Generation of heat, ignition or rupture may result. Do not place the battery pack together with articles such as necklaces or hairpins when carrying or storing.



Do Not Use This Computer with a Battery Pack Other Than the One Specified

Use only the specified battery pack (CF-VZSU43AU) with your CF-74. Use of battery packs other than those manufactured and supplied by Panasonic may present a safety hazard (generation of heat, ignition or rupture).

- Do not touch the terminals on the battery pack. The battery pack may no longer function properly if the contacts are dirty or damaged.
- Do not expose the battery pack to water, or allow it to become wet.
- If the battery pack will not be used for a long period of time (a month or more), charge or discharge (use) the battery pack until the remaining battery level becomes 30% to 40% and store it in a cool, dry place.

- This computer prevents overcharging of the battery by recharging only when the remaining power is less than approx. 95% of capacity.
- The battery pack is not charged when the computer is first purchased. Be sure to charge it before using it for the first time. When the AC adaptor is connected to the computer, charging begins automatically.
- Should the battery leak and the fluid get into your eyes, do not rub your eyes. Immediately flush your eyes with clear water and see a doctor for medical treatment as soon as possible.

NOTE

- The battery pack may become warm during recharging or normal use. This is completely normal.
- Recharging will not commence if internal temperature of the battery pack is outside of the allowable temperature range (0 °C to 50 °C {32°F to 122°F}) (→  Reference Manual "Battery Power"). Once the allowable range requirement is satisfied, charging begins automatically. Note that the recharging time varies based on the usage conditions. (Recharging takes longer than usual when the temperature is 10 °C {50°F} or below.)
- If the temperature is low, the operating time is shortened. Only use the computer within the allowable temperature range.
- This computer has a high temperature mode function that prevents the degradation of the battery in high temperature environments. (→  Reference Manual "Battery Power") A level corresponding to a 100% charge for high temperature mode is approximately equivalent to an 80% charge level for normal temperature mode.
- The battery pack is a consumable item. If the amount of time the computer can be run by using a particular battery pack becomes dramatically shorter and repeated recharging does not restore its performance, the battery pack should be replaced with a new one.
- When transporting a spare battery inside a package, briefcase, etc., it is recommended that it be placed in a plastic bag so that its contacts are protected.
- Always power off the computer when it is not in use. Leaving the computer on when the AC adaptor is not connected will exhaust the remaining battery capacity.

Description of Parts

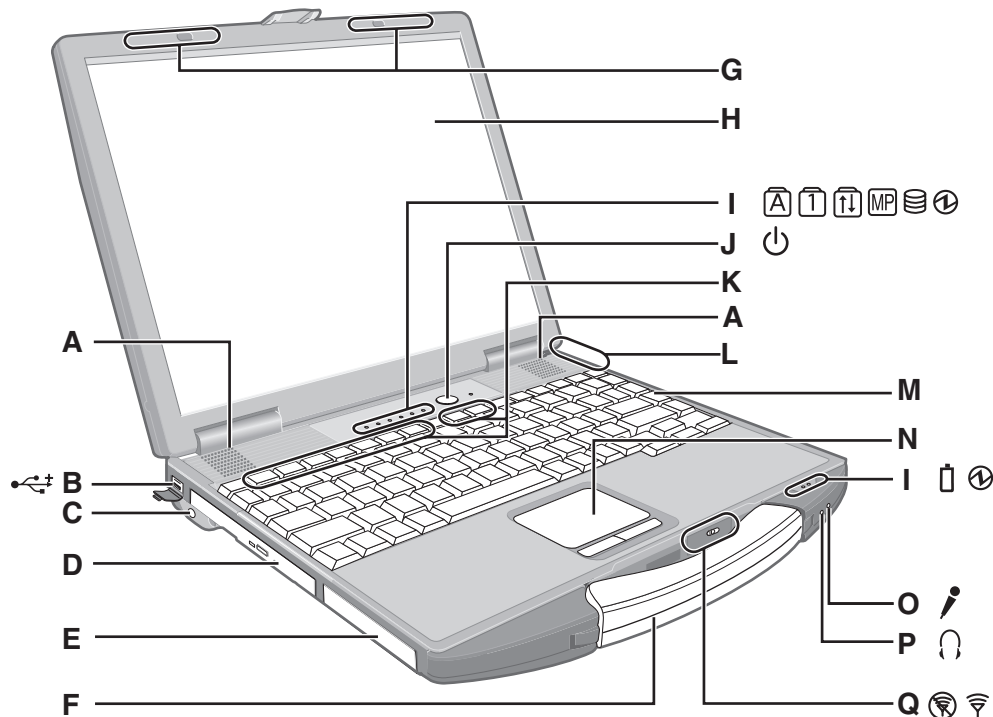

A : Speaker

→ Reference Manual "Key Combinations"

B : USB port

→ Reference Manual "USB Devices"

C : Stylus holder

D : Multimedia pocket

→ Reference Manual "Multimedia Pocket"

E : Hard disk drive

→ Reference Manual "Hard Disk Drive"

F : Carrying handle

G : Wireless LAN antenna

<Only for model with wireless LAN>

→ Reference Manual "Wireless LAN"

H : LCD

→ Reference Manual "Touchscreen"

I : LED indicator

: Caps lock

: Numeric key (NumLk)

: Scroll lock (ScrLk)

: Multimedia pocket device status or the second battery status

→ Reference Manual "Multimedia Pocket"
"Battery Power"

: Hard disk drive status

: Power status

(Off: Power off/Hibernation, Green: Power on, Blinking green: Standby, Blinking green rapidly: Cannot power on or resume due to low temperature.)

: Battery status

→ Reference Manual "Battery Power"

J : Power button

K : Function key

→ Reference Manual "Key Combinations"

L : Bluetooth antenna

<Only for model with Bluetooth>

→ Reference Manual "Bluetooth"

M : Keyboard

N : Touch pad

O : Microphone jack

You can use a stereo condenser microphone. Connecting other type of microphone may interrupt audio input or may cause a malfunction.

P : Headphone jack

You can connect headphones or amplified speakers. When they are connected, audio from the internal speakers is not heard.

Q : Wireless switch

→ Reference Manual "Wireless LAN" "Bluetooth"
"Wireless Switch Utility"

CAUTION

- Do not put a metallic object or magnetic media close to the speakers.

Description of Parts

Right side

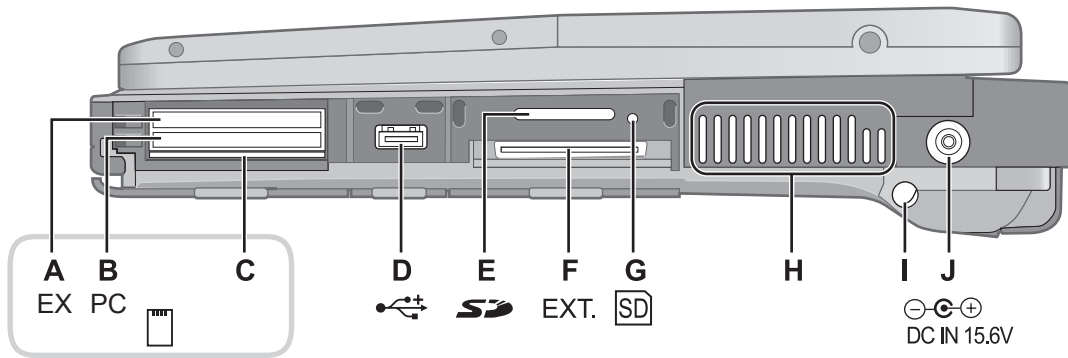

Rear side

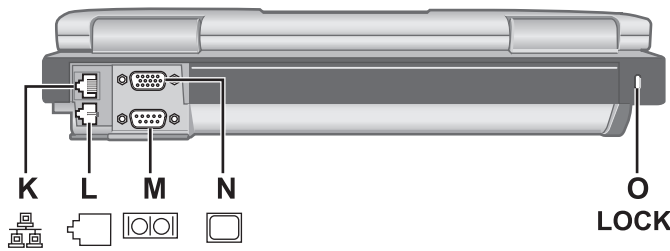

Bottom

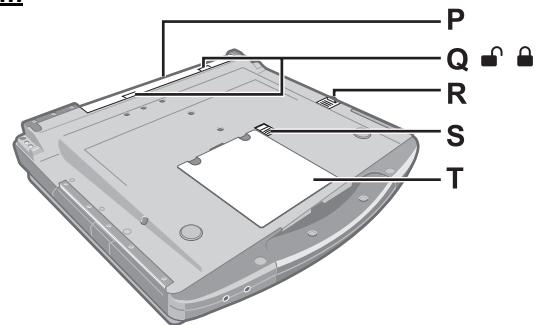

A : ExpressCard slot

→ Reference Manual "PC Card / ExpressCard"

B : PC Card slot

→ Reference Manual "PC Card / ExpressCard"

C : Smart Card slot

<Only for model with Smart Card slot>

→ Reference Manual "Smart Card"

D : USB port

→ Reference Manual "USB Devices"

E : SD Memory Card slot

→ Reference Manual "SD Memory Card"

F : Expansion bus connector

→ Reference Manual "Mini Port Replicator"

G : SD Memory Card indicator

(Blinking: During access or a password is requested)

→ Reference Manual "SD Memory Card"

H : Ventilation hole

I : Stylus holder

J : DC-IN jack

K : LAN port

→ Reference Manual "LAN"

L : Modem port

→ Reference Manual "Modem"

M : Serial port

N : External display port

→ Reference Manual "External Display"

O : Security lock

A Kensington cable can be connected.

For further information, read the manual that comes with the cable.

P : Battery pack

Q : Battery latch

R : Multimedia pocket release button

→ Reference Manual "Multimedia Pocket"

S : Hard disk drive latch

→ Reference Manual "Hard Disk Drive"

T : RAM module slot

→ Reference Manual "RAM Module"

CAUTION

- Do not block the ventilation hole with a thick cloth etc. Select a position with good ventilation.



A lithium ion battery that is recyclable powers the product you have purchased. Please call 1-800-8-BATTERY for information on how to recycle this battery.

L'appareil que vous vous êtes procuré est alimenté par une batterie au lithium-ion. Pour des renseignements sur le recyclage de la batterie, veuillez composer le 1-800-8-BATTERY.

First-time Operation

■ Preparation

① Check and identify the supplied accessories.

If you do not find the described accessories, contact Panasonic Technical Support (→ page 30).

- AC Adaptor 1
- AC Cord 1
- Battery Pack 1
- Modem Telephone Cable 1

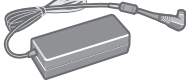

Model No: CF-AA1683A

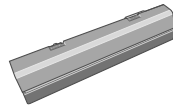

Model No: CF-VZSU43A



- Soft Cloth 1
- Stylus 1



(→ Reference Manual "Touchscreen")

- Operating Instructions (This book) . . . 1
- Product Recovery DVD-ROM 1
- Windows® Book 1

● You will need the serial number when you reinstall B's Recorder/B's CLiP using Product Recovery DVD-ROM (→ page 25).

② Read the LIMITED USE LICENSE AGREEMENT before breaking the seal on the computer's packaging (→ page 26).

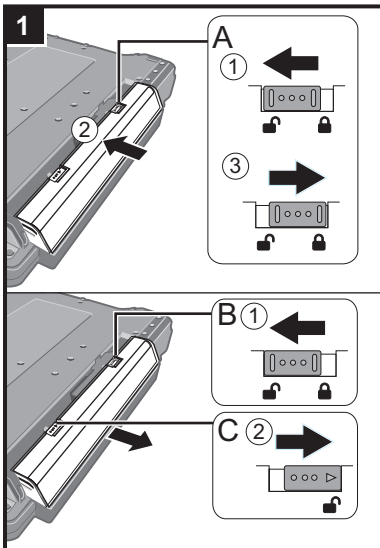

1 Insert the battery pack.

- ① Slide the right latch (A) to the unlocked position ().
- ② Insert the battery pack in the correct direction until it securely fits the connector.
- ③ Slide the right latch (A) to the locked position ().

■ To remove the battery pack

- ① Slide the right latch (B) to the unlocked position ().
- ② Slide and hold the left latch (C) to the unlocked position (), and hold the center of the battery pack and push out in parallel with the bottom surface of the computer.

CAUTION

- Make sure the latch is securely locked. Otherwise the battery pack may fall when you carry the computer.
- Do not touch the terminals of the battery pack and the computer. Doing so can make the terminals dirty or damaged, and may cause malfunction of the battery pack and the computer.

2 Connect your computer to a power outlet.

The battery charging starts automatically.



CAUTION

- Do not disconnect the AC adaptor and do not switch the wireless switch to on until the first-time operation procedure is completed.
- When using the computer for the first time, do not connect any peripheral device except the battery pack and AC adaptor.
- **Handling the AC adaptor**
 - Do not twist or pull the AC power cord forcefully. Doing so may damage the connections.
 - Use only the specified AC adaptor with your computer. Using an AC adaptor other than the one supplied might damage the battery and/or the computer.
 - When the DC plug is not connected to the computer, disconnect the AC cord from your AC wall outlet.
 - Problems such as sudden voltage drops may arise during periods of thunder and lightning. Since this could adversely affect your computer, an uninterruptible power source (UPS) is highly recommended unless running from the battery pack alone.

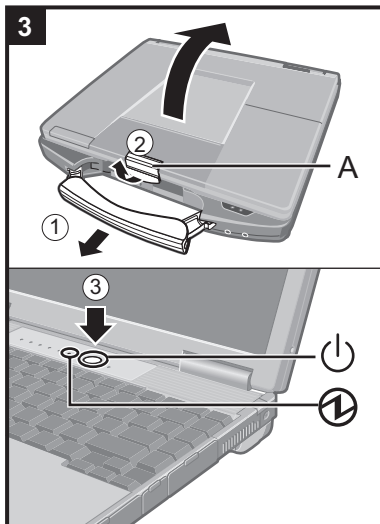
First-time Operation



3 Turn on the computer.

- ① Pull the carrying handle forward.
- ② Lift up the latch (A) and lift open the display.
- ③ Press and hold the power button  for approximately one second until the power indicator  lights.

CAUTION

- Do not press the power button repeatedly.
- The computer will forcibly be turned off if you press and hold the power button for four seconds or longer.
- Once you turn off the computer, wait for ten seconds or more before you turn on the computer again.
- Do not perform the following operation until the hard disk drive indicator  turns off.
 - Connecting or disconnecting the AC adaptor
 - Pressing the power button
 - Touching the keyboard, touch pad, touchscreen (only for model with touchscreen) or external mouse
 - Closing the display
- When the CPU temperature is high, the computer may not start up to prevent overheating of the CPU. Wait until the computer cools down, and then turn the power on again. If the computer does not power on even after cooling down, contact Panasonic Technical Support (→ page 30).

4 Setup Windows.

- ① Follow the on-screen instructions.

CAUTION

- When you set date/time/time zone and click [Next], the screen may not go to the next step for a few minutes. Do not touch the keyboard or touch pad, and wait until the screen changes.
- If "An unexpected error has occurred..." (or a similar message) is displayed, select [OK]. This is not a malfunction.
- Wait until the hard disk drive indicator  has turned off.

5 Create a new account.

- ① Click [start] - [Control Panel] - [User Accounts] - [Create a new account].

CAUTION

- Remember your password. If you forget the password, you cannot use the Windows operation system. Creating a password reset disk beforehand is recommended.

6 Perform the touchscreen calibration.

- ① Click [start] - [All programs] - [Fujitsu Touch Panel (USB)] - [Touch Screen Calibration Utility].
- ② Using the stylus, touch each of the 12 "+" target marks one by one until it blinks, and then click [Calibration].
- ③ Click [Save & Exit].

NOTE

● Regarding Windows XP

You can select the Classic view of Control Panel or the Classic Start menu. You can also change the way a user logs on or off. This manual explains using the Windows XP default setting (not Classic view or Classic Start menu etc.).

● Windows Update

You can update to the latest patches and service packs for Windows with the following menus.

[start] - [All Programs] - [Windows Update]

Do not apply "Driver Updates" even if a message to update a driver appears. If a driver update is required, contact Panasonic Technical Support (→ page 30).

● If the message "Your computer might be at risk" is displayed

Select  (red icon) on the taskbar and make the appropriate settings. The Windows Security Center regularly gives you notice so that you can make the optimum settings. This is not an error message and you can use the computer. However, making appropriate measures is recommended to reduce the risk of virus and other attacks.

● Note that the computer consumes electricity even when the computer power is off.

If the battery pack is fully charged, the battery will fully discharge in Approx. 3 weeks.

On-screen Manual

You can access the Reference Manual and the Important Tips on the computer screen.

When you access the Reference Manual and the Important Tips for the first time, the License Agreement of the Adobe Reader may be displayed. Read it carefully and select [Accept] to proceed.

■ Reference Manual

The Reference Manual contains the practical information to help you fully enjoy the computer's performance.

To access the Reference Manual:

- ① Click [start] - [Reference Manual].

Contents

- | | | |
|---------------------------------|------------------------|------------------------------|
| ● Key Combinations | ● SD Memory Card | ● Wireless Switch Utility |
| ● Touchscreen | ● SD Security | ● Wireless LAN |
| ● Standby/Hibernation Functions | ● Smart Card | ● Bluetooth |
| ● Security Measures | ● RAM Module | ● Hard Disk Drive |
| ● Battery Power | ● Mini Port Replicator | ● Setup Utility |
| ● Multimedia Pocket | ● External Display | ● Icon Enlarger |
| ● DVD-ROM & CD-R/RW Drive | ● USB Devices | ● Loupe Utility |
| ● WinDVD | ● Modem | ● DMI Viewer |
| ● B's Recorder/B's CLiP | ● LAN | ● Technical Information |
| ● PC Card / ExpressCard | | ● Troubleshooting (Advanced) |

■ Important Tips

The Important Tips will provide you with the helpful information about the battery and touchscreen. Read to use the battery pack in the optimum condition to obtain longer operation time.

To access the Important Tips:

- ① Double-click  on the desktop.
Important Tips

- Alternatively click [start] - [All Programs] - [Panasonic] - [On-Line Manuals] - [Important Tips].

Handling and Maintenance

Operation Environment

- Place the computer on a flat stable surface. Do not place the computer upright or turn it over. If the computer is exposed to an extremely strong impact, it may become inoperable.
 - Temperature: Operation: 5 °C to 35 °C {41 °F to 95 °F}
 Storage: -20°C to 60 °C {- 4 °F to 140 °F}
 - Humidity: Operation: 30% to 80% RH (No condensation)
 Storage: 30% to 90% RH (No condensation)
- Even within the above temperature/humidity ranges, using for a long time in an extreme environment will result in the product deterioration and will shorten the product life.
- Do not place the computer in the following areas, otherwise the computer may be damaged.
 - Near electronic equipment. Image distortion or noise may occur.
 - In extremely high or low temperature.
 - As the computer can become hot during operation, keep it away from items that are sensitive to heat.

Handling Cautions

This computer is designed to minimize shock to parts such as the LCD and the hard disk drive and equipped with a drip-proof keyboard, but no warranty is provided against any trouble caused by shock. Be extremely careful when handling the computer.

- When carrying the computer:
 - Turn off the computer.
 - Remove all external devices, cables, cards and other protruding things.
 - Remove a disc in the CD/DVD drive.
 - Do not drop or hit the computer against solid objects.
 - Do not leave the display open.
 - Do not grip the display part.
 - Do not put anything (e.g., a piece of paper) between the display and keyboard.
 - When you board an airplane, take the computer with you and never put it in your checked luggage. When using the computer on airplane, follow the airline's instructions.
 - When carrying a spare battery, put it in a plastic bag to protect its terminals.
 - The touch pad is designed to be used with a finger tip. Do not place any object on its surface and do not press down strongly with sharp-pointed or hard objects that may leave marks (e.g., nails, pencils and ball point pens).
 - Avoid any harmful substances such as oil from getting into the touch pad. The cursor may not work correctly.
- <Only for model with touchscreen>
- Use only the included stylus to touch the touchscreen. Do not place any object on its surface and do not press down strongly with sharp-pointed or hard objects that may leave marks (e.g., nails, pencils and ball point pens).
 - Do not use the stylus when dust or dirt (e.g., oil) is on the screen. Otherwise foreign particles on the screen/stylus can scratch the screen surface or obstruct the stylus operation.
 - Use the stylus only for touching the screen. Using it for any other purpose may damage the stylus and result in scratches on the screen.

■ When using peripheral devices

Follow these instructions and the Reference Manual to avoid any damage to the devices. Carefully read the instruction manuals of the peripheral devices.

- Use the peripheral devices conforming to the computer's specifications.
- Connect to the connectors in the correct direction.
- If it is hard to insert, do not try forcibly but check the connector's shape, direction, alignment of pins, etc.
- If screws are included, fasten them securely.
- Remove the cables when you carry the computer. Do not pull the cables forcibly.

■ Preventing your computer from unauthorized use via wireless LAN

<Only for model with wireless LAN>

- Before using wireless LAN, make the appropriate security settings such as data encryption.

Maintenance

To clean the LCD panel

Use the soft cloth included with the computer. (For further information, refer to “Suggestions About Cleaning the LCD Surface” that comes with the soft cloth.)

To clean areas other than the LCD panel

Wipe with a soft dry cloth such as gauze. When using detergent, dip a soft cloth in water-diluted detergent and wring it thoroughly.

CAUTION

- Do not use benzene, thinner, or rubbing alcohol since it may adversely affect the surface causing discoloration, etc. Do not use commercially-available household cleaners and cosmetics, as they may contain components harmful to the surface.
- Do not apply water or detergent directly to the computer, since liquid may enter inside of the computer and cause malfunction or damage.

Hard Disk Backup Function

The hard disk backup function creates a backup area (storage area) on the hard disk. This area is to back up (store) the hard disk data or to restore the backup data to their original locations.

Using this function, you can protect your data when it is lost or corrupted by operational errors or other factors. You do not need other media or peripheral devices to back up or restore hard disk data on this computer.

At purchase, the hard disk backup function is disabled. If you create a backup area, the hard disk backup function will be enabled and you can back up your data.

The hard disk backup function cannot back up or restore data correctly if a hard disk problem occurs during data backup or restoring. If an error occurs due to an unexpected malfunction, incorrect operation, or other reason while data is being restored, the hard disk data (data before restoration) may be lost.
Matsushita Electric Industrial Co., Ltd. will bear no responsibility for any damages suffered by the user (including loss of data) as a result of the use of this function.

CAUTION

- To disable the backup function after it is enabled, you have to perform the reinstallation procedure (→ page 20).
- A backup area cannot be created if the hard disk is already divided into several partitions. Return the computer to one partition, and create the backup area.
- If the partition configuration is changed after the backup area is created (creating partitions, changing size, etc.), the backup function will be disabled. You need to return the computer to the original condition and create the backup area again.
- Do not use the NTFS file system compression function. It may result in insufficient capacity of the backup area.
- The hard disk backup function does not accommodate dynamic disks. Do not convert the hard disk to a dynamic disk.

NOTE

- The backup area requires at least half of the entire hard disk capacity. If the capacity is not sufficient, the backup area will not be created.
- When the backup area is created, the usable hard disk capacity will be less than half of the original capacity.
- The backup area cannot be accessed from Windows. The backup data cannot be copied to CD-R or other removable disk media.
- When the hard disk backup function is executed, data in the backup area will be overwritten and the data previously stored will be lost.

Creating the Backup Area

Preparation

- Prepare the following items:
 - The Product Recovery DVD-ROM (included)
 - Panasonic CD/DVD drive (included)
- Remove all peripherals (except for the CD/DVD drive).
- Connect the AC adaptor and do not remove it until hard disk backup is complete.

- 1 Turn off the computer and insert the CD/DVD drive into the multimedia pocket (→  Reference Manual "Multimedia Pocket").**
- 2 Turn on the computer, and press F2 several times while [Panasonic] boot screen is displayed.**
The Setup Utility starts up.
 - If the password is requested, enter the Supervisor Password.
- 3 Select the [Boot] menu and select [IDE MP], and then press F6 until [IDE MP] moves up to the top of the boot priority order.**
- 4 Select the [Security] menu and set [CD/DVD Operation] to [Enable].**
- 5 Set the Product Recovery DVD-ROM into the CD/DVD drive.**

6 Press **F10**.

At the confirmation message, select [Yes] and press **Enter**.
The computer restarts.

- If [Enter Password] is displayed during the following procedures, input the Supervisor Password or the User Password.

7 Press **3** to execute [3. [Backup]].

At the confirmation message, press **Y**.

CAUTION

- When you divide the hard disk into partitions:
Do not execute [1. [Recovery]] to divide the hard disk into partitions. The hard disk backup function cannot be enabled after the hard disk has been partitioned. Use step 8 to divide the hard disk.

8 Select the setting.

- **To create a backup area and enable the backup function without dividing the hard disk**
Select [1].
- **To create a backup area and divide hard disk into two partitions, for OS and data**
Select [2]. Enter the size of operating system partition and press **Enter**.
 - To cancel: press **0**.
(The size of data partition will be determined by subtracting the operating system partition size from the maximum size.)

9 At the confirmation message, press **Y**.

The backup area is then created.

10 When the message [You must reboot in order to enable the Backup function.] appears, remove the Product Recovery DVD-ROM, and press any key to restart the computer.

The computer restarts, then the backup process will begin.

11 When the message [[Backup] is complete] appears, press **Ctrl + Alt + Del** to restart the computer.

- Do not press **Ctrl + Alt + Del** before the message is displayed.
- After logging on to Windows, a message will appear indicating that a new device has been installed and that the computer must be restarted to enable the settings.

12 Select [Yes] to restart the computer.

NOTE

- The [Boot] menu in the Setup Utility is now set to start up from the CD/DVD drive. Change it if necessary.
- To perform the backup/restore function next time; "Creating/Restoring the Backup Data" (→ below).
- The backup area cannot be accessed from windows.

Creating/Restoring the Backup Data

CAUTION

- Before executing the backup function, execute a disk error check.
- Do not interrupt the backup or restore functions. Do not turn off the power and do not press **Ctrl + Alt + Del**, otherwise Windows cannot start up, or the data may be lost and the backup and restore functions may not be completed.

1 Turn on the computer, and press **F2** several times while [Panasonic] boot screen is displayed.

The Setup Utility starts up.

- If the password is requested, enter the Supervisor Password or the User Password.

2 Select the [Exit] menu and select [Hard Disk Backup / Restore], and then press **Enter**.

At the confirmation message, select [Yes] and press **Enter**.

Hard Disk Backup Function

3 Select the setting.

● To back up hard disk contents to the backup area

- ① Press **1** to execute [1. [Backup]].
 - If the hard disk is divided into two partitions, select the backup method at the next screen.
- ② At the confirmation message, press **Y**.
 - The backup process starts.

● To restore backed up contents to the hard disk

- ① Press **2** to execute [2. [Restore]].
 - When data is backed up in two partitions, select the restore method at the next screen.
- ② At the confirmation message, press **Y**.
 - The restore process starts.

NOTE

- The required time to complete the backup or restore process depends on the data volume.

4 When the message **[[Backup] is complete]** or **[[Restore] is complete]** is displayed, press **Ctrl + Alt + Del** to restart the computer.

- If the backup or restore process was interrupted before completion, execute the process again.
- After logging on to Windows, a message will appear indicating that a new device has been installed and that the computer must be restarted to enable the settings. Select [Yes] to restart the computer.

CAUTION

- When the hard disk backup function has been enabled, you cannot erase the backup data even when you erase all data from user accessible area by using a commercial data erasing utility or similar software. To erase all data on the hard disk including backed up data, use the hard disk data erase utility included in this computer (→ page 19). Erase the data using the hard disk data erase utility before disposing of or transferring ownership of this computer.

■ To disable the hard disk backup function

Perform the reinstallation procedure.

CAUTION

- All data in the backup area and hard disk will be erased.

- ① Perform steps 1-9 for "Reinstalling Software" (→ page 20).
- ② Select [1] or [2] to execute the reinstallation at the screen for executing the reinstallation.
 - [1]: The hard disk backup function is disabled.
 - [2]: The hard disk backup function is disabled. However the hard disk backup function cannot be reenabled because the hard disk has been divided into partitions.
 - [3]: The hard disk backup function is not disabled.

Hard Disk Data Erase Utility

When disposing the computer or transferring the ownership, erase all hard disk data in order to avoid data leakage. Even if you erase the data or initialize the hard disk using normal Windows commands, the data can be read with some special software. Use the hard disk data erase utility to erase the data completely. Note that transferring of the ownership without uninstalling the commercial software will be a violation of the software's license agreement.

The hard disk data erase utility erases the data using overwriting method. If a malfunction or other operational error occurs during the erasing process, the data may not be completely erased. Also there may be special devices to read the erased data. To erase highly confidential data, ask a specialized company. Matsushita Electric Industrial Co., Ltd. will bear no responsibility for losses or damages suffered as a result of the use of this utility.

CAUTION

- The backup area and the backup data will be erased.

NOTE

- Even if hard disk data erase is performed, the number of times of DVD's region code setting will not be reset.

Preparation

- Prepare the following items:
 - The Product Recovery DVD-ROM (included)
 - Panasonic CD/DVD drive (included)
- Remove all peripherals (except for the CD/DVD drive).
- Connect the AC adaptor and do not remove it until hard disk data erase is complete.

- 1 Turn off the computer and insert the CD/DVD drive into the multimedia pocket (→  Reference Manual "Multimedia Pocket").**
- 2 Turn on the computer, and press F2 several times while [Panasonic] boot screen is displayed.**

The Setup Utility starts up.

 - If the password is requested, enter the Supervisor Password.
- 3 Select the [Boot] menu, then select [IDE MP] and press F6 until [IDE MP] is at the top of the boot priority order.**
- 4 Select the [Security] menu and set [CD/DVD Operation] to [Enable].**
- 5 Set the Product Recovery DVD-ROM into the CD/DVD drive.**
- 6 Press F10.**

At the confirmation message, select [Yes] and press Enter.
The computer restarts.

 - When the hard disk backup function has been enabled, the confirmation message appears to inform that the backup function will be disabled, and the backup area and data will be erased. Press Y to proceed.
- 7 Press 2 to execute [2. [Erase HDD]].**
 - To cancel this operation, press 0.
 - When the hard disk backup function has been enabled, the confirmation message appears to inform that the backup function will be disabled, and the backup area and data will be erased. Press Y to proceed. If the reboot message appears, press R to proceed.
- 8 At the confirmation message, press Y.**
- 9 When [<<< Start Menu >>>] is displayed, press Enter.**

The approximate time required for erasing data will be displayed.
- 10 Press Space.**

At the confirmation message, press Enter.
The hard disk erase process starts. When the operation is completed, the [Hard disk data has been deleted.] message will appear. If a problem has occurred during the operation, an error message will appear.

 - To cancel partway, press Ctrl + C. The data erasure will be up to that point.
- 11 Remove the Product Recovery DVD-ROM, and then press any key to turn off the computer.**

Reinstalling Software

When you reinstall the software, the hard disk data will be erased. Back up important data to other media or an external hard disk before reinstallation.

Reinstalling software will return the computer to the default condition. The hard disk backup area and the backup data (→ page 16) will be erased. (If you reinstall Windows in the first partition, the backup area and data will not be erased.) Even if the data is stored in partitions on the hard disk, it may be erased or corrupted.

Preparation

- Prepare the following items:
 - The Product Recovery DVD-ROM (included)
 - Panasonic CD/DVD drive (included)
- Remove all peripherals (except for the CD/DVD drive).
- Connect the AC adaptor and do not remove it until reinstallation is complete.

NOTE

- Even if reinstallation is performed, the number of times of DVD's region code setting will not be reset.

- 1 Turn off the computer and insert the CD/DVD drive into the multimedia pocket (→  Reference Manual "Multimedia Pocket").**
- 2 Turn on the computer, and press F2 several times while [Panasonic] boot screen is displayed.**

The Setup Utility starts up.

 - If the password is requested, enter the Supervisor Password.
- 3 Write down all of the contents of the Setup Utility and press F9.**

At the confirmation message, select [Yes] and press Enter.
- 4 Select the [Boot] menu, then select [IDE MP] and press F6 until [IDE MP] is at the top of the boot priority order.**
- 5 Select the [Security] menu and set [CD/DVD Operation] to [Enable].**
- 6 Set the Product Recovery DVD-ROM into the CD/DVD drive.**
- 7 Press F10.**

At the confirmation message, select [Yes] and press Enter.
The computer will restart.

 - When the hard disk backup function has been enabled, the confirmation message appears to inform that the backup function will be disabled, and the backup area and data will be erased. Press Y to proceed.
- 8 Press 1 to execute [1. [Recovery]].**

The License Agreement screen appears.

 - To cancel partway, press 0.
- 9 Press 1 to select [1. Yes, I agree to the provisions above and wish to continue!].**
- 10 Select the settings.**
 - [2]: Enter the size of operating system partition and press Enter.
You cannot create the hard disk backup area if you select [2].
(The size of data partition will be determined by subtracting the operating system partition size from the maximum size.)
 - [3]: Windows will be installed in the first partition.
(The size of the first partition must be 20 GB or more. If smaller, installation will not be possible.)
 - When the hard disk backup function has been enabled, the confirmation message appears to inform that the backup function will be disabled, and the backup area and data will be erased. Press Y to proceed. If the reboot message appears, press R to proceed.

At the confirmation message, press Y.
Reinstallation starts automatically. (It will take approximately 20 minutes.)

 - Do not interrupt reinstallation, for example by turning off the computer or pressing Ctrl + Alt + Del. Otherwise reinstallation may become unavailable as Windows may not start up or the data may be corrupted.
- 11 Remove the Product Recovery DVD-ROM, and then press any key to turn off the computer.**

12 Turn on the computer, and press F2 several times while [Panasonic] boot screen is displayed.

The Setup Utility starts up.

- If the password is requested, enter the Supervisor Password.

13 Press F9.

At the confirmation message, select [Yes] and then press Enter.

The Setup Utility settings excluding the password(s) will return to the default values.

14 Select the [Exit] menu and then select [Save Current Values], then press Enter.

At the confirmation message, select [Yes] and press Enter.

15 Turn the computer off by using the power button.

- If additional instructions are included with the computer, be sure to read them. It may be necessary to perform additional operations during the following procedure.

16 Perform the first-time operation (→ page 11).

17 Start the Setup Utility and change the settings as necessary.

■ **To change the drive letter of hard disk or CD/DVD drive**

NOTE

- Drive letters can be changed only when two or more partitions have been created on the hard disk drive.
- The name of the C: drive cannot be changed.
- Change the drive letters before installing applications.

- ① Click [start] - [Control Panel] - [Performance and Maintenance] - [Administrative Tools], and double-click [Computer Management].
- ② Click [Disk Management] from [Storage].
- ③ Right-click the hard disk partition or the CD/DVD drive name, and click [Change Drive Letter and Paths...].
- ④ Click [Change...].
- ⑤ Click [Assign the following drive letter] and the new drive letter, and then click [OK].
At the confirmation message, click [Yes].

Error Code/Message

Follow the instructions below when an error message or code appears. If the problem persists or if the error code/message is not shown here, contact Panasonic Technical Support (→ page 30).

Error Code/Message	Solution
0211 Keyboard error	<ul style="list-style-type: none"> ● Disconnect external keyboard or mouse.
0251 System CMOS checksum bad - Default configuration used	<p>An error has occurred in the memory of Setup Utility settings. This occurs when the memory content is changed by an unexpected program operation, etc.</p> <ul style="list-style-type: none"> ● Start the Setup Utility and return the settings to the default values, and then change the settings as necessary. ● If the problem persists, the internal clock battery may need to be replaced. Contact Panasonic Technical Support (→ page 30).
0271 Check date and time settings	<p>The date and time settings are not correct.</p> <ul style="list-style-type: none"> ● Start the Setup Utility and set the correct date and time. ● If the problem persists, the internal clock battery may need to be replaced. Contact Panasonic Technical Support (→ page 30).
0280 Previous boot incomplete - Default configuration used	<p>Startup has failed repeatedly, so the Setup Utility settings have been returned to the default values to startup the computer.</p> <ul style="list-style-type: none"> ● Start the Setup Utility and return the settings to the default values, and then change the settings as necessary.
Press <F2> to Setup	<ul style="list-style-type: none"> ● Write down the error details and press F2 to start the Setup Utility. Change the settings if necessary.
Operating System not found	<p>The operating system is not installed in the floppy disk or the hard disk that you are going to boot from.</p> <ul style="list-style-type: none"> ● If using a floppy disk, change the disk to the one you can use for boot. ● If using the hard disk, check if the hard disk is recognized in [Information] menu of the Setup Utility. If the hard disk is recognized, perform the reinstallation (→ page 20). If not, contact Panasonic Technical Support (→ page 30). ● If a device is connected to the ExpressCard slot or the USB port, disconnect the device, or set [ExpressCard Slot], [USB Port] or [Legacy USB Support] to [Disable] in the [Advanced] menu of the Setup Utility.
Extended RAM Module Failed	<p>When the extended RAM module is not inserted correctly or the extended RAM module is not conforming to the computer's specifications, so a beep will sound and the "Extended RAM Module Failed" message will be displayed when you turn the power on.</p> <ul style="list-style-type: none"> ● Press the power button for four seconds or longer to turn off the computer, confirm that the extended RAM module conforms to the specifications, and reinsert it.

■ To start the Setup Utility

- ① Restart the computer.
- ② Press **F2** several times while [Panasonic] boot screen is displayed.

Troubleshooting (Basic)

Follow the instructions below when a problem has occurred. There is also an advanced troubleshooting guide in the "Reference Manual". For a software problem, refer to the software's instruction manual. If the problem persists, contact Panasonic Technical Support (→ page 30). You can also check the computer's status in the PC Information Viewer (→  Reference Manual "Troubleshooting (Advanced)").

■ Starting Up

<p>Cannot start up. The power indicator or battery indicator is not lit.</p>	<ul style="list-style-type: none"> ● Connect the AC adaptor. ● Insert a fully charged battery. ● Remove the battery pack and the AC adaptor, then connect them again. ● If a device is connected to the ExpressCard slot or the USB port, disconnect the device, or set [ExpressCard Slot], [USB Port] or [Legacy USB Support] to [Disable] in the [Advanced] menu of the Setup Utility.
<p>The power is turned on but "Warming up the system (up to 30 minutes)" appears.</p>	<ul style="list-style-type: none"> ● The computer is warming up before start up. Wait for the computer to start up (takes up to 30 minutes). If, "Cannot warm up the system" is displayed, the computer failed to warm up and does not start. In this case, turn off the computer, leave it in an environment of 5 °C {41 °F} or higher temperature for about an hour, and then turn on the power again.
<p>Cannot turn on the computer. The computer does not resume from standby. (The power indicator blinks quickly in green.)</p>	<ul style="list-style-type: none"> ● Leave it in an environment of 5 °C {41 °F} or higher temperature for about an hour, then turn on the power again.
<p>You have forgotten the password.</p>	<ul style="list-style-type: none"> ● Supervisor Password or User Password: Contact Panasonic Technical Support (→ page 30). ● Administrator password: <ul style="list-style-type: none"> • If you have a password reset disk, you can reset the administrator password. Set the disk and enter any wrong password, then follow the on-screen instructions and set a new password. • If you do not have a password reset disk, reinstall (→ page 20) and set up Windows, and then set a new password.
<p>"Remove disks or other media. Press any key to restart" or a similar message appears.</p>	<ul style="list-style-type: none"> ● A floppy disk is in the drive and it does not contain system startup information. Remove the floppy disk and press any key. ● This message may appear with some devices connected to the ExpressCard slot or the USB port. Remove the device, or set [ExpressCard Slot], [USB Port] or [Legacy USB Support] to [Disable] in the [Advanced] menu of the Setup Utility. ● If the problem persists after removing the disk, it may be a hard disk failure. Contact Panasonic Technical Support (→ page 30).
<p>Windows startup and operation is slow.</p>	<ul style="list-style-type: none"> ● Press F9 in the Setup Utility (→ page 22 "To start the Setup Utility") to return the Setup Utility settings (excluding the passwords) to the default values. Start the Setup Utility and make the settings again. (Note that the processing speed depends on the application software, so this procedure may not make Windows faster.) ● If you installed a resident software after purchase, turn off the residence. ● Disable Indexing Service in the following menu. Click [start] - [Search] - [Change preferences] - [Without Indexing Service]
<p>The date and time are incorrect.</p>	<ul style="list-style-type: none"> ● Make the correct settings. Click [start] - [Control Panel] - [Date, Time, Language, and Regional Options] - [Date and Time]. ● If the problem persists, the internal clock battery may need to be replaced. Contact Panasonic Technical Support (→ page 30). ● When the computer is connected to LAN, check the date and time of the server. ● The 2100 A.D. or later year will not be correctly recognized on this computer.
<p>[Executing Battery Recalibration] screen appears.</p>	<ul style="list-style-type: none"> ● The Battery Recalibration was canceled before Windows was shut down last time. To start up Windows, turn off the computer by the power button, and then turn on.
<p>[Enter Password] does not appear when resuming from standby/hibernation.</p>	<ul style="list-style-type: none"> ● To display [Enter Password] at resuming, set the Windows password. The password you have set in the Setup Utility is not requested at resuming. <ol style="list-style-type: none"> ① Click [start] - [Control Panel] - [User Accounts] and select the account, and set the password. ② Click [start] - [Control Panel] - [Performance and Maintenance] - [Power Options] - [Advanced] and add a check mark for [Prompt for password when computer resumes from standby].

Troubleshooting (Basic)

■ Starting Up

Cannot resume.	<ul style="list-style-type: none"> ● An error may occur when the computer automatically enters the standby or hibernation mode while the screensaver is active. In this case, turn off the screensaver or change the pattern of the screensaver.
Other startup problems.	<ul style="list-style-type: none"> ● Press F9 in the Setup Utility (→ page 22 “To start the Setup Utility”) to return the Setup Utility settings (excluding the passwords) to the default values. Start the Setup Utility and make the settings again. ● Remove all peripheral devices. ● Check to see if there was a disk error. <ol style="list-style-type: none"> ① Click [start] - [My Computer] and right-click [Local Disk(C:)], and click [Properties]. ② Click [Tools] - [Check Now]. ③ Select the option in [Check disk options] and click [Start]. ● Start the computer in Safe Mode and check the error details. When the [Panasonic] boot screen disappears*¹ at startup, press and hold F8 until the Windows Advanced Options Menu is displayed. <p>*¹ When [Password on boot] is set to [Enable] in the [Security] menu of the Setup Utility, [Enter Password] appears after the [Panasonic] boot screen disappears. As soon as you enter the password and press Enter, press and hold F8.</p>

■ Shutting down

Windows does not shut down.	<ul style="list-style-type: none"> ● Remove the USB device and the ExpressCard. ● Wait one or two minutes. It is not a malfunction.
-----------------------------	---

■ Display

No display.	<ul style="list-style-type: none"> ● The external display is selected. Press Fn + F3 to switch the display. Wait until the display has been switched completely before pressing Fn + F3 again. ● When using an external display, <ul style="list-style-type: none"> • Check the cable connection. • Turn on the display. • Check the settings of external display. ● The display is turned off by the power-saving function. To resume, do not press the direct selection keys, but press any other key like Ctrl. ● The computer entered standby or hibernation by the power-saving function. To resume, press the power button.
The screen is dark.	<ul style="list-style-type: none"> ● The screen is darker when the AC adaptor is not connected. Press Fn + F2 and adjust the brightness. As you increase the brightness, battery consumption increases. You can separately set the brightness for when the AC adaptor is connected and when not connected.
The LCD brightness changes a number of times when the AC adaptor is disconnected.	<ul style="list-style-type: none"> ● Intel(R) Display Power Saving Technology is active and automatically changes the LCD brightness. This is not a malfunction.
Image colors are not reproduced as expected when displaying photographs or other images.	<ul style="list-style-type: none"> ● Remove the check mark of [Intel(R) Display Power Saving Technology]. <ol style="list-style-type: none"> ① Select [start] - [Control Panel] - [Other Control Panel Options] - [Intel(R) GMA Driver for Mobile]. ② Select [Display Settings] - [Power Settings].
The screen is disordered.	<ul style="list-style-type: none"> ● Changing the number of display colors and resolution may affect the screen. Restart the computer. ● Connecting/disconnecting an external display may affect the screen. Restart the computer. ● When using Simultaneous display, set the same display colors for the external display as those for the LCD. ● When using Simultaneous display, do not press Fn + F3. ● Enable or disable Simultaneous display, and soon restart the computer.

■ Display

During Simultaneous display, one of the screens becomes disordered.	<ul style="list-style-type: none"> ● When using the Extended Desktop, use the same display colors for the external display as those used by the LCD. ● If you continue to experience problems, try changing the display by clicking [start] - [Control Panel] - [Other Control Panel Options] - [Intel(R) GMA Driver for Mobile] - [Display Devices] ● When the [Command Prompt] is set to "Full Screen" by pressing Alt + Enter, the picture is displayed on one of the screens only. When the window display is restored by pressing Alt + Enter, the picture is displayed on both screens. ● Simultaneous display cannot be used until Windows startup is complete (during Setup Utility, etc.).
The external display does not work normally.	<ul style="list-style-type: none"> ● If the external display does not support the power saving function, it may not work normally when the computer enters the power saving mode. Turn off the external display.

■ Touch Pad / Touchscreen (only for model with touchscreen)

The cursor does not work.	<ul style="list-style-type: none"> ● When using the external mouse, connect it correctly. ● Restart the computer using the keyboard. (Press F8, U, and R to select [Restart].) ● If the computer does not respond to keyboard commands, read "No response" (→ below).
Cannot input using the touch pad.	<ul style="list-style-type: none"> ● Set [Touch Pad] to [Enable] in the [Main] menu of the Setup Utility. ● The drivers for some mice may disable the touch pad. Check your mouse's operating instructions.
Cannot input using the touchscreen.	<ul style="list-style-type: none"> ● When mouse drivers are installed (i.e. IntelliMouse), the touchscreen does not work. Reinstall the touchscreen driver.
Cannot point the correct position using the included stylus.	<ul style="list-style-type: none"> ● Perform the touchscreen calibration (→ page 12).

■ Reference Manual

The Reference Manual is not displayed.	<ul style="list-style-type: none"> ● Install Adobe Reader. <ol style="list-style-type: none"> ① Log on to Windows as an administrator. ② Click [start] - [Run], input [c:\util\reader\AdbeRdr70_enu_full.exe], then click [OK]. ③ Follow the on-screen instructions.
--	---

■ Reinstalling B's Recorder/B's CLiP

A serial number is requested when reinstalling.	<ul style="list-style-type: none"> ● Input the following serial number B's Recorder: B's CLiP:
---	---

■ Others

No response.	<ul style="list-style-type: none"> ● Press Ctrl+Shift+Esc to open Task Manager and close the software application that is not responding. ● An input screen (e.g., password input screen at startup) may be hidden behind another window. Press Alt+Tab to check. ● Press the power button for four seconds or longer to shut down the computer, and then press the power button to turn it on. If the application program does not work normally, uninstall and reinstall the program. To uninstall, click [start] - [Control Panel] - [Add or Remove Programs].
--------------	--

LIMITED USE LICENSE AGREEMENT

THE SOFTWARE PROGRAM(S) ("PROGRAMS") FURNISHED WITH THIS PANASONIC® PRODUCT ("PRODUCT") ARE LICENSED ONLY TO THE END-USER ("YOU"), AND MAY BE USED BY YOU ONLY IN ACCORDANCE WITH THE LICENSE TERMS DESCRIBED BELOW. YOUR USE OF THE PROGRAMS SHALL BE CONCLUSIVELY DEEMED TO CONSTITUTE YOUR ACCEPTANCE OF THE TERMS OF THIS LICENSE.

Matsushita Electric Industrial Co., Ltd. ("MEI") has developed or otherwise obtained the Programs and hereby licenses their use to you. You assume sole responsibility for the selection of the Product (including the associated Programs) to achieve your intended results, and for the installation, use and results obtained therefrom.

LICENSE

- A. MEI hereby grants you a personal, non-transferable and non-exclusive right and license to use the Programs in accordance with the terms and conditions stated in this Agreement. You acknowledge that you are receiving only a LIMITED LICENSE TO USE the Programs and related documentation and that you shall obtain no title, ownership nor any other rights in or to the Programs and related documentation nor in or to the algorithms, concepts, designs and ideas represented by or incorporated in the Programs and related documentation, all of which title, ownership and rights shall remain with MEI or its suppliers.
- B. You may use the Programs only on the single Product which was accompanied by the Programs.
- C. You and your employees and agents are required to protect the confidentiality of the Programs. You may not distribute or otherwise make the Programs or related documentation available to any third party, by time-sharing or otherwise, without the prior written consent of MEI.
- D. You may not copy or reproduce, or permit to be copied or reproduced, the Programs or related documentation for any purpose, except that you may make one (1) copy of the Programs for backup purposes only in support of your use of the Programs on the single Product which was accompanied by the Programs. You shall not modify, or attempt to modify, the Programs.
- E. You may transfer the Programs and license them to another party only in connection with your transfer of the single Product which was accompanied by the Programs to such other party. At the time of such a transfer, you must also transfer all copies, whether in printed or machine readable form, of every Program, and the related documentation, to the same party or destroy any such copies not so transferred.
- F. You may not remove any copyright, trademark or other notice or product identification from the Programs and you must reproduce and include any such notice or product identification on any copy of any Program.

YOU MAY NOT REVERSE ASSEMBLE, REVERSE COMPILE, OR MECHANICALLY OR ELECTRONICALLY TRACE THE PROGRAMS, OR ANY COPY THEREOF, IN WHOLE OR IN PART.

YOU MAY NOT USE, COPY, MODIFY, ALTER, OR TRANSFER THE PROGRAMS OR ANY COPY THEREOF, IN WHOLE OR IN PART, EXCEPT AS EXPRESSLY PROVIDED IN THE LICENSE.

IF YOU TRANSFER POSSESSION OF ANY COPY OF ANY PROGRAM TO ANOTHER PARTY, EXCEPT AS PERMITTED IN PARAGRAPH E ABOVE, YOUR LICENSE IS AUTOMATICALLY TERMINATED.

TERM

This license is effective only for so long as you own or lease the Product, unless earlier terminated. You may terminate this license at any time by destroying, at your expense, the Programs and related documentation together with all copies thereof in any form. This license will also terminate effective immediately upon occurrence of the conditions thereof set forth elsewhere in this Agreement, or if you fail to comply with any term or condition contained herein. Upon any such termination, you agree to destroy, at your expense, the Programs and related documentation together with all copies thereof in any form.

YOU ACKNOWLEDGE THAT YOU HAVE READ THIS AGREEMENT, UNDERSTAND IT AND AGREE TO BE BOUND BY ITS TERMS AND CONDITIONS. YOU FURTHER AGREE THAT IT IS THE COMPLETE AND EXCLUSIVE STATEMENT OF THE AGREEMENT BETWEEN US, WHICH SUPERSEDES ANY PROPOSAL OR PRIOR AGREEMENT, ORAL OR WRITTEN, AND ANY OTHER COMMUNICATIONS BETWEEN US, RELATING TO THE SUBJECT MATTER OF THIS AGREEMENT.

About Intel® software products

The enclosed software products and documentation were developed at private expense, and are provided with "RESTRICTED RIGHTS." Use, duplication or disclosure by the government is subject to restrictions as set forth in FAR 52.227-14 and DFARS 252.227-7013 et. seq. or its successor. The use of this product by the government constitutes acknowledgment of Intel's proprietary rights in the product.

Contrat de licence d'usage limité

Le(s) logiciel(s) (les "Logiciels") fournis avec ce produit Panasonic® (le "Produit") sont exclusivement concédés en licence à l'utilisateur ultime ("vous"), et ils ne peuvent être utilisés que conformément aux clauses contractuelles cidessous. En utilisant les logiciels, vous vous engagez de manière définitive à respecter les termes, clauses et conditions des présentes.

Matsushita Electric Industrial Co., Ltd. ("MEI") a mis au point ou obtenu les Logiciels et vous en concède l'utilisation par les présentes. Vous assumez l'entière responsabilité du choix de ce Produit (y compris des Logiciels associés) pour obtenir les résultats escomptés, ainsi que de l'installation, de l'utilisation et des résultats obtenus.

Licence

- A. MEI vous octroie par les présentes le droit et la licence personnels, non cessibles et non exclusifs d'utiliser les Logiciels conformément aux termes, clauses et conditions de ce contrat. Vous reconnaissez ne recevoir qu'un droit limité d'utiliser les Logiciels et la documentation les accompagnant et vous vous engagez à n'obtenir aucun droit de titre, propriété ni aucun autre droit vis-à-vis des Logiciels et de la documentation les accompagnant ni vis-à-vis des algorithmes, concepts, dessins, configurations et idées représentés par ou incorporés dans les Logiciels et la documentation les accompagnant, dont les titres, propriété et droits resteront tous à MEI ou à leurs propriétaires.
- B. Vous ne pouvez utiliser les Logiciels que sur le Produit unique qui est accompagné par les Logiciels.
- C. Vous et vos employés ou agents êtes requis de protéger la confidentialité des Logiciels. Vous ne pouvez ni distribuer ni mettre les Logiciels et la documentation les accompagnant à la disposition d'un tiers, par partage de temps ou de quelque autre manière que ce soit, sans l'autorisation écrite préalable de MEI.
- D. Vous ne pouvez ni copier ni reproduire ni permettre la copie ni la reproduction des Logiciels ni de la documentation les accompagnant pour quelque fin que ce soit, à l'exception d'une (1) copie des Logiciels à des fins de sauvegarde uniquement pour soutenir votre utilisation des Logiciels sur le Produit unique qui est accompagné par les Logiciels. Vous ne pouvez ni modifier ni tenter de modifier les Logiciels.
- E. Vous ne pouvez céder les Logiciels et en octroyer la licence à une autre partie qu'en rapport avec votre cession du Produit unique qui est accompagné par les Logiciels à cette autre partie. Au moment de cette cession, vous devez céder également toutes les copies, que ce soit sous forme imprimée ou lisible par la machine, de tous les Logiciels ainsi que de la documentation les accompagnant, à la même partie ou détruire les copies non cédées.
- F. Vous ne pouvez retirer aucune marque de droits d'auteur, marque de commerce ou autre ni aucune identification de produit des Logiciels et vous devez reproduire et inclure toutes ces notices ou identifications de produit sur toutes les copies des Logiciels.

Vous ne pouvez assembler en sens inverse, compiler en sens inverse ni retracer les Logiciels ni aucune de leurs copies, de façon électronique ou mécanique, en tout ou en partie.

Vous ne pouvez utiliser, copier, modifier, altérer ni céder les Logiciels ni aucune de leurs copies, en tout ou en partie, à l'exception de ce qui est expressément stipulé dans ce contrat.

Si vous cédez la possession de toute copie ou de tout Logiciel à une autre partie, à l'exception de ce qui est autorisé au paragraphe E ci-dessus, votre licence est automatiquement résiliée.

Termes, clauses et conditions

Cette licence n'est effective que pour la durée de possession ou de crédit-bail du Produit, à moins d'une résiliation antérieure. Vous pouvez résilier cette licence à tout moment en détruisant, à vos frais, les Logiciels et la documentation les accompagnant avec toutes leurs copies, sous quelque forme que ce soit. Cette licence sera également résiliée, avec application immédiate, si les conditions de résiliation définies ailleurs dans ce contrat se sont réalisées ou si vous ne respectez pas les termes, clauses et conditions qui y sont contenues. Au moment de la résiliation, vous acceptez de détruire, à vos frais, les Logiciels et la documentation les accompagnant avec toutes leurs copies, sous quelque forme que ce soit.

Vous reconnaissez avoir lu ce contrat, en avoir compris toute la substance et avoir accepté de respecter ses termes, clauses et conditions. Vous reconnaissez en outre qu'ils sont la description complète et exclusive du contrat conclu entre nous, contrat qui remplace et annule toute proposition ou contrat précédent, écrit ou oral, et toute autre communication entre nous, relativement à l'objet du présent contrat.

Specifications

This page provides the specifications for the basic model CF-74ECBAXBM / CF-74FCBAZBM / CF-74FCBCZBM / CF-74ECBCXBM / CF-74ECBADBM. The model number is different according to the unit configuration.

- To check the model number:
Check the bottom of the computer or the box the computer came in at the time of purchase.
- To check CPU speed, memory size and the hard disk drive (HDD) size:
Run the Setup Utility (→  *Reference Manual* "Setup Utility") and select [Information] menu.
[CPU Speed]: CPU speed, [System Memory]: Memory size, [Hard Disk]: Hard disk drive size

■ Main Specifications

Model No.		CF-74ECBAXBM / CF-74FCBAZBM / CF-74FCBCZBM / CF-74ECBCXBM / CF-74ECBADBM
CPU		Intel® Core™ Duo Processor T2500 (2.0 GHz, 2 MB ^{*1} L2 cache, 667 MHz FSB)
Chipset		Intel® 945GM
Memory ^{*1}		512 MB (2560 MB Max.)
Video Memory ^{*1*2}		UMA (128 MB Max.)
Hard Disk Drive ^{*3}		80 GB
CD/DVD Drive		DVD-ROM & CD-R/RW Drive
Data Transfer Rate ^{*4}	Reading ^{*5}	DVD-ROM: 8X (Max.), CD-ROM: 24X (Max.)
	Writing ^{*6}	CD-R: 4X/10X/7-16X/10-24X CD-RW: 4X High-Speed CD-RW: 4X/10X Ultra-Speed CD-RW: 10X/10-24X
Supported Discs/Format ^{*3}	Reading	DVD-ROM (4.7 GB, 8.5 GB, 9.4 GB, 17 GB), DVD-Video, DVD-R (1.4 GB, 3.95 GB, 4.7 GB), DVD-R DL (8.5 GB), DVD-RW ^{*7} (1.4 GB, 2.8 GB, 4.7 GB, 9.4 GB), DVD-RAM ^{*8} (1.4 GB, 2.8 GB, 2.6 GB, 5.2 GB, 4.7 GB, 9.4 GB), +R (4.7 GB), +R DL (8.5 GB), +RW (4.7 GB), CD-Audio, CD-ROM, CD-R, Photo CD, Video CD, CD-RW, CD TEXT, CD-EXTRA
	Writing	CD-R, CD-RW, High-Speed CD-RW, Ultra-Speed CD-RW
Display Method		13.3 type (TFT) with Touchscreen
Internal LCD ^{*9}		65,536/16,777,216 colors (800 × 600 dots/1024 × 768 dots)
External Display ^{*10}		65,536/16,777,216 colors (800 × 600 dots/1024 × 768 dots/1280 × 1024 dots/1600 × 1200 dots/2048 × 1536 dots)
Wireless LAN ^{*11}		→ page 29
Bluetooth ^{*12}		Version 2.0+EDR
LAN		IEEE 802.3 10Base-T, IEEE 802.3u 100Base-TX, IEEE 802.3ab 1000Base-T
Modem		Data: 56 kbps (V.92) FAX: 14.4 kbps
Sound		WAVE and MIDI playback, Stereo speaker, Intel® High Definition Audio subsystem support
Security Chip		TPM (TCG V1.2 compliant) ^{*13}
Card Slot	PC Card	Type I or Type II x 1 (3.3 V: 400 mA, 5 V: 400 mA)
	ExpressCard	ExpressCard/34 or ExpressCard/54 x 1
	SD Memory Card ^{*14}	x 1, Data transfer rate = 8 MB per second ^{*15}
	Smart Card ^{*16}	x 1
RAM Module Slot		200-pin, 1.8 V, SO-DIMM, DDR2 SDRAM, PC2-4200 Compliant
Interface		USB port (4-pin, USB 2.0) x 2, Serial Port (Dsub 9-pin male), Modem port (RJ-11), LAN port (RJ-45), External display port (Mini Dsub 15-pin female), Expansion Bus Connector (Dedicated 65-pin female), Microphone Jack (Miniature jack, 3.5 DIA, Stereo), Headphone Jack (Miniature jack, 3.5 DIA, Impedance 32 Ω, Output Power 4 mW × 2)
Keyboard / Pointing Device		87 keys / Touch Pad / Touchscreen (Anti-Reflection, Stylus (included) touch capable)
Power Supply		AC adaptor or Battery pack
AC Adaptor ^{*17}		Input: 100 V to 240 V AC, 50 Hz/60 Hz, Output: 15.6 V DC, 8.0 A

■ Main Specifications

Battery Pack	Li-ion 11.1 V, 7.8 Ah
Operating Time ^{*18*19}	Approx. 6 hours to 9 hours ^{*20} (Approx. 8 hours ^{*21})
Charging Time ^{*18}	Power on Approx. 4.5 hours
Clock Battery	Coin type lithium battery 3.0 V
Power Consumption ^{*22}	Approx. 40 W ^{*23} / Approx. 100 W (Maximum when recharging in the ON state)
Physical Dimensions (W × H × D) (including the carrying handle)	303.5 mm × 43.6 - 60.1 mm × 293.3 mm {12.0" × 1.7 - 2.4" × 11.6"}
Weight (including the carrying handle)	Approx. 2.7 kg {Approx. 6.0 lb.}
Operation Environment	Temperature: 5 °C to 35 °C {41 °F to 95 °F} Humidity: 30% to 80% RH (No condensation)
Storage Environment	Temperature: -20 °C to 60 °C {-4 °F to 140 °F} Humidity: 30% to 90% RH (No condensation)
Operating System	Microsoft® Windows® XP Professional Service Pack 2 with Advanced Security Technologies (NTFS File System)
Utility Programs	DMI Viewer, Microsoft® Windows® Media Player 10, Adobe Reader, PC Information Viewer, SD Utility, Icon Enlarger, Loupe Utility, WinDVD™ 5 (OEM Version), B's Recorder GOLD8 BASIC, B's CLiP 6, Intel® Matrix Storage Manager, Intel® PROSet/Wireless Software ^{*11} , Bluetooth™ Stack for Windows® by TOSHIBA ^{*12} , Wireless Switch Utility, Hotkey Settings, Battery Recalibration, LAN Power-Saving Utility, Infineon TPM Professional Package ^{*24} Setup Utility, Hard Disk Backup Utility ^{*25} , Hard Disk Data Erase Utility ^{*25}

■ Wireless LAN <Only for model with wireless LAN>

Intel PRO / Wireless 3945 ABG (802.11 a + b + g) PCI Ex. 1/4	
Data Transfer Rates ^{*26}	IEEE802.11a: 54/48/36/24/18/12/9/6 Mbps (automatically switched) IEEE802.11b: 11/5.5/2/1 Mbps (automatically switched) IEEE802.11g: 54/48/36/24/18/12/9/6 Mbps (automatically switched)
Standards Supported	IEEE802.11a/IEEE802.11b/IEEE802.11g
Transmission method	OFDM system, DSSS system
Wireless Channels Used	IEEE802.11a: Channels 36/40/44/48/52/56/60/64/149/153/157/161/165 IEEE802.11b/IEEE802.11g: Channels 1 to 11
RF Frequency Band	IEEE802.11a: 5.18-5.32 GHz, 5.745-5.825 GHz IEEE802.11b/IEEE802.11g: 2.412-2.462 GHz

*1 1MB = 1,048,576 bytes

*2 A segment of the main memory is allotted automatically depending on the computer's operating status. The size of the Video Memory cannot be set by the user.

*3 1GB = 1,000,000,000 bytes. Your operating system or some application software will report as fewer GB.

*4 The data transfer rate of DVD per 1X speed is 1,350 KB/s. The data transfer rate of CD per 1X speed is 150 KB/s.

*5 If an unbalanced disc (e.g., the balance has been displaced from the center) is inserted, the speed may become slower if there are large vibrations while the disc is rotating.

*6 Depending on the disc, the writing speed may become slower.

*7 Does not support DVD-RW Ver.1.0.

*8 DVD-RAM: Only non-cartridge type or removable cartridge type can be used.

*9 A 16,777,216 color display is achieved by using the dithering function.

*10 Maximum resolution depends on the specifications of the external display.

*11 Only for model with wireless LAN

*12 Only for model with Bluetooth

*13 For information on TPM, click [start] - [Run] and input "c:\util\drivers\tpm\README.pdf", and refer to the Installation Manual of "Trusted Platform Module (TPM)".

*14 Operation has been tested and confirmed using Panasonic SD Memory Cards with a capacity of up to 2 GB. The transfer rate using the SD Memory Card slot on this computer is 8 MB per second. (This is a theoretical value, and dif-

fers from actual speeds.)

The transfer rate is 8 MB per second even if you use an SD Memory Card that supports high-speed transfer rates.

Operation on other SD equipment is not guaranteed. This computer is not compatible with MultiMediaCards or SDHC Memory Cards. Do not insert these kinds of cards.

*15 Theoretical value and not the actual speed. The transfer rate does not become higher even if you use a card that supports the higher transfer rate.

*16 Only for model with Smart Card slot

*17 The AC adaptor is compatible with power sources up to 240 V AC adaptor. The computer is supplied with a 125 V AC compatible AC cord.

*18 Varies depending on the usage conditions.

*19 Measured with the LAN Power-saving function's Auto-off setting set to 1 minute.

*20 Measured using BatteryMark™ Version 4.0.1 (LCD brightness: Maximum - Minimum)

*21 Measured using MobileMark™ 2002 (LCD brightness: 60 cd/m²)

*22 Approx. 1.0 W when the battery pack is fully charged (or not being charged) and the computer is OFF.
Approx. 2.0 W when the Wake up from LAN has been enabled.

*23 Rated power consumption

*24 You need to install to use the feature.

*25 The Product Recovery DVD-ROM is required.

*26 These are speeds specified in IEEE802.11a+b+g standards. Actual speeds may differ.

LIMITED WARRANTY

For U.S.A.

PANASONIC PERSONAL COMPUTER AND PERIPHERALS LIMITED WARRANTY

Panasonic Computer Solutions Company (referred to as "Panasonic") will repair this product (other than software, which is covered by a separate warranty) with new or rebuilt parts, free of charge in the U.S.A. for three (3) years from the date of original purchase in the event of a defect in materials or workmanship. This warranty includes the AC adaptor but excludes the batteries and all other options and accessories which are covered for a period of one (1) year from the date of purchase.

This warranty is extended solely to the original purchaser. A purchase receipt or other proof of date of original purchase will be required before warranty performance is rendered.

This warranty only covers failures due to defects in materials or workmanship which occur during normal use. It does not cover damage which occurs in shipment or failures which are caused by products not supplied by Panasonic, or failures which result from alteration, accident, misuse, introduction of liquid or other foreign matter into the unit, abuse, neglect, installation, maladjustment of consumer controls, improper maintenance, modification or service by anyone other than a Factory Service Center or authorized Panasonic Service Dealer, or damage that is attributable to acts of God.

THIS PRODUCT IS NOT INTENDED FOR USE AS, OR AS PART OF, NUCLEAR EQUIPMENT/SYSTEMS, AIR TRAFFIC CONTROL EQUIPMENT/SYSTEMS, OR AIRCRAFT COCKPIT EQUIPMENT/SYSTEMS^{*1}. PANASONIC WILL NOT BE RESPONSIBLE FOR ANY LIABILITY RESULTING FROM THE USE OF THIS PRODUCT ARISING OUT OF THE FOREGOING USES.

^{*1} AIRCRAFT COCKPIT EQUIPMENT/SYSTEMS include Class2 Electrical Flight Bag (EFB) Systems and Class1 EFB Systems when used during critical phases of flight (e.g., during take-off and landing) and/or mounted on to the aircraft. Class1 EFB Systems and 2 EFB Systems are defined by FAA: AC (Advisory Circular) 120-76A or JAA: JAA TGL (Temporary Guidance Leaflets) No.36.

Limits and Exclusions:

There are no other express warranties except as listed below.

PANASONIC SHALL NOT BE LIABLE FOR LOSS OF DATA OR OTHER INCIDENTAL OR CONSEQUENTIAL DAMAGES RESULTING FROM THE USE OF THIS PRODUCT, OR ARISING OUT OF ANY BREACH OF THIS WARRANTY. ALL EXPRESS AND IMPLIED WARRANTIES, INCLUDING THE WARRANTIES OF MERCHANTABILITY AND FITNESS FOR A PARTICULAR PURPOSE ARE LIMITED TO THE APPLICABLE WARRANTY PERIOD SET FORTH ABOVE. Some states do not allow the exclusion or limitation of incidental or consequential damages, or limitations on how long an implied warranty lasts, so the above limitations or exclusions may not apply to you.

This limited warranty gives you specific legal rights, and you may also have other rights which vary from state to state. If a problem with your product develops during or after the warranty period, you may contact our representatives at 1-800-LAPTOP5. If the problem is not handled to your satisfaction, then write to the Consumer Affairs Division at the address indicated below.

SOFTWARE LIMITED WARRANTY

Panasonic Computer Solutions Company (referred to as "Panasonic") warrants to you only that the disk(s) or other media on which the Programs are furnished will be free from defects in materials and workmanship under normal use for a period of sixty (60) days from the date of delivery thereof to you, as evidenced by your purchase receipt.

This is the only warranty Panasonic makes to you. Panasonic does not warrant that the functions contained in the Programs will meet your requirements or that the operation of the Programs will be uninterrupted or error free.

Panasonic's entire liability, and your exclusive remedy under this warranty shall be limited to the replacement, in the United States, of any defective disk or other media which is returned to Panasonic's Authorized Service Center, together with a copy of the purchase receipt, within the aforesaid warranty period.

Anything in the foregoing to the contrary notwithstanding, Panasonic shall have no obligation for any defects in the disk(s) or other media on which the Programs are furnished resulting from your storage thereof, or for defects that have been caused by operation of the disk(s) or other media otherwise than on the Product or in environmental conditions other than those specified by Panasonic by alteration, accident, misuse, abuse, neglect, mishandling, misapplication, installation, maladjustment of consumer controls, improper maintenance, modification of damage that is attributable to acts of God. In addition, Panasonic shall have no obligation for any defects in the disk(s) or other media if you have modified, or attempted to modify any Program.

DURATION OF IMPLIED WARRANTIES, IF ANY, IS LIMITED TO SIXTY (60) DAYS.

PANASONIC ASSUMES NO RISK OF AND SHALL NOT IN ANY CASE BE LIABLE FOR ANY DAMAGES, INCLUDING, WITHOUT LIMITATION, ANY SPECIAL, INCIDENTAL, CONSEQUENTIAL, OR PUNITIVE DAMAGES ARISING FROM BREACH OF WARRANTY OR CONTRACT, NEGLIGENCE OR ANY OTHER LEGAL THEORY, INCLUDING, WITHOUT LIMITATION LOSS OF GOODWILL, PROFITS OR REVENUE, LOSS OF USE OF THE PROGRAMS OR PRODUCTS OR ANY ASSOCIATED EQUIPMENT, COST OF CAPITAL, COST OF ANY SUBSTITUTE EQUIPMENT, FACILITIES, SERVICES, DOWNTIME COSTS, OR CLAIMS OF ANY PARTY DEALING WITH YOU FOR SUCH DAMAGES.

Some states do not allow the exclusion or limitation of incidental or consequential damages, or limitations on how long an implied warranty lasts, so the above limitations or exclusions may not apply to you.

This limited warranty gives you specific legal rights, and you may also have other rights which vary from state to state.

This Limited Warranty will be governed by the laws the State of New York, without regard to its conflict-of-laws rules.

To obtain service or technical assistance within the continental U.S.A. and Alaska.

DIAL TOLL FREE: 1-800-LAPTOP5

Correspondence requesting product information should be sent to:
Panasonic Computer Solutions Company
3 Panasonic Way, Panazip 2F-5, Secaucus, NJ 07094

Appendix

PANASONIC COMPUTER AND PERIPHERALS LIMITED WARRANTY

Coverage – Panasonic Canada Inc. (“PCI”) warrants to you, the first end user customer, this computer product (excluding software media), when purchased from PCI or from a PCI authorized reseller, to be free from defects in materials and workmanship under normal use, subject to the terms set forth below, during the period of warranty coverage specified.

Scope of Coverage	Period of Coverage	Type of Failure Coverage
Whole Product (except Batteries), AC adaptor and CD-ROM (if factory installed)	Three (3) Years from Date of Original End User Customer Purchase	Defective Materials or Workmanship
Batteries, CD-ROM (unless factory installed), Port Replicator, Extra Memory Modules and all other Peripherals, Options and Accessories	One (1) Year from Date of Original End User Customer Purchase	Defective Materials or Workmanship

Remedy – In the event of a warranty claim, contact PCI’s representatives within the applicable warranty period, identifying the nature of the defect claimed, at 1-800-668-8386 between 9:00 A.M. and 5:00 P.M., Eastern Time Zone, Mon. – Fri. (excluding holidays) for instructions on how to obtain service. A purchase receipt or other proof of date of original purchase is required before warranty service is performed. Defective parts covered by this Limited Warranty will be repaired or replaced with new or comparable rebuilt parts on an exchange basis. Warranty replacement or repair is subject to the terms of this Limited Warranty for the balance of the original period of warranty coverage.

No Coverage – This Limited Warranty does not cover products purchased outside Canada. Neither does it cover damage to, failure of, or defects in a product or accessory through mishandling, improper installation, abnormal use, misuse, neglect, accident, introduction of liquid or other foreign matter into the product, alteration or servicing by anyone not authorized by PCI, or act of God.

THIS PRODUCT IS NOT INTENDED FOR USE AS, OR AS PART OF, NUCLEAR EQUIPMENT/SYSTEMS, AIR TRAFFIC CONTROL EQUIPMENT/SYSTEMS, OR AIRCRAFT COCKPIT EQUIPMENT/SYSTEMS^{*1}. PANASONIC WILL NOT BE RESPONSIBLE FOR ANY LIABILITY RESULTING FROM THE USE OF THIS PRODUCT ARISING OUT OF THE FOREGOING USES.

^{*1} AIRCRAFT COCKPIT EQUIPMENT/SYSTEMS include Class2 Electrical Flight Bag (EFB) Systems and Class1 EFB Systems when used during critical phases of flight (e.g., during take-off and landing) and/or mounted on to the aircraft. Class1 EFB Systems and 2 EFB Systems are defined by FAA: AC (Advisory Circular) 120-76A or JAA: JAA TGL (Temporary Guidance Leaflets) No.36.

IF YOU SHIP THE PRODUCT FOR WARRANTY SERVICE

Carefully pack the product, preferably in the original carton. Include details of defect claimed and proof of date of original purchase. No liability is assumed for loss or damage to the product while in transit, if you chose your own transportation carrier.

SOFTWARE MEDIA LIMITED WARRANTY

Coverage – Panasonic Canada Inc. (“PCI”) warrants to you, the first end user customer, that the disk(s) or other media on which software program(s) is/are supplied will be free from defects in materials and workmanship under normal use in Canada for a period of sixty (60) days from date of receipt as evidenced by your purchase receipt for your Panasonic Computer product.

THIS IS THE ONLY WARRANTY THAT PCI MAKES RESPECTING THE SOFTWARE MEDIA. PCI does not warrant the software. Please refer to the software licensor’s written warranty (accompanying the copy of the software) for any software warranty claim.

Claim Procedure – In the event of a defect in material or workmanship in the media during the sixty (60) day warranty period, and you return it, transportation costs prepaid, to Panasonic Canada Inc., Computer Products Marketing, at the above address, within the warranty period, together with a copy of your purchase receipt, and an explanation of the suspected defect, PCI will replace in Canada the defective disk(s) or other media.

Remedy – PCI’s entire liability, and your only remedy for any breach of this software media warranty is limited to replacement of the media only. It does not cover any other damages, including, but not limited to, loss of use or profit loss, or special, indirect or consequential damages, or other claims, whether or not of similar character.

No Coverage – This limited warranty does not apply if the disk(s) or other media has been used in other than a Panasonic product, or in environmental conditions other than those specified by PCI or the manufacturer, or if subjected to misuse, neglect, mishandling, modification or attempted modification of the program, or if damaged by accident or act of God. PCI is not responsible for damage to or loss of any program, data or removable storage media.

GENERAL

NO OTHER WARRANTIES – PCI DISCLAIMS ALL OTHER WARRANTIES, EITHER EXPRESS OR IMPLIED, INCLUDING, BUT NOT LIMITED TO, IMPLIED WARRANTIES OF MERCHANTABILITY AND FITNESS FOR A PARTICULAR PURPOSE, WITH RESPECT TO THE SOFTWARE, SOFTWARE MEDIA, COMPUTER PRODUCT, OPTIONS AND ACCESSORIES.

NO LIABILITY FOR CONSEQUENTIAL DAMAGES – IN NO EVENT SHALL PCI BE LIABLE FOR ANY SPECIAL, INDIRECT OR CONSEQUENTIAL DAMAGES ARISING FROM ANY BREACH OF THE LIMITED WARRANTIES SET OUT IN THIS DOCUMENT, OR FROM THE USE OF THE COMPUTER PRODUCT, INCLUDING, WITHOUT LIMITATION, LOSS OF DATA, BUSINESS, PROFIT OR GOODWILL.

IN ANY EVENT, PCI’S MAXIMUM LIABILITY FOR ANY BREACH SHALL NOT EXCEED THE AMOUNT ACTUALLY PAID BY YOU FOR THE COMPUTER PRODUCT.

NO ACTION, REGARDLESS OF ITS BASIS, MAY BE BEGUN AGAINST PCI MORE THAN TWO (2) YEARS AFTER THE CAUSE OF ACTION AROSE.

Statutory Warranties – Some jurisdictions do not allow these limitations or exclusions, so they may not apply to you.



As an ENERGY STAR® Partner, Matsushita Electric Industrial Co., Ltd. has determined that this product meets the ENERGY STAR® guidelines for energy efficiency.

Outline of the International ENERGY STAR® Office Equipment Program

The international ENERGY STAR® Office Equipment Program is an international program that promotes energy saving through the use of computers and other office equipment. The program backs the development and dissemination of products with functions that effectively reduce energy consumption. It is an open system in which business proprietors can participate voluntarily. The targeted products are office equipment such as computers, displays, printers, facsimiles, and copiers. Their standards and logos are uniform among participating nations.

Panasonic Computer Solutions Company
3 Panasonic Way, Panazip 2F-5,
Secaucus, NJ 07094

Panasonic Canada Inc.
5770 Ambler Drive Mississauga,
Ontario L4W 2T3

© 2006 Matsushita Electric Industrial Co., Ltd. All Rights Reserved.
Printed in Japan

HS0106-2096
DFQX5582XA



Free Manuals Download Website

<http://myh66.com>

<http://usermanuals.us>

<http://www.somanuals.com>

<http://www.4manuals.cc>

<http://www.manual-lib.com>

<http://www.404manual.com>

<http://www.luxmanual.com>

<http://aubethermostatmanual.com>

Golf course search by state

<http://golfingnear.com>

Email search by domain

<http://emailbydomain.com>

Auto manuals search

<http://auto.somanuals.com>

TV manuals search

<http://tv.somanuals.com>