



Panasonic.

Personal Computer
OPERATING INSTRUCTIONS

CF-M32 Series

95

Contents

Getting Started

Read Me First	4
Names of Parts	8
First-time Operation	11

Operation

Starting Up/Shutting Down	15
Creating Backup Disks	21
Computing On The Road	24
Using the Battery Pack	30
Security Measures	36
Infrared Data Communications	40
Add-ons/Peripherals	42

Troubleshooting

List of Error Codes	52
Dealing With Problems	53
Reinstalling Software	58

Appendix

LIMITED USE LICENSE AGREEMENT ...	69
Windows 95 Setup Procedure	70
Creating a Hibernation Data Area ..	71
Setup Utility	73
Key Combinations	80
LED Indicators	82
Specifications	83
Index	84

Customer's Record

Model No.*	CF-M32W5M	Dealer's Name	_____
Serial No.	_____	_____	_____
or			
Code No.	_____	Dealer's Address	_____
Date of Purchase	_____	_____	_____

Introduction

Thank you for purchasing the Panasonic computer. Please read the Operating Instructions thoroughly for proper operation of your new computer.

Illustrations in this Manual

- NOTE** : **NOTE** provides a useful fact or helpful information.
- CAUTION** : **CAUTION** indicates a condition that may result in minor or moderate injury.
- WARNING** : **WARNING** indicates a hazard that may result in moderate or serious injury, or even death.
- [Start]-[Shut Down] : This illustration means to click [Start], then to click [Shut Down] (For some applications, you may need to double-click.)
- Enter** : This illustration means to press the [Enter] key.
- Fn** + **F2** : This illustration means to press [Fn], and while holding down on [Fn], to press [F2].

Copyright

This manual is copyrighted by Matsushita Electric Industrial Co., Ltd. with all rights reserved. No part of this manual may be reproduced in any form without the prior written permission of Matsushita Electric Industrial Co., Ltd.

No patent liability is assumed with respect to the use of the information contained herein.

©Matsushita Electric Industrial Co., Ltd. 1998. All Rights Reserved.

Disclaimer

Computer specifications and manuals are subject to change without notice. Matsushita Electric Industrial Co., Ltd. assumes no liability for damage incurred directly or indirectly from errors, omissions or discrepancies between the computer and the manuals.

Trademarks

Microsoft®, MS-DOS® and Windows® are registered trademarks of Microsoft Corporation of the United States and/or other countries.

PS/2™ is a trademark of International Business Machines Corporation.

Pentium® is a registered trademark, and MMX™ is a trademark of Intel Corporation.

Panasonic® is a registered trademark of Matsushita Electric Industrial Co., Ltd.

Federal Communications Commission Radio Frequency Interference Statement

Note: This equipment has been tested and found to comply with the limits for a Class B digital device, pursuant to Part 15 of the FCC Rules. These limits are designed to provide reasonable protection against harmful interference in a residential installation. This equipment generates, uses and can radiate radio frequency energy and, if not installed and used in accordance with the instructions may cause harmful interference to radio communications. However, there is no guarantee that interference will not occur in a particular installation. If this equipment does cause harmful interference to radio or television reception, which can be determined by turning the equipment off and on, the user is encouraged to try to correct the interference by one or more of the following measures:

- Reorient or relocate the receiving antenna.
- Increase the separation between the equipment and receiver.
- Connect the equipment into an outlet on a circuit different from that to which the receiver is connected.
- Consult the Panasonic Service Center or an experienced radio/TV technician for help.

Warning

To assure continued compliance, use only shielded interface cables when connecting to a computer or peripheral. Also, any changes or modifications not expressly approved by the party responsible for compliance could void the user's authority to operate this equipment.

This device complies with Part 15 of the FCC Rules. Operation is subject to the following two conditions:

- (1) This device may not cause harmful interference, and
- (2) This device must accept any interference received, including interference that may cause undesired operation.

Responsible Party: Matsushita Electric Corporation of America
One Panasonic Way
Secaucus, NJ 07094
Tel No: 1-800-LAPTOP-5 (1-800-527-8675)

Lithium Battery!

This computer contains a lithium battery to enable the date, time, and other data to be stored in it.

The battery should only be exchanged by service personnel.

Warning! Risk of explosion from incorrect installation or misapplication!

Read Me First

Precautions

● Usage



Avoid Extreme Heat and Cold

Do not store or use the computer in locations exposed to heat, direct sunlight, or extreme cold.

Avoid moving the computer between locations with large temperature differences.

Operation: 5 °C to 35 °C (41 °F to 95 °F)

Storage: -20 °C to 60 °C (-4 °F to 140 °F)

Avoid Direct Sunlight on the LCD Panel

The display should not be exposed to direct sunlight or ultraviolet light.



Avoid Humidity, Liquids and Dust

Do not store or use the computer in locations exposed to high humidity, liquids (including rain) or dust.



Prevent Shock

Avoid subjecting the computer to severe vibrations or impact. Do not place the computer inside a car trunk.

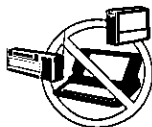

Avoid Radio Frequency Interference

Do not place the computer near a television or radio receiver.

● Handling



Avoid Magnetic Fields

Keep the computer away from magnets.



Avoid Stacking

Do not place heavy objects on top of the computer.



Keep Small Objects Away

Do not insert paper clips or other small objects into the computer.



Do Not Disassemble the Computer

Do not attempt to disassemble your computer.



Avoid Excessive Force to the LCD Panel

Do not apply excessive downward force on the LCD Panel.

● **Peripherals**

Incorrectly using peripheral devices may lead to a decrease in performance, an increase in temperature and/or damage your computer. For more information on peripheral devices, please refer to "Add-ons / Peripherals" (📖 page 42)

● **Cables**

Use of an interface cable longer than 3 m (9.84 feet) is not recommended.

Transporting

- It is a good idea to make backup copies on floppy disks and carry them with you. The external FDD (floppy disk drive; CF-VFDDU01) and Port Replicator (CF-VEBM31) are required to use floppy disks.
- Do not carry your computer when it is ON.
- Remove all cables before transporting your computer.
- We recommend preparing a fully charged battery.
When transporting spare batteries inside a package, briefcase, etc., it is recommended that the batteries be stored in a plastic bag.
- Do not carry the computer while the display is open, or carry it by gripping the display.
- Do not put anything (e.g., a piece of paper) between the display and keyboard.
- Do not drop or hit your computer against solid objects.

When flying

Always carry your computer with you. Never check it with luggage. For use of the computer inside an aircraft, we recommend asking the airlines regarding their policy on this issue.

Read Me First

Maintenance

- **Display area**

Use a soft dry cloth like gauze to lightly wipe the display.

- **All other areas**

Wipe these areas with a soft cloth, after applying water or detergent diluted with water to the soft cloth and firmly wringing it.

CAUTION

- Do not use benzene or thinner, or disinfectant-type alcohol.
- Do not directly use water, liquid detergents or spray-type cleaners. If liquid enters the computer, this may cause the computer to malfunction or become defective.

Saving Data on the Hard Disk

- **Do not expose your computer to shock.**

Please use care when handling your computer, shock may damage your hard disk or make your software applications and data unusable.

- **Do not power down your computer while software applications are running or HDD indicator is on.**

Properly shut Windows* down to avoid problems ([Start]-[Shut Down]).

- **Save all valuable data to floppy disks.**

Backing up data to floppy disks will limit damage should trouble occur to your computer or should you inadvertently change or erase data.

The external FDD (CF-VFDU01) and Port Replicator (CF-VEBM31) are required to use floppy disks.

- **Use the security function for all important data.**

➔ page 36 - Security Measures

* This computer uses Microsoft® Windows® 95 Operating System.

Saving Data on Floppy Disks

The external FDD (CF-VFDDU01) and Port Replicator (CF-VEBM31) are required to use floppy disks.

- **Do not power down your computer or press the floppy disk drive eject button while the FDD indicator is on.**
Doing so may damage the data on the floppy disk and render the disk useless.
- **Use care when handling floppy disks.**
To protect the data on your floppy disks or to prevent a floppy disk from becoming stuck in your computer, avoid the following:
 - Sliding the shutter on the floppy disk manually.
 - Exposing the disk to a magnetic field.
 - Storing the disk in locations prone to high temperatures, low pitched noise, dampness, or dust.
 - Applying more than one label on the disk.
- **Confirm the contents of a floppy disk before formatting it.**
Confirm that no important data is on the disk, because all data on the disk will be erased.
- **Use the write-protect tab.**
This is a must for preserving important data. This prevents your data from being erased or overwritten.



Write Enable



Write Disable

Computer Viruses

- **Users are advised to purchase the latest versions of virus protection software and use them regularly.**
We recommend you run the software:
 - When booting your computer.
 - After receiving data.We recommend that you check data received on floppy disks or from external sources, such as data downloaded from the Internet, e-mail, etc. (For compressed files, please uncompress them before running a check).

Names of Parts

Top Side

Panel Switch

When the LCD panel is closed, this button is depressed, causing the screen to automatically shut down or be suspended (☞ Caution below). When the LCD panel is opened, the screen is turned on or resumes.

Trackball

A built-in pointing device that works like a mouse. As you spin the ball with your fingertip, the cursor moves in accordance with the speed and direction of the ball's motion.

Keyboard

LED Indicators

(☞ page 82)

Open Latch

Open the Display

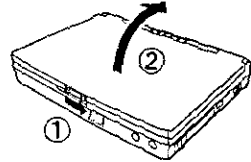

LCD(Display)

Brightness Adjustment :

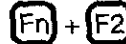

Click Buttons

When pressed while the trackball is in use, the buttons select items or perform other operations (☞ page 17).

CAUTION

To suspend the screen, [Panel Switch] must be set to [Suspend] (☞ page 26) in [Panasonic Power Management]. Do not reopen the LCD panel until the power indicator is blinking green. If the LCD panel is reopened before this happens, it may remain suspended and resuming may not be possible. In such cases, close the LCD panel again and wait a few seconds before reopening it.

Front / Right Side

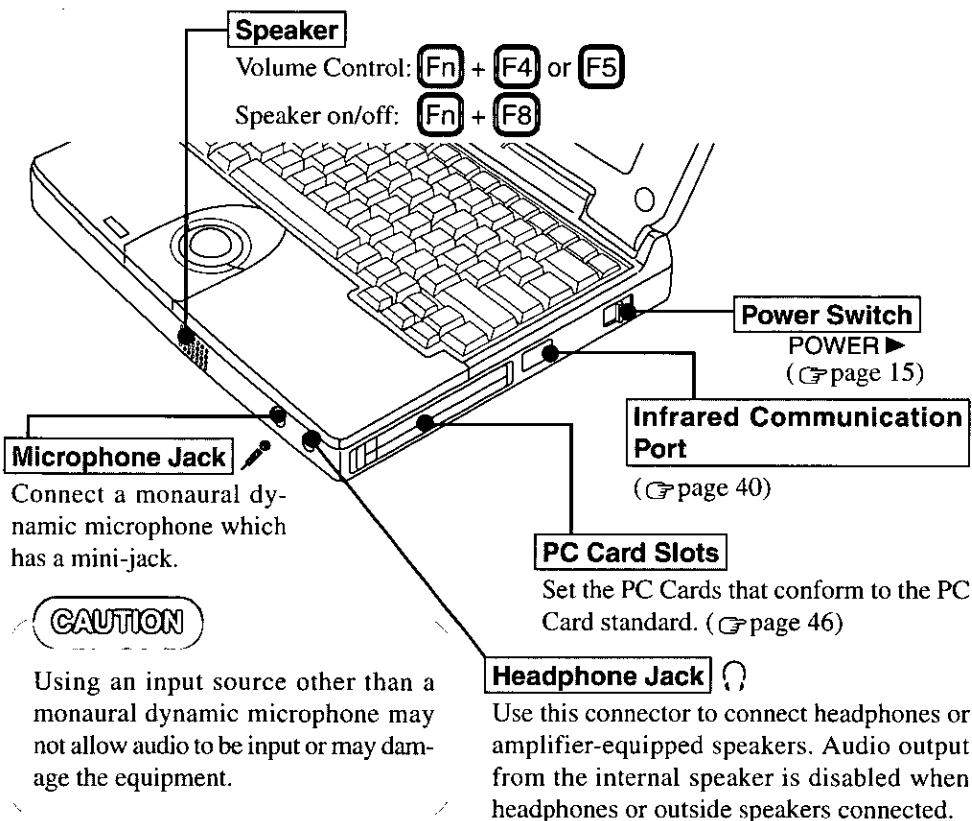

Left Side

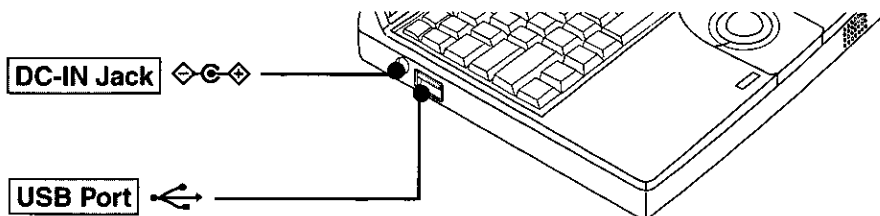

The USB port allows the mouse, modem, printer, and other peripheral devices to be connected while the power is on. To use the USB port, you may need to install a driver for your USB devices and [USB Port] must be set to [Enabled]. (☞ page 78, 79)

Names of Parts

Rear / Bottom Side

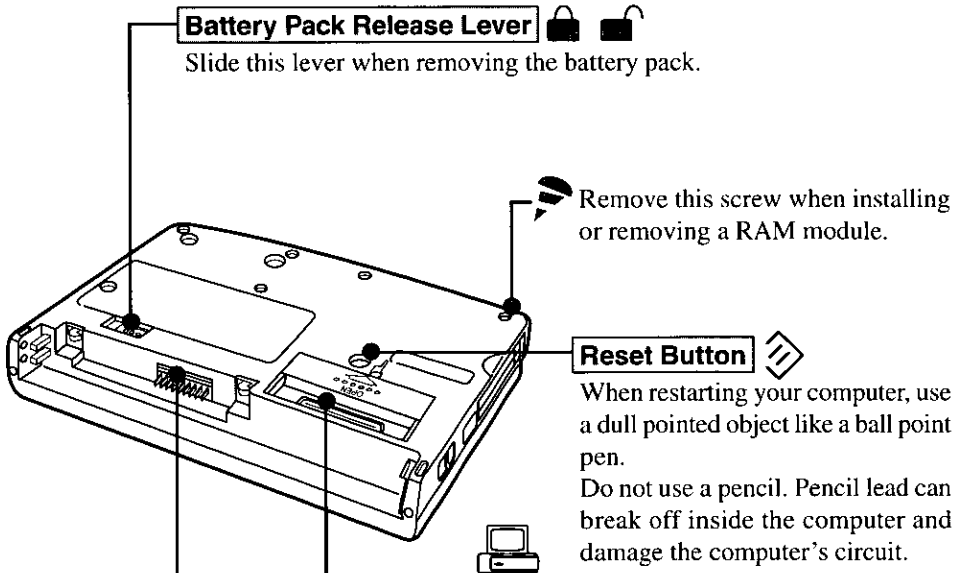

Battery Pack Release Lever

Slide this lever when removing the battery pack.

Remove this screw when installing or removing a RAM module.

Reset Button

When restarting your computer, use a dull pointed object like a ball point pen.

Do not use a pencil. Pencil lead can break off inside the computer and damage the computer's circuit.

Expansion Bus Connector

Install the port replicator.

Battery Pack Connector

Install the battery pack. (☞ page 30)

CAUTION

If a problem occurs but your computer does not lock, we recommend not pressing the reset button. It will cause you to lose data if an application is open.

CAUTION







Do not install a battery pack other than the battery pack (CF-VZSU05) or the optional Extended life Battery Pack (CF-VZSU06).

First-time Operation

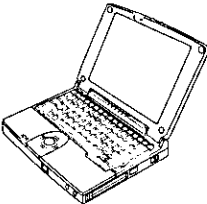
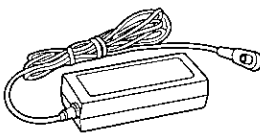
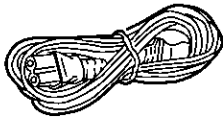
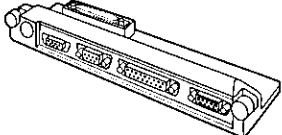
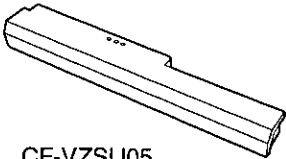
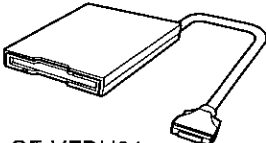
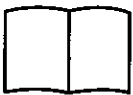
Please read the steps below to help you learn what items are included, and to gain an understanding of some basic computer-related operations.

1 Confirm the inclusion of all parts

Make sure the parts shown in the figure have been supplied. If any of these items are missing or is not working properly, please contact Panasonic Technical Support.

Computer 	AC Adapter 1  CF-AA1527	AC Cord 1 
Port Replicator 1  CF-VEBM31	Battery Pack 1  CF-VZSU05	External FDD 1  CF-VFDU01
Operating Instructions .. 1	Windows 95 System Pack..... 1	
	(Microsoft Corporation)    	
FIRSTAID CD 1		
	Windows 95 book	CD-ROM
	Registration card	Floppy disk label

2 Turn your computer over, install the battery pack
 (☞ page 32)

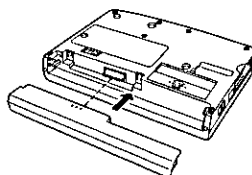

First-time Operation

3 Connect your computer to a power outlet

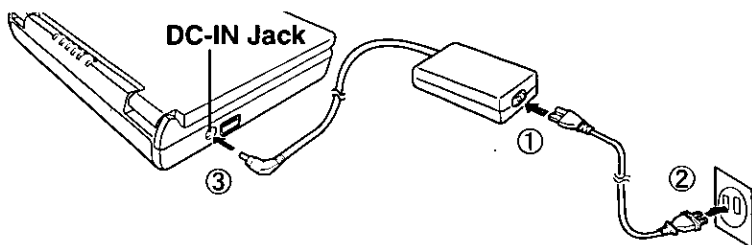

CAUTION

Handling the AC adapter

- Do not twist or pull the AC power cord forcefully. Doing so may damage the connections.
- Use only the specified AC adapter with your computer. Using an AC adapter other than the one supplied or car adapter might damage the battery and/or the computer.
- When the DC plug is not connected to the computer, disconnect the AC cord from your AC wall outlet.
(If the cord is kept connected, a very low level of power equivalent to approx. 0.6 W will be consumed.)
- Problems such as sudden voltage drops or surges may arise during periods of thunder and lightning. Since this could adversely affect your computer, an uninterruptible power source (UPS) is highly recommended unless a battery pack is installed.

4 Read the LIMITED USE LICENSE AGREEMENT (☞ page 69)

To open the display, slide the latch located at the front and lift open the display. Before removing the seal covering the power switch, please read the LIMITED USE LICENSE AGREEMENT. Removal of this seal indicates agreement to the terms specified. After you have agreed to the terms, you may turn your computer on.

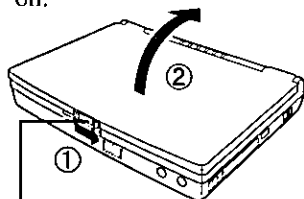

Open Latch

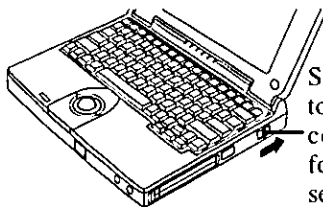

Slide the power switch toward the rear of the computer and hold it for approximately one second until the power indicator (Ⓢ) turns on before releasing it.

(☞ next page "CAUTION")

CAUTION

- If the power switch is held for more than four seconds at the ON position, the power goes OFF. Do not slide the power switch and hold it for more than four seconds.
- After confirming that the power indicator has turned on, do not touch the power switch until Windows setup has started.
- Once the computer is powered off, you must wait at least five seconds before powering it on again.

NOTE

The computer will not power on when the LCD panel is closed.

5 Setup Windows

The [Windows 95 Setup Wizard] will run after the computer is turned on. Simply follow the on-screen instructions.

When the setup procedure is completed, the Windows screen appears.

NOTE

- Please read the supplemental “Windows 95 Setup Procedure” for a more detailed explanation (☞ page 70).
- Moving the cursor (☞) or selecting items can be done through the trackball and click buttons. (☞ page 17).
- If the display is dim or the sound quality is not right, you can adjust the brightness and volume. (☞ page 8, 9, 80).
- The power saving function is factory set to remove power from the display if the computer is not operated or no access is made to a device for two minutes (Battery) or thirty minutes (AC). The display will resume normal operation if the trackball is moved or if a key on the keyboard is depressed.

First-time Operation

Internet Explorer

Internet Explorer 4.01 places a tremendous load on the system in order to execute the wide variety of functions that it provides. As a result, some unexpected faults may occur.

If any of these faults occurs, try using the software with some Internet Explorer 4.01 functions turned off. (See Internet Explorer Help for more details.)

⊙ It takes a long time to reboot or the computer locks up.

Delete the check mark for [Internet Explorer Channel Bar] in [Control Panel] - [Display] - [Web], then press [OK].

⊙ A system module error occurs.

Set (None) for [Wallpaper] in [Control Panel] - [Display] - [Background].

⊙ Performing the above steps does not solve the problem.

Uninstall Internet Explorer 4.01 with the following step.

Select [Microsoft Internet Explorer 4.0] in [Start] - [Settings] - [Control Panel] - [Add/Remove Programs] - [Install/Uninstall] and press [Add/Remove]. Follow the on-screen instructions.

⊙ If a window with the message [Version Conflict] appears during the installation process (network card and application installation), select [Yes].

Proper operation may not be possible if [No] is selected.



Starting Up/Shutting Down

Starting Up

1 Open the display

Slide the latch as shown and lift open the display.

NOTE

The computer will not power on when the LCD Panel is closed.

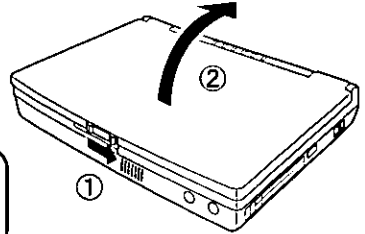

2 Turn your computer on

Slide the power switch toward the rear of the computer and hold it for approximately one second until the power indicator (Ⓢ) turns on before releasing it.

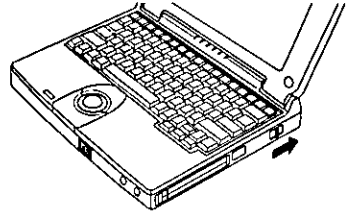

CAUTION

- If the power switch is held for more than four seconds at the ON position, the power goes OFF. Do not slide the power switch and hold it for more than four seconds.
 - After confirming that the power indicator has turned on, do not touch the power switch until Windows has completely started up. Also do not perform any keyboard or trackball operations.
 - Once the computer is powered off, you must wait at least five seconds before powering it on again.
 - When the CPU temperature rises, the computer does not power on to prevent the CPU from overheating. Should this happen, allow the computer to cool down then switch the power on again.
- If the computer still does not turn on, please contact Panasonic Technical Support.

● If  is displayed,

you must first enter your User Password (☞ page 36).

Upon entering your User Password and pressing **Enter**,

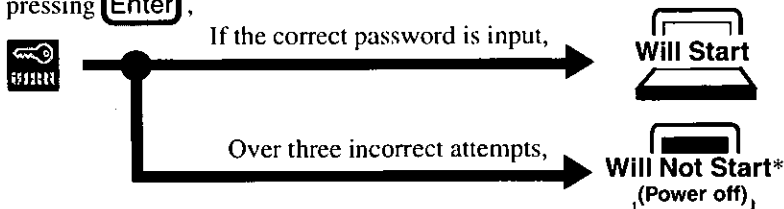

* If you are starting from the suspend mode (☞ page 18), if after three attempts the correct password is not input, or if no password is entered for about a minute, the computer returns to the suspend mode.

NOTE

If the display on the right appears,

The network password has been set. To read and write data to other computers, the correct password must be entered.

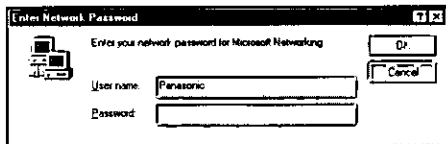

● When an application or file that was previously displayed appears on your screen,

this means the suspend or hibernation mode (☞ page 18) has been set.

3 Select your application

You are able to start working on your computer.

NOTE

The power saving function is factory set to remove power from the display if the computer is not operated or no access is made to a device for two minutes (Battery) or thirty minutes (AC). The display will resume normal operation if the trackball is moved or if a key on the keyboard is depressed.

Using the Trackball and Click Buttons

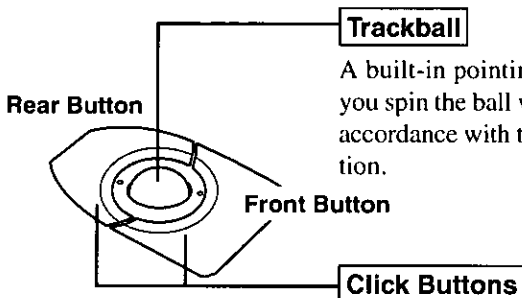

Trackball
A built-in pointing device that works like a mouse. As you spin the ball with your fingertip, the cursor moves in accordance with the speed and direction of the ball's motion.

Click Buttons
When pressed while the trackball is in use, the buttons select items or perform other operations.

● Clicking

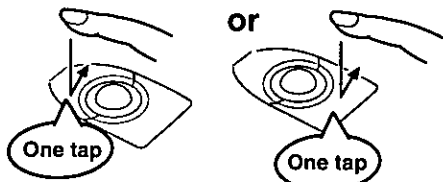

● Double-clicking

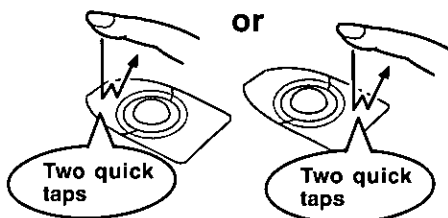

● Dragging

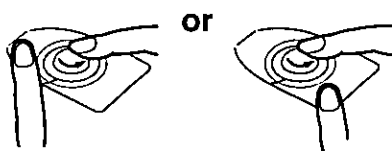

While holding down the button, spinning the trackball with your fingertips

NOTE

- The actions of the two buttons vary according to the software application being used. Normally the rear button is used to perform actions.
- To change the settings for the front and rear buttons of the trackball, and the left and right buttons of the mouse, select [Start] - [Settings] - [Control Panel] - [Mouse].

Starting Up/Shutting Down

Shutting Down (power off your computer)

This procedure is shutting down without using the suspend or hibernation function.

1 To shut down, save all data and select [Shut Down] from the [Start] menu

NOTE

From the keyboard,
You may choose to press down on  then select [Shut Down].

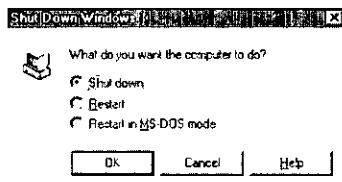

2 Confirm shutdown

Select [Shut down], then click [OK].

Your computer will power off automatically.

● Restarting your computer (without shutting down)

Select [Restart], then click [OK].

NOTE

To quickly resume computer operation after shutting down,
The suspend or hibernation functions is available. (⏏ below)

CAUTION

- Do not power off your computer while the HDD indicator is on.
It may damage data on the hard disk.
- If the computer will not be used for a long period of time, power off and disconnect the AC adapter.
(If the cord is kept connected, a very low level of power equivalent to approx. 0.6 W will be consumed.)

Starting Up Your Computer Quickly

If you want to immediately start up and continue an application after shutting down your computer, you can do so by using the suspend or hibernation function.

● Differences between suspend and hibernation function

Function	Suspend function	Hibernation function
Where data is saved to	Memory	Hard disk
Speed	Fast	Somewhat slow
Requires power supply	Yes (if power is cut, all data is lost)	Power not required to maintain data

Shutting Down

Using the suspend or hibernation function

It is necessary to set the suspend or hibernation function using the Panasonic Power Management Setting.

1 Click [Start] - [Settings] - [Control Panel]

2 Double-click [Panasonic Power Management]

3 Click [Operation Setting], then set [Suspend] or [Hibernation] for [Power Switch]

4 Click [OK]

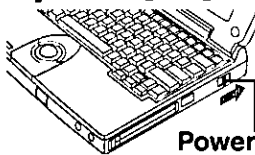

Power Switch

Do not touch the power switch while your computer is entering the suspend or hibernation mode.

Suspend Mode or Hibernation Mode



At the "beep" sound, release your finger.

NOTE

- If the internal speaker is off by pressing (Fn) + (F8), the "beep" sound will not be heard.
- You can also run [Power Management] from the Setup Utility (☞ page 76).

CAUTION

- Save all data before powering off your computer.
- If the power switch is held for more than four seconds at the ON position, the "beep" sound will come out again and the power will go OFF without activation of the suspend or hibernation function. Do not slide the power switch and hold it for more than four seconds.
- When restarting from or shutting down to the suspend or hibernation mode, do not touch the trackball (or move the mouse (serial or PS/2 type) if one is connected). There are cases where these devices will fail to operate; you will have to restart your computer using the keyboard (☞ page 18"NOTE").
- Do not use the suspend or hibernation function during the following periods (you may corrupt your data or file):
 - While the FDD, HDD or CD-ROM is being used.
 - While playing/recording audio files.
 - While communications software is being used.
 - While PC Cards (a SCSI card or ATA card etc.) are being used.

Starting Up/Shutting Down

CAUTION

- Do not use the suspend or hibernation function when using an OS other than Windows 95, the Setup Utility, or when experiencing static electricity or noise.
- If you hold down on the **(Alt)**, **(Ctrl)** or **(Shift)** to enter the suspend or hibernation mode, after resuming operation, you must press the same key. For example, if you hold down on the **(Shift)** key while sliding the power switch, upon resuming, if you do not press the **(Shift)** key again, only capital letters will result from typing.
- If your computer locks up, press the reset button. All data not saved is lost when this button is pressed.
- In the suspend mode, power is consumed. If PC Cards (e.g., a modem card) are inserted, more power is consumed. When all power has been consumed, all data at shut down is lost since it is retained in memory. We therefore recommend plugging in the AC adapter when using the suspend function.
- Set [USB Port] of [Supervisor Setup] to [Disabled] in the Setup Utility when using the suspend or hibernation function.
- A fixed memory data writing area is needed on the hard disk to use the hibernation function. This area is already created on the hard disk at the time of purchase. It will be necessary to create the area again if you change the hard disk partitions (☞ page 71).

Resuming Operation

If  is displayed upon sliding the power switch, your password has been set (☞ page 16).

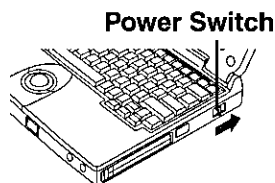

CAUTION

- If the power switch is held for more than four seconds at the ON position, the power goes OFF. Do not slide the power switch and hold it for more than four seconds.
- Do not perform any keyboard operations or move the mouse until Windows has completely started up.
- When operation resumes, serial devices such as a mouse or modem, or your PC Cards may not work. In such cases, you will need to restart your computer or reinitialize the individual devices.

Creating Backup Disks

Create the backup disks (total of 2 disks), listed below, in case you need to reinstall the software (e.g., if the hard disk contents are erased).

1. Windows 95 CD-ROM Setup Boot Disk (1 disk)
2. FIRSTAIID FD (1 disk)

NOTE

Backup disks may be created repeatedly, however, they cannot be recreated after reinstallation.

The following items are necessary:

- Port Replicator
- External floppy disk drive
- Two 2HD floppy disks (Not included)
- Floppy disk label "Microsoft Windows 95 CD-ROM Setup Boot Disk"
- One floppy disk label (Not included)

1 Power off your computer (☞ page 18) and disconnect the AC adapter

Do not shut down using the suspend or hibernation mode.

2 Turn over the computer

3 If an Extended life Battery Pack (CF-VZSU06) is connected to your computer, remove it (☞ page 32)

If you are using the included battery pack, it does not need to be removed.

Creating Backup Disks

4 Attach the Port Replicator (☞ page 42)

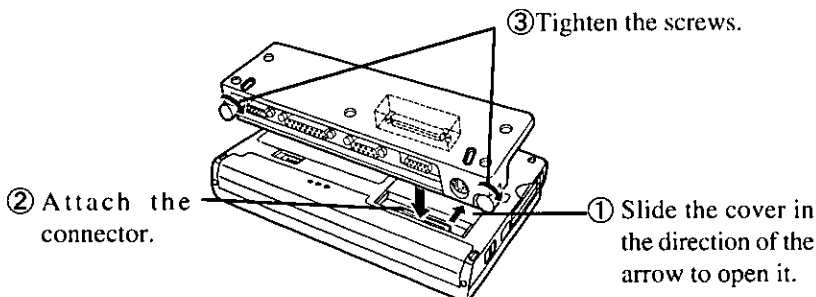

5 Attach the external floppy disk drive (☞ page 45)

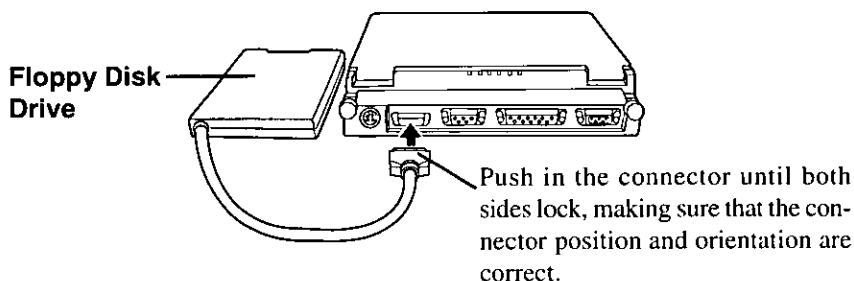

6 Connect the AC adapter, then open the display panel and turn on the power

The Windows screen will be displayed.

7 Click [Start], then move the cursor to [Programs]-[Panasonic], then click [Create FIRTAID FD]

Follow the instructions on the display. After this, place a label on each disk for identification purposes.

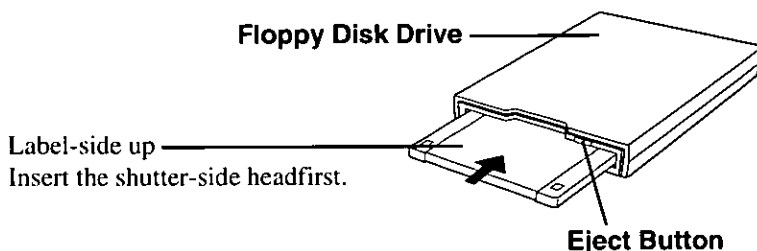

Make a copy of the CD-ROM driver

Copy the necessary drivers, from the floppy disk included with your CD-ROM drive, to the Windows 95 CD-ROM Setup Boot Disk. It will be necessary to edit the CONFIG.SYS file and AUTOEXEC.BAT file on the Windows 95 CD-ROM Setup Boot Disk. When editing the AUTOEXEC.BAT file, be careful not to delete lines containing settings for CAB files to be copied to the C drive on the hard disk.

Some CD-ROM drives require card managers (card and socket service). See the manual included with your CD-ROM drive for further details.

CAUTION

- It may take several minutes to reboot the computer.
- Please store the floppy disks in a safe place. They will enable you to return your computer to close to the condition at the time of purchase should any problems occur.
- Do not remove the floppy disk while the FDD indicator is on, power down your computer or use the suspend or hibernation function.
- When creating floppy disks, do not run any other application program.
- When creating floppy disks and the message [Insufficient files to copy] is displayed, click [OK] and then contact Panasonic Technical Support.

Computing On The Road

One of the main features of notebook-type computers is that you have the power of computing away from your home or office. In the following, information is provided on how to maximize use of the battery pack which is necessary for such computing.

Four Important Points

- POINT 1** Be sure to charge your battery before and after use.
- POINT 2** To get the maximum use of your battery, set the power management mode.
- POINT 3** Check to see that you have your AC adapter with you before leaving your home or office.
Purchasing an extra battery (CF-VZSU05W/06W) is highly recommended.
- POINT 4** Always watch your battery level!

Conserving Power

Things to Remember

- Leave your computer off when it is not in use (☞ page 18)
- Adjust the brightness (dark) with **Fn**+**F2** (☞ page 80)
- Before stepping away from your computer, press **Fn**+**F10** to put your computer in the standby mode (☞ page 81)
The standby mode helps you conserve power by cutting off power to the hard disk drive's motor and display. To resume, you may press any key other than **Fn** or move the trackball.
- In the power management mode, the setting of [Power Saving] is recommended (☞ page 26)

● **Enter the following settings under [Operation Setting] in [Panasonic Power Management]** (☞ page 26)

• **Panel Switch: Suspend**

The system will enter suspend mode and the power indicator will blink green when the LCD panel is closed. The system will resume when the LCD panel is opened.

• **Automatic Hibernation: Enabled**

After the system enters the suspend mode, it will automatically change to hibernation mode when a preset length of time, set in the [Operation Setting], has elapsed.

• **Turn Off PC Card in Suspend Mode: Enabled**

The PC Card power is turned off in suspend mode.

NOTE

- If you plan to use only the battery pack or set the power management, it is necessary to check [Allow Windows to manage power use on this computer] in [Start] - [Settings] - [Control Panel] - [Power]. If the check is removed, the time may not be displayed properly when operation is resumed from the suspend or hibernation mode or the operating time with the battery pack may become short (the power management function of Windows does work).
- When the modem is connected through a PC Card, [Wake up the computer when the phone rings] in [Control Panel]-[Power] is disabled.

Computing On The Road

Setting Panasonic Power Management

(How to set [Power Saving] and [Operation Setting])

1 Click [Start] - [Settings] - [Control Panel], then double-click [Panasonic Power Management]

Or, double-click the icon  in the task bar.

(The icon is not displayed, if [Show settings icon on the task bar] in [Panasonic Power Management] is not set.)

2 Click [Power Saving] tab, then set [Power Saving] under [Battery] or [AC]

NOTE

- When this command is used, if the AC adapter is connected, the [AC] setting will be enabled. If the AC adapter is not connected, the [Battery] setting will be enabled.
- The **[Fn]** and **[F6]** keys can be pressed together to toggle the mode in the following sequence: Standard --> Power Saving --> User Setting.

3 Click [Operation Setting] tab, then set [Suspend] under [Panel Switch]

4 Enter a check next to [Enable Automatic Hibernation], and set the time which must elapse before the change takes place

5 Select [Turn Off PC Card in Suspend Mode]

6 Click [OK]

NOTE

You can also run [Power Management] from the Setup Utility (☞ page 76).

● Panasonic Power Management Settings

The settings are the same for [AC] and for [Battery].

Setting / Function	Standard	Power Saving	User Setting
CPU Speed (%)	100	25	100, 75, 50, 25, 12.5
Standby Timeout (min)	30	2	1, 2, 5, 10, 15, 30, Disable
Suspend Timeout (min)	Disabled	10	1, 2, 5, 10, 15, 30, Disable
LCD Backlight	Bright	Power Saving	Bright, Medium, Dark, Power Saving

- **Standby Timeout** : When the computer is idle or a device is not accessed, the computer enters the standby mode after a preset interval of time.
When [USB Port] of [Supervisor Setup] is set to [Enabled] in Setup Utility, this function is disabled.
- **Suspend Timeout** : When the computer is idle or a device is not accessed, the computer enters the suspend mode after a preset interval of time.
When [USB Port] of [Supervisor Setup] is set to [Enabled] in Setup Utility, this function is disabled.
- **LCD Backlight** : [Bright] [Medium] [Dark] [Power Saving]
Bright <-----> Dark

CAUTION

When installed in a network environment.

After resuming operation from the hibernation mode, the network connection may be severed or the computer will not work properly.

When a device like a high-speed modem or ISDN terminal adapter is connected to the serial port, etc., or if the infrared communications port is being used for data transfer.

There are times when high-speed communication is adversely affected if the power management function is enable. Please disable the power management function.

Key operation and music playback.

When the power management function is running, the keyboard and trackball operations may feel sluggish. Also, music may not play correctly when entering the standby mode during operation.

Computing On The Road

Battery Status

Use the Battery Indicator () to check on the battery status

Battery Indicator	Battery Status
Orange	Charging
Green	Fully-charged
Red	Battery charge is low The battery must be charged. A beeping sound will be heard after the battery indicator has changed to red. Connect the AC adapter immediately. If the AC adapter is not available, quit all programs being run and turn off the power.
Blinking orange	The battery cannot be charged The battery pack cannot be charged since its temperature is outside the 5°C to 35°C (41°F to 95°F) range. Return the battery pack to a temperature at which it can be charged and try charging again.
Blinking red	The battery or AC adapter may not have been connected properly. Make the proper connections. If the problem persists, contact Panasonic Technical Support.

● Getting a detailed reading

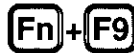

NOTE

- The value displayed may differ somewhat from the actual remaining capacity.
- When the battery pack is not in the computer,  is displayed.
- This computer prevents overcharging of the battery by recharging only when the remaining power is less than approx. 95% of capacity.

● If it seems that the battery status has not been checked properly ("Accurately Displaying Battery Capacity" on page 34)

When the remaining battery charge becomes low

Perform the following:

- Plug in the AC adapter, and fully charge your battery.
- Use a spare battery, if available.
- If you have neither the AC adapter nor an extra battery, save your data and power off your computer.

● If the suspend function is set under [Battery Setting] in [Panasonic Power Management]

Red indicator lights
Beep sounds*



● If the hibernation function is set under [Battery Setting] in [Panasonic Power Management]

Red indicator lights
Beep sounds*



* When disabling the speaker by pressing **(Fn) + (F8)**, the warning beep is also disabled.

NOTE

- The battery operating time is approximately 2.5 hours with the included battery pack, and approximately 8 hours with the Extended life Battery Pack (CF-VZSU06).

Using the Battery Pack

Precautions

● Handling precautions

- Care should be exercised with regard to the following in order to avoid the possibility of liquid leakage, overheating, or bursting.
 - Do not throw the battery pack into a fire or expose it to excessive heat.
 - Do not place the battery pack together with articles such as necklaces or hairpins when carrying or storing it.
 - Do not insert sharp objects into the battery pack, expose it to bumps or shocks, deform it, disassemble it, or modify it.
 - Do not short the positive (+) and negative (-) contacts.
 - The battery pack is rechargeable and is designed for use with the CF-M32 series or the specified charger. Do not use it with a computer or charger other than the one for which it was designed.
 - Do not charge, use or leave the battery pack for extended periods where it will be exposed to direct sunlight, in a hot place (in an automobile on a sunny day, for example), or in a cold place.
 - Do not put the battery into a microwave oven or a pressurized chamber.
 - Should the battery emit an abnormal odor, become hot to the touch, become discolored, change shape, or become in any way different from normal, remove it from the unit and discontinue use.
- When transporting spare batteries inside a package, briefcase, etc., it is recommended that the batteries be stored in a plastic bag.
- Do not expose the battery to water or allow it to become wet. The terminals may corrode.
- Do not touch the terminals on the battery pack. Dirt on the terminals may impair contact and/or make it impossible for the battery to be charged adequately.
- If, due to damage, battery electrolyte comes in contact with skin or clothing, wash it off immediately and thoroughly with water. Consult your physician if you feel any physical discomfort.
- Should the battery leak and some of the fluid get into your eyes, do not rub your eyes. Immediately flush your eyes with clear water and see a doctor for medical treatment as soon as possible.
- Keep batteries out of the reach of children.
- Do not carry the computer by gripping the optional Extended life Battery Pack (CF-VZSU06).

● Notice concerning operating temperature

- The recommended environment, operating temperature of the computer is between 5°C and 35°C (41°F and 95°F). The battery's operating time will decrease if the operating temperature is low.
- The battery pack will become somewhat warm during normal use. This is not a malfunction.

● Notice concerning charging

- Since the battery pack is not charged when the computer is purchased, be certain to charge the battery before using the computer.
Charging commences automatically when the battery pack is inserted into the computer and the AC adapter is connected.
- If the battery pack is not used for an extended period of time, be sure to charge it before use. In such cases, the charging process may not be completed in the normal length of time, but this is not an indication that the battery is malfunctioning.
- Charge the battery pack in the usage temperature range (5°C to 35°C (41°F to 95°F)). It may not be possible to charge the battery pack if the temperature is outside the usage temperature range, or is in the usage temperature range but the battery pack becomes too hot or cold due to usage conditions. (If this happens, the battery indicator will blink orange.) In such cases, take steps such as adjusting the room temperature or refrain from using the computer for a period of time. Charging will start automatically once the battery pack temperature returns to the specified temperature range.
- If the battery pack is attached and detached repeatedly and is charged each time, an overcurrent will result, generating heat. This should not be done as it will cause the battery pack to age.
- The battery pack is not a permanent part. If the battery pack operating time shortens significantly, and if its capabilities are not restored after repeated charging, then the battery pack has reached the end of its service life. Replace it with a new battery pack.
- If the battery indicator blinks red when charging is commenced or when it is underway, it may mean that the internal protection circuit has been activated and charging has been suspended. In such cases, disconnect the AC adapter and battery pack from the computer, then re-install them. If this problem persists, contact Panasonic Technical Support.

Using the Battery Pack

Installing/Removing the Battery Pack

CAUTION

Do not install a battery pack other than the battery pack (CF-VZSU05) or the optional Extended life Battery Pack (CF-VZSU06).

NOTE

The installing, removing and charging procedures for the optional Extended life Battery Pack (CF-VZSU06) are the same as the included battery pack.

1 Power off your computer (page 18)

Do not shut down using the suspend or hibernation mode.

CAUTION

In the suspend mode, do not remove/change the battery pack. Removing the pack in the suspend mode will erase your data and may damage the computer.

2 ● Installing the battery pack

Battery Pack Connector

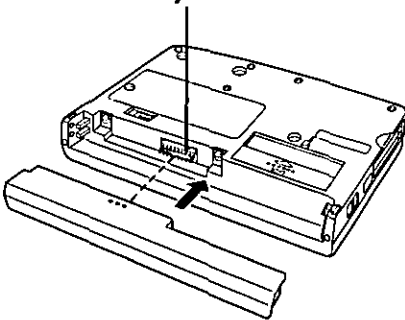

● Removing the battery pack

Battery Pack Release Lever

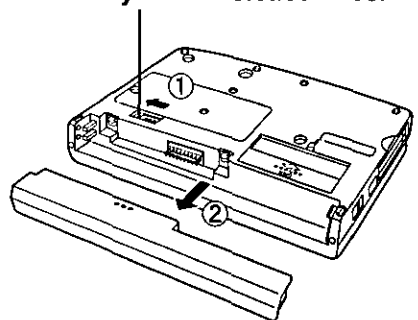

Charging

Since the battery pack is not charged when the computer is purchased, be absolutely sure to charge the battery before using the computer.

Proceed with the charging while the battery pack is installed in the computer.

1 Connect the AC adapter

Charging commences automatically.

While the battery pack is being charged, the battery indicator will light orange.

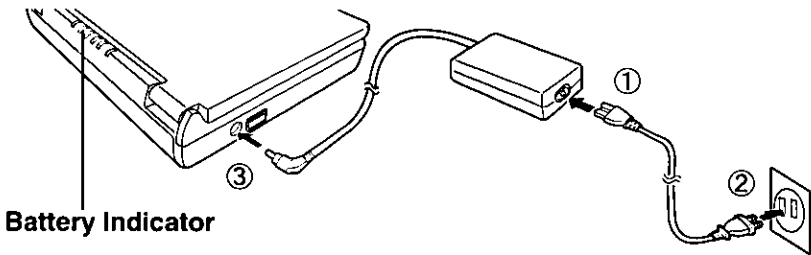

2 Check the charging status

When the battery pack has finished charging, the battery indicator will change to green.
(☞ page 28)

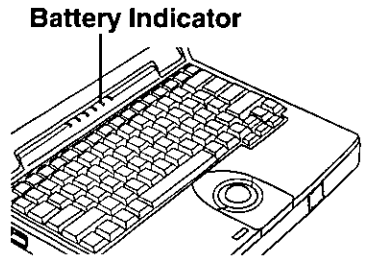

Charging Time

	CF-VZSU05	CF-VZSU06
Power On	Approx. 5 hours	Approx. 13 hours
Power Off	Approx. 2.5 hours	Approx. 6.5 hours

(Varies depending on the usage conditions)

NOTE

Approximately 80 mW of power is consumed even when the computer's power is off. This means that after a full charge the battery pack will discharge in approximately a week. Recharge it prior to use.

Using the Battery Pack

Accurately Displaying Battery Capacity

The battery pack has a function for measuring, storing, and learning about battery capacity. Using this function properly to accurately display remaining battery capacity requires that the battery pack be fully charged (charged to 100%), then fully discharged, and then fully charged again.

Use the procedure presented below to fully charge the battery pack, then discharge it, then charge it again. This procedure should be performed once after you purchase the computer. As you use the battery pack over a long period of time, the remaining capacity display may become inaccurate due to aging of the battery pack and other factors. The procedure described below should be repeated.

1 Attach the battery pack, then connect the AC adapter

CAUTION

In some cases, the remaining capacity display (shown through key actions) may give a reading of 100% capacity even though the battery indicator remains orange. Simply continue charging the battery pack until the indicator turns green.

2 Once the battery indicator turns green, remove the AC adapter (full charge)

3 Use the discharge tool to fully discharge the battery pack. (full discharge)

1. Choose [Start] - [Shut Down] - [Restart in MS-DOS mode], and then click [OK].
2. Type the following after the MS-DOS prompt (C:\WINDOWS>).

```
c:\panaapp\battref /G 
```

3. At the confirmation message, press .

The battery pack will be discharged fully and the computer will power off automatically.

CAUTION

Between when the above operation is performed and when the computer powers off, do not connect the AC adapter or turn the computer off. Doing so will make it impossible to measure the battery capacity.

NOTE

If the discharge tool is used when the battery is fully charged, approximately two hours must elapse before the computer powers off automatically.

4 Connect the AC adapter and charge the battery pack until the battery indicator turns green (full charge)

CAUTION

After fully discharging the battery pack, immediately connect the AC adapter to recharge it.

Security Measures

When you do not want your computer to be used without permission

Set the User Password.

Without the password, access to your computer is impossible.

● When the user password is set

Upon entering your User Password and pressing **Enter**,

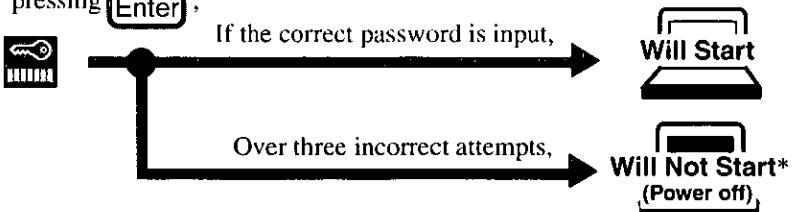

* If you are starting from the suspend mode (☞ page 18), if after three attempts the correct password is not input, or if no password is entered for about a minute, the computer returns to the suspend mode.

Setting the user password (enabling, changing, disabling)

1 Run the Setup Utility (☞ page 73)

2 Using **↓** and **↑**, select [System Setup] then press **Enter**

3 Using **↓** and **↑**, select [User Password], then press **Enter**

4 ● To enable or change your password

1. Enter your password at the [Enter User Password], then press **↓**.

2. Re-enter your password at the [Enter User Password Again].
(This is for confirmation purposes.)

3. Using **↓** and **↑**, select [Set User Password] then press **Enter**.

CAUTION

- Your password will not be displayed on the screen.
- Please limit your password to seven characters. Note that there is no distinction between upper and lower case letters.
- White colored keys can be used. Note that space bar, **[`~]** and function keys cannot be used.
- Do not input your password while holding down on the **[Shift]** or **[Ctrl]**.
- Use only the upper horizontal row of numeric keys to input user passwords.
- Do not forget your password. If a password is forgotten, you will be unable to use your computer.

● To disable your password

Using the **[↓]** and **[↑]** keys, select [Delete User Password] then press **[Enter]**.

5 At the confirmation screen, press **[Enter]**

6 Press **[Esc]** to end the password setting procedure

7 Close the Setup Utility (☞ page 74)

CAUTION

To prevent the changing of your password without permission

When running the Setup Utility program, do not leave your computer even for a short time.

Security Measures

When you do not want your Supervisor Setup changed without permission

Set the Supervisor Password.

After it has been set, no changes can be made to the Supervisor settings unless the password is entered.

- **When the supervisor password is set** in the Setup Utility (☞ page 78),

if  is displayed,

Input the correct supervisor password and press

Enter.

Supervisor Setup
**May be
Opened**

Supervisor Setup
**Can not be
Opened**

When the supervisor password is incorrect or when the user password is entered, (Or, even when the correct supervisor password is entered ☞ page 56.)

(There are cases in which the Supervisor Setup does not appear on the main screen). ☞ page 73

NOTE

You may wish to protect the User Password (☞ page 39).

Setting the supervisor password (enabling, changing, disabling)

1 Run the Setup Utility (☞ page 73)



2 Using **↓** and **↑**, select [Supervisor Setup] then press **Enter**

3 Using **↓** and **↑**, select [Supervisor Password], then press **Enter**



4 ● **To enable or change your supervisor password**

1. Enter your password at the [Enter Supervisor Password], then press **↓**.
2. Re-enter your password at the [Enter Supervisor Password Again].
(This is for confirmation purposes.)
3. Using **↓** and **↑**, select [Set Supervisor Password] then press **Enter**.

CAUTION

- Your password will not be displayed on the screen.
- Please limit your password to seven characters. Note that there is no distinction between upper and lower case letters.
- White colored keys can be used. Note that space bar,  and function keys cannot be used.
- Do not input your password while holding down on the  or .
- Use only the upper horizontal row of numeric keys to input user passwords.
- Do not forget your password. If a password is forgotten, you will be unable to use your computer.

● To disable your password



Using the  and  keys, select [Delete User Password] then press .

5 At the confirmation screen, press .

6 Press  to end the password setting procedure

NOTE

When you do not want the User Password enabled, changed, or disabled without permission,

use  and  to select [User Password protection by user], then set [Enable] with .

7 Close the Setup Utility ( page 74)

Infrared Data Communications

Your computer is equipped with an infrared communication port enabling you to transfer data without a cable.

1 Set the address of your infrared communications port to enable

Run the Setup Utility, then set infrared address for [Infrared Port] and set [Disabled] for [ASK Mode] in [Supervisor Setup]. (☞ page 78)

2 Install the Windows 95 infrared communication driver

CAUTION

To install the infrared communication driver after reinstallation;

You must insert the Windows 95 CD-ROM (included) after Step 8. below. Therefore a PC Card-compatible CD-ROM drive should be connected. (See the manual included with your CD-ROM drive for details on how to connect it.)

1. Click [Start], then [Settings], then [Control Panel]. Double-click the [Add New Hardware].
2. When the [Add New Hardware Wizard] opens, click [Next].
3. The following message will be displayed: "Do you want Windows to search for your new hardware?". Select [No], then click [Next].
4. Under [Hardware types], select [Infrared], then click [Next].
5. When the [Add Infrared Device Wizard] opens, click [Next].
6. Under [Manufacturers], select [Standard infrared devices], then click [Next].
7. In the port selection window, select [Generic Ir Serial Port (COM2)], then click [Next].
8. Select [Use default ports], then click [Next].
The infrared communication driver will be set up.
9. Click [Finish].

3 Prepare for Infrared Data Communications

- Position your computer so that the port is face-to-face with the port of another computer.
- A port-to-port distance of 20 to 50 cm (8 to 20 inches) is recommended.

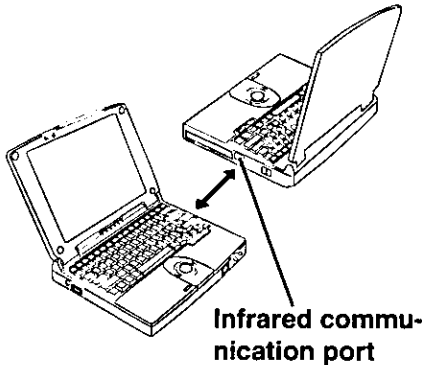

NOTE

Problems with infrared data communications

- An object is located between both ports.
- There are other electronic devices nearby causing interference, such as, a television, VCR, wireless headphone, etc.
- Direct sunlight or white glowing light, such as fluorescent lighting; can cause interference with communications between the ports.

4 Perform infrared communications

Perform communications using a store-bought infrared communications software application or [Direct Cable Connection] in Windows.

NOTE

- To process at a transfer speed of 4 Mbps, separate application software is necessary.
- When you select [Start]-[Settings]-[Control Panel], and then select [Infrared], this will give you the conditions for infrared data communications.
- Please refer to Windows help on how to use Direct Cable Connection.

Add-ons/Peripherals

Devices capable of being used by your computer are listed in the table below.

Device(s)	Where to connect	Reference
Port Replicator	Expansion Bus Connector	☞ below
External Floppy Disk	FDD Port	☞ page 45
PC Cards (Modem, LAN, SCSI, etc.)	PC Card Slots	☞ page 46
Serial Devices (Mouse, Modem, etc.)	Serial Port	☞ page 44
Extra Memory	RAM Module Slot	☞ page 48
External Display	Ext. Display Port	☞ page 50
Printer	Parallel Port	☞ page 51
Keyboard, External Mouse [Type PS/2], etc.	Ext. Keyboard/Mouse Port	☞ page 44
Speaker/Headphone	Headphone Jack	☞ page 9
Microphone	Microphone Jack	☞ page 9

CAUTION

Do not install or remove peripherals while your computer is in the suspend or hibernation mode; abnormal operation may result.

Connecting/Disconnecting the Port Replicator

Connect the port replicator to the computer before connecting devices such as an external floppy disk drive or an external display.

1 Power off your computer (☞ page 18)

Do not shut down using the suspend or hibernation mode.

2 Disconnect the AC adapter

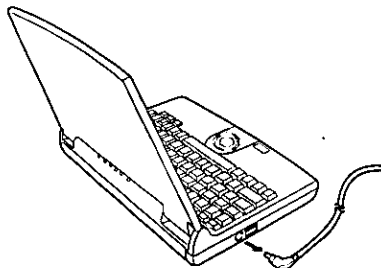

3 Close the display, then turn your computer over

4 If an Extended life Battery Pack (CF-VZSU06) is connected to your computer, remove it (☞ page 32)

If you are using the included battery pack, it does not need to be removed.

5 ● Connecting the Port Replicator

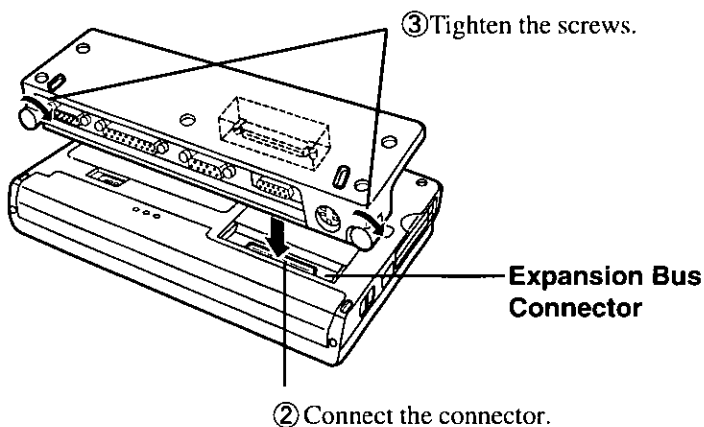
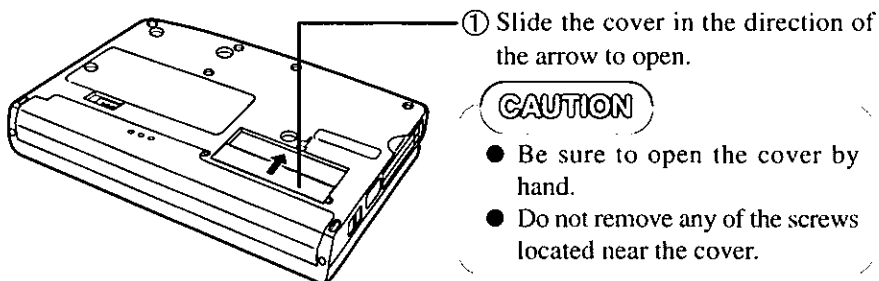

● Disconnecting the Port Replicator

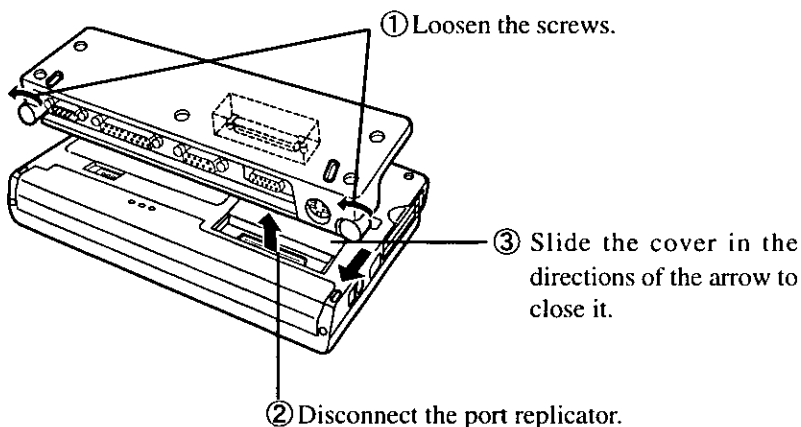

Add-ons/Peripherals

Port Replicator Attachment Diagram

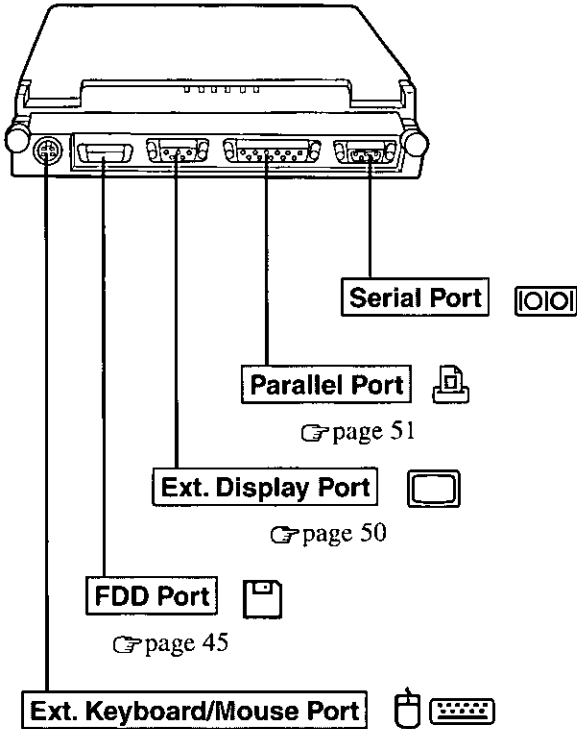

Use this port to connect PS/2 external mouse or external keyboard.

Using the External Floppy Disk Drive (FDD)

To use floppy disks, connect the included external floppy disk drive.

Connecting/Disconnecting the External FDD

1 Connect the Port Replicator (☞ page 42)

2 ● Connecting the External FDD

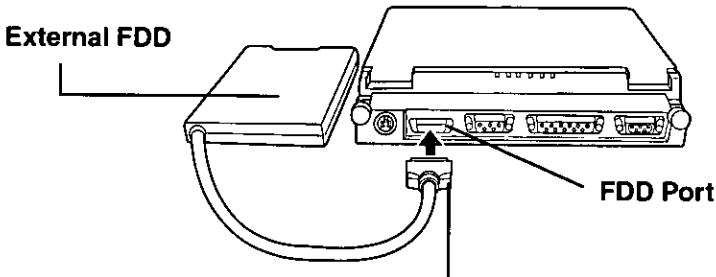

Push in the connector until both sides lock, making sure that the connector position and orientation are correct.

● Disconnecting the External FDD

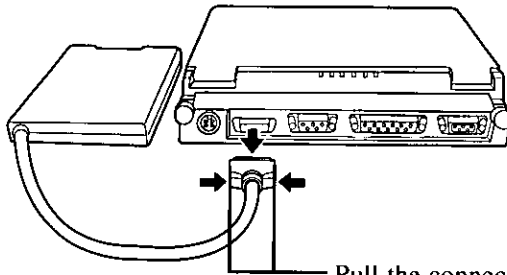

Pull the connector in the direction indicated by the arrow while holding down the unlock levers.

Add-ons/Peripherals

Using PC Cards

Your computer has two PC Card slots. These slots conform to the PC Card Standard; therefore, communications and SCSI devices may be utilized. The slot allows you to use two Type I or Type II cards (or one Type I and one Type II), or one Type III card.

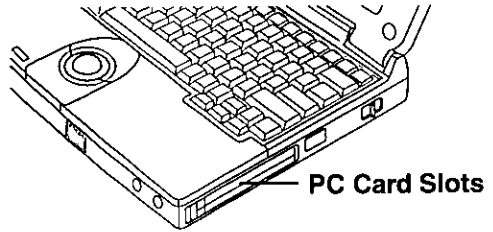

● Type I or II

Two cards can be used simultaneously.



● Type III

One card can be used only in the slot 1.

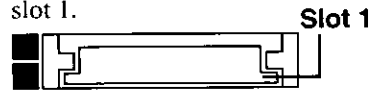

CAUTION

- Please check the PC Cards' specifications. Be sure the total operating current does not exceed the specified limit. Damage may result otherwise. Allowable Current (total for two slots) : 3.3 V: 800 mA, 5 V: 600 mA
- PC Cards which require a 12 V power supply cannot be used.
- There are times when both a Type I card and a Type II card will not work at the same time.
- **Using ZV Port Compatible PC Cards**
 - Some ZV port compatible PC Card driver software may not be compatible with this PC Card controller of this computer. Check with your Panasonic dealer when making your purchase. See the manual included with the PC Card for information on how to operate the ZV port compatible PC Card.
 - Some PC Cards may not work if installed in slot 2.
- **Using CardBus compatible PC cards**
 - When using a CardBus type card, no other types of cards can be used.
 - When removing a CardBus type card (e.g., to insert a non-CardBus type card), be sure to restart the computer after pressing [STOP] (➡ next page "To remove a PC Card").
After that, follow the procedure on installing/removing a PC card.

Installing/Removing the PC Card

CAUTION

To remove a PC Card

Before removing a PC Card, go to [Socket Status] (in [Start] - [Settings] - [Control Panel] - [PC Card (PCMCIA)]), select the PC Card slot and press [Stop]. When removing a CardBus type card, be sure to restart the computer.

1 Power off your computer (page 18)

Do not shut down using the suspend or hibernation mode.

CAUTION

Do not install or remove peripherals while your computer is in the suspend or hibernation mode; abnormal operation may result.

2 Removing the PC Card (or the dummy card)

- ① Pull the button out and then press it.
- ② Pull the PC Card the rest of the way out.

NOTE

Dummy cards are provided at the time of purchase. They provide protection for the PC Card slots against such things as dust.

3 Installing the PC Card (or the dummy card)

- ① Simply slide the PC Card in until it snaps into place.
- ② Pull the button out and return it to the original position.

Please refer to the manual for each card on how to install the card (insertion is typically label-side up).

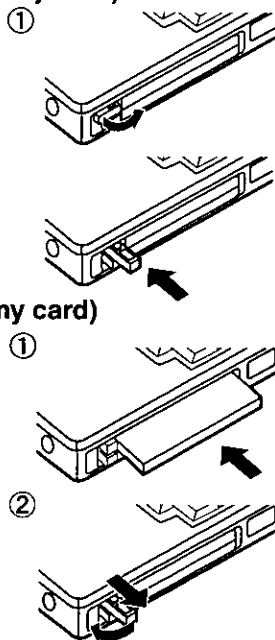

3 Turn your computer on

There are some PC Cards that require a special or updated device driver be installed. Follow the instructions on the screen and read any related manuals on how to install device drivers.

Add-ons/Peripherals

Adding Memory

CAUTION

RAM modules are extremely sensitive to static electricity. There are cases where static electricity generated by the human body has adversely affected such modules. In addition, it is easy to damage the RAM modules or internal components of the computer. Therefore, when installing or removing a RAM module, handle the module with extreme care.

Installing/Removing the RAM Module

1 Power off your computer (☞ page 18)

Do not shut down using the suspend or hibernation mode.

CAUTION

Do not install or remove peripherals while your computer is in the suspend or hibernation mode, abnormal operation may result.

RAM module specifications

144 pins, SO-DIMM, Non-Parity
60 ns, 3.3 V, EDO, Self refresh

2 Disconnect your computer from the power outlet

3 Remove the battery pack (☞ page 32)

4 Turn your computer over and use a screwdriver to remove the screw shown in the illustration

CAUTION

There are many screws on the bottom of the computer. When removing the screw to add memory, be sure to remember the proper position (☞)

Do not remove a screw other than the one shown in the illustration.

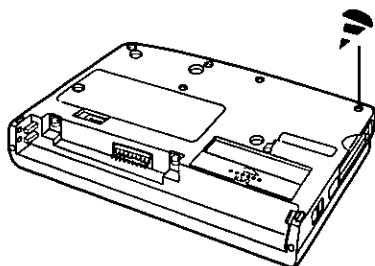

5 Open the display and remove the memory cover

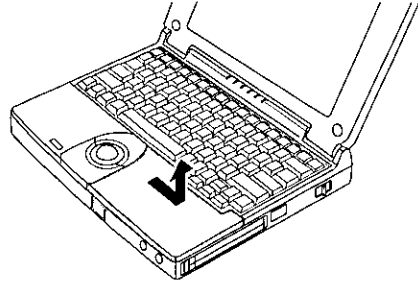
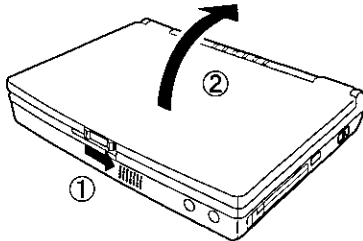

CAUTION

Do not touch the terminals or internal components, insert objects other than the module, or allow foreign particles to enter. Doing so may cause damage, fire or electric shock.

6 ● Installing the RAM module

- ① Slide the module in at an angle.
- ② Snap the module into place by pushing it down.

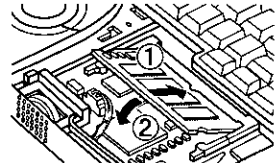

● Removing the RAM module

- ① Open the left and right hooks.
- ② Gently remove the RAM module from the slot.

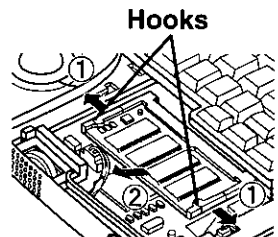

7 Put the cover back into place, then close the display

8 Turn your computer over and use a screwdriver to fasten the screw

Add-ons/Peripherals

Using an External Display

1 Power off your computer (☞ page 18)

Do not shut down using the suspend or hibernation mode.

2 Connect the external display to your computer

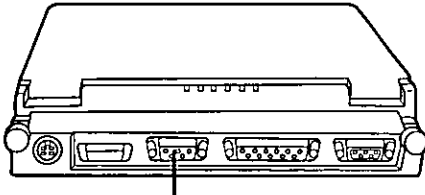

Ext. Display Port

NOTE

For more detailed information, please refer to the operation manual of the external display.

3 Turn on the display, then turn on your computer with the LCD panel opened

1 Run the Setup Utility (☞ page 73).

2 Using **↓** and **↑**, select [System Setup], then press **Enter**

3 Using **↓** and **↑**, select [Video Setup], then press **Enter**

4 Using **↓** and **↑**, select [Display], select the display with **←** then press **Esc**

5 Close the Setup Utility (☞ page 74).

4 Select your external display

Set your external display for [Monitor] in [Start] - [Settings] - [Control Panel] - [Display] - [Settings] - [Advanced Properties].

When a monitor that does not conform to the Plug & Play standards is connected, select [Change] and make the monitor settings.

NOTE

By pressing **(Fn) + (F3)**, you can choose to select either an external display or the LCD, or simultaneous.

Using a Printer

1 Power off your computer (☞ page 18)

Do not shut down using the suspend or hibernation mode.

2 Connect the printer to your computer

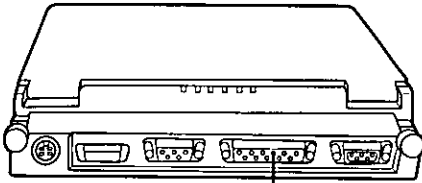

Parallel Port

3 Turn on the printer, then turn on your computer with the LCD panel opened

4 Setting your printer

Go to [My Computer] - [Printers]. Find your printer's icon, click on it, and click [File] - [Set As Default]. If no icon is available, select [Add Printer] and install the driver program.

NOTE

You may need to install a driver for your printer. Simply follow the on-screen instructions and refer to the operation manual for the printer on how to install the driver.

List of Error Codes

If a problem occurs with your hardware, [POST Start up Error(s)] is displayed along with the error code(s), follow the on-screen instructions.

Setup: Setup Utility (☞ page 73) is started. Run [Load Default Settings (Non-PnP)]. Rerun the Setup Utility to input the appropriate operating environment settings.

Exit: Ignore the error message(s), and restart the computer.

Code	Description
062	Boot failure--default configuration used
101	System Board Failure
102	System Board Failure
106	System Board Failure
151	System Board Failure
161	Bad CMOS Battery
162	Configuration Change Has Occurred
162	Configuration Error
163	Date and Time Incorrect
164	Memory Size Error
201	Memory Size Error
1780	Hard Disk Error

Dealing With Problems

When a problem occurs, please refer to this page. If a problem appears to be related to a software application, read the software related manual. If you still cannot troubleshoot the problem, please contact Panasonic Technical Support.

● Starting Up

<p>The computer doesn't work</p>	<ul style="list-style-type: none"> ● Check that connections are secure between the computer and the AC adapter, and between the AC power cord and AC wall outlet. ● The power will not turn on if the LCD panel is closed (i.e., if the panel switch is depressed). Turn on the power after opening the LCD panel. ● Confirm that a fully charged battery pack is installed properly. ● Press the reset button on the computer's bottom side to reboot the computer. ● Remove the AC adapter and battery pack, then reattach them and start the computer again. ● Have the hard disk contents been corrupted? In the Setup Utility, select [Supervisor Setup] and then change the [Boot up Drive] in setting [FDD -> HDD]. Insert the Windows 95 Boot Disk in the floppy disk drive and restart the computer. Check the hard disk contents.
<p>Information on the display screen isn't visible.</p>	<ul style="list-style-type: none"> ● The display may have automatically turned off due to the power-saving function. Move the power switch to restore the screen. ● Has an [External display] been selected by the Video Setup in the Setup Utility and connected to an external monitor? ● If your computer is connected to an external display and the internal LCD has been set to off, and the computer is placed in the hibernation or suspend mode, the internal LCD will remain in the off mode if the external display is not connected when the computer is restarted. In this case, reconnect the external display and reboot the computer.
<p> is Displayed</p>	<p>Please input your password. If you have forgotten it, contact Panasonic Technical Support.</p>
<p>The date and time are incorrect.</p>	<ul style="list-style-type: none"> ● You can set the date and time, through [Date/Time] in [Start] - [Settings] - [Control Panel] or the Date and Time Setup in the Setup Utility. ● If you continue to experience problems, the internal battery maintaining the clock may need to be replaced. Please contact Panasonic Technical Support.

Dealing With Problems

● During Operation

<p>The computer suddenly stops operating.</p>	<ul style="list-style-type: none"> ● When operating the computer with a battery pack, the power may become depleted. You must connect the AC adapter. ● The system may have locked up due to a problem in the application software you are using. Stop using the application software and reboot the computer by pressing the reset button.
<p>The battery indicator is red, or a 0% reading is displayed by pressing Fn+F9.</p>	<ul style="list-style-type: none"> ● Battery is low. Connect the AC adapter to charge the battery. ● The AC adapter may not have been connected properly. Make the proper connection. ● There is a possibility that the battery capacity measuring function is not functioning properly. Follow the steps listed under "Accurately Displaying Battery Capacity" (☞ page 34).
<p>The battery indicator blinks red.</p>	<ul style="list-style-type: none"> ● The battery may not have been connected properly. Make the proper connection. ● If the problem persists, contact Panasonic Technical Support.
<p>The battery indicator blinks orange.</p>	<ul style="list-style-type: none"> ● The battery pack temperature may be outside the 5°C to 35°C (41°F to 95°F) range. Return the battery pack to a temperature at which it can be charged.
<p>The beeper sounded.</p>	<ul style="list-style-type: none"> ● The battery is nearly discharged. Connect the AC adapter to charge or install a fully charged battery pack.
<p>The battery indicator not lit during charging.</p>	<ul style="list-style-type: none"> ● The battery or AC adapter may not been connected properly. Make the proper connections. ● If the problem persists, contact Panasonic Technical Support.
<p>A 100% reading is displayed by pressing Fn+F9, but the orange indicator lights for an extended period of time</p>	<ul style="list-style-type: none"> ● Simply continue charging the battery pack until the indicator turns green. ● There is a possibility that the battery capacity measuring function is not functioning properly. Follow the steps listed under "Accurately Displaying Battery Capacity" (☞ page 34).
<p>Operations are slow.</p>	<ul style="list-style-type: none"> ● There may not be enough memory. Add a RAM module (☞ page 48).

● Display



<p>No display after powering on;</p>	<ul style="list-style-type: none"> ● The brightness can be adjusted with (Fn)+(F2). ● At the time of purchase, the display setting is preset for an external display. If you connect an external display, the screen is displayed on the external display. ● When there is no display on an external display, <ul style="list-style-type: none"> • Check your cable connection to the external display. • Confirm your display is powered on. ● If your computer is connected to an external display and the internal LCD has been set to off, and the computer is placed in the hibernation or suspend mode, the internal LCD will remain in the off mode if the external display is not connected when the computer is restarted. In this case, reconnect the external display and reboot the computer.
<p>The display screen is cleared.</p>	<p>The standby or suspend/hibernation mode may have been established by the power-saving function. When press any key or slid the power switch in either of these scenarios, the display screen returns.</p>
<p>An afterimage appears.</p>	<p>If an image is displayed for a prolonged period of time, an afterimage may appear. This is not a malfunction. The afterimage will disappear when a different screen is displayed.</p>
<p>Green, red or blue dots remain on the display.</p>	<p>As a characteristic of color display's, these dots are known to appear, but it does not indicate any malfunction.</p>

● Disk Operations

<p>The computer won't access the hard disk drive.</p>	<ul style="list-style-type: none"> ● If the cause is unknown, contact Panasonic Technical Support.
<p>The computer won't access the floppy disk drive.</p>	<ul style="list-style-type: none"> ● Ensure that you have connected the external floppy disk drive securely. ● Ensure that you have inserted the floppy disk securely into the drive. ● Did you attempt to write to or read from a non-formatted disk? Floppy disks must be formatted before they can be used. ● Ensure that the write-protect tab is in the write-enable position.
<p>The computer won't format the floppy disk.</p>	<ul style="list-style-type: none"> ● Ensure that the write-protect tab is in the write-enable position. ● Select [3 1/2 Floppy(A:)] in [My Computer], then click [File] - [Format]. After confirming the disk volume and format type, start formatting.

Dealing With Problems

● Setup Utility

 is displayed	Enter the User Password. If you have forgotten it, contact Panasonic Technical Support.
[Supervisor Setup] is not displayed in the menu	At the start of the computer when  is displayed, you have to enter the Supervisor Password. When both the User Password and Supervisor Password have been set, if you enter the User Password, [Supervisor Setup] will not be displayed. If [Supervisor Setup] is not displayed even after entering the Supervisor Password, you have to delete the User Password. Run the Setup Utility again, and input the Supervisor Password.
[User Password] cannot be selected	[User Password protection by user] in [Supervisor Setup] may be enabled.

● Connecting Peripherals

Your peripheral does not work (An error occurs while installing the driver)	You need to use drivers conforming to OS*. Some earlier drivers will no longer work. For more information, please ask the manufacturer of the driver in question. * Windows® 95 Version 4.00.950C (OSR-2.5)
Unable to print	<ul style="list-style-type: none"> ● Check the computer-printer connection. ● Make sure the printer is on. ● Make sure the printer is in the on-line state. ● Make sure paper is in the printer tray and there is no paper jam. ● Has the Setup Utility been used to set [Parallel Port] to [378], [278] or [3BC]?
The cursor does not move from mouse operations	<ul style="list-style-type: none"> ● Check the connection. ● Confirm that the device driver for the mouse works. Please refer to the reference manual of the device. ● Try setting the [Track Ball] to disable in the Setup Utility. ● Has the Setup Utility been used to set [Serial Port] to [2F8] or [3F8]? ● Check your mouse connection, then reboot the computer from the keyboard. From the keyboard, you may choose to press down on  then select [Shut Down].

<p>The cursor does not move from trackball operations</p>	<ul style="list-style-type: none"> ● Confirm that the device driver for the mouse works. Please refer to the reference manual of the device. ● Try setting the [Track Ball] to enable in the Setup Utility. ● Has the Setup Utility been used to set [Serial Port] to [2F8] or [3F8]?
<p>The device connected to the serial port does not work</p>	<ul style="list-style-type: none"> ● Check the connection. ● Confirm that the device driver for the serial port works. Please refer to the reference manual for the device. ● Confirm that two mouse devices are not connected, one through the ext. keyboard/mouse port and the other through the serial port. ● Try setting the [Track Ball] to disable in the Setup Utility.
<p>A PC Card does not work</p>	<ul style="list-style-type: none"> ● Make sure the card is properly inserted. ● Confirm that the card conforms to the PC Card Standard. ● A driver for Windows 95 may need to be installed. ● Note that after a driver is installed, the computer must be rebooted. ● Check that the proper port settings have been made. ● Read the PC Card's manual. Or, you may need to call the source of the PC Card. ● When using a CardBus type card, no other types of cards can be used. ● Some ZV Cards may not work if installed in slot 2.
<p>You do not know the available RAM module</p>	<p>☞ page 46</p>
<p>The RAM module has not been recognized</p>	<p>Make sure the RAM module has been properly inserted.</p>
<p>The address map for IRQ, I/O port address, etc. is unclear</p>	<p>Click [Start] - [Settings] - [Control Panel]. Double-click [System]. Check the address map by going to [View Resources] in [Device Manager] - [Computer] - [Properties].</p>
<p>A USB device does not work</p>	<ul style="list-style-type: none"> ● Has the Setup Utility been used to set [USB Port] to [Enabled]? ● Make sure a driver is installed. ● Contact the manufacturer of the product.

Reinstalling Software

Software programs can be reinstalled in cases where, for example, the hard disk fails, information is lost, etc. However, Create FIRTAID FD program cannot be reinstalled.

Reinstalling Preparations

1 Prepare the following:

- 2 Backup disks created in advance (☞ page 21)
- Windows 95 CD-ROM (included)
- FIRTAID CD (included)
- Port Replicator (included)
- External floppy disk drive (included)
- PC Card-compatible CD-ROM drive

Prepare the CD-ROM drive used in "Make a copy of the CD-ROM driver" (☞ page 23) of the backup disk creation procedure.

2 If data on your hard disk is compressed, the data should be uncompressed.

3 Power off your computer (☞ page 18) and disconnect the AC adapter

Do not shut down using the suspend or hibernation mode.

4 Attach the external floppy disk drive (☞ page 45)

Remove all other peripheral devices.

5 Connect your computer to a power outlet.

Reinstallation Procedure

If the hard disk partitions have been changed since the computer was purchased

- **To leave the current partition settings**

Proceed to Procedure **1** on next page.

- **To restore the partition settings to factory default**

- (1) Insert the FIRSTAID FD, which you made earlier, into the floppy disk drive.
Then turn the computer on.
- (2) Select [2. Return hard disk partitions and hibernation data area to factory default.]
- (3) In response to the confirmation message, press **Y**.
- (4) When the message [Hibernation data area created.] is displayed, confirm that the FIRSTAID FD is in the floppy disk drive then press any key.
The computer will reboot. Then continue with step **2.** of Procedure **1** on next page.

- **To change the partition settings**

- (1) Insert the FIRSTAID FD, which you made earlier, into the floppy disk drive.
Then turn the computer on.
- (2) Use the FDISK command to delete all partitions.
- (3) Use the HBUTIL command to create the hibernation data area (☞ page 71).
- (4) Use the FDISK command to create MS-DOS partitions.
- (5) Press **Alt** + **Ctrl** + **Del** to reboot the computer.
- (6) Format each of the MS-DOS partitions.
Next, proceed to Procedure **2** on next page.

CAUTION

Make sure to reinstall the Windows 95 operating system on the C: drive.

Reinstalling Software

1 Format the C drive

1. Insert the FIRSAID FD which you made earlier in the floppy disk drive, then turn the computer on.

The following screen will be displayed.

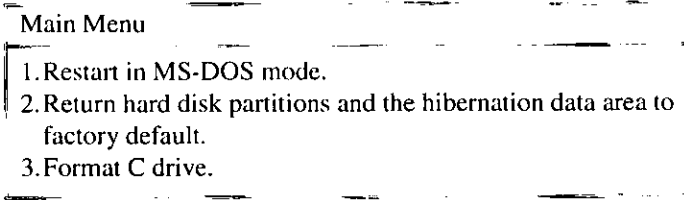

Enter a choice:

2. Select [3. Format C drive.]
3. At the confirmation message, press **Y**.

After the formatting process is completed, press any key. The computer will power off automatically.

2 Install Windows 95

1. Attach the CD-ROM drive. Turn on the CD-ROM drive.
2. Insert the Windows 95 CD-ROM Setup Boot Disk which you made earlier in the floppy disk drive, then turn the computer on.
3. When the message [Press F1 for Setup] is displayed, press **F1** to run the Setup Utility.
4. Select [Load Default Settings (Non-PnP)], then press **Enter**. At the confirmation message, press **Enter**.
5. Save the settings then close the Setup Utility.
The computer will reboot.
6. When the message [Press any key to continue...] is displayed, press any key.
7. When the message [Perform reinstallation?] is displayed, press **Y**.
8. When the computer prompts you to insert FIRSAID CD, please set the specified CD in the CD-ROM drive and press any key.
9. When the computer prompts you to insert Windows 95 CD-ROM, please set the specified in the CD-ROM drive and press any key.
10. When the message [To continue, press ENTER....] is displayed, press **Enter**.
After Microsoft ScanDisk completes, the computer will automatically return to the Windows 95 setup.

Simply follow the on-screen instructions.

To restore the settings which were set at the time of purchase, set the options as shown below.

Option	Settings
Choose Directory	C:\WINDOWS
Setup Options	Typical
Select Components	Windows Messaging (select all)
	Microsoft FAX
	Accessories (select all)
	Disk Tools (select all)
	Multimedia (select all)
	Accessibility Options
	For communications, do not change the default settings.

- When [Choose Directory] window is displayed, select [C:\WINDOWS] then click [Next].

NOTE

If the previous operating system or data are still on the hard disk, a directory other than [C:\WINDOWS] may be displayed. In this case, restore the hard disk partitions to the way they were when the computer was purchased and then perform Procedure 1 on page 60 once again.

- When [Setup Options] window is displayed, select [Typical] and click [Next].
- When [Certificate of Authenticity] window is displayed, enter the number printed on the front of the included Windows 95 book, then click [Next].
- When [User Information] window is displayed, enter your name and your company's name then click [Next].
- When [Analyzing Your Computer] window is displayed, click the check box to the left of [Sound, MIDI, or Video Capture Card] to check it then click [Next].
- When [Windows Components] window is displayed, click the circle to the left of [Show me the list of components so I can choose] to check it then click [Next].
- When [Select Components] window is displayed, select the required applications.

Reinstalling Software

- 18.** After completing this selection, click [Next].
- 19.** When [Startup Disk] window is displayed, check the circle to the left of [Yes] to create a startup disk, or check the circle to the left of [No] then click [Next] to skip this step.
- 20.** When [Start Copying Files] window is displayed, click [Next]. Follow the screen messages to continue with the installation process.
- 21.** When [Finishing Setup] window is displayed, remove the floppy disk and CD-ROM and click [Finish].
- 22.** When [Date/Time Properties] window is displayed, insert the correct time, data and time zone and click [Close].
- 23.** If you have installed Windows Messaging, the [Inbox Setup Wizard] will run then next time you start Windows. When this happens, select [Cancel] and proceed. (Set up the Inbox later.)
- 24.** When [Add Printer Wizard] window is displayed, click [Cancel].
- 25.** When [Setup has finished configuring your system.] is displayed, click [OK]. The computer will reboot.

3 Reset the system

<Install the files>

1. Click [Start], then click [Run]. Type "c:\panaapp\install.exe" under [Open], then click [OK].
2. When [Starting "Panasonic Reinstall Program".] is displayed, click [OK].
3. When ["Panasonic Reinstall Program" is finished.] is displayed, click [OK]. The computer will power off automatically.
4. Remove the CD-ROM drive.
5. Turn the computer on.

NOTE

Various devices are recognized during the Windows 95 startup process. Follow the steps below to install the drivers while paying close attention to the messages that appear on the screen.

<Copy the windows 95 files>

1. When the computer prompts you to insert Windows 95 CD-ROM, click [OK].
2. Type "c:\cabs" under [Copy files from], then click [OK].

<Install the YAMAHA sound card driver>

1. When [Unknown Device] is displayed, under [Update Device Driver Wizard] window, click [Next].
2. When [Windows was unable to locate a driver for this device] is displayed, click [Other Locations].
3. Type "c:\util\drivers\sound" under [Location], then click [OK].
4. Check whether [YAMAHA OPL3-SAx Sound System] has been found, then click [Finish].
5. Click [OK] when the insert disk message is displayed.
6. Type "c:\util\drivers\sound" under [Copy files from], then click [OK].

Reinstalling Software

<Install the hard disk controller(IDE)>

1. When [Intel 82371 AB/EB PCI Bus Master IDE Controller] is displayed, under [Update Device Driver Wizard] window, click [Next].
2. Check whether [Intel 82371 AB/EB PCI Bus Master IDE Controller] has been found, then click [Finish].

<USB detection>

1. When [PCI Universal Serial Bus] is displayed, under [Update Device Driver Wizard] window, click [Next].
2. When [Windows was unable to locate a driver for this device] is displayed, click [Finished].
(The USB function settings are performed later.  page 67)

<Install the video driver>

1. When [Standard PCI Graphics Adapter (VGA)] is displayed, under [Update Device Driver Wizard] window, click [Next].
2. Check whether [Standard PCI Graphics Adapter (VGA)] has been found, then click [Other Locations].
3. Type "c:\util\drivers\video" under [Location], then click [OK].
4. Check whether [NeoMagic MagicGraph 128XD] has been found, then click [Finish].
5. Click [OK] when the insert disk message is displayed.
6. Type "c:\util\drivers\video" under [Copy files from], then click [OK].

<Change the system settings>

1. After changing system settings, [Do you want to restart your computer now?] is displayed. Click [No].
 - The message [Do you want to restart your computer now?] will appear several times before the computer is restarted. In each case, click [No].

<Restart>

1. When Windows 95 reopens, click [Start]-[Shut Down], then select [Restart the computer?] and click [Yes].
 - Do not launch any programs or leave the computer unattended for a long period of time before restarting it.

4 Setting power management

1. Click [Start], then [Run].
2. Type "c:\panaapp\powerman\setup.exe" under [Open], then click [OK].
3. Follow the on-screen instructions to continue installation.
4. The display will ask you to restart Windows, then click [Yes] and [Finish].
5. Click [Start]-[Settings]-[Control Panel], then double-click [Power].
6. Click [Advanced], click the check box to the left of [Wake up the computer when the phone rings] to uncheck it then click [OK].
7. Click [OPL3-SAx power management] and set [Intermediate level of power save] for [Level of power consumption].
8. Click [OK].

5 Setting display

1. Double-click [Display] in [Control Panel].
2. Click [Settings] under [Display Properties], then click on [Advanced Properties].
3. Click [Monitor] under [Advanced Display Properties] then click [Change].
4. Under [Model], select [SuperVGA 1024x768], then click [OK].
5. Confirm that there is a check mark for [Automatically detect Plug & Play monitor] in [Options] for the [Monitor].
6. Click [Performance], then select [Apply the changes without restarting].
7. Click [Adapter], select [Adapter default] under [Refresh rate], click [Close].
8. At the confirmation message, click [OK] and click [Yes].
9. Enter the following settings in [Settings] window under [Display Properties].

Parameter	Setting
Color palette	High Color (16 bit)
Desktop area	800 by 600 pixels
Show settings icon on task bar	Enabled (enter a check mark)

10. After entering the settings, click [OK].
11. At the confirmation message, click [OK] and click [Yes].

Reinstalling Software

6 Setting PC Card

1. Double-click [PC Card (PCMCIA)] in [Control Panel].
2. The [Welcome to the PC Card (PCMCIA) Wizard] window will be displayed. Select [No], then click [Next].
3. Select [No], then click [Next] and [Finish].
4. The following message will be displayed: [Would you like to shut down your computer now?]. Click [Yes].
The computer will power off automatically.

7 Attach the CD-ROM drive

A CD-ROM drive is required in order to perform the installation procedure described below. After connecting the CD-ROM drive, turn on the computer and wait for it to be recognized by Windows 95.

See the manual included with the CD-ROM drive for information on how to attach it.

8 Change the system properties

1. Double-click [System] in [Control Panel].
2. Click [Device Manager] under [System Properties].
3. Click the mark to the left of [CDROM], then select CD-ROM drive and click [Properties].
4. Click [Settings]. Set [Start drive letter] and [End drive letter] to [L:] in [Reserved drive letters], then click [OK].
5. Click the mark to the left of [Disk drivers], then select [GENERIC IDE DISK TYPE<7] and click [Properties].
6. Click [Settings], then add the check mark for [DMA] in [Option]. Click [OK].
7. Click [OK] in [System Properties].
8. The display will ask you to restart Windows, click [Yes].
The computer will reboot.

9 Setting USB function

1. Set Windows 95 CD-ROM in the CD-ROM drive.
2. Click [Start], then click [Run]. Type "L:\other\updates\usb\usbsupp.exe", then click [OK].
At the confirmation message, click [Yes].
3. Read the [END-USER LICENSE AGREEMENT] and click [Yes].
 - Installation will be aborted if [NO] is pressed.
4. After Microsoft ScanDisk completes, installation will start. At the confirmation message, click [OK].
The computer will reboot.
5. Click [Start], then click [Run]. Type "L:\other\updates\usb\usbupd2.exe", then click [OK].
6. Click [Start], then click [Run]. Type "c:\util\usb\usbcopy.bat", then click [OK].
7. When [Finished-usbcopy] is displayed in the title bar of the DOS window, click the [X]-mark in the upper right corner of the DOS window to close it.
8. Double-click [System] in [Control Panel].
9. Click [Device Manager], then select [PCI Universal Serial Bus] for [Other device]. Click [Remove] and [OK].
10. Click [Close] in [System Properties].
11. Click [Start], then click [Shut Down]. Select [Restart the computer?], then click [Yes].

CAUTION

When using a USB device, set [Enabled] for [USB Port] in [Supervisor Setup]. [Disabled] is the default setting. (☞ page 78, 79)

Reinstalling Software

10 Install the applications

<Install the DirectX5>

1. Set Windows 95 CD-ROM in the CD-ROM drive.
2. Click [Start], then click [Run].
3. Type "L:\other\updates\dx5\setupdx5.exe" under [Open], then click [OK].
4. When installation is finished, click [Start]-[Shut Down]. Select [Restart the computer], then click [Yes].

<Install the Internet Explorer 4.01>

Reinstalling Windows causes an older version of Internet Explorer to be installed. To return the computer to the state it was in when you purchased it, follow the steps below to install the newer version of Internet Explorer.

1. Set Windows 95 CD-ROM in the CD-ROM drive.
2. Click [Start], then click [Run].
3. Type "L:\win95\ie4setup.exe" under [Open], then click [OK].
4. Follow the on-screen instructions.
 - [Installation Option] will be displayed, select [Full Installation].

LIMITED USE LICENSE AGREEMENT

THE SOFTWARE PROGRAM(S) ("PROGRAMS") FURNISHED WITH THIS PANASONIC® PRODUCT ("PRODUCT") ARE LICENSED ONLY TO THE END-USER ("YOU"), AND MAY BE USED BY YOU ONLY IN ACCORDANCE WITH THE LICENSE TERMS DESCRIBED BELOW. YOUR USE OF THE PROGRAMS SHALL BE CONCLUSIVELY DEEMED TO CONSTITUTE YOUR ACCEPTANCE OF THE TERMS OF THIS LICENSE.

Matsushita Electric Industrial Co., Ltd. ("MEI") has developed or otherwise obtained the Programs and hereby licenses their use to you. You assume sole responsibility for the selection of the Product (including the associated Programs) to achieve your intended results, and for the installation, use and results obtained therefrom.

LICENSE

- A. MEI hereby grants you a personal, non-transferable and non-exclusive right and license to use the Programs in accordance with the terms and conditions stated in this Agreement. You acknowledge that you are receiving only a LIMITED LICENSE TO USE the Programs and related documentation and that you shall obtain no title, ownership nor any other rights in or to the Programs and related documentation nor in or to the algorithms, concepts, designs and ideas represented by or incorporated in the Programs and related documentation, all of which title, ownership and rights shall remain with MEI or its suppliers.
- B. You may use the Programs only on the single Product which was accompanied by the Programs.
- C. You and your employees and agents are required to protect the confidentiality of the Programs. You may not distribute or otherwise make the Programs or related documentation available to any third party, by time-sharing or otherwise, without the prior written consent of MEI.
- D. You may not copy or reproduce, or permit to be copied or reproduced, the Programs or related documentation for any purpose, except that you may make one (1) copy of the Programs for backup purposes only in support of your use of the Programs on the single Product which was accompanied by the Programs. You shall not modify, or attempt to modify, the Programs.
- E. You may transfer the Programs and license them to another party only in connection with your transfer of the single Product which was accompanied by the Programs to such other party. At the time of such a transfer, you must also transfer all copies, whether in printed or machine readable form, of every Program, and the related documentation, to the same party or destroy any such copies not so transferred.
- F. You may not remove any copyright, trademark or other notice or product identification from the Programs and you must reproduce and include any such notice or product identification on any copy of any Program.

YOU MAY NOT REVERSE ASSEMBLE, REVERSE COMPILE, OR MECHANICALLY OR ELECTRONICALLY TRACE THE PROGRAMS, OR ANY COPY THEREOF, IN WHOLE OR IN PART.

YOU MAY NOT USE, COPY, MODIFY, ALTER, OR TRANSFER THE PROGRAMS OR ANY COPY THEREOF, IN WHOLE OR IN PART, EXCEPT AS EXPRESSLY PROVIDED IN THE LICENSE.

IF YOU TRANSFER POSSESSION OF ANY COPY OF ANY PROGRAM TO ANOTHER PARTY, EXCEPT AS PERMITTED IN PARAGRAPH E ABOVE, YOUR LICENSE IS AUTOMATICALLY TERMINATED.

TERM

This license is effective only for so long as you own or lease the Product, unless earlier terminated. You may terminate this license at any time by destroying, at your expense, the Programs and related documentation together with all copies thereof in any form. This license will also terminate effective immediately upon occurrence of the conditions therefor set forth elsewhere in this Agreement, or if you fail to comply with any term or condition contained herein. Upon any such termination, you agree to destroy, at your expense, the Programs and related documentation together with all copies thereof in any form.

YOU ACKNOWLEDGE THAT YOU HAVE READ THIS AGREEMENT, UNDERSTAND IT AND AGREE TO BE BOUND BY ITS TERMS AND CONDITIONS. YOU FURTHER AGREE THAT IT IS THE COMPLETE AND EXCLUSIVE STATEMENT OF THE AGREEMENT BETWEEN US, WHICH SUPERSEDES ANY PROPOSAL OR PRIOR AGREEMENT, ORAL OR WRITTEN, AND ANY OTHER COMMUNICATIONS BETWEEN US, RELATING TO THE SUBJECT MATTER OF THIS AGREEMENT.

Windows 95 Setup Procedure

This procedure explains step **5** on page 13 in more detail.

1 Enter your name and your company's name, then click [Next]

The License Agreement will be displayed.

2 After reading the agreement, select [I accept the agreement] or [I don't accept the agreement] then click [Next]

If the former is selected, the [Certificate of Authenticity] will appear. If the latter is selected, the Windows setup will be aborted.

3 Input the Product Number written on the "Certificate of Authenticity" located in the Windows 95 book that comes with this computer then click [Next]

4 Click [Finish]

5 Input the correct time, date and time zone and click [Close]

You can also complete these settings at a later time.

6 If you wish to complete the printer settings, click [Next]

Simply follow the on-screen instructions.

If not, click [Cancel]

You can also complete these settings at a later time.

7 Click [Next] to install Internet Explorer. Simply follow the on-screen instructions.

Creating a Hibernation Data Area

(When you have changed the hard disk partitions)

A data area for storing memory data on the hard disk must be created in order to use the hibernation function.

Required disk space: Main memory capacity + 2 MB

At the time of purchase, this area is created approximately 98 MB in size. It must be created again if you have changed the hard disk partitions.

The HBUTIL command on the FIRSTAID FD is used to create the hibernation data area. The procedure for using the HBUTIL command is explained below.

How to use HBUTIL.EXE

CAUTION

- Run HBUTIL.EXE from the FIRSTAID FD. It will not run properly if you run it from the Windows 95 MS-DOS prompt.
- Restart the computer immediately after actions such as creating or deleting a data area.

HBUTIL command has the options listed below.

Enter a single space between the command and the options.

Option	Description
P [size]	With this option, the hibernation data area is created as a Partition. Specify the main memory capacity in megabytes for [size]. If [size] is omitted, the partition will be created based on the current installed memory size. If [size] is set to zero, the hibernation Partition can be deleted. (Example) HBUTIL P 96 A partition will be created for executing hibernation when the main memory consists of 96 MB or less (when on-board memory and 64 MB RAM module are installed).
I	With this option, information regarding the hibernation data area is displayed.
/?	With this option, information regarding this HBUTIL command is displayed.

Creating a Hibernation Data Area

● Error Messages

Message on Screen	Causes and Steps to Take
Partition management information still not written to disk.	There is no partition management information. The partition management information must be initialized with the FDISK command. First run the FDISK/MBR command, then run the FDISK command again to delete the existing primary MS-DOS partition. Restart the computer, then run the HBUTIL command again.
Empty partition with sufficient space not found.	An empty area with sufficient space is needed to create a hibernation data area as a Partition. Take steps such as deleting currently filled areas to free up space.

Setup Utility

Running the Setup Utility

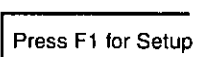
To run the Setup Utility, you need to restart your computer. → Upon seeing this message  → press **F1**

NOTE

- The Setup Utility will not be run if **F1** is not pressed soon after the computer restarts. In this case, you need to restart your computer again.

- If  is displayed, enter your password.

If both the [User Password] and [Supervisor Password] have been set, after entering the User Password, [Supervisor Setup] and [Load Default Setting...] will not be displayed on the main screen.

To display the [Supervisor Setup] and [Load Default Setting...], enter the Supervisor Password.

<Main Screen>

Setup Utility	
•System Summary	→ page 74
•System Setup	→ page 75
•Power Management	→ page 76
•Supervisor Setup	→ page 78
Save Settings	
Restore Settings	Return to the state existing at the time of Setup Utility startup, or to the settings saved with [Save Settings].
Load Default Settings(PnP)	
Load Default Settings(Non-PnP)	
Exit Setup	

Set default settings.

- (PnP) Plug & Play is set.
- (Non-PnP) Plug & Play is not set.
- When the Supervisor Password has been set, input of the password is necessary.

Setup Utility

NOTE

Key Operations

- | | |
|--|---|
| F1 :To display the corresponding "help" file. | ↓ ↑ :To move among the items. |
| Enter :To make a selection. | ← → :To move among the values of each item. |
| Esc :To display previous screen (To exit the program at the main screen). | F9 :To return to the setting before a change. |
| | F10 :To set the default values. |

Closing the Program

Exit
Settings were changed. Do you want to save them?
Yes, save and exit the Setup Utility. No, exit the Setup Utility without saving. No, return to the Setup Utility.

NOTE

If the User Password has been set, the password must be entered before Windows can start.

(The display may be different if no changes to the settings are made.)

System Summary

This can be used to check the current memory capacity and the BIOS version.

System Summary	
System Memory	640 KB
Extended Memory	31 MB
BIOS Version	V***L**

(The version number is displayed in place of the asterisks (*).)

System Setup

System Setup	
Keyboard NumLock State	[Off]
Track Ball	[Enabled]
•Data and Time	
•Video Setup	
•User Password	

page 36

Set the date and time.

Enable/Disable ten key input.

Enable/Disable trackball operation.

Video Setup	
Display	[External Display]
Expanded Text Display	[Disable]
Expanded Graphics Display	[Disable]

Select the default status of the display. Select [Internal LCD], [Simultaneous] or [External Display].

Select [Enable] to display text mode screens with a resolution of 640 x 480 expanded so that they fill the LCD screen.

Select [Enable] to display graphics mode screens with a resolution of 640 x 480 expanded so that they fill the LCD screen.

Setup Utility

Power Management

Power Management	
•Power Saving (Battery)	_____
•Power Saving (AC)	_____
•Resume Timer	_____
Operation Setting	
Power Switch	[Suspend]
Panel Switch	[LCD Off]
PC Card Power	[ON]
Automatic Hibernation	[Never]
Battery Setting	
when remaining capacity is low	[Suspend]

If it is enabled, the system will resume from suspend mode at a specified time.

This setting specifies whether the computer will enter suspend or hibernation mode when the remaining battery capacity is low.

Power Switch

Select the power switch function while the computer is turned on. Select [Suspend], [Hibernation] or [Power Off].

Panel Switch

Set the action to take place when the panel is closed. Select [LCD Off] or [Suspend].

PC Card Power

Set the power supply for the PC Card during Suspend mode. Select [ON] or [OFF].

Automatic Hibernation

Set the amount of time that must elapse from when the computer enters suspend status until it automatically switches to hibernation status. Select [Never], [5 min], [10 min], [30 min], [60 min] or [120 min].

Power Saving (Battery)	
Power Management Mode	[Power Saving]
CPU Speed	25 %
Standby Timeout	2 min
Suspend Timeout	10 min
LCD Back Light	Power Saving

Power Saving (AC)	
Power Management Mode	[Standard]
CPU Speed	100 %
Standby Timeout	30 min
Suspend Timeout	Disable
LCD Back Light	Bright

The settings are the same for [AC] and for [Battery].

Function \ Setting	Standard	Power Saving	User Setting
CPU Speed (%)	100	25	100, 75, 50, 25, 12.5
Standby Timeout (min)	30	2	1, 2, 5, 10, 15, 30, Disable
Suspend Timeout (min)	Disabled	10	1, 2, 5, 10, 15, 30, Disable
LCD Backlight	Bright	Power Saving	Bright, Medium, Dark, Power Saving

Setup Utility

Supervisor Setup

If a supervisor password has been set, the password input screen will appear. Input the supervisor password.

Supervisor Setup	
Parallel Port	[Port 378, IRQ 7]
Mode	[Bidirectional]
DMA	None
Infrared Port	[Port 2F8, IRQ 3]
ASK Mode	[Disabled]
DMA	[DMA 0]
Serial Port	[Port 3F8, IRQ 4]
Sound Port	[Enabled]
Sound Blaster compatible I/O	[220h]
WSS CODEC I/O	[530h]
IRQ	[IRQ 5]
DMA-A	[DMA 7]
DMA-B (Sound Blaster)	[DMA 1]
USB Port	[Disabled]
Boot up Drive	[FDD -> HDD]
• Supervisor Password	
User Password protection by user	[Disable]
PCI clock control*	[Enable]

page 38

(To display the items marked with an asterisk (*), move the cursor to the bottom of the screen to cause it to scroll down.)

[Sound Port]

Select the sound chip operation setting. If [Disabled] is selected, all sound related settings are disabled.

[Sound Port: Sound Blaster compatible I/O]

Set the I/O address for the Sound Blaster compatibility mode.

[Sound Port: WSS CODEC I/O]

Set the I/O address for WSS CODEC.

[Sound Port: IRQ]

Set the IRQ for the sound chip.

It is not possible to select the same IRQ as that selected for the parallel port.

[Sound Port: DMA-A] [Sound Port: DMA-B]

Set the DMA for the sound chip. Make sure that the settings for DMA-A and DMA-B do not overlap, and that neither of them overlaps with the DMA setting for the parallel port or the infrared port.

Set the parallel port IRQ.

If the setting conflicts with the sound port IRQ setting, the sound port is automatically set to a different IRQ.

Set the operation mode of the parallel port.

The [EPP] and [ECP] mode settings can be selected only if the parallel port setting is [278] or [378].

If [Parallel Port Mode] is set to [ECP], set the DMA channel.

Make sure that the setting does not conflict with the DMA setting for [Sound Port: DMA-A], [Sound Port: DMA-B], or the infrared port.

[Infrared Port]

Set the infrared port IRQ.

If the setting conflicts with IRQ set for the serial port, the serial port is automatically set to a different IRQ.

[Infrared Port: ASK Mode]

Selecting [Enabled] activates the ASK mode.

Select [Disabled] for the IrDA or FIR mode.

[Infrared Port: DMA]

Set the DMA for the infrared port. Make sure that the setting does not conflict with the DMA setting for the sound port or the parallel port.

Set the serial port IRQ.

If the setting conflicts with IRQ set for the infrared port, the infrared port is automatically set to a different IRQ.

Select [Enabled] in order to use the USB port.

Select [Disabled] if you will be using the suspend or hibernation function.

Set the drive to be used to boot the computer.







Select [Enable] if you want to prevent someone from setting the user password without your knowing it.





Select whether or not to use PCI clock control.

Note that if [Enable] is selected, some CardBus cards may not be detected properly.







Key Combinations

- Do not press the following key combinations repeatedly in (quick) succession.
- Do not press the following key combinations while using the trackball (mouse) or other keys.
- Some keys cannot be used during system startup, or while executing the suspend or hibernation process.
- Communication errors may occur if keys are used during processes such as high speed serial communications. Do not use the keys during communications.
- Pressing a key during audio playback or recording may cause the audio to be disrupted.
- Settings changed using **Fn + F2**, **Fn + F3** and **Fn + F6** only remain in effect temporarily. The settings defined using the Setup Utility are restored the next time the computer is restarted.

<p>LCD brightness control</p> <p>Fn + F2</p>	<p>Hold down the Fn key and press F2 to change the brightness. Each press advances the setting one step through the following sequence : Dark-Medium-Bright-Power Saving.</p> <p>When the brightness is at its maximum value, the following icon is displayed.</p> 
<p>Display change</p> <p>Fn + F3</p>	<p>By pressing this key combination, you can select either an external display , LCD or simultaneous.</p>
<p>Volume control</p> <p>Fn + F4 (down), Fn + F5 (up)</p>	<p>Pressing this key combination adjusts the volume of the internal speaker.</p> <p>The following icon is displayed.</p>   <p>Minimum Maximum</p>
<p>Power Management switch</p> <p>Fn + F6</p>	<p>By pressing this key combination, you can change the power management feature of the Setup Utility.</p> <p>The following icon is displayed.</p>    <p>Power Saving User Setting Standard</p>

<p>Power off using the hibernation function</p> <p>Fn + F7</p>	<p>Pressing this combination causes the current screen on the display to be saved to hard disk drive, and powers off the computer. When the computer is powered on again, this same screen will be displayed.</p>
<p>Speaker on/off switch</p> <p>Fn + F8</p>	<p>Pressing this key combination turns off audio from the internal speaker. Pressing it again turns audio back on. Also, the speaker automatically turns on when Fn + F4 or Fn + F5 is pressed. The following icon is displayed.</p> <div style="display: flex; justify-content: space-around; align-items: center;"> <div style="text-align: center;">  <p>On</p> </div> <div style="text-align: center;">  <p>Off</p> </div> </div>
<p>Remaining capacity of the battery pack</p> <p>Fn + F9</p>	<p>Pressing this key combination displays the remaining battery capacity on the screen. The following icon is displayed.</p> <div style="display: flex; justify-content: space-around; align-items: center;"> <div style="text-align: center;">  <p>Remaining capacity display</p> </div> <div style="text-align: center;">  <p>Battery pack is not installed.</p> </div> </div>
<p>Standby mode for conserving power</p> <p>Fn + F10</p>	<p>Pressing this key combination cuts off power to the motor of the hard disk drive and the display until operation is resumed by pressing any key.</p>

LED Indicators

	Caps Lock	This indicator lights green when Caps Lock is pressed. Subsequent non-shifted input is capitalized.
	NumLK (Numeric key)	This  indicator lights green when NumLK is pressed. This causes a portion of the keyboard to function as a numeric keypad.
	ScrLK (Scroll lock)	This indicator lights green when ScrLK is pressed. Scroll lock functions differently depending on the application.
	Hard disk status	This indicator lights when the hard disk drive is accessed.
	Battery pack status	<p>(Not lit) :AC adapter not connected or charging not being performed.</p> <p>(Lit constantly orange) :Charging in progress.</p> <p>(Lit constantly green) :Charging is finished.</p> <p>(Lit constantly red) :Battery is low</p> <p>(Blinking red) :Battery pack or charging malfunction.</p> <p>(Blinking orange) :Charging on standby. (The ambient temperature is outside the allowable range.)</p>
	Power status	<p>(Not lit)</p> <ul style="list-style-type: none"> • Power off • When the computer enters the hibernation mode. <p>(Blinking green)</p> <ul style="list-style-type: none"> • When the computer enters the suspend mode. <p>(Lit constantly green)</p> <ul style="list-style-type: none"> • Power on • When the computer enters the standby mode.

Specifications

Model No.		CF-M32W5M
CPU		Pentium® Processor with MMX™ technology 166 MHz
Cache Memory (second cache memory)		32 KB (256 KB)
EDO Memory		32 MB (96 MB Max.)
Video Memory		2 MB
LCD	Type	8.4" (TFT)
	Displayed Colors	262,144 colors (800 X 600 dots)
Hard Disk Drive		2.1 GB (1 GB =10 ⁹ bytes)
Input Device	Keyboard	84 keys
	Pointing Device	16mm Optical Trackball (Logitech Marble)
Ext. Floppy Disk Drive		720 KB/1.44 MB (two-mode)
Card Slots	PC Card Slots	Two Type I or Type II, or one Type III Allowable current (total for two slots) 3.3 V :800 mA 5 V :600 mA
	RAM Module Slot	144-pin, SO-DIMM, 60 ns, 3.3 V, EDO, Self refresh
Interface	<Port Replicator>	
	Parallel Port	Dsub 25-pin female
	Ext. Display Port	Mini Dsub 15-pin female
	Serial Port	Dsub 9-pin male
	Ext. Keyboard/Mouse Port	Mini DIN 6-pin female (PS/2 type)
	FDD Port	26-pin female, For External Floppy Disk Drive (CF-VFDU01)
	Microphone Jack	Dynamic Microphone
	Headphone Jack	Miniature jack, 3.5 DIA
	IrDA Port	IrDA 1.1 compliant, 4 Mbps data transmission speed*/ASK
USB Port	Universal Serial Bus	
Sound		16 bits, 44.1 kHz PCM/FM sound (Sound Blaster PRO Compatible) Mono Speaker X 1
Software	Operating System	Microsoft® Windows® 95
	Utility Programs	Setup Utility
Battery	Battery Pack	Lithium Ion 10.8 V, 1500 mAh
	Operating Time	Approx. 2.5 hours**
	Charging Time	Power On :Approx. 5 hours** Power Off :Approx. 2.5 hours**
	Clock Battery	Coin type lithium battery 3.0 V
AC Adapter		Input :100-240 V AC, 50/60 Hz Output :15.1 V DC, 2.6 A
Power Consumption		Approx. 26 W*** (maximum when charging in the ON state)
Physical Dimensions (WxDxH)		225 mm X 172 mm X 36 mm (8.86" X 6.77" X 1.42")
Weight		Approx. 1.0 kg (2.2 lbs) (With the battery pack installed)
Usage Condition		Temperature :5 °C to 35 °C (41 °F to 95 °F) Humidity :30 % to 80 % RH (No condensation)

* Separate communications software is necessary.

** Varies depending on the usage conditions.

*** Approx. 0.6 W when the battery pack is fully charged (or not being charged) and the computer is OFF.

Index

A

AC adapter 11,12,83
AC cord 11,12

B

Backup disks 21,58
Battery indicator 28,33,54
Battery pack 11,30,83
Battery pack connector 10,32
Battery pack release lever 10,32
Battery status 28,82
Brightness adjustment 8,80

C

CD-ROM drive 23,40,58
Charging 31,33
Click buttons 8,17
Computer viruses 7
CPU 15,83

D

DC-IN jack 9,12
Display 8,50,55
Displayed colors 83
Double-clicking 17
Dragging 17

E

Error codes 52
Expansion bus connector 10,43
Ext. display port 44,50,83
Ext. keyboard/mouse port 44,83
Extended life Battery Pack 30,32
External display 50,53,55

F

FIRSTAID FD 21,59,71
Floppy disk 5,7,21,55
Floppy disk drive 22,45,55,83
Format 55,60

H

Hard disk 6,59
Hard disk drive (HDD) 6,83
HDD indicator 6,8,18,82
Headphone jack 9,42,83
Hibernation data area 59,71
Hibernation function 18-20,29,81

I

Infrared communication port 9,41,83
Infrared data communications 40
I/O port address 57
IRQ 57

K

Keyboard 8,44,83
Key combinations 80

L

LED indicators 8,82
Limited use license agreement 12,69
Load default settings 52,73

M

Microphone jack 9,42,83

N

Network password 16

P

Parallel port	44,51,83
Password	16,36,56
PC Card	42,46,57
PC Card slots	9,46,83
Peripherals	5,42,56
Port Replicator	11,42,83
Power indicator	8,12,82
Power management	19,26,76,80
Power switch	9,12,19,76
Printer	42,51,56

R

RAM module	42,48,83
RAM module slot	42,49,83
Reinstalling software	58
Reset button	10,53,54
Restarting	10,18

S

Saving data	6
Security measures	36
Serial port	44,56,78,83
Setup utility	56,73
Shutting down	18,19
Speaker	9,80,83
Standby function	24,81
Standby timeout	27,77
Starting up	15,53
Supervisor password	38
Suspend function	18-20,29
Suspend timeout	27,77
System setup	75

T

Trackball	8,17,56,75
-----------------	------------

U

User password	16,36
USB	9,57,64,78

V

Video setup	50,75
Volume	9,80

W

Windows 95 setup	13,70
Write-protect tab	7,55

Memo



As an ENERGY STAR® Partner, Panasonic has determined that this product meets the ENERGY STAR® guidelines for energy efficiency.

Outline of the International ENERGY STAR® Office Equipment Program

The international ENERGY STAR® Office Equipment Program is an international program that promotes energy saving through the use of computers and other office equipment. The program backs the development and dissemination of products with functions that effectively reduce energy consumption. It is an open system in which business proprietors can participate voluntarily. The targeted products are office equipment such as computers, displays, printers, facsimiles, and copiers. Their standards and logos are uniform among participating nations.

Free Manuals Download Website

<http://myh66.com>

<http://usermanuals.us>

<http://www.somanuals.com>

<http://www.4manuals.cc>

<http://www.manual-lib.com>

<http://www.404manual.com>

<http://www.luxmanual.com>

<http://aubethermostatmanual.com>

Golf course search by state

<http://golfingnear.com>

Email search by domain

<http://emailbydomain.com>

Auto manuals search

<http://auto.somanuals.com>

TV manuals search

<http://tv.somanuals.com>