

USER MANUAL

MODEL 2157R Ruggedized CopperLink Ethernet Extender



This is a Class A device and is intended for use in a light industrial environment. It is not intended nor approved for use in an industrial or residential environment.



Part# 07M2157R-UM
Rev. B
Revised 10/15/08

SALES OFFICE
(301) 975-1000
TECHNICAL SUPPORT
(301) 975-1007

An ISO-9001 Certified
Company

Download from [Www.Somanuals.com](http://www.Somanuals.com). All Manuals Search And Download.

CONTENTS

1.0	Warranty Information	3
1.1	Compliance	3
	EMC Compliance:.....	3
	Safety Compliance:	3
	PSTN Compliance:	3
1.2	Radio and TV Interference (FCC Part 15)	3
1.3	CE Declaration of Conformity	4
1.4	Authorized European Representative	4
1.5	Service	4
1.6	Safety When Working With Electricity	5
2.0	General Information	6
2.1	Features.....	6
2.2	Description.....	6
3.0	Installation	8
3.1	Connecting the Twisted-Pair Line Interface	9
3.2	Line Interface—Connecting the 10/100Base-T Ethernet Interface ..	10
	Connecting the 10/100Base-T Ethernet Port to a Hub or PC.....	10
3.3	Connecting Power	11
3.4	Power Input Connector	11
	External AC universal power supply	12
	External 48 VDC power supply	12
3.5	Console Port	13
4.0	Operation	14
4.1	Front Panel LED Status Monitors	14
A		
	Specifications	15
A.1	General Characteristics	15
A.2	WAN Characteristics	15
A.3	Ethernet	15
A.4	Extension distance and rate	16
A.5	LED Indicators	17
A.6	Power and Power Supply Specifications	17
A.7	Temperature Range	17
A.8	Humidity	17
A.9	Dimensions	17
B		
	Model 2157R Series Factory	
	Replacement Parts and Accessories	18
C		
	Model 2157R Series Interface Pin Assignment	19
C.1	10/100Base-T Interface	19
	RJ-45	19

C.2 CopperLink Interface	19
RJ-11	19

1.0 WARRANTY INFORMATION

Patton Electronics warrants all Model 2157R components to be free from defects, and will—at our option—repair or replace the product should it fail within one year from the first date of the shipment.

This warranty is limited to defects in workmanship or materials, and does not cover customer damage, abuse or unauthorized modification. If this product fails or does not perform as warranted, your sole recourse shall be repair or replacement as described above. Under no condition shall **Patton Electronics** be liable for any damages incurred by the use of this product. These damages include, but are not limited to, the following: lost profits, lost savings and incidental or consequential damages arising from the use of or inability to use this product. **Patton Electronics** specifically disclaims all other warranties, expressed or implied, and the installation or use of this product shall be deemed an acceptance of these terms by the user.

Note Conformity documents of all Patton products can be viewed online at www.patton.com under the appropriate product page.

1.1 COMPLIANCE

EMC Compliance:

- FCC Part 15, Class A
- EN55022, Class A
- EN55024

Safety Compliance:

- IEC/EN 60950-1
- AS/NZS 60950-1

PSTN Compliance:

Note This device is not intended nor approved for connection to the PSTN.

1.2 RADIO AND TV INTERFERENCE (FCC PART 15)

This equipment generates and uses radio frequency energy, and if not installed and used properly—that is, in strict accordance with the manufacturer's instructions—may cause interference to radio and television reception. This equipment has been tested and found to comply with the

limits for a Class A computing device in accordance with the specifications in Subpart B of Part 15 of FCC rules, which are designed to provide reasonable protection from such interference in a commercial installation. However, there is no guarantee that interference will not occur in a particular installation. If the equipment causes interference to radio or television reception, which can be determined by disconnecting the cables, try to correct the interference by one or more of the following measures: moving the computing equipment away from the receiver, re-orienting the receiving antenna, and/or plugging the receiving equipment into a different AC outlet (such that the computing equipment and receiver are on different branches).

1.3 CE DECLARATION OF CONFORMITY

We certify that the apparatus described above conforms to the requirements of Council Directive 2004/108/EC on the approximation of the laws of the member states relating to electromagnetic compatibility; and Council Directive 2006/95/EC on the approximation of the laws of the member states relating to electrical equipment designed for use within certain voltage limits.

The safety advice in the documentation accompanying this product shall be obeyed. The conformity to the above directive is indicated by the CE sign on the device.

1.4 AUTHORIZED EUROPEAN REPRESENTATIVE

D R M Green

European Compliance Services Limited.

Avalon House, Marcham Road

Abingdon,

Oxon OX14 1UD, UK

1.5 SERVICE

All warranty and non-warranty repairs must be returned freight prepaid and insured to Patton Electronics. All returns must have a Return Materials Authorization number on the outside of the shipping container. This number may be obtained from Patton Electronics Technical Services at:

- Tel: **+1 (301) 975-1007**
- Email: **support@patton.com**
- URL: **http://www.patton.com**

1.6 SAFETY WHEN WORKING WITH ELECTRICITY



- This device contains no user serviceable parts. The equipment shall be returned to Patton Electronics for repairs, or repaired by qualified service personnel.
- The external power adapter shall be a listed Limited Power Source. The mains outlet that is utilized to power the device shall be within 10 feet (3 meters) of the device, shall be easily accessible, and protected by a circuit breaker.
- If an AC power adapter is used, ensure that the power cable used meets all applicable standards for the country in which it is to be installed, and that it is connected to a wall outlet which has earth ground.
- Hazardous network voltages are present in WAN ports regardless of whether power to the unit is ON or OFF. To avoid electric shock, use caution when near WAN ports. When detaching the cables, detach the end away from the device first.
- Do not work on the system or connect or disconnect cables during periods of lightning activity.



In accordance with the requirements of council directive 2002/96/EC on Waste of Electrical and Electronic Equipment (WEEE), ensure that at end-of-life you separate this product from other waste and scrap and deliver to the WEEE collection system in your country for recycling.



This device is NOT intended nor approved for connection to the PSTN. It is intended only for connection to customer premise equipment.



When the 2157R is mounted, it shall be secured in such a way as to withstand a vertical shear force of 50N or 14 pounds.

2.0 GENERAL INFORMATION

Thank you purchasing this Patton Electronics product. This product has been thoroughly inspected and tested and is warranted for one year for parts and labor. If questions arise while installing or using this product, contact **Technical Support** at **+1 (301) 975-1007**.

2.1 FEATURES

- Easy-to-install Ethernet Extenders—*no configuration required*
- Auto-rate adaption ensures the highest rate possible for each extension distance
- Data rates to 2.3 Mbps 4.6 Mbps
- Auto-sensing 10/100Base-T
- Extends network connections up to 30,000 ft (9,144 m) over 2-wire 24-AWG unconditioned lines (see Appendix A on page 16)
- Transparent operation to higher level protocols such as TCP/IP, DECnet, NETBIOS, IPX, etc.
- Compatible with 802.1Q VLAN
- LED indicators for Power; Line Link, Line Transmit, Line Receive, Ethernet Link, Ethernet 100 M, Ethernet Transmit, Ethernet Receive
- Extended temperature ratings of -10 to 70C (2157R/E) and -40 to 85C (2157R/CC/E)
- Made in the USA

2.2 DESCRIPTION

The Patton Electronics Model 2157R Ruggedized CopperLink Ethernet Extender provides high-speed LAN connections between peered Ethernet LANs, remote PCs, or any other network enabled 10/100Base-T device.

Operating in pairs, one Model 2157R or 2157 can automatically forward LAN broadcasts, multicasts, and frames across a 2-wire voice-grade twisted-pair link. The data is passed transparently (unmodified) through the Ethernet Extenders. They automatically add and delete MAC addresses, only passing packets across the CopperLink line that are meant for the remote peered LAN.

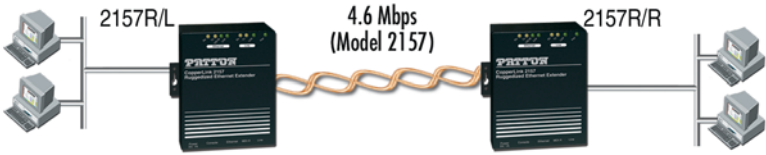

Figure 1. Typical application

The 2157/L and 2157/R work together to create a transparent extension between two peered Ethernet LANs. Figure 1 shows a typical point-to-point application.

3.0 INSTALLATION



The interconnecting cables shall be acceptable for external use and shall be rated for the proper application with respect to voltage, current, anticipated temperature, flammability, and mechanical serviceability.

Because the CopperLink Ethernet Extenders require no configuration, they can be installed quickly. Installation consists of the following:

- Connect the line interface between the units (refer to section 3.1, “Connecting the Twisted-Pair Line Interface” on page 10)

Note See Figure 2 for the rear-panel connectors locations.

- Connect the Ethernet interface (refer to section 3.2, “Line Interface—Connecting the 10/100Base-T Ethernet Interface” on page 11).
- Connect the power plug (refer to section 3.3, “Connecting Power” on page 12).

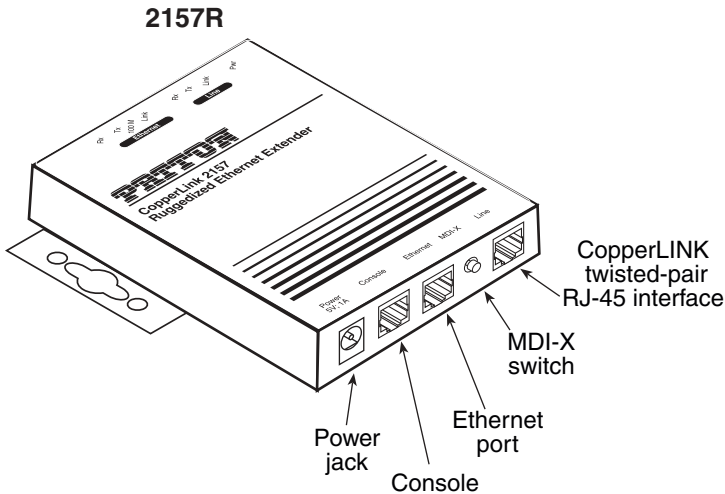

Figure 2. CopperLink Ethernet Extender rear panel

3.1 CONNECTING THE TWISTED-PAIR LINE INTERFACE



The Interconnecting cables shall be acceptable for external use and shall be rated for the proper application with respect to voltage, current, anticipated temperature, flammability, and mechanical serviceability.

The Model 2157R supports communication between two peer Ethernet LAN sites over a distance greater than 30,000 ft (9,144 m) over 24 AWG (0.5 mm) twisted-pair wire.

Note The Model 2157R uses an auto-rate adaption feature to provide the fastest data rate possible over the wire and distance of each Ethernet extension. The actual distance and rate achieved for Ethernet extension may vary depending on the environment and type/gauge of the wire used.

Follow the steps below to connect the CopperLink interfaces.

Note The Model 2157R units work in pairs. One of the units must be configured as a (L) Local unit, and the other unit must be configured as a (R) Remote unit. It does not matter which end is the L and which is the R. The link is always initiated by the R unit. As long as the L unit is powered on, the R unit can establish a link by being powered on or by having its power reset.

1. To function properly, the two Ethernet Extenders must be connected together using twisted-pair, unconditioned, dry, metal wire, between 19 (0.9mm) and 26 AWG (0.4mm). Leased circuits that run through signal equalization equipment are not acceptable.
2. The Model 2157R is equipped with an RJ-11 interface. The CopperLink interfaces are a two-wire interface. Observe the signal/pin relationships on the CopperLink interface jack.

The RJ-11 connector on the CopperLink Ethernet Extender's twisted pair interface is polarity insensitive and is wired for a two-wire interface. The signal/pin relationship is shown in Figure 3.

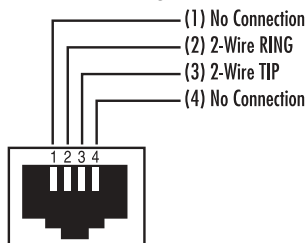

Figure 3. CopperLink Ethernet Extender (RJ-11) twisted pair line interface.

3.2 LINE INTERFACE—CONNECTING THE 10/100BASE-T ETHERNET INTERFACE



The Interconnecting cables shall be acceptable for external use and shall be rated for the proper application with respect to voltage, current, anticipated temperature, flammability, and mechanical serviceability.

The shielded RJ-45 port labeled *Ethernet* is the 10/100Base-T interface. This port is designed to connect directly to a 10/100Base-T network. Figure 4 shows the signal/pin relationships on this interface. You may connect this port to another Ethernet device via a Type 4 or Type 5 cable that is up to 328 ft (100 m) long.

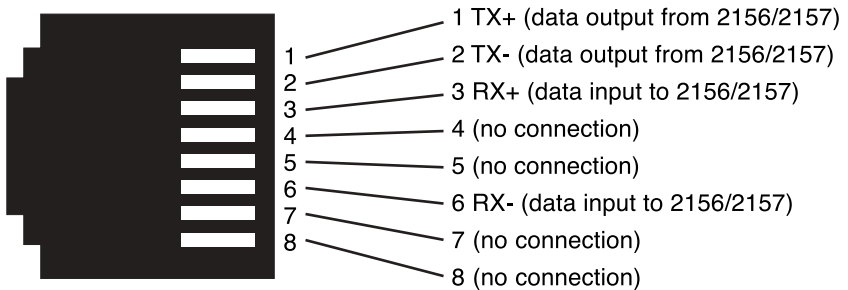

Figure 4. CopperLink Ethernet Extender 10/100Base-T RJ-45 Connector Pinout.

Connecting the 10/100Base-T Ethernet Port to a Hub or PC

The Model 2157R is equipped with an MDI-X switch that enables connections to a hub (DCE) or PC (DTE) interface, thereby eliminating confusion over whether a straight-through or crossover cable is needed.

When using a straight-through cable for connecting to a hub, the MDI-X switch should be in its released (DCE mode) position (see Figure 5). When connecting to a PC, the MDI-X switch should be pushed in to engage the crossover function so you won't have to use a crossover cable



Figure 5. MDI-X switch positions

Note If you have difficulty achieving a working connection between the CopperLink Ethernet Extender's Ethernet port and the hub or PC, change the position of the MDI-X switch and try again.

In its released position, the MDI-X switch enables straight-through connections (see Figure 6) or in its inserted position the MDI-X switch performs the crossover function (see Figure 7 on page 12).

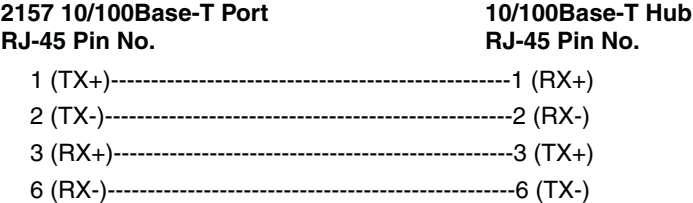

Figure 6. Wiring diagram for connecting the CopperLink Ethernet Extender to a 10/100Base-T hub (MDI-X switch released)

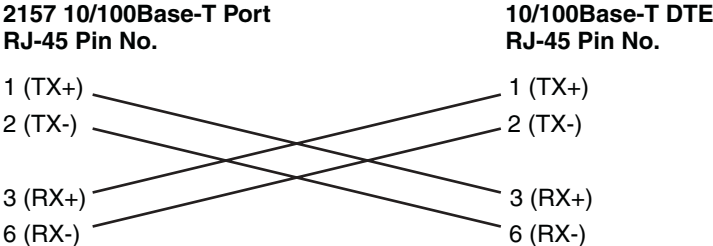

Figure 7. MDI-X switch pressed in performs 10/100Base-T crossover function

3.3 CONNECTING POWER



The Interconnecting cables shall be acceptable for external use and shall be rated for the proper application with respect to voltage, current, anticipated temperature, flammability, and mechanical serviceability.

The Model 2157R does not have a power switch, so it powers up as soon as it is plugged in.

An external AC or DC power supply is available separately. This connection is made via the barrel jack on the rear panel of the Model 2157R. No configuration is necessary for the power supply (See Appendix B on page 19 for domestic and international power supply and cord options).

3.4 POWER INPUT CONNECTOR

The CopperLink Ethernet Extender comes with an AC or DC power supply.

- The supplies connection to the CopperLink Ethernet Extender is a 2.5 mm barrel receptacle with the center conductor positive (see Figure 6).

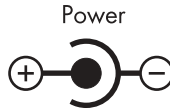

Figure 8. Power connection barrel receptacle diagram

- CopperLink Ethernet Extender's rated voltage: 5.0 VDC
- CopperLink Ethernet Extender's rated current: 1 A DC

External AC universal power supply

- Output from power supply: 5 VDC, 2A
- Input to power supply: universal input 100–240 VAC 50/60 Hz 0.3A



An approved LPS external power supply that incorporates a disconnect device must be used and positioned within easy reach of the operator's position.



Connect the equipment to a 5 VDC source that is electrically isolated from the AC source. The 5 VDC source is to be reliably connected to earth.

External 48 VDC power supply

- Input
 - Rated voltage: 36–60 VDC
 - Rated current: 0.25 A DC at nominal 48 VDC
 - 3-pin locking connector, 3.5 mm pitch
 - Reverse polarity protection
 - Transient over-voltage protection, 100 VDC at 2 ms
- Output
 - Rated voltage: 5 VDC \pm 5%, 5W
 - Rated current; 1 A DC

- 6-inch cable terminated with 2.5 mm barrel plug, center positive



An approved LPS external power supply that incorporates a disconnect device must be used and positioned within easy reach of the operator's position.



Connect the equipment to a 36–60 VDC source that is electrically isolated from the AC source. The 36–60 VDC source is to be reliably connected to earth.

3.5 CONSOLE PORT

The Console Port is only intended for use by Patton Electronics Technical Support technicians.

4.0 OPERATION

Once the CopperLink Ethernet Extenders are properly installed, they should operate transparently. No user settings required. This section describes reading the LED status monitors.

4.1 FRONT PANEL LED STATUS MONITORS

The Model 2157R features eight front-panel LEDs that monitor power, Ethernet signals, and the CopperLink connection. Figure 9 shows the front panel location of each LED. Table 1 describes the LED functions.

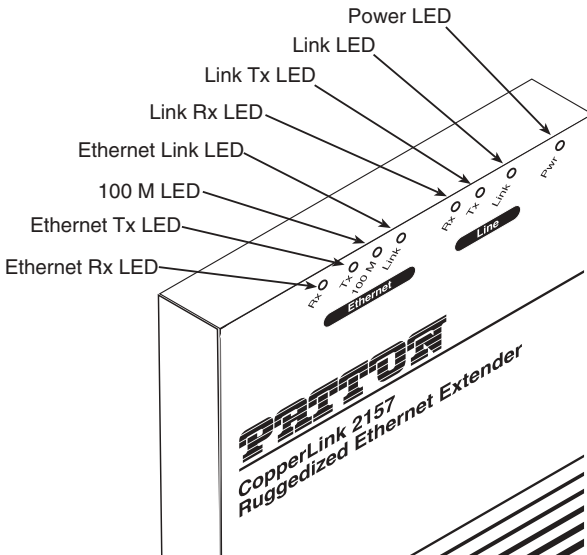

Figure 9. CopperLink Ethernet Extender standalone unit front panel

Table 1: Front panel LED description

LED		Description
Power		When lit, indicates the unit is powered on
Line	Link	<ul style="list-style-type: none"> On solid—link is connected Off—No signal detected
	TX	Flashing—Data is being transmitted from the local unit to the remote unit
	RX	Flashing—Data is being received at the local unit from the remote unit
Ethernet	Link	On—Ethernet is linked
	100 M	On—100 Mbps Ethernet is selected
	TX	Flashing—When data is transmitted from the unit to the LAN
	RX	Flashing—When data is received from the LAN

APPENDIX A

SPECIFICATIONS

A.1 GENERAL CHARACTERISTICS

- Compact low cost plug-and-play router
- 10/100 Ethernet
- Unlimited host support
- Eight front panel LEDs indicate Power, WAN, Ethernet LAN speed and status
- Convenient and standard RJ connectors for Ethernet and line
- External UI or 48 VDC power supply options
- Standard 1-year warranty

A.2 WAN CHARACTERISTICS

- 4.6 Mbps speed
- RJ-11 connector
- Uses two-wire unconditioned twisted-pair

A.3 ETHERNET

- Full-duplex, auto-sensing, 10Base-T/100Base-TX Ethernet
- Standard RJ-45 and built-in MDI-X crossover switch
- IEEE 802.1d transparent learning bridge up to 1,024 addresses and spanning tree
- Compatible with 802.1Q VLAN
- Addresses deleted after 5 minutes of inactivity

A.4 EXTENSION DISTANCE AND RATE

- 4.6 Mbps speed
- Distances up to 30,000 ft (9,144 m) on 24 AWG (0.4 mm) wire
- Auto-adjusting rate picks best rate for a given extension distance (see tables below)

Table 2: Model 2157R Extension Distances

Line Rate	No Noise									
	26g (0.4 mm)		24g (0.5 mm)		22g (0.6 mm)		20g (0.8 mm)		19g (0.9 mm)	
kbps	miles	km	miles	km	miles	km	miles	km	miles	km
200	4.4	7.0	5.7	9.4	8.0	13.1	10.3	16.8	12.1	19.7
392	4.0	6.6	5.4	8.8	7.5	12.3	9.7	15.8	10.8	17.5
520	3.8	6.2	5.1	8.3	7.1	11.6	9.2	14.9	9.7	15.8
776	3.5	5.6	4.6	7.5	6.0	9.8	7.8	12.7	8.8	14.3
1160	3.0	4.9	4.0	6.4	5.2	8.4	6.7	11.0	7.5	12.3
1544	2.8	4.6	3.7	6.1	4.9	7.9	6.4	10.3	6.7	11.0
2056	2.5	4.0	3.3	5.3	4.2	6.9	5.6	9.0	5.9	9.6
2312	2.3	3.8	3.1	5.0	4.0	6.6	5.3	8.6	5.6	9.1
2696	2.3	3.7	3.0	5.0	4.0	6.4	5.2	8.4	5.5	8.9
3080	2.2	3.6	3.0	4.8	3.9	6.3	5.0	8.2	5.4	8.7
3464	2.1	3.4	2.7	4.5	3.6	5.8	4.7	7.6	4.9	8.0
3848	1.9	3.1	2.5	4.1	3.3	5.3	4.3	7.0	4.5	7.4
4232	1.7	2.8	2.3	3.7	2.9	4.8	3.9	6.3	4.1	6.6
4616	1.5	2.5	2.0	3.3	2.6	4.2	3.4	5.5	3.6	5.9

A.5 LED INDICATORS

- Eight LED indicators
- Power
- Line Link, Transmit, and Receive
- Ethernet Link, 100M, Transmit, and Receive

A.6 POWER AND POWER SUPPLY SPECIFICATIONS

- Either AC or DC options are available
- Connection to the CopperLink Ethernet Extender requires +5VDC $\pm 5\%$ DC power (1.0A minimum). Center pin is +5V. The barrel type plug has a 2.5/5.5/10mm I.D./O.D./shaft length dimensions
- CopperLink Ethernet Extender's rated voltage: 5.0 VDC
- CopperLink Ethernet Extender's rated current: 1A DC

A.7 TEMPERATURE RANGE

- -10 to 70°C (2157R/E)
- -40 to 85°C (2157R/CC/E)

A.8 HUMIDITY

Standard:Up to 90% non-condensing

Conformal Coated: 85% condensing humidity from -10 to 35°C

A.9 DIMENSIONS

1.5H x 4.13W x 3.75D in.(3.81H x 10.5W x 9.53D cm)

APPENDIX B
 MODEL 2157R SERIES FACTORY
 REPLACEMENT PARTS AND ACCESSORIES

Patton Model #	Description
2157R Base Models	
2157R/EUI	Ruggedized 4.6 Mbps CopperLink Ethernet Extender
2157R/EUI-2PK	Ruggedized 4.6Mbps CopperLink Ethernet Extender Kit: includes one local (L) and one remote (R) Model 2157R
2157R/CC/E	Extended Temperature 4.6 Mbps CopperLink Ethernet Extender
2157R/CC/E-2PK	Extended Temperature 4.6 Mbps CopperLink Ethernet Extender Kit: includes one local (L) and one remote (R) Model 2157R
2157R User Manual	
07M2157R-UM	User Manual
Power Supplies	
08055DCUI	100–240VAC (+5V reg. DC/2A) Universal Input Adapter.
48V-PSM3	DC/DC; 48V in 5V 1A out
24V-PSM	DC/DC; 24V in 5V 1A out
12V-PSM	DC/DC; 12V in 5V 1A out
Power Cords*	
0805US	American Power Cord
0805EUR	European Power Cord CEE 7
0805UK	United Kingdom Power Cord
0805AUS	Australian Power Cord
0805DEN	Denmark Power Cord
0805FR	France/Belgium Power Cord
0805IN	India Power Cord
0805IS	Israel Power Cord
0805JAP	Japan Power Cord
0805SW	Switzerland Power Cord

*Only required with optional UI power supply (08055DCUI)

APPENDIX C

MODEL 2157R SERIES INTERFACE PIN ASSIGNMENT

C.1 10/100BASE-T INTERFACE

RJ-45

- Pin 1: TX+
- Pin 2: TX-
- Pin 3: RX+
- Pin 6: RX-
- Pins 4, 5, 7, 8: no connection

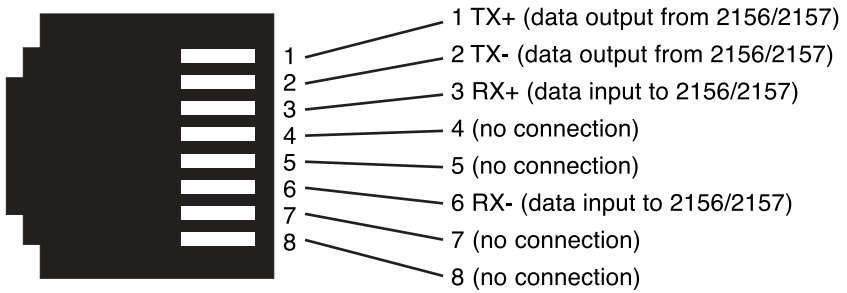

C.2 COPPERLINK INTERFACE

RJ-11

- Pin 2: RING
- Pin 3: TIP
- Pins 1 & 4: no connection

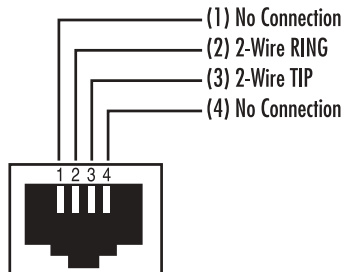

Free Manuals Download Website

<http://myh66.com>

<http://usermanuals.us>

<http://www.somanuals.com>

<http://www.4manuals.cc>

<http://www.manual-lib.com>

<http://www.404manual.com>

<http://www.luxmanual.com>

<http://aubethermostatmanual.com>

Golf course search by state

<http://golfingnear.com>

Email search by domain

<http://emailbydomain.com>

Auto manuals search

<http://auto.somanuals.com>

TV manuals search

<http://tv.somanuals.com>