

Model 3196RC **iDSL TDM-Digital Access Concentrator (T-DAC)**

User Manual

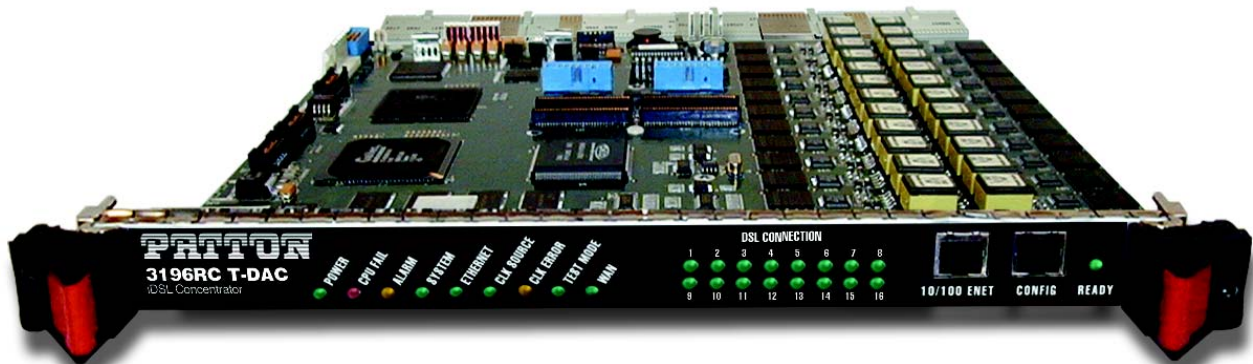

Sales Office: **+1 (301) 975-1000**
Technical Support: **+1 (301) 975-1007**
E-mail: support@patton.com
WWW: www.patton.com

Part Number: **07MD3196RC-G5, Rev. D**
Revised: **February 17, 2012**

Patton Electronics Company, Inc.

7622 Rickenbacker Drive
Gaithersburg, MD 20879 USA

Tel: +1 (301) 975-1000

Fax: +1 (301) 869-9293

Support: +1 (301) 975-1007

Web: www.patton.com

E-mail: support@patton.com

Copyright © 2012, Patton Electronics Company. All rights reserved.

The information in this document is subject to change without notice. Patton Electronics assumes no liability for errors that may appear in this document.

Warranty Information

The software described in this document is furnished under a license and may be used or copied only in accordance with the terms of such license.

Patton Electronics warrants all Model 3196RC components to be free from defects, and will—at our option—repair or replace the product should it fail within one year from the first date of the shipment.

This warranty is limited to defects in workmanship or materials, and does not cover customer damage, abuse or unauthorized modification. If the product fails to perform as warranted, your sole recourse shall be repair or replacement as described above. Under no condition shall **Patton Electronics** be liable for any damages incurred by the use of this product. These damages include, but are not limited to, the following: lost profits, lost savings and incidental or consequential damages arising from the use of or inability to use this product. **Patton Electronics** specifically disclaims all other warranties, expressed or implied, and the installation or use of this product shall be deemed an acceptance of these terms by the user.

Summary Table of Contents

1	Introduction	16
2	Hardware installation	24
3	Configuring the T-DAC for operation	35
4	Operation and shutdown	68
5	Troubleshooting and maintenance	70
6	Contacting Patton for assistance	85
A	Network Ports (RJ-21X) connector pin-out	88
B	WAN Network Module connector pinout	91

Table of Contents

Summary Table of Contents	3
Table of Contents	4
List of Figures	7
List of Tables	9
Compliance Information	10
Radio and TV Interference	10
Industry Canada Notice	11
FCC Part 68 (ACTA) Statement	11
CE Notice	12
About this guide	13
Audience.....	13
Structure.....	13
Precautions	14
Typographical conventions used in this document.....	14
General conventions	14
Mouse conventions	15
1 Introduction	16
Model 3196RC iDSL T-DAC overview	17
Hardware overview.....	18
WAN	18
LAN	19
RS-232 control port	19
Power system	19
Central processing unit	19
iDSL ports	19
System timing	20
Temperature	20
Altitude	20
Humidity	20
Physical dimensions	20
Management services	20
LED display	21
Approvals	23
2 Hardware installation	24
Introduction.....	25
Unpacking the Model 3196RC T-DAC.....	25
T-DAC blades installation.....	25
Cable installation.....	27

Connecting the Ethernet ports	27
Connecting the 10/100Base-T Ethernet port to an Ethernet switch or hub	27
Connecting the 10/100Base-T Ethernet port to an Ethernet-capable workstation or PC	28
Connecting the EIA-561 RS-232 configuration port (DCE configured)	28
Connecting to the T1/E1 WAN ports	29
Connecting the iDSL ports	31
Connecting the BITS clock	32
Completing the hardware installation	34
3 Configuring the T-DAC for operation	35
Introduction	36
Configuration prerequisites	36
Initial configuration through the RS-232 control port	37
Connecting the DB9-RJ45 adapter with the included cable	37
Setting up the HyperTerminal (or similar program) session	38
Using a browser to complete Model 3196RC configuration	41
Displaying the T-DAC 3196RC web administration pages	41
Home page overview	42
Configuring the default gateway	44
Configuring the system clocking parameters	45
Configuring the DS0 mapping	47
Examples for configuring static connections.	49
Activating the iDSL ports	54
Configuring Patton iDSL CPE device remotely via the Model 3196RC	54
Configuring line settings and signaling for E1	57
Accessing the Line Interface Settings	57
Configuring the E1 line interface settings	58
Configuring line settings and signaling for T1	60
Accessing the Line Interface Settings	60
Configuring the T1 line settings	61
Saving your configuration.....	63
Backing up your configuration parameters.....	63
Backing up the configuration store in flash memory	65
Completing the installation	66
4 Operation and shutdown.....	68
Introduction	69
Activating the Model 3196RC.....	69
De-activating the Model 3196RC	69
5 Troubleshooting and maintenance	70
Introduction	71
Fault analysis	72
Basic iDSL and T1/E1 test modes	74
iDSL port test modes	74
Local loop	74

Remote loop	75
Line Loop	76
T1/E1 port test modes	77
DSX1 payload loop (dsx1PayloadLoop)	77
DSX1 line loop (dsxLineLoop)	78
Periodic maintenance	78
Calibration	78
Maintenance.....	79
Replacing the Model 3196RC	79
Exporting the current Model 3196RC configuration	79
Removing the defective Model 3196RC	82
Installing the replacement Model 3196RC	83
Importing a saved configuration	83
Completing the installation	84
6 Contacting Patton for assistance	85
Introduction.....	86
Contact information.....	86
Warranty Service and Returned Merchandise Authorizations (RMAs).....	86
Warranty coverage	86
Out-of-warranty service	86
Returns for credit	86
Return for credit policy	87
RMA numbers	87
Shipping instructions	87
A Network Ports (RJ-21X) connector pin-out	88
Introduction.....	89
B WAN Network Module connector pinout	91
Introduction.....	92
68-Pin Telco pinout.....	92

List of Figures

1	Ferrite location	10
2	Model 3196RC T-DAC	17
3	Model 3196RC T-DAC features	18
4	Model 3196RC front panel LEDs	21
5	Alignment/ESD pin and card handle	26
6	Model 3196RC network and configuration ports	27
7	Ethernet RJ-45 pin and signal definitions for T-DAC	28
8	Cross-over RJ-45-to-RJ-45 Ethernet cable diagram	28
9	DB-9-to-RJ-45 cable diagram	28
10	WAN cable's 68-pin SCSI connector	29
11	68 pin SCSI-to-RJ45 6-foot WAN cable	29
12	RJ-21X connector	31
13	EXT CLOCK connector location	33
14	Model 3196RC interface ports	37
15	Connection Description window	38
16	Connect To window	38
17	COM1 Properties window	39
18	Terminal keys configuration	39
19	Login window	40
20	VT-100 Top Level Management window	40
21	3196RC Configuration Menu home page	42
22	HOME page window panes	43
23	Immediate Actions buttons	43
24	IP Routing Information Page	44
25	IP Routing Information window	45
26	System Clocking Configuration page, example 1	46
27	System Clocking Configuration page, example 2	47
28	DS0 Mapping Configuration window	48
29	DS0 Mapping Configuration page	48
30	iDSL Port Configuration page	50
31	iDSL Port 1 Details page	51
32	iDSL Port configurable parameters	51
33	iDSL Port Configuration window	54
34	T1/E1 Link Activity Overview page	57
35	T1/E1 Link Activity Ports 1 – 4 page.	58
36	WAN Circuit Configuration page, Line Interface Settings	58
37	Line Type pull-down menu	58
38	Line Coding pull-down menu with dsx1HDB3(3) selected	59
39	Line Build Out pull-down menu with e1pulse(1) selected	59
40	E1 ALARMS PRESENT indicator	59
41	T1/E1 Link Activity Overview page	60
42	T1/E1 Link Activity Ports 1 – 4 page.	60
43	WAN Circuit Configuration page, Line Interface Settings	61
44	Line Type pull-down menu with dsx1ESF(2) selected	61
45	Line Coding pull-down menu with dsx1B8ZS(2) selected	62
46	Line Build Out pull-down menu with t1pulse0dB(1) selected	62
47	T1 ALARMS PRESENT indicator on T1/E1 LINK ACTIVITY page	62

48	3196RC Configuration Menu home page	63
49	IMPORT/EXPORT page	64
50	Example T-DAC flash memory configuration file displayed in a browser	65
51	Saving the access server flash memory configuration data as a text file	66
52	Local loopback	75
53	Remote loopback	75
54	Line Loopback	76
55	Payload loopback	77
56	Line Loop	78
57	IMPORT/EXPORT page	80
58	Example T-DAC flash memory configuration file displayed in a browser	81
59	Saving the access server flash memory configuration data as a text file	82
60	50-pin Telco connector	89
61	68-pin SCSI connector	92

List of Tables

1	General conventions	14
2	Mouse conventions	15
3	LED definitions	21
4	WAN cable's 68 non-terminated twisted-pairs	30
5	Band Marked Color Code	31
6	EXT CLOCK connector pinout	33
7	Symptoms	71
8	LED definitions	72
9	Band Marked Color Code	89
10	WAN cable's 68 non-terminated twisted-pairs	92

Compliance Information

Radio and TV Interference

The Model 3196RC generates and uses radio frequency energy, and if not installed and used properly—that is, in strict accordance with the manufacturer's instructions—may cause interference to radio and television reception. The Model 3196RC has been tested and found to comply with the limits for a Class A computing device in accordance with the specifications in Subpart B of Part 15 of FCC rules, which are designed to provide reasonable protection from such interference in a commercial installation. However, there is no guarantee that interference will not occur in a particular installation. If the Model 3196RC causes interference to radio or television reception, which can be determined by disconnecting the cables, try to correct the interference by one or more of the following measures: moving the computing equipment away from the receiver, re-orienting the receiving antenna, and/or plugging the receiving equipment into a different AC outlet (such that the computing equipment and receiver are on different branches).

Interference can also be reduced by installing an optional clamp-on ferrite (Patton P/N 0816-13) on the DSL cable, within 12 inches (30 cm) of the DSL connector (see figure 1)

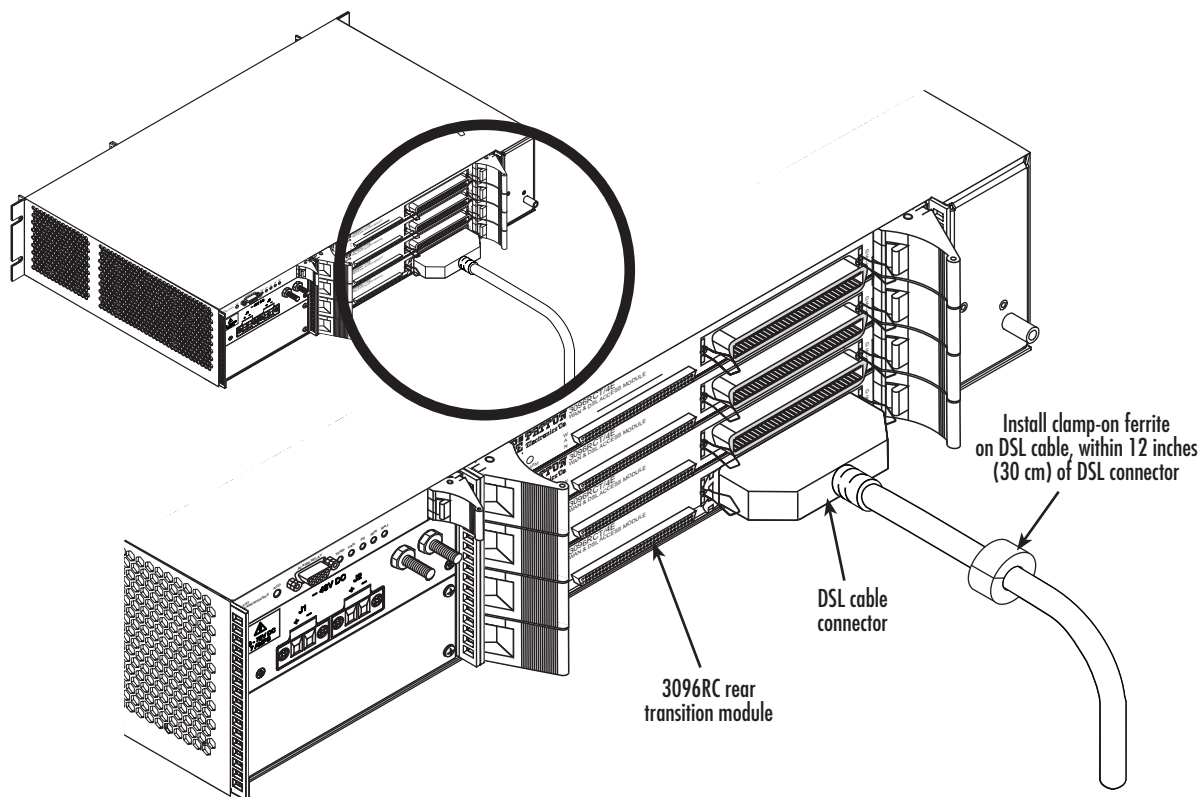

Figure 1. Ferrite location

Industry Canada Notice

Note This equipment meets the applicable Industry Canada Terminal Equipment Technical Specifications. This is confirmed by the registration number. The abbreviation, *IC*, before the registration number signifies that registration was performed based on a Declaration of conformity indicating that Industry Canada technical specifications were met. It does not imply that Industry Canada approved the equipment.



Users should not attempt to establish or modify ground connections themselves, instead they should contact the appropriate electric inspection authority or electrician.

FCC Part 68 (ACTA) Statement

This equipment complies with Part 68 of FCC rules and the requirements adopted by ACTA. On the bottom side of this equipment is a label that contains—among other information—a product identifier in the format *US: AAAEQ##TXXXX*. If requested, this number must be provided to the telephone company.

A plug and jack used to connect this equipment to the premises wiring and telephone network must comply with the applicable FCC Part 68 rules and requirements adopted by the ACTA.

This equipment uses a Universal Service Order Code (USOC) jack: RJ-11C.

If this equipment causes harm to the telephone network, the telephone company will notify you in advance that temporary discontinuance of service may be required. But if advance notice isn't practical, the telephone company will notify the customer as soon as possible. Also, you will be advised of your right to file a complaint with the FCC if you believe it is necessary.

The telephone company may make changes in its facilities, equipment, operations or procedures that could affect the operation of the equipment. If this happens the telephone company will provide advance notice in order for you to make necessary modifications to maintain uninterrupted service.

If trouble is experienced with this equipment, for repair or warranty information, please contact our company. If the equipment is causing harm to the telephone network, the telephone company may request that you disconnect the equipment until the problem is resolved.

Connection to party line service is subject to state tariffs. Contact the state public utility commission, public service commission or corporation commission for information.

In accordance with FCC rules and regulation CFR 47 68.218(b)(6), you must notify the telephone company prior to disconnection. The following information may be required when applying to your local telephone com-

pany for leased line facilities. The Universal Service Order Code (USOC) is RJ48. The Facility Interface Codes (FIC) are 04DU9-BN, 04DU9-DN, 04DU9-1KN, and 04DU9-1SN. The Service Order Code (SOC) is 6.0N.

Service	Facility Interface Code	Service Code	Network Connection
1.544 Mbps SF format without line power	04DU9-BN	6.0N	RJ-48C
1.544 Mbps SF and B8ZS without line power	04DU9-DN	6.0N	RJ-48C
1.544 Mbps ANSI ESF without line power	04DU9-1KN	6.0N	RJ-48C
1.544 Mbps ANSI ESF and B8ZS without line power	04DU9-1SN	6.0N	RJ-48C

CE Notice

The CE symbol on your Patton Electronics equipment indicates that it is in compliance with the Electromagnetic Compatibility (EMC) directive and the Low Voltage Directive (LVD) of the European Union (EU). A Certificate of Compliance is available by contacting Technical Support.

About this guide

This guide describes installing and configuring a Patton Electronics Model 3196RC TDM-Digital Access Concentrator (T-DAC). By the time you are finished with this guide, your T-DAC will be connected to the remote DSL modems and transferring data. The instructions in this guide are based on the following assumptions:

- The T-DAC will connect to a T1 or E1
- There is a LAN connected to the Ethernet port of the T-DAC
- Users will be connected to remote iDSL modems

Audience

This guide is intended for the following users:

- Operators
- Installers
- Maintenance technicians

Structure

This guide contains the following chapters and appendices:

- Chapter 1 describes the T-DAC
- Chapter 2 describes installing the T-DAC hardware
- Chapter 3 describes configuring the T-DAC for use
- Chapter 4 details how to power up and deactivate the T-DAC
- Chapter 5 contains troubleshooting and maintenance information
- Chapter 6 contains information on contacting Patton technical support for assistance

For best results, read the contents of this guide *before* you install the T-DAC.

Precautions

Notes and cautions, which have the following meanings, are used throughout this guide to help you become aware of potential T-DAC problems. *Warnings* relate to personal injury issues, and *Cautions* refer to potential property damage.

Note Calls attention to important information.



The shock hazard symbol and **WARNING** heading indicate a potential electric shock hazard. Strictly follow the warning instructions to avoid injury caused by electric shock.



The alert symbol and **WARNING** heading indicate a potential safety hazard. Strictly follow the warning instructions to avoid personal injury.



The shock hazard symbol and **CAUTION** heading indicate a potential electric shock hazard. Strictly follow the instructions to avoid property damage caused by electric shock.



The alert symbol and **CAUTION** heading indicate a potential hazard. Strictly follow the instructions to avoid property damage.

Typographical conventions used in this document

This section describes the typographical conventions and terms used in this guide.

General conventions

The procedures described in this manual use the following text conventions:

Table 1. General conventions

Convention	Meaning
Garamond blue type	Indicates a cross-reference hyperlink that points to a figure, graphic, table, or section heading. Clicking on the hyperlink jumps you to the reference. When you have finished reviewing the reference, click on the Go to Previous View button  in the Adobe® Acrobat® Reader toolbar to return to your starting point.
Futura bold type	Indicates the names of menu bar options.
<i>Italicized Futura type</i>	Indicates the names of options on pull-down menus.
Futura type	Indicates the names of fields or windows.

Table 1. General conventions

Convention	Meaning
Garamond bold type	Indicates the names of command buttons that execute an action.
< >	Angle brackets indicate function and keyboard keys, such as <SHIFT>, <CTRL>, <C>, and so on.
Are you ready?	All system messages and prompts appear in the Courier font as the system would display them.
% dir *.*	Bold Courier font indicates where the operator must type a response or command

Mouse conventions

The following conventions are used when describing mouse actions:

Table 2. Mouse conventions

Convention	Meaning
Left mouse button	This button refers to the primary or leftmost mouse button (unless you have changed the default configuration).
Right mouse button	This button refers the secondary or rightmost mouse button (unless you have changed the default configuration).
Point	This word means to move the mouse in such a way that the tip of the pointing arrow on the screen ends up resting at the desired location.
Click	Means to quickly press and release the left or right mouse button (as instructed in the procedure). Make sure you do not move the mouse pointer while clicking a mouse button.
Double-click	Means to press and release the same mouse button two times quickly
Drag	This word means to point the arrow and then hold down the left or right mouse button (as instructed in the procedure) as you move the mouse to a new location. When you have moved the mouse pointer to the desired location, you can release the mouse button.

Chapter 1 **Introduction**

Chapter contents

Model 3196RC iDSL T-DAC overview	17
Hardware overview	18
WAN	18
LAN	19
RS-232 control port	19
Power system	19
Central processing unit	19
iDSL ports	19
System timing	20
Temperature	20
Altitude	20
Humidity	20
Physical dimensions	20
Management services	20
LED display	21
Approvals	23

Model 3196RC iDSL T-DAC overview

The Model 3196RC (see [figure 2](#)) provides 16 iDSL subscriber ports and 4, 8, 12, or 16 T1/E1 WAN uplink ports. A built-in digital cross-connect switch provides completely flexible grooming; the capability to connect any DS0-channel to any other DS0-channel from the WAN uplink ports or the iDSL ports. The T-DAC combines a time-slot multiplexer and a centralized web-based management system on a front and rear blade for insertion in a rack with a CPCI mid-plane architecture. The front blade contains LED status indicators, an RS-232 configuration port and a 10/100 Ethernet management port. The rear blade contains the iDSL modem connections and WAN port connections. The 16 iDSL subscriber ports connect to compatible customer premise equipment modems for data rates up to 144 kbps over a single pair. The WAN links accept channelized T1 or E1 network connections.

Each iDSL port requires only a single twisted pair (2-wires) for full-duplex data transmission at ranges in excess of 9 km (24 AWG). TC-PAM line encoding ensures spectral compatibility within existing voice/data bundles. Each WAN port terminates T1/E1 with flexible any-to-any DS0 mapping. The entire system can be managed in-band (via T1/E1 Frame Relay/PPP links) or out-of-band from a web browser by means of SNMP/HTTP-based management screens.

The Model 3196RC connects 16 iDSL remote NTUs or modems at data-rates up to 144 kbps to digital (ATM/FR/DDN/IP) networks, thus permitting multi-service access to CLECs, ISPs, and PTTs.

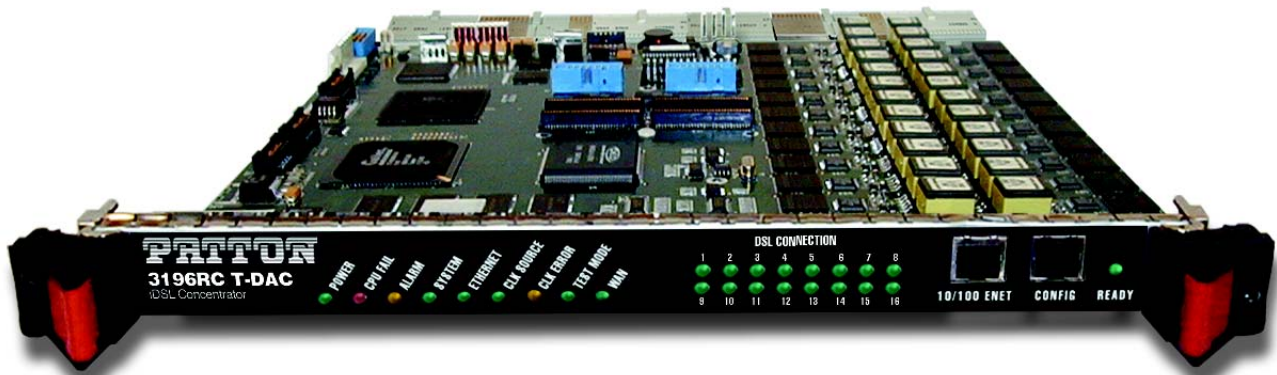

Figure 2. Model 3196RC T-DAC

Hardware overview

The Model 3196RC combines transmission and networking technology concentrating 16 iDSL ports and 4 to 16 T1/E1 WAN links into a single slot blade for a standard CPCI chassis. The T-DAC front blade (see [figure 3](#)) contains a full set of LED status indicators presented on the front panel, and an RS-232 async control port. The rear blade presents electrical connections for the iDSL modems and WAN ports as well as an alarm LED.

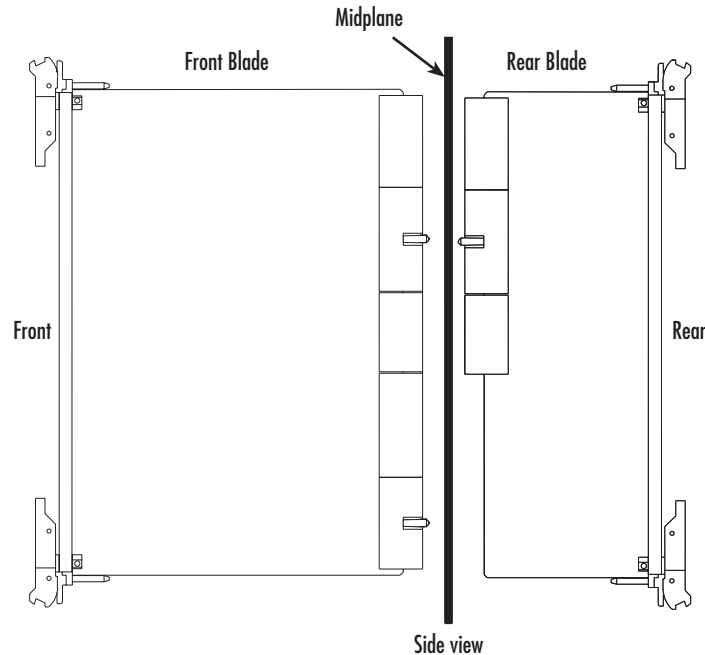

Figure 3. Model 3196RC T-DAC features

WAN

The 3196RC includes four, eight, twelve, or sixteen WAN uplink ports selectable for T1 or E1 operation. The WAN uplink ports may be connected to ATM/FR/DDN/ IP network backbones and are accessible via the 68-pin SCSI connector. Also included are:

- Four to sixteen built-in T1/E1 CSU/DSUs
- T1 1.544 Mbps with D4 or ESF framing, AMI or B8ZS line coding, FCC part 68 compliant
- E1 2.048 Mbps multi-framing with or without CRC4 framing, AMI/HDB3 line coding, CTR-12, and CTR-13 compliant
- Built-in fuses and surge protectors

LAN

The 10/100-Mbps Ethernet LAN port is presented on an RJ-45 connector with an auto-sensing/full-duplex 10Base-T or 100Base-T interface. Also included are:

- 100Base-TX half-/full-duplex operation (100 + 100)
- 10Base-T half-/full-duplex operation (10 + 10)
- Auto detection and fallback
- 10/100 Mbps link and status indicators

RS-232 control port

The RS-232 port provides for initial configuration of the Model 3196RC. The RS-232 port supports:

- Asynchronous data rates of 19.2 kbps, 8 data bits, no parity, 1 stop bit.
- An RJ-45 connector with EIA-561 pinouts
- A management interface that supports VT-100 terminals
- Hardware flow control (RTS and CTS)

Power system

The 3196RC obtains power from the CPCI chassis via PCMG 2.11 47-pin power connectors on the front and rear blade. Total power consumption is a maximum of 43 Watts, provided by modular power supplies installed in the CPCI chassis.

Central processing unit

The 3196RC employs an Intel i960VH RISC processor operating at 100 MHz/100 Mips. The CPU controls the memory, front/back-panel and management interface for iDSL port/WAN time slot mapping, local switching, loopback and the management system. The memory holds:

- 4 MB Flash ROM
- 8 MB EDO DRAM

iDSL ports

The 16 iDSL ports operate at data-rates up to 144 kbps and are accessible via the RJ-21X 50-pin Telco connector. Each port uses one twisted-pair (2-wires) for full-duplex communication. The iDSL ports can be concentrated into TDM data output on the WAN ports. Other features include:

- Line encoding defined by iDSL
- “Plug-and-Play” automatic configuration between the multiplexer and the CPE modems
- Built-in surge protection
- Configuration parameters and line status indicators accessible to upper-level utility or application software

System timing

The iDSL T-DAC's system timing may be derived from an internal clock from an on-board chip, a CPE iDSL modem, a network clock from one of the T1/E1 WAN ports, or an external 64-kHz BITS (building integrated timing supply) reference clock.

The system timing is configured through the NMS.

Temperature

Operating range: 32–104°F (0–40°C)

Altitude

Maximum operating altitude: 15,000 feet (4,752 meters)

Humidity

5 to 95% relative humidity (RH), non-condensing

Physical dimensions

- 1.75 inches (4.44 cm) height, standard 19-inch (48.26 cm) width, 12-inch (30.48 cm) depth
- Weight: 8.94 lbs (20.12 kg)

Management services

- Out-of-Band RS-232 configuration port for management and control
- SNMP version 1 configuration management
- MIB II
- TELNET via Ethernet
- SYSLOG Client
- Remote Software Upgrade via FTP/TFTP
- Built-in HTTP server for complete configuration and control using a standard web browser
- Frame Relay or PPP in-band management via T1/E1 DS0s.

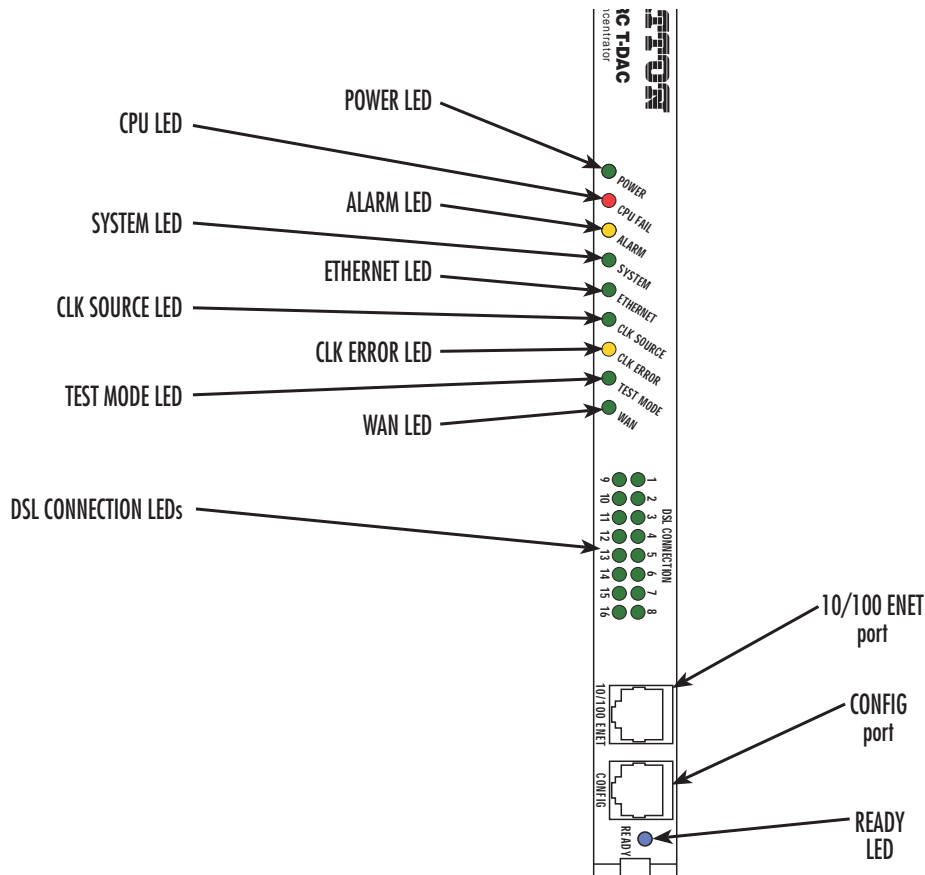

Figure 4. Model 3196RC front panel LEDs

LED display

Front panel LEDs (figure 3) display the status of the WAN ports, the iDSL ports, the Ethernet LAN port, power, and the alarms. The LEDs are described in table 3.

Table 3. LED definitions

LED	Color	Status	Meaning
POWER	Green	On solid	Power is being applied. No action recommended.
		Flashing	The 3196RC has detected a power failure on a power bus.
		Off	No input power is being applied.
CPU FAIL	Red	On solid	CPU is unable to load the software from FLASH to RAM for operation.
		Off	The CPU is operating normally.
ALARM	Yellow	On solid	A minor alarm condition has been detected.
		Flashing	A major alarm condition has been detected.
		Off	The Model 3196RC is operating normally.
SYSTEM	Green	Flashing	The Model 3196RC is operating normally.
		Off	The Model 3196RC is not functioning properly.
ETHERNET	Green	On solid	Link status is nominal for the Ethernet port. No action recommended.
		Off	A valid link has not been detected.

Table 3. LED definitions (Continued)

LED	Color	Status	Meaning
CLK SOURCE	Green	On solid	The 3196RC is set as the Master Clock source.
		Flashing	The 3196RC is set as the secondary clock source.
		Off	The 3196RC is set as the slave, getting its clock from the H.110 Bus.
CLK ERROR	Yellow	On solid	Master Clock source has been lost and the 3196RC is using the secondary source for its clock.
		Flashing	Master Clock source and the Secondary Clock source have been lost and the 3196RC is using its internal crystal for its clock.
		Off	No clock errors currently detected.
TEST MODE	Green	On solid	One or more iDSL ports or T1/E1 ports is in test mode.
		Flashing	One or more of the iDSL ports or the T1/E1 ports is in test mode and errors have been received.
		Off	None of the iDSL ports is operating in test mode.
WAN ^a	Green	On solid	Indicates the given port is activated, linked, and operating normally.
		Single Flash	Indicates that the Model 3196RC is detecting the network, but is unable to synchronize with it.
		Double Flash	Indicates an error on any of the T1/E1 links.
		Off	Indicates no T1/E1 links are in use.
DSL CONNECTION (LEDs 1–16)	Green	On solid	The port is activated, linked, and operating normally.
		Flashing	The port is activated but not linked or in an error state.
		Off	The iDSL port has not been configured to establish a link.
READY	Blue	On	Card ready for removal from cPCI chassis.
		Off	Card not ready for removal from cPCI chassis.

a. The WAN LED provides status indications for the WAN links established via the T1/E1 ports on the rear blade of the 3196RC.

Approvals

The Model 3196RC T-DAC has achieved the following approvals and certifications:

- Safety
 - UL 60950
 - Industry Canada CSA C22.2 No. 60950
- RTTE Directive (CE Mark)
 - EMC Directive 89/336/EEC
 - Low Voltage Directive 73/23/EEC (EN 60950)
 - ETSI CTR 12
 - ETSI CTR 13
- EMC
 - FCC Part 15, Subpart B, Class A
- Telecom
 - FCC Part 68
 - Industry Canada CS-03

Chapter 2 **Hardware installation**

Chapter contents

Introduction.....	25
Unpacking the Model 3196RC T-DAC.....	25
T-DAC blades installation.....	25
Cable installation.....	27
Connecting the Ethernet ports	27
Connecting the 10/100Base-T Ethernet port to an Ethernet switch or hub	27
Connecting the 10/100Base-T Ethernet port to an Ethernet-capable workstation or PC	28
Connecting the EIA-561 RS-232 configuration port (DCE configured)	28
Connecting to the T1/E1 WAN ports	29
Connecting the iDSL ports	31
Connecting the BITS clock	32
Completing the hardware installation.....	34

Introduction

This chapter contains the following procedures for installing the Model 3196RC T-DAC:

Note Before installing the T-DAC, you will need to obtain the line type and encoding of the T1/E1 line from your local telephone company (Telco).

- “Unpacking the Model 3196RC T-DAC”—lists the contents in the T-DAC shipping container
- “T-DAC blades installation”—describes installing the T-DAC on a flat surface or in a standard 19-inch rack
- “Cable installation” on page 27—describes installing the power and network interface cables
- “Completing the hardware installation” on page 34—describes testing the T-DAC hardware to verify that it is ready for software configuration

Unpacking the Model 3196RC T-DAC

Inspect the shipping carton for external damage. Note any damage before removing the container contents. Report equipment damage to the shipping carrier immediately for claim purposes. Save all packing materials in case you need to return an item to the factory for servicing.

The T-DAC comes with the following items:

- The Model 3196RC Digital Cross-Connect (T-DAC)
- One RJ45-to-RJ45 cable for use with the console and Ethernet ports
- A DB9-RJ45 (EIA-561) adapter for connecting a PC’s serial port to the T-DAC console port

T-DAC blades installation

Do the following:

Note Verify that the rack chassis is properly grounded before installing the T-DAC blades. An adequate ground can be achieved by connecting a #10 AWG ground wire between the rack chassis grounding stud and one of the following ground sources:

- The building ground rod (generally located at the site’s main service entrance)
- A sprinkler system pipe
- A cold-water pipe
- Building structural steel

1. If you have not done so already, remove the T-DAC from its shipping container.

Note Be sure to wear the anti-static strap to prevent electrostatic damage to the blade.

Note The T-DAC should be installed as close as possible to the termination jack provided by the Telco. The location should be well ventilated. Do not block the rack chassis' cooling vents.

2. Insert the rear blade into the desired slot in the rack chassis. Make sure the blade is seated properly in the slot guides.

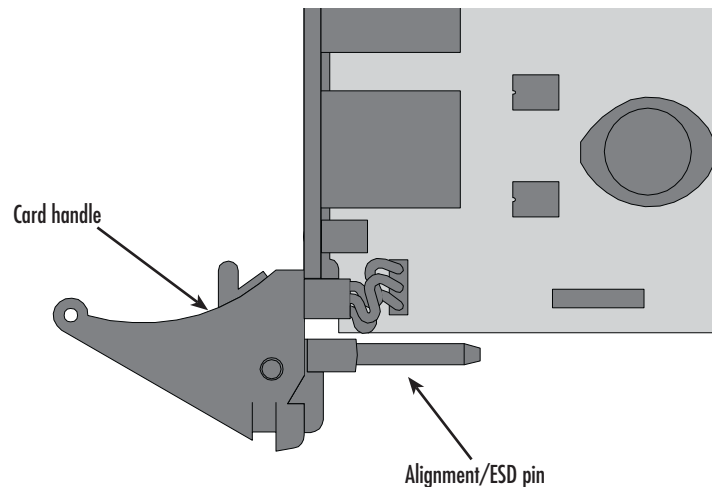

Figure 5. Alignment/ESD pin and card handle

3. Gently press the blade into the chassis until the alignment/ESD pin (see [figure 5](#)) engages the chassis. When the blade is fully seated, the red buttons in the handles click up automatically, thus locking the handle and activating the switch (closed position). The click of the button gives a visual and audible confirmation that the board is fully seated.
4. Insert the front blade into the rack chassis slot that corresponds to the slot in which you installed the rear blade. Verify that the buttons in both handles click up to indicate that the board is fully seated and locked into place.

Cable installation

This section describes installing the network interface cables.

Connecting the Ethernet ports

The T-DAC has a single 10/100 Ethernet interface for connection to your LAN (figure 6). The Ethernet port will autosense the correct speed of the local LAN and automatically negotiate half or full-duplex operation. This section describes connecting the T-DAC to the Ethernet LAN via an Ethernet hub, switch, or workstation.

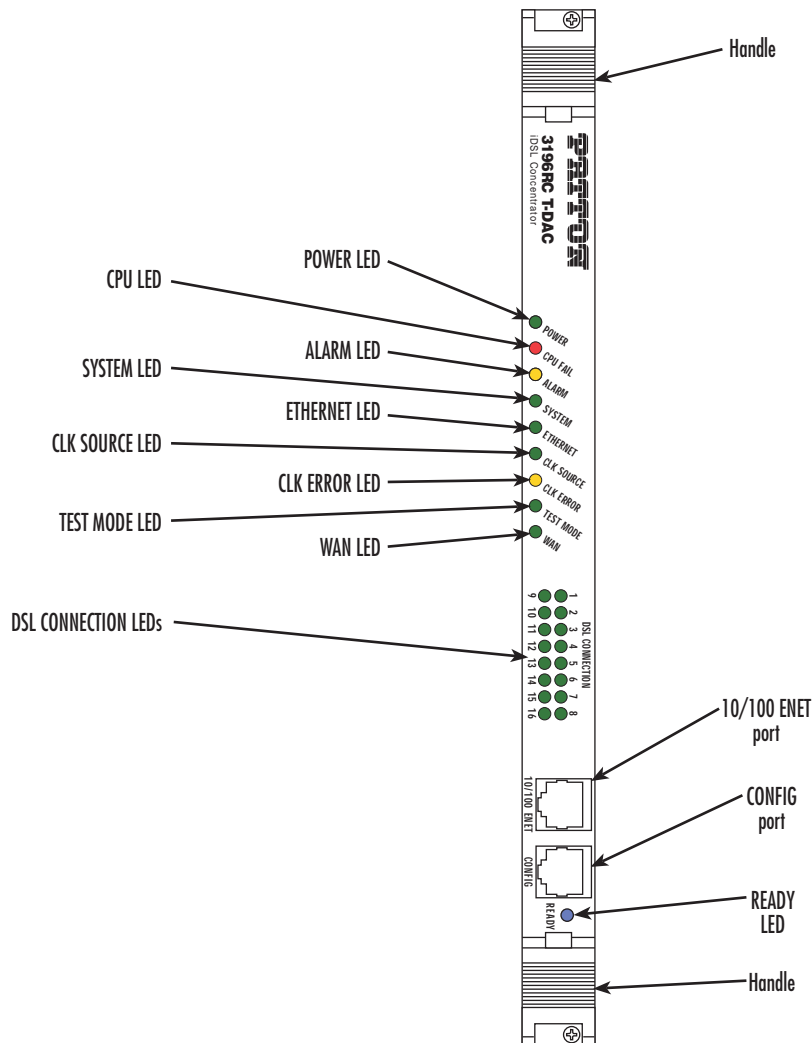

Figure 6. Model 3196RC network and configuration ports

Connecting the 10/100Base-T Ethernet port to an Ethernet switch or hub

The 10/100Base-T Ethernet port (see figure 5) is designed to connect to an Ethernet switch or hub. The Ethernet RJ-45 pin and signal definitions for the T-DAC or for a NIC card in a workstation/PC are shown in figure 7 on page 28. Connect a straight-through CAT-5 cable (one wired as shown in figure 7) between the T-DAC and the hub/switch.

DACS RJ-45 Jack	Signal Name	Direction
 1	(TX+) Transmit Data +	Output
2	(TX-) Transmit Data -	Output
3	(RX+) Receive Data +	Input
4		
5		
6	(RX-) Receive Data -	Input
7		
8		

Figure 7. Ethernet RJ-45 pin and signal definitions for T-DAC

Connecting the 10/100Base-T Ethernet port to an Ethernet-capable workstation or PC

The 10/100Base-T Ethernet port can connect to a single Ethernet-capable workstation or PC by means of a cross over cable. Refer to figure 8 to assemble a cross-connect cable that will connect between the NIC Ethernet port in the workstation and the T-DAC 10/100Base-T Ethernet port.

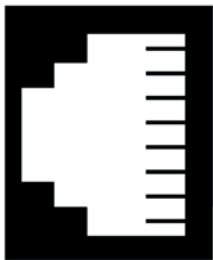
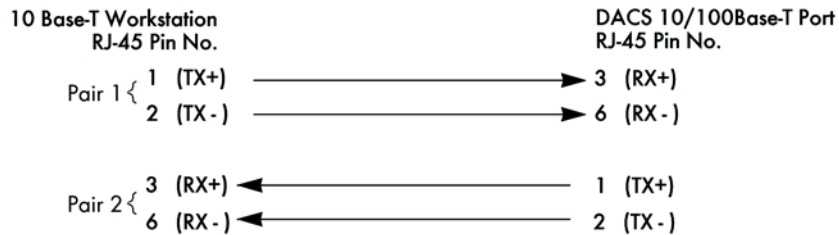
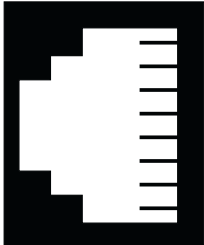

Figure 8. Cross-over RJ-45-to-RJ-45 Ethernet cable diagram

Connecting the EIA-561 RS-232 configuration port (DCE configured)

Install the supplied RJ-45-to-RJ-45 cable with the DB9-RJ45 adapter between the T-DAC RS-232 port (see figure 6 on page 27) and an open serial port on your computer. If you need to assemble your own cable, refer to the pinout diagram in figure 9.

RJ-45 Jack	DB-9	Signal Name
 1	6	DSR
2	1	CD
3	4	DTR
4	5	SG
5	2	RD (driven by DACS)
6	3	TD (received by DACS)
7	8	CTS (driven by DACS)
8	7	RTS (received by DACS)

} Wired together
(No other electrical connection)

Figure 9. DB-9-to-RJ-45 cable diagram

Connecting to the T1/E1 WAN ports

An active T1/E1 is not necessary to configure the T-DAC. However, an active T1/E1 connection is required when mapping iDSL modems to specific time slots in the T1/E1 ports or even for mapping WAN time slots to other WAN time slots. The factory-set default configuration of the Model 3196RC has the T1/E1 ports disabled.

Note The cable connecting the T1/E1 WAN ports to the RJ-48C termination jack should be CAT-3 or higher and extend no farther than 1 mile (1.6 km) from the digital services termination.

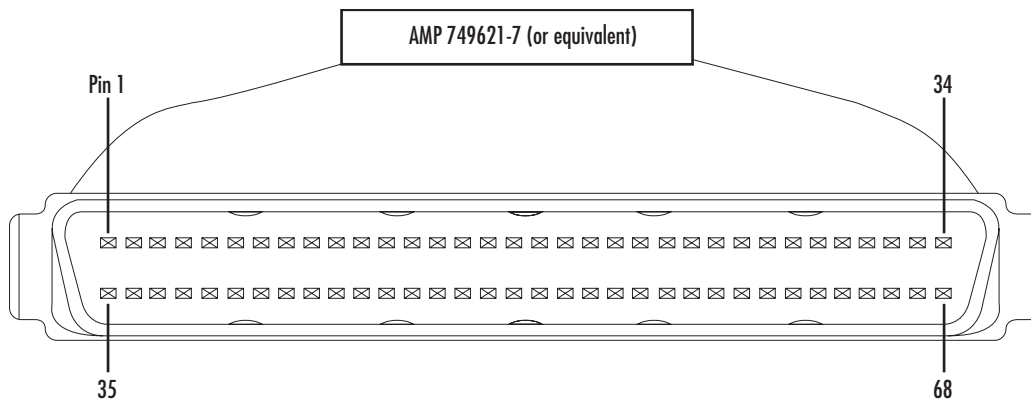

Figure 10. WAN cable's 68-pin SCSI connector

1. Connect the 68-pin SCSI connector (see [figure 10](#)) of the 6-foot WAN cable (see [figure 11](#)) to the connector on the rear panel of the Model 3196RC

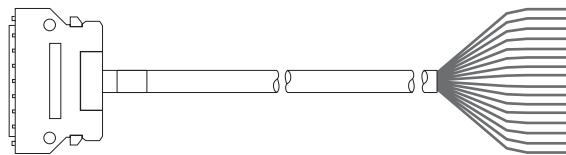

Figure 11. 68 pin SCSI-to-RJ45 6-foot WAN cable

- The other end of the cable has 68 non-terminated twisted-pairs for connection to a punch-down block (see [table 4](#)). Select the twisted pairs for the WAN ports that will be activated and terminate them on the punch-down block.

Table 4. WAN cable's 68 non-terminated twisted-pairs

Port/Direction	Pairs	68 Pin Positions	Wire Color Code
Port 1/TX	1	1 35	White/Tan Tan/White
Port 1/RX	2	2 36	White/Brown Brown/White
Port 2/TX	3	3 37	White/Pink Pink/White
Port 2/RX	4	4 38	White/Orange Orange/White
Port 3/TX	5	5 39	White/Violet Violet/White
Port 3/RX	6	6 40	White/Blue Blue/White
Port 4/TX	7	7 41	White/Yellow Yellow/White
Port 4/RX	8	8 42	White/Green Green/White
Port 5/TX	9	9 43	White/Gray Gray/White
Port 5/RX	10	10 44	Tan/Brown Brown/Tan
Port 6/TX	11	11 45	Tan/Pink Pink/Tan
Port 6/RX	12	12 46	Tan/Orange Orange/Tan
Port 7/TX	13	13 47	Tan/Violet Violet/Tan
Port 7/RX	14	14 48	Tan/Blue Blue/Tan
Port 8/TX	15	15 49	Tan/Yellow Yellow/Tan
Port 8/RX	16	16 50	Tan/Green Green/Tan
	—	33 67	NOT USED

Port/Direction	Pairs	68 Pin Positions	Wire Color Code
Port 9/TX	17	17 51	Tan/Gray Gray/Tan
Port 9/RX	18	18 52	Brown/Pink Pink/Brown
Port 10/TX	19	19 53	Brown/Orange Orange/Brown
Port 10/RX	20	20 54	Brown/Violet Violet/Brown
Port 11/TX	21	21 55	Brown/Blue Blue/Brown
Port 11/RX	22	22 56	Brown/Yellow Yellow/Brown
Port 12/TX	23	23 57	Brown/Green Green/Brown
Port 12/RX	24	24 58	Brown/Gray Gray/Brown
Port 13/TX	25	25 59	Pink/Orange Orange/Pink
Port 13/RX	26	26 60	Pink/Violet Violet/Pink
Port 14/TX	27	27 61	Pink/Blue Blue/Pink
Port 14/RX	28	28 62	Pink/Yellow Yellow/Pink
Port 15/TX	29	29 63	Pink/Green Green/Pink
Port 15/RX	30	30 64	Pink/Gray Gray/Pink
Port 16/TX	31	31 65	Orange/Violet Violet/Orange
Port 16/RX	32	32 66	Orange/Blue Violet/Blue
	—	34 68	NOT USED

Connecting the iDSL ports

The remote (CPE) iDSL modems are connected to the T-DAC via the RJ-21X cable (see figure 12).

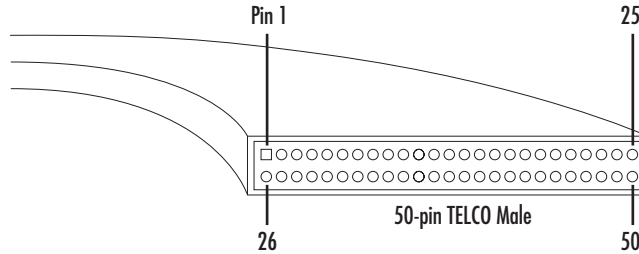

Figure 12. RJ-21X connector

1. Connect the RJ-21X connector of the cable into the 50-pin RJ-21X receptacle on the rear of the 3196RC.
2. The other end of the cable has 25 non-terminated twisted-pairs for connection to punch-down blocks. Only 16 of the 25 pairs (see table 5) will be used since there are 16 iDSL modem connections, each requiring one twisted pair. Select the twisted-pairs which will be used for active iDSL modem connections and terminate each pair on the punch-down blocks.

Table 5. Band Marked Color Code

DSL Port	50 Pin Positions	Wire Color Code
Port 1	1	Blue/White
	26	White/Blue
Port 2	2	Orange/White
	27	White/Orange
Port 3	3	Green/White
	28	White/Green
Port 4	4	Brown/White
	29	White/Brown
Port 5	5	Slate/White
	30	White/Slate
Port 6	6	Blue/Red
	31	Red/Blue
Port 7	7	Orange/Red
	32	Red/Orange
Port 8	8	Green/Red
	33	Red/Green
Port 9	9	Brown/Red
	34	Red/Brown
Port 10	10	Slate/Red
	35	Red/Slate
Port 11	11	Blue/Black
	36	Black/Blue

Table 5. Band Marked Color Code (Continued)

DSL Port	50 Pin Positions	Wire Color Code
Port 12	12	Orange/Black
	37	Black/Orange
Port 13	13	Green/Black
	38	Black/Green
Port 14	14	Brown/Black
	39	Black/Brown
Port 15	15	Slate/Black
	40	Black/Slate
Port 16	16	Blue/Yellow
	41	Yellow/Blue
	17	Orange/Yellow
	42	Yellow/Orange
	18	Green/Yellow
	43	Yellow/Green
	19	Brown/Yellow
	44	Yellow/Brown
	20	Slate/Yellow
	45	Yellow/Slate
	21	Blue/Violet
	46	Violet/Blue
	22	Orange/Violet
	47	Violet/Orange
	23	Green/Violet
	48	Violet/Green
	24	Brown/Violet
	49	Violet/Brown
	25	Slate/Violet
	50	Violet/Slate

Note The 2-wire iDSL modem lines are polarity insensitive so you only need to match the correct *pair* of wires to the correct *pair* of terminals on the punch-down block.

3. Select and attach the appropriate twisted pair from each remote (CPE) iDSL modem on punch-down blocks for connection to the chosen iDSL port in the 3196RC.

Connecting the BITS clock

The ForeFront system can accept and synchronize with an external reference clock signal provided by a building integrated timing system (BITS) residing at the installation site. The BITS clock signal is specified by ITU-T Recommendation G.703 as a balanced, polarity-insensitive, 64kbps signal with a maximum voltage of 2.2 V_{pp}.

Note To synchronize the ForeFront system with a BITS clock, you must connect the site BITS clock system to the *EXT CLOCK* connector located on the rear-panel of the T-DAC WAN Access Module rear card (see figure 13).

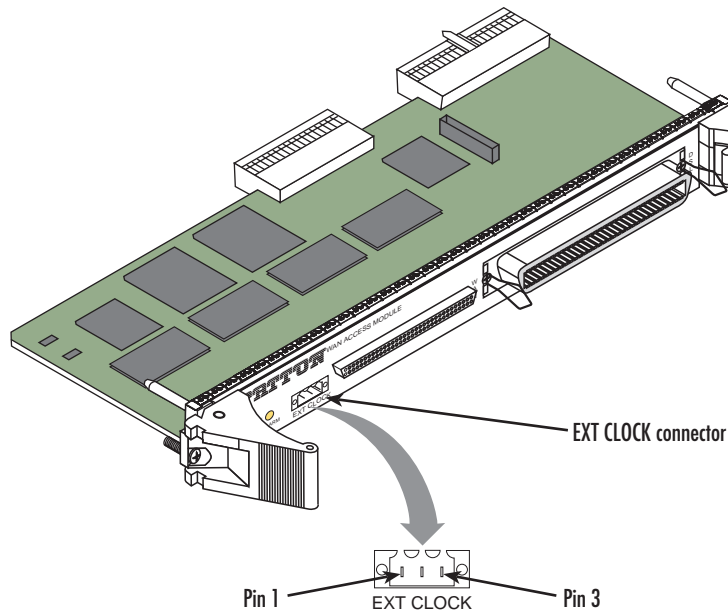

Figure 13. EXT CLOCK connector location

Do the following to connect the WAN Access Module card's *EXT CLOCK* connector to the BITS clock:

1. The *EXT CLOCK* connector is a 3-pin terminal block connector (see figure 13). As you face the rear-panel, pin 1 is located at the top (vertical card orientation) or left (horizontal card orientation). Table 6 lists the connector pinout.

Table 6. EXT CLOCK connector pinout

Pin	Description
1	Negative input
2	Positive input
3	Chassis ground

2. Plug the connector on the end of the BITS clock cable into the *EXT CLOCK* connector. Tighten the captive screws to secure the connector.

Completing the hardware installation

This section verifies that the T-DAC hardware is operational to the point where you can begin configuring the software settings.

Power is delivered from the CPCI chassis backplane through the 47-pin PICMG 2.11 power connectors on the 3196RC blades. Upon insertion into the CPCI chassis, the Model 3196RC immediately powers up and begins its boot cycle. During the boot cycle the following should occur:

1. The POWER LED illuminates, indicating normal power is being applied to the 3196RC.
2. The green SYSTEM LED begins flashing, indicating the 3196RC is operating normally.

Hardware installation is now complete. To configure the 3196RC for operation, refer to chapter 3, “[Configuring the T-DAC for operation](#)” on page 35.

Chapter 3 **Configuring the T-DAC for operation**

Chapter contents

Introduction	36
Configuration prerequisites	36
Initial configuration through the RS-232 control port.....	37
Connecting the DB9-RJ45 adapter with the included cable	37
Setting up the HyperTerminal (or similar program) session	38
Using a browser to complete Model 3196RC configuration	41
Displaying the T-DAC 3196RC web administration pages	41
Home page overview	42
Configuring the default gateway	44
Configuring the system clocking parameters	45
Configuring the DS0 mapping	47
Examples for configuring static connections.	49
Activating the iDSL ports	54
Configuring Patton iDSL CPE device remotely via the Model 3196RC	54
Configuring line settings and signaling for E1	57
Accessing the Line Interface Settings	57
Configuring the E1 line interface settings	58
Configuring line settings and signaling for T1	60
Accessing the Line Interface Settings	60
Configuring the T1 line settings	61
Saving your configuration.....	63
Backing up your configuration parameters.....	63
Backing up the configuration store in flash memory	65
Completing the installation	66

Introduction

This chapter contains the following procedures that describe configuring the Model 3196RC T-DAC for operation:

- “[Configuration prerequisites](#)”—lists the items you need to have on hand before configuring the T-DAC.
- “[Initial configuration through the RS-232 control port](#)” on page 37—describes how to define the 3196RC’s LAN IP address and netmask parameters.
- “[Using a browser to complete Model 3196RC configuration](#)” on page 41—describes how to define the remaining basic configuration parameters in order to bring your T-DAC on-line. The steps are:
 - Defining static connections with DS0 mapping (see [page 47](#))
 - Configuring the system clocking parameters (see [page 45](#))
 - Defining the IP default gateway (see [page 44](#))
 - Defining E1 WAN link parameters (see “[Configuring line settings and signaling for E1](#)” on page 57) or T1 WAN link parameters (see “[Configuring line settings and signaling for T1](#)” on page 60)
- “[Saving your configuration](#)” on page 63—describes how to save your configuration settings.
- “[Backing up your configuration parameters](#)” on page 63—describes how save your configuration parameters to a file
- “[Completing the installation](#)” on page 66—describes how to verify that your 3196RC T-DAC is fully operational.

Configuration prerequisites

You will need the following to configure the 3196RC T-DAC:

- A PC equipped with the following:
 - RS-232/V.24 serial port
 - VT-100 terminal program, e.g., HyperTerminal
 - Ethernet port
 - Web browser (e.g., Netscape Communicator or Microsoft Internet Explorer)
- You will need the following information to configure the Model 3196RC:
 - The IP address and subnet mask for the 3196RC’s Ethernet port
 - The IP address of the default gateway
 - The 3196RC iDSL port number to which each customer premises equipment (CPE) iDSL modem will be connecting.
 - A mnemonic naming convention scheme for your iDSL circuit IDs (optional).
 - The data rate at which each CPE iDSL will be operating
 - The final destination port of the CPE’s iDSL modem connection (WAN time slots or another iDSL port, for example,).

- If you are using a T1 WAN line, you will need the following information from the telephone company (central office):
 - Line Type: either ESF or D4
 - Line Coding: either B8ZS or AMI
- If you are using a E1 WAN line, you will need the following information from the Telco:
 - Line Type: either E1 or E1-CRC
 - Line Coding: either HDB3 or AMI

Initial configuration through the RS-232 control port

Initially you must configure the 3196RC's IP address and—in rare instances—change the netmask from the default settings.

Note Do *not* connect power or the Ethernet connection to the Model 3196RC at this time.

Connecting the DB9-RJ45 adapter with the included cable

Do the following:

1. Find the DB9-RJ45 adapter for your PC and RJ-45-to-RJ45 cable shipped with your 3196RC T-DAC.
2. Connect the DB9-RJ45 adapter to your PC's RS-232 serial port.
3. Connect the RJ45-RJ45 cable between the adapter which you installed in step 1 and the *RS-232 Config* port on the front of the Model 3196RC (see [figure 14](#)).

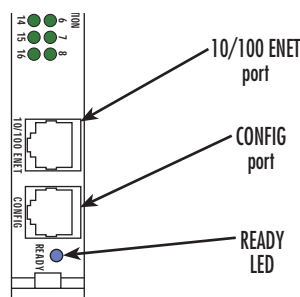

Figure 14. Model 3196RC interface ports

Setting up the HyperTerminal (or similar program) session

Do the following:

1. At your PC, find the file *HYPERTRM.EXE*. Open a HyperTerminal session by double-clicking on the file name.



Figure 15. Connection Description window

2. Type a connection name (e.g., *3196RC Config*), select an icon, then click **OK** (figure 16).



Figure 16. Connect To window

3. On the *Connect To* window (figure 16), set *Connect using:* to one of the options named *Direct to ComX* (where the “X” refers to the number identifying the RS-232 serial port on the PC). In the following procedure, *Com1* will be the used as the port identifier.
4. Click **OK**.
5. The *COM1 Properties* window displays.

- Configure your COM port settings as shown in figure 17, then click **OK**.

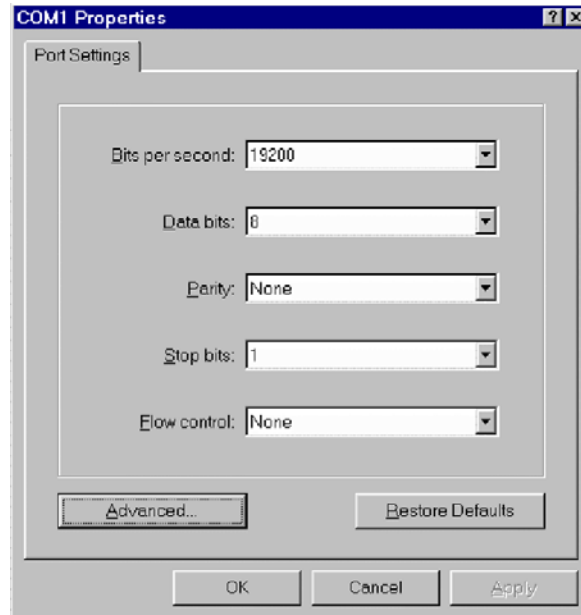

Figure 17. COM1 Properties window

- Click on the **File** menu, then select *Properties*.
- Configure the settings for *Function, arrow and ctrl keys act as to Terminal keys* as shown in figure 18, then click **OK**.

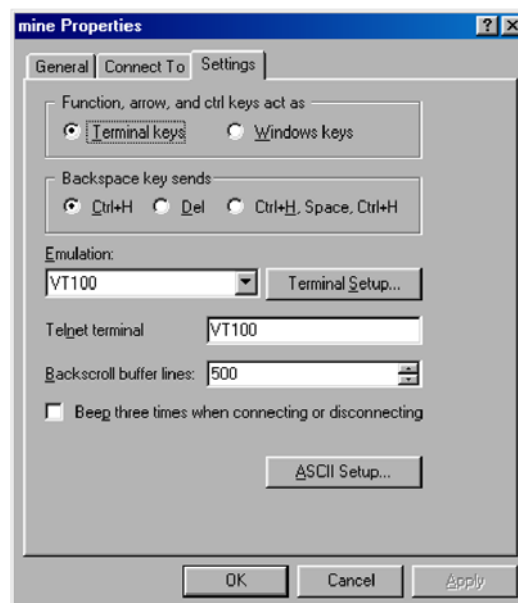

Figure 18. Terminal keys configuration

9. Connect the male end of the 3196RC T-DAC' power cables to the power outlets.
10. Boot up information will display on your HyperTerminal connection window, eventually followed by a login request window (see figure 19).

```

Patton Electronics Company

Software Revision 3.0.3 May 19 2000 16:48:45

Username: _

```

Figure 19. Login window

11. For the user name, type **superuser**.
12. For the password, type **superuser**; the TOP LEVEL MANAGEMENT window then appears (see figure 20).

```

TOP LEVEL MANAGEMENT
-----
a  HOME
b  ALARMS
c  DSP MAPPING
d  Clocking
e  iDSL
f  Ethernet
g  ICMP
h  IP
i  RIP Version 2
j  SNMP
k  System
l  System Log
m  T1/E1 Link
n  TCP
o  UDP
p  About
q

Please Enter a selection
>

```

Figure 20. VT-100 Top Level Management window

13. Type **k** for System, then press **<Enter>**.
14. Under System, type **1** for Details, then press **<Enter>**.
15. Enter **g** for LAN Address, then press **<Enter>**.
16. Type your LAN IP address followed by pressing **<Enter>**.
17. Press the left-arrow cursor key on your keyboard to return to the previous screen.
18. If you do not need to change the LAN Mask from the default of 255.255.255.0, go to step 21. Otherwise, press **h** and type the new LAN Mask in the same manner as when entering a LAN IP address.

19. Press the left-arrow cursor key until the TOP LEVEL MANAGEMENT window displays.
20. Select **a** for *Home*, then press **<Enter>**.
21. Under the *Current Status* page, type **1** (*store Config(1)*) to save the changes you have just made to the configuration.

This completes the initial configuration of the Model 3196RC. The next steps in configuration will be done using your Web browser connected via Ethernet to the 3196RC.

Using a browser to complete Model 3196RC configuration

This section describes the following procedures:

- Displaying the T-DAC home page (see “Displaying the T-DAC 3196RC web administration pages” on page 41)
- Setting static connections with DS0 mapping (see “Configuring the DS0 mapping” on page 47)
- Setting the system clocking parameters (see “Configuring the system clocking parameters” on page 45)
- Configuring the IP default gateway (see “Configuring the default gateway” on page 44)
- Configuring the T1/E1 WAN links (see “Configuring line settings and signaling for E1” on page 57 or “Configuring line settings and signaling for T1” on page 60)

Displaying the T-DAC 3196RC web administration pages

Do the following:

1. Connect your PC's Ethernet connection to the Ethernet LAN.
2. Connect the 3196RC's T-DAC 10/100 Ethernet connection to the Ethernet LAN.
3. At your PC, open a Web browser session. In your browser's URL/address field type the IP address of the Model 3196RC (for example, if the Model 3196RC's IP address *123.124.221.10*, you would type **123.124.221.10** in the browser's URL/address field). If you do not have an IP address in your TDAC, refer to “Initial configuration through the RS-232 control port” on page 37.
4. A login prompt will appear. In the username field type **superuser** then press **<Tab>** to move the cursor to the Password field. In the password field type **superuser** then press **<Enter>**.

5. The 3196RC Configuration Menu home page will appear (see figure 21).

3196RC CONFIGURATION MENU

Patton Home Page

PATTON
Electronics Co.

Model 3196RC TDM Digital Access Concentrator
Software Revision 1.0.14a Jul 10 2003 17:08:45

STATUS OF T-DAC

Number of Egress Ports:	8
Shelf Address:	31
Slot ID:	7
% CPU Idle:	97
Running Since Last Boot:	57 days 03:41:00 hours
Current Blade State	Clear
Total System Alarms:	0

IMMEDIATE ACTIONS

Record Current Configuration

Hard Reset

Set Factory Default Configuration

HOME
Import/Export
System Status
System History
Alarms
DSO Mapping
System Clocking
iDSL
Ethernet
IP Filtering
Frame Relay
PPP
ICMP
IP
TCP
UDP
RIP Version 2
SNMP
System
System Log
T1/E1 Link
About
License

Figure 21. 3196RC Configuration Menu home page

Home page overview

The HOME window is divided into two panes: the Configuration Menu pane and the Configuration/information pane (see figure 22). The Configuration Menu contains the links to the various Model 3196RC subsystems, while in the Configuration/information pane, you can view status and other information or make changes to the system configuration. Unlike the Configuration Menu pane, which appears the same no matter which subsystem page you may select, the Configuration/information pane contents will change as you move from one subsystem page to another.

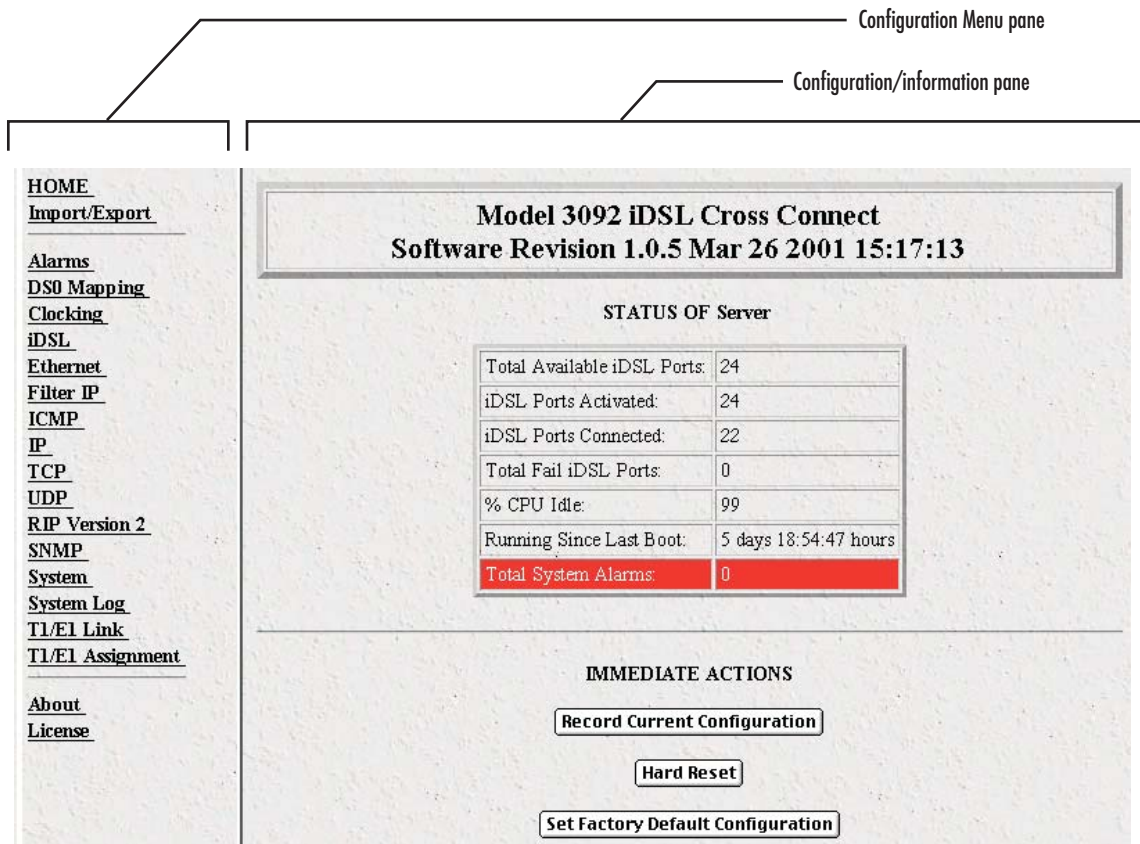

Figure 22. HOME page window panes

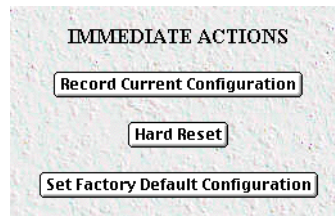

Figure 23. Immediate Actions buttons

From the Home page, the following actions can be performed:

- **Record Current Configuration**—clicking on this button (see [figure 23](#)) saves the current configuration from volatile DRAM memory to FLASH memory. Once the configuration is saved into FLASH memory, the configuration will not be lost even if the power is cycled on the 3196RC. Initially, changes made to the 3196RC configuration are stored in volatile DRAM, enabling the user to set the box up with a working configuration before committing it to storage in FLASH. When you select **Record Current Configuration**, the 3196RC stores your changes to FLASH memory.

Note If you want to save the configuration changes that you have made, you must click on **Record Current Configuration**, otherwise all con-

figuration changes will be lost if the power to the Model 3196RC is turned off.

- **Hard Reset**—this button (see [figure 23](#)) causes the Model 3196RC to perform a cold restart. When you select **Hard Reset**, the T-DAC confirms that you want to execute this command. Then, the T-DAC will disconnect all current sessions, re-initialize the interfaces, and re-load configuration parameters from FLASH.
- **Set Factory Default Configuration**—this button (see [figure 23](#)) clears out the configuration in FLASH and loads the factory default parameters into FLASH memory. The factory default settings will not execute on the Model 3196RC until it is re-booted by doing a Hard Reset.

Note **Set Factory Default Configuration** ([figure 23](#)) will delete any routing information, the Model 3196RC's Ethernet IP address, and any other site-specific settings made for your particular installation. You will have to re-enter the Model 3196RC's Ethernet IP address and net-mask using the rear panel control port before using the HTTP/HTML Management pages.

Configuring the default gateway

The default gateway IP address, if defined, is used solely for managing the 3196RC remotely via the Ethernet port. The 3196RC does not transmit or receive user data nor any other traffic via the default gateway IP address or the Ethernet port.

Do the following to add the default gateway:

1. On the *3196RC Configuration Menu*, click the *IP* hyperlink to open the **IP Configuration** page.
2. Click the *Routing Info* hyperlink to open the **IP Routing Information** page ([figure 24](#)).

The screenshot shows the 'IP ROUTING INFORMATION' page. At the top right is a 'T-DAC' button. Below it is a table with the following data:

Destination	Mask	Gateway	Cost	Interface	Protocol	State
10.10.0.0	255.255.0.0	0.0.0.0	1	1	local(1)	active(2)

Below the table is an 'Add a route:' section with three input fields for 'Destination', 'Mask', and 'Gateway', each followed by an 'Add Route' button. The first row has '0.0.0.0' in all three fields. Below this is an 'Advanced...' section with an 'Interface' field and an 'Add Route' button. The 'Interface' field has '0' entered.

At the bottom left, there is a link for 'OS forwarding table'.

Figure 24. IP Routing Information Page

3. The existing route you see in the table is the LAN IP address you assigned to the 3196RC during initial configuration through the RS-232 control port, earlier in this chapter.

4. To enter the default gateway, use the first **Add a route line**. The *Destination* shall remain *0.0.0.0*, and there is no mask to enter.
5. In the *Gateway* box, type your default gateway IP address for the 3196RC.
6. Click the **Add Route** button to save your configuration.

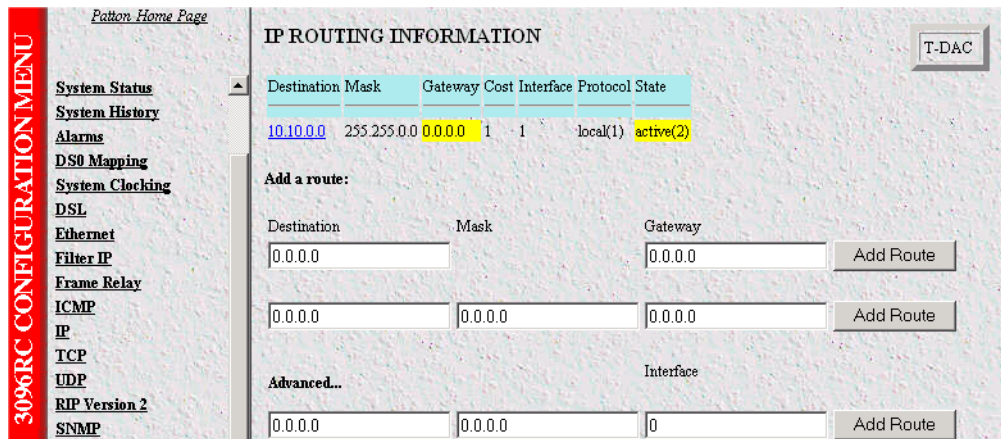

Figure 25. IP Routing Information window

7. The route which you already see in the table appeared upon the configuration of the LAN IP address.
8. To enter the default gateway, use the first *Add Route* line. The *Destination* shall remain as *0.0.0.0*. There is no mask to enter.
9. Enter the IP address in the Gateway box. This is the default gateway.
10. Click on the **Add Route** button.

Configuring the system clocking parameters

In this section you will define clocking sources for the main reference and fallback reference on the 3196RC TDAC. Clocking source selection will depend on the clocking role you assign to the blade: *master(1)*, *secondary(2)*, or *slave(3)*. The master will drive the main reference clock for the chassis. Should the master fail, the secondary will drive the main reference. Slaves will not drive any clock reference. Most often the 3196RC will be configured as *slave(3)*, with another blade (such as the Patton Model 6511) configured as the *master(1)*.

As clocking sources for the 3196RC, you can choose:

- Any one of the WAN ports
- An internal oscillator
- A WAN port from another blade module
- An external 64-kHz BITS (building integrated timing supply) reference clock

Note For the external BITS clock setting to operate, you must connect the BITS clock system at the installation site to the *EXT CLOCK* connector on one of the WAN access modules installed in the rear of the ForeFront chassis.

Unless it fails or becomes disconnected, the main reference provides the system clock for the 3196RC. Should this failure occur, the fallback reference will be the clocking source for the 3196RC's system clock.

Example 1

Your 3196RC is the only blade in the chassis and must be configured as the *system clocking master*. This example assumes you will use WAN port #1 as the main reference and WAN port #2 as the fallback reference. To define the clocking source, do the following:

1. Connect a T1/E1 WAN line to WAN port #1 through the 3196RC's WAN port cable.
2. Connect a T1/E1 WAN line to WAN port #2 through the 3196RC's WAN port cable.
3. Click the *System Clocking* hyperlink on the *3196RC Configuration Menu* to open the **System Clocking Configuration** page (see [figure 26](#)).

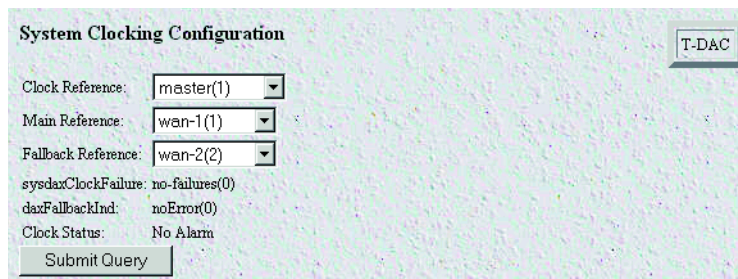

The screenshot shows a web-based configuration interface for the System Clocking Configuration. It features a title bar with 'System Clocking Configuration' and a 'T-DAC' logo. Below the title, there are several configuration fields, each with a dropdown menu and a small 'x' icon to the right. The fields are: 'Clock Reference' set to 'master(1)', 'Main Reference' set to 'wan-1(1)', and 'Fallback Reference' set to 'wan-2(2)'. Below these are three status fields: 'sysdaxClockFailure' set to 'no-failures(0)', 'daxFallbackInd' set to 'noError(0)', and 'Clock Status' set to 'No Alarm'. At the bottom of the form is a 'Submit Query' button.

Figure 26. System Clocking Configuration page, example 1

4. For *Clock Reference* select *master(1)*.
5. For *Main Reference* select *wan-1(1)*.
6. For *Fallback Reference* select *wan-2(2)*.
7. Click on the **Submit Query** button.
8. Select *enable(1)* to enable the fallback reference clock.
9. Click the **Submit Query** button.

Example 2

Another card such as the Patton Model 6511 is the clocking master and your 3196RC is a slave. This example assumes you will use the system clock as the main reference and WAN port #1 as the fallback reference. To define the clocking source, do the following:

1. Connect a T1/E1 WAN line to WAN port #1 through the 3196RC's WAN port cable.

- Click the *System Clocking* hyperlink on the *3196RC Configuration Menu* to open the **System Clocking Configuration** page (see [figure 27](#)).

Figure 27. System Clocking Configuration page, example 2

- For *Clock Reference* select *slave(3)*.
- For *Main Reference* select *system(500)*.
- For *Fallback Reference* select *wan-1(1)*.
- Click the **Submit Query** button.
- Select *enable(1)* to enable the fallback reference clock.
- Click the **Submit Query** button.

Configuring the DS0 mapping

You need to make internal connections between an iDSL modem link and its destination. The destination of an iDSL modem may be at the end of a T1 or E1 link, or another iDSL port. Each iDSL modem inside the 3196RC T-DAC is configured by selecting the number of DS0 time slots, each time slot being 64 kbps. You may choose to map from 1 to 3 DS0 time slots in the iDSL modem. The most common destination for the iDSL modems will be at the remote end of a T1/E1 WAN link.

The T-DAC's iDSL port can operate at speeds ranging from 19.2 kbps up to 144 kbps. The table below shows the number of timeslots required for each iDSL data rate.

Data Rate	Number of DS0 Timeslots Required
rate19.2k(0)	2
rate32k(1)	1
rate56k(2)	1
rate64k(3)	1
rate128k(4)	2
rate144k(5)	3

Note When an iDSL port is operating at the 19.2 kbps data rate, the iDSL modem uses 2 timeslots (2 DS0s) for data transmission. Therefore, when defining the DS0 mapping for any iDSL port operating at 19.2 kbps, you must define a 2-time slots connection.

The DS0 Mapping window (Digital Cross Connect Configuration) provides full DS0 grooming and supports three variations. You may define connections between (1) an iDSL modem and a WAN port, (2) two iDSL modems, or (3) two WAN time slots. (When no mapping is defined, neither the iDSL modems nor the WAN ports have any destination).

To define the DS0 Mapping for the iDSL modems, do the following:

1. On the Configuration Menu click *DS0 Mapping* hyperlink.
2. In the *DACS Display Type* drop-down menu (figure 28), select *displayLongForm(0)*.

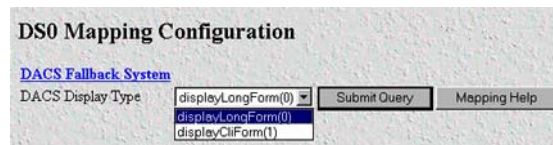

Figure 28. DS0 Mapping Configuration window

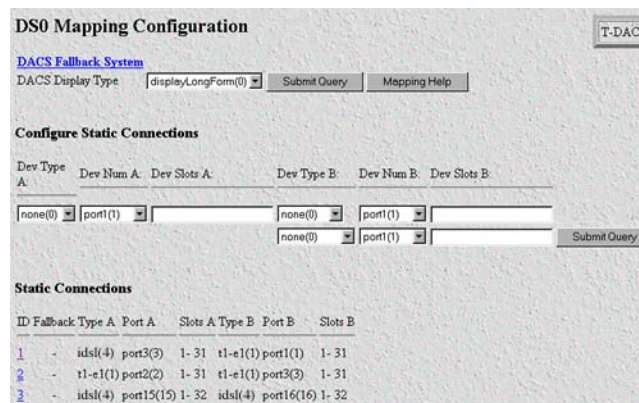

Figure 29. DS0 Mapping Configuration page

To define each DS0 Mapping you will create a static connection. “A” and “B” designate the two ends of the static connection. For each static connection you will define the following parameters:

- Device Type. Specifies the physical interface type for the connection. You may select either *t1-e1(1)* for a T1/E1 WAN line or *idsl(4)* for an iDSL modem.
- Device Number: Defines which WAN or iDSL port number on the 3196RC you are mapping. For example, to map a connection for iDSL port 3 (i.e. iDSL modem #3) you would select *port3(3)*
- Device Slots. Defines which DS0 channels will be mapped. Each DS0 channel is 64 kbps. Each iDSL port has 3 DS0 channels for data. Each T1 WAN port has 24 DS0 channels. Each E1 WAN port has 31 DS0 channels. When defining time slots you must select the same number of Device Slots on the “A” and “B” sides of the connection. The slots are defined by entering a text string that represents the slots. For the iDSL ports, the slots that are available are 1 - 3. For a WAN port configured as a T1, the available slots are numbered from 1 - 24. For a WAN port configured as an E1, the available slots are 1 - 31.

The following notation should be used for assigning timeslots:

- dash: (-), e.g., 1-3
- comma: (,), e.g., 1,4,9
- combo: 1-2,3,6-7

Examples for configuring static connections.

Three examples are provided:

- Example 1: Connecting an iDSL modem port to an E1 WAN port.
- Example 2: Connecting an E1 WAN port to another E1 WAN port.
- Example 3: Connect an iDSL modems port to another iDSL modem port.

Example 1

Connect iDSL modem, Port 3 (referring to modem #3), time slots 1 - 3, to an E1 line on (WAN) Port 1, time slots 1 - 3.

Solution:

1. Under *Dev Type A*, select *iDSL(3)*.
2. Under *Dev Num A*, select *port3(3)*.
3. Under *Dev Slots A*, enter *1 - 3*.
4. Under *Dev Type B*, select *t1-e1(1)*.
5. Under *Dev Num B*, select *port1(1)*.
6. Under *Dev Slots B*, enter *1 - 3*.
7. Click the **Submit Query** button.

Note At this point the DS0 channel mapping is completed. Now is time to configure the DTE data rate of the iDSL modem, refer to section “Activating the iDSL ports” on page 54.

- On the *3196RC Configuration Menu*, click the *iDSL* hyperlink to open the **iDSL Port Configuration** page (figure 30). Using your mnemonic naming convention scheme, enter a name for this connection in the *Circuit ID* field to the right of Port #3 (optional).

iDSL Port Configuration DACS

Number of iDSL Ports Available: 16 Number of iDSL Ports Linked: 1
 Number of iDSL Ports Activated: 1 % iDSL Ports Linked: 100%
 Number of iDSL Ports Failed: 6 Number of iDSL Ports Training: 0
 Number of iDSL Ports in Test Mode: 0 Total Flap Count: 1

Activate All 16 Ports

Submit **Refresh Current Page**

Port #	Circuit ID	Current State	Desired State	Test Mode	CPE Device	CPE Circuit ID
1	None	dataMode(6)	activate(1) ▾	none(0) ▾	model1082C(22)	None
2	None	deactivate(0)	deactivate(0) ▾	none(0)	none(0)	None
3	None	deactivate(0)	deactivate(0) ▾	none(0)	none(0)	None
4	None	deactivate(0)	deactivate(0) ▾	none(0)	none(0)	None
5	None	deactivate(0)	deactivate(0) ▾	none(0)	none(0)	None
6	None	deactivate(0)	deactivate(0) ▾	none(0)	none(0)	None
7	None	deactivate(0)	deactivate(0) ▾	none(0)	none(0)	None
8	None	deactivate(0)	deactivate(0) ▾	none(0)	none(0)	None
9	None	deactivate(0)	deactivate(0) ▾	none(0)	none(0)	None
10	None	deactivate(0)	deactivate(0) ▾	none(0)	none(0)	None
11	None	deactivate(0)	deactivate(0) ▾	none(0)	none(0)	None
12	None	deactivate(0)	deactivate(0) ▾	none(0)	none(0)	None
13	None	deactivate(0)	deactivate(0) ▾	none(0)	none(0)	None
14	None	deactivate(0)	deactivate(0) ▾	none(0)	none(0)	None
15	None	deactivate(0)	deactivate(0) ▾	none(0)	none(0)	None
16	None	deactivate(0)	deactivate(0) ▾	none(0)	none(0)	None

Submit

Figure 30. iDSL Port Configuration page

- On the Configuration/information pane, click on the number 3 under the column titled *Port #* to open the **iDSL Port 3 Details** page (see figure 31).

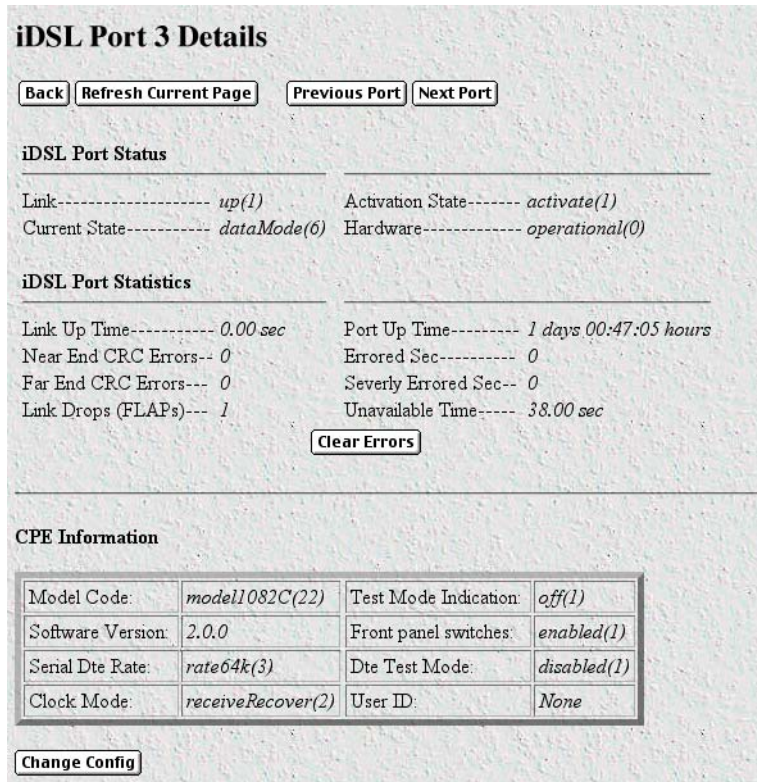

Figure 31. iDSL Port 1 Details page

- Click the **Change Config** button to open the configurable parameter fields (see figure 32).

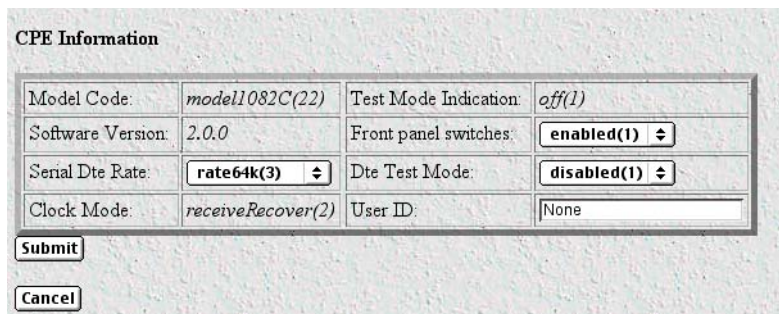

Figure 32. iDSL Port configurable parameters

- Near the bottom of the pane, change *Serial Data Rate* to *144k(5)* and click the **Submit** button. You will automatically return to the **iDSL Port Information** page.

You have completed the DS0 mapping configuration for example 1.

Example 2

Connect an E1 line, (WAN) Port 2, timeslots 1 - 31, to another E1 line, (WAN) Port 3, timeslots 1 - 31.

Solution:

1. Under *Dev Type A*, select *t1-e1(1)*.
2. Under *Dev Num A*, select *port2(2)*.
3. Under *Dev Slots A*, enter 1 - 31.
4. Under *Dev Type B*, select *t1-e1(1)*.
5. Under *Dev Num B*, select *port3(3)*.
6. Under *Dev Slots B*, enter 1 - 31.
7. Click the **Submit Query** button

You have completed the configuration for example 2.

Example 3

Connect two iDSL modems together - iDSL modem #15, time slots 1 - 2 (for a DTE data rate of 128 kbps) to iDSL modem #16, time slots 1 - 2.

Solution:

1. Under *Dev Type A*, select *iDSL(4)*.
2. Under *Dev Num A*, select *port15(15)*.
3. Under *Dev Slots A*, enter 1 - 2.
4. Under *Dev Type B*, select *iDSL(3)*.
5. Under *Dev Num B*, select *port16(16)*.
6. Under *Dev Slots B*, enter 1 - 2.
7. Click the **Submit Query** button.

Note At this point the DS0 channel mapping is completed. Now we need to configure the DTE data rate of the iDSL modem. The T-DAC will derive the iDSL line rates from the connected CPE modems.

8. Click the *iDSL* hyperlink on the *3196RC Configuration Menu*.
9. On the Configuration/information pane, click on the number 15 under the column titled *Port #* to open the **iDSL Port 15 Details** page.
10. Click the **Change Config** button.
11. Near the bottom of the pane, change *Serial DTE Rate to 144k(5)* and click the “**Submit**” button. You will automatically return to the **iDSL Port Information** page.
12. Click the *iDSL* hyperlink on the *3196RC Configuration Menu*.
13. Scroll down to port 16.
14. Under desired state, select *activate(1)*.

15. Click the **Submit** button at the bottom of the page.
 16. Repeat steps 9 through 15 for iDSL modem port 16.
- You have completed the configuration for example 3.

Example 4

Mapping between different blades. Connect WAN port 1, time slot 1 on Blade Number 1 to WAN port 7, time slot 31 on Blade Number 3.

Solution:

Complete the following steps.

1. Go to blade number 1.
2. Under *Dev Type A*, select *t1-e1(1)*.
3. Under *Dev Num A* select *port1(1)*.
4. Under *Dev Slots A*, enter *1*.
5. Under *Dev Type B*, select to *H110(5)*.
6. Under *Dev Num B*, select *port1(1)*.
7. Under *Dev Slots B*, enter *1*.
8. Under *Dev Type B*, bottom window, select from *H110(6)*.
9. Under *Dev Num B*, bottom window, select *port2(2)*.
10. Under *Dev Slots B*, bottom window, enter *1*.
11. Click on **Submit Query**.
12. Go to blade number 3.
13. Under *Dev Type A*, select *t1-e1(1)*.
14. Under *Dev Num A*, select *port7(7)*.
15. Under *Dev Slots A*, enter *31*.
16. Under *Dev Type B*, select to *H110(5)*.
17. Under *Dev Num B*, select *port2(2)*.
18. Under *Dev Slots B*, enter *1*.
19. Under *Dev Type B*, bottom window, select from *H110(6)*.
20. Under *Dev Num B*, bottom window, select *port1(1)*.
21. Under *Dev Slots B*, bottom window, enter *1*.
22. Click on **Submit Query**.
23. You have completed the configuration for example 4.

Activating the iDSL ports

Do the following to activate an iDSL port:

1. On the 3196RC Configuration Menu, click the DSL hyperlink to display the iDSL Port Configuration page (see figure 33). (Optional: Using your mnemonic naming convention scheme, enter a name for this connection in the “Circuit ID” field to the right of the Port # you wish to activate).

iDSL Port Configuration DACS

Number of iDSL Ports Available: 16 Number of iDSL Ports Linked: 1
 Number of iDSL Ports Activated: 1 % iDSL Ports Linked: 100%
 Number of iDSL Ports Failed: 6 Number of iDSL Ports Training: 0
 Number of iDSL Ports in Test Mode: 0 Total Flap Count: 1

Port #	Circuit ID	Current State	Desired State	Test Mode	CPE Device	CPE Circuit ID
1	None	dataMode(6)	activate(1)	none(0)	model1082C(22)	None
2	None	deactivate(0)	deactivate(0)	none(0)	none(0)	None
3	None	deactivate(0)	deactivate(0)	none(0)	none(0)	None
4	None	deactivate(0)	deactivate(0)	none(0)	none(0)	None
5	None	deactivate(0)	deactivate(0)	none(0)	none(0)	None
6	None	deactivate(0)	deactivate(0)	none(0)	none(0)	None
7	None	deactivate(0)	deactivate(0)	none(0)	none(0)	None
8	None	deactivate(0)	deactivate(0)	none(0)	none(0)	None
9	None	deactivate(0)	deactivate(0)	none(0)	none(0)	None
10	None	deactivate(0)	deactivate(0)	none(0)	none(0)	None
11	None	deactivate(0)	deactivate(0)	none(0)	none(0)	None
12	None	deactivate(0)	deactivate(0)	none(0)	none(0)	None
13	None	deactivate(0)	deactivate(0)	none(0)	none(0)	None
14	None	deactivate(0)	deactivate(0)	none(0)	none(0)	None
15	None	deactivate(0)	deactivate(0)	none(0)	none(0)	None
16	None	deactivate(0)	deactivate(0)	none(0)	none(0)	None

Figure 33. iDSL Port Configuration window

2. From the Desired State drop-down menu, select *activate(1)*.
3. Click the “Submit” button to record your changes in volatile DRAM.

You have now completed the procedure to activate one iDSL port. To activate additional iDSL ports, repeat the above procedure for each port you wish to activate.

Configuring Patton iDSL CPE device remotely via the Model 3196RC

Once an iDSL link is established between the 3196RC port and a Patton Customer Premise Equipment (CPE) iDSL device, (such as the Model 3092) you may use the 3196RC Web Management pages to remotely configure DSL port parameters on the CPE device. The following DSL port parameters may be configured remotely:

- Serial DTE Rate

- Front panel switches
- DTE test mode
- User ID

Do the following to configure the iDSL port parameters on the Patton CPE device:

1. On the 3196RC home page click the DSL hyperlink to display the iDSL Port Configuration page.

iDSL Port Configuration DACS

Number of iDSL Ports Available: 16 Number of iDSL Ports Linked: 1
 Number of iDSL Ports Activated: 1 % iDSL Ports Linked: 100%
 Number of iDSL Ports Failed: 6 Number of iDSL Ports Training: 0
 Number of iDSL Ports in Test Mode: 0 Total Flap Count: 1

Activate All 16 Ports

Submit **Refresh Current Page**

Port #	Circuit ID	Current State	Desired State	Test Mode	CPE Device	CPE Circuit ID
1	None	dataMode(6)	activate(1) ↓	none(0) ↓	model1082C(22)	None
2	None	deactivate(0)	deactivate(0) ↓	none(0)	none(0)	None
3	None	deactivate(0)	deactivate(0) ↓	none(0)	none(0)	None
4	None	deactivate(0)	deactivate(0) ↓	none(0)	none(0)	None
5	None	deactivate(0)	deactivate(0) ↓	none(0)	none(0)	None
6	None	deactivate(0)	deactivate(0) ↓	none(0)	none(0)	None
7	None	deactivate(0)	deactivate(0) ↓	none(0)	none(0)	None
8	None	deactivate(0)	deactivate(0) ↓	none(0)	none(0)	None
9	None	deactivate(0)	deactivate(0) ↓	none(0)	none(0)	None
10	None	deactivate(0)	deactivate(0) ↓	none(0)	none(0)	None
11	None	deactivate(0)	deactivate(0) ↓	none(0)	none(0)	None
12	None	deactivate(0)	deactivate(0) ↓	none(0)	none(0)	None
13	None	deactivate(0)	deactivate(0) ↓	none(0)	none(0)	None
14	None	deactivate(0)	deactivate(0) ↓	none(0)	none(0)	None
15	None	deactivate(0)	deactivate(0) ↓	none(0)	none(0)	None
16	None	deactivate(0)	deactivate(0) ↓	none(0)	none(0)	None

Submit

2. Scroll to the table row for the port which connects to the Patton CPE device, and click the port number hyperlink to display the iDSL Port # Details page.

iDSL Port 1 Details

[Back](#)
[Refresh Current Page](#)
[Previous Port](#)
[Next Port](#)

iDSL Port Status

Link----- *up(1)* Activation State----- *activate(1)*
 Current State----- *dataMode(6)* Hardware----- *operational(0)*

iDSL Port Statistics

Link Up Time----- *0.00 sec* Port Up Time----- *1 days 00:47:05 hours*
 Near End CRC Errors-- *0* Errored Sec----- *0*
 Far End CRC Errors--- *0* Severly Errored Sec-- *0*
 Link Drops (FLAPs)--- *1* Unavailable Time---- *38.00 sec*

[Clear Errors](#)

CPE Information

Model Code:	<i>model1082C(22)</i>	Test Mode Indication:	<i>off(1)</i>
Software Version:	<i>2.0.0</i>	Front panel switches:	<i>enabled(1)</i>
Serial Dte Rate:	<i>rate64k(3)</i>	Dte Test Mode:	<i>disabled(1)</i>
Clock Mode:	<i>receiveRecover(2)</i>	User ID:	<i>None</i>

[Change Config](#)

Near End Performance in the Current 15 Minute Interval

Current Seconds: 540
 Errored Seconds (ES): 0
 Severly Errored Seconds (SES): 0
 Unavailable Seconds (UAS): 0
 15 Minutes Intervals Since Activation: 93

[History Details](#)

iDSL Alarm Thresholds Per 15 Minute Interval

Errored Seconds Alarm Threshold (per interval): (0=disable)
 Severly Errored Seconds Alarm Threshold (per interval): (0=disable)
 Unavailable Seconds Alarm Threshold (per interval): (0=disable)

[Submit](#)

- Click the [change configuration] button to display the configurable parameters for the Patton CPE device on the right-hand side of the page (see below).

CPE Information			
Model Code:	model1082C(22)	Test Mode Indication:	off(1)
Software Version:	2.0.0	Front panel switches:	enabled(1) ▾
Serial Dte Rate:	rate64k(3) ▾	Dte Test Mode:	disabled(1) ▾
Clock Mode:	receiveRecover(2)	User ID:	None
<input type="button" value="Submit"/>			
<input type="button" value="Cancel"/>			

- Use the drop-down menus to set the configurable parameters to your desired values.
- Click the [submit] button to record your changes on the remote Patton CPE. You will automatically return to the iDSL Port # Details page.

You have now completed the procedure to remotely configure one Patton iDSL CPE device via the Model 3196RC. To activate additional Patton CPE devices, repeat the above procedure for each device you wish to configure.

Configuring line settings and signaling for E1

Accessing the Line Interface Settings

- On the 3196RC Configuration Menu, click the *T1/E1 Link* hyperlink to open the T1/E1 LINK ACTIVITY OVERVIEW page (see figure 34).

T1/E1 LINK ACTIVITY OVERVIEW			Blade 1
View Links 1 - 4:	View Links		
View Link 1	Circuit ID: WAN Circuit	Line Type: dsx1E1(4)	Line Status: No Alarm
View Link 2	Circuit ID: WAN Circuit	Line Type: other(1)	Line Status: No Alarm
View Link 3	Circuit ID: WAN Circuit	Line Type: other(1)	Line Status: No Alarm
View Link 4	Circuit ID: WAN Circuit	Line Type: other(1)	Line Status: No Alarm
Links 5 - 8 Not Installed:			
Links 9 - 12 Not Installed:			
Links 13 - 16 Not Installed:			
View All Links:	View Links		

Figure 34. T1/E1 Link Activity Overview page

- View Link 1* corresponds to the first WAN circuit on the T-DAC. To the right of *View Links 1-4* click the *View Links...* hyperlink to open the T1/E1 LINK ACTIVITY PORTS 1 – 4 page (see figure 35).

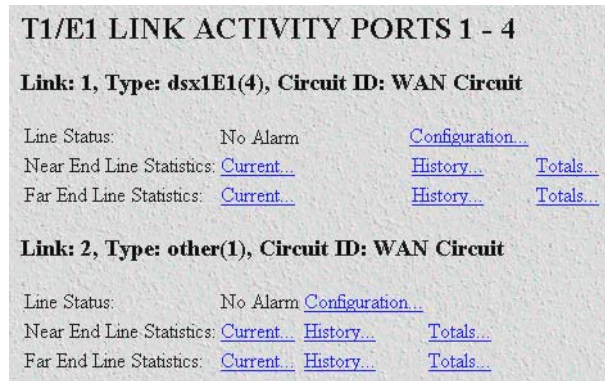

Figure 35. T1/E1 Link Activity Ports 1 – 4 page.

- Click the *Configuration...* hyperlink then click the *Modify Configuration...* hyperlink to open the WAN Circuit CONFIGURATION LINK window (see [figure 36](#)) and view the *Line Interface Settings*.

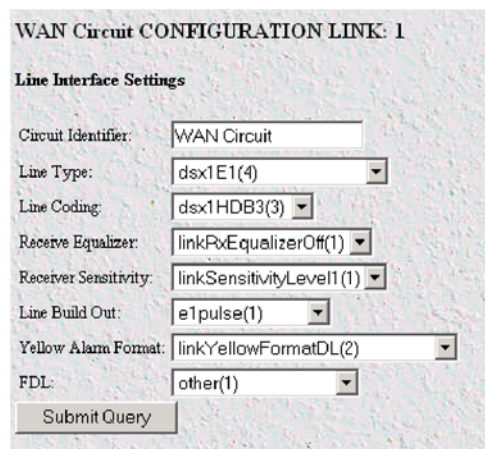

Figure 36. WAN Circuit Configuration page, Line Interface Settings

Configuring the E1 line interface settings

- From the *Line Type* pull-down menu ([figure 37](#)) select *dsx1E1(4)* or *dsx1E1-CRC(5)*.

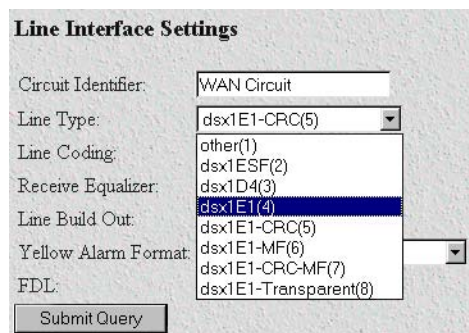

Figure 37. Line Type pull-down menu

- From the *Line Coding* pull-down menu (figure 38) select *dsx1AMI(5)* or *dsxHDB3(3)*. Most installations will use HDB3.

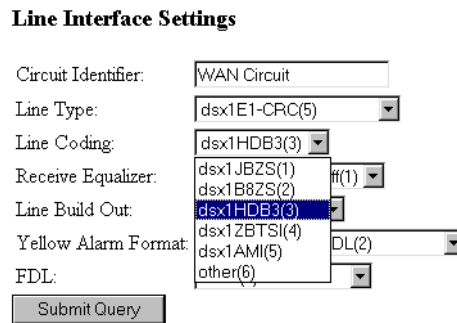

Figure 38. Line Coding pull-down menu with dsx1HDB3(3) selected

- From the *Line Build Out* pull-down menu (figure 39) select *e1pulse(1)*.

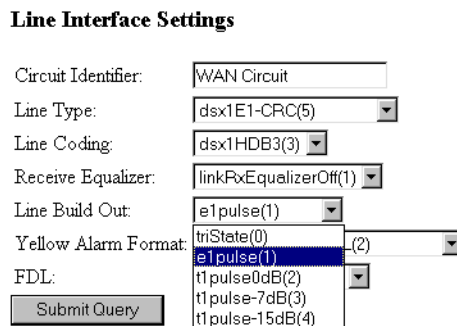

Figure 39. Line Build Out pull-down menu with e1pulse(1) selected

- Click the **Submit Query** button to apply your line interface settings.

At this point the WAN front panel LEDs will become active. The *WAN* indicator LED should now display a steady green light, indicating the T-DAC has synchronized with the E1 line. If the E1 line is not connected to the 3196RC, T1/E1 link pages will display the hyperlink *ALARMS PRESENT* (figure 40) for that T1/E1 link.

T1/E1 LINK ACTIVITY PORTS 1 - 4

Link: 1, Type: dsx1E1(4), Circuit ID: WAN Circuit

Line Status: **ALARMS PRESENT** [Configuration...](#)
 Near End Line Statistics: [Current...](#) [History...](#) [Totals...](#)
 Far End Line Statistics: [Current...](#) [History...](#) [Totals...](#)

Figure 40. E1 ALARMS PRESENT indicator

After you connect the E1 line to the WAN port on the rear of the Model 3196RC these alarms should disappear.

Configuring line settings and signaling for T1

Accessing the Line Interface Settings

1. On the *3196RC Configuration Menu*, click the *T1/E1 Link* hyperlink to open the **T1/E1 LINK ACTIVITY OVERVIEW** page (figure 41).

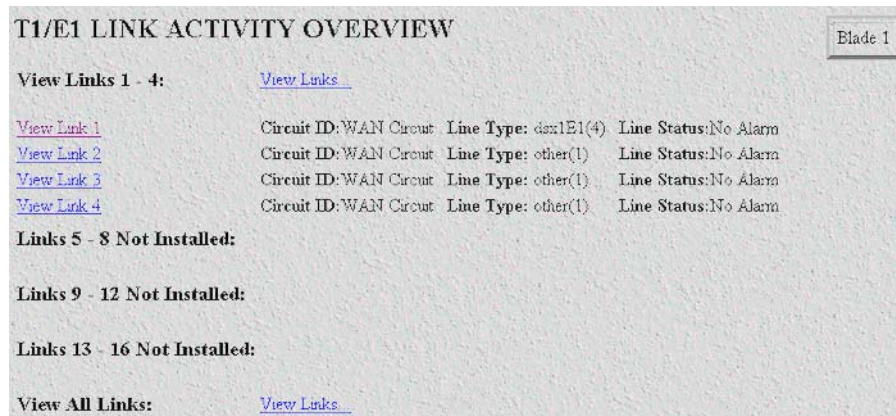

Figure 41. T1/E1 Link Activity Overview page

2. *View Link 1* corresponds to the first WAN circuit on the T-DAC. To the right of *View Links 1-4* click the *View Links...* hyperlink to open the **T1/E1 LINK ACTIVITY PORTS 1 – 4** page (figure 42).

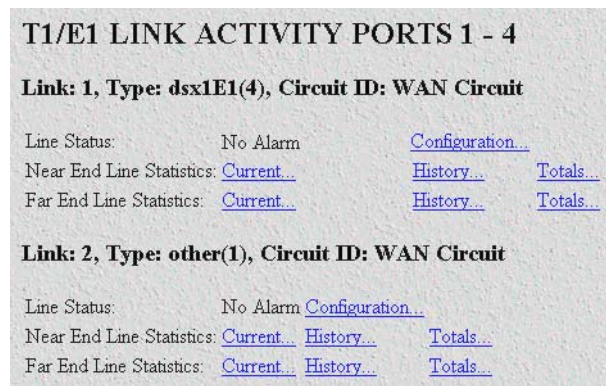

Figure 42. T1/E1 Link Activity Ports 1 – 4 page.

- Click the *Configuration...* hyperlink, then click the *Modify Configuration...* hyperlink to open the WAN Circuit CONFIGURATION LINK window (figure 43) and view the *Line Interface Settings*.

WAN Circuit CONFIGURATION LINK: 1

Line Interface Settings

Circuit Identifier:	WAN Circuit
Line Type:	dsx1E1(4)
Line Coding:	dsx1HDB3(3)
Receive Equalizer:	linkRxEqualizerOff(1)
Line Build Out:	e1pulse(1)
Yellow Alarm Format:	linkYellowFormatDL(2)
FDL:	other(1)
Submit Query	

Figure 43. WAN Circuit Configuration page, Line Interface Settings

Configuring the T1 line settings

- From the *Line Type* pull-down menu (figure 44) select either:

- *dsx1ESF(2)* - indicates Extended SuperFrame DS1
- *dsx1D4* - indicates AT&T D4 format DS1

Line Interface Settings

Circuit Identifier:	WAN Circuit
Line Type:	dsx1ESF(2)
Line Coding:	other(1) dsx1ESF(2)
Receive Equalizer:	dsx1D4(3) dsx1E1(4)
Line Build Out:	dsx1E1-CRC(5)
Yellow Alarm Format:	dsx1E1-MF(6) dsx1E1-CRC-MF(7)
FDL:	dsx1E1-Transparent(8)
Submit Query	

Figure 44. Line Type pull-down menu with dsx1ESF(2) selected

- From the *Line Coding* pull-down menu (figure 45), select *dsx1B8ZS(2)* or *dsx1AMI(5)*.

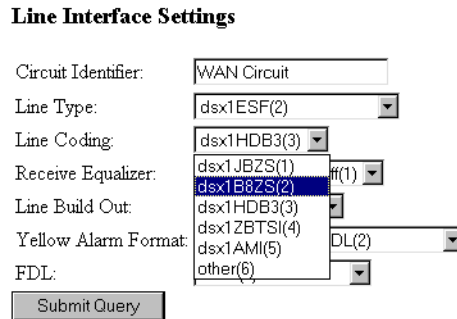

Figure 45. Line Coding pull-down menu with dsx1B8ZS(2) selected

- From the *Line Build Out* pull-down menu (figure 46) select *t1pulse0dB(1)*.

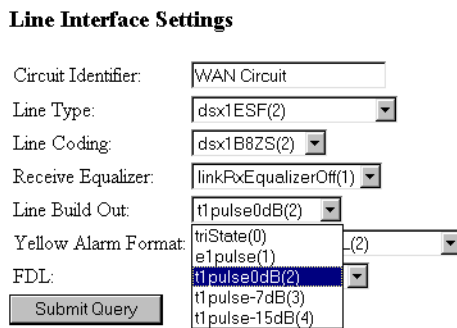

Figure 46. Line Build Out pull-down menu with t1pulse0dB(1) selected

- Click on **Submit Query** to apply your settings.

At this point the WAN front panel LEDs will become active. The *FRAME* indicator LED should now display a steady green light, indicating the T-DAC has synchronized with the E1 line. If the E1 line is not connected to the 3196RC, T1/E1 link pages will display the hyperlink *ALARMS PRESENT* (figure 47) for that T1/E1 link.

T1/E1 LINK ACTIVITY PORTS 1 - 4

Link: 1, Type: dsx1ESF(2), Circuit ID: WAN Circuit

Line Status: [ALARMS PRESENT Configuration...](#)
 Near End Line Statistics: [Current...](#) [History...](#) [Totals...](#)
 Far End Line Statistics: [Current...](#) [History...](#) [Totals...](#)

Link: 2, Type: other(1), Circuit ID: WAN Circuit

Figure 47. T1 ALARMS PRESENT indicator on T1/E1 LINK ACTIVITY page

After you connect the E1 line to the WAN port on the rear of the Model 3196RC, these alarms should disappear.

Saving your configuration

At this point you have completed the basic configuration of your T-DAC for operation. To save your configuration settings in non-volatile RAM, do the following:

1. On the Configuration Menu click the Select *HOME* hyperlink to open the *3196RC Configuration Menu* home page (figure 48).

STATUS OF Blade 1	
Number of Egress Ports:	4
Shelf Address:	31
Slot ID:	5
% CPU Idle:	94
Running Since Last Boot:	00:39:52 hours
Total System Alarms:	6

IMMEDIATE ACTIONS

Record Current Configuration

Hard Reset

Set Factory Default Configuration

Figure 48. 3196RC Configuration Menu home page

2. Click the **Record Current Configuration** button (see figure 48).

Note All configuration settings will be lost unless you click on the **Record Current Configuration** button before you power down or reset the T-DAC.

Backing up your configuration parameters

The 3196RC T-DAC provides Import/Export functions. These functions enable you to back up (*export*) and restore (*import*) your T-DAC's configuration parameters against possible failure. Should your T-DAC ever need replacing, a previously saved copy of your (*exported*) configuration file can quickly be loaded (*imported*) into a replacement T-DAC.

Note Import/Export functions require superuser access privileges.

Note The parameters that will be exported are the power-up settings as they are stored in flash memory and *may not* be the current operating parameters. To ensure that you export the most current parameters, go to HOME, then under *Immediate Actions*, click on the **Record Current Configuration** button.

To import or export a configuration, do the following:

1. On the Configuration Menu pane, click the *Import/Export* hyperlink to display the IMPORT/EXPORT page (see figure 49).

IMPORT / EXPORT Blade 1

EXPORT CURRENT FLASH CONFIGURATION

The current power up settings as stored in the system flash will be dumped to your screen. You may then save them in a file using the "save as" function in your web browser for later import back into the system.

Note that the information which is exported is the current hard storage settings, NOT the currently running settings. You may want to issue a "Record Current Configuration" on the home page before dumping the configuration.

[Export Flash...](#)

IMPORT FLASH CONFIGURATION FROM FILE

If you have previously exported the system configuration to a file then you can submit that file below and the system will update its flash configuration from the data saved in the file.

After this operation the system should be rebooted to activate the new settings. The configuration is loaded directly into the flash and so does NOT immediately modify any settings.

WARNING: This operation will erase whatever settings you currently have in the system.

HOME
[Import/Export](#)
[System Status](#)
[System History](#)
[Alarms](#)
[DS0 Mapping](#)
[System Clocking](#)
[DSL](#)
[Ethernet](#)
[Filter IP](#)
[Frame Relay](#)
[ICMP](#)
[IP](#)
[TCP](#)
[UDP](#)
[RIP Version 2](#)
[SNMP](#)
[System](#)
[System Log](#)

Figure 49. IMPORT/EXPORT page

Note If the T-DAC does not behave as described, the most likely cause is that the T-DAC default settings are not compatible with the T1/E1 line. If this is the case, use the RS-232 CONFIG port to correct the T-DAC settings. You will have to use the 3196RC Configuration Menu pages to examine the configured T1/E1 link settings.

6. There are two LEDs that indicate the status of the T-DAC 10/100 Ethernet port: a green LED indicates link status and activity, and a yellow LED that indicates line speed. Verify that the green LED is either flashing green (meaning that packets are being received at the Ethernet port) or solid green (meaning that the link is valid but no packets are being received).

Congratulations! Your T-DAC is now installed. If you require further information about configuring your T-DAC settings, refer to the *DSL T-DAC Administrator's Reference Guide* available online at www.patton.com/manuals/TDAC-arg.pdf.

Note For information on activating and de-activating your Model 3196RC T-DAC, refer to chapter 4, “[Operation and shutdown](#)” on page 68.

Chapter 4 **Operation and shutdown**

Chapter contents

Introduction.....	69
Activating the Model 3196RC.....	69
De-activating the Model 3196RC	69

Introduction

This chapter describes how to start up and power down the Model 3196RC.

Activating the Model 3196RC

The Model 3196RC is activated by completing the procedures in chapter 2, “[Hardware installation](#)” on page 24 and chapter 3, “[Configuring the T-DAC for operation](#)” on page 35. To activate the 3196RC, follow the procedures in those chapters.

The Model 3196RC is designed for unattended operation. Once the Model 3196RC has been installed and configured, no further operator action is required under normal conditions.

De-activating the Model 3196RC

Perform the following procedure to deactivate the Model 3196RC.

Note Be sure to wear an anti-static strap to prevent electrostatic damage to the blade.

1. Unlock the handles on the front of the 3196RC by pressing the red button on each handle. The button immediately activates the switch (turning it to an open position), while the button itself remains depressed. Remove the blade by pushing the handles outwards.
2. Remove the Model 3196RC from the rack chassis. Place the blade on an anti-static surface.
3. Remove the rear blade from the rack chassis. Place the blade on an anti-static surface.

Chapter 5 **Troubleshooting and maintenance**

Chapter contents

Introduction	71
Fault analysis	72
Basic iDSL and T1/E1 test modes	74
iDSL port test modes	74
Local loop	74
Remote loop	75
Line Loop	76
T1/E1 port test modes	77
DSX1 payload loop (dsx1PayloadLoop)	77
DSX1 line loop (dsxLineLoop)	78
Periodic maintenance	78
Calibration	78
Maintenance	79
Replacing the Model 3196RC	79
Exporting the current Model 3196RC configuration	79
Removing the defective Model 3196RC	82
Installing the replacement Model 3196RC	83
Importing a saved configuration	83
Completing the installation	84

Introduction

This chapter describes troubleshooting and fault analysis that can be performed by the operator. If you require more help, refer to chapter 6, “[Contacting Patton for assistance](#)” on page 85. Refer to [table 7](#) for a list of common symptoms and suggested remedies.

Note The following information assumes that there is only one failure involving the Model 3196RC and that if you perform the corrective action listed, it will solve the problem. If you are unable to correct a failure, refer to chapter 6, “[Contacting Patton for assistance](#)” on page 85.

Note When removing the 3196RC from the chassis, follow the procedures cited in section “[De-activating the Model 3196RC](#)” on page 69.

Note When re-inserting the 3196RC into the chassis, please follow the procedures cited in section “[T-DAC blades installation](#)” on page 25.

Table 7. Symptoms

Problem	Corrective Action
POWER LED (green) is extinguished	To verify that power is being supplied to the Model 3196RC via the CPCI chassis power bus: verify that at least one chassis power supply module is installed in the chassis and functioning normally.
POWER LED (green) is flashing	The 3196RC has detected a power failure on a power bus. There may be a problem with the CPCI chassis power system which feeds the Model 3196RC such as a failed power supply module in the chassis. The Model 3196RC will function normally with one power supply. Inspect the power supplies in the CPCI chassis to identify and replace the failed power supply module. If no failed power supply is found, or if the POWER LED continues flashing, contact Patton Technical Support to determine if the T-DAC should be replaced.
CPU FAIL LED (red) is lit	CPU is unable to load the software from FLASH to RAM for operation. As soon as possible, remove the Model 3196RC from the CPCI chassis, wait 30 seconds, then re-insert the Model 3196RC into the CPCI chassis and see if the problem disappears. If the CPU FAIL LED remains lit after the Model 3196RC completes the power-up cycle, contact Patton Technical Support to determine if the T-DAC needs to be replaced.
ALARM LED (yellow) is lit	Indicates The 3196RC has detected a minor or major alarm condition.
SYSTEM LED (green) is not flashing	The Model 3196RC is not functioning properly. As soon as possible, remove the Model 3196RC from the CPCI chassis, wait 30 seconds, then re-insert the Model 3196RC into the CPCI chassis and see if the problem disappears. If the SYSTEM LED remains lit after the Model 3196RC completes the power-up cycle, contact Patton Technical Support to determine if the T-DAC needs to be replaced.
ETHERNET LED (green) is extinguished	<ul style="list-style-type: none"> • A valid Ethernet link has not been detected. Verify that the Model 3196RC is connected by means of an Ethernet cable to an Ethernet hub, switch, or workstation and that both ends of the cable are plugged in. • Verify that the hub, switch, or workstation is powered on. • Verify that the correct cable is being used—either a straight through or cross-over cable depending on whether you are connecting to a workstation (PC), hub, or switch. • Replace the Ethernet cable. If the problem still exists, contact Patton Technical Support to determine if the T-DAC should be replaced.

Fault analysis

The following procedures outline steps you should follow when troubleshooting a Model 3196RC malfunction.

1. If possible, talk to the person who filed the trouble complaint and determine the operational symptoms. Record the symptoms on the appropriate trouble report form (include the front panel LED indications).
2. Refer to [table 8](#) for LED definitions and compare the recorded results from the trouble report against those in the table, then refer to the section recommended in the table for the maintenance procedure that will repair the malfunction.

Table 8. LED definitions

LED	Location	Color	Status	Meaning
POWER	Front panel	Green	On solid	Power is being applied. No action recommended.
			Flash-ing	The 3196RC has detected a power failure on a power bus. There may be a problem with the CPCI power supply system such as a failed power supply module in the chassis. The Model 3196RC will function normally with one power supply. Inspect the power supplies in the CPCI chassis to identify and replace the failed power supply module. If the POWER LED continues flashing when all chassis power supplies are functional, contact Patton Technical Support to determine if the T-DAC should be replaced.
			Off	No input power is being applied. Verify that at least one chassis power supply module is installed in the chassis and functioning normally.
CPU FAIL	Front panel	Red	On solid	CPU is unable to load the software from FLASH to RAM for operation. As soon as possible, remove the Model 3196RC from the CPCI chassis, wait 30 seconds, then re-insert the Model 3196RC into the CPCI chassis and see if the problem disappears. If the CPU FAIL LED remains lit after the Model 3196RC completes the power-up cycle, contact Patton Technical Support to determine if the T-DAC needs to be replaced.
			Off	The CPU is operating normally. No action recommended.
ALARM	Front panel	Red	On solid	A minor alarm condition has been detected.
			Flash-ing	A major alarm condition has been detected.
			Off	The Model 3196RC is operating normally. No action recommended.

Table 8. LED definitions (Continued)

LED	Location	Color	Status	Meaning
SYSTEM	Front panel	Green	Flashing	The Model 3196RC is operating normally. No action recommended.
			Off	The Model 3196RC is not functioning properly. As soon as possible, unplug both power cables from the Model 3196RC, wait 30 seconds, then plug the cables back into the Model 3196RC to see if the problem disappears. If the SYSTEM LED remains lit after the Model 3196RC completes the power-up cycle, contact Patton Technical Support to determine whether the T-DAC needs to be replaced.
ETHERNET	Front panel	Green	On solid	Link status is nominal for the Ethernet port. No action recommended.
			Off	<ul style="list-style-type: none"> • A valid link has not been detected. • Verify that an Ethernet cable is plugged into the hub, switch, or workstation and the Ethernet port of the Model 3196RC. • Verify that the hub, switch, or workstation is powered on. • Verify that the correct straight-through or cross-over cable is being used, depending on whether you are connecting to a workstation (PC), hub, or switch. • Replace the cable. If the problem still exists, contact Patton Technical Support to determine if the T-DAC should be replaced.
CLK SOURCE	Front panel	Green	On solid	The 3196RC is set as the Master Clock source. No action recommended.
			Flashing	The 3196RC is set as the secondary clock source. No action recommended.
			Off	The 3196RC is set as the slave, getting its clock from the H.110 Bus. No action recommended.
CLK ERROR	Front panel	Yellow	On solid	Master Clock source has been lost and the 3196RC is using the secondary source for its clock.
			Flashing	Master Clock source and the Secondary Clock source have been lost and the 3196RC is using its internal crystal for its clock.
			Off	No clock errors currently detected. No action recommended.
TEST MODE	Front panel	Green	On solid	One or more iDSL ports or T1/E1 ports is in test mode. No action recommended.
			Flashing	One or more of the iDSL ports or the T1/E1 ports is in test mode and errors have been received.
			Off	None of the iDSL ports is operating in test mode. No action recommended.

Table 8. LED definitions (Continued)

LED	Location	Color	Status	Meaning
WAN ^a	Front Panel	Green	On solid	Indicates normal activity at each of the T1/E1/PRI links. No action recommended.
			Single Flash	Indicates that the Model 3196RC is detecting the network, but is unable to synchronize with it.
			Double Flash	Indicates an error on any of the T1/E1/PRI links.
			Off	Indicates no T1/E1 links are in use.
DSL CONNECTION (LEDs 1–16)	Front Panel	Green	On solid	The ports are activated, linked, and operating normally.
			Flashing	One or more iDSL ports have errors.
			Off	No iDSL ports have been configured to establish a link. See chapter 3, “Configuring the T-DAC for operation” on page 35 to configure the iDSL ports.
READY	Front panel	Blue	On	Card ready for removal from cPCI chassis.
			Off	Card not ready for removal from cPCI chassis. Do not remove card from chassis.
ALARM	Rear blade	Yellow	On solid	A minor alarm condition has been detected.
			Flashing	A major alarm condition has been detected.
			Off	The Model 3196RC is operating normally. No action recommended.
READY	Rear blade	Blue	On	Card ready for removal from cPCI chassis.
			Off	Card not ready for removal from cPCI chassis. Do not remove card from chassis.

a. This LED provides status indications for the WAN links established via the T1/E1 ports on the Rear Blade of the 3196RC

Basic iDSL and T1/E1 test modes

Model 3196RC T-DACS offer a variety of test modes for individual G.HSDSL and T1/E1 ports that are of outstanding value when initially installing or troubleshooting connections on the iDSL or T1/E1 side.

iDSL port test modes

Diagnostics loops for the 3196RC iDSL ports include:

- Local loop
- Remote loop
- Line loop

Local loop

This loop tests the operation of the selected DSL port. Data transmitted to the port is looped at the DSL port. For example, as shown in [figure 52](#), if DSL port 1 is mapped to T1/E1 port 1, data arriving at the T1/E1 port and passed by the DACS to DSL port 1, is looped and sent back to T1/E1 port 1.



Figure 52. Local loopback

To select local loop go to the iDSL page and find the port to be placed under loopback. Locate the *Test Mode* drop down menu and select *local Loop(1)*. Go to the bottom of the screen and click on the **Submit** button.

Port #	Circuit ID	State	Desired State	Test Mode	Test Pattern
1	None	localLoop (6)	dataMode(1)	localLoop(6)	off(0)
2	None	training (2)	dataMode(1)	off(9)	-
3	None	training (2)	dataMode(1)	off(9)	-
4	None	training (2)	dataMode(1)	off(9)	-

To turn off the loop mode, use the Test Mode drop down menu, select “Off” and click on the **Submit** button. The port field should be highlighted in green when the port returns to data mode.

Remote loop

The remote loop, initiated from the 3196RC, will place a remote CPE (3092) in loopback mode. Under this condition, data sent by the 3196RC over the DSL link and destined to the iDSL port of a Model 3092 will be sent back to the 3196RC (see figure 53).

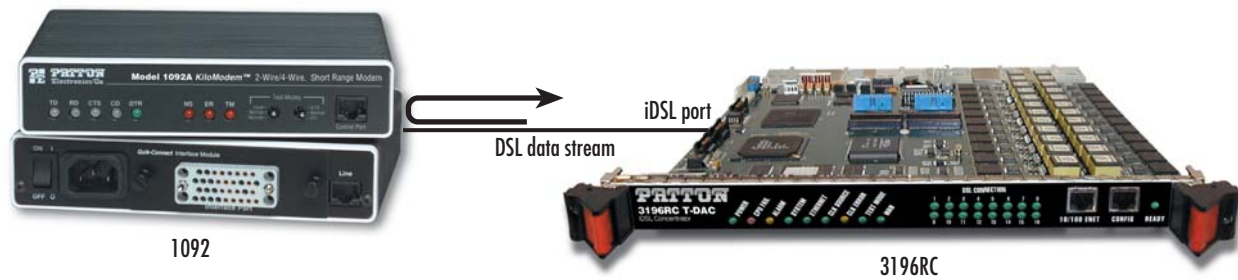

Figure 53. Remote loopback

Note The test mode LED on the CPE will illuminate when the CPE’s iDSL port enters remote loopback mode. However the CPE does not notify users when its iDSL port enters remote loopback mode. Therefore, you may wish to notify any active users connected to the CPE device that service will be interrupted before executing any remote loopback testing.

To activate remote loop, do the following:

1. Go to the iDSL page and find the port to be placed under loopback.
2. Locate the *Test Mode* drop down menu and select *remoteLoop(2)*.
3. Go to the bottom of the screen and click on the **Submit** button. the DSL port selected for remote loop will be highlighted in blue.

Port #	Circuit ID	State	Desired State	Test Mode	Test Pattern
1	None	localLoop(6)	dataMode(1)	remSerLoop(8)	off(0)
2	None	training(2)	dataMode(1)	off(9)	-
3	None	training(2)	dataMode(1)	off(9)	-

To deactivate the loop mode, use the *Test Mode* drop down menu, select *none(0)* and click on the **Submit** button. The port field should be highlighted green when the port returns to data mode.

Line Loop

The line loop, initiated from the 3196RC, tests the DSL link between a 3196RC DSL port and the CPE. When a DSL port is placed on line loop, data transmitted by the CPE is looped at the 3196RC port (see figure 54).

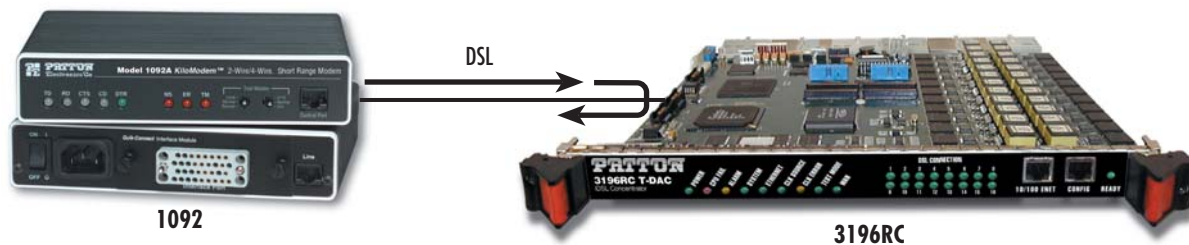

Figure 54. Line Loopback

Note Line Loopback testing is intended for troubleshooting an iDSL connection in consultation with an end-user connected to the CPE. The CPE does not notify users when the T-DAC's iDSL port enters line loopback mode.

To activate line loop on a DSL port, do the following:

1. Go to the iDSL page and find the port to be placed under loopback.
2. Locate the *Test Mode* drop down menu and select *lineLoop(3)*.
3. Go to the bottom of the screen and click on the **Submit** button. The port selected for line loop will be highlighted in blue.

To turn off the loop mode, use the *Test Mode* drop down menu, select *none(0)* and click on the **Submit** button. The iDSL port field should be highlighted in green when the port returns to data mode.

Port #	Circuit ID	State	Desired State	Test Mode	Test Pattern
1	None	localLoop(6)	dataMode(1)	lineLoop(10)	off(0)
2	None	idle(0)	idle(0)	off(9)	-
3	None	idle(0)	idle(0)	off(9)	-

T1/E1 port test modes

The 3196RC offers a number of diagnostics tools to test operation and performance of the T1/E1 ports and line. Diagnostics include DSX1 payload loop and DSX1 line loop.

DSX1 payload loop (*dsx1PayloadLoop*)

When activated, the received signal at the selected T1/E1 port, will be looped through the 3196RC (see [figure 55](#)). Typically the received signal is looped back for retransmission after it has passed through the device's framing function (framing is terminated and then regenerated).

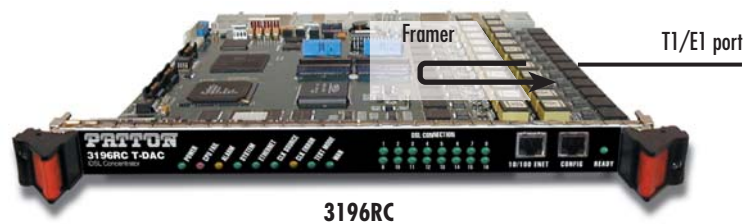

Figure 55. Payload loopback

To activate payload loop, do the following:

1. Click on the *Modify Configuration* link of the T1/E1 port to be placed under test
2. Locate the *Loopback Configuration* drop down menu
3. Select *Payload Loop* and click on the **Submit Query** button on the right.

To deactivate payload loop, set the *Loopback Configuration* drop down menu to *NoLoop*.

Test Settings	
Force Yellow Alarm:	linkYellowDisable(3) <input type="button" value="Submit Query"/>
Loopback Configuration:	dsx1PayloadLoop(2) <input type="button" value="Submit Query"/>
Send Code:	dsx1SendNoCode(1) <input type="button" value="Submit Query"/>

DSX1 line loop (*dsxLineLoop*)

When activated, data received at the selected T1/E1 port, is looped back to the originating device (see figure 56). Data is looped at the T1/E1 port.

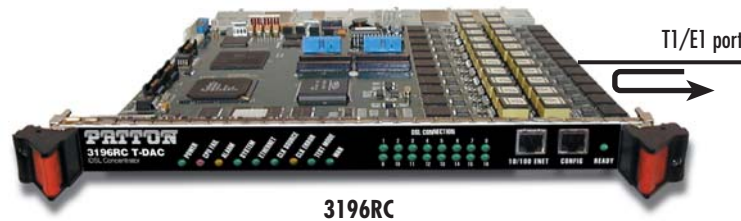
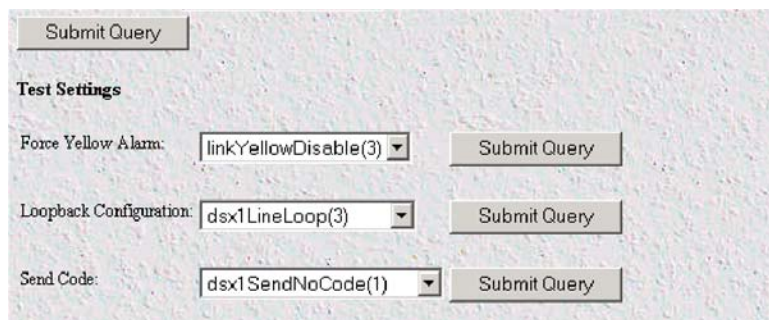

Figure 56. Line Loop

To activate line loop, do the following:

1. Click on the *Modify Configuration* link of the T1/E1 port to be placed under test.
2. Locate the *Loopback Configuration* drop down menu
3. Select *LineLoop* and click on the **Submit Query** button on the right.

To deactivate payload loop, set the *Loopback Configuration* drop down menu to *NoLoop*, and click on the **Submit Query** button on the right.



Note Refer to the *Administration Reference Guide* for descriptions of yellow alarms and send codes.

Periodic maintenance

Consult the rack chassis user manual for information on preventative maintenance (such as cleaning the chassis air cooling vents to remove accumulated dust).

Calibration

The Model 3196RC requires no calibration.

Maintenance

This section describes replacing the Model 3196RC.

Replacing the Model 3196RC

If you isolate a problem to the a Model 3196RC component, the entire Model 3196RC must be replaced as follows.

Exporting the current Model 3196RC configuration

The 3196RC T-DAC provides Import/Export functions. These functions enable you to back up (*export*) and restore (*import*) your T-DAC's configuration parameters against possible failure. Should your T-DAC ever need replacing, a previously saved copy of your (*exported*) configuration file can quickly be loaded (*imported*) into a replacement T-DAC.

Note Import/Export functions require superuser access privileges.

Note The parameters that will be exported are the power-up settings as they are stored in flash memory and may not be the current operating parameters. To ensure that you export the most current parameters, go to HOME, then under Immediate Actions, click on the **Record Current Configuration** button.

1. If you already have an exported backup copy of your current configuration, go to [“Removing the defective Model 3196RC”](#) on page 82. Otherwise, go to step 2.

2. On the Configuration Menu pane, click the *Import/Export* hyperlink to display the **Import/Export** page (figure 57).

3196RC CONFIGURATION MENU

- [HOME](#)
- [Import/Export](#)
- [System Status](#)
- [System History](#)
- [Alarms](#)
- [DSO Mapping](#)
- [System Clocking](#)
- [DSL](#)
- [Ethernet](#)
- [Filter IP](#)
- [Frame Relay](#)
- [ICMP](#)
- [IP](#)
- [TCP](#)
- [UDP](#)
- [RIP Version 2](#)
- [SNMP](#)
- [System](#)
- [System Log](#)

IMPORT / EXPORT Blade 1

EXPORT CURRENT FLASH CONFIGURATION

The current power up settings as stored in the system flash will be dumped to your screen. You may then save them in a file using the "save as" function in your web browser for later import back into the system.

Note that the information which is exported is the current hard storage settings, NOT the currently running settings. You may want to issue a "Record Current Configuration" on the home page before dumping the configuration.

[Export Flash..](#)

IMPORT FLASH CONFIGURATION FROM FILE

If you have previously exported the system configuration to a file then you can submit that file below and the system will update its flash configuration from the data saved in the file.

After this operation the system should be rebooted to activate the new settings. The configuration is loaded directly into the flash and so does NOT immediately modify any settings.

WARNING: This operation will erase whatever settings you currently have in the system.

Figure 57. IMPORT/EXPORT page

3. Unlock the handles by pressing the red button on each handle. The button immediately activates the switch (turning it to an open position), while the button itself remains depressed. The blade can then be removed.
4. Remove the malfunctioning Model 3196RC by pushing the handles outwards, pulling the card gently but firmly from its slot in the chassis. Place the removed card in the container the replacement Model 3196RC came in so you can return the defective Model 3196RC for repair.

Installing the replacement Model 3196RC

1. Insert the replacement Model 3196RC into the rack chassis.
2. Insert the rear blade into the desired slot in the rack chassis. Make sure the blade is seated properly in the slot guides.
3. Gently press the blade into the chassis until the alignment/ESD pin engages the chassis. When the blade is fully seated, the red buttons in the handles click up automatically, thus locking the handle and activating the switch (closed position). The click of the button gives a visual and audible confirmation that the board is fully seated.
4. Connect the following cables to the Model 3196RC:
 - The T1/E1 WAN cable (68-pin SCSI connector)
 - The iDSL modem cable (RJ-21X connector)
 - The RS-232 CONFIG cable
 - The 10/100 ETHERNET cable
5. Verify that the green *POWER* LED is lit.

Importing a saved configuration

Before importing a saved configuration, you must define the Model 3196RC's IP address and netmask. These parameters are defined via the Model 3196RC RS-232 CONFIG port on the Model 3196RC.

1. Refer to [Chapter 3, “Configuring the T-DAC for operation”](#) and follow the procedures contained in section “Initial configuration through the RS-232 control port” on page 37.
2. To import a saved configuration, connect your Web browser to the Administration Pages, then click on *Import/Export* under the Configuration Menu to display the **Import/Export** page ([figure 57](#) on page 80).
3. To import a configuration file into the Model 3196RC, type the complete path and filename for the configuration file you wish to load or click on the **Browse...** button to select the desired file, then click the **Submit Query** button.

Upon successfully importing the file, the Model 3196RC will display *Configuration Load Complete*, indicating that the new operating parameters have been loaded into flash memory.

4. On the Configuration Menu, click the *HOME* hyperlink, then click the **Hard Reset** button under *Immediate Actions*.

Note Do not select **Record Current Configuration** after importing configuration parameters.

Completing the installation

This section verifies that the Model 3196RC is fully operational.

1. Verify that the green *POWER* LED is lit. If the *POWER* LED is flashing green, refer to section “[Fault analysis](#)” on page 72.
2. Verify that the *WAN* LED illuminates, indicating that the Model 3196RC is synchronizing with the T1/E1 signal.
3. Verify that after 5 seconds, the *WAN* LED begins flashing, indicating that the Model 3196RC is satisfied with the quality of the T1/E1 signal.
4. Verify that after 10 seconds, the *WAN* LED extinguishes, indicating that the Model 3196RC is satisfied with the network signal and that the link is ready for use.
5. Verify that the green Ethernet LED is either flashing (indicating link status is nominal for the front Ethernet port) or on solid (indicating that link status is nominal for at least one of the Ethernet backplane connections).

The Model 3196RC is operational.

Chapter 6 **Contacting Patton for assistance**

Chapter contents

Introduction.....	86
Contact information.....	86
Warranty Service and Returned Merchandise Authorizations (RMAs).....	86
Warranty coverage	86
Out-of-warranty service	86
Returns for credit	86
Return for credit policy	87
RMA numbers	87
Shipping instructions	87

Introduction

This chapter contains the following information:

- “Contact information”—describes how to contact Patton technical support for assistance.
- “Warranty Service and Returned Merchandise Authorizations (RMAs)” —contains information about the RAS warranty and obtaining a return merchandise authorization (RMA).

Contact information

Patton Electronics offers a wide array of free technical services. If you have questions about any of our other products we recommend you begin your search for answers by using our technical knowledge base. Here, we have gathered together many of the more commonly asked questions and compiled them into a searchable database to help you quickly solve your problems.

- Online support—available at www.patton.com.
- E-mail support—e-mail sent to support@patton.com will be answered within 1 business day
- Telephone support—standard telephone support is available Monday through Friday, from 8:00 A.M. to 5:00 P.M. EST (8:00 to 17:00 UTC-5), Monday through Friday by calling +1 (301) 975-1007

Warranty Service and Returned Merchandise Authorizations (RMAs)

Patton Electronics is an ISO-9001 certified manufacturer and our products are carefully tested before shipment. All of our products are backed by a comprehensive warranty program.

Note If you purchased your equipment from a Patton Electronics reseller, ask your reseller how you should proceed with warranty service. It is often more convenient for you to work with your local reseller to obtain a replacement. Patton services our products no matter how you acquired them.

Warranty coverage

Our products are under warranty to be free from defects, and we will, at our option, repair or replace the product should it fail within one year from the first date of shipment. Our warranty is limited to defects in workmanship or materials, and does not cover customer damage, lightning or power surge damage, abuse, or unauthorized modification.

Out-of-warranty service

Patton services what we sell, no matter how you acquired it, including malfunctioning products that are no longer under warranty. Our products have a flat fee for repairs. Units damaged by lightning or elephants may require replacement.

Returns for credit

Customer satisfaction is important to us, therefore any product may be returned with authorization within 30 days from the shipment date for a full credit of the purchase price. If you have ordered the wrong equipment or you are dissatisfied in any way, please contact us to request an RMA number to accept your return. Patton is not responsible for equipment returned without a Return Authorization.

Return for credit policy

- Less than 30 days: No Charge. Your credit will be issued upon receipt and inspection of the equipment.
- 30 to 120 days: We will add a 20% restocking charge (crediting your account with 80% of the purchase price).
- Over 120 days: Products will be accepted for repairs only.

RMA numbers

RMA numbers are required for all product returns. You can obtain an RMA by doing one of the following:

- Completing a request on the RMA Request page in the *Support* section at www.patton.com
- By calling +1 (301) 975-1000 and speaking to a Technical Support Engineer
- By sending an e-mail to returns@patton.com

All returned units must have the RMA number clearly visible on the outside of the shipping container. Please use the original packing material that the device came in or pack the unit securely to avoid damage during shipping.

Shipping instructions

The RMA number should be clearly visible on the address label. Our shipping address is as follows:

Patton Electronics Company

RMA#: xxxx

7622 Rickenbacker Dr.

Gaithersburg, MD 20879-4773 USA

Patton will ship the equipment back to you in the same manner you ship it to us. Patton will pay the return shipping costs.

Appendix A **Network Ports (RJ-21X)** **connector pin-out**

Chapter contents

Introduction	89
--------------------	----

Introduction

Figure 60 shows the pin-out for the RJ-21X 50-pin Telco connector. Table 9 contains the band-marked color codes for the RJ-21X 50-pin Telco connector

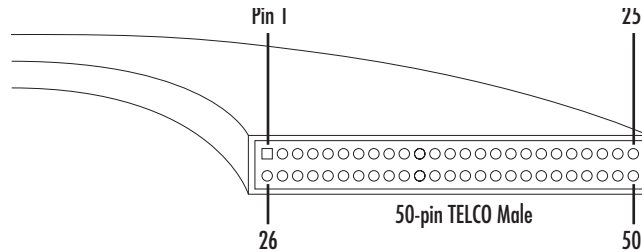

Figure 60. 50-pin Telco connector

Table 9. Band Marked Color Code

DSL Port	50 Pin Positions	Wire Color Code
Port 1	1 26	Blue/White White/Blue
Port 2	2 27	Orange/White White/Orange
Port 3	3 28	Green/White White/Green
Port 4	4 29	Brown/White White/Brown
Port 5	5 30	Slate/White White/Slate
Port 6	6 31	Blue/Red Red/Blue
Port 7	7 32	Orange/Red Red/Orange
Port 8	8 33	Green/Red Red/Green
Port 9	9 34	Brown/Red Red/Brown
Port 10	10 35	Slate/Red Red/Slate
Port 11	11 36	Blue/Black Black/Blue
Port 12	12 37	Orange/Black Black/Orange
Port 13	13 38	Green/Black Black/Green
Port 14	14 39	Brown/Black Black/Brown

Table 9. Band Marked Color Code (Continued)

DSL Port	50 Pin Positions	Wire Color Code
Port 15	15	Slate/Black
	40	Black/Slate
Port 16	16	Blue/Yellow
	41	Yellow/Blue
	17	Orange/Yellow
	42	Yellow/Orange
	18	Green/Yellow
	43	Yellow/Green
	19	Brown/Yellow
	44	Yellow/Brown
	20	Slate/Yellow
	45	Yellow/Slate
	21	Blue/Violet
	46	Violet/Blue
	22	Orange/Violet
	47	Violet/Orange
	23	Green/Violet
	48	Violet/Green
	24	Brown/Violet
	49	Violet/Brown
	25	Slate/Violet
	50	Violet/Slate

Appendix B **WAN Network Module connector pinout**

Chapter contents

Introduction	92
68-Pin Telco pinout	92

Introduction

The WAN cable is 6 feet in length comprising 34 twisted pairs. One end of the cable will have the AMP connector 749621-7 (or equivalent) and the AMP back shell 749195-2 (or equivalent). The other end will be blunt.

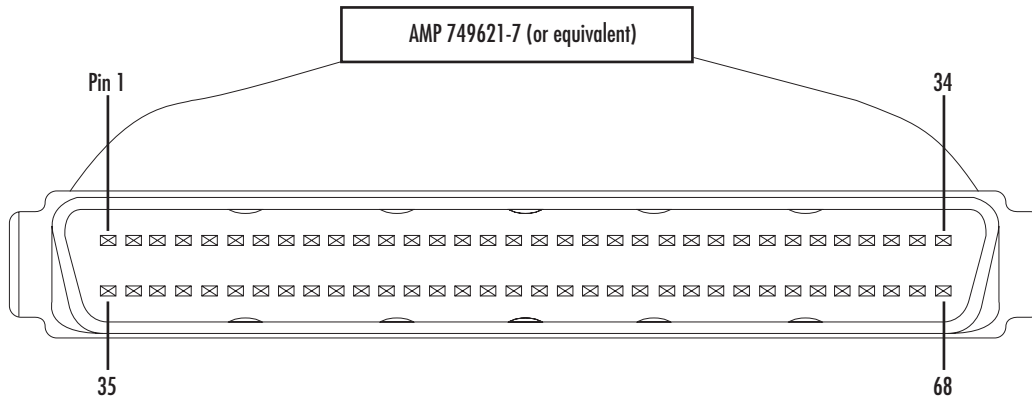

Figure 61. 68-pin SCSI connector

68-Pin Telco pinout

Table 10 show the pin-out information for the 68-pin SCSI connector with a color code chart for the twisted pairs and RJ pin out.

Table 10. WAN cable's 68 non-terminated twisted-pairs

Port/Direction	Pairs	68 Pin Positions	Wire Color Code	Port/Direction	Pairs	68 Pin Positions	Wire Color Code
Port 1/TX	1	1 35	White/Tan Tan/White	Port 9/TX	17	17 51	Tan/Gray Gray/Tan
Port 1/RX	2	2 36	White/Brown Brown/White	Port 9/RX	18	18 52	Brown/Pink Pink/Brown
Port 2/TX	3	3 37	White/Pink Pink/White	Port 10/TX	19	19 53	Brown/Orange Orange/Brown
Port 2/RX	4	4 38	White/Orange Orange/White	Port 10/RX	20	20 54	Brown/Violet Violet/Brown
Port 3/TX	5	5 39	White/Violet Violet/White	Port 11/TX	21	21 55	Brown/Blue Blue/Brown
Port 3/RX	6	6 40	White/Blue Blue/White	Port 11/RX	22	22 56	Brown/Yellow Yellow/Brown
Port 4/TX	7	7 41	White/Yellow Yellow/White	Port 12/TX	23	23 57	Brown/Green Green/Brown
Port 4/RX	8	8 42	White/Green Green/White	Port 12/RX	24	24 58	Brown/Gray Gray/Brown
Port 5/TX	9	9 43	White/Gray Gray/White	Port 13/TX	25	25 59	Pink/Orange Orange/Pink

Table 10. WAN cable's 68 non-terminated twisted-pairs (Continued)

Port/ Direction	Pairs	68 Pin Positions	Wire Color Code	Port/ Direction	Pairs	68 Pin Positions	Wire Color Code
Port 5/RX	10	10 44	Tan/Brown Brown/Tan	Port 13/RX	26	26 60	Pink/Violet Violet/Pink
Port 6/TX	11	11 45	Tan/Pink Pink/Tan	Port 14/TX	27	27 61	Pink/Blue Blue/Pink
Port 6/RX	12	12 46	Tan/Orange Orange/Tan	Port 14/RX	28	28 62	Pink/Yellow Yellow/Pink
Port 7/TX	13	13 47	Tan/Violet Violet/Tan	Port 15/TX	29	29 63	Pink/Green Green/Pink
Port 7/RX	14	14 48	Tan/Blue Blue/Tan	Port 15/RX	30	30 64	Pink/Gray Gray/Pink
Port 8/TX	15	15 49	Tan/Yellow Yellow/Tan	Port 16/TX	31	31 65	Orange/Violet Violet/Orange
Port 8/RX	16	16 50	Tan/Green Green/Tan	Port 16/RX	32	32 66	Orange/Blue Violet/Blue
	—	33 67	NOT USED		—	34 68	NOT USED

Free Manuals Download Website

<http://myh66.com>

<http://usermanuals.us>

<http://www.somanuals.com>

<http://www.4manuals.cc>

<http://www.manual-lib.com>

<http://www.404manual.com>

<http://www.luxmanual.com>

<http://aubethermostatmanual.com>

Golf course search by state

<http://golfingnear.com>

Email search by domain

<http://emailbydomain.com>

Auto manuals search

<http://auto.somanuals.com>

TV manuals search

<http://tv.somanuals.com>