

USER MANUAL

MODEL 222N and 222NS Miniature RS-232 to RS-422 Converters



PA PATTON
IE Electronics Co.



An ISO-9001
Certified Company

Part #07M222N-C
Doc. #023022U, Rev. D
Revised 1/23/08

SALES OFFICE
(301) 975-1000
TECHNICAL SUPPORT
(301) 975-1007
<http://www.patton.com>

1.0 WARRANTY INFORMATION

Patton Electronics warrants all Model 222N components to be free from defects, and will—at our option—repair or replace the product should it fail within one year from the first date of shipment.

This warranty is limited to defects in workmanship or materials, and does not cover customer damage, abuse, or unauthorized modification. If this product fails or does not perform as warranted, your sole recourse shall be repair or replacement as described above. Under no condition shall **Patton Electronics** be liable for any damages incurred by the use of this product. These damages include, but are not limited to, the following: lost profits, lost savings, and incidental or consequential damages arising from the use of or inability to use this product. **Patton Electronics** specifically disclaims all other warranties, expressed or implied, and the installation or use of this product shall be deemed an acceptance of these terms by the user.

1.1 RADIO AND TV INTERFERENCE

The Model 222N generates and uses radio frequency energy, and if not installed and used properly—that is, in strict accordance with the manufacturer's instructions—may cause interference to radio and television reception. The Model 222N has been tested and found to comply with the limits for a Class A computing device in accordance with the specifications in Subpart J of Part 15 of FCC rules, which are designed to provide reasonable protection from such interference in a commercial installation. However, there is no guarantee that interference will not occur in a particular installation. If the Model 222N does cause interference to radio or television reception, which can be determined by disconnecting the RS-232 interface, the user is encouraged to try to correct the interference by one or more of the following measures: moving the computing equipment away from the receiver, re-orienting the receiving antenna, and/or plugging the receiving equipment into a different AC outlet (such that the computing equipment and receiver are on different branches).

1.2 CE NOTICE

The CE symbol on your Patton Electronics equipment indicates that it is in compliance with the Electromagnetic Compatibility (EMC) directive and the Low Voltage Directive (LVD) of the Union European (EU). A Certificate of Compliance is available by contacting Patton Technical Support.

1.3 SERVICE

All warranty and non-warranty repairs must be returned freight prepaid and insured to Patton Electronics. All returns must have a Return Materials Authorization number on the outside of the shipping container. This number may be obtained from Patton Electronics Technical Service at **(301) 975-1007**, **<http://www.patton.com>**, or **support@patton.com**.

NOTE: Packages received without an RMA number will not be accepted.

Patton Electronics' technical staff is also available to answer any questions that might arise concerning the installation or use of your Model 222N. Technical Service hours: **8AM to 5PM EST, Monday through Friday**.

2.0 GENERAL INFORMATION

Thank you for your purchase of this Patton Electronics product. This product has been thoroughly inspected and tested and is warranted for One Year parts and labor. If any questions or problems arise during installation or use of this product, please do not hesitate to contact Patton Electronics Technical Support at (301) 975-1007.

2.1 FEATURES

- Bi-directionally converts RS-232 signals to balanced RS-422
- DCE/DTE switch selectable on RS-232 interface
- Supports transmit and receive data (X-ON/X-OFF flow control)
- Loops back all handshaking signals on the RS-232 interface
- Very thin case (.75") for closely spaced computer ports
- No AC power or batteries required—draws all necessary operating power from RS-232 interface
- Supports data rates to 19,200 bps

2.2 DESCRIPTION

The Patton Model 222N interface converter allows computers, terminals and modems employing the RS-232E interface to communicate with devices using RS-422 balanced electrical signals. This unit derives the necessary power for operation from the data and control voltages on the RS-232 interface. The 222N features bi-directional data conversion at full or half duplex at distances up to 3.5 miles.

An external DCE/DTE switch lets you connect to the serial port of either a computer/terminal (DTE) or a modem (DCE) without using a crossover cable. The Model 222N is available with several RS-422 interface options: DB-25 male or female (following the RS-530 standard), RJ-11, RJ-45, or terminal blocks with strain relief.

The surge protected Model 222NS uses high speed avalanche diodes to intercept data line transient surges and shunt them safely to chassis ground. Compliant with IEC 801.5 level 2, 1kV, the 222NS can protect itself and connected equipment from nearby lightning strikes, and other surges of electromagnetic radiation.

3.0 CONFIGURATION

The Model 222N is designed to be easy to use. There are no internal jumpers or DIP switches to set, so there is no need to open the case to configure the unit (you may need to open the case for wire connection—refer to section 4.0). The only configuration necessary for operation is proper setting of the external DTE/DCE switch.

The figure below shows the location of the DTE/DCE switch on the PC board, as well as the location of the terminal block and surge suppressors ("S" model only).

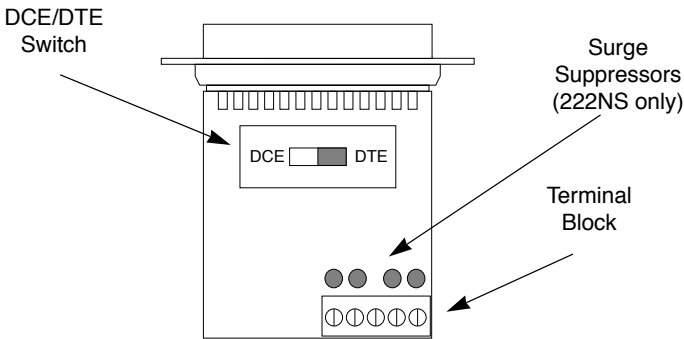

3.1 SETTING THE DTE/DCE SWITCH

For your convenience, the Model 222N has an externally accessible DTE/DCE switch (see diagram below). If the device connected to the Model 222N is a modem or multiplexer (or is wired like one), set the switch to "DTE". This setting causes the Model 222N to behave like Data Terminal Equipment and transmit data on pin 2.

If the device connected to the Model 222N is a PC, terminal or host computer (or is wired like one), set the switch to "DCE". This setting causes the Model 222N to behave like Data Communications Equipment and transmit data on pin 3.

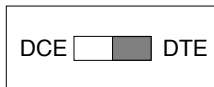

4.0 INSTALLATION

Once you have properly configured the DTE/DCE switch, you are ready to connect the Model 222N to your system. This section tells you how to properly connect the Model 222N to the RS-422 and RS-232 interfaces, and how to operate the Model 222N.

4.1 CONNECTION TO THE RS-422 INTERFACE

The Model 222N supports data-only communication distances up to 4000 feet between itself and the RS-422 device. To function properly, the Model 222N *must* have two twisted pairs of metallic wire. These pairs must be dry, unconditioned metallic wire, between 19 and 26 AWG (the higher number gauges may limit distance somewhat).

For your convenience, the Model 222N is available with several different physical interfaces on the RS-422 side: DB-25 (following the RS-530 standard), RJ-11 jack, RJ-45 jack, and terminal blocks with strain relief.

4.1.1 RS-422 CONNECTION USING THE DB-25

The DB-25 connector on the Model 222N's RS-422 side conforms to the RS-530 interface standard (See Appendix C). When connecting to an RS-422 device that also conforms to the RS-530 standard, your cable should be "crossed over" in the manner shown below:

MODEL 222N		RS-422 (530) DEVICE	
SIGNAL	DB-25 PIN[†]	DB-25 PIN	SIGNAL
XMT+	2	3	RCV+
XMT-	14	16	RCV-
RCV+	3	2	XMT+
RCV-	16	14	XMT-

[†]The DB-25 connector that is farthest from the DTE/DCE switch

NOTE: It is not necessary that the RS-422 device adhere to the RS-530 standard. However, you must make sure that the signals, polarities, and pairing of your connection conform to the above diagram.

4.1.2 RS-422 CONNECTION USING RJ-11 OR RJ-45

The RJ-11 and RJ-45 connectors on the Model 222N's RS-422 side are pre-wired for a standard TELCO wiring environment. The signal/pin relationships are shown below:

<u>RJ-11</u>	<u>SIGNAL</u>	<u>RJ-45</u>	<u>SIGNAL</u>
1.....	GND*	1	N/C
2.....	RCV-	2	GND*
3.....	XMT+	3	RCV-
4.....	XMT-	4	XMT+
5.....	RCV+	5	XMT-
6.....	GND	6	RCV+
		7	GND
		8	N/C

In most modular RS-422 applications, it is necessary to use a "cross over" cable. The diagram below shows how a cross over cable should be constructed for an environment where both the Model 222N and the RS-422 device use a 6-wire RJ-11 connector. Similar logic should be followed when using RJ-45 connectors or a combination of the two.

<u>MODEL 222N</u>			<u>RS-422 DEVICE</u>		
<u>SIGNAL</u>	<u>PIN#</u>	<u>COLOR</u>	<u>COLOR</u>	<u>PIN#</u>	<u>422 SIGNAL</u>
GND [†]	1	Blue [†]	N/C		
RCV-	2	Yellow	Red	4	XMT-
XMT+	3	Green	Black	5	RCV+
XMT-	4	Red	Yellow	2	RCV-
RCV+	5	Black	Green	3	XMT+
GND [†]	6	White	N/C		

[†]Connection to ground is optional

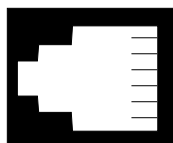

- 1 - Blue
- 2 - Yellow
- 3 - Green
- 4 - Red
- 5 - Black
- 6 - White

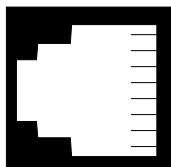

- 1 - Blue
- 2 - Orange
- 3 - Black
- 4 - Red
- 5 - Green
- 6 - Yellow
- 7 - Brown
- 8 - Slate

[†]Standard AT&T color codes—yours may be different

4.1.3 RS-422 CONNECTION USING TERMINAL BLOCKS

If your RS-422 application requires you to connect two pairs of bare wires to the Model 222N, you will need to open the case to access the terminal blocks. The following instructions will tell you how to open the case, connect the bare wires to the terminal blocks, and fasten the strain relief collar in place so that the wires won't pull loose.

1. Open the unit by gently inserting a screwdriver between the DB-25 connector and the lip of the plastic case (see below). You don't have to worry about breaking the plastic, but be careful not to bend the D-sub connector.

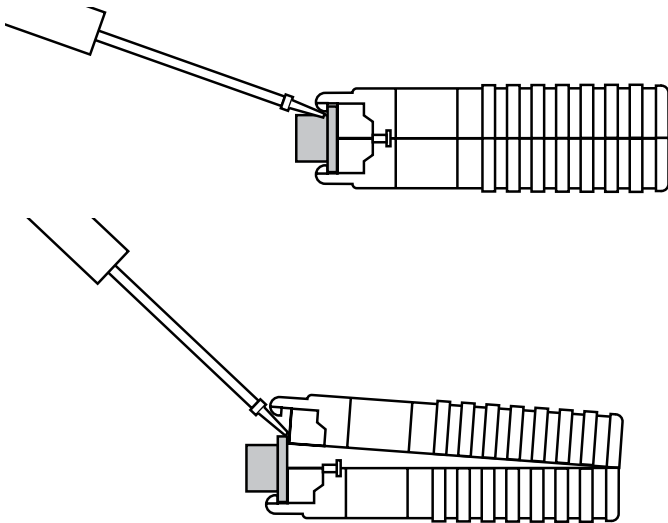

Once the unit has been opened, you will be able to see the terminal blocks located at the rear of the PC board.

2. Strip the outer insulation from the twisted pairs about one inch from the end.

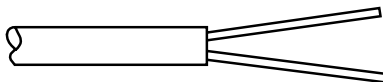

3. Strip back the insulation on each of the 2 twisted pair wires about .25".

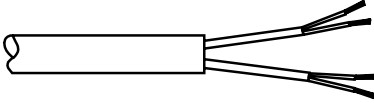

4. Connect *one pair* of wires to XMT+ and XMT- (transmit positive and negative) on the terminal block, making careful note of which color is positive, and which color is negative.

5. Connect the *other pair* of wires to RCV+ and RCV- (receive positive and negative) on the terminal block, again making careful note of which color is positive, and which color is negative.

Ultimately, you will want to construct a two pair cross over cable that makes a connection with the RS-422 device as shown below:

<u>Model 222N</u>	<u>RS-422 Device</u>
XMT+.....	RCV+
XMT-.....	RCV-
RCV+.....	XMT+
RCV-.....	XMT-

6. If there is a shield around the telephone cable, it may be connected to "G" on the terminal block. To avoid ground loops, we recommend connecting the shield at one end only. A ground wire is *not necessary* for proper operation of the Model 222N.

7. When you finish connecting the wires to the terminal block, the assembly should resemble the diagram below:

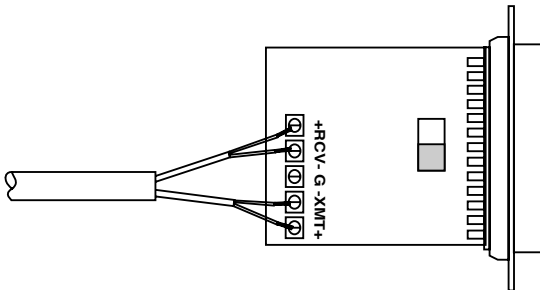

8. Place the 2 halves of the strain relief assembly on either side of the telephone wire and press together very lightly. Slide the assembly so that it is about 2 inches from the terminal posts and press together firmly. If your cable diameter is too small or too large for our strain relief, please contact our technical support. We have strain relief assemblies to accommodate most cable diameters.

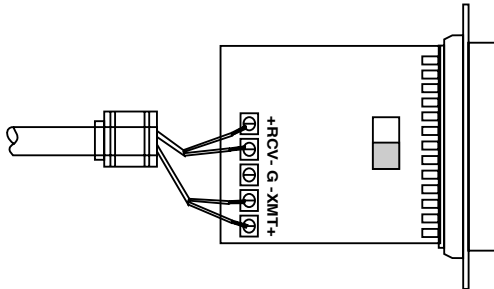

9. Insert the strain relief assembly with the wire going through it into the slot in the bottom half of the modem case and set it into the recess in the case.

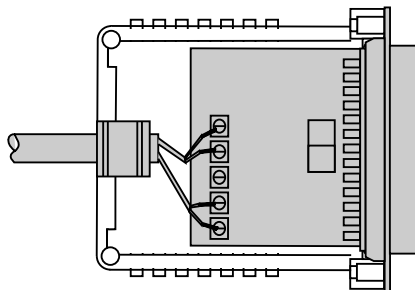

10. BEND the top half of the case as necessary to place it over the strain relief assembly. Do not snap the case together yet.

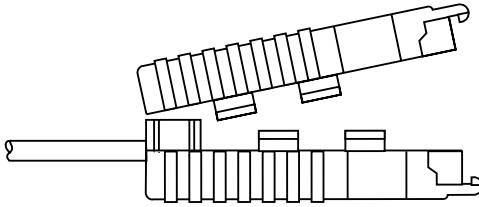

11. Insert one captive screw through a saddle washer, then insert the captive screw with the washer on it through the hole in the DB-25 end of the case. Snap that side of the case closed. Repeat the process for the other side. This completes the cable installation process.

4.2 CONNECTION TO THE RS-232 INTERFACE

Once you have configured the Model 222N for DTE or DCE and connected the twisted pair wires correctly, simply plug the 222N directly into the DB-25 port of the RS-232 device. After doing so, remember to insert and tighten the two captive connector screws.

NOTE: If you must use a cable to connect the Model 222N to the RS-232 device, make sure it is a *straight through* cable of the shortest possible length—we recommend 6 ft or less.

4.3 OPERATING THE MODEL 222N

Once the Model 222N is properly installed, it should operate transparently—as if it were a standard cable connection. Operating power is derived from the RS-232 data and control signals; there is no "ON/OFF" switch. All data signals from the RS-232 and RS-422 interfaces are passed straight through. All control signals from the RS-232 interface are looped back.

NOTE: If your system requires *hardware* flow control, you will need the Patton Model 285 RS-232 to RS-485 converter. Call Patton Customer Service at 301-975-1007.

APPENDIX A

PATTON MODEL 222N SPECIFICATIONS

Date Rates:	19,200 bps (according to the RS-232 interface)
Transmission Format:	Asynchronous
Transmission Mode:	Full/half duplex
Power:	AC power not required, derives approximately 3mA from RS-232 data and control voltages
Surge Protection:	Compliant with IEC 801.5 level 2, 1kV (Model 222NS Only)
Factory Switch Setting:	DCE; data is received from the remote short range modem via RX+ and RX-, and is sent to the DTE from the Model 222N via pin 3 of the RS-232 interface; (the RS-232 interface is the DB-25 connector closest to the DTE/DCE switch).
Dimensions:	2.20" x 1.75" x .75"

APPENDIX B

PATTON MODEL 222N CABLE RECOMMENDATIONS

The Patton Model 222N operates at frequencies of 20kHz or less and has been performance tested by Patton technicians using twisted-pair cable with the following characteristics:

<u>Wire Gauge</u>	<u>Capacitance</u>	<u>Resistance</u>
19 AWG/.9mm	83nf/mi or 15.72 pf/ft.	.0163 Ohms/ft.
22 AWG/.6mm	83nf/mi or 15.72 pf/ft.	.0326 Ohms/ft.
24 AWG/.5mm	83nf/mi or 15.72 pf/ft.	.05165 Ohms/ft.

To gain optimum performance from the Model 222N, please keep the following guidelines in mind:

- *Always* use **twisted pair** wire—this is not an option.
- Use twisted pair wire with a capacitance of 20pf/ft or less.
- Avoid twisted pair wire thinner than 26 AWG (i.e. avoid higher AWG numbers than 26)
- Use of twisted pair with a resistance greater than the above specifications may cause a reduction in maximum distance obtainable. Functionality should not be affected.
- Environmental factors too numerous to mention can affect the maximum distances obtainable at a particular site. Use “maximum distance” figures as a **general guideline only**.

APPENDIX C

PATTON MODEL PIN ASSIGNMENTS

EIA-232 Interface (DB-25 Connector)

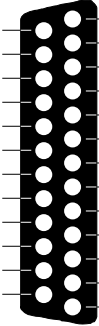
DIRECTION	STANDARD "DCE" SETTING	DIRECTION
To Model 222N	 <p style="text-align: center;">Data Term. Ready (DTR) - 20</p>	To Model 222N From Model 222N To Model 222N From Model 222N From Model 222N From Model 222N

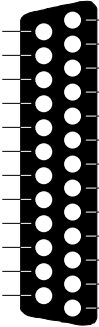
DIRECTION	STANDARD "DTE" SETTING	DIRECTION
From Model 222N	 <p style="text-align: center;">Data Term. Ready (DTR) - 20</p>	From Model 222N To Model 222N From Model 222N To Model 222N To Model 222N To Model 222N

APPENDIX C

PATTON MODEL PIN ASSIGNMENTS

EIA-422 (EIA-530) Interface (DB-25 Connector)

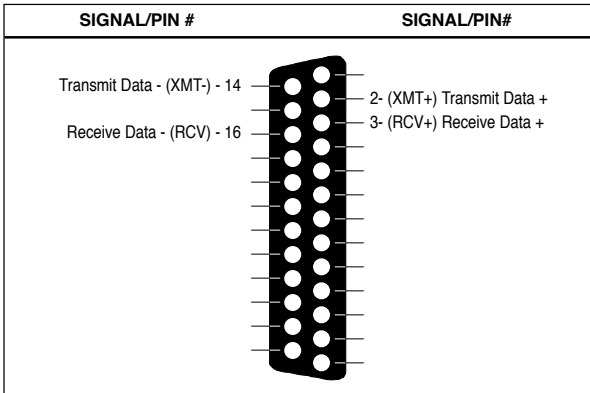

EIA-422 Interface (RJ-11 Female Connector)

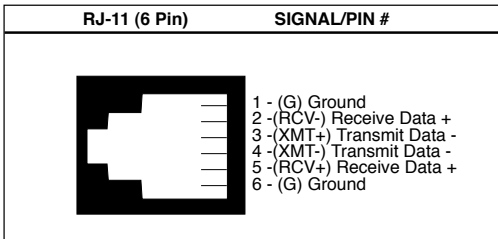

EIA-422 Interface (RJ-45 Female Connector)

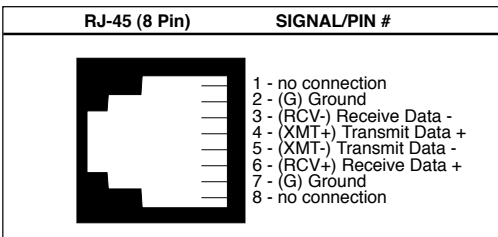

NOTE: Signals XMT+ and XMT- are the EIA-422 "A" and "B" transmitters, respectively; Signals RCV+ and RCV- are the EIA-422 "A" and "B" receivers, respectively.

APPENDIX D

PATTON MODEL 222N BLOCK DIAGRAM

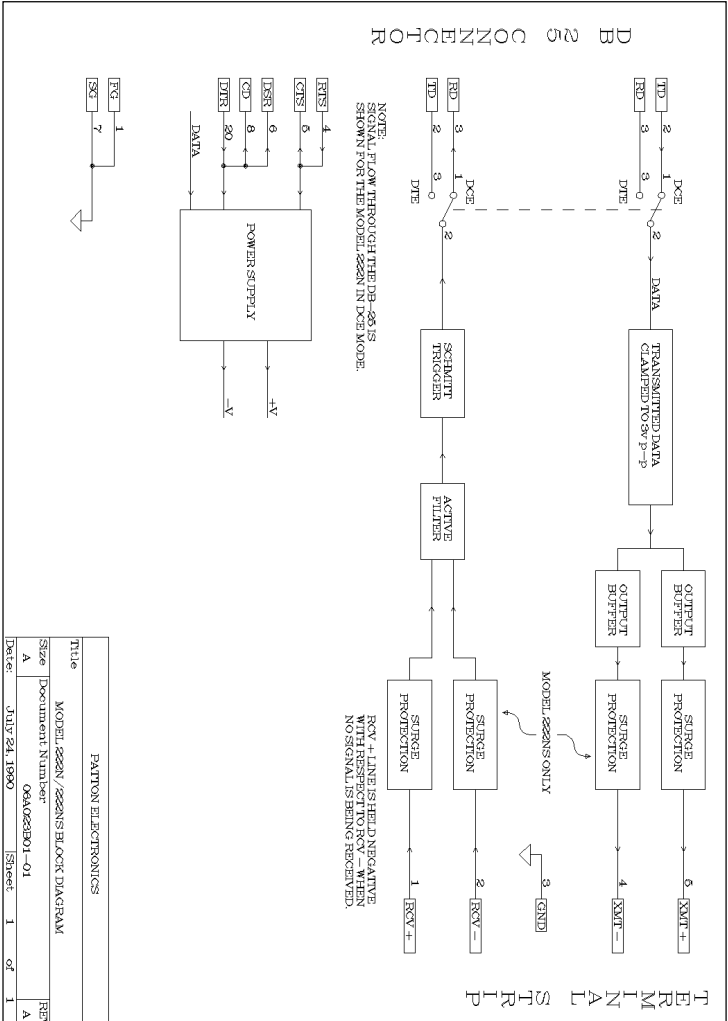

Copyright © 1997
 Patton Electronics Company
 All Rights Reserved

Dear Valued Customer,

Thank you for purchasing Patton Electronics products! We do appreciate your business. I trust that you find this user manual helpful.

We manufacture one of the widest selections of data communications products in the world including CSU/DSU's, network termination units, powered and self-powered short range modems, fiber optic modems, interface converters, baluns, electronic data switches, data-line surge protectors, multiplexers, transceivers, hubs, print servers and much more. We produce these products at our Gaithersburg, MD, USA, facility, and can custom manufacture products for your unique needs.

We would like to hear from you. Please contact us in any of the following ways to tell us how you like this product and how we can meet your product needs today and in the future.

Web:	http://www.patton.com
Sales E-mail:	sales@patton.com
Support E-mail:	support@patton.com
Phone - Sales	(301) 975-1000
Phone - Support	(301) 975-1007
Fax:	(301) 869-9293
Mail:	Patton Electronics Company 7622 Rickenbacker Drive Gaithersburg, MD 20879 USA

We are committed to a quality product at a quality price. Patton Electronics is ISO 9001 certified. We meet and exceed the highest standards in the industry (CE, UL, etc.).

It is our business to serve you. If you are not satisfied with any aspect of this product or the service provided from Patton Electronics or its distributors, please let us know.

Thank you.

Burton A.Patton
Vice President

P.S. Please tell us where you purchased this product.

Free Manuals Download Website

<http://myh66.com>

<http://usermanuals.us>

<http://www.somanuals.com>

<http://www.4manuals.cc>

<http://www.manual-lib.com>

<http://www.404manual.com>

<http://www.luxmanual.com>

<http://aubethermostatmanual.com>

Golf course search by state

<http://golfingnear.com>

Email search by domain

<http://emailbydomain.com>

Auto manuals search

<http://auto.somanuals.com>

TV manuals search

<http://tv.somanuals.com>