



ProComm[®] PCX[™] -U7 True Diversity UHF Wireless Receiver

Operating
Manual



www.peavey.com



Intended to alert the user to the presence of uninsulated “dangerous voltage” within the product’s enclosure that may be of sufficient magnitude to constitute a risk of electric shock to persons.



Intended to alert the user of the presence of important operating and maintenance (servicing) instructions in the literature accompanying the product.

CAUTION: Risk of electrical shock — DO NOT OPEN!

CAUTION: To reduce the risk of electric shock, do not remove cover. No user serviceable parts inside. Refer servicing to qualified service personnel.

WARNING: To prevent electrical shock or fire hazard, this apparatus should not be exposed to rain or moisture, and objects filled with liquids, such as vases, should not be placed on this apparatus. Before using this apparatus, read the operating guide for further warnings.

ENGLISH



Este símbolo tiene el propósito, de alertar al usuario de la presencia de “(voltaje) peligroso” sin aislamiento dentro de la caja del producto y que puede tener una magnitud suficiente como para constituir riesgo de descarga eléctrica.



Este símbolo tiene el propósito de alertar al usuario de la presencia de instrucciones importantes sobre la operación y mantenimiento en la información que viene con el producto.

PRECAUCION: Riesgo de descarga eléctrica ¡NO ABRIR!

PRECAUCION: Para disminuir el riesgo de descarga eléctrica, no abra la cubierta. No hay piezas útiles dentro. Deje todo mantenimiento en manos del personal técnico cualificado.

ADVERTENCIA: Para prevenir choque eléctrico o riesgo de incendios, este aparato no se debe exponer a la lluvia o a la humedad. Los objetos llenos de líquidos, como los floreros, no se deben colocar encima de este aparato. Antes de usar este aparato, lea la guía de funcionamiento para otras advertencias.

ESPAÑOL



Ce symbole est utilisé dans ce manuel pour indiquer à l'utilisateur la présence d'une tension dangereuse pouvant être d'amplitude suffisante pour constituer un risque de choc électrique.



Ce symbole est utilisé dans ce manuel pour indiquer à l'utilisateur qu'il ou qu'elle trouvera d'importantes instructions concernant l'utilisation et l'entretien de l'appareil dans le paragraphe signalé.

ATTENTION: Risques de choc électrique — NE PAS OUVRIR!

ATTENTION: Afin de réduire le risque de choc électrique, ne pas enlever le couvercle. Il ne se trouve à l'intérieur aucune pièce pouvant être réparée par l'utilisateur. Confiez l'entretien et la réparation de l'appareil à un réparateur Peavey agréé.

AVIS: Dans le but de réduire les risques d'incendie ou de décharge électrique, cet appareil ne doit pas être exposé à la pluie ou à l'humidité et aucun objet rempli de liquide, tel qu'un vase, ne doit être posé sur celui-ci. Avant d'utiliser de cet appareil, lisez attentivement le guide fonctionnant pour avertissements supplémentaires.

FRANÇAIS

IMPORTANT SAFETY INSTRUCTIONS

WARNING: When using electrical products, basic cautions should always be followed, including the following:

1. Read these instructions.
2. Keep these instructions.
3. Heed all warnings.
4. Follow all instructions.
5. Do not use this apparatus near water.
6. Clean only with a dry cloth.
7. Do not block any of the ventilation openings. Install in accordance with manufacturer's instructions.
8. Do not install near any heat sources such as radiators, heat registers, stoves or other apparatus (including amplifiers) that produce heat.
9. Do not defeat the safety purpose of the polarized or grounding-type plug. A polarized plug has two blades with one wider than the other. A grounding type plug has two blades and a third grounding plug. The wide blade or third prong is provided for your safety. If the provided plug does not fit into your outlet, consult an electrician for replacement of the obsolete outlet.
10. Protect the power cord from being walked on or pinched, particularly at plugs, convenience receptacles, and the point they exit from the apparatus.
11. Only use attachments/accessories provided by the manufacturer.
12. Use only with a cart, stand, tripod, bracket, or table specified by the manufacturer, or sold with the apparatus. When a cart is used, use caution when moving the cart/apparatus combination to avoid injury from tip-over.
13. Unplug this apparatus during lightning storms or when unused for long periods of time.
14. Refer all servicing to qualified service personnel. Servicing is required when the apparatus has been damaged in any way, such as power-supply cord or plug is damaged, liquid has been spilled or objects have fallen into the apparatus, the apparatus has been exposed to rain or moisture, does not operate normally, or has been dropped.
15. Never break off the ground pin. Write for our free booklet "Shock Hazard and Grounding." Connect only to a power supply of the type marked on the unit adjacent to the power supply cord.
16. If this product is to be mounted in an equipment rack, rear support should be provided.
17. This electrical apparatus should not be exposed to dripping or splashing and care should be taken not to place objects containing liquids, such as vases, upon the apparatus.
18. The on/off switch in this unit does not break both sides of the primary mains. Hazardous energy can be present inside the chassis when the on/off switch is in the off position. The mains plug or appliance coupler is used as the disconnect device, the disconnect device shall remain readily operable.
19. Exposure to extremely high noise levels may cause a permanent hearing loss. Individuals vary considerably in susceptibility to noise-induced hearing loss, but nearly everyone will lose some hearing if exposed to sufficiently intense noise for a sufficient time. The U.S. Government's Occupational Safety and Health Administration (OSHA) has specified the following permissible noise level exposures:

Duration Per Day In Hours	Sound Level dBA, Slow Response
8	90
6	92
4	95
3	97
2	100
1 1/2	102
1	105
1/2	110
1/4 or less	115

According to OSHA, any exposure in excess of the above permissible limits could result in some hearing loss. Ear plugs or protectors to the ear canals or over the ears must be worn when operating this amplification system in order to prevent a permanent hearing loss, if exposure is in excess of the limits as set forth above. To ensure against potentially dangerous exposure to high sound pressure levels, it is recommended that all persons exposed to equipment capable of producing high sound pressure levels such as this amplification system be protected by hearing protectors while this unit is in operation.

SAVE THESE INSTRUCTIONS!

FCC Class B Notice

If your system is FCC Class B, the following applies:

Note – **This equipment has been tested and found to comply with the limits for a Class B digital device, pursuant to Part 15 of the FCC Rules.** These limits are designed to provide reasonable protection against harmful interference in a residential installation. This equipment generates, uses and can radiate radio frequency energy and, if not installed and used in accordance with the instructions, may cause harmful interference to radio communications. However, there is no guarantee that interference will not occur in a particular installation. If this equipment does cause harmful interference to radio or television reception, which can be determined by turning the equipment off and on, the user is encouraged to try to correct the interference by one or more of the following measures:

- Reorient or relocate the receiving antenna.
- Increase the separation between the equipment and receiver.
- Connect the equipment into an outlet on a circuit different from that to which the receiver is connected.
- Consult the dealer or an experienced radio/TV technician for help.

INSTRUCCIONES IMPORTANTES PARA SU SEGURIDAD

CUIDADO: Cuando use productos electrónicos, debe tomar precauciones básicas, incluyendo las siguientes:



1. Lea estas instrucciones.
2. Guarde estas instrucciones.
3. Haga caso de todos los consejos.
4. Siga todas las instrucciones.
5. No usar este aparato cerca del agua.
6. Limpiar solamente con una tela seca.
7. No bloquear ninguna de las salidas de ventilación. Instalar de acuerdo a las instrucciones del fabricante.
8. No instalar cerca de ninguna fuente de calor como radiadores, estufas, hornos u otros aparatos (incluyendo amplificadores) que produzcan calor.
9. No retire la patilla protectora del enchufe polarizado o de tipo "a Tierra". Un enchufe polarizado tiene dos puntas, una de ellas más ancha que la otra. Un enchufe de tipo "a Tierra" tiene dos puntas y una tercera "a Tierra". La punta ancha (la tercera) se proporciona para su seguridad. Si el enchufe proporcionado no encaja en su enchufe de red, consulte a un electricista para que reemplace su enchufe obsoleto.
10. Proteja el cable de alimentación para que no sea pisado o pinchado, particularmente en los enchufes, huecos, y los puntos que salen del aparato.
11. Usar solamente añadidos/accesorios proporcionados por el fabricante.
12. Usar solamente un carro, pie, trípode, o soporte especificado por el fabricante, o vendido junto al aparato. Cuando se use un carro, tenga cuidado al mover el conjunto carro/aparato para evitar que se dañe en un vuelco. No suspenda esta caja de ninguna manera.
13. Desenchufe este aparato durante tormentas o cuando no sea usado durante largos periodos de tiempo.
14. Para cualquier reparación, acuda a personal de servicio cualificado. Se requieren reparaciones cuando el aparato ha sido dañado de alguna manera, como cuando el cable de alimentación o el enchufe se han dañado, algún líquido ha sido derramado o algún objeto ha caído dentro del aparato, el aparato ha sido expuesto a la lluvia o la humedad, no funciona de manera normal, o ha sufrido una caída.
15. Nunca retire la patilla de Tierra. Escríbanos para obtener nuestro folleto gratuito "Shock Hazard and Grounding" ("Peligro de Electrocuación y Toma a Tierra"). Conecte el aparato sólo a una fuente de alimentación del tipo marcado al lado del cable de alimentación.
16. Si este producto va a ser enracado con más equipo, use algún tipo de apoyo trasero.
17. Este aparato eléctrico no debe ser sometido a ningún tipo de goteo o salpicadura y se debe tener cuidado para no poner objetos que contengan líquidos, como vasos, sobre el aparato.
18. El interruptor de en/lejos en esta unidad no rompe ambos lados de la red primaria. La energía peligrosa puede ser presente dentro del chasis cuando el interruptor de en/lejos está en el de la posición. El tapón de la red o el acoplador del aparato son utilizados como el desconecta dispositivo, el desconecta dispositivo se quedará fácilmente operable.
19. La exposición a altos niveles de ruido puede causar una pérdida permanente en la audición. La susceptibilidad a la pérdida de audición provocada por el ruido varía según la persona, pero casi todo el mundo perderá algo de audición si se expone a un nivel de ruido suficientemente intenso durante un tiempo determinado. El Departamento para la Salud y para la Seguridad del Gobierno de los Estados Unidos (OSHA) ha especificado las siguientes exposiciones al ruido permisibles:

Duración por Día en Horas	Nivel de Sonido dBA, Respuesta Lenta
8	90
6	92
4	95
3	97
2	100
1 1/2	102
1	105
1/2	110
1/4 o menos	115

De acuerdo al OSHA, cualquier exposición que exceda los límites arriba indicados puede producir algún tipo de pérdida en la audición. Protectores para los canales auditivos o tapones para los oídos deben ser usados cuando se opere con este sistema de sonido para prevenir una pérdida permanente en la audición, si la exposición excede los límites indicados más arriba. Para protegerse de una exposición a altos niveles de sonido potencialmente peligrosa, se recomienda que todas las personas expuestas a equipamiento capaz de producir altos niveles de presión sonora, tales como este sistema de amplificación, se encuentren protegidas por protectores auditivos mientras esta unidad esté operando.

GUARDE ESTAS INSTRUCCIONES!

INSTRUCTIONS IMPORTANTES DE SECURITE

ATTENTION: L'utilisation de tout appareil électrique doit être soumise aux précautions d'usage incluant:



1. Lire ces instructions.
2. Gardez ce manuel pour de futures références.
3. Prêtez attention aux messages de précautions de ce manuel.
4. Suivez ces instructions.
5. N'utilisez pas cette unité proche de plans d'eau.
6. N'utilisez qu'un tissu sec pour le nettoyage de votre unité.
7. N'obstruez pas les systèmes de refroidissement de votre unité et installez votre unité en fonction des instructions de ce manuel.
8. Ne positionnez pas votre unité à proximité de toute source de chaleur.
9. Connectez toujours votre unité sur une alimentation munie de prise de terre utilisant le cordon d'alimentation fourni.
10. Protégez les connecteurs de votre unité et positionnez les cablages pour éviter toutes déconnexions accidentelles.
11. N'utilisez que des fixations approuvées par le fabricant.
12. Lors de l'utilisation sur pied ou pole de support, assurez dans le cas de déplacement de l'ensemble enceinte/support de prévenir tout basculement intempestif de celui-ci.
13. Il est conseillé de déconnecter du secteur votre unité en cas d'orage ou de durée prolongée sans utilisation.
14. Seul un technicien agréé par le fabricant est à même de réparer/contrôler votre unité. Celle-ci doit être contrôlée si elle a subi des dommages de manipulation, d'utilisation ou de stockage (humidité,...).
15. Ne déconnectez jamais la prise de terre de votre unité.
16. Si votre unité est destinée à être montée en rack, des supports arrière doivent être utilisés.
17. Cet équipement électrique ne doit en aucun cas être en contact avec un quelconque liquide et aucun objet contenant un liquide, vase ou autre ne devrait être posé sur celui-ci.
18. L'interrupter (on-off) dans cette unité ne casse pas les deux côtés du primaire principal. L'énergie hasardeuse peut être présente dans châssis quand l'interrupter (on-off) est dans le de la position. Le bouchon principal ou atelage d'appareil est utilisé comme le débrancher l'appareil restera facilement opérable.
19. Une exposition à de hauts niveaux sonores peut conduire à des dommages de l'écoute irréversibles. La susceptibilité au bruit varie considérablement d'un individu à l'autre, mais une large majorité de la population expérimentera une perte de l'écoute après une exposition à une forte puissance sonore pour une durée prolongée. L'organisme de la santé américaine (OSHA) a produit le guide ci-dessous en rapport à la perte occasionnée:

Durée par jour (heures)	Niveau sonore moyen (dBA)
8	90
6	92
4	95
3	97
2	100
1 1/2	102
1	105
1/2	110
1/4 ou inférieur	115

D'après les études menées par le OSHA, toute exposition au delà des limites décrites ce-dessus entrainera des pertes de l'écoute chez la plupart des sujets. Le port de système de protection (casque, oreillette de filtrage,...) doit être observé lors de l'opération cette unité ou des dommages irréversibles peuvent être occasionnés. Le port de ces systèmes doit être observé par toutes personnes susceptibles d'être exposées à des conditions au delà des limites décrites ci-dessus.

GARDEZ CES INSTRUCTIONS!



ENGLISH

INTRODUCTION

Thank you for selecting a Peavey ProComm® PCX™-U7 quartz controlled single channel true diversity wireless microphone system. Before operating and installing this system please read this operating guide carefully and thoroughly in order to attain the correct operating procedures and to achieve the best results.

True Diversity Receiver

The Peavey ProComm PCX-U7 quartz controlled receiver is a true diversity wireless system. This system is also equipped with “Superior frequency tracking and muting techniques” that is effective in eliminating the random noise interference when the receiver is in standby state. The Peavey ProComm PCX-U7 receiver is equipped with both balanced and unbalanced outputs.

This system includes the following accessories:

- AC/DC Adapter
- Mic Clip
- Antenna (2)
- Operating Guide

I. UNIT FEATURES AND FUNCTIONS

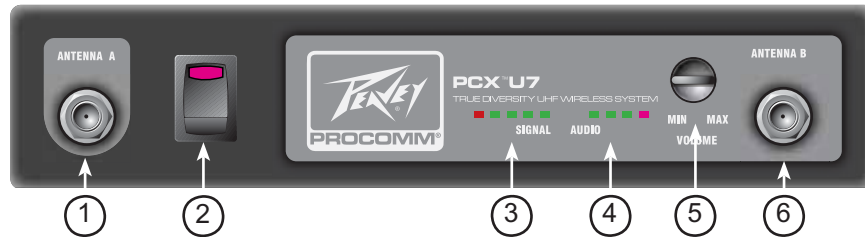

Front Panel

1. Antenna Input Connector

2. Power Switch and Indicator:

When the switch is turned on the red indicator illuminates to denote normal power status.

3. RF Signal Level Indicator:

Indicates the RF signal strength received from the microphone. As soon as the signal is emitted from the microphone the LED indicator illuminates.

4. Audio Signal Level Indicator:

Indicates the audio signal level. As soon as the microphone signal is modulated, the LED indicator illuminates.

5. Volume Control:

Adjusts the AF output level of the receiver.

6. Antenna Input Connector

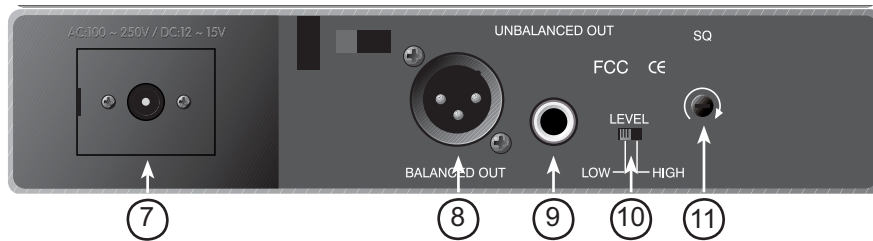

Rear Panel

7. DC 12V Input Jack:

Connect the 12V DC plug from the AC/DC adapter.

8. Balanced Audio Output Jack:

XLR type connector

9. Unbalanced Audio Output Jack:

1/4" Phone Jack

10. Unbalanced Level Switch:

“LOW selection is for “Microphone-Level” output.

“HIGH” selection is for “Line-Out” level output.

11. Squelch Adjustment:

Adjust the squelch level to eliminate the RF noise interference at the receiver.

II. INSTALLATION OF THE RECEIVER

1. Install one of the antennas at one antenna input connector . Then install the other antenna at the antenna at the other input connector.

2. AC/DC Power Connection:

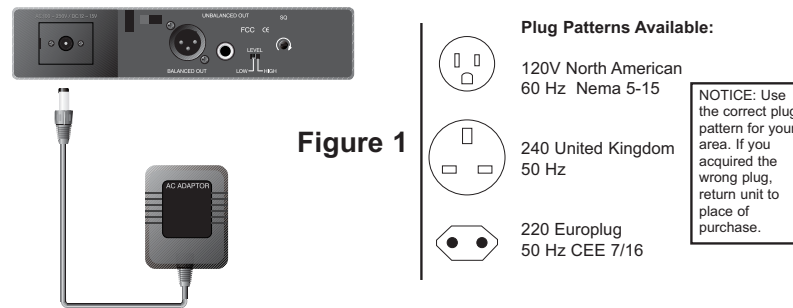

Connect the AC/DC adapter cable to the DC 12V input jack. Then plug the adapter unit into an appropriate AC outlet as shown in Figure 1.

Caution: Make sure the correct voltage is present at the AC outlet as indicated on the AC/DC adapter.

3. Audio Output Connection:

a. Unbalanced Level Switch Setting Position:

Make sure to match the unbalanced output setting to the device input setting. The incorrect setting could result in low sensitivity level or over load distortion. Ex. (If you are going into the “Line” input on a mixer or amplifier then the switch should be set to the high position. If you are going into the “Mic” input of an amplifier or mixer then the switch should be set to the low position.)

b. Unbalanced Output:

Connect the 1/4" phone plug of the audio cable into the unbalanced output connector on the back of the receiver. Connect the other end of the cable to the proper input of the desired device. Make sure the unbalanced level switch is in the proper position before applying power.

c. **Balanced Output:**

Connect the male XLR connector into the balanced output connector on the back of the receiver. Connect the other end of the cable into the “Mic/Balanced” input of the desired device. The characteristics of the 3-pin XLR connector are shown below.

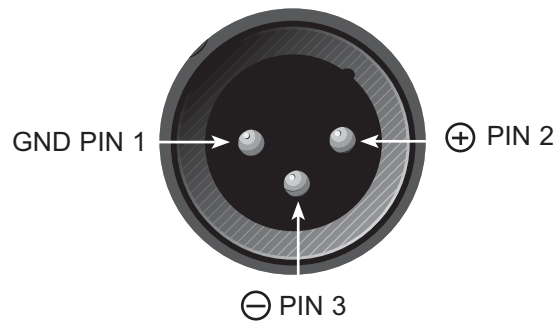

III. RECEIVER INSTALLATION

A. Setup for single half-rack receiver

1. Push the rack mount brackets (RM-11) upwards until it is firmly attached to the receiver.



B. Setup for dual half-rack receivers

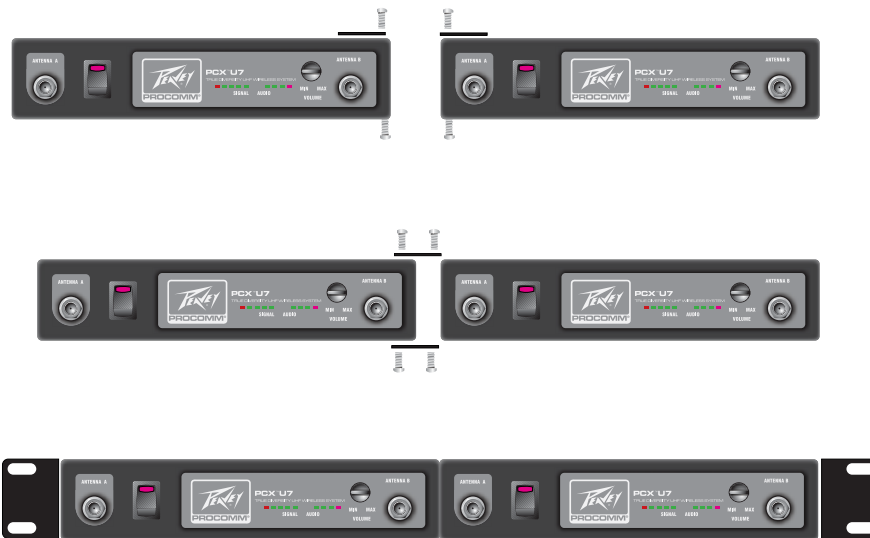

1. Remove the screws at the top and bottom of the receiver where they will be joined together. Remove one steel plate from each receiver. Push the receivers next to each other.
2. Insert the steel plate in between the two receivers (top and bottom). Align and fasten the screws tightly.
3. Align and fasten the rack mount brackets (RM-12) on the outer sides of both receivers.
4. After completion, it can be rackmounted into an EIA standard rack case.
5. Make sure that the system performs correctly by placing the system away from noise sources. Place the receiver at least one meter above the ground and one meter away from noise sources. Place the microphone at least one meter away from the receiving antenna.

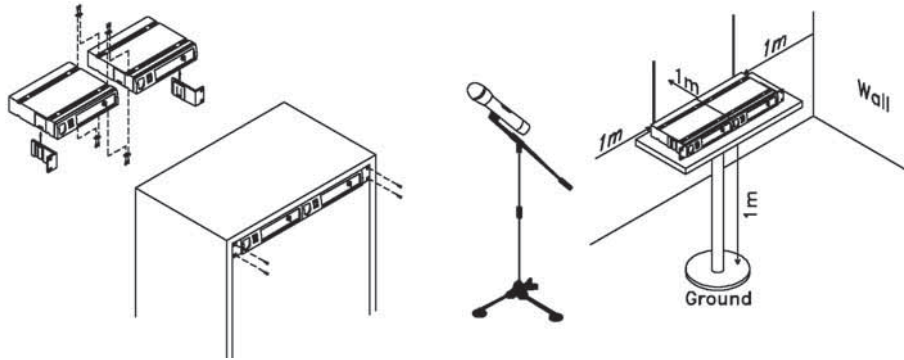

IV Operation Instructions

1. Turn the volume controls of the receiver and device in use to a minimum setting before turning on the microphone transmitter. After the receiver's power switch is set to the on position, the power switch's red indicator illuminates to denote normal power status.
2. If the SIGNAL LED indicators of the receiver are illuminated before switching on the microphone or transmitter, it indicates the receiver is receiving interference signals. The more LEDs that illuminate the more severity of interference. This system has "Pilotone" and "NoiseLock" dual-squelch features so noise output will not occur. If multiple channels are used and both SIGNAL and AUDIO LEDs illuminate before the transmitter is turned on, simply adjust the Squelch controls clockwise until the AUDIO signal indicators extinguish. However, by adjusting the squelch controls it affects the sensitivity level of the receiver, therefore, shortening the operating distance and decreasing the stability.

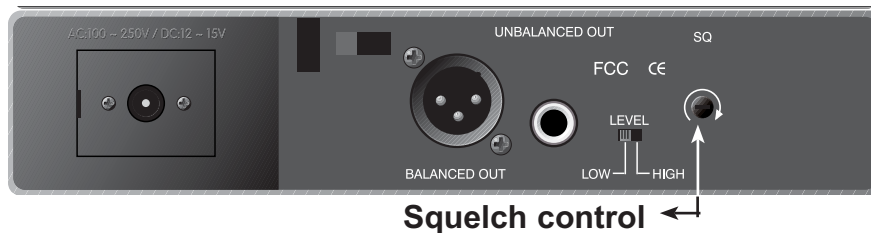

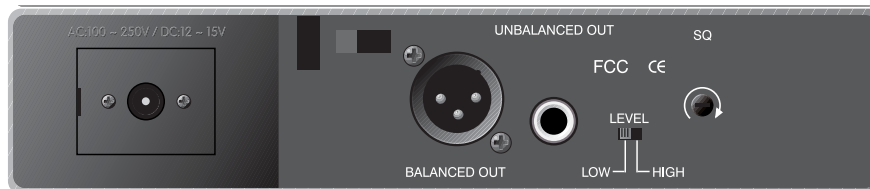

3. Under normal circumstances, the SIGNAL indicator lights up when a microphone or transmitter is turned on near the receiver to indicate the receiver is ready for normal operation. Once sounds enter into the microphone the AUDIO LED indicators will illuminate according to the strength of sound level. If the LEDs do not illuminate or sound is not present at the output, the system is not functioning properly and must be checked.

4. Receiver and Amplifier Volume Adjustment:

a. Single-channel Unbalanced Audio Output: Switch the level switch on the rear panel of the receiver to the left “LOW” Position, then adjust the volume control to twelve o’clock position. Adjust the volume control of the amplifier or mixer to an appropriate sound level. The volume control is used for fine adjustment of the microphone sensitivity. When the knob is turned to the twelve o’clock position the output sensitivity level of the wireless microphone is the same as a normal dynamic microphone. Once the receiver output level is appropriately adjusted, do not adjust the volume control again. Adjust the mixer or amplifier volume control if the sound level needs to increase or decrease.

b. Balanced Output: Adjust according to the unbalanced audio output method in the previous step. (Note: The level switch does not effect the balanced output.)

c. To obtain the same sensitivity level when using a wireless microphone and a wired microphone with one amplifier or mixer connect both the receiver output and the wired output to a “MIC-IN” input jack of the amplifier or mixer. Adjust the volume controls of the amplifier or mixer to the same desired level, then properly fine adjust the receiver volume control to match the same sensitivity as the wired microphone.

d. If the receiver output level is adjusted to a level that is near the maximum input level of the desired device, it will cause saturation distortion of the device when the receiver output level is increased due to a increase in level by the sound source. Conversely, S/N ratio will decrease if the receiver volume control is adjusted too low.

5. Plug the cable of the mains unit into DC socket on the receiver's back panel. Thread the cable through the cable grip as shown in figure 8. The cable grip prevents the connector from being pulled off by accident.



Caution

1. Since the installation of the antenna influences the operating efficiency of the receiver, the most important rule is to minimize the distance as much as possible between the receiving antenna and the microphone for the best reception and performance.

2. The output voltage of the external DC power supply should not be below 12V, otherwise it will not work properly. If the voltage is over 15V some components of the receiver will be damaged due to excessive current draw. Use a power supply with a 1A minimum rating.

V. Handheld Wireless Microphone

The Peavey ProComm® PCX-U7™ handheld wireless microphone is a modular design. It also incorporates “Superior frequency tracking and muting techniques” dual-squelch to eliminate noise interference.

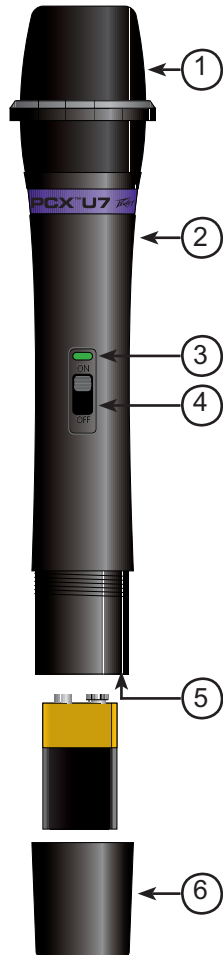

I. Unit Features and Functions

1. Grille: Protects cartridge and prevents breathing and wind POP noises.

2. Housing: Upper portion that is connected to the capsule module.

Internally it holds the transmitter PCB and battery compartment.

3. Battery Status Indicator: Indicates the power on/off and battery status. When the power switch is turned ON, the red LED indicator flashes briefly and then goes out indicating normal battery status. If no flash occurs, it has either no battery or the battery is drained or installed incorrectly. The power led will also warn when the battery is weak by remaining on after power up. A battery replacement is then necessary.

4. Power On-off Switch: Slide the power switch to the “ON” position for use or to the “OFF” position when not in use.

5. Battery Compartment: Designed to accommodate one 9V battery.

6. Battery Cap: Covers battery in the battery compartment.

II. BATTERY INSERTION

1. Unscrew the battery cap in a counter-clockwise direction.
2. Insert a 9V battery into the battery compartment according to the correct polarity. The moment the battery touches the terminals of the compartment, the indicator will flash briefly. This means the polarity is correct. However, if no flash occurs, this indicates wrong insertion or battery is dead. Please re-insert the battery according to its correct polarity or exchange it for a fresh battery.

III. OPERATING INSTRUCTIONS

1. When the microphone is switched on the indicator will flash briefly indicating normal operation.
2. After the microphone is switched on the RF SIGNAL LED indicator of the receiver illuminates. As the signal strength increases the number of illuminated LEDs will increase. If only the red LED illuminates this indicates abnormal receiving status.
3. During usage the AUDIO LED indicator of the receiver will illuminate according to the sound strength input to the microphone. When the red LED is illuminated, it denotes the maximum sound pressure level is being reached but does not represent distortion.
4. When the microphone is not in use make sure to turn it off to extend the battery life. Remove the battery from the battery compartment if the microphone will not be in use for a long period of time. If a rechargeable battery is used take it out for a recharge as necessary.

Belt Pack Transmitter

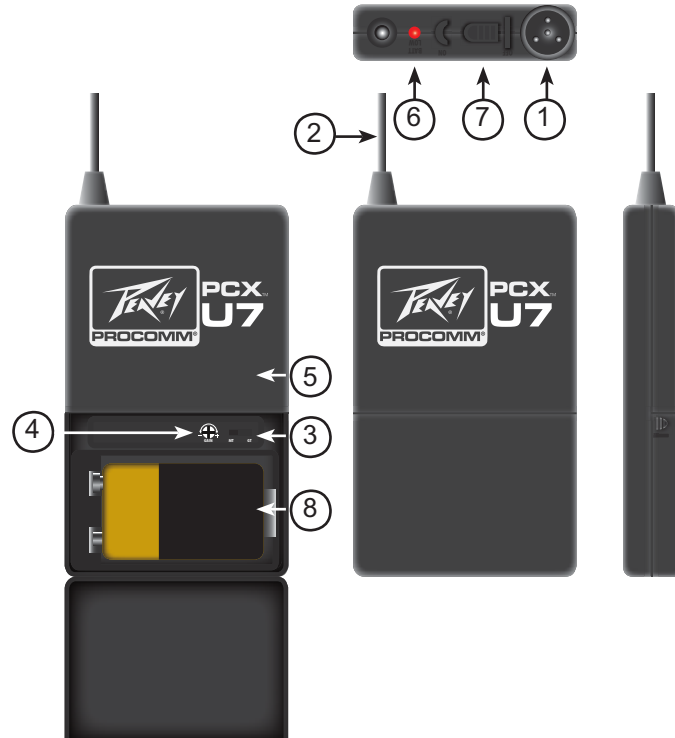

I. Unit Features and Functions

1. 3-pin Jack Input Connector: Connects to the Peavey ProComm® 3-pin connector. Allow 5 different input configurations (See the five ways of connection on an AF input connection, page 20.)

2. Transmitting Antenna: 1/4 wavelength transmitting antenna

3. GT/MT Switch: Switch to the GT position for electric guitar use ONLY. Gain Control is irrelevant for “GT” mode. Switch to the “MT” position for condenser microphone, wired microphone or Line-in use. Gain Control works in the “MT” mode for input sensitivity adjustments.

4. Gain Control: Adjusts the input gain to an appropriate level.

5. Transmitter Housing: Contains the PCB and battery.

6. Battery Status Indicator: Indicates the power on/off and battery status.

a. When the power switch is turned on the LED indicator flashes briefly, indicating normal battery status.

b. If the LED illumination is sustained at either power on or during usage the battery level is low. The old battery should be replaced with a new one.

7. Power Switch: Switch to ON position for operation. Switch to OFF position when not in use.

8. Battery Compartment and Cover: Accommodates one 9V battery.

II. Operating Instructions

1. Push down on the battery cover to open the battery compartment.

2. Insert a 9V battery into the battery compartment according to the correct polarity. Then push up on the battery cover to close the battery compartment.

3. The LED indicator will flash briefly when power is turned on to indicate normal battery status. If no flash occurs it has either no battery, the battery is drained or installed incorrectly. Change accordingly.

4. 4-Pin Jack: Volume can be adjusted by the gain control. Gain control has no effect when the switch is in the "GT" position (Guitar).

5. 4-Pin Jack: Align and insert the 4-pin plug into the jack accordingly and tighten it in the clockwise direction.

AF 4-Pin Input Connection Methods

- (1) 2-Wire Electret condenser microphone Capsule

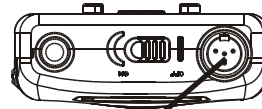
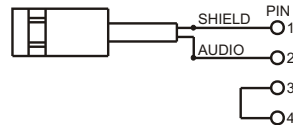

- (2) 3-Wire Electret condenser microphone Capsule

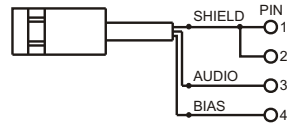

- (3) Dynamic Microphone

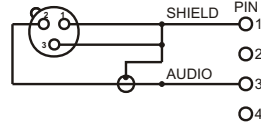

- (4) Electric Guitar

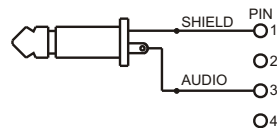

- (5) Line-in (Impedance $8K\Omega$ ATT. 10dB)

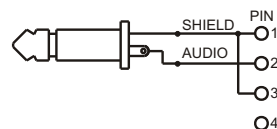

SPECIFICATIONS

1. Overall: UHF PCX™ -U7

1. Carrier Frequency Range: UHF Band 7 models, 914.900-929.875 MHz
2. Oscillation Mode: Quartz-controlled
3. Channel: 1-channel fixed
4. Stability: ± 0.005 % with temperature compensation
5. Max. Deviation: ± 56 KHz with level limiting
6. Dynamic Range: > 110 dB
7. S/N Ratio: > 100 dB
8. T.H.D.: < 0.5 %
9. Squelch: "Superior frequency tracking and muting techniques" Dual-Squelch Circuitry
10. Frequency Response: 60 Hz~18 KHz ± 3 dB

2. Receiver: UHF PCX™ -U7

1. Receiving Method: True Diversity Single Channel
2. Sensitivity: 6 dBuV at S/N > 70 dB
3. Image Rejection: > 60 dB
4. Spurious Rejection: > 80 dB
5. Audio Output: can switch between -2 dB/5 K Ω and -12dB/600 Ω unbalanced and balanced
6. Power Supply: 12~15 VDC/0.5 A
7. Panel: 19/2", half-rack size
8. Dimensions (m/m): 210 (L) x 175 (W) x 44 (H)
9. Weight: Approx. 1.0 Kgs

3. Transmitter: UHF PCX™ -U7

1. Mic Element: Condenser Microphone Capsule
2. Antenna: Built-in
3. RF Output: 10~50 mW (according to regulation)
4. Spurious: < -40 dBc
5. Battery: One 9-Volt Battery
6. Dimensions: (m/m): 49 x 234(L)
7. Weight: 270 grams (without battery)
8. 20-hour battery life per single 9-volt alkaline

TROUBLESHOOTING GUIDE

Symptom	Distance	Possible Cause	Possible Solution
No AF signal and no RF signal	Any	low transmitter battery voltage	replace battery
No AF signal and no RF signal	long	out of range	move transmitter closer to receiver or obstacles
No AF signal but normal RF signal	any	microphone or other input source	check input source
Distortion with no AF peak indication	any	low transmitter battery voltage	replace battery
Noise with low AF signal and normal RF signal	any	strong RFI	identify source and eliminate or change frequency of wireless microphone system
Intermittent AF signal low RF signal	long	out of range	move transmitter closer to RCV
Intermittent AF and RF signals	average	obstructions in signal path	remove obstructions or reposition transmitter and/or RCV

MULTIPLE SYSTEM

Symptom	Distance	Possible Cause	Action
Distortion on two or more systems without	any	units on same frequency	change frequencies
Distortion on one or more systems without	transmitter-transmitter short	transmitter + transmitter intermod	change frequencies
Distortion on one or more systems without	transmitter-transmitter short transmitter-receiver short	transmitter + transmitter intermod transmitter + transmitter receiver intermod	increase transmitter to transmitter distance change frequencies
Distortion on one or more systems without AF peak indication	transmitter-receiver short	transmitter + transmitter receiver intermod	increase transmitter to receive distance

PEAVEY ELECTRONICS CORPORATION LIMITED WARRANTY

Effective Date: 03/04/2010

What This Warranty Covers

Your Peavey Warranty covers defects in material and workmanship in Peavey products purchased and serviced in the U.S.A. and Canada.

What This Warranty Does Not Cover

The Warranty does not cover: (1) damage caused by accident, misuse, abuse, improper installation or operation, rental, product modification or neglect; (2) damage occurring during shipment; (3) damage caused by repair or service performed by persons not authorized by Peavey; (4) products on which the serial number has been altered, defaced or removed; (5) products not purchased from an Authorized Peavey Dealer.

Who This Warranty Protects

This Warranty protects only the original purchaser of the product.

How Long This Warranty Lasts

The Warranty begins on the date of purchase by the original retail purchaser. The duration of the Warranty is as follows:

Product Category	Duration
Guitars/Basses, Amplifiers, Preamplifiers, Mixers, Electronic Crossovers and Equalizers	2 years *(+ 3 years)
Drums	2 years *(+ 1 year)
Enclosures	3 years *(+ 2 years)
Digital Effect Devices and Keyboards and MIDI Controllers	1 years *(+ 1 year)
Microphones	2 years
Speaker Components (Incl. Speakers, Baskets, Drivers, Diaphragm Replacement Kits and Passive Crossovers)	1 year
Tubes and Meters	90 Days
Cables	Limited Lifetime
Rockmaster Series, Strum'n Fun, Vectra, Rotor, OCC Stage pack, GT & BT Series amps, Retro Fire, Metal Maker and Iron Wing	1 year

[* Denotes additional Warranty period applicable if optional Warranty Registration Card is completed and returned to Peavey by original retail purchaser within 90 days of purchase.]

What Peavey Will Do

We will repair or replace (at Peavey's discretion) products covered by Warranty at no charge for labor or materials. If the product or component must be shipped to Peavey for Warranty service, the consumer must pay initial shipping charges. If the repairs are covered by Warranty, Peavey will pay the return shipping charges.

How To Get Warranty Service

(1) Take the defective item and your sales receipt or other proof of date of purchase to your Authorized Peavey Dealer or Authorized Peavey Service Center.

OR

(2) Ship the defective item, prepaid, to Peavey Electronics Corporation, International Service Center, 412 Highway 11 & 80 East, Meridian, MS 39301. Include a detailed description of the problem, together with a copy of your sales receipt or other proof of date of purchase as evidence of Warranty coverage. Also provide a complete return address.

Limitation of Implied Warranties

ANY IMPLIED WARRANTIES, INCLUDING WARRANTIES OF MERCHANTABILITY AND FITNESS FOR A PARTICULAR PURPOSE, ARE LIMITED IN DURATION TO THE LENGTH OF THIS WARRANTY.

Some states do not allow limitations on how long an implied Warranty lasts, so the above limitation may not apply to you.

Exclusions of Damages

PEAVEY'S LIABILITY FOR ANY DEFECTIVE PRODUCT IS LIMITED TO THE REPAIR OR REPLACEMENT OF THE PRODUCT, AT PEAVEY'S OPTION. IF WE ELECT TO REPLACE THE PRODUCT, THE REPLACEMENT MAY BE A RECONDITIONED UNIT. PEAVEY SHALL NOT BE LIABLE FOR DAMAGES BASED ON INCONVENIENCE, LOSS OF USE, LOST PROFITS, LOST SAVINGS, DAMAGE TO ANY OTHER EQUIPMENT OR OTHER ITEMS AT THE SITE OF USE, OR ANY OTHER DAMAGES WHETHER INCIDENTAL, CONSEQUENTIAL OR OTHERWISE, EVEN IF PEAVEY HAS BEEN ADVISED OF THE POSSIBILITY OF SUCH DAMAGES.

Some states do not allow the exclusion or limitation of incidental or consequential damages, so the above limitation may not apply to you.

This Warranty gives you specific legal rights, and you may also have other rights which vary from state to state.

If you have any questions about this Warranty or services received or if you need assistance in locating an Authorized Service Center, please contact the Peavey International Service Center at (601) 483-5365.

Features and specifications are subject to change without notice.



Logo referenced in Directive 2002/96/EC Annex IV
(OJL37/38,13.02.03 and defined in EN 50419: 2005
The bar is the symbol for marking of new waste and
is applied only to equipment manufactured after
13 August 2005



Features and specifications subject to change without notice.

Peavey Electronics Corporation • 5022 Hartley Peavey Drive • Meridian • MS • 39305
(601) 483-5365 • FAX (601) 486-1278 • www.peavey.com
©2010 EX000126

Free Manuals Download Website

<http://myh66.com>

<http://usermanuals.us>

<http://www.somanuals.com>

<http://www.4manuals.cc>

<http://www.manual-lib.com>

<http://www.404manual.com>

<http://www.luxmanual.com>

<http://aubethermostatmanual.com>

Golf course search by state

<http://golfingnear.com>

Email search by domain

<http://emailbydomain.com>

Auto manuals search

<http://auto.somanuals.com>

TV manuals search

<http://tv.somanuals.com>