

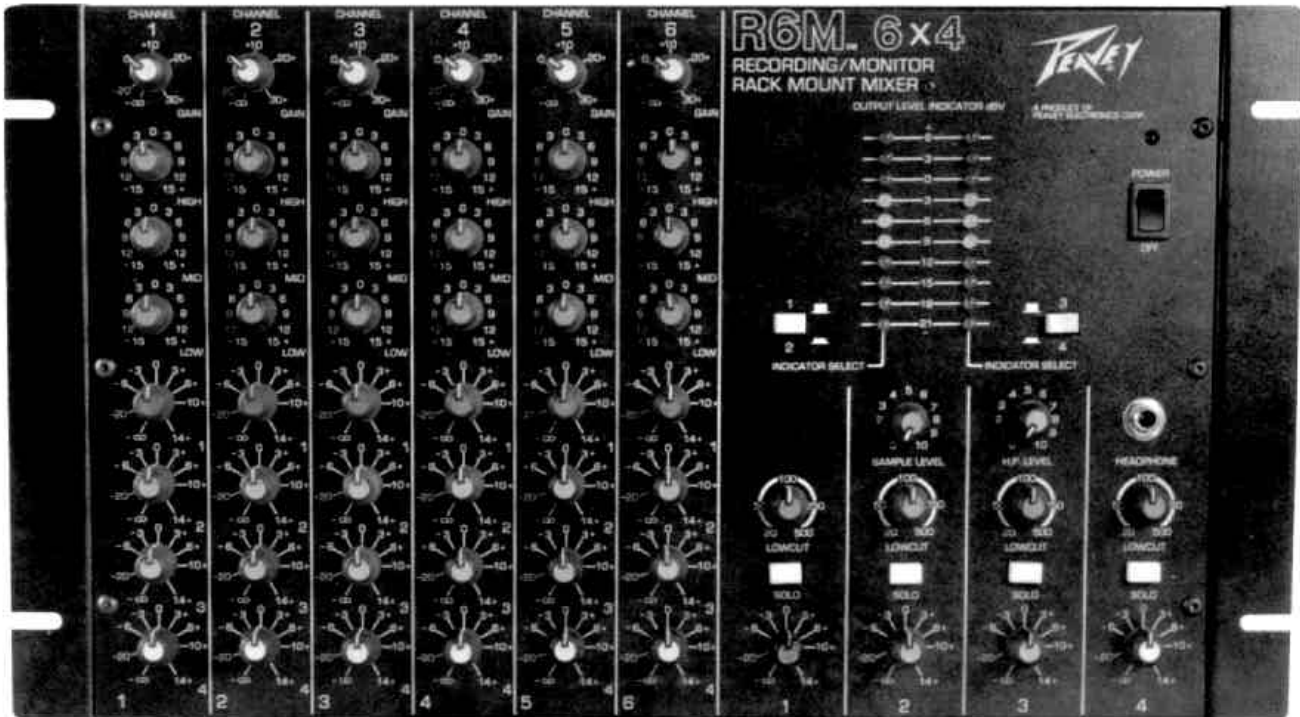

R6M™ 6x4

Recording/Monitor Rack Mount Mixer

OPERATING GUIDE



Thanks for your purchase of the R6M Mixer. This mixer has been designed to interface with virtually all "out front" (main) systems to accomplish the sophisticated procedure of separate stage monitor mixes, as well as perform 4-track recording functions. The compact rack mountable package allows the R6M to be very portable and may be racked in multiples when more than six channels are needed. Many groups today are finding that one or two monitor mixes do not satisfy their requirements as players continue to ask for different instruments/vocals, etc., in their monitors. This product performs the job of separate monitor mixing without many of

the expensive "gingerbread" features that often increase the price to such a point that it is impossible for most groups to get into separate monitor mixes.

The R6M gives you the necessary capabilities for successfully accomplishing four totally separate monitor mixes. Please read this manual and become familiar with all the features before attempting the complex job of doing separate stage monitor mixing. Please be aware also that it takes experience to achieve a good monitor mix and don't expect to do a perfect job the first time you attempt to do a fully separate mix with the R6M Monitor Mixer or any other monitor mixer.

CAUTION

TO PREVENT ELECTRICAL SHOCK OR FIRE HAZARD, DO NOT EXPOSE THIS INSTRUMENT TO RAIN OR MOISTURE. BEFORE USING THIS INSTRUMENT, READ BACK COVER FOR FURTHER WARNINGS.

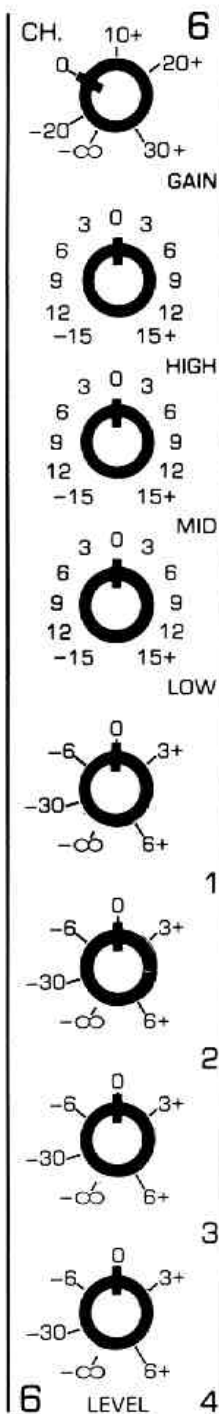

INPUT GAIN CONTROL

The Input Gain Control of the R6M Mixer utilizes a unique configuration so that input **attenuation** and **gain adjustment** occur simultaneously. This arrangement allows the vital input circuitry to handle almost any input voltage from low level mics to speaker levels. The function and operational requirements of this input gain stage are conventional and should present no operational difficulty.

HIGH FREQUENCY EQUALIZATION CONTROL

The High Frequency Control is capable of 15 dB boost or cut at 8 KHz with a "shelving" characteristic sloping down to the crossover point. High frequency *boost* is obtained with a *clockwise* rotation of this control and *counterclockwise* rotation results in a *cutting* of the high frequencies. Flat response is obtained in the center (12:00 o'clock) position. This "flat," 12:00 o'clock, position is an excellent place to begin tuning the system so that with different rooms and concert halls you will be able to determine what degree equalization is needed or not, then you may adjust accordingly.

MID FREQUENCY EQUALIZATION CONTROL

The Mid Control is capable of 15 dB boost or cut at 600 Hz with a peak/notch type of filter response. This middle EQ circuit enables control over the vital mid-range frequencies. The action of this middle filter is somewhat different than the high and low EQ since it is of the "peaking and notching" type. This type filter response is necessary to avoid undue interaction with the high and low equalizers. Caution must be exercised in order to avoid overboosting or overcutting the mid-range. Experience has proven that for most applications a very slight *mid-range cut* tends to produce a "tight" and well defined sound. Generally, large amounts of mid-range boost are extremely unpleasant and will probably never be used except for special effects or to correct extremely marginal microphones or unusual voice timbres. Monitor systems tend to get very "muddy" and lose a certain amount of presence when excessive amounts of mid-range is used.

LOW FREQUENCY CONTROL

This control is capable of 15 dB boost or cut at 60 Hz and demonstrates a "shelving" characteristic so that excessive lows are not boosted below the usable range of sound reinforcement speaker systems. The shelving action of this circuit has proven to yield much more satisfying and effective equalization characteristics than some of the the "wide open" EQ circuits claiming 20 to 25 dB boost and cut. Care should be taken with the Low Frequency Control to not *overboost* lows on any particular instrument or vocal due to the fact that tremendous amounts of power amp "headroom" will be used up and a general "muddiness" will be apparent in the monitor system. Woofers may also be blown much more easily with excessive low frequency boost.

MATRIX LEVEL CONTROLS

There are *four* level controls on each channel of the R6M Monitor Mixer which complete the monitor mix matrix and allow each instrument or vocal to be assigned to any or all of the four mixes. The channel level controls should be operated near the *zero* indication (unity gain) whenever possible for optimum headroom and signal-to-noise. Operation of this control above the zero point increases system gain (and noise), and below the zero point sacrifices headroom. Please notice each control is capable of 6 dB of gain above the (zero) unity gain position.

MASTER SECTION

OUTPUT MIX LEVEL INDICATION

Two ten-segment LED arrays have been utilized to visually indicate the output level of each of the R6M's four separate mixes. Masters (1) through (4) may be selected for visual output indication with the push, indicator select switches located near the 10-segment LED arrays. (-21 dBV to +6 dBV). Each main output is capable of +18 dBV, so there is *12 dB of headroom* left when the *top LED flashes* for each output section.

AC POWER SWITCH/LED

The Power Switch is a rocker type which is *off* at the bottom position and *on* at the top. The LED indicates that the AC mains are supplying the necessary power to the mixer.

SAMPLE LEVEL

Many times monitor applications require the monitor mix engineer(s) to have a sampling amp/speaker system in order to listen to the exact same mix the players are hearing. The Sample Level Control is the gain determining element for the sample output on the rear panel. Some monitor situations may only call for headphone sampling at the monitor mix board and in that

case the sample output will not necessarily be used. In most cases, however, for high level operation, the separate sampling speaker is much more effective than typical headphones. The main advantage is that the monitor mix engineer is able to listen under similar conditions through the same type speaker as the performers on stage. NOTE: For sample output to become operational solo switches and sample level must be pre-set. Sample output system may be used to monitor any or all four tracks during recording situations. (See diagrams C & D).

HEADPHONE LEVEL

The Headphone Level is a gain regulating device which determines the listening level in the headphones for the solo system. The related jack for the headphones is immediately to the right of the Headphone Level Control and will accept most typical headphone units with no problem. When monitoring the sample system through stereo headphones, the signal appears *monaurally* in both earpieces.

LOW CUT CONTROL

Each of the four respective masters include a "Low Cut" Control which tailors the low frequency response of all instruments or vocals assigned to that particular mix. The purpose of this control is a "roll-off" function of 12 dB per octave beginning at the frequency which is selected by a rotation of the control knob. The range of frequency selection is 20 Hz to 500 Hz. The low cut feature is a very useful device for matching the output signal with the capabilities of the power amp/speaker system for a particular mix. Low frequencies which the speaker system will not reproduce efficiently may be cut ("rolled-off") at 12 dB per octave, thus eliminating the muddiness often encountered with monitor systems. Monitor speaker systems in general are *not required* to reproduce as much low end as the "out front" (main) house system. Many monitor speaker systems are incapable of reproducing frequencies much below 100 Hz and the durability and projection of these systems is greatly increased when those devices are not driven with frequencies below their *cut off* capabilities.

SOLO FUNCTION

The "Solo Function" is a push-push type and allows the operator to select any or all master mixes in his headphone or sample output. The Solo Function is the final signal output of each master mix *after* the master level control. In order to monitor a master output with this feature, the *sample level* or *H.P. level* control in the master section must be set to the desired listening level and a solo button must be depressed. NOTE: Any number of master mixes may be monitored at the *same* time with the Solo Function.

MASTER MIX LEVEL

All *four* master mix controls function identically to regulate the output level of each mix separately. For example, Master 1 feeds the output on the rear panel for mix 1 only. These controls should be operated near the mid point or zero dB position for optimum headroom and signal- to-noise performance. NOTE: A setting above the zero dB position will increase output signal but will also increase system noise; and a setting below zero dB will result in improved noise performance at the expense of less headroom. Notice there is *14 dB* of gain available above the zero position for situations where extra gain is required. A rough "rule of thumb" for setting the master controls would be at the input sensitivity rating of the power amplifier for that particular mix. For instance, if the power amp sensitivity rating is +3 dBV, then adjust the controls for that mix to +3 dB as a starting point.

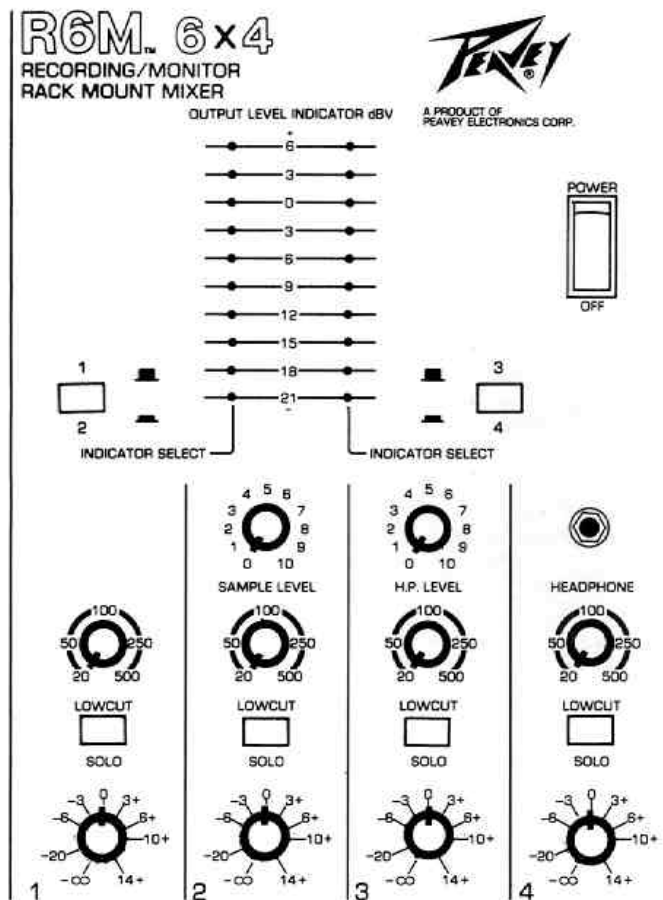

REAR PANEL

AUXILIARY INPUT JACK

There is an Auxiliary Input for each separate mix to allow patching in other outboard signals such as additional monitor channels or an "outboard" monitor mixer. There are no auxiliary input level controls associated with these jacks, but the signal simply mixes into the master summing buss for each separate monitor mix, and is controlled by the master mix level control.

SOLO PATCH

The Solo Patch is a stereo 1/4" jack and is designed to interconnect the "electronic logic" of the solo feature when *two* monitor mixers are patched together and the solo function is desirable on both units. When two consoles are used for additional channels in a monitor situation, the logic and signal *should be connected* so that listening capability is possible for both consoles through the solo feature for each monitor mix.

NOTE

A TWO CONDUCTOR SHIELDED CORD FITTED WITH STEREO PLUGS (RING, TIP AND SHEEVE) MUST BE USED TO ACCOMPLISH THIS PATCH.

SAMPLE OUTPUT JACK

The Sample Output Jack is a 1/4" phone jack and provides a signal from the sample level on the front panel and should be used for the monitor mix engineer to sample the different mixes that are occurring on stage. This creates a separate system which is usually located near the monitor mix console and should include the same basic type of amplifier and speaker system that is employed on stage so that the mix engineer will know exactly how the monitors sound on stage. The patch hookup for this system would be *from* the Sample Output Jack to the amp/speaker system that is used for the sampling source. NOTE: For most high level monitor applications, a *separate* sampling speaker/amplifier system is much more effective than trying to do a monitor mix through headphones. (See explanation of Sample Level Control and Diagram C). For recording applications the sampling speaker will be control room monitor.

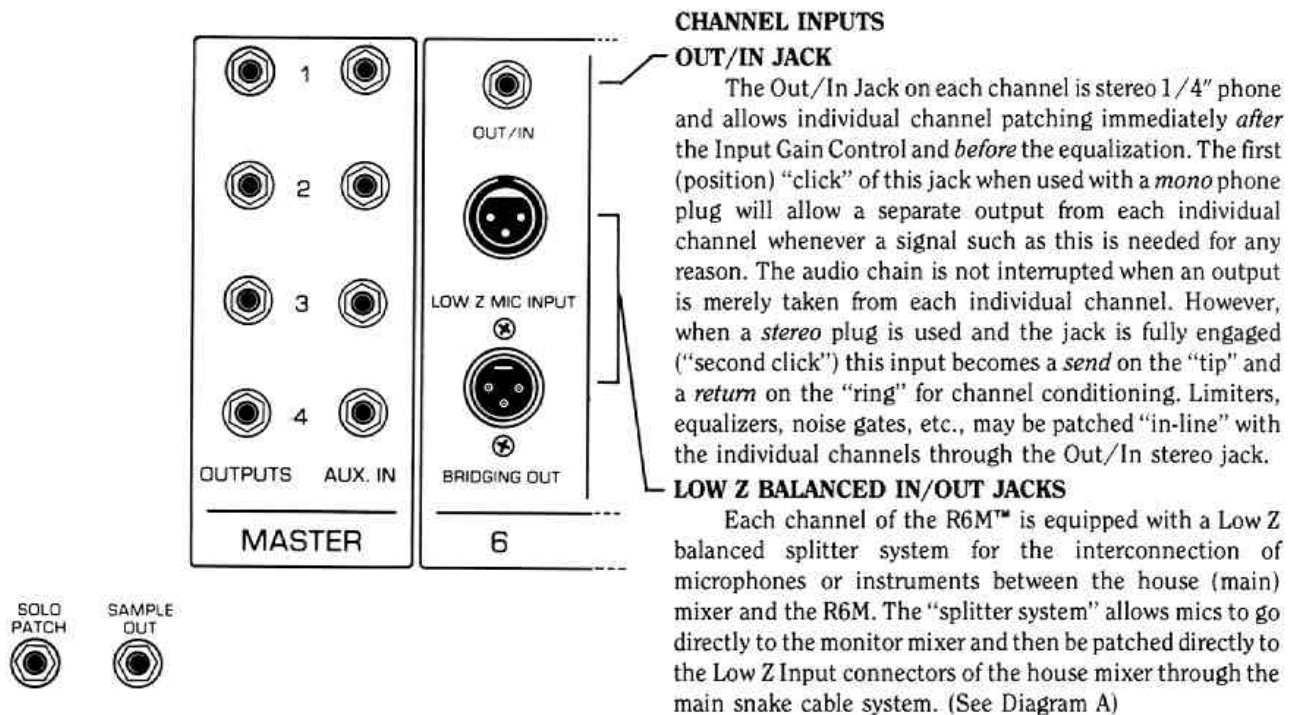

DIAGRAM A

PATCH BETWEEN MICS, MONITOR MIXER AND HOUSE (MAIN) MIXER!

SHOWN TYPICAL EACH CHANNEL

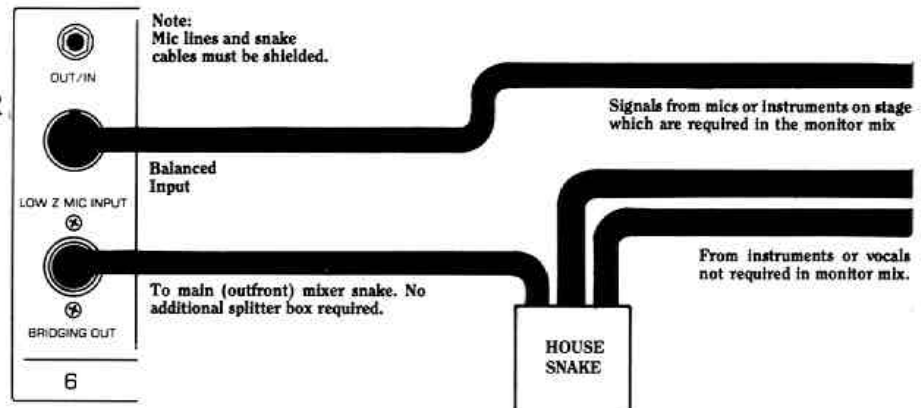
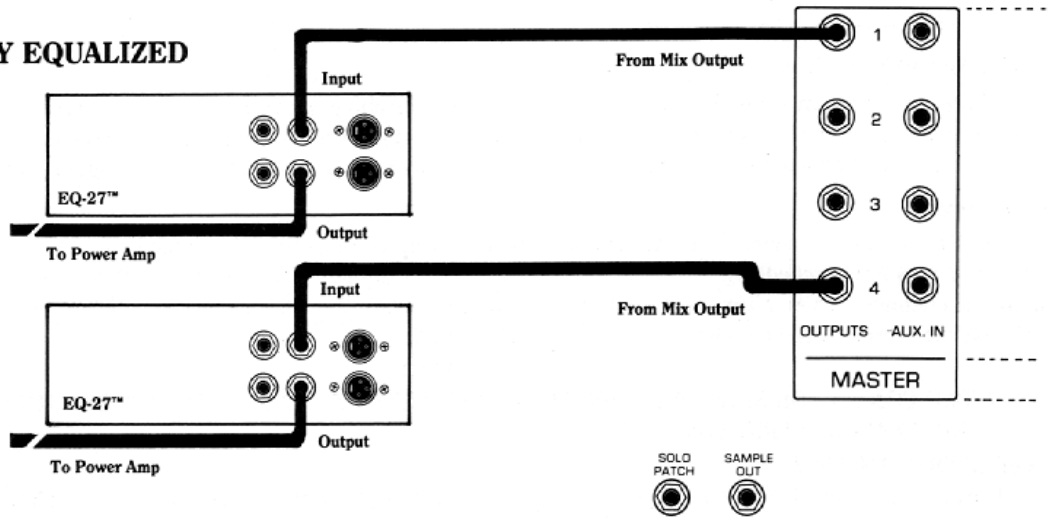
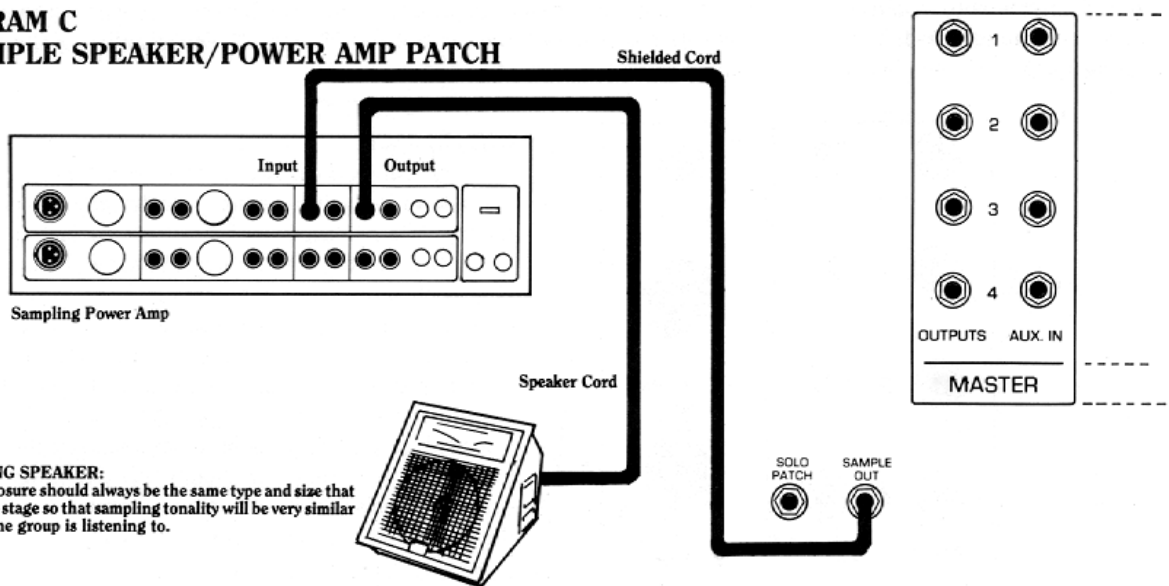

DIAGRAM B
EXTERNALLY EQUALIZED
MONITOR
MIXES



- NOTES:**
- Use good quality shielded cords for all connections.
 - Only (2) equalizers are shown, but system is capable of (4) equalized mixes.
 - Use 1/3 octave equalizers whenever possible.

DIAGRAM C
SAMPLE SPEAKER/POWER AMP PATCH



SAMPLING SPEAKER:
 This enclosure should always be the same type and size that is used on stage so that sampling tonality will be very similar to what the group is listening to.

DIAGRAM D
FOUR TRACK RECORDING/AUX.
MIXER PATCH

PATCH AUX. MIXER
 with shielded cables, patch from aux. mixer's outputs to R6M™ aux. inputs.

NOTE: Aux. mixer not required for recording unless additional channels are needed.

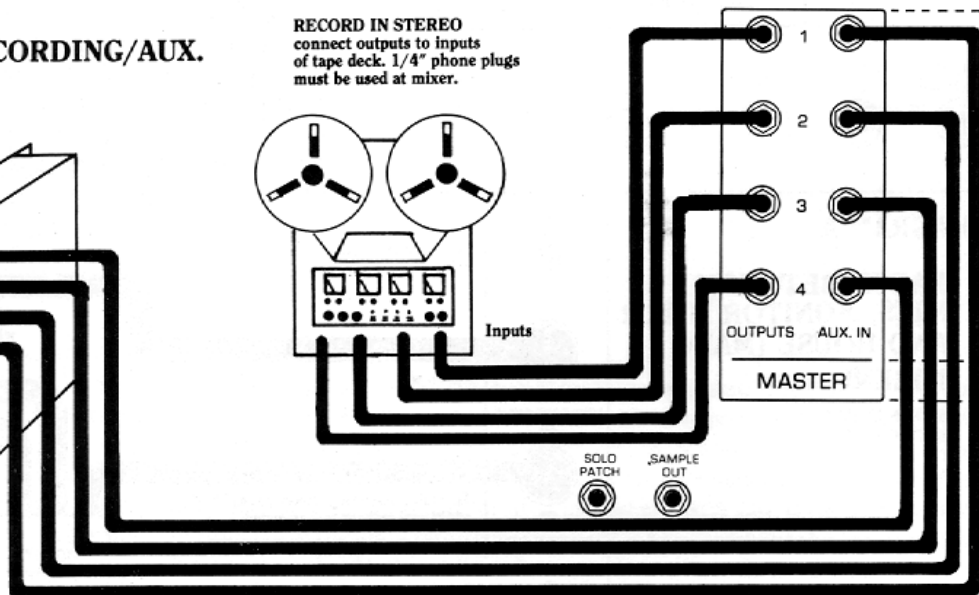

RECORD IN STEREO
 connect outputs to inputs of tape deck. 1/4" phone plugs must be used at mixer.

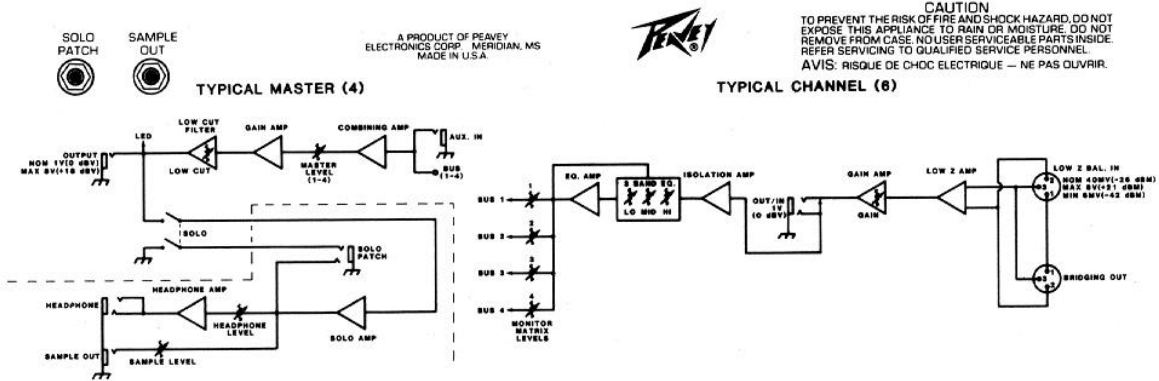

CAUTION
 TO PREVENT THE RISK OF FIRE AND SHOCK HAZARD, DO NOT EXPOSE THIS APPLIANCE TO RAIN OR MOISTURE. DO NOT REMOVE FROM CASE. NO USER SERVICEABLE PARTS INSIDE. REFER SERVICING TO QUALIFIED SERVICE PERSONNEL.
 AVIS: RISQUE DE CHOC ELECTRIQUE - NE PAS OUVRIER.

R6M™ RECORDING RACK MOUNT MIXER SPECS:

SUMMARY OF FUNCTIONS:

6 channels in; 4 mixes out; 1 sample out; bridging male and female XLR balanced input/outputs with ground isolation, pre send and return each channel; 1 unbalanced auxiliary and 1 unbalanced output for each mix; mono headphone output for solo listening; input gain/attenuation, 3-band EQ, and 4 matrix sends each channel; solo, variable low cut, master slider, LED ladder and auxiliary input level each master mix.

INPUTS, EACH CHANNEL:

1 Low Z balanced microphone; 1 High Z unbalanced (stereo ring) pre return

INPUTS, MASTER:

1 High Z unbalanced auxiliary for each of 4 mixes; 1 unbalanced solo patch

OUTPUTS, EACH CHANNEL:

1 Low Z unbalanced (stereo jack tip) pre send

OUTPUTS, MASTER:

1 Low Z unbalanced line for each of 4 mixes; 1 unbalanced sample out; 1 headphone out

BRIDGING CHANNEL MICROPHONE INPUTS/OUTPUTS (Replaces conventional splitter box):

Mic Impedance: Designed for 600 ohm or lower mics; balanced system with ground isolation
 Nominal Input Level: -26 dBm, 40 mV RMS
 Minimum Input Level: -42 dBm, 6 mV RMS
 Maximum Input Level: +20 dBm, 8V RMS

CHANNEL PRE RETURN INPUTS:

Line Impedance: High Z 47K ohms unbalanced
 Designed Input Level: 0 dBV, 1V RMS

MASTER AUXILIARY INPUTS:

Line Impedance: High Z 33K ohms unbalanced
 Nominal Input Level: 0 dBV, 1V RMS

MASTER & CHANNEL SENDS UNBALANCED OUTPUTS:

Load Impedance: 600 ohms or greater
 Nominal Output: 0 dBV, 1V RMS
 Maximum Output: +18 dBV, 8V RMS into 50K ohm load; +18 dBm, 6V RMS into 600 ohm load

SAMPLE UNBALANCED OUTPUTS:

Load Impedance: 10K ohms or greater
 Nominal Output: 0 dBV, 1V RMS
 Maximum Output: +18 dBV, 8V RMS into 10K ohm load

HEADPHONES (Mono Amp with Stereo Jack):

Load Impedance: 4 ohms to 50 ohms
 Maximum Output Power: 100 mW

THE FOLLOWING SPECS ARE MEASURED WITH A NOMINAL INPUT GAIN SETTING OF +20 dB ALL CHANNELS, ALL CHANNEL MATRIX CONTROLS AND ALL MASTER MATRIX CONTROLS ARE SET AT 0 dB, ALL EQ SET FLAT, ALL LOW CUT FILTERS SET AT 20 Hz, ALL LOW Z INPUTS TERMINATED WITH 600 OHMS, ALL HIGH Z INPUTS AND ALL OUTPUTS TERMINATED WITH 47K OHMS:

FREQUENCY RESPONSE (Any In/Out Combination with 1V RMS Output):
 +0, -2 dB, 20 Hz to 30 kHz

SYSTEM HUM & NOISE (All Channels On):

-80 dBV; Low Z mic inputs

EQUIVALENT INPUT NOISE (20 Hz - 20 kHz, 150 ohms):

-126 dBV

OVERALL DISTORTION (Any In/Out Combination, 20 Hz - 20 kHz at 1V RMS):

Less than .05% THD; typically below .01%

EQUALIZATION:

+/- 15 dB at 60 Hz and 8 kHz (shelving)
 +/- 15 dB at 600 Hz (peak/notch)

LOW CUT FILTERS:

12 dB/octave slope, 20 Hz to 500 Hz

CROSSTALK:

Greater than 60 dB at 1 kHz

MAXIMUM AVAILABLE GAIN:

+14 dB (Master Control); +6 dB (Channel Matrix Control); +40 dB (Input Control); +60 dB (total)

LED READOUT RANGE:

-21 to +6 dBV

POWER REQUIREMENTS:

120 VAC, 60 Hz, 40 watts

WARNING

EXPOSURE TO EXTREMELY HIGH NOISE LEVELS MAY CAUSE A PERMANENT HEARING LOSS. INDIVIDUALS VARY CONSIDERABLY IN SUSCEPTIBILITY TO NOISE INDUCED HEARING LOSS. BUT NEARLY EVERYONE WILL LOSE SOME HEARING IF EXPOSED TO SUFFICIENTLY INTENSE NOISE FOR A SUFFICIENT TIME.

THE U.S. GOVERNMENT'S OCCUPATIONAL SAFETY AND HEALTH ADMINISTRATION (OSHA) HAS SPECIFIED THE FOLLOWING PERMISSIBLE NOISE LEVEL EXPOSURES:

DURATION PER DAY IN HOURS	SOUND LEVEL dBA, SLOW RESPONSE
8	90
6	92
4	95
3	97
2	100
1 1/2	102
1	105
3/4	110
1/2 or less	115

ACCORDING TO OSHA, ANY EXPOSURE IN EXCESS OF THE ABOVE PERMISSIBLE LIMITS COULD RESULT IN SOME HEARING LOSS. EAR PLUGS OR PROTECTORS IN THE EAR CANALS OR OVER THE EARS MUST BE WORN WHEN OPERATING THIS AMPLIFICATION SYSTEM IN ORDER TO PREVENT A PERMANENT HEARING LOSS IF EXPOSURE IS IN EXCESS OF THE LIMITS AS SET FORTH ABOVE. TO INSURE AGAINST POTENTIALLY DANGEROUS EXPOSURE TO HIGH SOUND PRESSURE LEVELS, IT IS RECOMMENDED THAT ALL PERSONS EXPOSED TO EQUIPMENT CAPABLE OF PRODUCING HIGH SOUND PRESSURE LEVELS SUCH AS THIS AMPLIFICATION SYSTEM BE PROTECTED BY HEARING PROTECTORS WHILE THIS UNIT IS IN OPERATION.

CAUTION

THIS AMPLIFIER HAS BEEN DESIGNED AND CONSTRUCTED TO PROVIDE ADEQUATE POWER RESERVE FOR PLAYING MODERN MUSIC WHICH MAY REQUIRE OCCASIONAL PEAK POWER TO HANDLE OCCASIONAL PEAK POWER. APPROPRIATE POWER "HEADROOM" HAS BEEN DESIGNED INTO THIS SYSTEM. EXTENDED OPERATION AT ABSOLUTE MAXIMUM POWER LEVELS IS NOT RECOMMENDED SINCE THIS COULD DAMAGE THE ASSOCIATED LOUDSPEAKER SYSTEM. PLEASE BE AWARE THAT MAXIMUM POWER CAN BE OBTAINED WITH VERY LOW SETTINGS OF THE GAIN CONTROLS IF THE INPUT SIGNAL IS VERY STRONG.

- Read all safety and operating instructions before using this product.
- All safety and operating instructions should be retained for future reference.
- Obey all cautions in the operating instructions and on the back of the unit.
- All operating instructions should be followed.
- This product should not be used near water, i.e. a bathtub, sink, swimming pool, wet basement, etc.
- This product should be located so that its position does not interfere with its proper ventilation. It should not be placed flat against a wall or placed in a built-in enclosure that will impede the flow of cooling air.
- This product should not be placed near a source of heat such as a stove, heater, radiator or another heat producing amplifier.
- Contact only to a power supply of the type marked on the unit attached to the power supply cords.
- Never break off the ground pin on the power supply cord. For more information on grounding write for our free booklet "Shock Hazard and Grounding."
- Power supply cords should always be handled carefully. Never walk or place equipment on power supply cords. Periodically check cords for cuts or signs of stress, especially at the plug and the point where the cord exits the unit.
- The power supply cord should be unplugged when the unit is to be unused for long periods of time.
- Metal parts can be cleaned with a damp rag. The vinyl covering used on some units can be cleaned with a damp rag, or an ammonia based household cleaner if necessary.
- Care should be taken so that objects do not fall and liquids are not spilled into the unit through the ventilation holes or any other openings.
- This unit should be checked by a qualified service technician if:
 - The power supply cord or plug has been damaged.
 - Anything has fallen or been spilled into the unit.
 - The unit does not operate correctly.
 - The unit has been dropped or the enclosure damaged.
- The user should not attempt to service this equipment. All service work should be done by a qualified service technician.

PEAVEY ELECTRONICS CORPORATION

711 A Street / Meridian, MS 39301 / Telephone: (601) 483-5365 / Telex: 504115 / Printed in U.S.A. / ©1984

Free Manuals Download Website

<http://myh66.com>

<http://usermanuals.us>

<http://www.somanuals.com>

<http://www.4manuals.cc>

<http://www.manual-lib.com>

<http://www.404manual.com>

<http://www.luxmanual.com>

<http://aubethermostatmanual.com>

Golf course search by state

<http://golfingnear.com>

Email search by domain

<http://emailbydomain.com>

Auto manuals search

<http://auto.somanuals.com>

TV manuals search

<http://tv.somanuals.com>