

OWNERS MANUAL



ALPHABASS[®]



WARNING: TO PREVENT ELECTRICAL SHOCK OR FIRE HAZARD, DO NOT EXPOSE THIS APPLIANCE TO RAIN OR MOISTURE. BEFORE USING THIS APPLIANCE, READ THE OPERATING GUIDE FOR FURTHER WARNINGS.

Front Panel



AlphaBASS™

HIGH ENERGY TUBE BASS AMPLIFIER

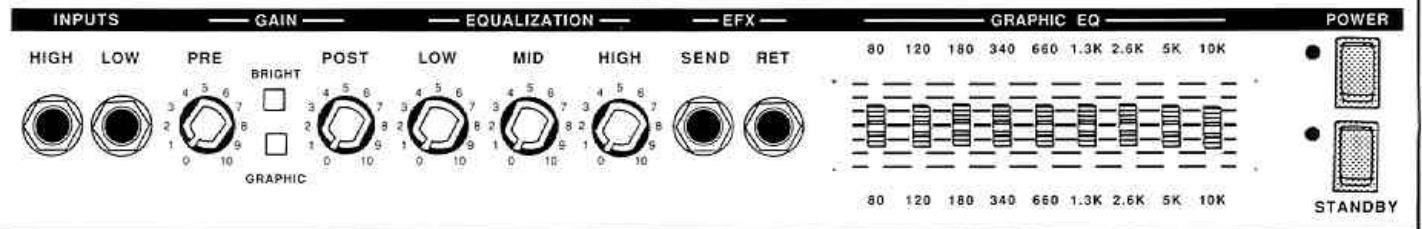

1 2 3 4 5 6 7 8 9 10 11 12

HIGH GAIN INPUT (1)

Used for most electric guitars. It is 6 dB louder than the Low Gain input.

LOW GAIN INPUT (2)

Provided for instruments that have extremely high outputs, which can result in overdriving (distorting) the High Gain input. If both inputs are used simultaneously, the output levels are the same (both are Low Gain).

PRE GAIN (3)

Controls the input volume level of the channel.

BRIGHT SWITCH (4)

Provides a preset boost (+/- 8 dB) to treble frequencies. To activate, depress the switch to its "in" position.

GRAPHIC SELECT (5)

The "in" position of this switch routes the instrument signal through the 9-band equalizer. The "out" position removes the graphic equalizer from the signal path.

POST GAIN (6)

Controls the overall volume level of the amplifier. The final level adjustment should be made after the desired sound has been achieved.

3-BAND PASSIVE EQ (7)

Passive tone controls that regulate the low, mid and high frequencies, respectively.

EFFECTS SEND (8)

Output for supplying signals to external effects or signal processing equipment.

EFFECTS RETURN (9)

Input for returning signals from external effects or signal processing equipment.

GRAPHIC EQUALIZER (10)

This 9-band, one octave equalizer provides 12 dB of boost or cut at each center frequency.

POWER SWITCH (11)

Depress the switch to the "On" position. The red pilot light (LED) will illuminate indicating power is being supplied to the unit.

STANDBY SWITCH (12)

Allows amp to be placed in standby or active mode. In standby mode the tubes remain hot, but the amplifier is not operational.

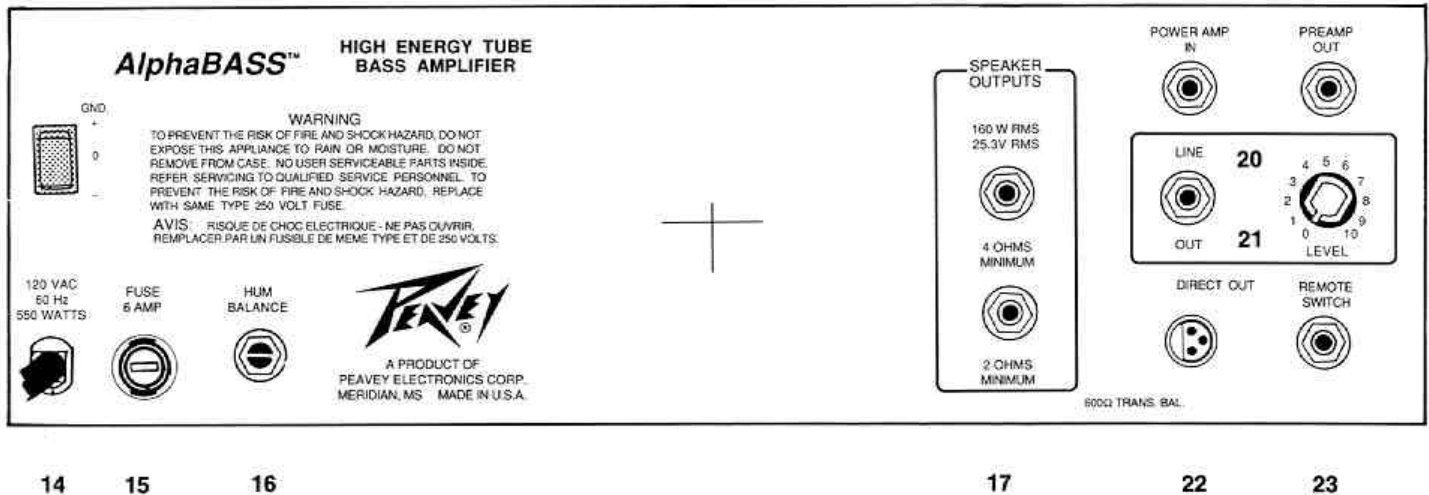

GROUND SWITCH (13)

Three position rocker-type switch which, in most applications, should be operated in its center or zero position. There may be some situations when audible hum and/or noise will come from the loudspeaker. If this situation arises, position the ground switch to either positive (+ or -) or until the noise is minimized. NOTE: Should the noise problem continue, consult your Authorized Peavey Dealer, the Peavey Factory, or a qualified service technician. THE GROUND SWITCH IS NOT FUNCTIONAL ON 220/240 VOLT MODELS.

LINE CORD (120V products only) (14)

For your safety, we have incorporated a 3-wire line (mains) cable with proper grounding facilities. It is not advisable to remove the ground pin under any circumstances. If it is necessary to use the equipment without proper grounding facilities, suitable grounding adaptors should be used. Less noise and greatly reduced shock hazard exists when the unit is operated with the proper grounded receptacles.

FUSE (15)

The fuse is located within the cap of the fuseholder. If the fuse should fail, IT MUST BE REPLACED WITH THE SAME TYPE AND VALUE IN ORDER TO AVOID DAMAGE TO THE EQUIPMENT AND TO PREVENT VOIDING THE WARRANTY. If the amp repeatedly blows fuses, it should be taken to a qualified service center for repair.

WARNING: THE FUSE SHOULD ONLY BE REPLACED WHEN THE POWER CORD HAS BEEN DISCONNECTED FROM ITS POWER SOURCE.

HUM BALANCE (16)

A control to minimize hum. To adjust, first make sure that nothing is plugged into the amp but the speaker cabinet. Turn the unit on and set the Pre Gain, Pump and Post Gain controls at 7. While listening to the speaker closely, gradually rotate the Hum Balance control using a screwdriver until hum is at a minimum. This procedure is required periodically. Reset Hum Balance after tube change.

SPEAKER OUTPUT (17)

Provided for connection of external speaker enclosures. Minimum total impedance is 2 ohms. A 4 ohm enclosure should be patched into the 4 ohm jack. A 2 ohm speaker enclosure combination may be patched into the 2 ohm jack. Two 4 ohm enclosures may be used by patching one enclosure into the 4 ohm jack and the other into the 2 ohm jack for 2 ohm operation.

POWER AMP IN (18)

Provided for patching external signals direct to the internal power amplifier. A signal of 3 volts is necessary to drive the power amplifier to full power.

PREAMP OUT (19)

The preamp output may be used to route the preamp signal to outboard power amplifiers, crossovers, etc. This output provides a 3-volt signal level to drive other "tube" power amplifiers and should not be used as an effects send to signal processors or effects devices.

LINE OUTPUT (20)

The line output provides a signal with level control to drive other power amplifier/slave speaker systems. (See line output level)

LINE OUTPUT LEVEL (21)

Controls the signal level at the line output jack. This control may be used as a balance control when slave power amp/speaker systems are driven from the line output.

DIRECT OUTPUT (22)

Provides 600 ohm, transformer balanced signal to be used as "direct" patch into mixing consoles, tape recorders, etc. The signal at this point has been frequency compensated for low noise operation.

REMOTE SWITCH JACK (23)

Provided for the connection of the supplied remote footswitch. Footswitch is used to select or bypass the 9-band graphic equalizer section.

NOTE: Graphic select switch on the front panel must be in the "in" position in order to allow graphic selection with the remote footswitch.

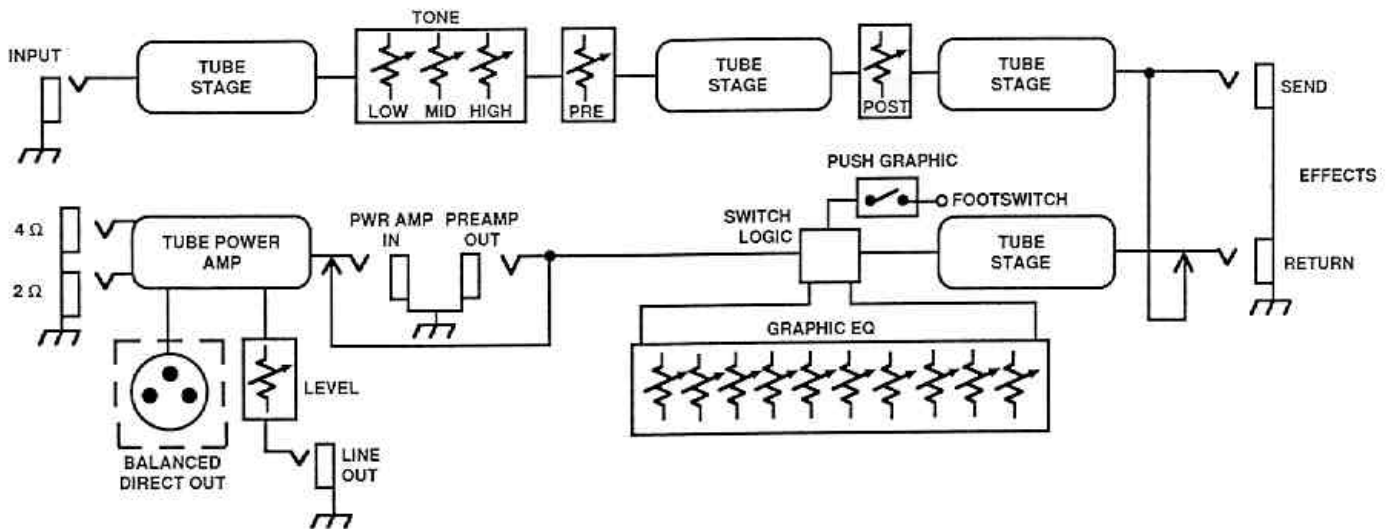

SPECIFICATIONS

POWER AMPLIFIER SECTION

6-6L6GC's with 12AT7 drive and 12AX7 predriver

RATED POWER & LOAD

160W RMS into 4 or 2 ohms

POWER @ CLIPPING (Typically)

(5% THD, 1 kHz, 120V AC line)
170W RMS into 4 ohms
165W RMS into 2 ohms
(Bias must be reduced to measure)

FREQUENCY RESPONSE

+0, -1 dB 40 Hz to 10 kHz
@ 140 watts into 4 ohms

HUM & NOISE

Greater than 95 dB below the rated power

POWER CONSUMPTION

550 watts, 50/60 Hz, 120V AC

PREAMP SECTION

2-12AX7's

THE FOLLOWING SPECS ARE MEASURED @ 1 kHz WITH THE CONTROLS PRESET AS FOLLOWS

Push Bright Off (Out)
Push Graphic On (In)
Low & High @ 10
Mid @ 0
Post Gain @ 10
Graphic EQ @ 0 dB

Nominal levels are with normal gain @ 5
Minimum levels are with normal gain @ 10

PREAMP HIGH GAIN INPUT

Impedance: Very high Z, 1M ohms
Nominal Input Level: -16 dBV,
150 mV RMS
Minimum Input Level: -44 dBV,
6 mV RMS
Maximum Input Level: 0 dBV, 1V RMS

PREAMP LOW GAIN INPUT

Impedance: High Z, 44K ohms
Nominal Input Level: -10 dBV,
300 mV RMS
Minimum Input Level: -38 dBV,
12 mV RMS
Maximum Input Level: +6 dBV, 2V RMS

EFFECTS SEND

Load Impedance: 20K ohms or greater
Nominal Output Level: -10 dBV,
0.3V RMS

EFFECTS RETURN

Impedance: Very high Z, 470K ohms
Designed Input Level: -10 dBV,
0.3V RMS
(Switching jack providing Effects Send to Effects Return connection when not used)

PREAMP OUTPUT

Load Impedance: 1K ohms or greater
Nominal Output Level: +10 dBV, 3V RMS

POWER AMP INPUT

Impedance: High Z, 22K ohms
Designed Input Level: +10 dBV, 3V RMS
(Switching jack providing Preamp Output to Power Amp Input connection when not used)

LINE OUTPUT

Load Impedance: 20K ohms or greater
Maximum Output Level: +10 dBV,
3V RMS

DIRECT OUTPUT

Load Impedance: 600 ohms or greater
Nominal Output Level: -6 dBV,
500 mV RMS
(Transformer balanced/XLR connector)

SYSTEM HUM & NOISE @ NOMINAL INPUT LEVEL

(20 Hz to 20 kHz unweighted)
72 dB below rated power

EQUALIZATION (Normal Channel Only)

Special Low, Mid & High passive type EQ
Footswitchable 7 band Graphic: +/-
12 dB @ 80, 120, 180, 340, 680, 1.3K,
2.6K, 5K, and 10 kHz; Peak/Notch
Push Bright: +10 dB @ 2 kHz

EXTERNAL FOOTSWITCH FUNCTION

Graphic EQ Defeat (when selected with button)

STONE TONING CHART



AlphaBASS™

ADJUST TO TASTE HIGH ENERGY TUBE BASS AMPLIFIER

INPUTS		GAIN		EQUALIZATION				EFX		GRAPHIC EQ							POWER			
HIGH	LOW	PRE	BRIGHT	POST	LOW	MID	HIGH	SEND	RET	80	120	180	340	660	1.3K	2.6K	5K	10K	●	●
			<input type="checkbox"/>																	
			GRAPHIC "IN"							80	120	180	340	660	1.3K	2.6K	5K	10K		STANDBY

COUNTRY CLEAN



AlphaBASS™

HIGH ENERGY TUBE BASS AMPLIFIER

INPUTS		GAIN		EQUALIZATION				EFX		GRAPHIC EQ							POWER			
HIGH	LOW	PRE	BRIGHT	POST	LOW	MID	HIGH	SEND	RET	80	120	180	340	660	1.3K	2.6K	5K	10K	●	●
			<input type="checkbox"/>																	
			GRAPHIC "IN"							80	120	180	340	660	1.3K	2.6K	5K	10K		STANDBY

ROCK MILD



AlphaBASS™

ADJUST TO TASTE HIGH ENERGY TUBE BASS AMPLIFIER

INPUTS		GAIN		EQUALIZATION				EFX		GRAPHIC EQ							POWER			
HIGH	LOW	PRE	BRIGHT	POST	LOW	MID	HIGH	SEND	RET	80	120	180	340	660	1.3K	2.6K	5K	10K	●	●
			<input type="checkbox"/>																	
			GRAPHIC "IN"							80	120	180	340	660	1.3K	2.6K	5K	10K		STANDBY

ROCK CLEAN

Tone settings given are general and will vary according to type of guitar, type and gauges of strings, type of pickup and even type of pick. Personal taste, playing style, and type of music greatly contribute to desired tonality.

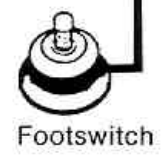
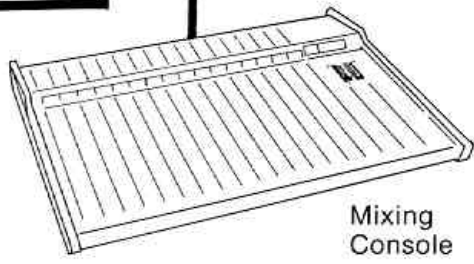
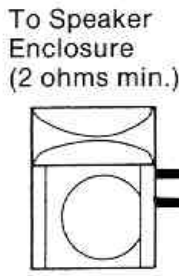
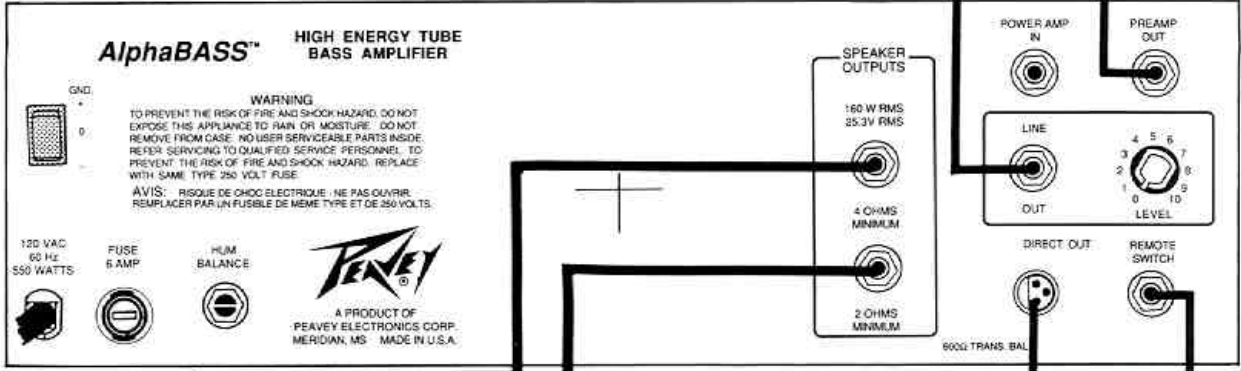
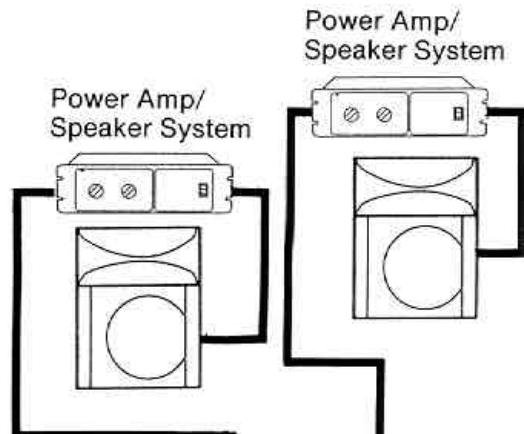
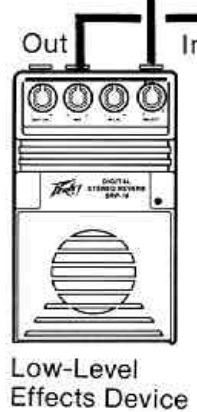
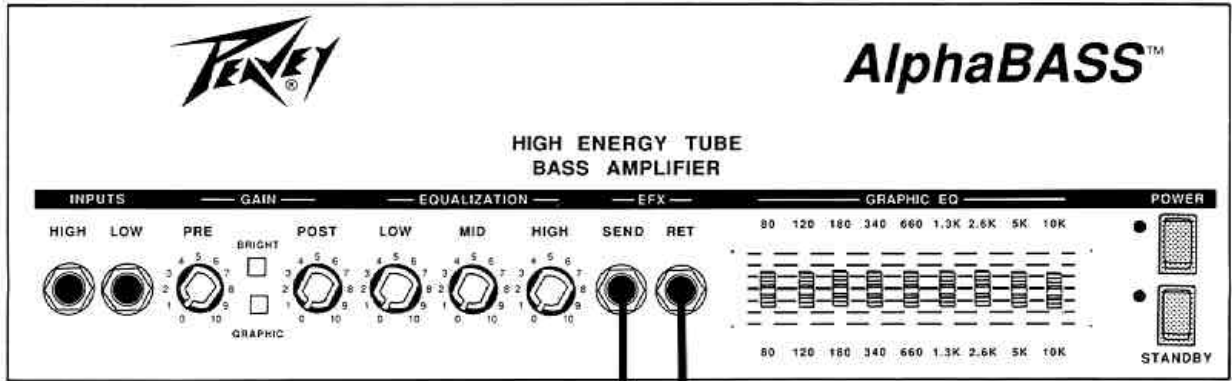

NOTE: System Should Not Be Operated Without Speaker Connected.

THIS LIMITED WARRANTY VALID ONLY WHEN PURCHASED AND REGISTERED IN THE UNITED STATES OR CANADA. ALL EXPORTED PRODUCTS ARE SUBJECT TO WARRANTY AND SERVICES TO BE SPECIFIED AND PROVIDED BY THE AUTHORIZED DISTRIBUTOR FOR EACH COUNTRY.

Ces clauses de garantie ne sont valables qu'aux Etats-Unis et au Canada. Dans tous les autres pays, les clauses de garantie et de maintenance sont fixées par le distributeur national et assurées par lui selon la législation en vigueur.

Diese Garantie ist nur in den USA und Kanada gültig. Alle Export-Produkte sind der Garantie und dem Service des Importeurs des jeweiligen Landes unterworfen.

Esta garantía es válida solamente cuando el producto es comprado en E.U. continentales o en Canada. Todos los productos que sean comprados en el extranjero, están sujetos a las garantías y servicio que cada distribuidor autorizado determine y ofrezca en los diferentes países.

ONE-YEAR LIMITED WARRANTY/REMEDY

PEAVEY ELECTRONICS CORPORATION ("PEAVEY") warrants this product, EXCEPT for covers, footswitches, patchcords, tubes and meters, to be free from defects in material and workmanship for a period of one (1) year from date of purchase, PROVIDED, however that this limited warranty is extended only to the original retail purchaser and is subject to the conditions, exclusions and limitations hereinafter set forth:

PEAVEY 90-DAY LIMITED WARRANTY ON TUBES AND METERS

If this product contains tubes or meters, Peavey warrants the tubes or meters contained in the product to be free from defects in material and workmanship for a period of ninety (90) days from date of purchase; PROVIDED, however, that this limited warranty is extended only to the original retail purchaser and is also subject to the conditions, exclusions and limitations hereinafter set forth.

CONDITIONS, EXCLUSIONS AND LIMITATIONS OF LIMITED WARRANTIES

These limited warranties shall be void and of no effect if:

- The first purchase of the product is for the purpose of resale; or
- The original retail purchase is not made from an AUTHORIZED PEAVEY DEALER; or
- The product has been damaged by accident or unreasonable use, neglect, improper service or maintenance, or other causes not arising out of defects in material or workmanship; or
- The serial number affixed to the product is altered, defaced or removed.

In the event of a defect in material and/or workmanship covered by this limited warranty, Peavey will:

- In the case of tubes or meters, replace the defective component without charge;
- In other covered cases (i.e., cases involving anything other than covers, footswitches, patchcords, tubes or meters), repair the defect in material or workmanship or replace the product, at Peavey's option;

and provided, however, that, in any case, all costs of shipping, if necessary, are paid by you, the purchaser.

THE WARRANTY REGISTRATION CARD SHOULD BE ACCURATELY COMPLETED AND MAILED TO AND RECEIVED BY PEAVEY WITHIN FOURTEEN (14) DAYS FROM THE DATE OF YOUR PURCHASE.

In order to obtain service under these warranties, you must:

- Bring the defective item to any AUTHORIZED PEAVEY DEALER or AUTHORIZED PEAVEY SERVICE CENTER and present therewith the ORIGINAL PROOF OF PURCHASE supplied to you by the AUTHORIZED PEAVEY DEALER in connection with your purchase from him of this product.

If the DEALER or SERVICE CENTER is unable to provide the necessary warranty service you will be directed to the nearest other PEAVEY AUTHORIZED DEALER or AUTHORIZED PEAVEY SERVICE CENTER which can provide such service.

OR

- Ship the defective item, prepaid, to:

PEAVEY ELECTRONICS CORPORATION
International Service Center
Highway 80 East
MERIDIAN, MS 39301

including therewith a complete, detailed description of the problem, together with a legible copy of the original PROOF OF PURCHASE and a complete return address. Upon Peavey's receipt of these items:

If the defect is remedial under these limited warranties and the other terms and conditions expressed herein have been complied with, Peavey will provide the necessary warranty service to repair or replace the product and will return it, FREIGHT COLLECT, to you, the purchaser.

Peavey's liability to the purchaser for damages from any cause whatsoever and regardless of the form of action, including negligence, is limited to the actual damages up to the greater of \$500.00 or an amount equal to the purchase price of the product that caused the damage or that is the subject of or is directly related to the cause of action. Such purchase price will be that in effect for the specific product when the cause of action arose. This limitation of liability will not apply to claims for personal injury or damage to real property or tangible personal property allegedly caused by Peavey's negligence. Peavey does not assume liability for personal injury or property damage arising out of or caused by a non-Peavey alteration or attachment, nor does Peavey assume any responsibility for damage to interconnected non-Peavey equipment that may result from the normal functioning and maintenance of the Peavey equipment.

UNDER NO CIRCUMSTANCES WILL PEAVEY BE LIABLE FOR ANY LOST PROFITS, LOST SAVINGS, ANY INCIDENTAL DAMAGES OR ANY CONSEQUENTIAL DAMAGES ARISING OUT OF THE USE OR INABILITY TO USE THE PRODUCT, EVEN IF PEAVEY HAS BEEN ADVISED OF THE POSSIBILITY OF SUCH DAMAGES.

THESE LIMITED WARRANTIES ARE IN LIEU OF ANY AND ALL WARRANTIES, EXPRESS OR IMPLIED, INCLUDING, BUT NOT LIMITED TO, THE IMPLIED WARRANTIES OF MERCHANTABILITY AND FITNESS FOR A PARTICULAR USE; PROVIDED, HOWEVER, THAT IF THE OTHER TERMS AND CONDITIONS NECESSARY TO THE EXISTENCE OF THE EXPRESS, LIMITED WARRANTIES, AS HEREINABOVE STATED, HAVE BEEN COMPLIED WITH, IMPLIED WARRANTIES ARE NOT DISCLAIMED DURING THE APPLICABLE ONE-YEAR OR NINETY-DAY PERIOD FROM DATE OF PURCHASE OF THIS PRODUCT.

SOME STATES DO NOT ALLOW LIMITATION ON HOW LONG AN IMPLIED WARRANTY LASTS, OR THE EXCLUSION OR LIMITATION OF INCIDENTAL OR CONSEQUENTIAL DAMAGES, SO THE ABOVE LIMITATIONS OR EXCLUSIONS MAY NOT APPLY TO YOU. THESE LIMITED WARRANTIES GIVE YOU SPECIFIC LEGAL RIGHTS, AND YOU MAY ALSO HAVE OTHER RIGHTS WHICH MAY VARY FROM STATE TO STATE.

THESE LIMITED WARRANTIES ARE THE ONLY EXPRESS WARRANTIES ON THIS PRODUCT, AND NO OTHER STATEMENT, REPRESENTATION, WARRANTY OR AGREEMENT BY ANY PERSON SHALL BE VALID OR BINDING UPON PEAVEY.

In the event of any modification or disclaimer of express or implied warranties, or any limitation of remedies, contained herein conflicts with applicable law, then such modification, disclaimer or limitation, as the case may be, shall be deemed to be modified to the extent necessary to comply with such law.

Your remedies for breach of these warranties are limited to those remedies provided herein and Peavey Electronics Corporation gives this limited warranty only with respect to equipment purchased in the United States of America.

INSTRUCTIONS — WARRANTY REGISTRATION CARD

1. Mail the completed WARRANTY REGISTRATION CARD to:

PEAVEY ELECTRONICS CORPORATION
POST OFFICE BOX 2898
MERIDIAN, MISSISSIPPI 39302-2898

- a. Keep the PROOF OF PURCHASE. In the event warranty service is required during the warranty period, you will need this document. **There will be no identification card issued by Peavey Electronics Corporation.**

2. IMPORTANCE OF WARRANTY REGISTRATION CARDS AND NOTIFICATION OF CHANGES OF ADDRESS:

- a. Completion and mailing of WARRANTY REGISTRATION CARDS — Should notification become necessary for any condition that may require correction, the REGISTRATION CARD will help ensure that you are contacted and properly notified.
- b. Notice of address changes — If you move from the address shown on the WARRANTY REGISTRATION CARD, you should notify Peavey of the change of address so as to facilitate your receipt of any bulletins or other forms of notification which may become necessary in connection with any condition that may require dissemination of information or correction.

3. You may contact Peavey directly by telephoning (601) 483-5365.

4. Please have the Peavey product name and serial number available when communicating with Peavey Customer Service.

DANGER

EXPOSURE TO EXTREMELY HIGH NOISE LEVELS MAY CAUSE A PERMANENT HEARING LOSS. INDIVIDUALS VARY CONSIDERABLY IN SUSCEPTIBILITY TO NOISE INDUCED HEARING LOSS, BUT NEARLY EVERYONE WILL LOSE SOME HEARING IF EXPOSED TO SUFFICIENTLY INTENSE NOISE FOR A SUFFICIENT TIME.

THE U.S. GOVERNMENT'S OCCUPATIONAL SAFETY AND HEALTH ADMINISTRATION (OSHA) HAS SPECIFIED THE FOLLOWING PERMISSIBLE NOISE LEVEL EXPOSURES:

DURATION PER DAY IN HOURS	SOUND LEVEL dBA, SLOW RESPONSE
8	90
6	92
4	95
3	97
2	100
1½	102
1	105
¾	110
½ or less	115

ACCORDING TO OSHA, ANY EXPOSURE IN EXCESS OF THE ABOVE PERMISSIBLE LIMITS COULD RESULT IN SOME HEARING LOSS.

EAR PLUGS OR PROTECTORS IN THE EAR CANALS OR OVER THE EARS MUST BE WORN WHEN OPERATING THIS AMPLIFICATION SYSTEM IN ORDER TO PREVENT A PERMANENT HEARING LOSS IF EXPOSURE IS IN EXCESS OF THE LIMITS AS SET FORTH ABOVE. TO INSURE AGAINST POTENTIALLY DANGEROUS EXPOSURE TO HIGH SOUND PRESSURE LEVELS, IT IS RECOMMENDED THAT ALL PERSONS EXPOSED TO EQUIPMENT CAPABLE OF PRODUCING HIGH SOUND PRESSURE LEVELS SUCH AS THIS AMPLIFICATION SYSTEM BE PROTECTED BY HEARING PROTECTORS WHILE THE UNIT IS IN OPERATION.

CAUTION

THIS AMPLIFIER HAS BEEN DESIGNED AND CONSTRUCTED TO PROVIDE ADEQUATE POWER RESERVE FOR PLAYING MODERN MUSIC WHICH MAY REQUIRE OCCASIONAL PEAK POWER TO HANDLE OCCASIONAL PEAK POWER. ADEQUATE POWER "HEADROOM" HAS BEEN DESIGNED INTO THIS SYSTEM. EXTENDED OPERATION AT ABSOLUTE MAXIMUM POWER LEVELS IS NOT RECOMMENDED SINCE THIS COULD DAMAGE THE ASSOCIATED LOUDSPEAKER SYSTEM. PLEASE BE AWARE THAT **MAXIMUM POWER** CAN BE OBTAINED WITH VERY LOW SETTINGS OF THE GAIN CONTROLS IF THE INPUT SIGNAL IS VERY STRONG.

1. Read all safety and operating instructions before using this product.
2. All safety and operating instructions should be retained for future reference.
3. Obey all cautions in the operating instructions and on the back of the unit.
4. All operating instructions should be followed.
5. This product should not be used near water, i.e. a bathtub, sink, swimming pool, wet basement, etc.
6. This product should be located so that its position does not interfere with its proper ventilation. It should not be placed flat against a wall or placed in a built-in enclosure that will impede the flow of cooling air.
7. This product should not be placed near a source of heat such as a stove, radiator or another heat producing amplifier.
8. Connect only to a power supply of the type marked on the unit adjacent to the power supply cord.
9. Never break off the ground pin on the power supply cord. For more information on grounding write for our free booklet "Shock Hazard and Grounding."
10. Power supply cords should always be handled carefully. Never walk or place equipment on power supply cords. Periodically check cords for cuts or signs of stress, especially at the plug and the point where the cord exits the unit.
11. The power supply cord should be unplugged when the unit is to be unused for long periods of time.
12. If this product is to be mounted in an equipment rack, rear support should be provided.
13. Metal parts can be cleaned with a damp rag. The vinyl covering used on some units can be cleaned with a damp rag or an ammonia based household cleaner if necessary.
14. Care should be taken so that objects do not fall and liquids are not spilled into the unit through the ventilation holes or any other openings.
15. This unit should be checked by a qualified service technician if:
 - A. The power supply cord or plug has been damaged.
 - B. Anything has fallen or been spilled into the unit.
 - C. The unit does not operate correctly.
 - D. The unit has been dropped or the enclosure damaged.
16. The user should not attempt to service this equipment. All service work should be done by a qualified service technician.



Features and specifications subject to change without notice.

Peavey Electronics Corporation / 711 A Street / Meridian, MS 39302-2898 / U.S.A. / (601) 483-5365 Telex: 504115 / Fax: 484-4278
©1989 Printed in the U.S.A. #80300980 2/89

Free Manuals Download Website

<http://myh66.com>

<http://usermanuals.us>

<http://www.somanuals.com>

<http://www.4manuals.cc>

<http://www.manual-lib.com>

<http://www.404manual.com>

<http://www.luxmanual.com>

<http://aubethermostatmanual.com>

Golf course search by state

<http://golfingnear.com>

Email search by domain

<http://emailbydomain.com>

Auto manuals search

<http://auto.somanuals.com>

TV manuals search

<http://tv.somanuals.com>