

SPECIFICATIONS QW™-1



Frequency response, 1 meter on-axis, swept-sine in an anechoic environment:

200 Hz to 18 kHz (± 3 dB)

Usable low frequency limit (-10 dB point):

150 Hz

Power handling:

Full Range:
600 Watts continuous
1200 Watts program
2400 Watts peak

Mid Frequency Section:

600 Watts continuous
1200 Watts program
2400 Watts peak

High Frequency Section:

100 Watts continuous
200 Watts program
400 Watts peak

Sound pressure level, 1 Watt, 1 meter in an anechoic environment:

Full Range:
101 dB SPL, (2 Volt input)

Mid Frequency Section:

101 dB SPL, (2 Volt input)

High Frequency Section:

111 dB SPL, (2.83 Volt input)

Maximum sound pressure level (1 meter):

Mid Frequency Section:

129 dB SPL continuous

135 dB SPL peak

High Frequency Section:

131 dB SPL continuous

137 dB SPL peak

Radiation angle measured at -6 dB point of polar response:

500 Hz to 1.6 kHz:

Horiz. $65^\circ \pm 15^\circ$

Vert. $60^\circ \pm 15^\circ$

1.6 kHz to 5 kHz:

Horiz. $40^\circ \pm 5^\circ$

Vert. $45^\circ \pm 15^\circ$

5 kHz to 16 kHz:

Horiz. $50^\circ \pm 5^\circ$

Vert. $30^\circ \pm 5^\circ$

Directivity factor, Q (Mean):

22.28 ± 9.65

Directivity index, Di (Mean):

13.10 dB ± 1.81 dB

Transducer complement:

Mid Frequency Section:

2x 10" woofers

BWX 1008-8 HE

High Frequency Section:

1x 1.6" exit/100 mm voice coil compression driver on Quadratic Throat Waveguide™ 44XT™ (without adapter) on CH®-642QT horn

Harmonic distortion:

1% rated power

Second Harmonic:

200 Hz: 0.50%

1 kHz: 0.98%

Third Harmonic:

200 Hz: 1.40%

1 kHz: 0.55%

10% rated power

Second Harmonic:

200 Hz: 0.70%

1 kHz: 3.15%



SPECIFICATIONS

QW™-1

Third Harmonic:
200 Hz: 5.25%
1 kHz: 0.31%

Recommended active crossover frequency region and slope:

Mid Frequency to High Frequency:
1,000 Hz at 18 dB/octave

Time Offset:

Mid Frequency: 0 ms
High Frequency: delay 0.813 ms

Impedance (Z):

Mid Frequency:
Nominal: 4 Ohms
Minimum: 4.2 Ohms
High Frequency:
Nominal: 8 Ohms
Minimum: 5.4 Ohms

Input connections:

2xNL4MP bi-amp MF and HF inputs in parallel

Enclosure materials and finish:

0.720 plywood finished in black Hammer Head™ hard coating

Mounting provisions:

 (12) 3/8" -16 threaded mounting suspension points (three each top and bottom and two each side and back). Use only forged shoulder machinery eye bolt, Mil Spec MIL51937-3.

Dimensions (H x W x D):

Front:
48.5" H x 21.0" W x 30.38" D
1232 mm x 533 mm x 772 mm
Rear:
48.5" H x 10.38" W x 30.38" D
1232 mm x 264 mm x 772 mm

Net weight:

154 lbs. (70 kg)

Features

- 200 Hz to 18 kHz
- Patented 4" diaphragm titanium compression driver, ferro fluid cooled
- Patented Quadratic Throat Waveguide™
- Flexible suspension provisions
- Maximum concert power
- Designed for professional bi-amp applications

Applications

- Stadiums
- Arenas
- Multi-purpose facilities
- Cruise ships
- Theme parks
- Concerts
- Theaters

Description

The new QW-1 is designed for the top end of a three- or four-way professional high performance sound system. When used in conjunction with the QW-215 and QW-218, in four-way applications, the sound pressure levels of a single four-way can reach SPLs of 140 dB continuous. The power handling of this system in four-way applications approaches 6800 Watts program. Due to its high efficiency drivers, the QW-1 has a rating of 1200 Watts program for the mids, with a 44XT™ rated at 200 Watts program (band limited 1000 Hz to 20 kHz). For reference, the QW-215 is rated at 2400 Watts program and the QW-218 is rated at 3200 Watts program.

The QW's patented CH®-642qt horn is loaded with the patented 44XT high efficiency compression driver and a BWX 1008-8 HE high powered mid, designed specifically for the QW-1. The horn has a coverage pattern of 60° in the horizontal axis and 40° in the vertical axis.

The QW-1 is designed for arraying in flying applications or stacking on a stage. Twelve mounting points are located on the unit for flying applications. Three flying points are located on the top and bottom, and two points are on the right and left sides and the rear of the enclosure.

The QW-1 is constructed with a special grade of high density 3/4" plywood and covered with a black Hammer Head hard coat, a tough finish equivalent to the durable liners used in truck beds today. This finish makes the enclosure very road-worthy, but more importantly the Hammer Head finish helps to dampen resonant modes that may develop. These minor, subtle resonant modes are dampened to help improve the overall sound quality of the system.

Frequency response

This measurement is useful in determining how accurately a given unit reproduces an input signal. The frequency response of the QW-1 is measured at a distance of 1 meter using a 1 Watt swept-sine input signal (into the nominal impedance). As shown in Figure 1, the selected drivers in the QW-1, in conjunction with the Peavey CEX 5, combine to give a smooth frequency response from 200 Hz to 18 kHz.

Directivity

Beamwidth is derived from the -6 dB points from the polar plots (see Figure 2), which are measured in a whole space anechoic environment. Q and Directivity Index are plotted for the on-axis measurement position. These specifications provide a reference to the coverage characteristics of the unit and insight into proper placement and installation in the chosen environment. The combination of components in the QW-1 exhibit a desirable beamwidth and directivity (Figures 2 and 3) suitable for sound reinforcement applications.

Power handling

Peavey rates this loudspeaker system's power handling using a full range form of the AES Standard 2-1984. Using audio band 20 Hz to 20 kHz pink noise with peaks of four times the RMS level, our strenuous testing assures that every portion of this system can withstand today's high technology music. This rating is contingent upon having a minimum of 3 dB amplifier headroom.

Harmonic distortion

Second and third harmonic distortions vs. frequency are plotted in Figures 4 and 5 for two power levels: ten percent (10%) of rated input power and either one percent (1%) of rated input power or 1 Watt, whichever is greater. Distortion is the difference between the fundamental signal (frequency response) and the desired harmonic. For example, a distortion curve down 40 dB from the fundamental is equivalent to 1% distortion.

SPECIFICATIONS QW™-1

Mounting

⚠ Caution: Before attempting to suspend this speaker, consult a certified structural engineer. This speaker can fall from improper suspension, resulting in serious injury and property damage. Other enclosures may be suspended below a QW-1, but the combined weight of additional enclosures and all cables, clamps and other hardware must not exceed 296 lbs. The QW-1 weighs 154 lbs. and the maximum combined weight suspended from the uppermost mounting bracket assemblies must not exceed 450 lbs. The maximum enclosure angle is 45°. Use only the correct mating hardware. All associated rigging is the responsibility of the user.

Architectural and engineering specifications

The loudspeaker system shall have an operating bandwidth of 200 Hz to 18 kHz. The nominal output level shall be 101 dB when measured at a distance of 1 meter with an input of 1 Watt. The nominal impedance shall be 4 Ohms. The maximum continuous power handling shall be 600 Watts, with maximum program power of 1200 Watts and peak power input of at least 2400 Watts (with a minimum amplifier headroom of 3 dB). The nominal radiation geometry shall be 60° in the horizontal plane and 40° in the vertical plane. The outside dimensions shall be 48.5" high by 21" wide by 30.38"

deep. The weight shall be 154 lbs. The loudspeaker system shall be a model QW-1.

3 + 2 YEAR LIMITED WARRANTY

NOTE: For details, refer to the warranty statement. Copies of this statement may be obtained by contacting Peavey Electronics Corporation, P.O. Box 2898, Meridian, Mississippi 39301-2898.

Amplitude Response (1W 1m On-Axis)

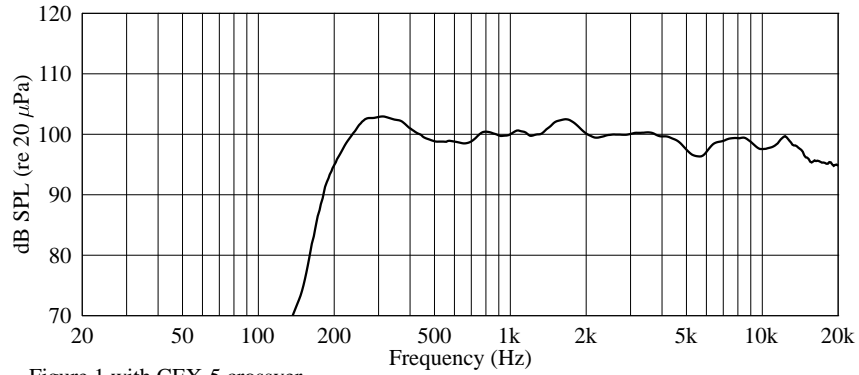

Figure 1 with CEX-5 crossover

Beamwidth

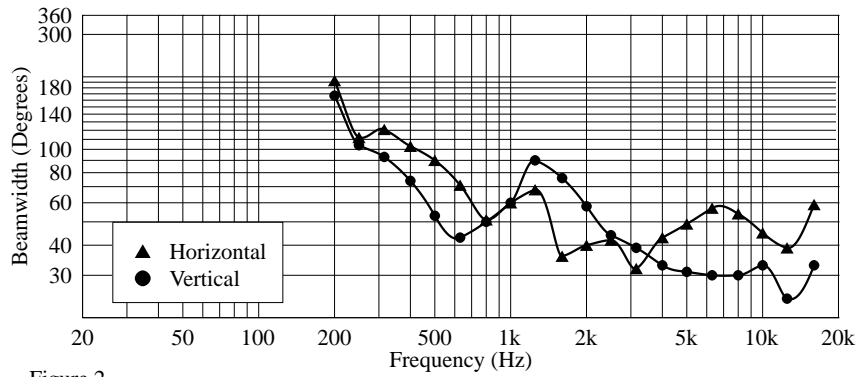

Figure 2

Q & Directivity Index

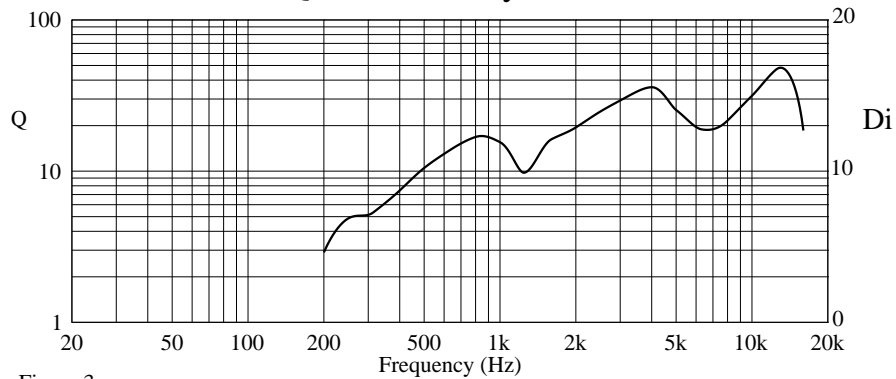

Figure 3

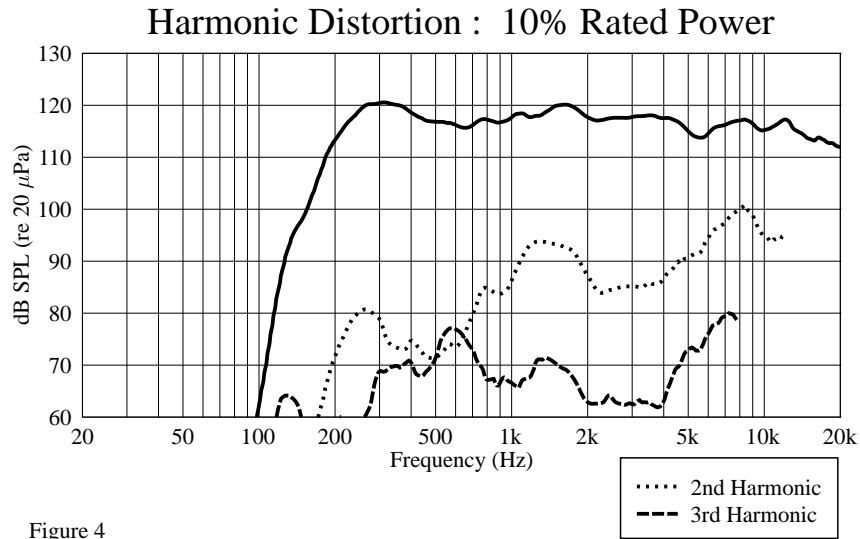

Figure 4

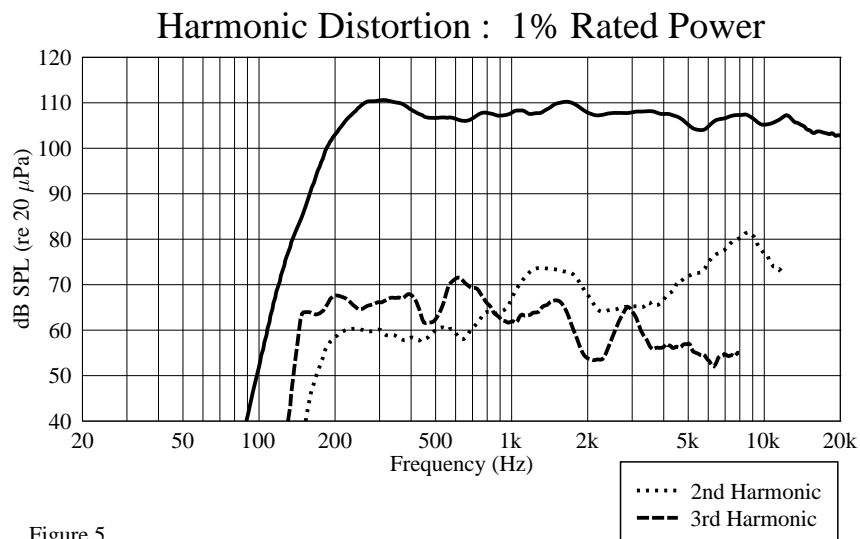

Figure 5

Amplitude Response (1W 1m On-Axis)

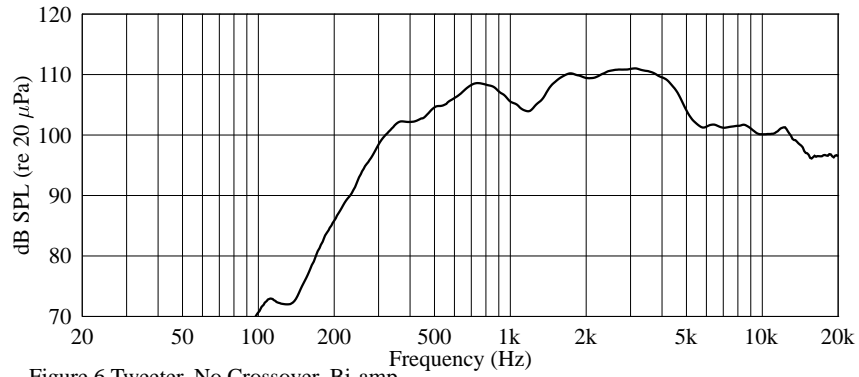

Figure 6 Tweeter, No Crossover, Bi-amp

Impedance

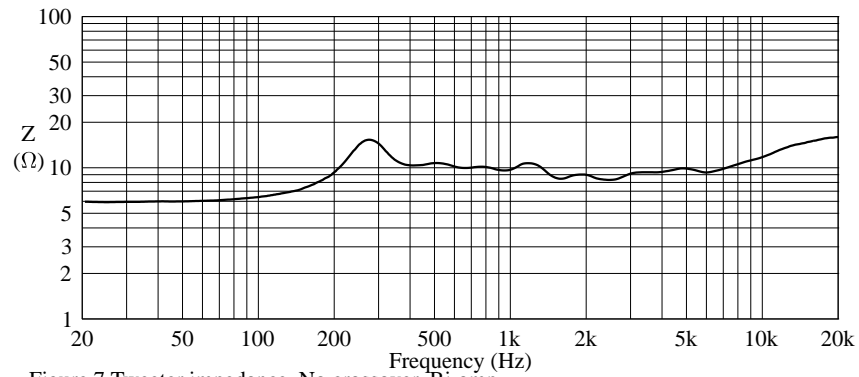

Figure 7 Tweeter impedance, No crossover, Bi-amp

Amplitude Response (1W 1m On-Axis)

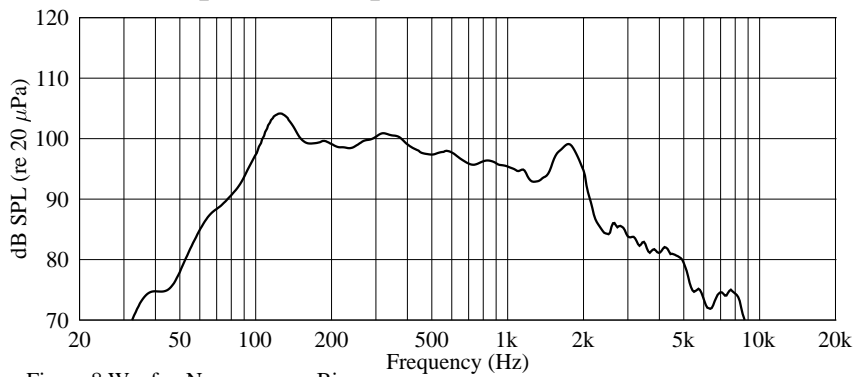

Figure 8 Woofer, No crossover, Bi-amp

Impedance

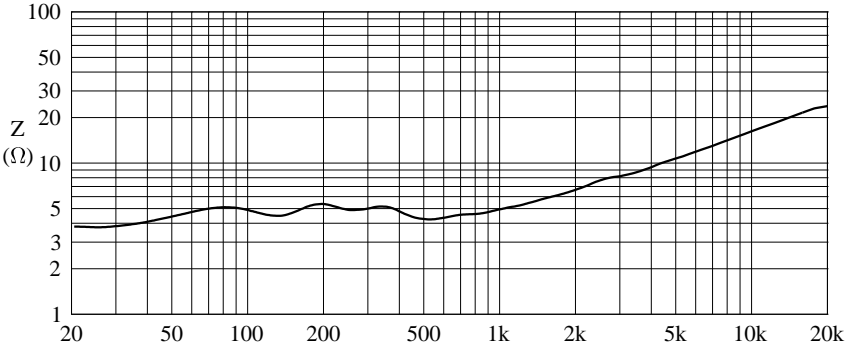
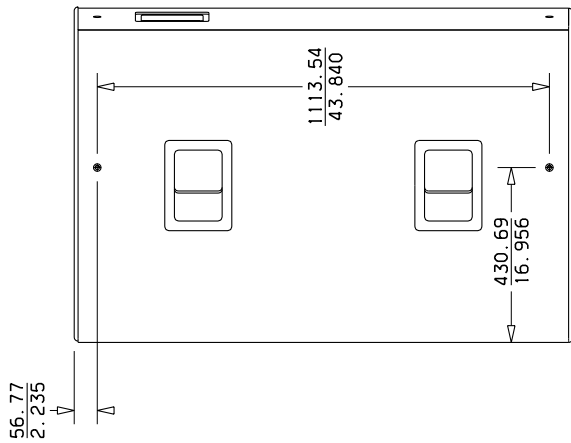
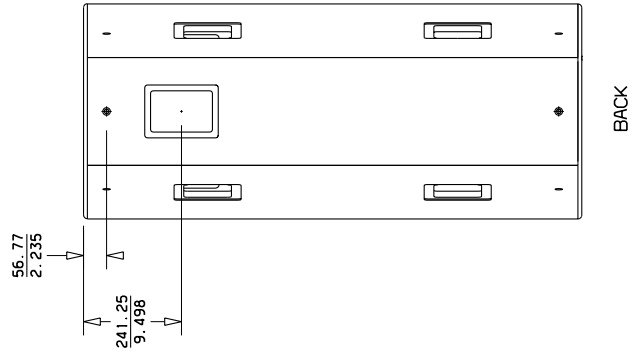

Figure 9 Woofer impedance, No crossover, Bi-amp

Flying points dimensions



VIEW A:A



BACK

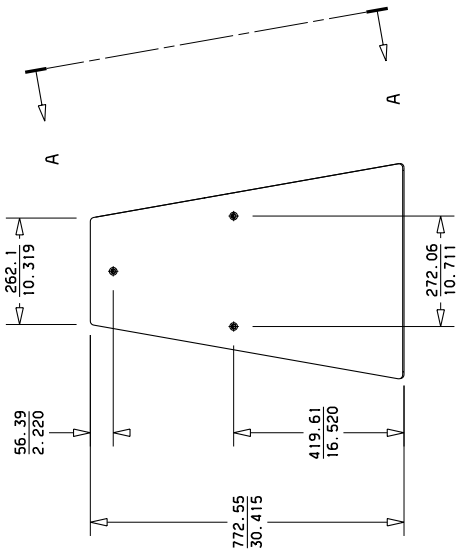

TOP

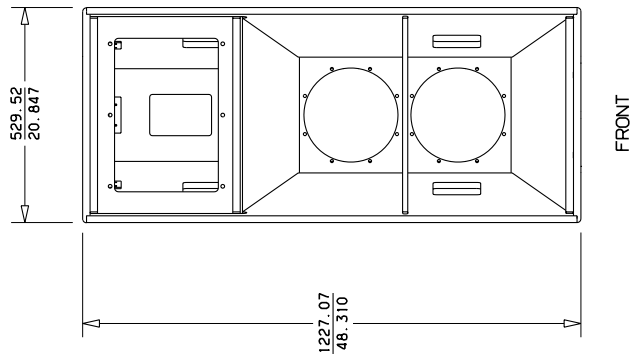

FRONT

O-W 1



80305054

Features and specifications subject to change without notice.

Peavey Electronics Corporation • 711 A Street • Meridian • MS • 39301 (601) 483-5365 • FAX (601) 486-1278 • www.peavey.com

©2002 Printed in the U.S.A. 12/02



Free Manuals Download Website

<http://myh66.com>

<http://usermanuals.us>

<http://www.somanuals.com>

<http://www.4manuals.cc>

<http://www.manual-lib.com>

<http://www.404manual.com>

<http://www.luxmanual.com>

<http://aubethermostatmanual.com>

Golf course search by state

<http://golfingnear.com>

Email search by domain

<http://emailbydomain.com>

Auto manuals search

<http://auto.somanuals.com>

TV manuals search

<http://tv.somanuals.com>