



Endura™ SP04-140 Dual-Input Video Encoder



C613M-A (5/05)

Contents

Regulatory Notices	4
Description	5
Before You Begin	5
Parts List	5
Product Serial Number Label Placement	6
Equipment Placement and Rack Mounting	7
Desktop Mounting	7
Wall Mounting	8
Rack Mounting	9
Pelco Badge Orientation	10
Connections	11
Connecting Video Inputs	11
Connecting Audio	13
Connecting a PTZ Device, Relay, and Alarms	14
Connecting a PTZ Device (Pelco D Protocol)	15
Connecting a Relay Device	16
Connecting Alarms	17
Connecting Power	19
Connecting to the Network	20
Operation	21
Front Panel Indicators	21
Configuration/Reset Button	22
Troubleshooting	23
Specifications	24

List of Illustrations

1	Product Serial Number Label	6
2	SP04-140 Desktop Placement	7
3	SP04-140 and WM5001-4U Wall Mount	8
4	Tighten the Thumbscrew to Secure the Unit	8
5	Multiple SP04-140 Units in an RK5000PS-5U	9
6	Tighten Thumbscrew to Secure the Unit	9
7	Pelco Badge Orientation	10
8	SP04-140 Rear Panel	11
9	Video Inputs	11
10	SP04-140 Audio Connections	13
11	SP04-140 Terminal Block	14
12	Connecting a Spectra Dome	15
13	Connecting a Relay Device	16
14	Supervised Alarm Conditions	17
15	Supervised Alarm Input Wiring	18
16	Unsupervised Alarm Conditions	18
17	Unsupervised Alarm Input Wiring	18
18	Connecting Alarms	19
19	Connecting Power	20
20	SP04-140 Front Panel	21

List of Tables

A	Video Coaxial Cable Requirements	12
B	PTZ, Relay, and Alarm Pin Assignments	14
C	Serial Port Options and Defaults	16
D	Powering Multiple Units	19
E	Recommended Wire Gauge and Maximum Wiring Distances	20
F	Configuration/Reset Button Functions and Indicators	22
G	Troubleshooting the SP04-140	23

Regulatory Notices

This device complies with Part 15 of the FCC Rules. Operation is subject to the following two conditions: (1) this device may not cause harmful interference, and (2) this device must accept any interference received, including interference that may cause undesired operation.

RADIO AND TELEVISION INTERFERENCE

This equipment has been tested and found to comply with the limits of a Class B digital device, pursuant to Part 15 of the FCC Rules. These limits are designed to provide reasonable protection against harmful interference in a residential installation. This equipment generates, uses, and can radiate radio frequency energy and, if not installed and used in accordance with the instructions, may cause harmful interference to radio communications. However there is no guarantee that the interference will not occur in a particular installation. If this equipment does cause harmful interference to radio or television reception, which can be determined by turning the equipment off and on, the user is encouraged to try to correct the interference by one or more of the following measures:

- Reorient or relocate the receiving antenna.
- Increase the separation between the equipment and the receiver.
- Connect the equipment into an outlet on a circuit different from that to which the receiver is connected.
- Consult the dealer or an experienced radio/TV technician for help.

You may also find helpful the following booklet, prepared by the FCC: "How to Identify and Resolve Radio-TV Interference Problems." This booklet is available from the U.S. Government Printing Office, Washington D.C. 20402.

Changes and Modifications not expressly approved by the manufacturer or registrant of this equipment can void your authority to operate this equipment under Federal Communications Commission's rules.

In order to maintain compliance with FCC regulations, shielded cables must be used with this equipment. Operation with non-approved equipment or unshielded cables is likely to result in interference to radio and television reception.

This Class B digital apparatus complies with Canadian ICES-003.

Cet appareil numérique de la classe B est conforme à la norme NMB-003 du Canada.

Description

The SP04-140 is a special version of the single-input NET5301T video encoder. It is a high-performance, dual-stream, dual-input video encoding unit. Its main function is to convert live analog video from two cameras into dual MPEG-4 video streams. It transmits these streams over an Ethernet network to other Endura™ system components. Then these streams can be recorded on an Endura NVR5100 Series network video recorder or decoded by the following Endura components:

- NET5301R video decoder: Converts up to 4 video streams for display or recording on an analog device.
- WS5050 workstation: Converts up to 16 video streams for display on a computer monitor.
- VCD5000 video console display: Converts up to 64 video streams (depending on model) for display or recording on an analog device.

NOTE: The front panel of the SP04-140 shows NET5301T as the model. However, the special number appears on the product serial number label on the unit's bottom panel.

The SP04-140 incorporates EnduraView™ video optimization technology to select the best image quality and frame rate for the target Endura product (decoder, workstation, console), all without affecting the system recording rate. For example, the unit selects a high rate and quality setting for recording and alarm conditions; it selects a lower rate for simple monitoring.

The SP04-140 can be configured for three alarm inputs and one relay output. When an alarm event is triggered, the unit can send a message to an operator, trigger a relay, and implement video recording.

The unit also supports activity detection. You can configure up to four activity zones. When the SP04-140 detects activity in any of these areas, it can trigger an alarm event.

The video encoder supports half-duplex, bidirectional audio over the network. The system operator (security personnel) can see and hear the person.

All Endura products support Pelco D and Coaxitron® protocols. As a result, the SP04-140 supports control of remote peripherals such as pan/tilt/zoom (PTZ) cameras.

Before You Begin

Endura is a network system that requires a continuous amount of bandwidth to transmit true, live video. Therefore, always include your network administrator when planning and installing Endura components.

You will also need the following:

- Pelco-approved Endura certification
- Power source
- One or two NTSC or PAL (fixed or PTZ) cameras
- Microphone and speaker (if using audio)
- Small flat-tip screwdriver (if connecting camera control, relay, or alarms)
- Access to an Endura network

NOTE: Since power requirements vary by installation, the SP04-140 does not include an individual power supply. You can purchase the optional NET5301PS single-unit power supply from Pelco. Refer to *Connecting Power* for more information on supplying power to the SP04-140.

PARTS LIST

Qty	Description
1	SP04-140 dual-input video encoder
1	16-pin terminal block
1	Two-pin power terminal block
1	SP04-140 Installation manual
1	Pelco badge rotation sticker

PRODUCT SERIAL NUMBER LABEL PLACEMENT

Product serial number labels help Pelco's Product Support identify your system and its factory configuration in case the SP04-140 or its components require service.

A label citing your product's serial number is attached to the bottom panel of the SP04-140. Because rack mounting or other installation options may obscure the factory-applied label, two additional labels are provided. Attach one of them to your product documentation or another product location that will not be obscured by installation. The second label is a spare.

To use these labels:

1. On the bottom panel of your SP04-140, locate two small labels, attached with a yellow sticker that reads, "Extra serial number labels: remove prior to installation."
2. Remove the yellow sticker and the labels.
3. Peel away the backing from one label and attach it to this installation manual, other product documentation, or an unobscured product location.

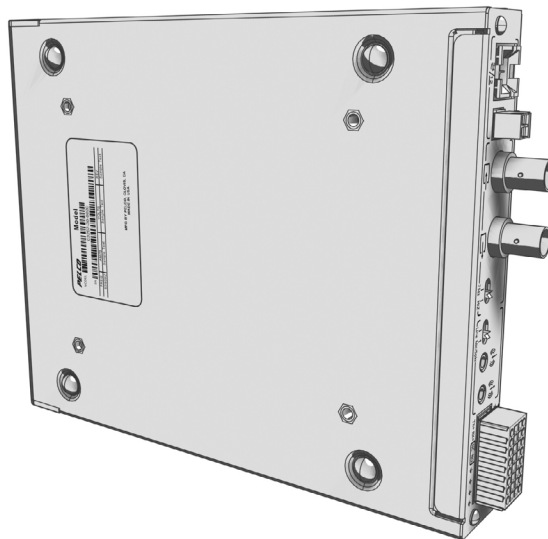

Figure 1. Product Serial Number Label

Equipment Placement and Rack Mounting

The SP04-140 can be placed on a flat surface, such as a desktop; mounted to a wall; or mounted into an equipment rack.

DESKTOP MOUNTING

To place the SP04-140 on a flat surface, such as a desktop:

1. Make sure the rubber feet are installed on the unit to prevent surface damage.
2. Position the unit to allow for cable and power cord clearance at the front and rear panels.

⚠ WARNING: Do not place the SP04-140 unit on its side; the unit could fall over and cause damage.

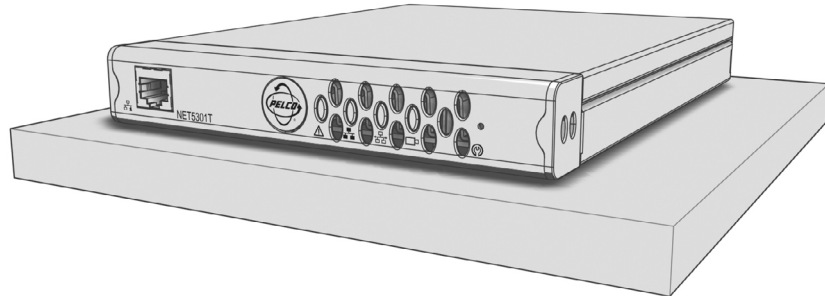

Figure 2. SP04-140 Desktop Placement

WALL MOUNTING

The SP04-140 can be mounted to a wall using the optional WM5001-4U wall mount system. You can mount up to four SP04-140, NET5301T, and NET5301R units, in any combination, in a fully expanded WM5001-4U (one WM5001-4U with up to three WM5001-4UEXP expansion units).

To mount the SP04-140 to a wall using the WM5001-4U:

1. Install the WM5001-4U and any WM5001-4UEXP expansion units (refer to the WM5000 installation manual).
2. Insert the SP04-140 into the desired wall mount unit. Make sure all front and rear panel connectors are accessible.

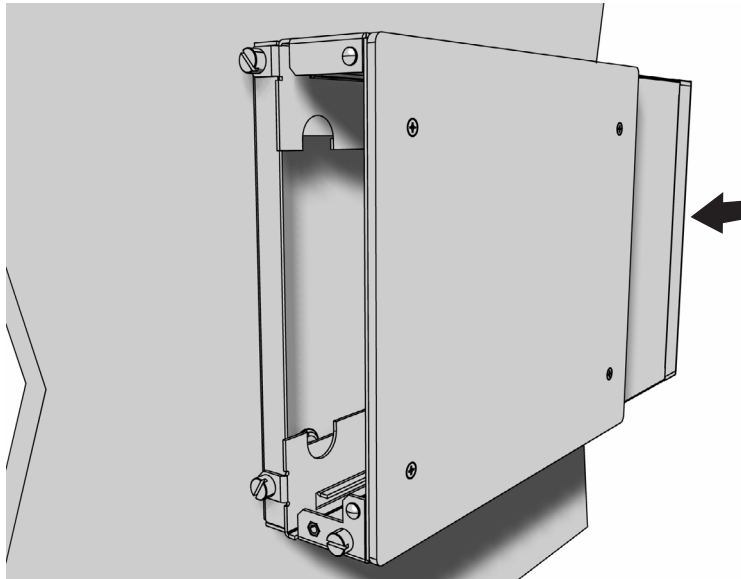

Figure 3. SP04-140 and WM5001-4U Wall Mount

3. Tighten the thumbscrew on the wall mount to secure the unit (refer to Figure 4).

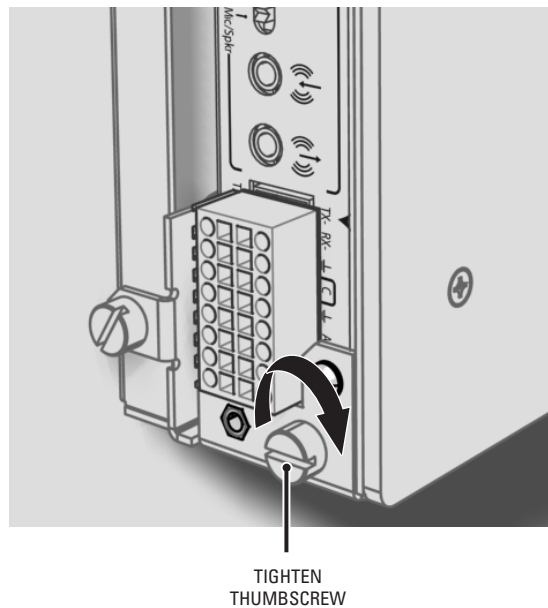

Figure 4. Tighten the Thumbscrew to Secure the Unit

RACK MOUNTING

Any combination of SP04-140, NET5301T, and NET5301R units can be mounted together in the optional RK5000PS-5U rack mount kit, up to 12 units. Each unit plugs directly into a power connector in the rack and is powered by the rack.

NOTE: The RK5000PS-5U only supplies power. It does not provide a dock for any other unit connectors.

To install the SP04-140 into a rack mount kit:

1. Install the RK5000PS-5U rack mount kit into the rack (refer to the RK5000PS-5U installation manual).
2. Insert the SP04-140 into the desired slot.

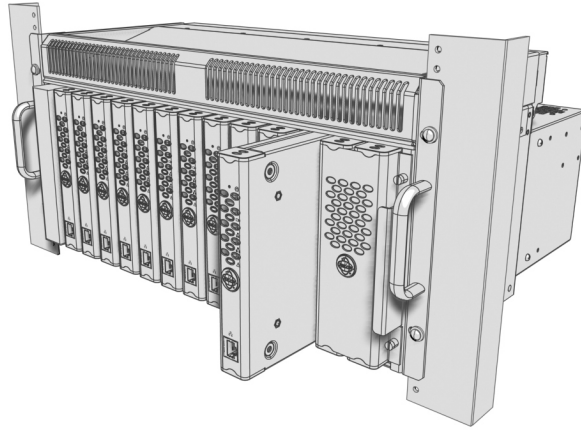

Figure 5. Multiple SP04-140 Units in an RK5000PS-5U

3. Tighten the thumbscrew on the rack mount to secure the unit into the rack (refer to Figure 6).

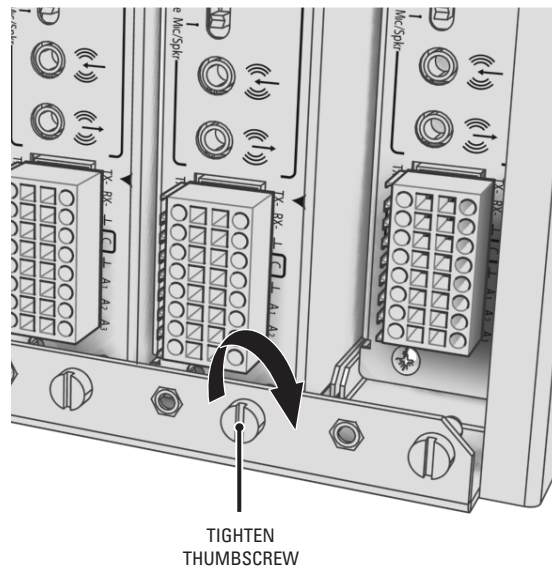

Figure 6. Tighten Thumbscrew to Secure the Unit

PELCO BADGE ORIENTATION

The Pelco badge on the front panel of the SP04-140 can be rotated in quarter turns. If you install the unit on a flat surface, the Pelco badge will be turned the wrong way.

To rotate the Pelco badge:

1. Use the Pelco badge rotation sticker that came with the unit.
2. Attach the middle portion of the rotation sticker to the badge.
3. Press firmly with your thumb and rotate the badge to its correct position.
4. Remove the rotation sticker from the badge.

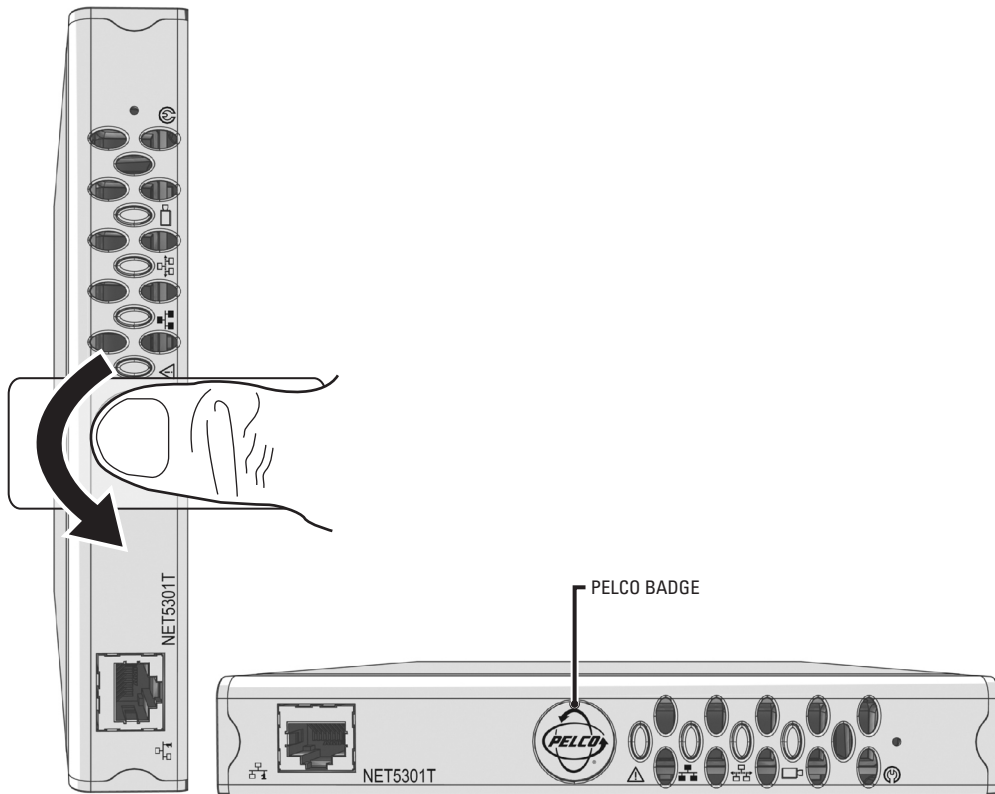

Figure 7. Pelco Badge Orientation

Connections

Familiarize yourself with the SP04-140 rear panel before connecting any equipment to the unit.

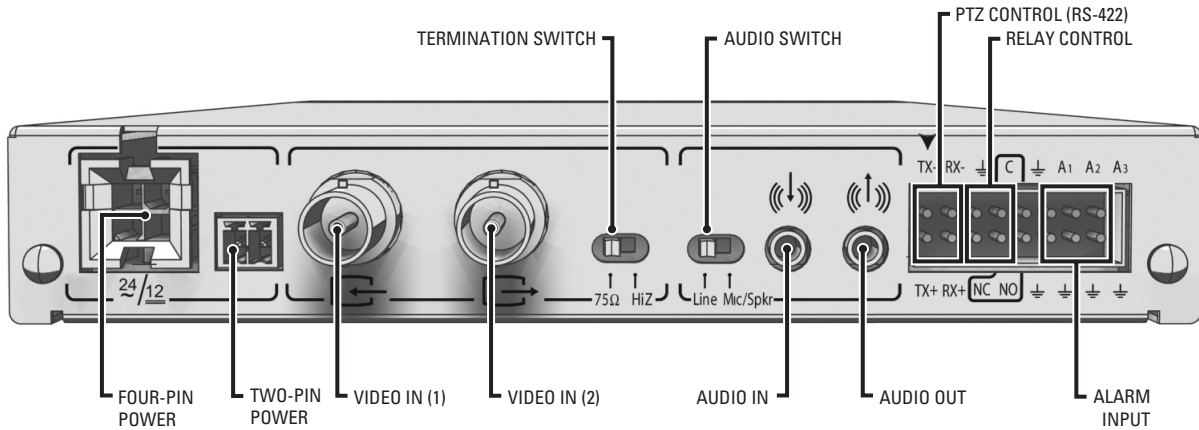

Figure 8. SP04-140 Rear Panel

CONNECTING VIDEO INPUTS

The SP04-140 offers two analog video inputs. The unit automatically detects the video standard (PAL or NTSC) and accepts both color and black-and-white analog video at both inputs.

The Video In (2) connector also supports PTZ operation using the following protocols:

- **Coaxitron:** When the SP04-140 receives a camera control command, it transmits that command up the coaxial cable to the PTZ device. Since Coaxitron is a single-direction protocol, the PTZ device cannot return any data to the unit. By default, Coaxitron is disabled.
- **Pelco D (RS-422):** When the SP04-140 receives a camera control command, it transmits that command via the serial wires to the PTZ device. Pelco D is a bidirectional protocol.

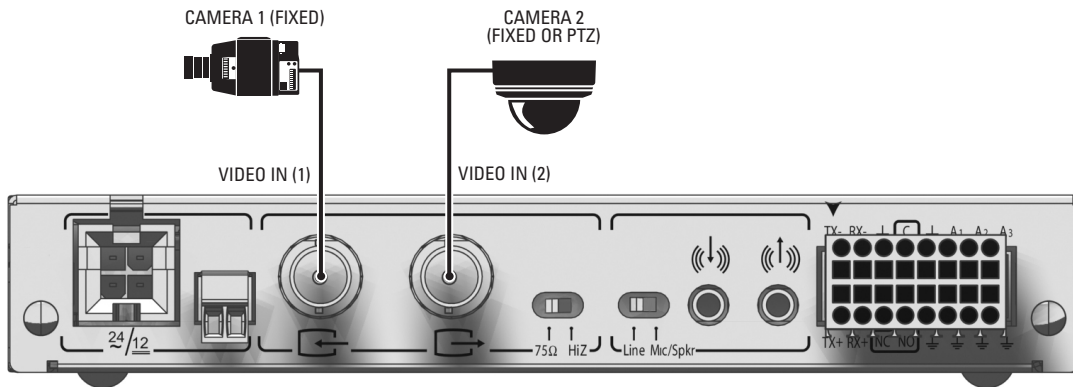

Figure 9. Video Inputs

Before installing the SP04-140, make sure the distance from the unit to the video device is less than the maximum distance for the coaxial cable. Refer to Table A for maximum video coaxial cable distances.

Table A. Video Coaxial Cable Requirements

Cable Type*	Maximum Distance
RG59/U	750 ft (229 m)
RG6/U	1,000 ft (305 m)
RG11/U	1,500 ft (457 m)

*Cable requirements:

75-ohm impedance

All-copper center conductor; steel-center conductor cable may result in poor performance

All-copper braided shield with 95% braid coverage

NOTE: Make sure the termination switch is set to 75Ω to enable termination. This is the default.

To connect a fixed camera:

1. Connect a coaxial cable to the camera device.
2. Connect the coaxial cable to the video in (1) connector on the rear panel.

To connect a second fixed camera:

1. Connect a coaxial cable to the camera device.
2. Connect the coaxial cable to the video in (2) connector on the rear panel.

To connect a PTZ device:

1. Connect a coaxial cable to the PTZ device.
2. Connect the coaxial cable to the video in (2) connector.
3. **Pelco D only:** Wire the TX and RX leads from the encoder to the PTZ device. Refer to *Connecting a PTZ Device (Pelco D Protocol)*.

CONNECTING AUDIO

The SP04-140 supports half-duplex, bidirectional audio (one direction at a time). It transmits audio and video signals simultaneously. This lets you control a loudspeaker or other audio equipment, such as a door intercom system, at the monitored location.

The unit supports both microphone and line input levels. Microphones are usually not powered; they have weaker signals that must be amplified. Line inputs usually have stronger, powered signals that have already been amplified.

NOTE: Use either microphone/speaker or line in/line out. The SP04-140 does not support mixed audio signal inputs and outputs.

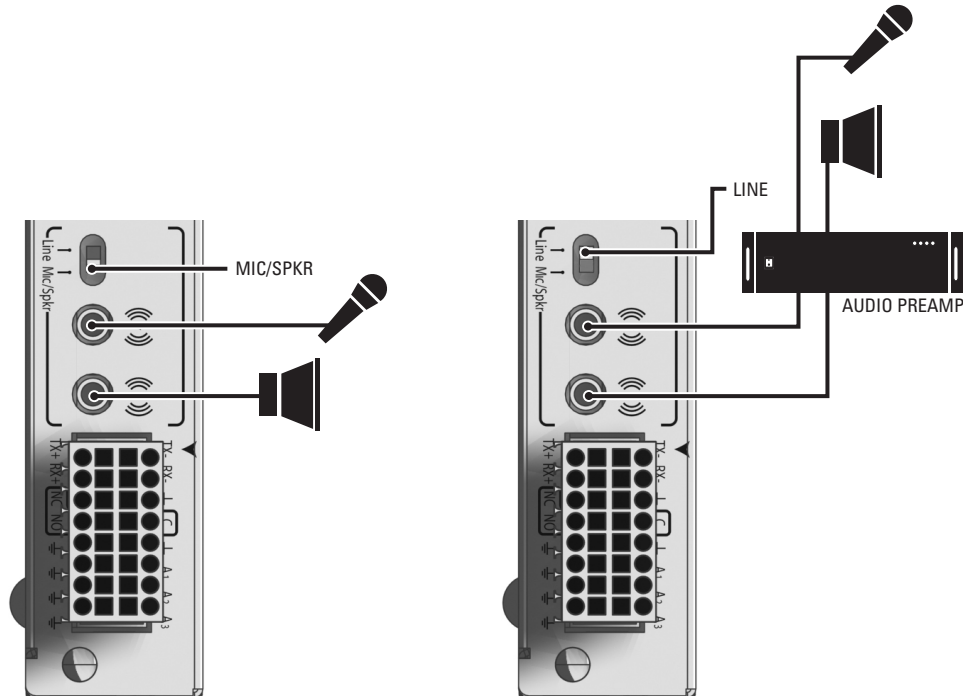

Figure 10. SP04-140 Audio Connections

To implement audio:

1. Select the type of audio signal:

Mic/Spkr Switch to Mic/Spkr if you are connecting a microphone or a speaker. The microphone input level is 5 mVp-p. The speaker output level is 2.5 Vp-p.

Line Switch to Line if you are connecting a powered audio input or output device. The line input and output level is 1 Vp-p. By default, the switch is set to Line.

NOTE: If the switch setting does not match your audio equipment, audio distortion problems may occur.

2. Make sure the input and output audio connectors are wired as follows:

Connector Tip Signal high

Connector Sleeve Common

3. Connect a line input device or microphone to the blue 3.5 mm audio in monaural connector. A preamplified microphone is recommended.
4. Connect a line output device or speaker to the green 3.5 mm audio out monaural connector.

NOTE: Audio out is not supported at this time.

CONNECTING A PTZ DEVICE, RELAY, AND ALARMS

The SP04-140 incorporates a 16-pin terminal block to support the following:

- PTZ device, such as a dome camera, using the Pelco D protocol (RS-422)
- Relay control, either normally open or normally closed
- Up to three alarm inputs, supervised or unsupervised, using any combination of high and low signals

The terminal block has tension clamps instead of screw terminals. Use a small screwdriver to open the clamp for a particular lead. Figure 11 shows how to wire the terminal block and connect it to the SP04-140.

NOTE: The terminal block is keyed. It attaches only one way to the video encoder.

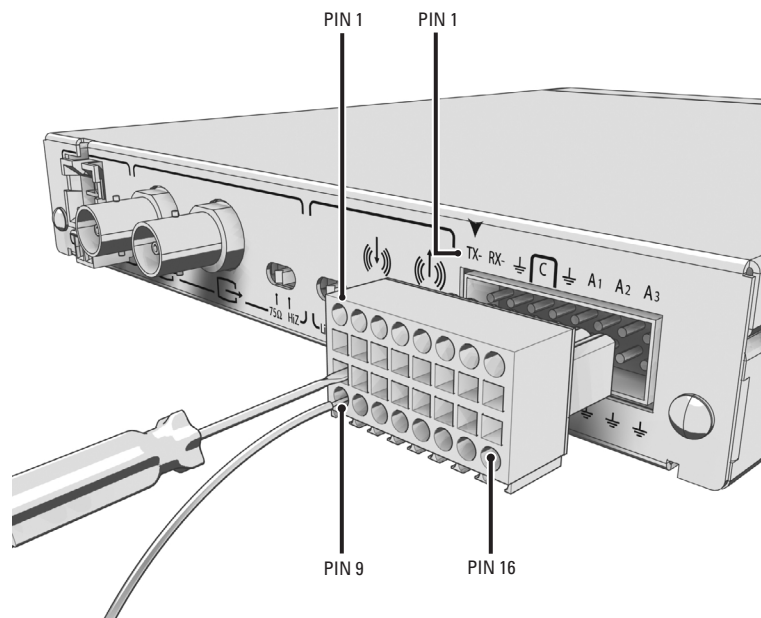

Figure 11. SP04-140 Terminal Block

Table B identifies the pin assignments for the terminal block. An arrow on the rear panel identifies pin 1; on the terminal block, pin 1 is the leftmost lead on the top row (refer to Figure 11).

Table B. PTZ, Relay, and Alarm Pin Assignments

Top Row			Bottom Row		
Pin	Label	Lead	Pin	Label	Lead
1	TX-	RS-422 Data TX-	9	TX+	RS-422 Data TX+
2	RX-	RS-422 Data RX-	10	RX+	RS-422 Data RX+
3	⏏	Ground	11	NC	Relay Normally Closed
4	C	Relay Common	12	NO	Relay Normally Open
5	⏏	Ground	13	⏏	Ground
6	A1	Alarm 1	14	⏏	Ground
7	A2	Alarm 2	15	⏏	Ground
8	A3	Alarm 3	16	⏏	Ground

CONNECTING A PTZ DEVICE (PELCO D PROTOCOL)

NOTE: To connect a Coaxitron PTZ device, refer to *Connecting Video Inputs*

The SP04-140 supports camera control using Pelco D protocol (RS-422) for a PTZ device. You can connect only one serial PTZ device to a video encoder. The default Pelco D device address is 0.

When the SP04-140 receives a camera control command, it transmits that command to the PTZ device. In four-wire installations, the encoder also receives data from the PTZ device, including camera status and alarm states. It then transmits that data to the command center.

Figure 12 shows how to wire the SP04-140 to a Spectra® dome (refer to Table B for the specific connector pin assignments).

NOTE: When connecting a PTZ device to the SP04-140, connect the TX+ and TX- leads to the RX+ and RX- leads between the encoder and the PTZ device.

By default, the encoder identifies any PTZ device as a fixed camera. You must configure the encoder before you can use the PTZ device (refer to the WS5000 operation manual).

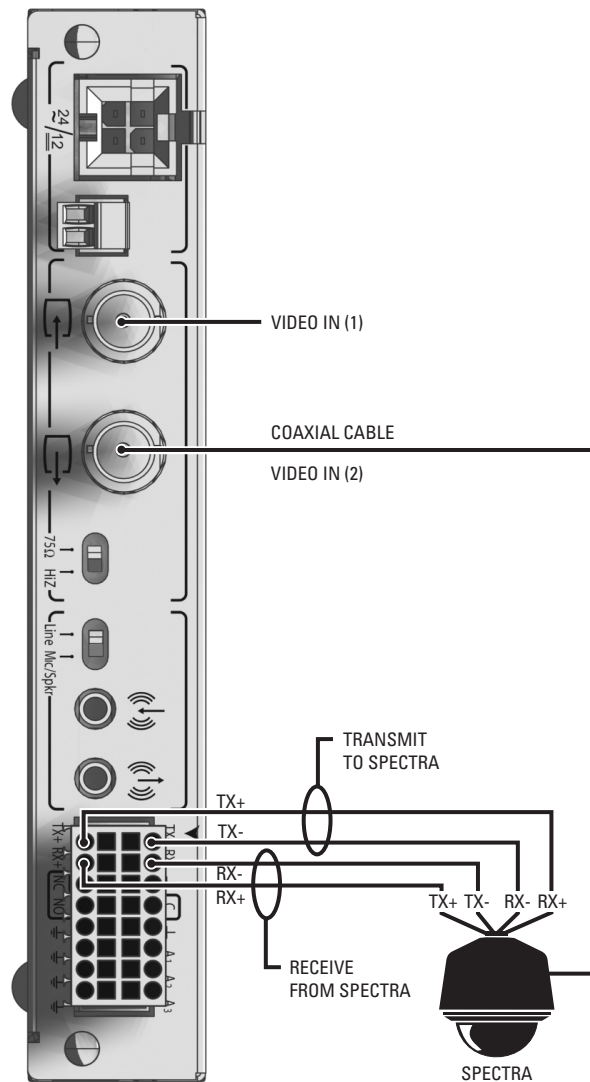

Figure 12. Connecting a Spectra Dome

Refer to Table C when installing the PTZ device. It lists the serial port settings that the SP04-140 supports.

Table C. Serial Port Options and Defaults

Setting	Options	Default
Data rate (bits per second)	110, 300, 1200, 2400, 4800, 9600, 19200, 38400, 57600, 115200, 230400	2400
Data bits	5, 6, 7, 8	8
Parity	None, Odd, Even	None
Stop bits	1, 2	1

CONNECTING A RELAY DEVICE

The SP04-140 has an output for triggering an external device. It supports both momentary and continuous relay operation.

You can operate the relay interactively, during an active connection, or automatically to coincide with certain events. Typical applications include activating a door, gate or lock, or switching on lights or other electrical devices.

⚠ WARNING: Do not exceed the maximum rating of 30 VDC, 1 A.

Figure 13 shows how to wire the relay with its power source to the video encoder (refer to Table B for the specific connector pin assignments).

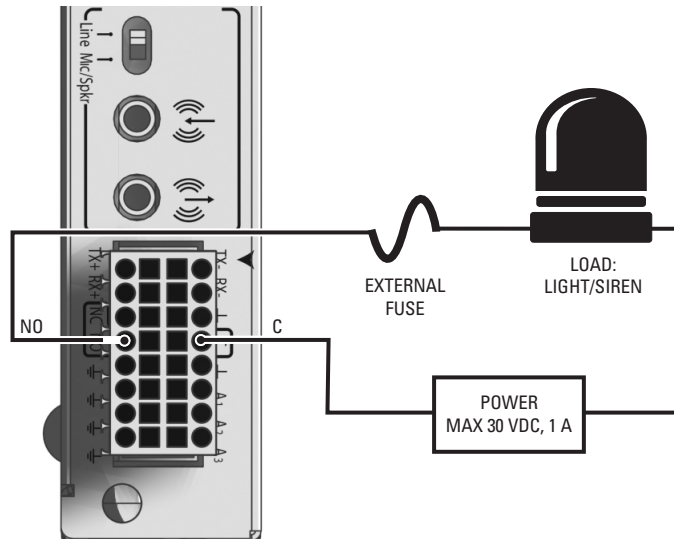

Figure 13. Connecting a Relay Device

CONNECTING ALARMS

The SP04-140 offers three alarm inputs for external signaling devices, such as door contacts or motion detectors. Each encoder supports either all normally open or all normally closed devices. If your installation requires mixed devices, install another SP04-140, NET5301T, or a NET5301R video decoder. Then connect the normally open devices to one unit and the normally closed devices to the other unit.

Once configured, an alarm input can invoke many different activities, including triggering a relay device, sending an alert to a security office, changing the video recording settings, and storing pre-alarm video to an NVR5100 Series recorder. You can connect switches or contacts directly to the unit without a separate power supply.

Each encoder supports either all supervised or all unsupervised alarms. If your installation requires mixed alarm types, install another SP04-140, NET5301T, or a NET5301R video decoder. Then connect the supervised alarm inputs to one unit and the unsupervised alarm inputs to the other unit.

Supervised Alarms

When an alarm is configured as a supervised alarm, the SP04-140 maintains a constant electrical current through the alarm circuit (3.3 VDC, 1 k Ω). If the alarm circuit length changes, due to an electrical short or a bypass, the voltage fluctuates from its normal state. Therefore, the unit triggers an alarm.

NOTE: Install the 1 k Ω resistor as close to the switch as possible.

Figure 14 illustrates the alarm and no alarm conditions of a supervised alarm input. Whether the alarm is normally closed or normally open, neither a cut nor a bypass can defeat these alarms.

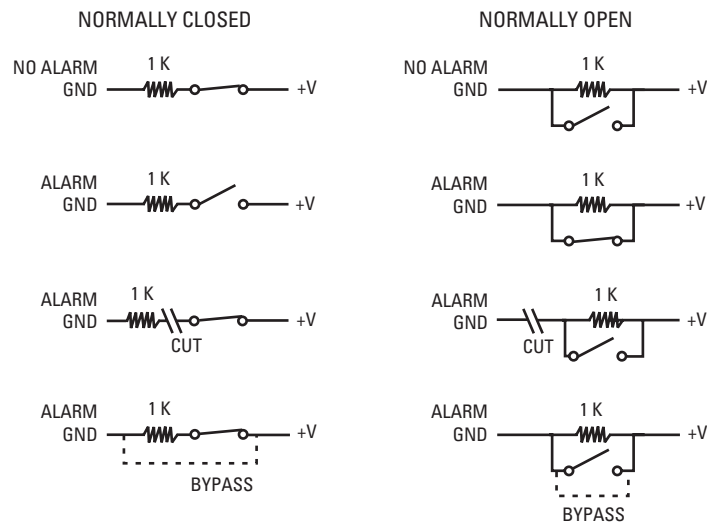

Figure 14. Supervised Alarm Conditions

Figure 15 illustrates the wiring configuration for supervised alarm inputs.

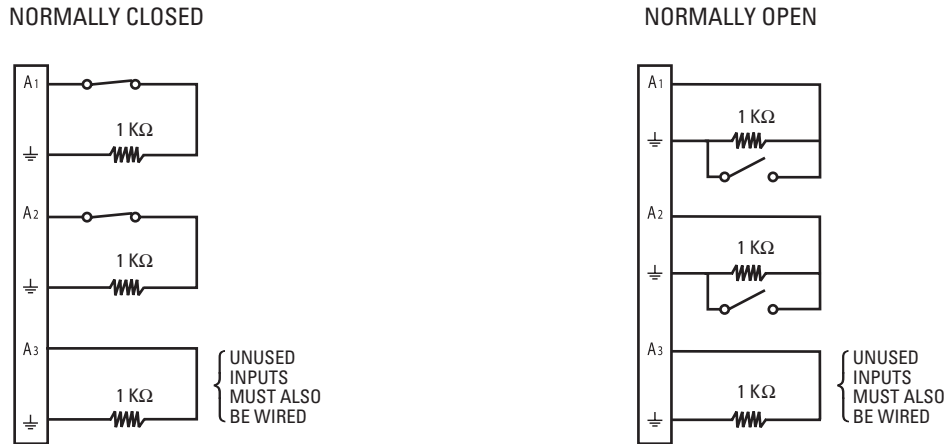

Figure 15. Supervised Alarm Input Wiring

Unsupervised Alarms

When an alarm is configured as an unsupervised alarm, the SP04-140 only triggers an alarm when the normal alarm state (open or closed) changes.

Figure 16 illustrates the alarm and no alarm conditions of an unsupervised alarm input. A normally closed alarm input can be defeated with a bypass. A normally open input can be defeated with a cut.

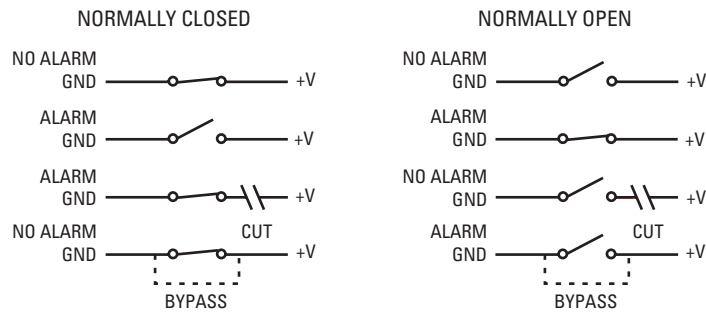

Figure 16. Unsupervised Alarm Conditions

Figure 17 illustrates the wiring configuration for unsupervised alarm inputs.

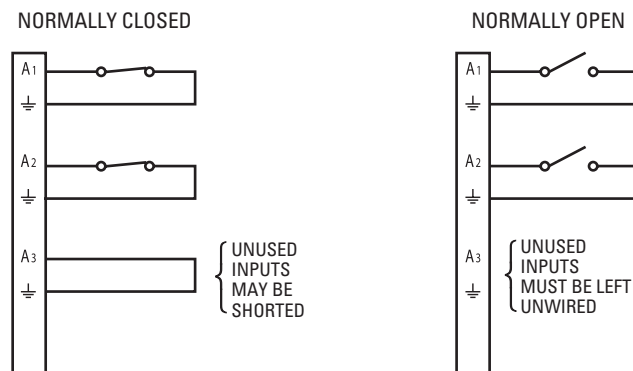

Figure 17. Unsupervised Alarm Input Wiring

Alarm Connections

Figure 18 shows how to wire the video encoder to an alarm (refer to Table B for the specific connector pin assignments).

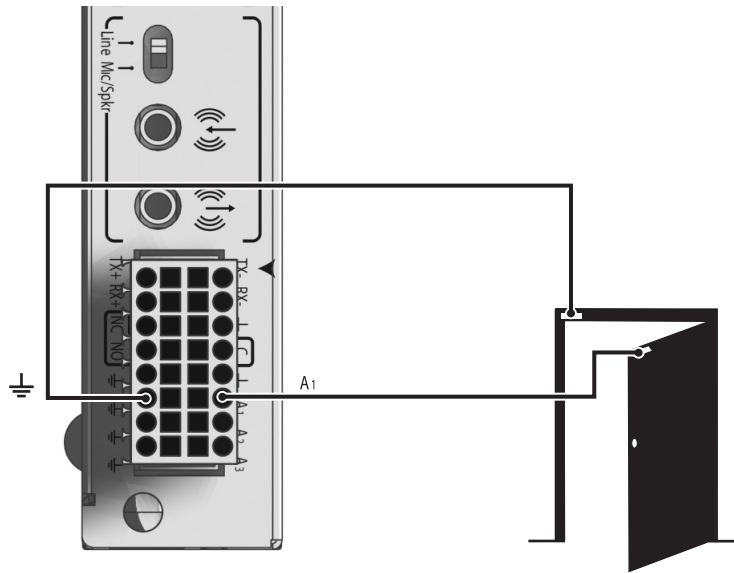

Figure 18. Connecting Alarms

CONNECTING POWER

The SP04-140 video encoder is designed to operate from either a 12 VDC or a 24 VAC power supply. It automatically senses power type and polarity (DC).

The SP04-140 can be powered from many sources:

- NET5301PS power supply connects directly to the four-pin connector on the SP04-140 rear panel.
- The RK5000PS-5U rack mount kit supplies power through the four-pin connector on the SP04-140 rear panel as soon as the unit slides into place.
- The Pelco MCS (B model), WCS (B model), and TF Series power supplies provide power through a two-pin terminal block (supplied) that plugs into the two-pin connector on the SP04-140 rear panel.
- Other UL Listed direct plug-in power units marked "Class 2" and rated for 12 VDC +10%/-15% or 24 VAC +10%/-15% provide power through a two-pin terminal block (supplied) that plugs into the two-pin connector on the SP04-140 rear panel.

The power consumption of the SP04-140 is eight watts (13.3 VA).

Use Table D to estimate your power requirements when installing multiple SP04-140, NET5301T, and NET5301R units. This table is based on a 24 VAC power supply.

Table D. Powering Multiple Units

Model	Units Powered						
	at 20 VA	at 48 VA	at 50 VA	at 100 VA	at 120 VA	at 240 VA	at 480 VA
NET5301T SP04-140	1	3	3	7	9	18	36
NET5301R	1	2	2	4	5	11	24

Use Table E to help identify the necessary wire gauge and maximum cable distance. This table applies to two-conductor solid copper wire. (Reduce distance by 10% for stranded copper wire.) These maximum distances are based on a maximum allowable voltage drop of 10%.

Table E. Recommended Wire Gauge and Maximum Wiring Distances

Wire Gauge	Maximum Distance	
	12 VDC	24 VAC
20 AWG (0.5 mm ²)	89 ft (27 m)	356 ft (108 m)
18 AWG (1.0 mm ²)	141 ft (42 m)	566 ft (172 m)
16 AWG (1.5 mm ²)	224 ft (68 m)	899 ft (274 m)
14 AWG (2.5 mm ²)	357 ft (108 m)	1,428 ft (435 m)
12 AWG (4.0 mm ²)	566 ft (172 m)	2,267 ft (690 m)
10 AWG (6.0 mm ²)	900 ft (274 m)	3,600 ft (1,097 m)

Connect power to the SP04-140. The Pelco badge (blue) and the status light (green) on the front panel should glow.

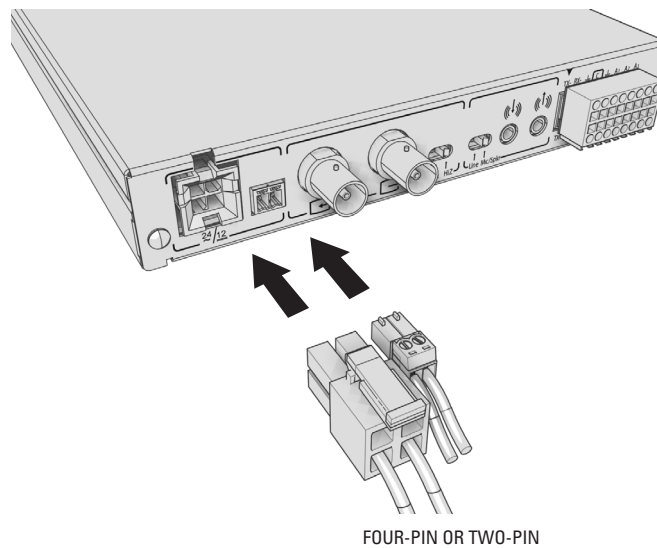



Figure 19. Connecting Power

CONNECTING TO THE NETWORK

When using one or more network switches with the Endura system, make sure you enable auto negotiation on all switches.

Connect the SP04-140 video encoder to your network:

1. Connect a 10/100/1000BaseT network Cat5e (or better) cable to the RJ-45 network connector  on the front panel. The encoder automatically searches the network for other Endura components.
2. Check the indicators on the front panel. They show network connection speed and status (refer to *Front Panel Indicators*).

Operation

Refer to the WS5000 operation manual for details on how to access and configure the SP04-140 video encoder.

FRONT PANEL INDICATORS

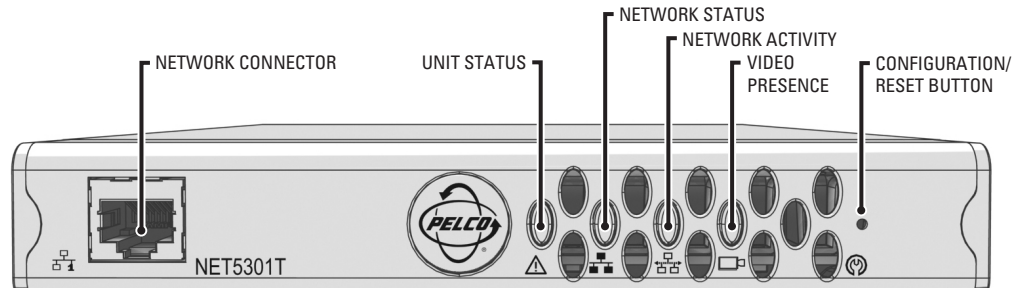

Figure 20. SP04-140 Front Panel

Pelco badge (power)

The Pelco badge glows blue when the unit has power.

Unit status

Unit status is indicated by one of the following three colors:

- Green** The unit is functioning normally.
- Amber** The unit is in configuration mode.
- Red** The unit is in an error condition.

Whenever the unit status indicator is flashing, the unit is in one of three system modes (refer to *Configuration/Reset Button*).

Network status

Network status (connection and speed) is indicated by one of the following conditions:

- Off** The unit is not connected to the network.
- Solid Amber** The unit is connected to the network using the 100BaseT standard.
- Solid Red** The unit is connected to the network using the 10BaseT standard.

NOTE: For optimum performance, Pelco recommends using the 100 BaseT standard.

Network activity

The network activity indicator flashes whenever the video encoder is sending or receiving network data.

Video presence

Video presence is indicated by one of the following conditions:

- Green** Camera video is present at the video in (2) connector, or both video in connectors.
- Red** Camera video is present at the video in (1) connector. The indicator is also red if there is no video to both video connectors.

CONFIGURATION/RESET BUTTON

Use the recessed configuration/reset button at the top of the front panel to access the following modes:

Table F. Configuration/Reset Button Functions and Indicators

Mode	Function	Unit Status Indicator Light
Configuration	Initiates system configuration.	<ul style="list-style-type: none">Flashing amber when entering this modeSolid amber when selected
Reboot	Restarts the unit.	<ul style="list-style-type: none">Flashing green when entering this modeFlashing green when selected and during restart
Reset	Resets unit to factory default settings and then restarts unit.	<ul style="list-style-type: none">Flashing red when entering this modeFlashing red when selected, then flashing green during restart
Cancel	Cancel any configuration or reset action.	<ul style="list-style-type: none">No light

To access one of these modes:

1. Use a probe or paper clip to press and hold the configuration/reset button . The unit starts cycling through the four modes (configuration, reboot, reset, and cancel), holding each mode for five seconds. The unit status indicator flashes the color for the current mode.
2. When the color of the desired mode appears, release the button.

NOTE: If there is no configuration activity for 15 minutes, the SP04-140 automatically exits configuration/reset mode.

Troubleshooting

If the following instructions fail to solve your problem, contact Pelco Product Support at 1-800-289-9100 or 1-559-292-1981 for assistance.

Access the properties windows for the SP04-140 video encoder on the WS5050 workstation (refer to the WS5000 operation manual). Then note the following before calling Pelco:

- Unit serial number: located on the Properties window and on the product label
- Unit firmware version: located on the Advanced Properties window, listed for the Encoder Device

Do not try to repair the unit yourself. Opening it immediately voids any warranty. Leave maintenance and repairs to qualified technical personnel.

Exchange the defective unit and return it for repair.

Table G. Troubleshooting the SP04-140

Problem	Possible Causes	Suggested Remedy
No video transmission	Power turned off	Check that the SP04-140 is switched on and the power indicator is lit.
	Faulty cable connections	Check all leads, plugs, contacts, and connections.
	Defective camera	Connect local monitor and check camera function.
	Defective encoder	Check camera on a different encoder.
	Network connectivity issues	Contact your network administrator.
No audio transmission to receiver	Faulty cable connection	Check all leads, plugs, contacts, and connections.
	Defective hardware	Check functioning of all connected audio devices.
	Connection in use by another receiver	Wait until the connection is free and try again.
Cannot control PTZ cameras or other devices	Faulty cable connection	Check all cable connections and ensure all plugs are properly plugged in.
	Network connectivity issues	Contact your network administrator.
	Incorrect PTZ settings	Change the camera settings on the WS5050 workstation.
	PTZ camera connected to the video in (1) connector	Connect the PTZ camera to the video in (2) connector.
The unit is not ready for operation after firmware upload	Voltage failure during programming of update file	Replace the device and have it checked by Pelco.

Specifications

MODEL NUMBER

SP04-140 Dual-input network video server that encodes video, audio, and control data for transmission over an IP network

SUPPLIED ACCESSORIES

Mating Connectors One 16-pin, one 2-pin

SYSTEM

Processor PowerPC® 405EP
Operating System Linux®
User Interface Remote operation via WS5050 or VCD5000

VIDEO/AUDIO

Video Standards NTSC/PAL/EIA/CCIR composite

Video Coding MPEG-4

Video Streams 2, simultaneous

Video Resolutions	<u>NTSC</u>	<u>PAL</u>
4CIF	704 x 480	704 x 576
2CIF	704 x 240	704 x 288
CIF	352 x 240	352 x 288
QCIF	176 x 120	176 x 144

Video Inputs/Connectors 2, BNC, 75 Ω , 1 Vp-p

Video Switch Hi-Z, 75 Ω

Audio Encoding G.711 speech codec

Audio Bit Rate 64 kbps

Audio Levels

Line In/Line Out	1 Vp-p, 10 k Ω
Microphone	5 mVp-p, approximately 40 k Ω
Speaker	2.5 Vp-p, 30 mW, minimum 16 Ω

Audio Connectors Two 3.5 mm monaural

Connector Tip Signal high (input and output)

Connector Sleeve Common

Audio Inputs Microphone or line in

Audio Outputs Speaker or line out

Audio Switch Line, microphone/speaker

PTZ CONTROL

PTZ Interface RS-422, video in

PTZ Protocols Pelco D (RS-422), Coaxitron

ALARMS/RELAYS

Alarm Inputs 3, programmable, 3.3 VDC, 1 k Ω , triggered; uses 6 of 16 pins on terminal block connector

Relay Output 1, form-C relay, 30 VDC, 1 A; uses 3 of 16 pins on terminal block connector

VIDEO ACTIVITY DETECTION

Zones	3 plus background zone
Zone Types	Any shape, user-definable in 16 x 16 pixel blocks
Sensitivity	Adjustable

AUXILIARY INTERFACES

Serial	Pelco D (RS-422); uses 4 of 16 pins on terminal block connector
Terminal Block Connector	16-pin: Pelco D (RS-422), 3 alarm inputs, 1 relay output

FRONT PANEL INDICATORS/FUNCTIONS

Network	RJ-45, 10/100 BaseT
Power	Blue
Status	Green, amber, red
Network Link/Speed	Amber, red
Network Activity	Green
Video	Green, red
Configuration/Reset	Recessed button, 4 states

POWER

Power Consumption	8 watts, 28 BTU/H
Power Input	12 VDC +10%/-15%, 24 VAC +10%/-15%
Power Connectors	
4-Pin	For RK5000PS-5U or NET5301PS
2-Pin	For user-supplied power supply

ENVIRONMENTAL

Operating Temperature	32° to 122°F (0° to 50°C)
Storage Temperature	-40° to 149°F (-40° to 65°C)
Operating Humidity	20% to 80%, noncondensing
Maximum Humidity Gradient	10% per hour
Operating Altitude	-50 ft to 10,000 ft (-16 m to 3,048 m)
Operating Vibration	0.25 G at 3 Hz to 200 Hz at a sweep rate of 0.5 octave/minute

PHYSICAL

Construction	Sheet metal
Finish	Gray metallic with black end caps, black matte finish
Dimension	8.75" (D) x 6.5" (W) x 1.2" (H) (22.2 x 16.5 x 3.0 cm)
Mounting	Desktop (feet), wall, or rack via options
Unit Weight	2.0 lb (0.9 kg)

OPTIONAL ACCESSORIES

RK5000PS-5U	Rack mount with power supply (12 units)
WM5001-4U	Wall mount without power supply (1 unit)
WM5001-4UEXP	Wall mount expansion (1 unit)
NET5301PS	Power supply (1 unit)

STANDARDS/ORGANIZATIONS

- Pelco is a member of the MPEG-4 Industry Forum
- Pelco is a member of the Universal Plug and Play (UPnP) Forum
- Pelco is a member of the Universal Serial Bus (USB) Implementers Forum
- Pelco is a contributor to the International Standards for Organization/Electrotechnical Commission (ISO/IEC) Joint Technical Committee 1 (JTC1), "Information Technology," Subcommittee 29, Working Group 11
- Compliance, ISO/IEC 14496 standard (also known as MPEG-4)
- Compliant with International Telecommunication Union (ITU) Recommendation G.711, "Pulse Code Modulation (PCM) of Voice Frequencies"
(Design and product specifications subject to change without notice.)

PRODUCT WARRANTY AND RETURN INFORMATION

WARRANTY

Pelco will repair or replace, without charge, any merchandise proved defective in material or workmanship **for a period of one year** after the date of shipment.

Exceptions to this warranty are as noted below:

- Five years on FT/FR8000 Series fiber optic products and the following fixed camera models: CC3701H-2, CC3701H-2X, CC3751H-2, CC3651H-2X, MC3651H-2, and CC3651H-2X.
- Three years on all other fixed camera models (including Camclosure® Integrated Camera Systems) and Genex® Series (multiplexers, server, and keyboard).
- Two years on all standard motorized or fixed focal length lenses.
- Two years on Legacy®, CM6700/CM6800/CM8500/CM9500/CM9700 Series Matrix, DF5 and DF8 Series Fixed Dome products.
- Two years on Spectra®, Esprit®, and PS20 Scanners, including when used in continuous motion applications.
- Two years on Esprit® and WW5700 Series window wiper (excluding wiper blades).
- Eighteen months on DX Series digital video recorders, NVR300 Series network video recorders, and all Endura™ Series distributed network-based video products.
- One year (except video heads) on video cassette recorders (VCRs). Video heads will be covered for a period of six months.
- Six months on all pan and tilts, scanners or preset lenses used in continuous motion applications (that is, preset scan, tour and auto scan modes).

Pelco will warrant all replacement parts and repairs for 90 days from the date of Pelco shipment. All goods requiring warranty repair shall be sent freight prepaid to Pelco, Clovis, California. Repairs made necessary by reason of misuse, alteration, normal wear, or accident are not covered under this warranty.

Pelco assumes no risk and shall be subject to no liability for damages or loss resulting from the specific use or application made of the Products. Pelco's liability for any claim, whether based on breach of contract, negligence, infringement of any rights of any party or product liability, relating to the Products shall not exceed the price paid by the Dealer to Pelco for such Products. In no event will Pelco be liable for any special, incidental or consequential damages (including loss of use, loss of profit and claims of third parties) however caused, whether by the negligence of Pelco or otherwise.

The above warranty provides the Dealer with specific legal rights. The Dealer may also have additional rights, which are subject to variation from state to state.

If a warranty repair is required, the Dealer must contact Pelco at (800) 289-9100 or (559) 292-1981 to obtain a Repair Authorization number (RA), and provide the following information:

1. Model and serial number
2. Date of shipment, P.O. number, Sales Order number, or Pelco invoice number
3. Details of the defect or problem

If there is a dispute regarding the warranty of a product which does not fall under the warranty conditions stated above, please include a written explanation with the product when returned.

Method of return shipment shall be the same or equal to the method by which the item was received by Pelco.

RETURNS

In order to expedite parts returned to the factory for repair or credit, please call the factory at (800) 289-9100 or (559) 292-1981 to obtain an authorization number (CA number if returned for credit, and RA number if returned for repair).

All merchandise returned for credit may be subject to a 20% restocking and refurbishing charge.

Goods returned for repair or credit should be clearly identified with the assigned CA or RA number and freight should be prepaid. Ship to the appropriate address below.

If you are located within the continental U.S., Alaska, Hawaii or Puerto Rico, send goods to:

Service Department
Pelco
3500 Pelco Way
Clovis, CA 93612-5699

If you are located outside the continental U.S., Alaska, Hawaii or Puerto Rico and are instructed to return goods to the USA, you may do one of the following:

If the goods are to be sent by a COURIER SERVICE, send the goods to:

Pelco
3500 Pelco Way
Clovis, CA 93612-5699 USA

If the goods are to be sent by a FREIGHT FORWARDER, send the goods to:

Pelco c/o Expeditors
473 Eccles Avenue
South San Francisco, CA 94080 USA
Phone: 650-737-1700
Fax: 650-737-0933

REVISION HISTORY

Manual #	Date	Comments
C613M	12/04	Original version.
C613M-A	5/05	New labeling and specifications. General minor modifications.

Pelco, the Pelco logo, Spectra, Genex, Esprit, Camclosure, Coaxitron, and Legacy are registered trademarks of Pelco.
Endura is a trademark of Pelco.
PowerPC is a registered trademark of International Business Machines Corporation.
Linux is a registered trademark of Linus Torvalds.

© Copyright 2005, Pelco. All rights reserved.



Worldwide Headquarters
3500 Pelco Way
Clovis, California 93612 USA

USA & Canada
Tel: 800/289-9100
Fax: 800/289-9150

International
Tel: 1-559/292-1981
Fax: 1-559/348-1120

www.pelco.com

ISO9001

United States | Canada | United Kingdom | The Netherlands | Singapore | Spain | Scandinavia | France | Middle East

Free Manuals Download Website

<http://myh66.com>

<http://usermanuals.us>

<http://www.somanuals.com>

<http://www.4manuals.cc>

<http://www.manual-lib.com>

<http://www.404manual.com>

<http://www.luxmanual.com>

<http://aubethermostatmanual.com>

Golf course search by state

<http://golfingnear.com>

Email search by domain

<http://emailbydomain.com>

Auto manuals search

<http://auto.somanuals.com>

TV manuals search

<http://tv.somanuals.com>