



DX9100 Digital Video Recorder & DX9100 Viewstation



C636M-E (4/05)

CONTENTS

Section	Page
IMPORTANT SAFETY INSTRUCTIONS	7
REGULATORY NOTICES	8
DESCRIPTION	9
MODELS	10
FRONT VIEW (RECORDER)	11
BACK VIEW (RECORDER)	12
FRONT VIEW (VIEWSTATION)	13
BACK VIEW (VIEWSTATION)	14
INSTALLATION	15
INSTALLATION GUIDELINES	16
MOUNTING	17
CONNECTIONS	19
WIRING ALARMS AND RELAYS	21
POWER UP THE EQUIPMENT	22
PROGRAMMING	23
VIEWSTATION NETWORK CONFIGURATION	23
CHANGING THE VIEWSTATION'S IDENTIFICATION	24
CHANGING THE VIEWSTATION'S IP ADDRESS AND SUBNET MASK	25
CHANGING THE RECORDER'S IDENTIFICATION	27
TIME SYNCHRONIZATION	28
SETTING DATE/TIME PROPERTIES	29
CLIENT CONFIGURATION UTILITY	30
RECORDER INITIALIZATION OPTIONS	32
SERVER STATE	34
DATABASE BACKUP AND REPAIR	36
ADVANCED RECORDER OPTIONS	36
DATABASE RESTORATION	37
CONFIGURING STANDARD ALARM AND RELAY PROPERTIES	46
CAMERA RECORDING PROPERTIES	47
CONTINUOUS RECORDING SCHEDULE	49
DAILY RECORDING SCHEDULE	49
WEEKLY RECORDING SCHEDULE	51
MOTION DETECTION	52
CHANNEL SETUP	53
DEFINING USERS	55
EDIT EXISTING USERS	56
ADDING A NEW USER	56
DELETING A USER	56
ADVANCED FEATURES	57
I/O INTERFACE	57
I/O HANDLER	57
I/O MANAGER	57
CONNECTING AN ALARM UNIT	58
ALARM UNIT CONFIGURATION	59
I/O MANAGER FOR ALARM UNIT	61
CONNECTING A RELAY UNIT	64
RELAY UNIT CONFIGURATION	65
I/O MANAGER FOR RELAY UNIT	67
CONNECTING A CM9760-CC1	69
CONNECTING A CM6800	70
DATA TRANSLATOR CONFIGURATION	71
I/O MANAGER FOR DATA TRANSLATOR	73
DVR MANAGEMENT	75

DATA TRANSLATOR CONNECTIONS	75
CONFIGURING THE DATA TRANSLATOR	76
RELAY UNIT CONNECTIONS	78
CONFIGURING THE RELAY UNIT	79
FOREIGN LANGUAGE PROGRAMMING	81
SPECIFICATIONS	83
WARRANTY AND RETURN INFORMATION	84

LIST OF ILLUSTRATIONS

Figure	Page
1. DX9100 System Overview	9
2. Front View of Recorder	11
3. Back View of Recorder	12
4. Front View of Viewstation	13
5. Back View of Viewstation	14
6. DX9100 Rack Mount Installation	18
7. Hasp Key Message	19
8. System Connections	20
9. Alarm and Relay Wiring	21
10. Viewstation Network Identification Page	24
11. Viewstation Identification Changes Dialog Box	24
12. Viewstation Network Connections Window	25
13. Viewstation Local Area Connection Status Dialog Box	25
14. Viewstation Local Area Connection Properties Dialog Box	26
15. Viewstation Internet Protocol (TCP/IP) Properties Dialog Box	26
16. Server Configuration Utility Dialog Box	27
17. Server Identification Dialog Box	27
18. Date & Time Page	29
19. Time Zone Page	29
20. Client Configuration Login Dialog Box	30
21. Client Configuration Utility	30
22. Export to Server Dialog Box	31
23. DX9116H Frame Rate and Resolution	32
24. DX9116F Frame Rate and Resolution	32
25. License Information Dialog Box	32
26. Server State	34
27. Configuration Options	34
28. Error Alert	34
29. Advanced Options	36
30. Database Backup and Repair Confirmation	36
31. System Tray	37
32. Server Service Manager Window	37
33. Stop SQL Dialog Box 1	37
34. Stop SQL Dialog Box 2	37
35. Start/Continue Window	38
36. My Computer Window	38
37. Databases Window	39
38. Rename MSSQL	39
39. C Drive Databases Window	40
40. MSSQL Folders	40
41. Start/Continue Window	41
42. Database Backups Window	41
43. Explorer Windows	42
44. Restore Utility Dialog Box	42
45. System Tray	42
46. Server Service Manager Window	43
47. Stop SQL Dialog Box 1	43
48. Stop SQL Dialog Box 2	43
49. Start/Continue Window	43
50. Replace Database Dialog Box	44
51. Restore Confirmation Dialog Box	44
52. Operation Completed Dialog Box	44
53. Maintenance Dialog Box	44
54. Finished Scan Dialog Box	45
55. Finished Merging Dialog Box	45

56.	I/O Ports Driver Dialog Box	46
57.	Alarm Modes/Relay Intervals Dialog Box	46
58.	Camera Properties Dialog Box	47
59.	Select Channel Dialog Box	48
60.	Continuous Recording Schedule Page	48
61.	Continuous Daily Recording Schedule Page	49
62.	Daily Event Recording Page	50
63.	Continuous Weekly Recording Schedule Page	51
64.	Weekly Event Recording Schedule Page	51
65.	Motion Detection Page	52
66.	Camera Video Setup Page	53
67.	User Access Dialog Box	55
68.	User Manager Dialog Box	55
69.	Connecting a CM9760-ALM	58
70.	Alarm I/O Handler Configuration Dialog Box	59
71.	CM9760 Alarm Driver Dialog Box	59
72.	Device 2 Alarm Driver Dialog Box	60
73.	CM9760 Alarm Configuration Dialog Box	60
74.	Dialog Box to Configure External 1 Source	61
75.	Sample Configuration for External 1 Source	62
76.	Dialog Box to Configure External 2 Source	63
77.	Connecting a CM9760-REL	64
78.	Relay I/O Handler Dialog Box	65
79.	CM9760 Relay Driver Dialog Box	65
80.	Device 1 Relay Driver Dialog Box	66
81.	CM9760 Relay Configuration Dialog Box	66
82.	Relay Unit Step 3 Screen	67
83.	Dialog Box to Configure Relay Event Type	69
84.	Connecting a CM9760-CC1	69
85.	Connecting a CM6800	70
86.	Data Translator I/O Handler Configuration Dialog Box	71
87.	CM9760 Data Translator Driver Dialog Box	71
88.	Device 1 Data Translator Driver Dialog Box	72
89.	CM9760 Relay Configuration Dialog Box	72
90.	Dialog Box to Configure Data Translator	73
91.	Dialog Box to Configure Data Translator Event Type	74
92.	Connecting a CM9760-DT for DVR Management	75
93.	Data Translator Configuration Dialog Box	76
94.	Data Translator Driver Dialog Box	76
95.	Data Translator Driver Settings Dialog Box	76
96.	CM9760-DT Configuration	77
97.	Connecting a CM9760-REL for DVR Management	78
98.	Relay Unit Configuration Dialog Box	79
99.	Relay Unit Driver Dialog Box	79
100.	Relay Unit Driver Settings Dialog Box	79
101.	CM9760-REL Configuration Dialog Box	80
102.	Change System Location	81
103.	Select System Location	82

LIST OF TABLES

Table		Page
A.	Server State Symbols	34
B.	Channel Setup	54
C.	User Access Rights	56

IMPORTANT SAFETY INSTRUCTIONS

1. Read these instructions.
2. Keep these instructions.
3. Heed all warnings.
4. Follow all instructions.
5. Do not use this apparatus near water.
6. Clean only with dry cloth.
7. Do not block any ventilation openings. Install in accordance with the manufacturer's instructions.
8. Do not install near any heat sources such as radiators, heat registers, stoves, or other apparatus (including amplifiers) that produce heat.
9. Do not defeat the safety purpose of the polarized or grounding-type plug. A polarized plug has two blades with one wider than the other. A grounding plug has two blades and a third grounding prong. The wide blade or the third prong are provided for your safety. If the provided plug does not fit into your outlet consult an electrician for replacement of the obsolete outlet.
10. Protect the power cord from being walked on or pinched particularly at plugs, convenience receptacles, and the points where they exit from the apparatus.
11. Only use attachments/accessories specified by the manufacturer.
12. Use only with the cart, stand, tripod, bracket, or table specified by the manufacturer, or sold with the apparatus. When a cart is used, use caution when moving the cart/apparatus combination to avoid injury from tip-over.
13. Refer all servicing to qualified service personnel. Servicing is required when the apparatus has been damaged in any way, such as power-supply cord or plug is damaged, liquid has been spilled or objects have fallen into the apparatus, the apparatus has been exposed to rain or moisture, does not operate normally, or has been dropped.
14. Apparatus shall not be exposed to dripping or splashing and that no objects filled with liquids, such as vases shall be placed on the apparatus.
15. **WARNING:** To reduce the risk of fire or electric shock, do not expose this apparatus to rain or moisture.
16. Installation should be done only by qualified personnel and conform to all local codes.
17. Use only installation methods and materials capable of supporting four times the maximum specified load.

The socket-outlet shall be installed near the equipment and shall be easily accessible.

CAUTION: These servicing instructions are for use by qualified service personnel only. To reduce the risk of electric shock do not perform any servicing other than that contained in the operating instructions unless you are qualified to do so.

CAUTION: Danger of explosion if battery is incorrectly replaced. Replace only with the same or equivalent type. Dispose of used batteries according to the instructions provided by the battery manufacturer.

Only use replacement parts recommended by Pelco.

REGULATORY NOTICES

DX9100DVR Series

This device complies with part 15 of the FCC Rules. Operation is subject to the following two conditions: (1) this device may not cause harmful interference, and (2) this device must accept any interference received, including interference that may cause undesired operation.

RADIO AND TELEVISION INTERFERENCE

This equipment has been tested and found to comply with the limits of a Class B digital device, pursuant to part 15 of the FCC rules. These limits are designed to provide reasonable protection against harmful interference when the equipment is operated in a commercial environment. This equipment generates, uses, and can radiate radio frequency energy and, if not installed and used in accordance with the instruction manual, may cause harmful interference to radio communications. Operation of this equipment in a residential area is likely to cause harmful interference in which case the user will be required to correct the interference at his own expense.

In order to maintain compliance with FCC regulations shielded cables must be used with this equipment. Operation with non-approved equipment or unshielded cables is likely to result in interference to radio and television reception.

DX9100VSR

This device complies with Part 15 of the FCC Rules. Operation is subject to the following two conditions: (1) this device may not cause harmful interference, and (2) this device must accept any interference received, including interference that may cause undesired operation.

RADIO AND TELEVISION INTERFERENCE

This equipment has been tested and found to comply with the limits of a Class A digital device, pursuant to Part 15 of the FCC Rules. These limits are designed to provide reasonable protection against harmful interference when the equipment is operated in a commercial environment. This equipment generates, uses, and can radiate radio frequency energy and, if not installed and used in accordance with the instruction manual, may cause harmful interference to radio communications. Operation of this equipment in a residential area is likely to cause harmful interference in which case the user will be required to correct the interference at his own expense.

Changes and modifications not expressly approved by the manufacturer or registrant of this equipment can void your authority to operate this equipment under Federal Communications Commission's rules.

This Class A digital apparatus complies with Canadian ICES-003.

Cet appareil numérique de la classe A est conforme à la norme NMB-003 du Canada.

DESCRIPTION

The DX9100 system consists of at least one digital video recorder (DVR) and one viewstation.

The DX9100 digital video recorder has these features:

- 16 video inputs
- Internal hard disk storage drive
- Compatibility with existing DX9000 recorders with C1.1 software
- Compatibility with DX9100VS viewstations
- 16 alarm inputs and 2 relay outputs
- USB connectors

Thousands of cameras can be recorded and viewed at the same time when multiple DX9100 recorders and DX9100 viewstations are linked to each other through a local area network (LAN) or wide area network (WAN).

The DX9100VS viewstation has these features:

- Simultaneous viewing of live or recorded video can be seen from as many as four cameras.
- Live video can be marked for later review by the user or by using the motion detection feature.
- Scan feature allows the user to search recorded video for movement of a specific object.
- Video files can be saved in MPEG format to a compact disk, hard drive, or anywhere on the network.
- A current video frame can be printed on a standard PC printer.

IMPORTANT NOTE. PLEASE READ. The network implementations in this document are shown as general representations only and are not intended to show detailed network topologies. Your actual network will differ, requiring changes or perhaps additional network equipment to accommodate the systems as illustrated. Please contact your local Pelco Representative to discuss your specific requirements.

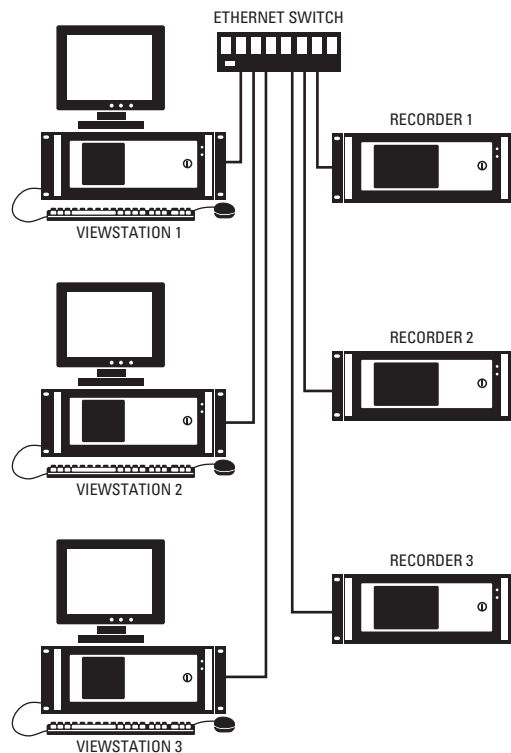

Figure 1. DX9100 System Overview

MODELS

DX9100VSR	Viewstation; rack mountable
DX9116H-500	Digital video recorder; records at 7.5 or 15 images per second (ips) at CIF resolution; 500 GB internal storage
DX9116H-750	Same as the DX9116H-500 except has 750 GB internal storage
DX9116H-1000	Same as the DX9116H-500 except has 1,000 GB internal storage
DX9116H-1250	Same as the DX9116H-500 except has 1,250 GB internal storage
DX9116H-1500	Same as the DX9116H-500 except has 1,500 GB internal storage
DX9116F-500	Digital video recorder; records at 7.5, 15, or 30 ips at CIF resolution or at 7.5 or 15 ips at 2CIF resolution; 500 GB internal storage
DX9116F-750	Same as the DX9116F-500 except has 750 GB internal storage
DX9116F-1000	Same as the DX9116F-500 except has 1,000 GB internal storage
DX9116F-1250	Same as the DX9116F-500 except has 1,250 GB internal storage
DX9116F-1500	Same as the DX9116F-500 except has 1,500 GB internal storage

FRONT VIEW (RECORDER)

- ❶ Power LED
- ❷ HDD (Hard Disk Drive) LED
- ❸ Handle (2)
- ❹ Rack Ear (2)
- ❺ Fan Ventilation
- ❻ Lock (2 Keys Supplied)
- ❼ Power Button
- ❽ Fan (2)

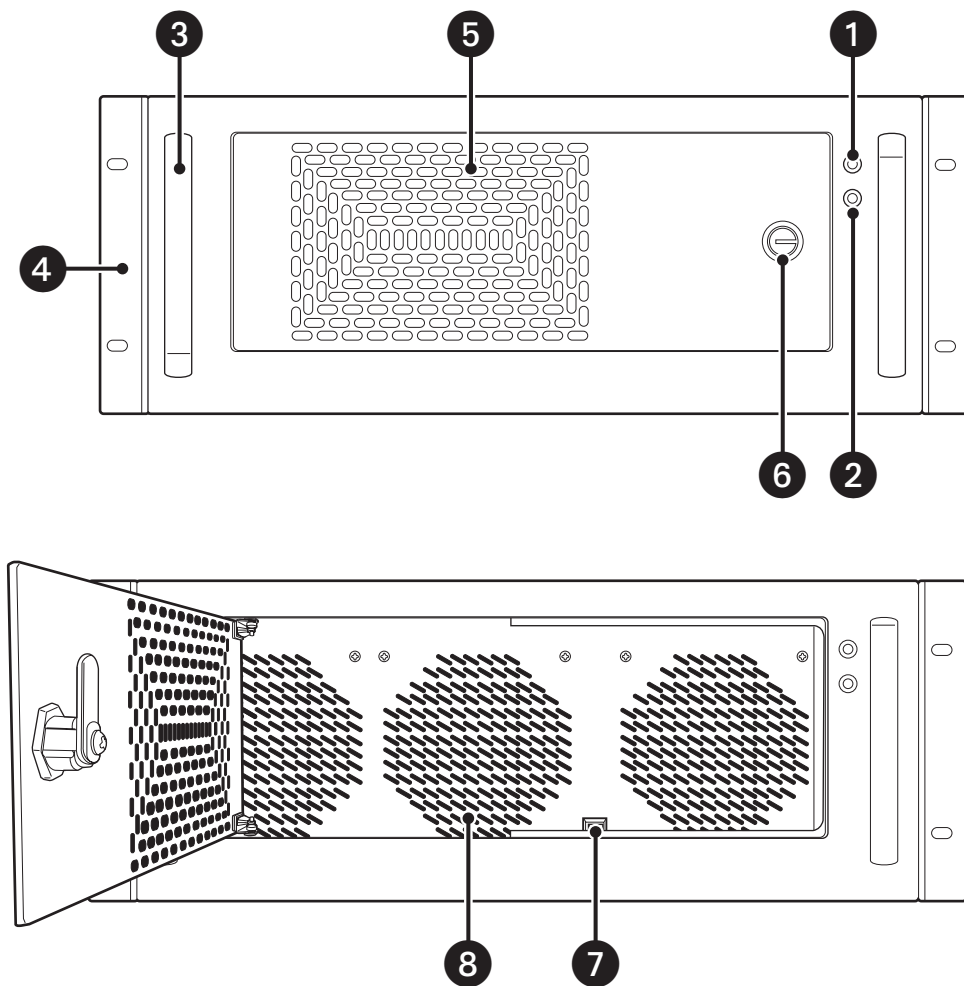

Figure 2. Front View of Recorder

BACK VIEW (RECORDER)

- ❶ Video Looping Output Coaxial Connector (16)
- ❷ Video Input Coaxial Connector (16)
- ❸ Video Termination Switch (4)
- ❹ Alarm Inputs (16) and Relay Outputs (2)
- ❺ Audio Inputs (Reserved for Future Use)
- ❻ RJ-45 Network Connector
- ❼ USB Port for HASP USB Key
- ❽ VGA Connector
- ❾ RS-232 Connector
- ❿ Parallel Port (Not Used)
- ⓫ PS/2 Connectors (Keyboard/Mouse)
- ⓬ Power Input (100-240 VAC)

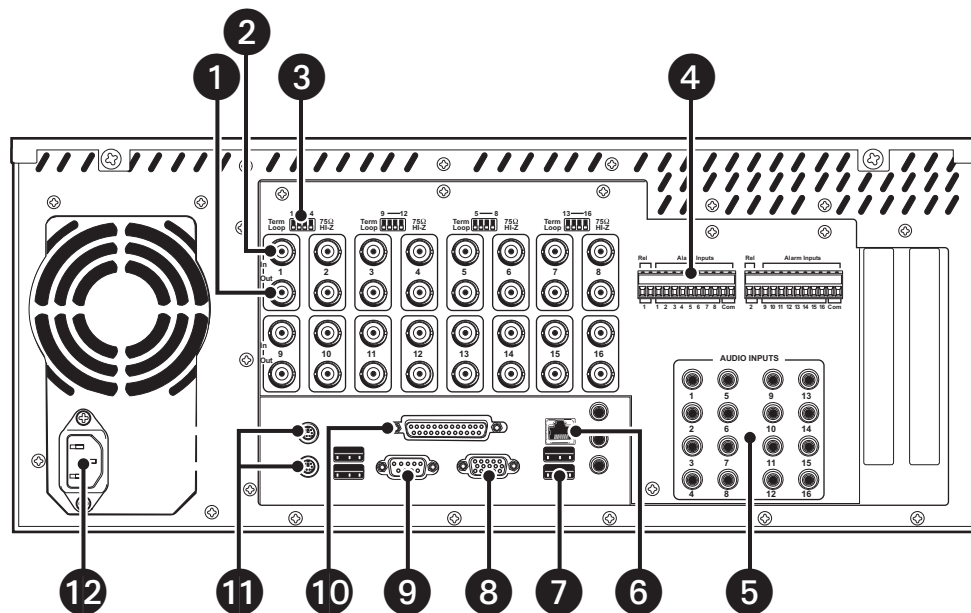

Figure 3. Back View of Recorder

FRONT VIEW (VIEWSTATION)

- ① Power LED
- ② HDD (Hard Disk Drive) LED
- ③ Key Lock (2 Keys Supplied)
- ④ Fan Ventilation
- ⑤ Handles
- ⑥ Rack Ears
- ⑦ Fan
- ⑧ Power Button
- ⑨ DVD-RW/CD-RW
- ⑩ 3.5-Inch Floppy Drive

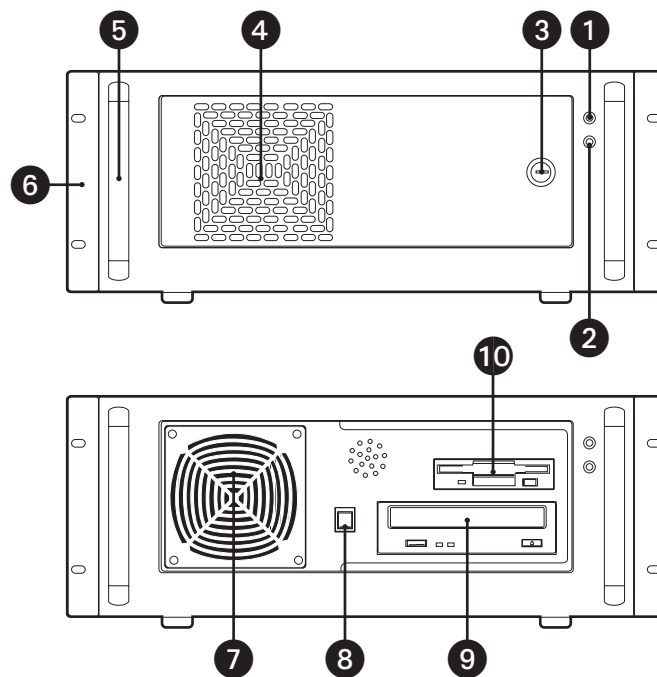

Figure 4. Front View of Viewstation

BACK VIEW (VIEWSTATION)

- ❶ Power Input (100-240 VAC)
- ❷ PS/2 Connectors (Keyboard/Mouse)
- ❸ Secondary RJ-45 Network Connector
- ❹ USB Ports
- ❺ RS-232 Connector (COM 1)
- ❻ Parallel Port
- ❼ Primary RJ-45 Network Connector
- ❽ Audio Inputs (Line In, Line Out/Headphone, Microphone In)
- ❾ VGA Connectors
- ❿ Modem Connectors
- ⓫ RS-232 Connector (COM 2)

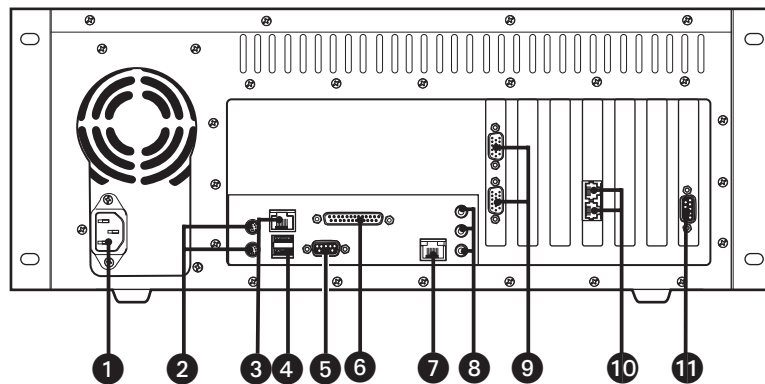

Figure 5. Back View of Viewstation

INSTALLATION

Make sure all parts are present for each unit.

Recorder

- 1 Recorder
- 2 Power cords (1 USA standard and 1 European standard)
- 2 Brackets
 - 6 Screws, 8-32 x .250-inch, pan head
- 2 Rack ears
 - 4 Screws, 10-32 x .250-inch, flat head
 - 4 Screws, 10-32 x .750-inch, Phillips, pan head with washers
- 2 Rear mounting rails
 - 8 Screws, 10-32 x .375-inch, flat head
- 2 Front mounting rails
 - 6 Screws, 8-32 x .375-inch, pan head with washers
 - 4 Screws, 10-32 x .375-inch, flat head
- 2 Keys
 - 1 Windows® 2000 license label (on unit)
 - 1 pcAnywhere™ package
 - 1 Resource CD
 - 1 USB HASP key

Viewstation

- 1 Viewstation
- 2 Power cords (1 USA standard and 1 European standard)
- 1 PS/2 keyboard
- 1 PS/2 mouse
- 1 Analog video output adapter cable
- 1 Modem cable
- 2 Brackets
 - 6 Screws, 8-32 x .250-inch, pan head
- 2 Rack ears
 - 4 Screws, 10-32 x .250-inch, flat head
 - 4 Screws, 10-32 x .750-inch, Phillips, pan head with washers
- 2 Rear mounting rails
 - 8 Screws, 10-32 x .375-inch, flat head
- 2 Front mounting rails
 - 6 Screws, 8-32 x .375-inch, pan head with washers
 - 4 Screws, 10-32 x .375-inch, flat head
- 2 Keys
 - 1 Windows 2000 license label (on unit)
 - 1 pcAnywhere package
 - 1 Resource CD

INSTALLATION GUIDELINES

Follow these guidelines for the best system performance.

- The DX9100 recorders require connection to an uninterruptible power supply (UPS) to ensure no corruption of data during a power loss.
- The DX9100 system must be installed in a climate-controlled room. The temperature range should be 41° to 85°F (5° to 29°C).
- All network devices that will transport DX9100 video must be capable of moving multicast traffic.
- Pelco recommends that the DX9100 recorder be installed in a ventilated rack enclosure.
- When securing the recorder to the rack enclosure, do not lift the recorder by the handles only.
- Make sure the rack enclosure is properly grounded.
- Pelco recommends that a spare phone line be installed and connected to a primary DX9100 viewstation to allow the Pelco Technical Support Group to dial into the site upon customer request. Pelco personnel will not make changes unless authorized by the customer. This phone line can be protected by a password to prevent unauthorized access.

Lack of adherence to these guidelines gives Pelco discretion in honoring product warranty.

MOUNTING

The DX9100 recorder and viewstation are supplied with the necessary parts for mounting into an industry standard 19-inch (48.26 cm) wide equipment rack. The units can also be placed on a flat surface, such as a shelf.



CAUTION: The units should be installed in an air-conditioned room where the temperature is maintained between 41° and 86°F (5° and 29°C). Allow one rack unit (1.75 inches or 4.5 cm) of space between each unit on the rack for air circulation.

To install the unit into an equipment rack:

1. Attach the two brackets to both sides of the unit.
2. Attach the mounting rails to the equipment rack.
3. Place the unit onto the mounting rails. It should slide in and out of the rack easily.
4. Fasten the rack ears to the equipment rack.

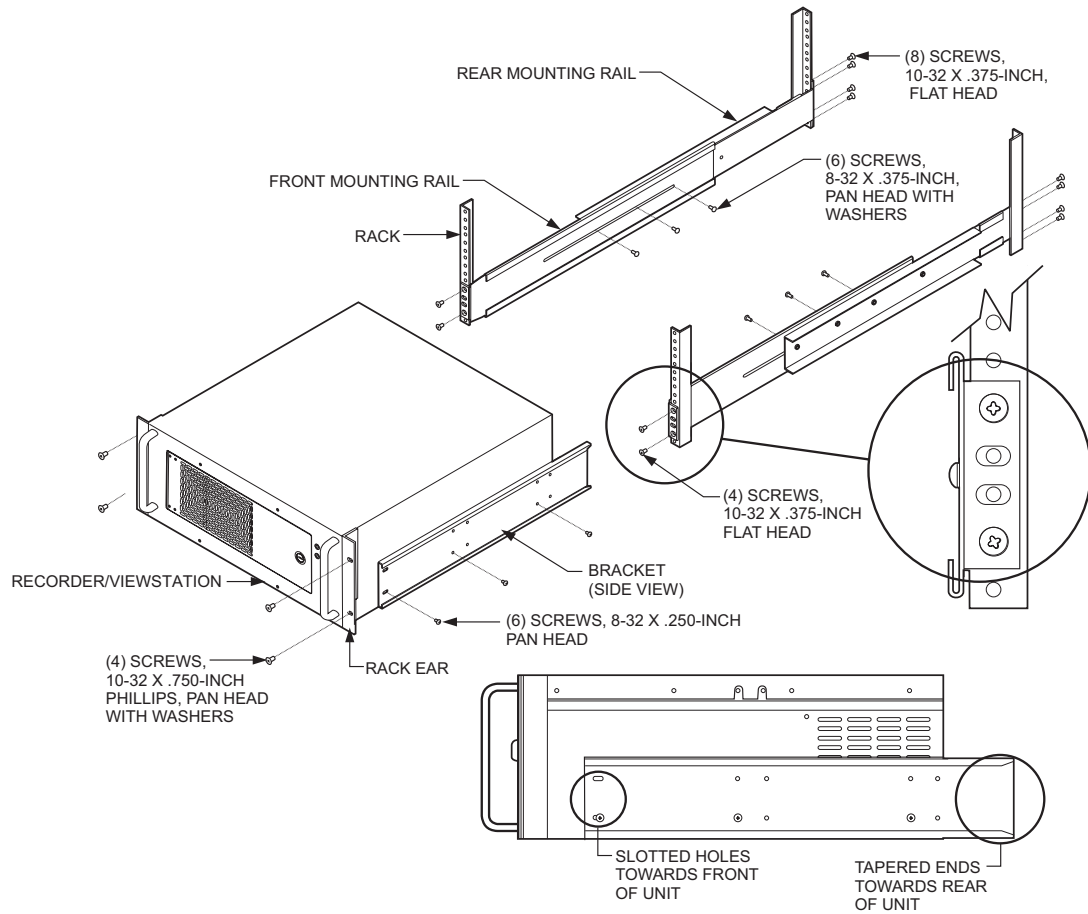

Figure 6. DX9100 Rack Mount Installation

CONNECTIONS

Refer to Figure 8.

1. Connect the viewstation to the recorder via an Ethernet switch. Use shielded network cables.

NOTE: Use a shielded cable, similar to Belden 1533P, that meets or exceeds the support requirements for ANSI/TIA/EIA 568B.2 Cat 5e.

2. Connect a monitor, keyboard, and mouse to the viewstation.
3. Connect cameras to the video input coaxial connectors on the recorders, and then set the termination switches to Term (75 ohms). This is the factory default.
4. Connect looping video sources, such as monitors, to the video output coaxial connectors on the recorder and then set the switches to Loop (HI-Z). You can then terminate at the final devices.
5. Connect a CM9760-REL, CM9760-ALM, or CM9760-DT to the RS-232 COM port. Refer to the *Advanced Features* section.
6. Wire alarms and relays. Refer to the *Wiring Alarms and Relays* section.
7. Plug the HASP (Hardware Against Software Piracy) USB key into the bottom right USB port on the recorder. A red light on the key indicates that it is working properly. The key contains the product license and its configured permissions. The following message appears if you do not plug in the HASP key:

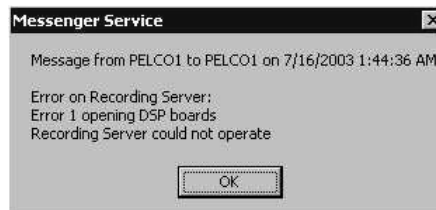

Figure 7. Hasp Key Message

8. Connect a monitor, keyboard, and mouse to the recorder. You can remove them after setup is complete.
9. Connect all power cords.

NOTE: The audio inputs on the rear of the recorder are reserved for future use.

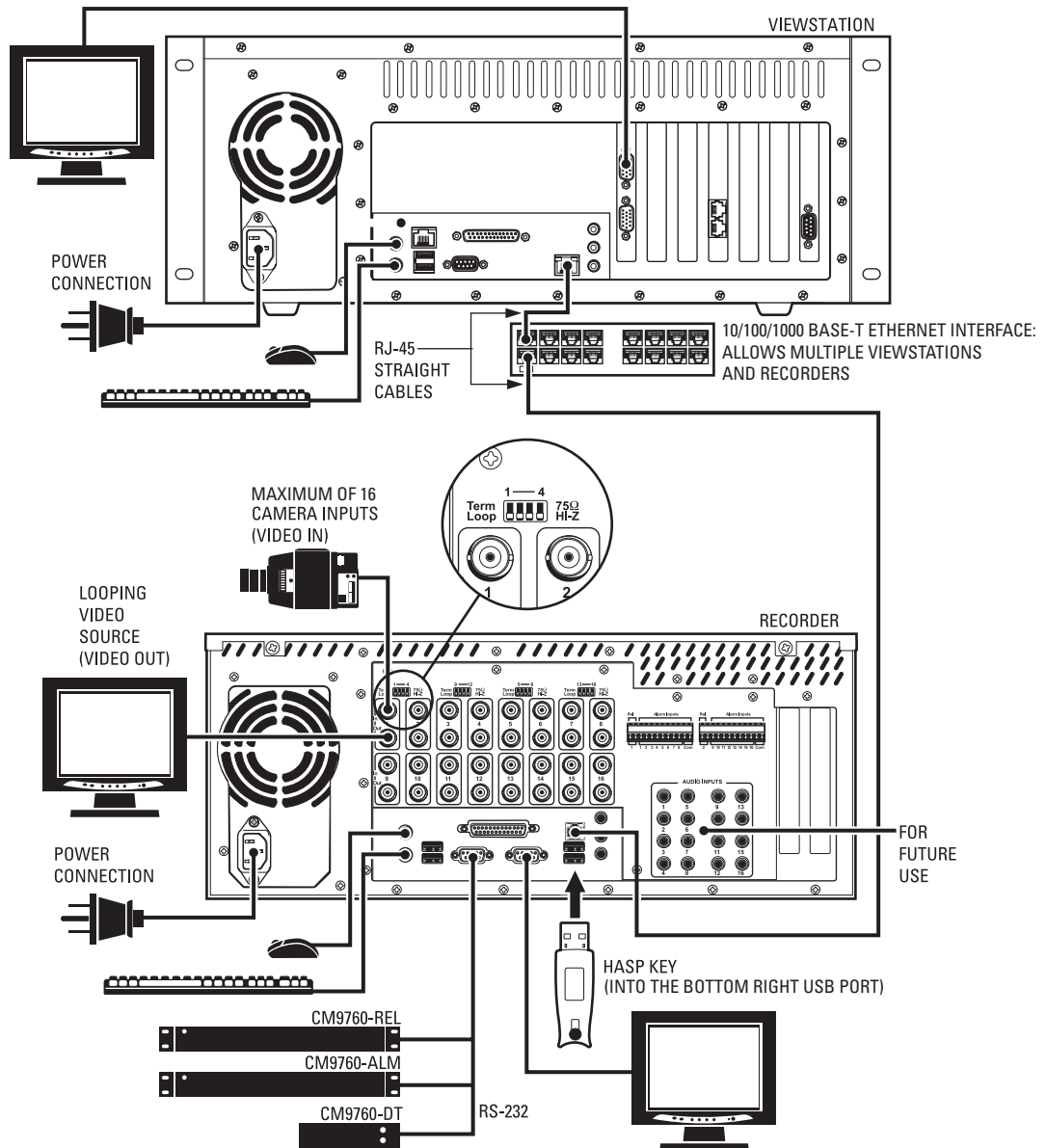

Figure 8. System Connections

WIRING ALARMS AND RELAYS

The DX9100 provides 16 alarm inputs and two relay outputs. Each alarm input and relay output can be matched to a video input. For example, alarm input 5 can match video input 3 and relay 1.

You can connect wires from the sensors to the respective alarm inputs on the connectors on the back panel of the DX9100. Each sensor requires two wires. Follow the example below.

1. Connect a wire from Alarm 1 to alarm input 1.
2. Connect a wire from Alarm 1 to one of the Com terminals.
3. Connect a wire from Alarm 2 to alarm input 2.
4. Connect a wire from Alarm 2 to one of the Com terminals.
5. Connect wires to relay output 1.

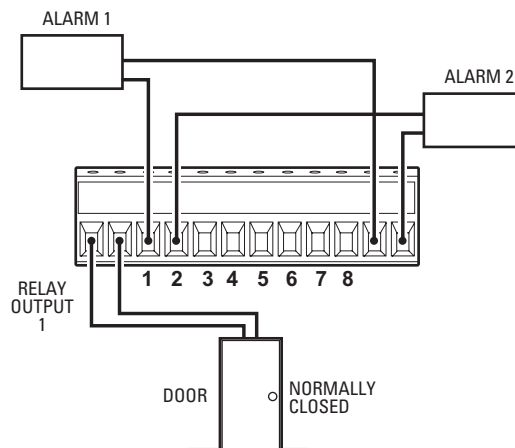
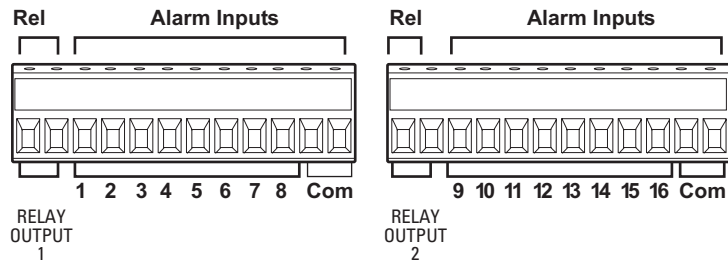

Figure 9. Alarm and Relay Wiring

Alarm sensors can be either N.O. (normally open) or N.C. (normally closed) contacts. The DX9100 is set to normally open as a factory default. To change the default to normally closed, refer to the *Configuring Standard Alarms and Relay Properties* section.

POWER UP THE EQUIPMENT

After you make all of the connections, turn on the recorder first and then the viewstation. The recorder applications start automatically. There are four applications that should be running in order for the recorder to work:

- SQL Server Service Manager (🔌 appears in system tray)
- Server Attendant
- Recording Server
- Time Synchronizer (🕒 appears in system tray)

NOTE: The Time Synchronizer icon should also appear in the viewstation's system tray to ensure that the recorder and viewstation have the same time.

The pcAnywhere™ application is preinstalled on all recorders and viewstations. You can use this application to access remote recorders or viewstations.

VIEWSTATION NETWORK CONFIGURATION

After you make all connections, you have to configure the viewstation to work on the network. To configure the viewstation, you need the following information. You can obtain this information from your network administrator.

- Unique viewstation name: (Examples are Pelcovs1, Pelcovs2, Pelcovs3, etc. This is the default naming scheme.)
- Unique IP address: (Examples are 100.0.0.201, 100.0.0.202, 100.0.0.203, etc. This is the default addressing scheme.) Each viewstation is identified by a logical IP address over a local area network (LAN). Each requires a unique IP address for communication using TCP/IP protocol. The IP address identifies a system's location on the network and must be globally unique and have a uniform format.
- Network subnet mask: This must be the same on all recorders and viewstations. (For example, 255.0.0.0 is the default.)
- Computer workgroup name: This must be the same on all recorders and viewstations. (For example, DX9000_GROUP is the default.)

CHANGING THE VIEWSTATION'S IDENTIFICATION

To change the default computer name or workgroup:

1. Close all windows on the viewstation desktop.
2. Right-click My Computer and then go to Properties.
3. Click the Network Identification tab. The following page appears.

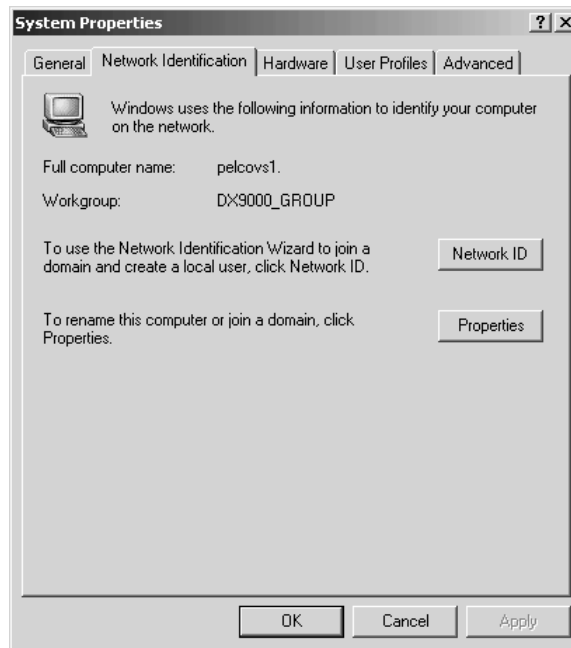

Figure 10. Viewstation Network Identification Page

4. Click Properties. The following dialog box appears.



Figure 11. Viewstation Identification Changes Dialog Box

5. Enter the new computer name or workgroup.
6. Click OK.
7. Restart.

CHANGING THE VIEWSTATION'S IP ADDRESS AND SUBNET MASK

To change the viewstation's IP address:

1. Close all windows on the viewstation desktop.
2. Right-click My Network Places and then go to Properties. The following window appears.

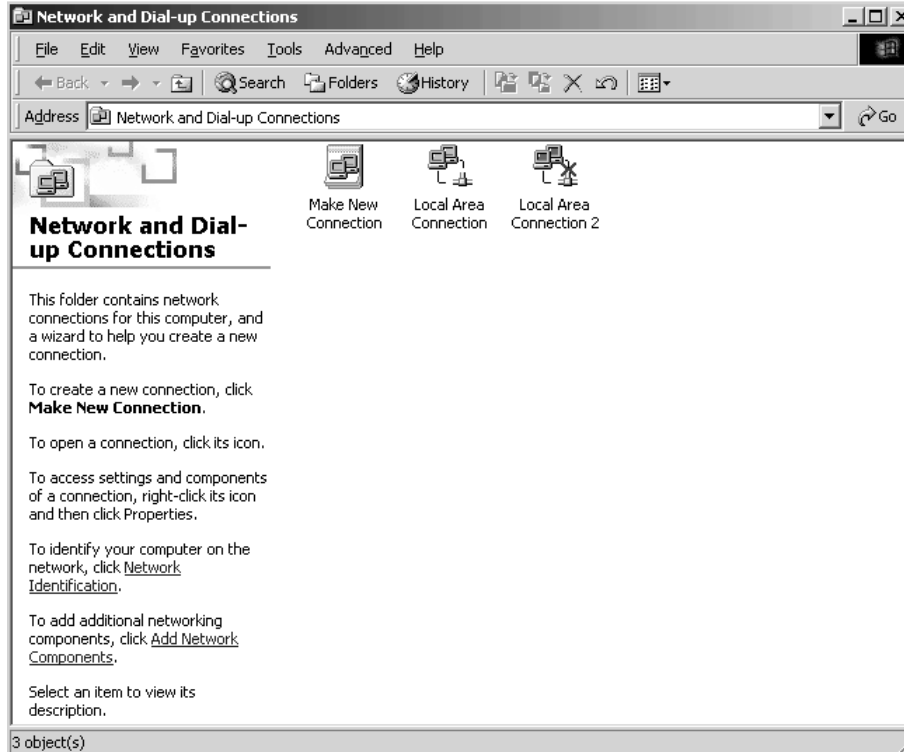

Figure 12. Viewstation Network Connections Window

3. Double-click Local Area Connection. The following dialog box appears.

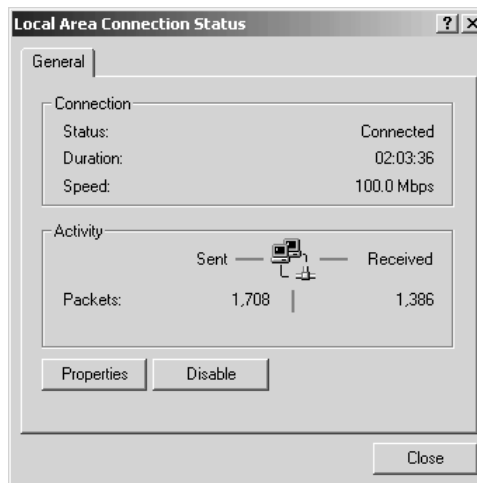

Figure 13. Viewstation Local Area Connection Status Dialog Box

- Click Properties. The following dialog box appears.

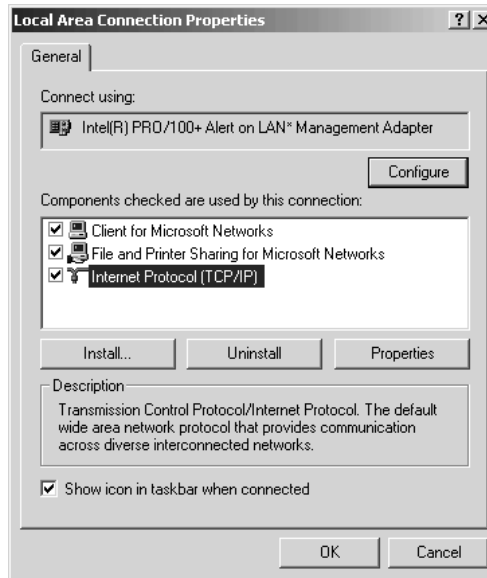

Figure 14. Viewstation Local Area Connection Properties Dialog Box

- Make sure the “Show icon in taskbar when connected” checkbox is selected.
- Double-click Internet Protocol (TCP/IP). The following dialog box appears.

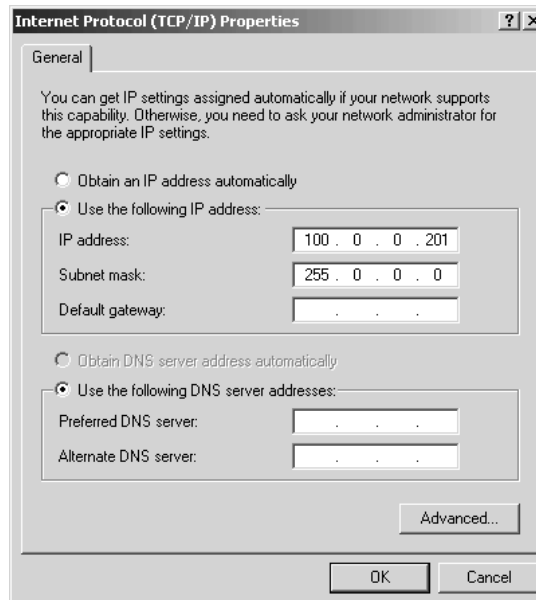

Figure 15. Viewstation Internet Protocol (TCP/IP) Properties Dialog Box

- Enter the IP address (for example, 100.0.0.201). The last three digits must be different for each viewstation (for example, 201, 202, 203, etc.).
- Enter the subnet mask.

NOTE: You may also have to enter your default gateway address and your DNS server address(es).

- Click OK, close all windows, and then restart the viewstation.

CHANGING THE RECORDER'S IDENTIFICATION

The recorder name has been preset during manufacturing. The default name is Pelco1. Changing the recorder's name should be done through the Server Identification dialog box only.

1. Close all applications on the recorder.
2. Double-click the DX9000 Server Configuration Utility icon on the desktop. The following dialog box appears.

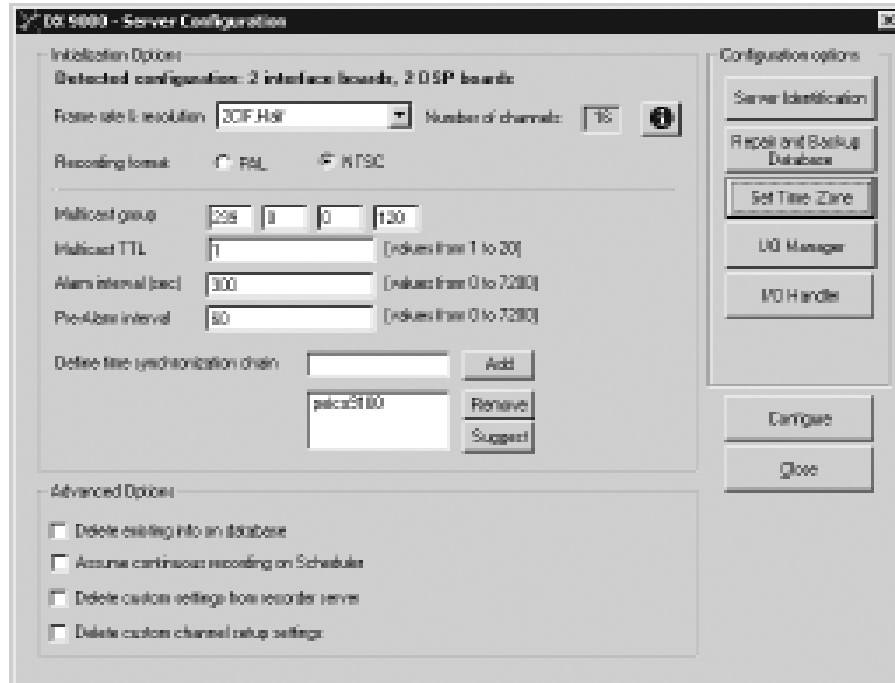

Figure 16. Server Configuration Utility Dialog Box

3. Click Server Identification. The following dialog box appears.

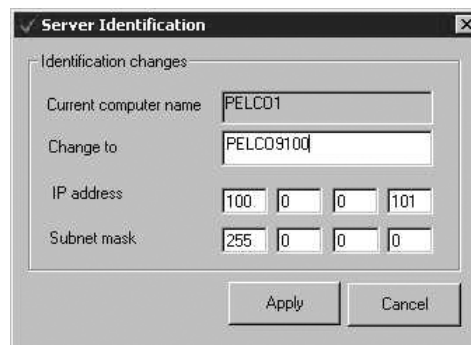

Figure 17. Server Identification Dialog Box

4. Enter the new computer name.

NOTE: The computer name may appear shortened if it is longer than five characters.

5. Enter the new IP address. Make sure the network cable is plugged in before changing the IP address.
6. Click Apply.
7. Click OK to restart the system.
8. Repeat steps 1-7 for all recorders.

TIME SYNCHRONIZATION

All equipment in your system must have the same time. Pelco recommends you select all recorders as time synchronization recorders. Creating this chain ensures that the system will maintain the correct time in case one or more recorders fail. All recorders and viewstations must belong to the same workgroup or local area network (LAN).

Follow these steps for each recorder and each viewstation:

1. Close all applications on the recorder and viewstation.
2. Make sure that the recorder and viewstation are connected to the network switch.
3. Right-click  in the system tray of each unit and select Exit.

NOTE: You can use pcAnywhere to access additional recorders and viewstations. The default user name and password is admin/admin.

4. Make sure the Date/Time Properties are correct on the recorder. You can access the date and time from the system tray.

SETTING DATE/TIME PROPERTIES

Follow these steps to set the Date/Time Properties on the recorder and the viewstation. Make sure you close all applications on the recorder and viewstation.

1. Double-click the time on the system tray. The following page appears.

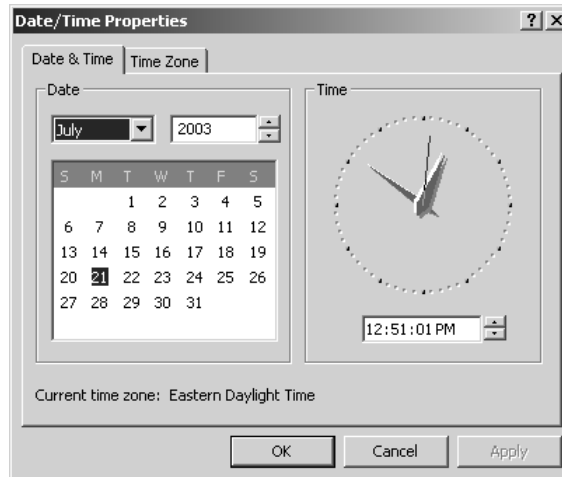

Figure 18. Date & Time Page

2. Set the date and time and then click Apply.
3. Click Time Zone. The following page appears.

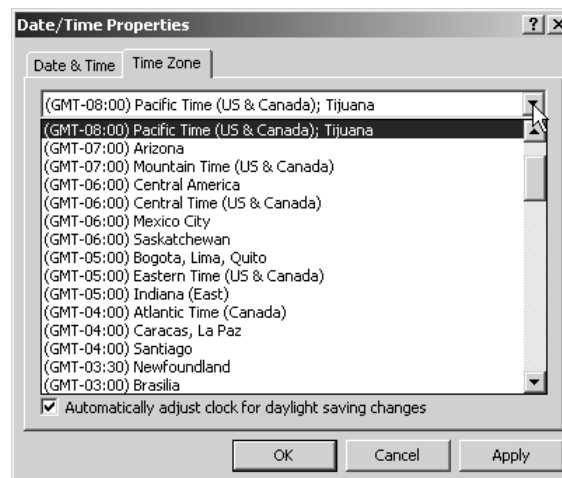

Figure 19. Time Zone Page

4. Select your time zone from the drop-down box. The default is (GMT -08:00) Pacific Time (US & Canada); Tijuana.

NOTE: You must restart the system if you change the default time zone setting on the recorder or viewstation. Do not restart the system during the time synchronization setup.

5. Make sure that the "Automatically adjust clock for daylight saving changes" checkbox is selected, if applicable for the location of installation.
6. Click Apply and then OK.

CLIENT CONFIGURATION UTILITY

NOTE: Make sure the DX9000 Viewstation application is closed before opening the Client Configuration Utility.

You can do the following with this utility:

- Synchronize the time between the recorder and the viewstation
- Identify all the recorders that interface with the viewstation
- Set the Daylight Saving Time for the viewstation
- Import and export the server chain list
- Build a list of local servers

1. Go to Start > Programs > DX9000 Viewstation > Client Configuration Utility. The following dialog box appears.

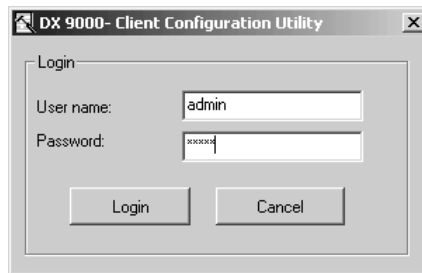

Figure 20. Client Configuration Login Dialog Box

2. Enter your "User name" and Password.

NOTE: The user name (admin) and the password (admin) have been predefined. This is meant for the first time the administrator logs in and should not be shared with nonadministrative users.

3. Click Login. The following dialog box appears.

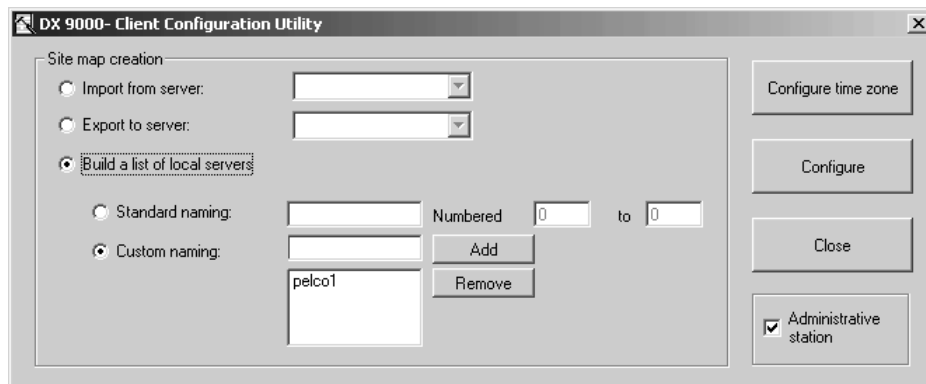

Figure 21. Client Configuration Utility

4. Select "Build a list of local servers."

5. Select "Standard naming" or "Custom naming."
 - a. Standard naming: Select this option if all recorders have the same name and the only difference is the numbers. For example, Pelco1, Pelco2, Pelco3.
 - b. Custom naming: If your recorders have different names, enter the names and then click Add.
6. Click Configure. The following dialog box appears.

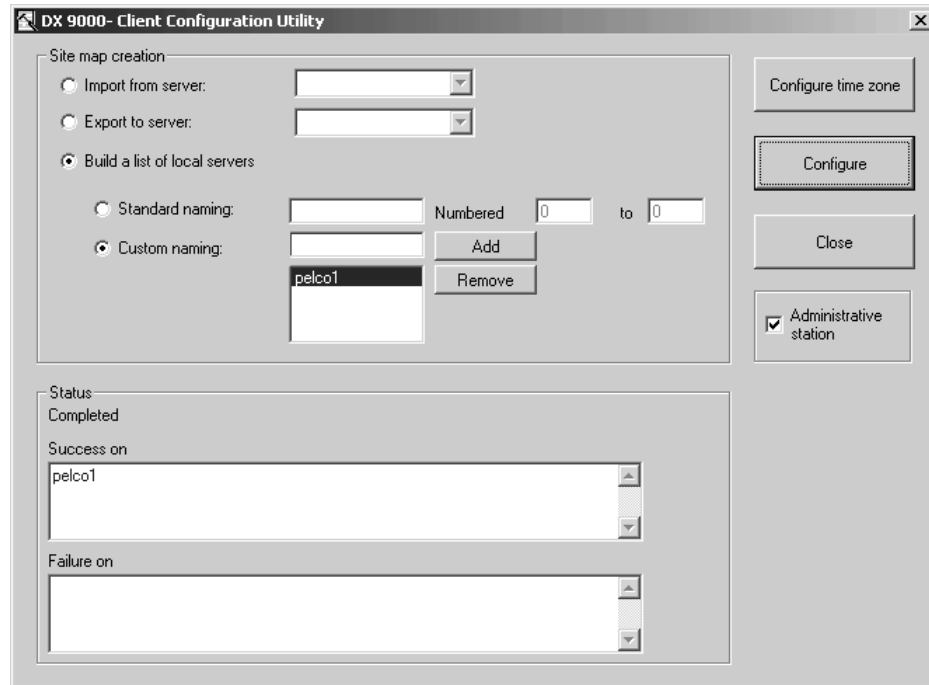

Figure 22. Export to Server Dialog Box

7. Select "Export to server."
8. Select the name of the first recorder from the drop-down box.
9. Click Configure.

NOTE: You must repeat steps 8 and 9 for each recorder that is in the drop-down box.

10. Click Close.
11. Refer to Step 8 of the *Recorder Initialization Options* section to complete time synchronization.

RECORDER INITIALIZATION OPTIONS

To set the recorder initialization options, you must open the DX9000 Server Configuration Utility.

1. Double-click the DX9000 Server Configuration Utility icon on the desktop.
2. Set the "Frame rate & resolution" from the drop-down box. The default is CIF, Half, which is 15 ips at CIF resolution for DX9116H models and 30 ips at CIF resolution for DX9116F models.

The following figure shows the options for the DX9116H models.



Figure 23. DX9116H Frame Rate and Resolution

The following figure shows the options for the DX9116F models.



Figure 24. DX9116F Frame Rate and Resolution

NOTE: When changing the resolution from CIF to 2CIF or 2CIF to CIF, the video recorded prior to the change of resolutions will not be available in the Export Viewer and Sherlock. Also, you must go back to the Client Configuration Utility and click Configure after you restart the recorder.

The number of channels is set automatically based on the frame rate and resolution you select. Click  for more information. The License Information dialog box displays important information about your license, such as the maximum allowed channels and the frame rates and resolutions that are allowed.

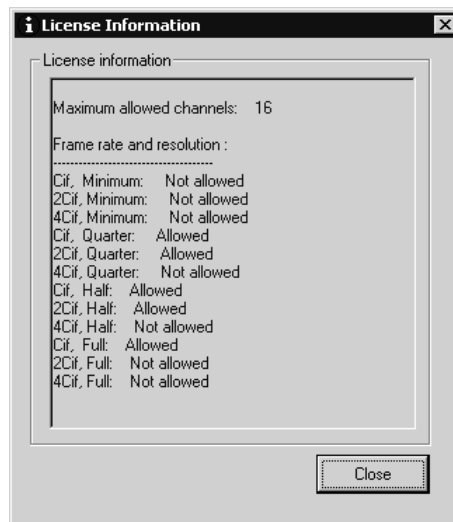

Figure 25. License Information Dialog Box

3. Select PAL or NTSC as the recording format. The default is NTSC.

NOTE: If you change the recording format, you must restart the recorder.

4. Enter the "Multicast group." This number is based on the recorder's IP address. For example, if the IP address is 100.0.0.101, then the multicast group number should be 239.0.0.101. The last three numbers should match.
5. Enter the Multicast TTL number (1-20). This is the number of routers, if any, which separate the recorder from its farthest viewstation on the network. If you do not know the number of routers, contact the network administrator.
6. Enter the "Alarm interval." This is the time (in seconds) between alarms. No alarm will be triggered until the end of the specified interval. The default value is 300 seconds. The range is from 0 to 7,200.
7. Enter the "Pre-Alarm interval." Set the number of seconds to record before the event. The default value is 60 seconds. The range is from 0 to 7,200.
8. Click Suggest to see a list of available recorders. This option is available only if you performed the "Export to server" procedures as described in the Client Configuration Utility. If not, enter the name of the recorders in the "Define time synchronization chain" box. The order of entry for the recorders must be entered identically on each recorder.
9. Select a recorder and then click Add to add it to the time synchronization chain.
10. Click Configure.
11. Restart all recorders and viewstations.

SERVER STATE

The Server State utility checks the status of the recorders that are connected to the viewstation. It verifies if a recorder is recording, not recording, or unreachable. The Server State application should be running in the background all the time.

1. Go to Start > Programs > DX9000 Viewstation > Server State.

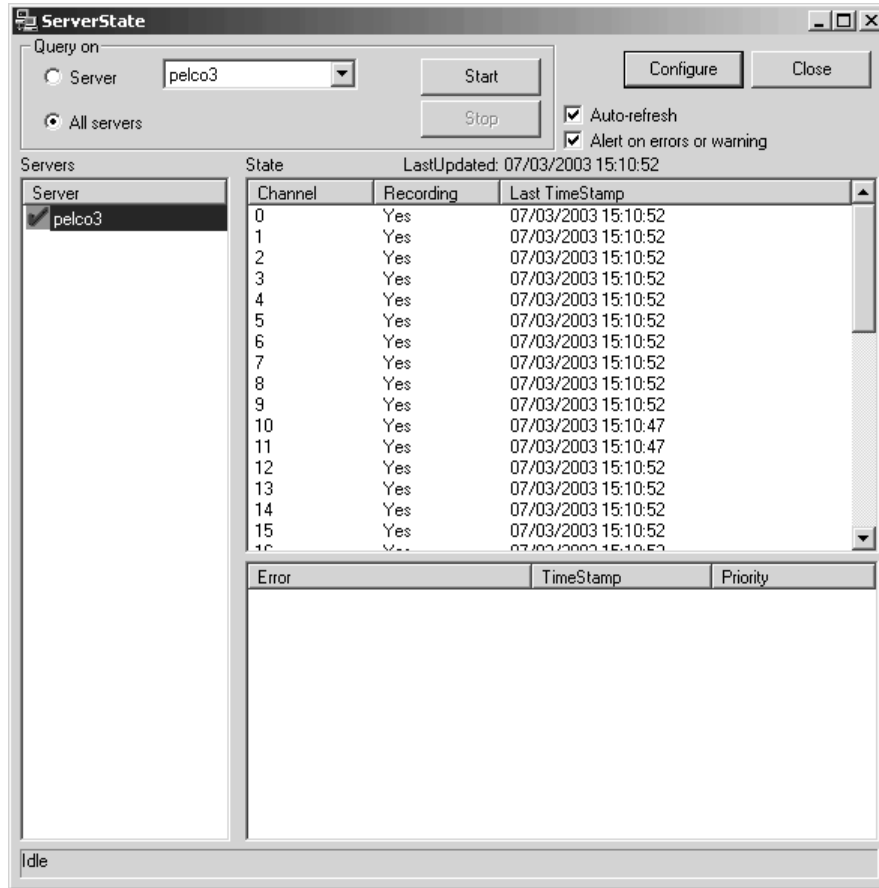

Figure 26. Server State

2. Select "All servers" to run the test on all recorders or "Server" to run the test on a specific recorder.
3. Click Configure.

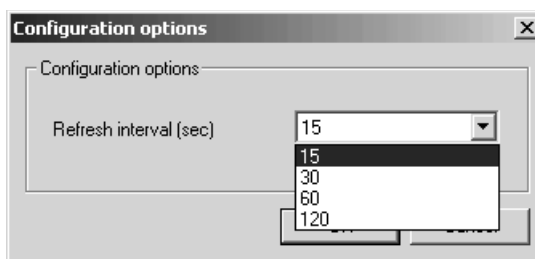

Figure 27. Configuration Options

4. Select the refresh interval. The recommended setting is 60 seconds. Any setting less than 60 seconds will become network intensive because the viewstation constantly polls the recorders.
5. Click OK.
6. Check the "Auto-refresh" checkbox. The application checks the refresh interval when you click start.
7. Check the "Alert on errors or warning" checkbox. The following message appears when an error occurs.



Figure 28. Error Alert

8. Click Start. The following table explains the symbols that appear next to the server name.

Table A. Server State Symbols

Symbol	Status
?	Status is not known. The server has not been tested yet.
→	Test in progress. This arrow appears next to each server being tested.
✓	The server is working.
⊘	Server alert. The error alert message above appears. The error results appear in the bottom right panel.
⚠	Alerts you to a server problem even though the server is still recording.

ADVANCED RECORDER OPTIONS

To set the advanced recorder options, you must open the DX9000 Server Configuration Utility. Double-click the DX9000 Server Configuration Utility icon on the desktop. The Server Configuration Utility dialog box appears with the Advanced Options section.

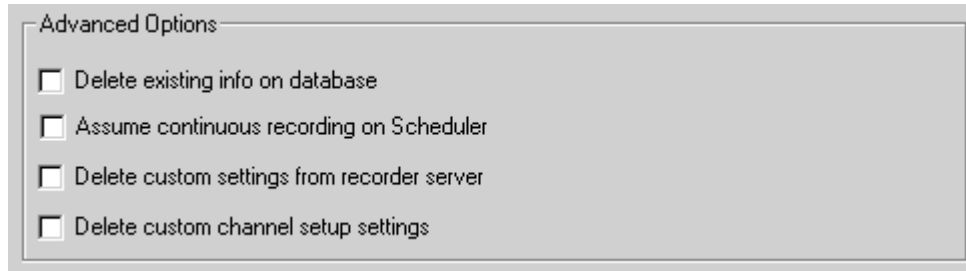

Figure 29. Advanced Options

Delete existing info on database: Select the checkbox to restore the database to its initial state. Click Configure.



WARNING: All information about video files and events will be deleted. You cannot undo these changes.

Assume continuous recording on Scheduler: Select the checkbox to employ continuous recording on the scheduler. Click Configure.

Delete custom settings from recorder server: Select the checkbox to restore the DVMD settings to the default settings. Click Configure.

Delete custom channel setup settings: Select the checkbox to restore the channel setup settings to the default settings. Click Configure.

DATABASE BACKUP AND REPAIR

This option backs up the database files to a backup folder, which it automatically creates in e:\databasebackups\. The system backs up the database automatically once a day.

You can also use this option to back up the database manually to the current time. This ensures you will not lose any information, such as camera titles, in case of system failure.

NOTE: You should perform this option before making changes to the system, such as software upgrades, disk replacement, repair of hardware, etc.

1. Double-click the DX9000 Server Configuration Utility icon on the desktop.
2. Click Repair and Backup Database.
3. Click OK.

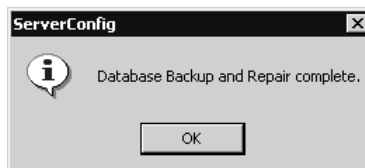

Figure 30. Database Backup and Repair Confirmation

DATABASE RESTORATION

The following procedure explains how to restore a database that has been backed up.

1. Close all recorder applications.
2. Go to the system tray.

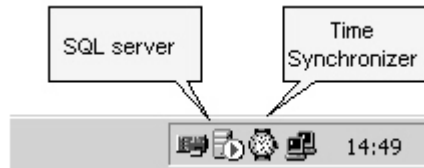

Figure 31. System Tray

3. Double-click the SQL server icon. The following window appears.

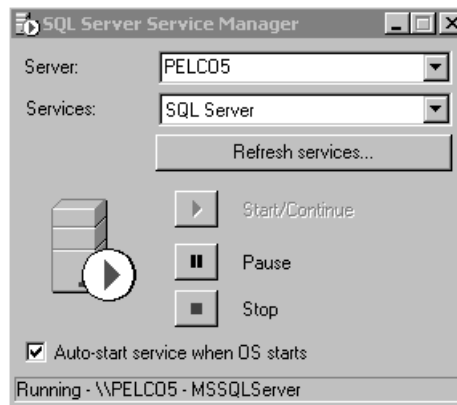

Figure 32. Server Service Manager Window

4. Click Stop. The following dialog box appears.

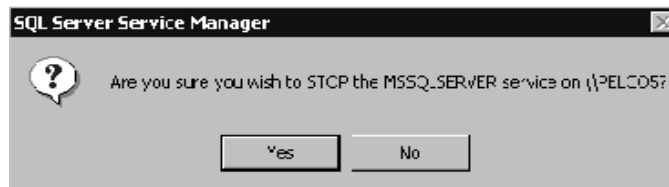

Figure 33. Stop SQL Dialog Box 1

5. Click Yes. The following dialog box appears.

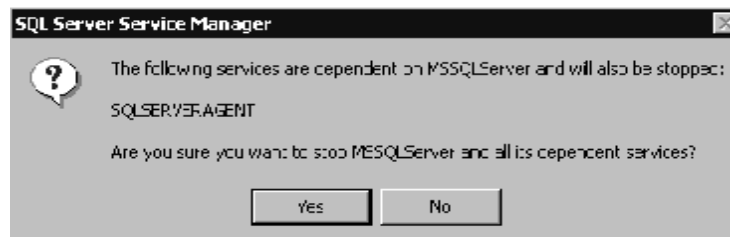

Figure 34. Stop SQL Dialog Box 2

- Click Yes. Start/Continue is enabled after several seconds.

NOTE: The SQL Server Agent will be stopped also. It must be restarted later in the procedure.

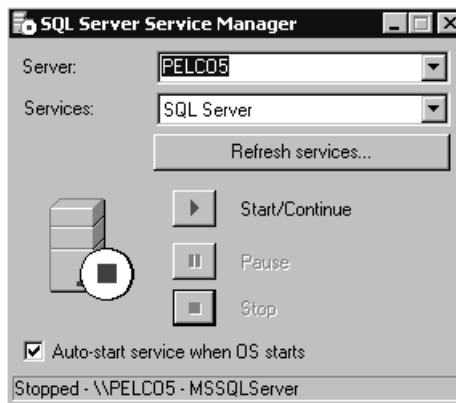

Figure 35. Start/Continue Window

- Exit the window.
- Double-click the recorder name icon on your desktop. The following window appears.

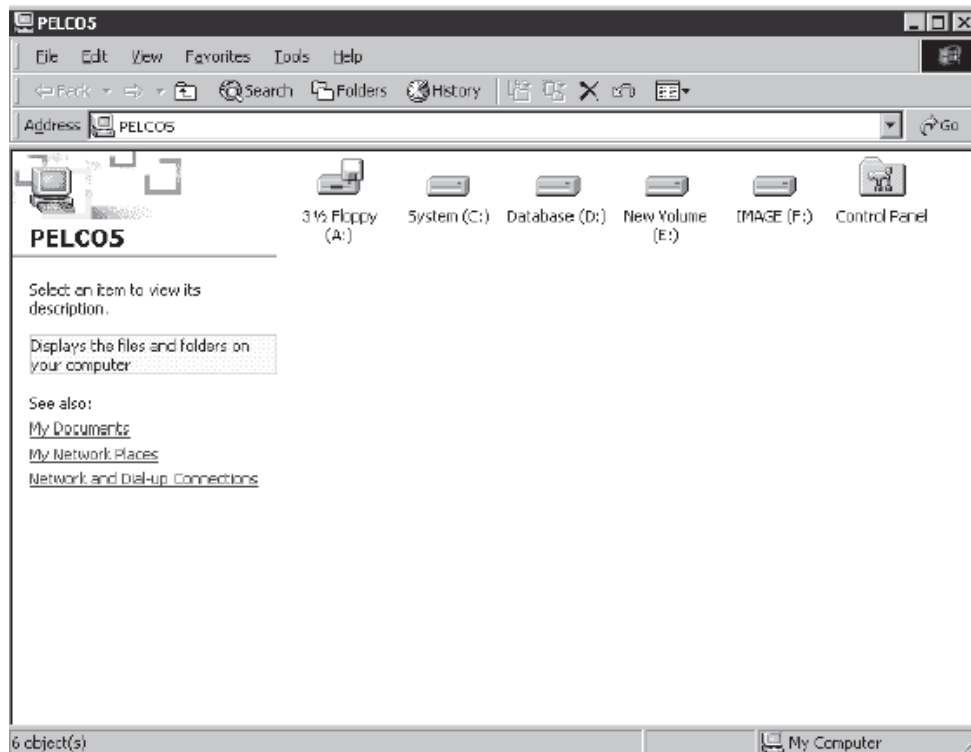

Figure 36. My Computer Window

9. Go to D:\Databases. The following window appears.

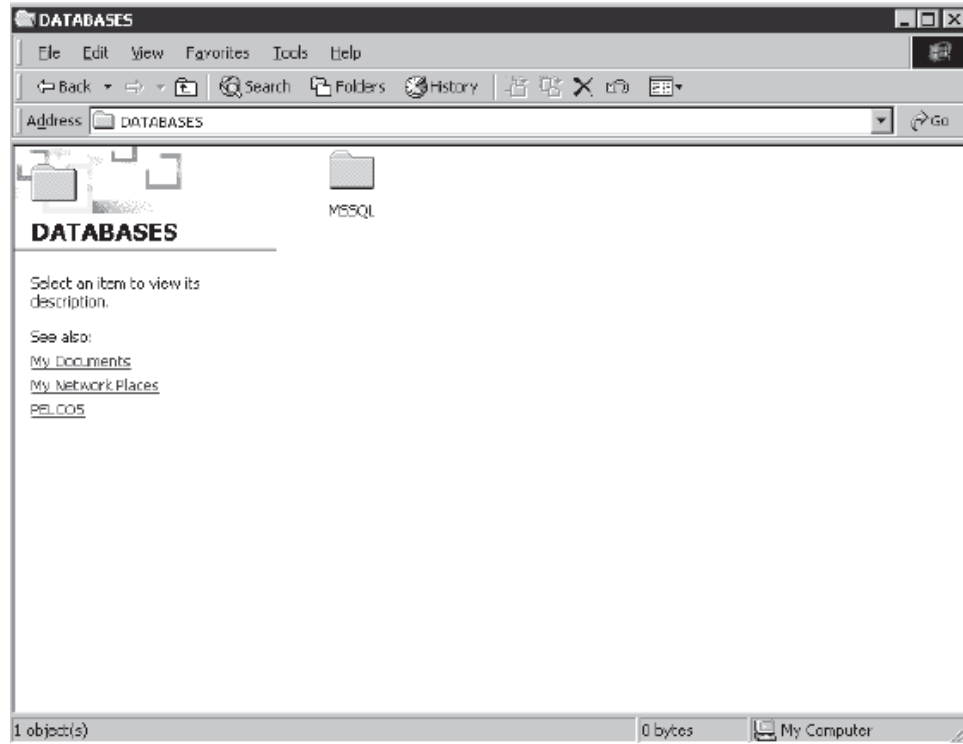

Figure 37. Databases Window

10. Rename MSSQL to MSSQL_old.

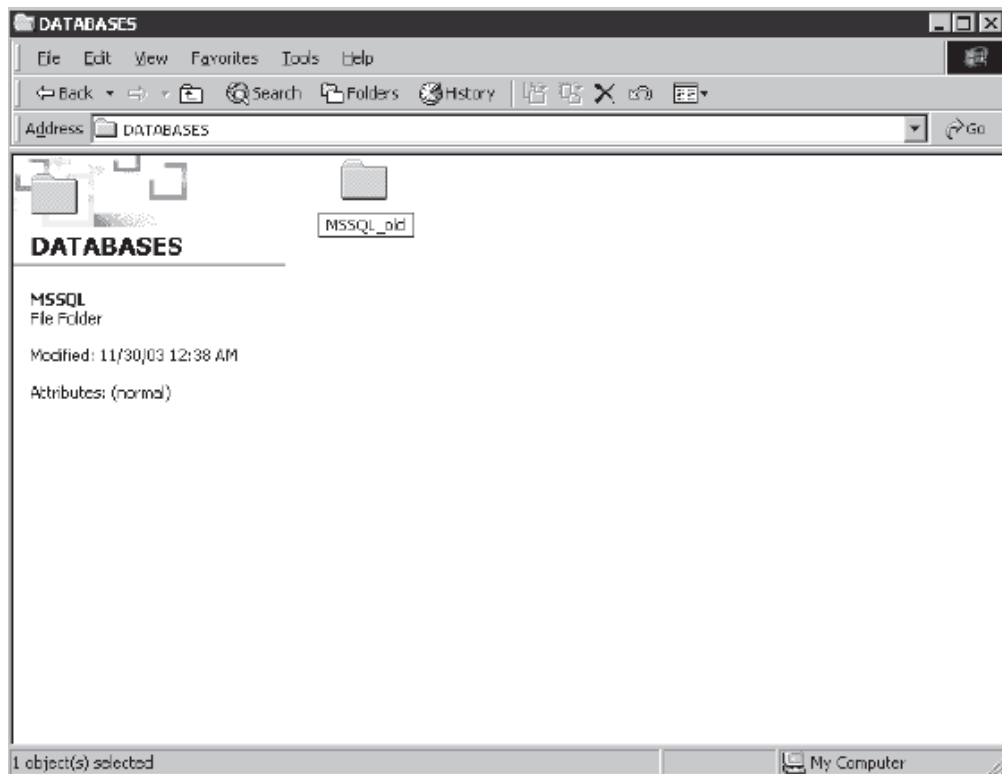

Figure 38. Rename MSSQL

11. Go to C:\Copy of D Drive\Databases. The following window appears.

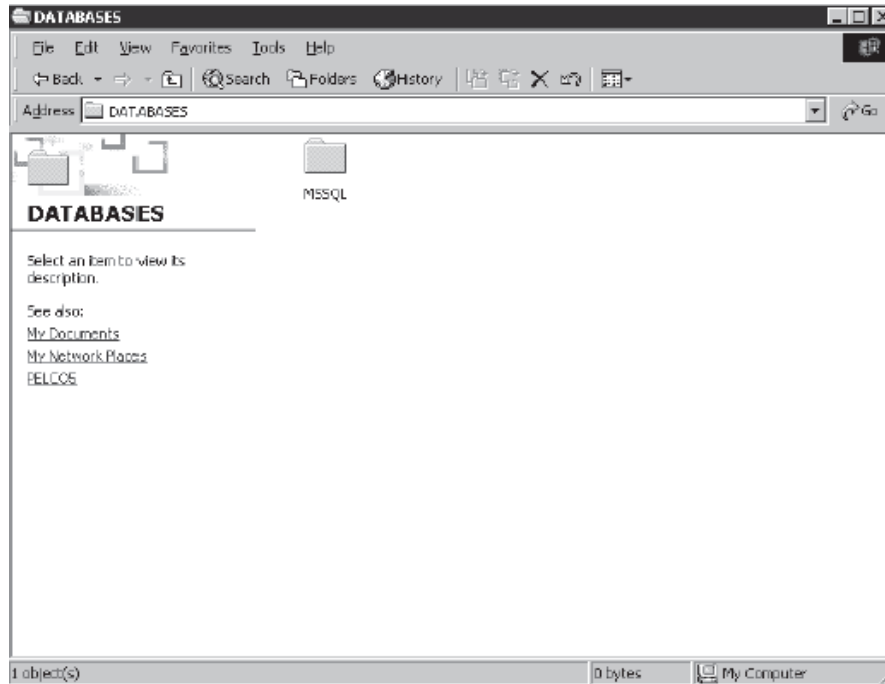

Figure 39. C Drive Databases Window

12. Copy the MSSQL folder and paste it to D:\Databases.

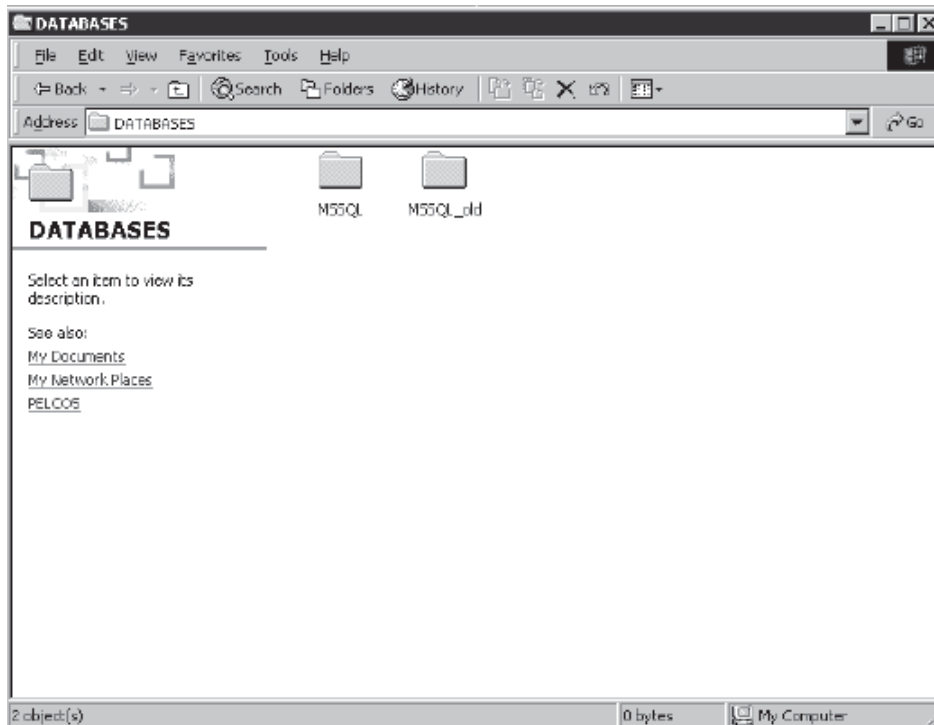

Figure 40. MSSQL Folders

13. Delete MSSQL_old.

NOTE: Remember to delete it from your recycle bin also.

- Double-click the SQL server icon. The following window appears.



Figure 41. Start/Continue Window

- Select SQL Server Agent from the Services drop-down box.
- Click Start/Continue. Stop is enabled and the status is Running after several seconds.
- Select SQL Server from the Services drop-down box.
- Exit the window.
- Go to E:\DatabaseBackups. The following window appears.

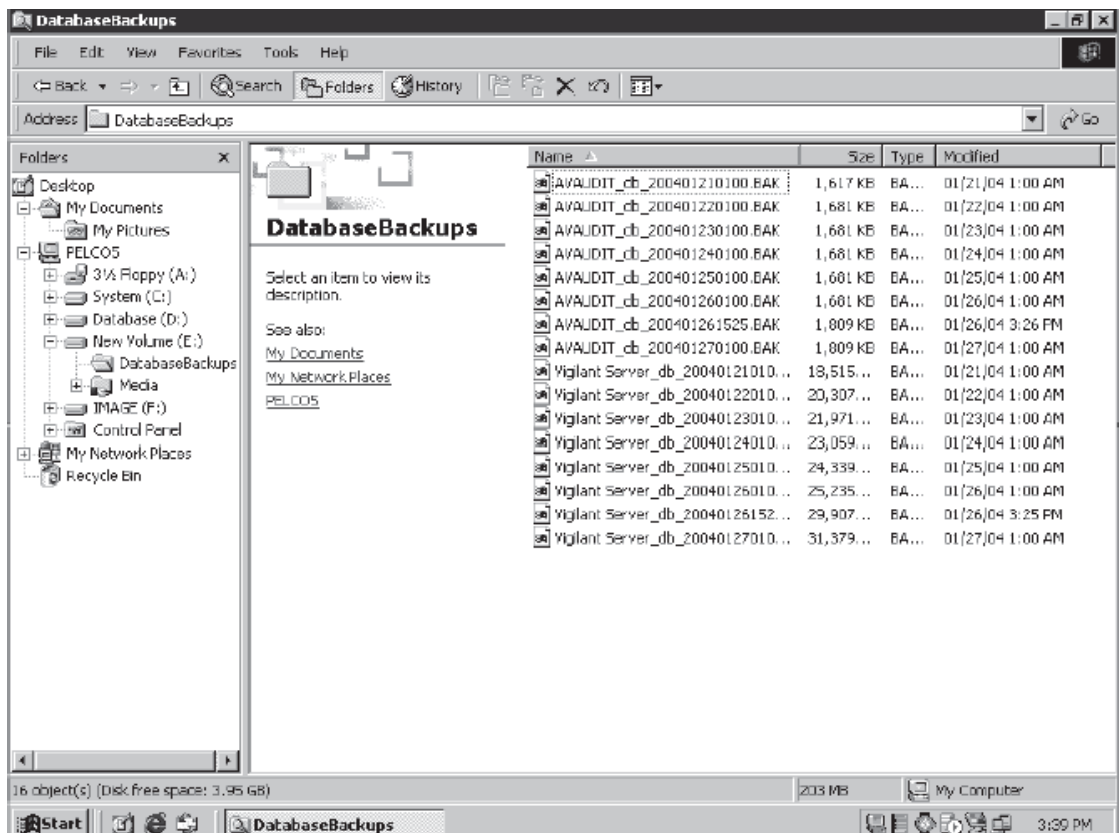

Figure 42. Database Backups Window

- Select the most recent database backup file (Vigilant Server_db).
- Double-click the recorder name icon on your desktop again, and then go to C:\AvServerConfig\avRestoreDBR2.

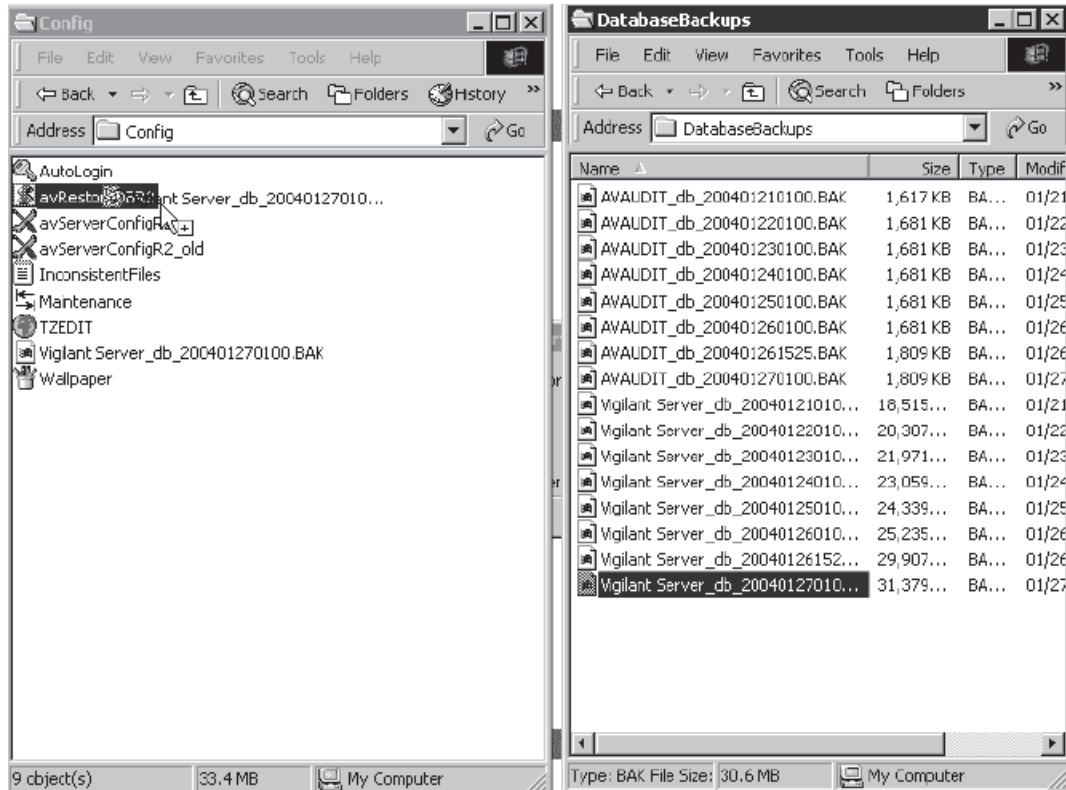

Figure 43. Explorer Windows

- Drag the database backup file to C:\AvServer\Config\avRestoreDBR2. The following dialog box appears.

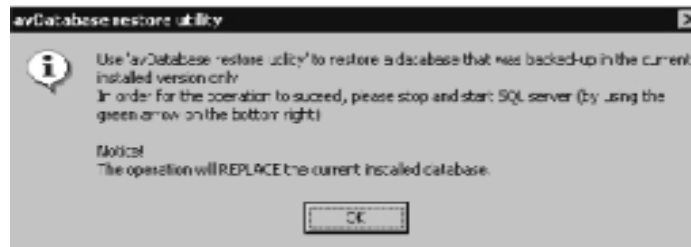

Figure 44. Restore Utility Dialog Box

- Go to the system tray.

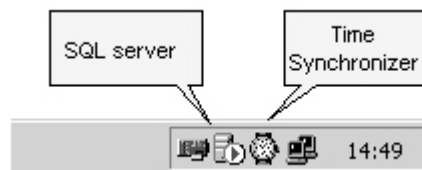

Figure 45. System Tray

24. Double-click the SQL server icon. The following window appears.

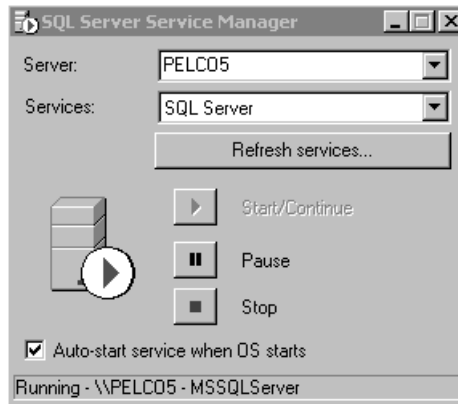

Figure 46. Server Service Manager Window

25. Click Stop. The following dialog box appears.

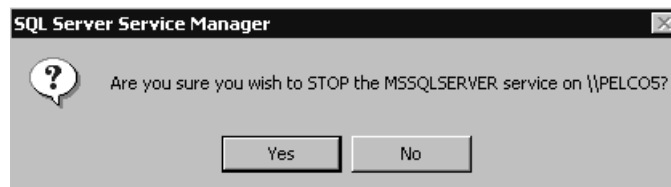

Figure 47. Stop SQL Dialog Box 1

26. Click Yes. The following dialog box appears

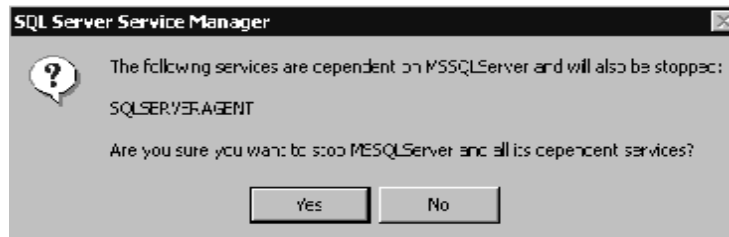

Figure 48. Stop SQL Dialog Box 2

27. Click Yes. Start/Continue is enabled after several seconds.

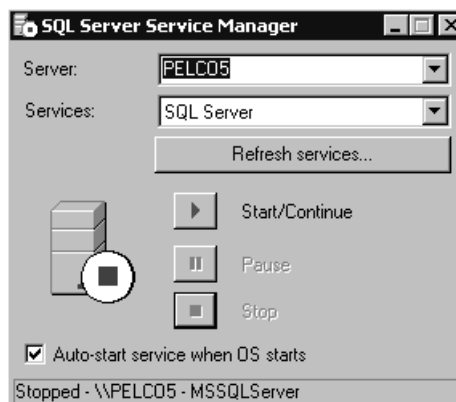

Figure 49. Start/Continue Window

28. Select SQL Server Agent from the Services drop-down box.
29. Click Start/Continue. Stop is enabled and the status is Running after several seconds.
30. Select SQL Server from the Services drop-down box.
31. Exit the window.

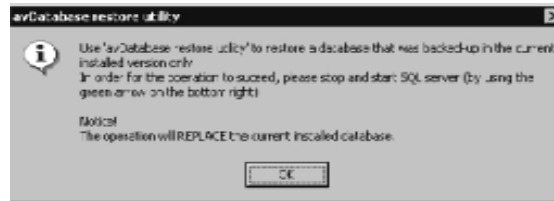

Figure 50. Replace Database Dialog Box

32. Click OK. The following dialog box appears.

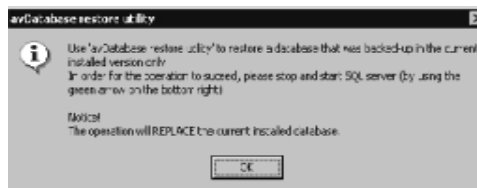

Figure 51. Restore Confirmation Dialog Box

33. Click OK to restore from the selected backup file. The following dialog box appears.



Figure 52. Operation Completed Dialog Box

34. Click OK and restart the recorder.
35. Close all recorder applications.
36. Go to C:\AvServer\Config, and then double-click Maintenance. The following dialog box appears.

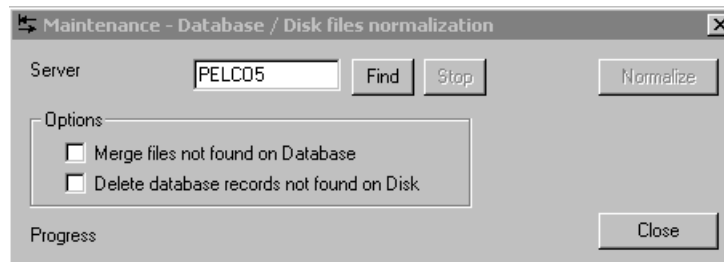

Figure 53. Maintenance Dialog Box

37. Enter the name of the desired recorder. The default is the local recorder name.
38. Click Find. The utility counts the number of files on the disk that do not have corresponding records in the database and the number of records in the database that do not have corresponding files.

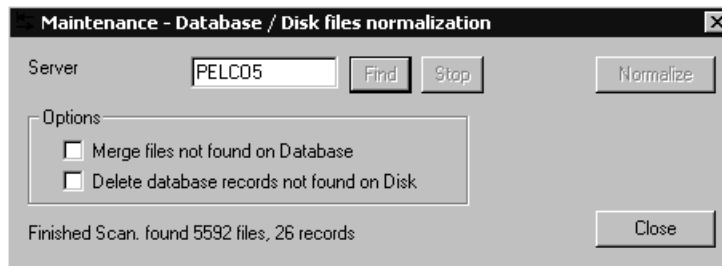

Figure 54. Finished Scan Dialog Box

39. Select "Merge files not found on Database" to create new records on the database for the video files that were detected.
40. Select "Delete database records not found on Disk" to delete records on the database that do not have any video files.
41. Click Normalize to merge files and delete records. "Finished Merging" appears at the bottom of the window when the process is complete.



Figure 55. Finished Merging Dialog Box

42. Click Close.
43. Restart the recorder.

CONFIGURING STANDARD ALARM AND RELAY PROPERTIES

In the I/O Handler dialog box, you can define the correct driver to support the external devices. The recorder is already configured to support its built-in I/O ports. If you need to configure the recorder to support different settings or external devices, use the I/O Handler. The default driver for the I/O ports is the **Av11602.dll** driver

1. Open the DX9000 Server Configuration Utility icon on the desktop and then click I/O Handler. The following dialog box appears.

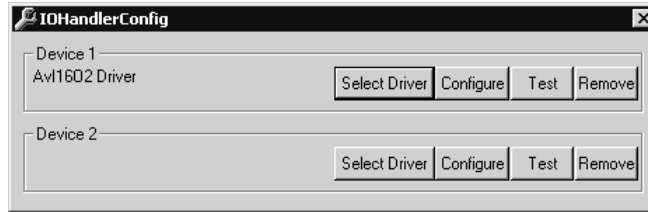

Figure 56. I/O Ports Driver Dialog Box

2. The recorder has one built-in I/O port, which is mapped to Device 1. Click Test. You will get a confirmation message indicating that the configuration test of the driver is successful.
3. Click Configure to set the relay intervals and alarm modes. The following dialog box appears.

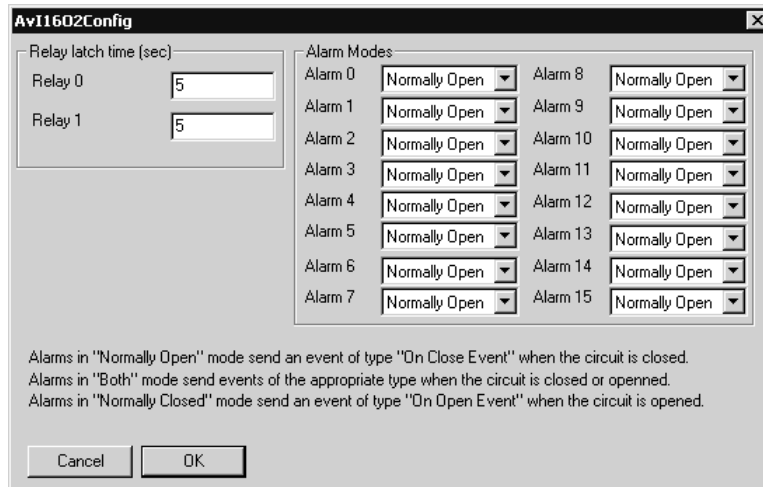

Figure 57. Alarm Modes/Relay Intervals Dialog Box

4. Set a value between 0 and 86,400 seconds for the relays. The default value is 5 seconds. You can set the alarm modes to Normally Open, Normally Closed, or Both. The default is Normally Open.

NOTE: In the Normally Open mode, alarms are triggered when the circuit is closed. In the Normally Closed mode, alarms are triggered when the circuit is opened. In the Both mode, an alarm is triggered when the circuit is open or closed.

5. Click OK.
6. Click Test.
7. Close the I/O Handler Configuration application.

NOTE: Refer to the *I/O Manager for Relay Unit* and the *I/O Manager for Alarm Unit* sections to complete configuration.

CAMERA RECORDING PROPERTIES

Camera recording properties should be set by the system administrator during installation. Only system administrators and operators with a Level 1 authorization can set or change camera recording properties. To set or change camera recording properties, you must open the DX9000 Viewstation application. The System button on the main toolbar is not available to Level 2-6 operators. If you do not have access, see the system administrator.

To set or change camera recording properties:

1. Click System > Properties on the main toolbar. The following window appears.

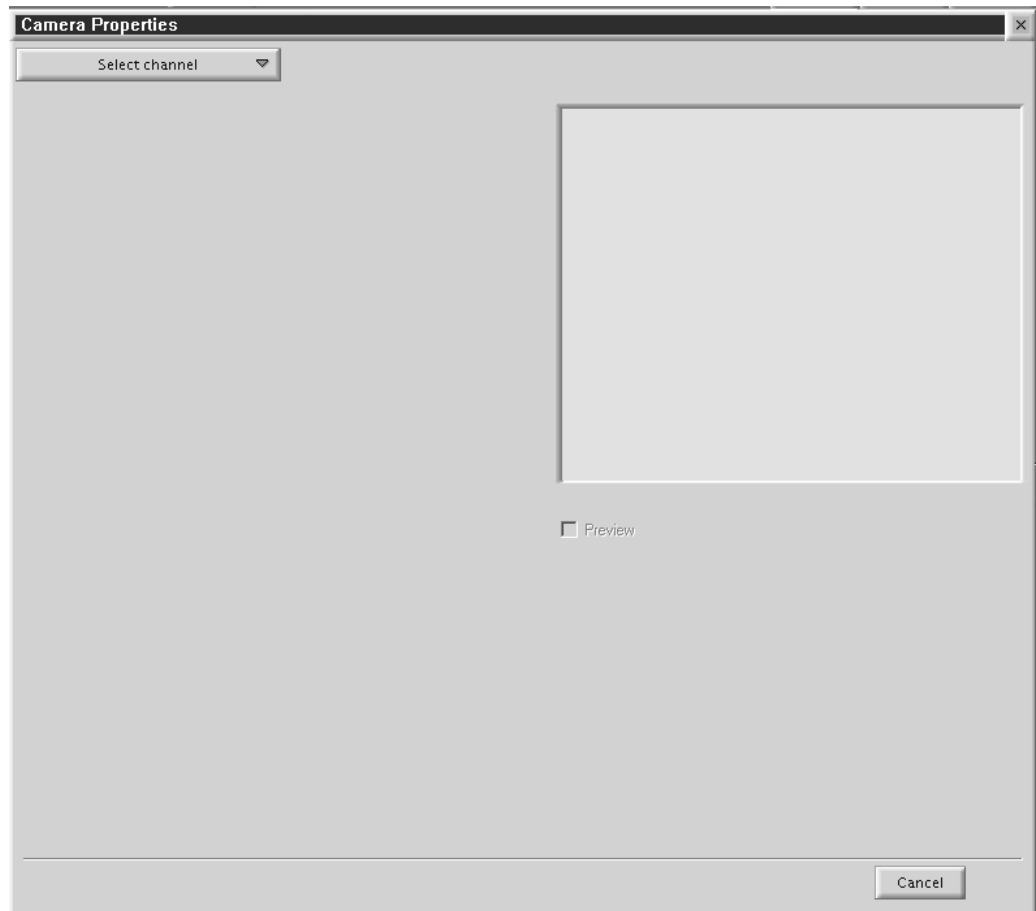

Figure 58. Camera Properties Dialog Box

- Click "Select channel" to display a list of recorders. An example is shown below.

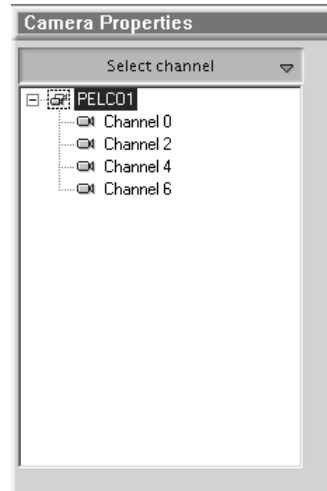

Figure 59. Select Channel Dialog Box

- Select a channel.
- Select the Preview checkbox, as shown below, to verify that you have the correct camera.



Figure 60. Continuous Recording Schedule Page

CONTINUOUS RECORDING SCHEDULE

1. Select the "Continuous recording" radio button. (This is the default setting and should already be selected the first time you select a channel.) Refer to Figure 60.
2. Click Apply.

Recording is done at all times and no schedule is defined. The entire daily and weekly recording schedules are marked in light yellow, and any previous definitions on the schedules are removed.

DAILY RECORDING SCHEDULE

NOTE: To make sure there is no delay during scheduled recording, begin the recording at least five minutes before the actual recording time. For example, schedule a recording at 7:55 a.m. instead of 8:00 a.m.

1. Select the "Daily recording schedule" radio button.
2. Click Continuous or "Event record."
3. In the time bar, click the desired start/end times for recording, or enter the exact start/end times in the "Fine tune" fields.
4. Click Apply.

The example below shows a *Continuous* daily recording schedule from 7:05 a.m. to 12:05 p.m. The box in the time bar is blue with a red border. You can make the box smaller or larger by dragging it with your mouse.

Daily recording schedule

00:00 06:00 12:00 18:00 24:00

Weekly recording schedule

Sun

Mon

Tue

Wed

Thu

Fri

Sat

Continuous Event record No record

Fine tune: From: 7:05:00 AM To: 12:05:00 PM

Figure 61. Continuous Daily Recording Schedule Page

The example below shows a daily *Event record* schedule from 7:05 a.m. to 12:05 p.m. The box in the time bar is yellow with a red border. You can make the box smaller or larger by dragging it using your mouse.

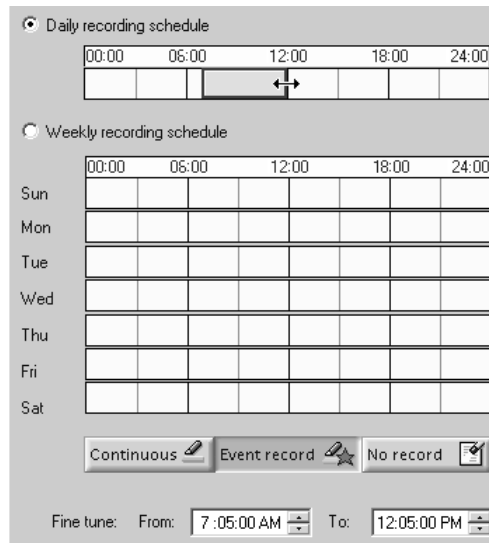

Figure 62. Daily Event Recording Page

If you select event recording, the DX9100 actually records continuously. The difference between continuous and event recording is the way the video is saved in the database. When the hard drives are full, the DX9100 starts overwriting the oldest video. With continuous recording, the DX9100 overwrites the video in the order in which it was recorded, whether it is an event or a nonevent. With event recording, the DX9100 overwrites nonevents first and then events. Data is overwritten on a day-to-day basis.

To delete a time period:

1. Click "No record."
2. Click the box in the time bar.

WEEKLY RECORDING SCHEDULE

NOTE: To make sure there is no delay during scheduled recording, begin the recording at least five minutes before the actual recording time. For example, schedule a recording at 7:55 a.m. instead of 8:00 a.m.

1. Select the "Weekly recording schedule" radio button.
2. Click Continuous or "Event record."
3. In the time bars, click the desired start/end times for recording for each day of the week, or enter the exact start/end times in the "Fine tune" fields.
4. Click Apply.

The example below shows a *Continuous* weekly recording schedule from 7:05 a.m. to 12:05 p.m. The boxes in the time bars are blue with a red border. You can make the boxes smaller or larger by dragging them with your mouse.

Weekly recording schedule

00:00 06:00 12:00 18:00 24:00

Sun
Mon
Tue
Wed
Thu
Fri
Sat

Continuous Event record No record

Fine tune: From: 7:05:00 AM To: 12:05:00 PM

Figure 63. Continuous Weekly Recording Schedule Page

The example below shows a weekly *Event record* schedule from 7:05 a.m. to 12:05 p.m. The boxes in the time bars are yellow with a red border. You can make the boxes smaller or larger by dragging them with your mouse.

Weekly recording schedule

00:00 06:00 12:00 18:00 24:00

Sun
Mon
Tue
Wed
Thu
Fri
Sat

Continuous Event record No record

Fine tune: From: 7:05:00 AM To: 12:05:00 PM

Figure 64. Weekly Event Recording Schedule Page

To delete a time period:

1. Click "No record."
2. Click the boxes in the time bars.

MOTION DETECTION

1. Click the DVMD tab. The DVMD page appears. Refer to Figure 65.
2. Select the "Detector on" radio button.
3. Select the Preview checkbox. The video has blue squares over the entire area meaning the entire video has been selected for motion detection.
4. Click "Clear all" to remove all of the boxes or click the right mouse button on each box you want to remove.
5. Click "Mark all" to select the entire video for motion detection or click the left mouse button to add individual boxes.
6. Click "Discard changes" to undo your changes.
7. Drag the triangles on the slider bars to select the minimum time between events and the video motion detection (VMD) sensitivity.
8. Click Apply.

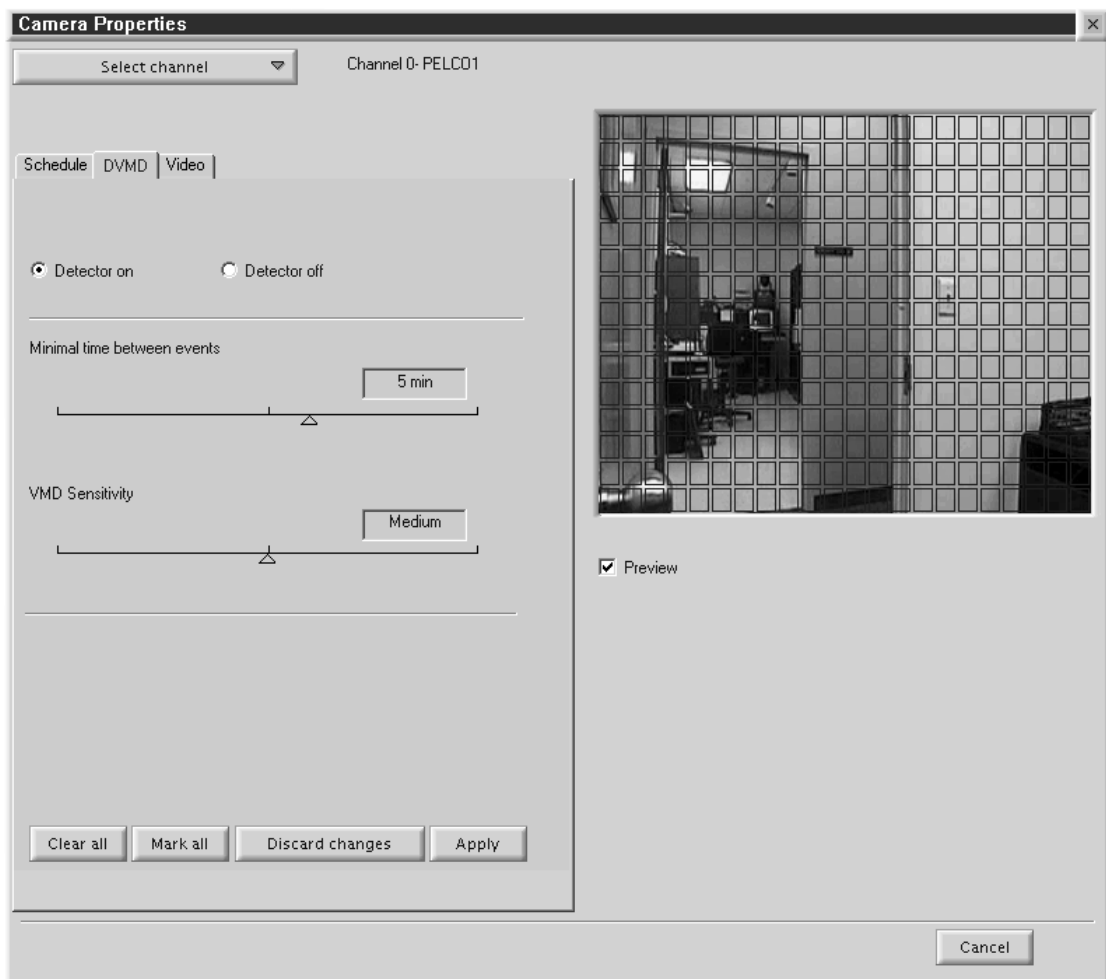

Figure 65. Motion Detection Page

CHANNEL SETUP

This section describes how to set camera properties to get the best picture.

1. Click the Video tab. The Video page appears. Refer to Figure 66.
2. Select the Preview checkbox to see the video quality with the default settings.
3. Adjust the video quality by dragging the triangles on the slider bars to the desired values. Refer to Table B.
4. Click Apply.

NOTE: The bit rate, located under the "Select channel" button, displays the amount of activity in the specified channel. A higher bit rate requires more storage space. It is important to notice the bit rate as you adjust your camera settings to achieve the highest quality picture with the lowest bit rate.

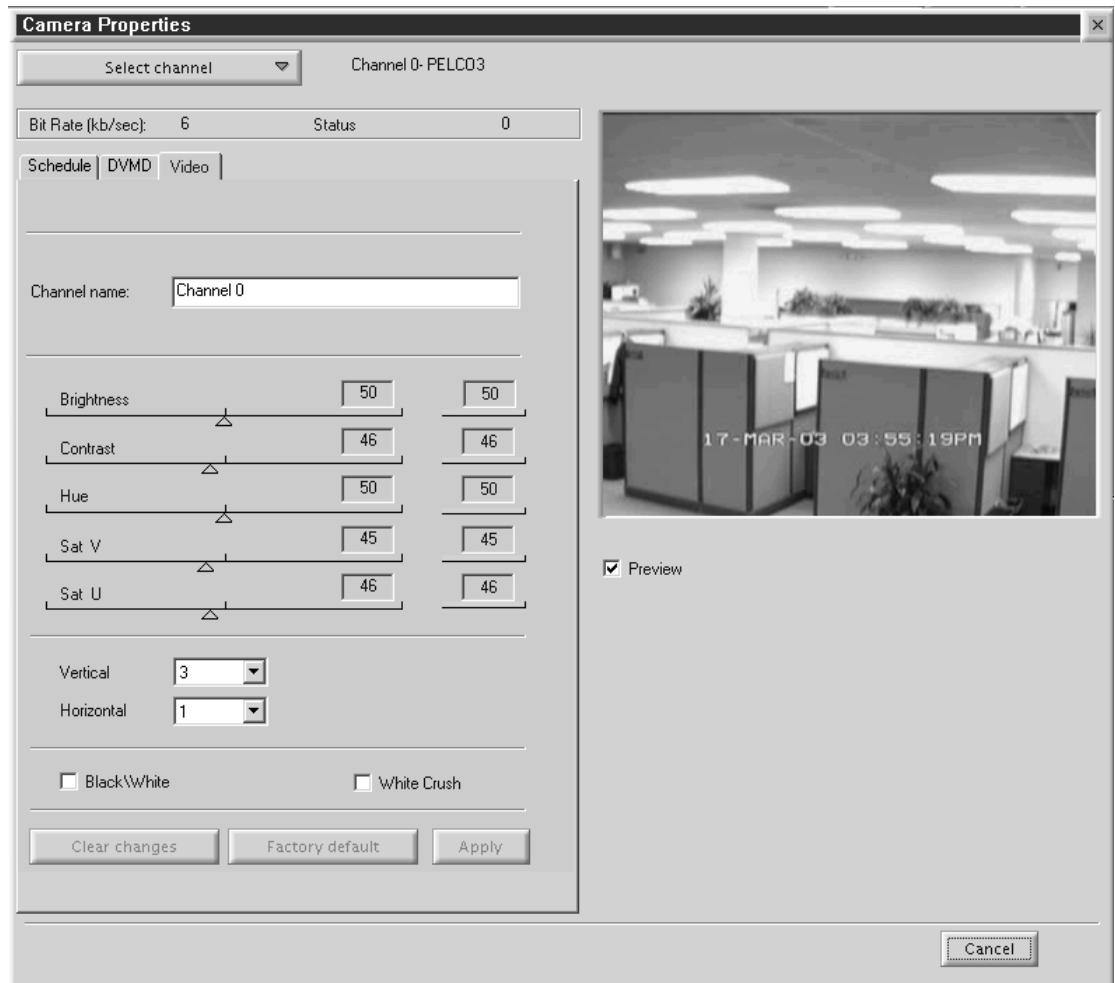

Figure 66. Camera Video Setup Page

Table B. Channel Setup

Parameter	Description/Action
Channel Name	Enter a new name for this channel. You can enter up to 20 characters.
Brightness	Drag the triangle to change the brightness value. The higher the value, the higher the bit rate. The previous value is displayed to the right of the brightness bar.
Contrast	Drag the triangle to change the contrast value. The higher the value, the higher the bit rate. The previous value is displayed to the right of the contrast bar.
Hue	Drag the triangle to change the hue value. The previous value is displayed to the right of the hue bar.
Sat V	Drag the triangle to increase or decrease the red color in the video. The previous value is displayed to the right of the Sat V bar.
Sat U	Drag the triangle to increase or decrease the blue color in the video. The previous value is displayed to the right of the Sat U bar.
Vertical	This reduces or eliminates video noise. The higher the value, the lower the bit rate. The lower the value, the higher the bit rate.
Horizontal	This reduces or eliminates video noise. The higher the value, the lower the bit rate. The lower the value, the higher the bit rate.
Black/White	Select this checkbox if the channel is connected to a black/white camera. This option ignores video noise.
White Crush	Select this checkbox to reduce the intensity of the white images.

DEFINING USERS

Only system administrators can define user names and passwords for the DX9100 Viewstation. Other users trying to access this option will get the following message:

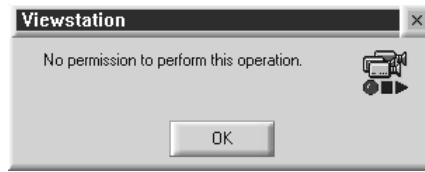

Figure 67. User Access Dialog Box

This option allows an administrator to add, delete, and change the properties of users in the DX9100 system. There are seven predefined user access levels ranging from Administrator to Operator Level 6. Each user is assigned different access rights to the DX9100 network and videos.

Click System > Users on the main toolbar. In the example below, each operator level has been assigned a user name and password.

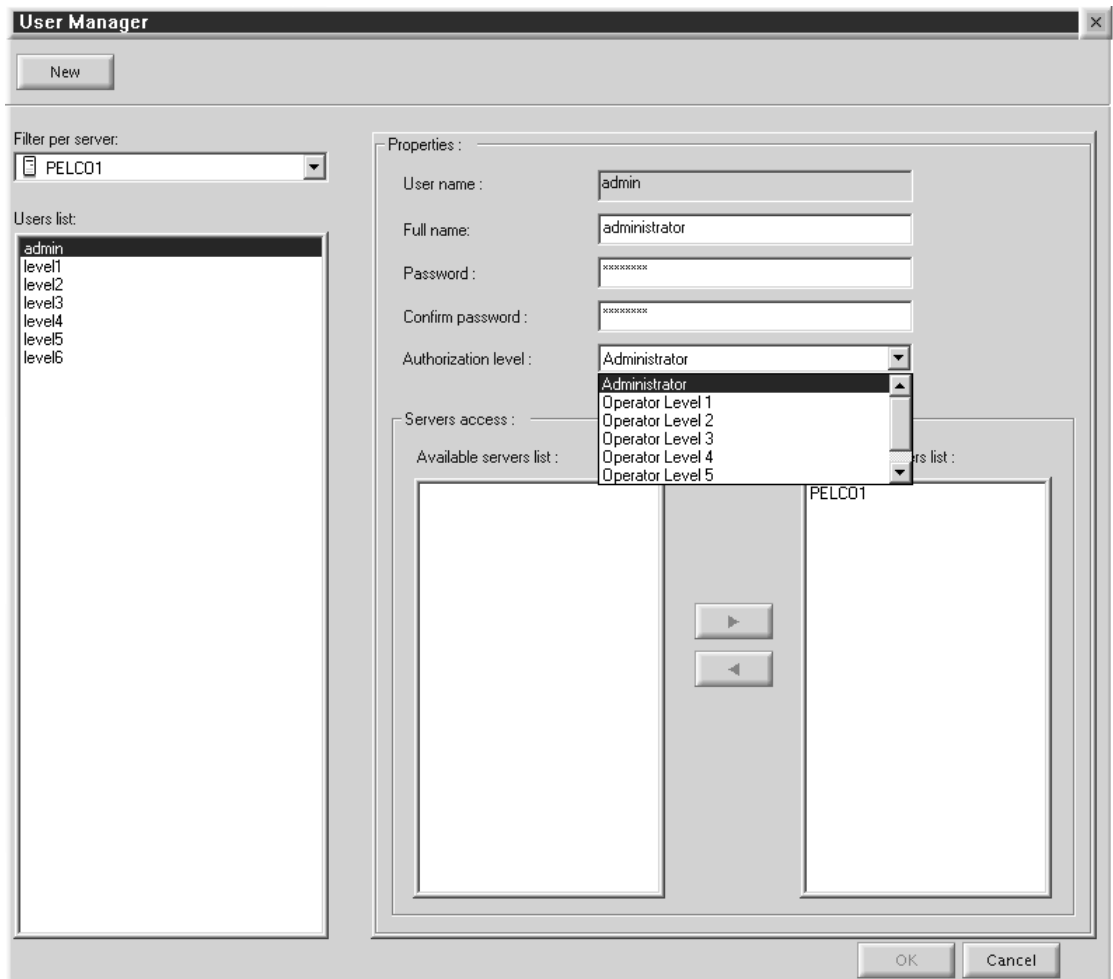

Figure 68. User Manager Dialog Box

Table C. User Access Rights

User	Live Video/ Live Events	Video Playback/ Query/Sherlock	Locked Video Playback	Lock Video	Export Image/ Video	Unlock Video/ Change Camera Settings	Define Users/Audit Viewer
Administrator	✓	✓	✓	✓	✓	✓	✓
Operator Level 1	✓	✓	✓	✓	✓	✓	
Operator Level 2	✓	✓	✓	✓	✓		
Operator Level 3	✓	✓	✓	✓			
Operator Level 4	✓	✓	✓				
Operator Level 5	✓	✓					
Operator Level 6	✓						

Edit Existing Users

1. Select the server name from the "Filter per server" drop-down box. A list of users defined for the selected server appears under the Users List.
2. Select a user. The user's properties appear in the Properties panel.
3. Select a new operator authorization level.
4. Select the server name from the "Accessible servers list."
5. Click OK.

Adding a New User

1. Click New.
2. Enter the user name. This is the login user name.
3. Enter the user's full name.
4. Enter the user's password. This is the login password.
5. Reenter the same password.
6. Select the user's authorization level: administrator or operator.
7. Highlight the server the user should have access to from the "Accessible servers list."
8. Click OK.

Deleting a User

1. Select the user name from the "Users list."
2. Select the server name from the "Accessible servers list."
3. Click the left arrow button.
4. Click OK.

ADVANCED FEATURES

I/O INTERFACE

The DX9100 system can interface with the CM6800, CM9740, or CM9760 matrix switchers. It can integrate with the CM9760-DT, CM9760-ALM, and CM9760-REL.

- CM9760-DT data translator translates the ASCII protocol to the P protocol of the CM9740/CM9760 matrix switchers.
- Connect up to four CM9760-ALM alarm units to each DX9100 recorder.
- Connect up to four CM9760-REL relay units to each DX9100 recorder.

I/O HANDLER

This application is used to program the onboard alarm and relay driver and allows the installer to identify one additional external device—the CM9760 data translator, the CM9760-ALM alarm unit, or the CM9760-REL relay unit—to be connected to the COM port on the recorder. Each of the external devices can be shared across multiple recorders, but when programming to external devices, the programming only needs to be done on the recorder which is physically attached to the device.

I/O MANAGER

This application is used in conjunction with the I/O Handler to configure the DX9100 recorder's onboard relays and alarms, and to interface to:

- the CM9760-ALM if more than the provided 16 inputs are needed
- the CM9760-REL if more than the provided 2 outputs are needed
- the CM9760-DT to send software alarms such as video motion detection from the recorder to the matrix

Since these devices can be shared across multiple recorders across the network, the installer can identify alarm inputs 1-16 for recorder #1, alarm inputs 17-32 for recorder #2, and so on.

CONNECTING AN ALARM UNIT

You can connect a maximum of four alarm units to a recorder.

To connect a CM9760-ALM to a DX9100 recorder using RS-232 communication:

1. Connect a null modem cable from the alarm unit's RS-232 port to the recorder's RS-232 port.
2. Set the DIP switches on the alarm unit for RS-232 communication. Refer to the CM9760-ALM Installation/Operation manual.

If using RS-422 communication:

1. Connect a cable from the alarm unit's RJ-45 COM IN port to the recorder's RS-232 port via an RS-232 to RS-422 converter.
2. Set the DIP switches on the alarm unit for RS-422 communication. Refer to the CM9760-ALM Installation/Operation manual.

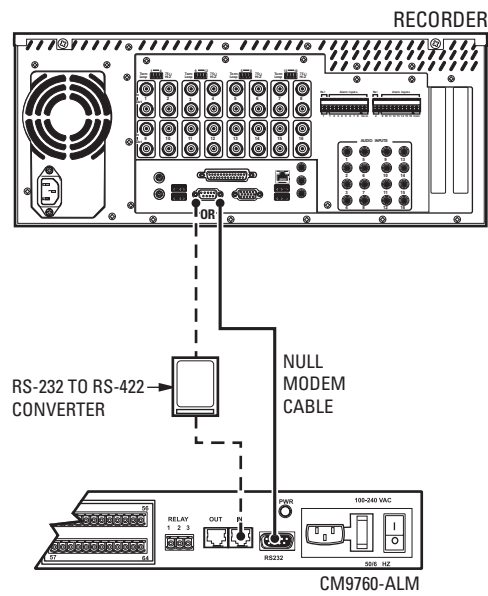

Figure 69. Connecting a CM9760-ALM

ALARM UNIT CONFIGURATION

Follow these steps to configure a CM9760-ALM alarm unit.

NOTE: This programming is required only on the recorder that is physically connected to the CM9760-ALM.

1. Go to Start > Programs > DX9000 Server > IO Handler Configuration. The following dialog box appears.

NOTE: You can also open the I/O Handler from the DX9000 Server Configuration Utility.

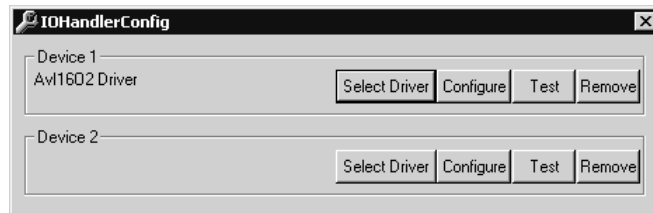

Figure 70. Alarm I/O Handler Configuration Dialog Box

2. Click Select Driver on Device 2 to define the external device that is connected to the recorder. The following dialog box appears.

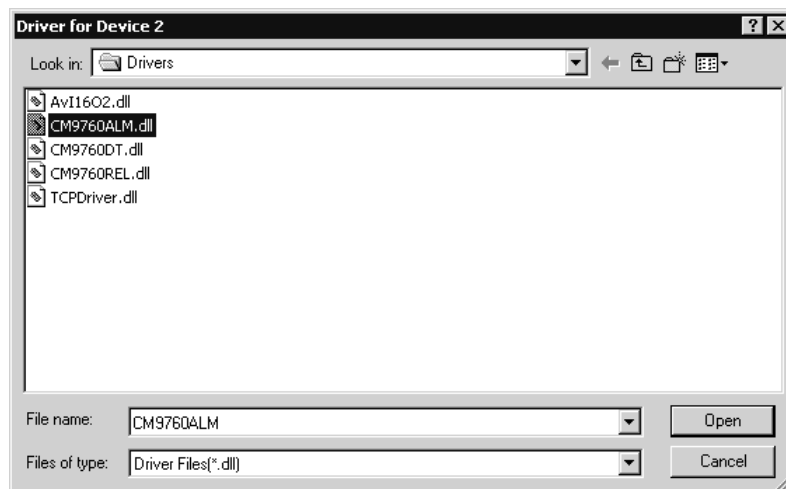

Figure 71. CM9760 Alarm Driver Dialog Box

3. Select CM9760ALM.dll.

- Click Open. The following dialog box appears.

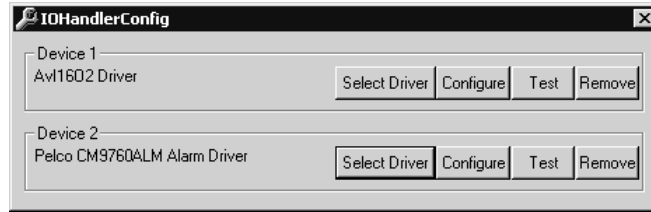

Figure 72. Device 2 Alarm Driver Dialog Box

- Click Configure. The following dialog box appears.

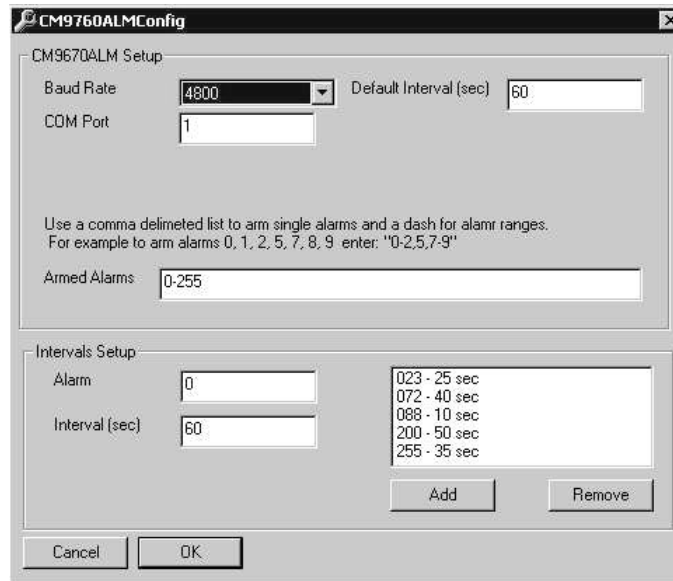

Figure 73. CM9760 Alarm Configuration Dialog Box

- Set the baud rate to 4800. The alarm unit should have this same baud rate.
- Enter 1 in the COM Port field. This is the port on the recorder that connects to the alarm unit. The system defaults to COM 2.
- Set the default interval. This is the time interval between two events and sets the same time interval for all of the alarm ports. The default is 60 seconds.
- Set the armed alarms. If the recorder is connected to two alarms units, you should have a range of 0-127 because each alarm has 64 ports. The default range is 0-63.
- Add intervals for specific alarms. Figure 73 shows five different intervals for five different alarms.
- Click OK.
- Click Test.
- Close the I/O Handler Configuration application.

I/O Manager for Alarm Unit

1. Go to Start > Programs > DX9000 Server > IO Manager Configuration. The Overview dialog box appears.

NOTE: You can also open the I/O Manager from the DX9000 Server Configuration Utility.

2. Click Next. The following dialog box appears.

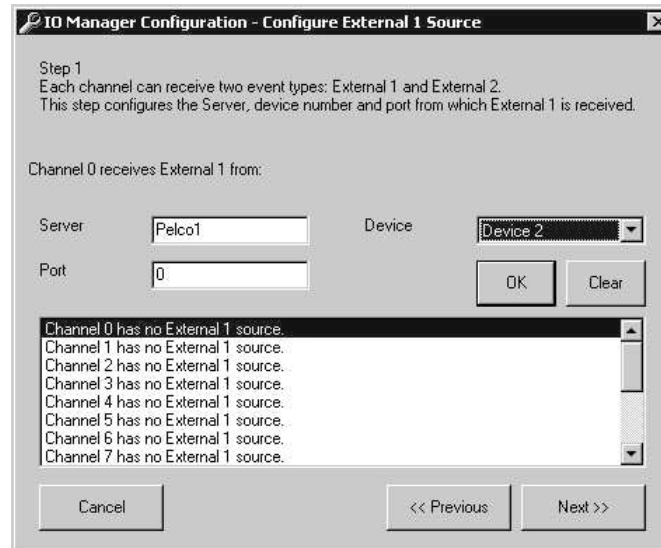

Figure 74. Dialog Box to Configure External 1 Source

3. Select the channel or channels that will receive events from the alarm unit.
4. Enter the server name that the alarm unit is connected to.
5. Select Device 2 as configured in the I/O Handler. This is the logical device number that the alarm unit is connected to.
6. Enter the alarm port number that the selected channel will receive events from. If several channels are selected, this number specifies the related port of the first channel. For example, if eight channels are selected, port 0 relates to channel 0 and so on.

7. Click OK. The information you entered appears on the screen, as shown in Figure 75.

NOTE: If you click Clear, all configurations for the selected channel are deleted.

IO Manager Configuration - Configure External 1 Source

Step 1
Each channel can receive two event types: External 1 and External 2.
This step configures the Server, device number and port from which External 1 is received.

Server: Device:

Port:

Channel 0 Receives External 1 from Server:PELC01 Device: 2 Port: 0.
Channel 1 has no External 1 source.
Channel 2 has no External 1 source.
Channel 3 has no External 1 source.
Channel 4 has no External 1 source.
Channel 5 has no External 1 source.
Channel 6 has no External 1 source.
Channel 7 has no External 1 source.

Figure 75. Sample Configuration for External 1 Source

8. Click Next. The following dialog box appears.

IO Manager Configuration - Configure External 2 Source

Step 2
Each channel can receive two event types: External 1 and External 2.
This step configures the Server, device number and port from which External 2 is received.

Server Device

Port

Channel 0 has no External 2 source.
Channel 2 has no External 2 source.
Channel 4 has no External 2 source.
Channel 6 has no External 2 source.

Figure 76. Dialog Box to Configure External 2 Source

9. Follow steps 3-7 if you want to define a second event.
10. Click Next. The Step 3 screen appears.

NOTE: The Step 3 and Step 4 screens are used for the relay unit configuration and the data translator configuration. You do not have to enter any information in these screens for the alarm unit configuration. To exit, click Next and then Finish. To configure a relay unit or data translator, refer to the sections on Connecting a Relay Unit or Connecting a Data Translator.

CONNECTING A RELAY UNIT

To connect a CM9760-REL to a DX9100 recorder using RS-232 communication:

1. Connect a null modem cable from the relay unit's RS-232 port to the recorder's RS-232 port.
2. Set the DIP switches on the relay unit for RS-232 communication. Refer to the CM9760-REL Installation/Operation manual.

If using RS-422 communication:

1. Connect a cable from the relay unit's RJ-45 COM IN port to the recorder's RS-232 port via an RS-232 to RS-422 converter.
2. Set the DIP switches on the relay unit for RS-422 communication. Refer to the CM9760-REL Installation/Operation manual.

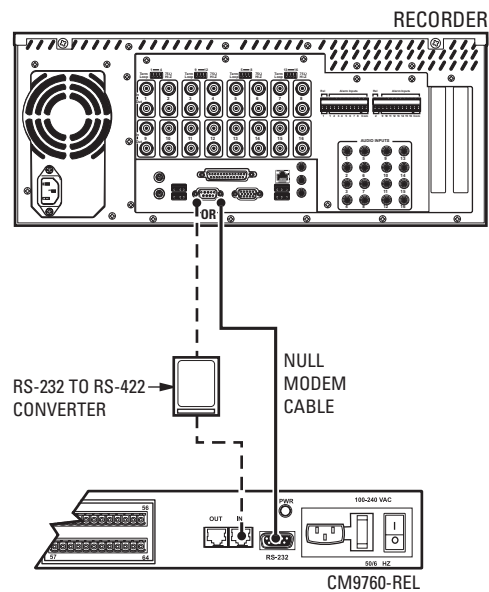

Figure 77. Connecting a CM9760-REL

RELAY UNIT CONFIGURATION

Follow these steps to configure a CM9760-REL relay unit.

NOTE: This programming is required only on the recorder that is physically connected to the CM9760-REL.

1. Go to Start > Programs > DX9000 Server > IO Handler Configuration. The following dialog box appears.

NOTE: You can also open the I/O Handler from the DX9000 Server Configuration Utility.

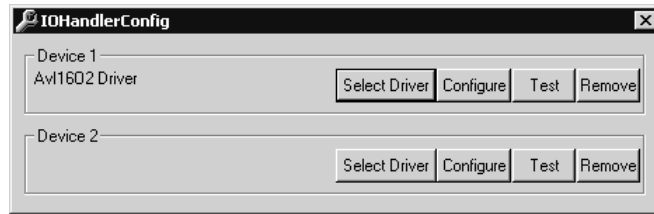

Figure 78. Relay I/O Handler Dialog Box

2. Click Select Driver on Device 2 to define the external device driver that is connected to the server. The following dialog box appears.



Figure 79. CM9760 Relay Driver Dialog Box

3. Select CM9760REL.dll.

- Click Open. The following dialog box appears.

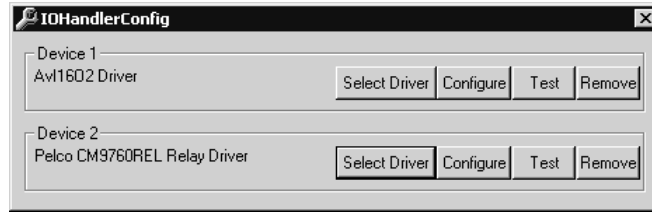

Figure 80. Device 1 Relay Driver Dialog Box

- Click Configure. The following dialog box appears.

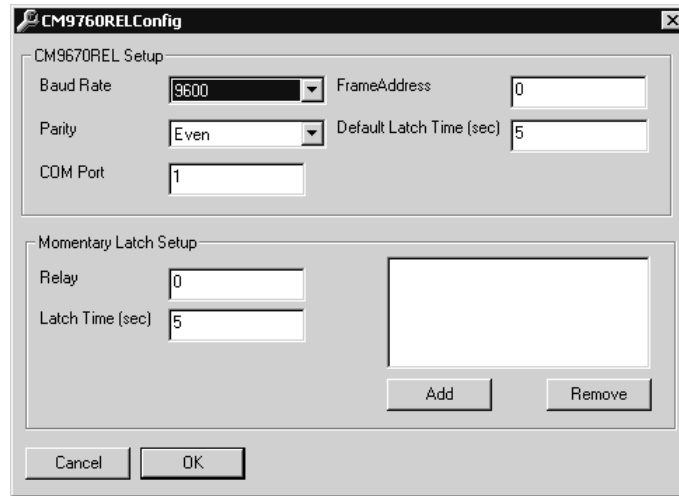

Figure 81. CM9760 Relay Configuration Dialog Box

- Set the baud rate to 9600 and the parity to Even. The relay unit should have these same settings.
- Enter 1 in the COM Port field. This is the port on the recorder that connects to the relay unit. The system defaults to COM 2.
- Set the default latch time. This time activates the relays on the relay unit and sets the same latch time for all of the relay ports. The default is 5 seconds.

NOTE: Frame Address is not used. The default value is 0.

- Add latch times for specific relays.
- Click OK.
- Click Test.
- Close the I/O Handler Configuration application.

I/O Manager for Relay Unit

The Step 3 and Step 4 screens in the I/O Manager Configuration are used to finish configuring a relay unit. Step 3 configures the recorder channels with the selected relay ports. Step 4 translates the event type from one type to another.

If you are already in the I/O Manager Configuration, follow the steps below.

If you are not in the I/O Manager Configuration, go to Start > Programs > DX9000 Server > IO Manager Configuration. In the I/O Manager Configuration, click Next three times to reach Step 3.

Refer to Figure 82 for the following steps.

1. Select the channel or channels that will send events to the relay unit.
2. Enter the server name that the relay unit is connected to.
3. Select Device 2 as configured in the I/O Handler. This is the logical device number that the relay unit is connected to.
4. Enter the relay port number that the selected channel will send events to. If several channels are selected, this number specifies the related port of the first channel. For example, if eight channels are selected, port 0 relates to channel 0 and so on.
5. Click OK. The information you entered appears on the screen.

NOTE: If you click Clear, all configurations for the selected channel are deleted.

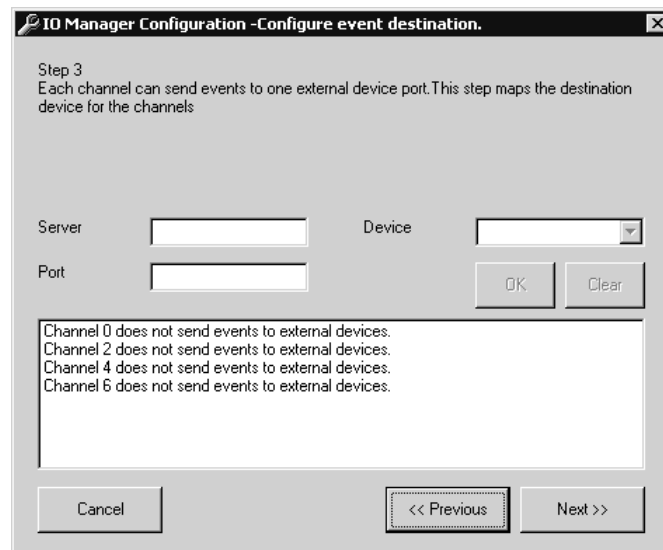

Figure 82. Relay Unit Step 3 Screen

6. Click Next. The following dialog box appears.

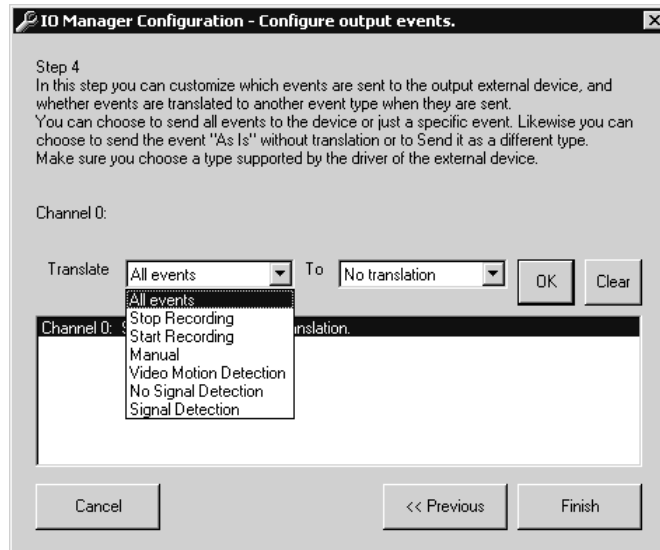

Figure 83. Dialog Box to Configure Relay Event Type

7. Select the event type to translate.

NOTE: Do not select Stop Recording and Start Recording. They are reserved for future use.

8. Select "No translation."
9. Click OK and then Finish.

CONNECTING A CM9760-CC1

To connect a CM9760-CC1 to a DX9100 recorder:

1. Connect a null modem cable from the CM9760-DT's COM A port to the recorder's RS-232 port.
2. Connect a null modem cable from the CM9760-DT's COM B port to COM 1 or COM 2 port on the CM9760-CC1.
3. Set the jumpers in the data translator for baud rate and parity. Refer to the CM9760-DT Installation/Operation manual.

NOTE: You can also connect the CM9760-DT to one of the CM9760-CC1 SERCOM ports for RS-422 communication.

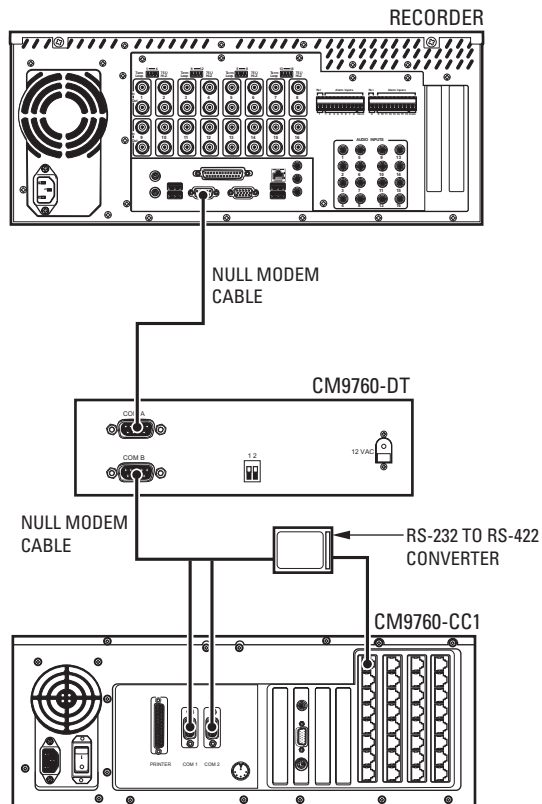

Figure 84. Connecting a CM9760-CC1

NOTE: You do not have to use a CM9760-DT if the CM9760-CC1 has software version 8.0. However, you must set the COM port on the CC1 as an internal data translator. Refer to the CM9760-CC1 Installation/Operation manual.

CONNECTING A CM6800

The CM6800 external alarm files must be set up correctly. You must set auto reset on the CM6800 to acknowledge alarms. Refer to the CM6800 Installation/Operation manual.

To connect a CM6800 to a DX9100 recorder:

1. Connect a null modem cable from the recorder's RS-232 port to COM 1 (RS-232) on the CM6800.
2. Set the RS-232 COM 1 port on the CM6800 as ASCII.
3. Set the baud rate on the CM6800 to match the baud rate on the recorder.

You can also connect to the additional ASCII ports on the CM6800 via an RS-232 to RS-422 converter. Refer to the CM6800 or CM6800E manuals for the correct ASCII ports.

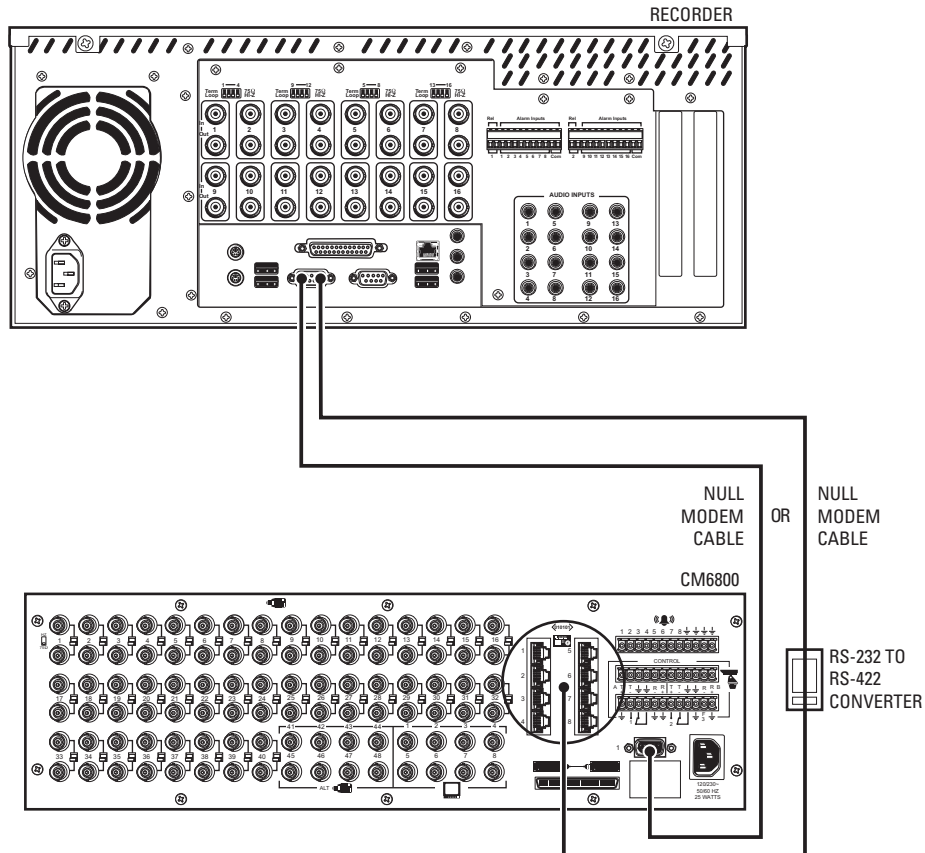

Figure 85. Connecting a CM6800

NOTE: You still must configure the data translator when using a CM6800. Refer to the *Data Translator Configuration* section.

DATA TRANSLATOR CONFIGURATION

Integrating a data translator serves two functions:

- Synchronize time between the DX9100 system and the matrix switcher.
- Send ASCII command strings to the matrix switcher (CM6800/CM9740/CM9760) for alarm conditions, such as sending alarms based on motion detection.

NOTE: This programming is required only on the recorder that is physically connected to the CM9760-DT.

Follow these steps to configure a data translator unit.

1. Go to Start > Programs > DX9000 Server > IO Handler Configuration. The following dialog box appears.

NOTE: You can also open the I/O Handler from the DX9000 Server Configuration Utility.

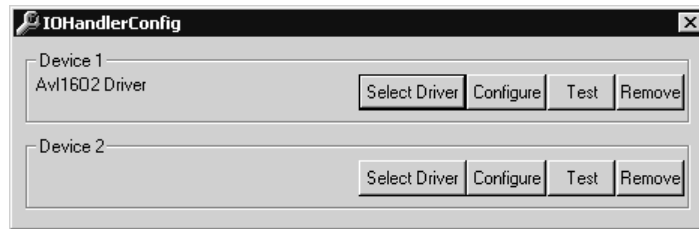

Figure 86. Data Translator I/O Handler Configuration Dialog Box

2. Click Select Driver on Device 2 to define the external device driver that is connected to the server. The following dialog box appears.



Figure 87. CM9760 Data Translator Driver Dialog Box

3. Select CM9760DT.dll.

- Click Open. The following dialog box appears.

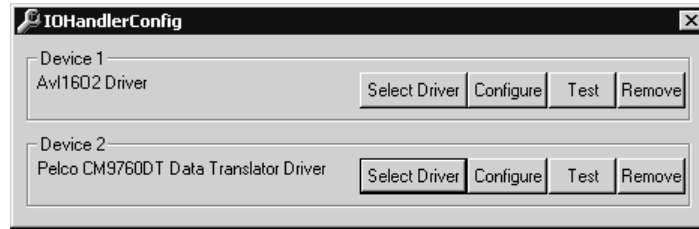

Figure 88. Device 1 Data Translator Driver Dialog Box

- Click Configure. The following dialog box appears.

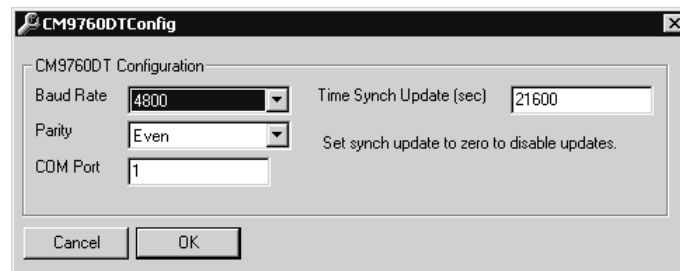

Figure 89. CM9760 Relay Configuration Dialog Box

- Set the baud rate to 4800 and the parity to Even. The data translator should have these same settings.
- Enter 1 in the COM Port field. This is the port on the recorder that connects to the data translator. The system defaults to COM 2.
- Set the Time Synch Update. This is the interval that the recorder updates the CM9760 clock. The default is 21,600 seconds (6 hours).
- Click OK.
- Click Test.
- Close the I/O Handler Configuration application.

I/O Manager for Data Translator

The Step 3 and Step 4 screens in the I/O Manager Configuration are used to configure the data translator. Step 3 configures the recorder channels with the selected data translator. Step 4 translates the event type from one type to another.

If you are already in the I/O Manager Configuration, follow the steps below.

If you are not in the I/O Manager Configuration, go to Start > Programs > DX9000 Server > IO Manager Configuration. In the I/O Manager Configuration, click Next three times to reach Step 3.

Refer to Figure 90 for the following steps.

1. Select the channel(s) you want to configure with the data translator.
2. Enter the server name that the data translator is connected to.
3. Select Device 2 as configured in the I/O Handler. This is the logical device number that the data translator is connected to.
4. In the Port field, enter the alarm number you want to activate in the matrix switcher.

NOTE: In the Port field, you can enter and configure only alarm numbers (physical and logical numbers in the CM9760 System Manager). If you select several channels, the port number you enter will be the starting port. That means the first port on the data translator is 1.

5. Click OK. The information you entered appears on the screen.

NOTE: If you click Clear, all configurations for the selected channel are deleted.

The screenshot shows a dialog box titled "IO Manager Configuration - Configure event destination." It is at Step 3, with instructions: "Each channel can send events to one external device port. This step maps the destination device for the channels." There are three input fields: "Server" (text), "Device" (dropdown menu), and "Port" (text). Below these are "OK" and "Clear" buttons. A list box contains the text: "Channel 0 does not send events to external devices.", "Channel 2 does not send events to external devices.", "Channel 4 does not send events to external devices.", and "Channel 6 does not send events to external devices." At the bottom are "Cancel", "<< Previous", and "Next >>" buttons.

Figure 90. Dialog Box to Configure Data Translator

6. Click Next. The following dialog box appears.

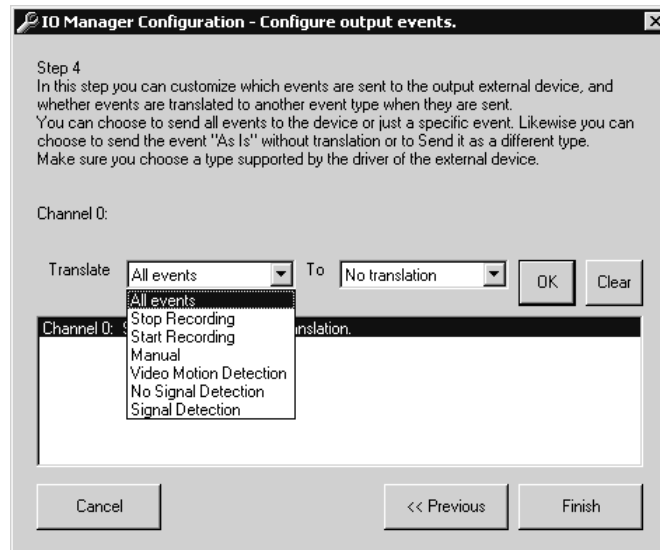

Figure 91. Dialog Box to Configure Data Translator Event Type

7. Select the event type to translate.
8. Select "No translation."
8. Click OK and then Finish.

DVR MANAGEMENT

If the DX9100 DVR system is connected to a matrix switcher, the operation of the system can be managed with the Server Alert Configuration Utility. If recorders are not recording or there is no communication with recorders, this utility sends alarms to the matrix switcher.

If the DX9100 system is connected to a Pelco matrix switcher, such as the CM9740 or CM9760, alarms are sent through a data translator. For non-Pelco matrix switchers, alarms are sent through a relay unit.

NOTE: Refer to the *Server State* section for more information on the Server State application.

DATA TRANSLATOR CONNECTIONS

The CM9760-DT should be used with Pelco matrix switchers, such as the CM9740 or CM9760.

1. Connect a null modem cable from the CM9760-DT's COM A port to the COM 1 or COM 2 port on the viewstation.
2. Connect a null modem cable from the CM9760-DT's COM B port to the COM 1 or COM 2 port on the CM9760-CC1.
3. Set the jumpers in the data translator for baud rate and parity. Refer to the CM9760-DT Installation/Operation manual.

NOTE: You can also connect the CM9760-DT to one of the CM9760-CC1 SERCOM ports for RS-422 communication.

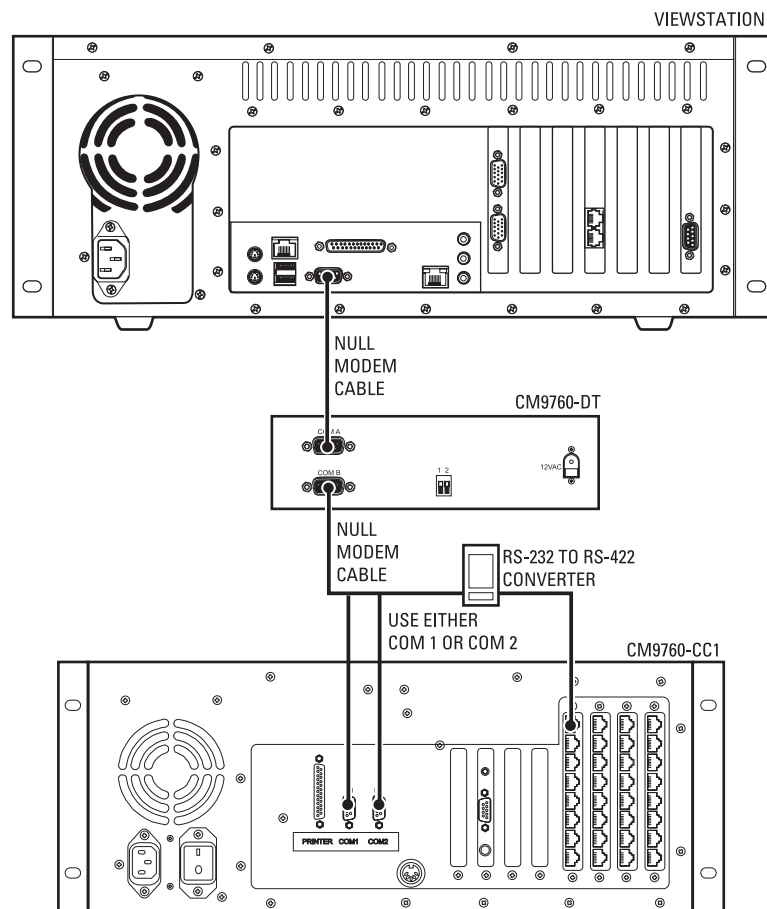

Figure 92. Connecting a CM9760-DT for DVR Management

CONFIGURING THE DATA TRANSLATOR

1. Go to Start > Programs > DX9000 Viewstation > Server Alert Configuration Utility. The following dialog box appears.

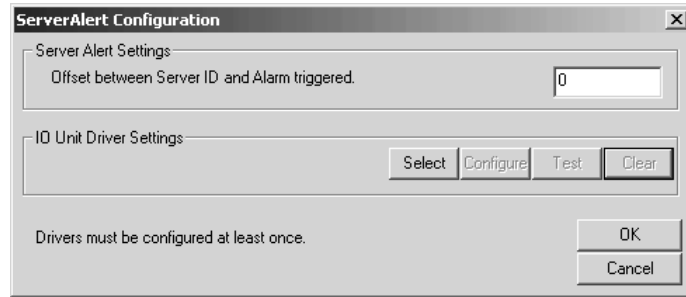

Figure 93. Data Translator Configuration Dialog Box

2. Click Select. The following dialog box appears.

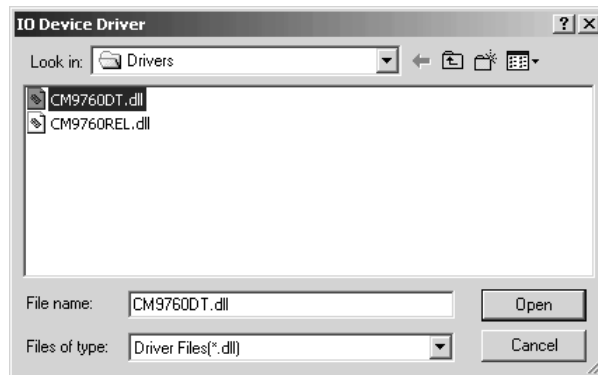

Figure 94. Data Translator Driver Dialog Box

3. Select CM9760DT.dll.
4. Click Open. The following dialog box appears.

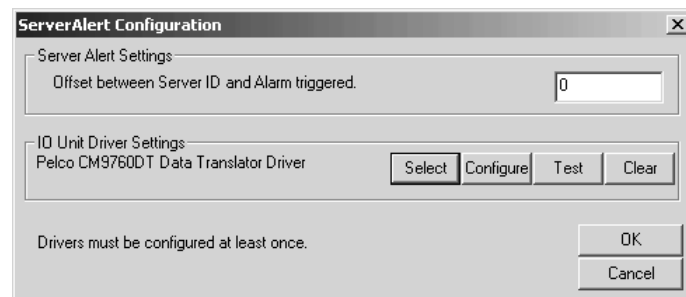

Figure 95. Data Translator Driver Settings Dialog Box

5. Enter the offset number in the Server Alert Settings box.

NOTE: The offset number must match the logical and physical numbers of the first alarm in the CM9760 System Manager.

6. Click Configure. The following dialog box appears.

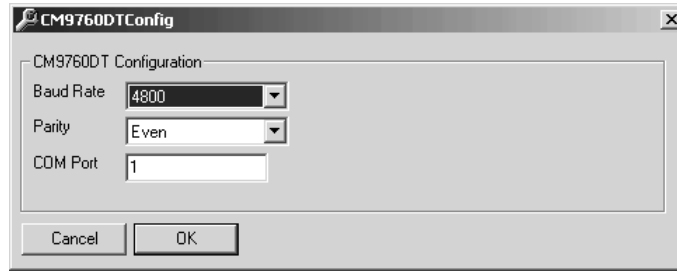

Figure 96. CM9760-DT Configuration

7. Set the baud rate to 4800 and the parity to Even. The data translator should have these same settings.
8. Enter the COM Port number. This is the port on the viewstation that connects to the data translator.
9. Click OK.
10. Click Test.
11. Click OK on the Server Alert Configuration screen to save your settings.

NOTE: Once you complete programming, refer to the CM9760-MGR manual for instructions on macro programming for the matrix switcher. Individual macro commands must be customized within the CM9760-MGR software to switch the appropriate group of cameras to the monitors connected to the standby DX9100.

RELAY UNIT CONNECTIONS

You can connect up to four relay units to each viewstation. The CM9760-REL should be used with third-party matrix switchers for hard-wired alarm integration.

To connect a CM9760-REL to a DX9100 viewstation using RS-232 communication:

1. Connect a null modem cable from the relay unit's RS-232 port to the viewstation's RS-232 port.
2. Set the DIP Switches on the relay unit for RS-232 communication. Refer to the CM9760-REL Installation/Operation manual.

If using RS-422 communication:

1. Connect a cable from the relay unit's RJ-45 COM IN port to the viewstation's COM 1 or COM 2 port via an RS-232 to RS-422 converter.
2. Set the DIP Switches on the relay unit for RS-422 communication. Refer to the CM9760-REL Installation/Operation manual.

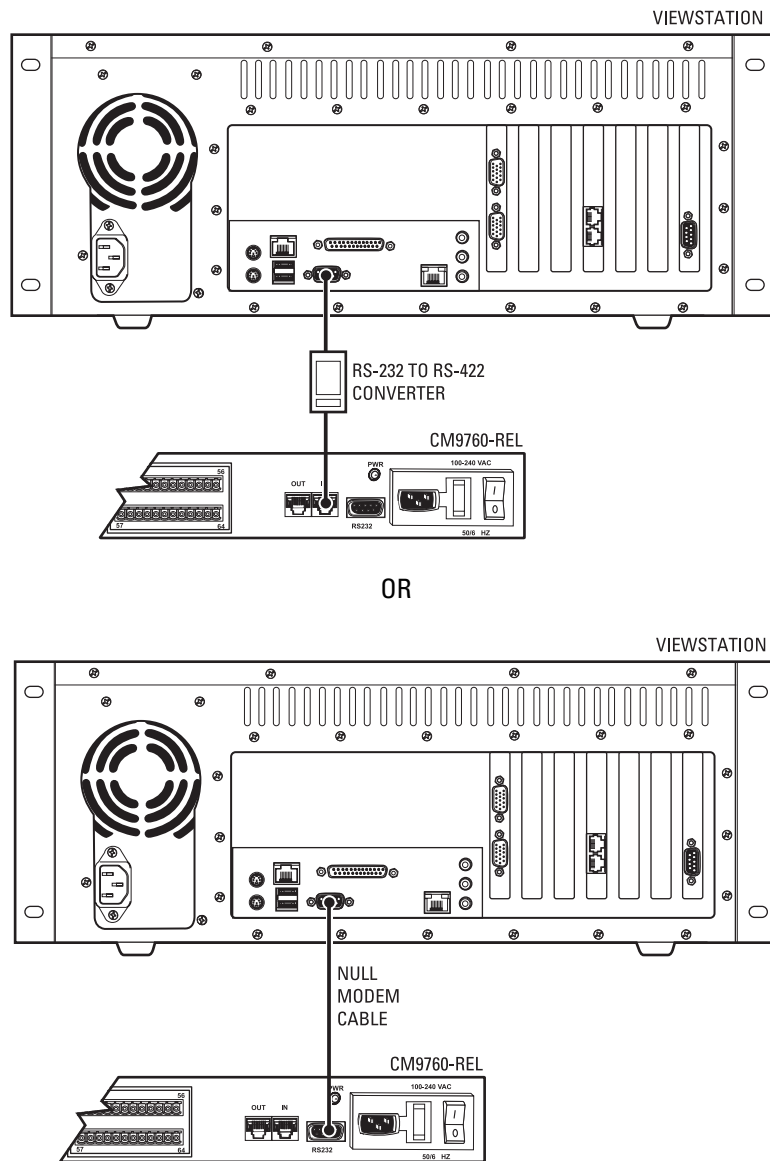

Figure 97. Connecting a CM9760-REL for DVR Management

CONFIGURING THE RELAY UNIT

1. Go to Start > Programs > DX9000 Viewstation > Server Alert Configuration Utility.

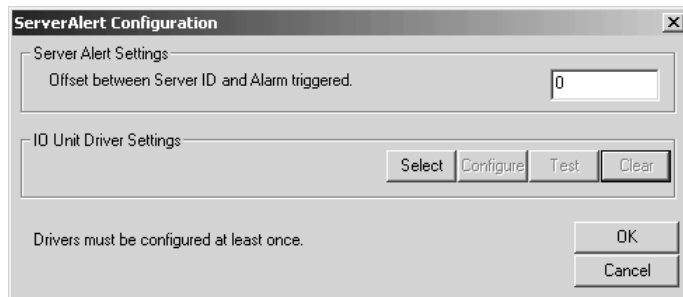

Figure 98. Relay Unit Configuration Dialog Box

2. Click Select. The following dialog box appears.

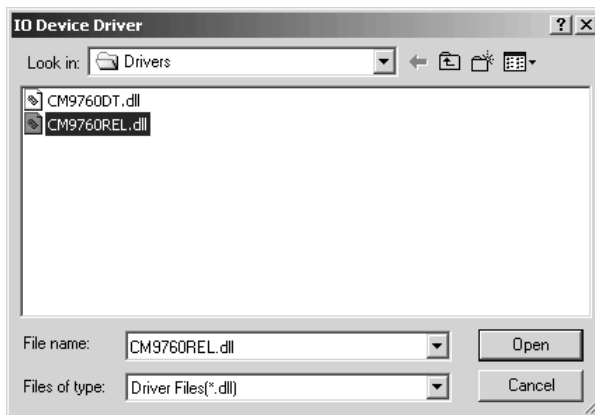

Figure 99. Relay Unit Driver Dialog Box

3. Select CM9760REL.dll.
4. Click Open. The following dialog box appears.

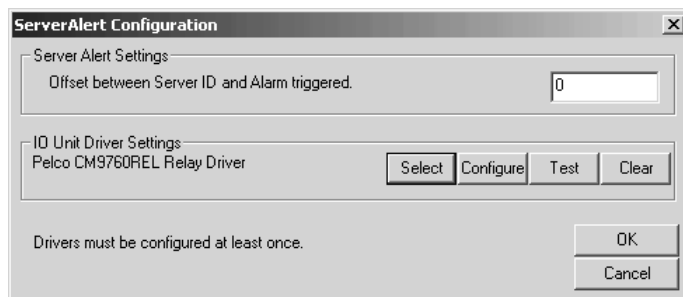

Figure 100. Relay Unit Driver Settings Dialog Box

5. Enter the logical relay number in the Server Alert Settings box.

- Click Configure. The following dialog box appears.

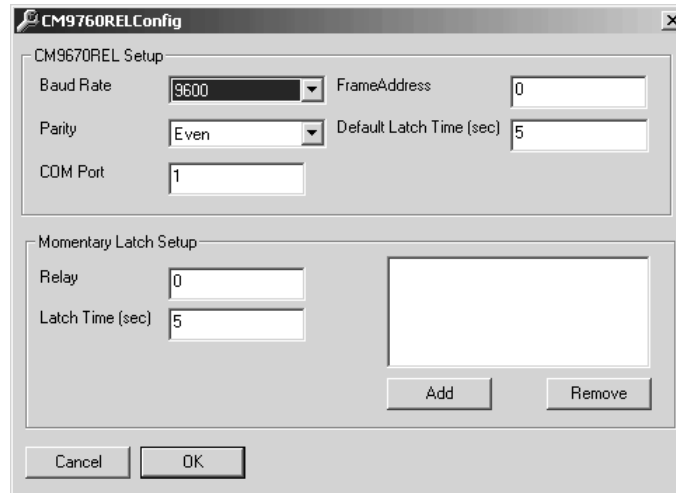

Figure 101. CM9760-REL Configuration Dialog Box

- Set the baud rate to 9600 and the parity to Even. The relay unit should have these same settings.
- Enter the COM Port number. This is the port on the viewstation that connects to the relay unit.
- Change the default latch time. This time activates the relays on the relay unit and sets the same latch time for all of the relay ports. The default is 5 seconds.

NOTE: Frame Address is not used. The default value is 0.

- Add latch times for specific relays.
- Click OK.
- Click Test.
- Click OK on the Server Alert Configuration screen.

FOREIGN LANGUAGE PROGRAMMING

This programming is applicable to the viewstation only. You can select only the following locations for use with the DX9100 system:

- English (United States)
- French (France)
- German (Germany)
- Italian (Italy)
- Polish
- Portuguese (Brazil)
- Russian
- Chinese (PRC)
- Spanish (Spain)

In the example below, the location is changed from the default English (United States) to Spanish (Spain).

1. Double-click My Computer > Control Panel > Regional Options. The following page appears.

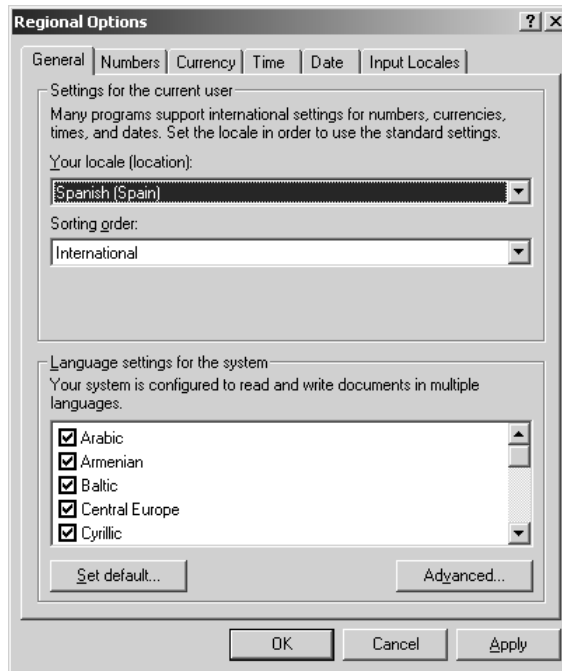

Figure 102. Change System Location

NOTE: All of the languages in the “Language settings for the system” section are selected.

2. Change the location to Spanish (Spain).

NOTE: Italian language users must click the Time tab and change the “Time separator” to a colon (:).

3. Click Apply.

4. Click Set Default. The following dialog box appears.

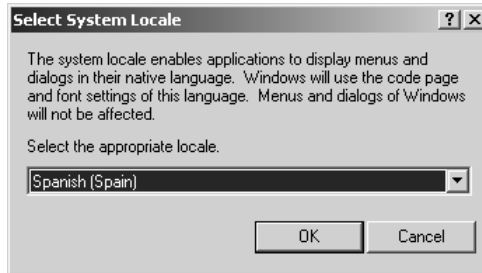

Figure 103. Select System Location

5. Select the same location.
6. Click OK.
7. Click Apply.
8. Click Yes to skip file copying and use existing files.
9. Click Yes to restart your computer.

The new settings take effect after the computer reboots. The DX9100 will support Spanish settings for numbers, currency, times, dates, menu strings, and text translations.

Follow these same steps to change the location back to English (United States) or to select another location.

SPECIFICATIONS

RECORDER

Electrical/Video

Input Voltage:	100-240 VAC, 50/60 Hz, autoranging. Reset feature enabled when power becomes unstable or interrupted.
Power Consumption:	235 W maximum
Signal System:	NTSC/PAL, autosensing
Operating System:	Windows 2000 and SP3 Service Pack
Recording Resolution	
NTSC (DX9100H)	352 x 240 (CIF) at 7.5 or 15 ips
PAL (DX9100H)	352 x 288 (CIF) at 6.25 or 12.5 ips
NTSC (DX9100F)	352 x 240 (CIF) at 7.5, 15, or 30 ips
	704 x 240 (2CIF) at 7.5 or 15 ips
PAL (DX9100F)	352 x 288 (CIF) at 6.25, 12.5, or 25 ips
	704 x 288 (2CIF) at 6.25 or 12.5 ips
Recording Speed	
NTSC (DX9100H)	7.5 or 15 ips
PAL (DX9100H)	6.25 or 12.5 ips
NTSC (DX9100F)	7.5, 15, or 30 ips
PAL (DX9100F)	6.25, 12.5, or 25 ips
HDD Configuration	RAID 0 array
Compression	MPEG-1
Video Inputs	16
Looping Video Outputs	16
Alarm Inputs	16
Relay Outputs	2
Remote Control	Full control via TCP/IP

Mechanical

Connectors	
BNC	Video inputs
BNC	Looping video outputs
6-pin mini-DIN	PS/2 mouse and keyboard
DB9	One RS-232 COM port available for external devices
DB15	Monitor port (VGA)
DB25	Printer port
RJ-45	Ethernet port (10/100BaseT)
	Ethernet port (10/100/1000BaseT)
Audio Inputs	Not used
Alarm Inputs	Removeable screw terminal
Relay Outputs	Removeable screw terminal
USB 2.0	Four ports available

General

Operating Temperature:	41° to 85°F (5° to 29°C)
Relative Humidity:	Maximum 80% noncondensing
Dimensions	
Desktop:	7.1 (H) x 17.0 (W) x 19.6 (D) inches (18.1 x 43.0 x 49.8 cm)
Rack-Mount:	7.0 (H) x 19.0 (W) x 19.6 (D) inches (17.8 x 48.3 x 49.8 cm)
Unit Weight:	52.2 lb (23.5 kg) maximum

VIEWSTATION

Electrical

Input Voltage:	100-240 VAC, 50/60 Hz, autoranging
Power Consumption:	90 W maximum
Operating System:	Windows 2000 and SP2 Service Pack

Mechanical

Connectors

6-pin mini-DIN	PS/2 mouse and keyboard
DB9	Two RS-232 COM ports available for external devices
DB15	SVGA monitor port (1024 x 768)
DB15	Composite monitor port (analog adapter provided)
DB25	Printer port
RJ-11	Internal modem (for use with pcAnywhere software only)
RJ-45	Ethernet port (10/100BaseT)
	Ethernet port (10/100/1000BaseT)
USB	Two ports available
RCA	Audio output (reserved for future use)

Hardware

Processor	Pentium® 4, 2.4 GHz
RAM	512 MB DDR
Video card	ATI Radeon™ 9600 PRO
Modem	V.90/56K
Drive	DVD-RW/CD-RW

General

Operating Temperature:	41° to 85°F (5° to 29°C)
Relative Humidity:	Maximum 80% noncondensing
Dimensions	
Desktop:	7.3 (H) x 17.0 (W) x 19.6 (D) inches (18.5 x 43.2 x 49.8 cm)
Rack-Mount:	7.0 (H) x 19.0 (W) x 19.6 (D) inches (17.8 x 48.3 x 49.8 cm)
Unit Weight:	33 lb (15.0 kg)

WARRANTY AND RETURN INFORMATION

WARRANTY

Pelco will repair or replace, without charge, any merchandise proved defective in material or workmanship for a period of one year after the date of shipment.
Exceptions to this warranty are as noted below:

- Five years on FT/FR8000 Series fiber optic products.
- Three years on Genex® Series products (multiplexers, server, and keyboard).
- Three years on Camclosure® and fixed camera models, except the CC3701H-2, CC3701H-2X, CC3751H-2, CC3651H-2X, MC3651H-2, and CC3651H-2X camera models, which have a five-year warranty.
- Two years on standard motorized or fixed focal length lenses.
- Two years on Legacy®, CM6700/CM6800/CM9700 Series matrix, and DF5/DF8 Series fixed dome products.
- Two years on Spectra®, Esprit®, ExSite™, and PS20 Scanners, including when used in continuous motion applications.
- Two years on Esprit® and WW5700 Series window wiper (excluding wiper blades).
- Eighteen months on DX Series digital video recorders, NVR300 Series network video recorders, and Endura™ Series distributed network-based video products.
- One year (except video heads) on video cassette recorders (VCRs). Video heads will be covered for a period of six months.
- Six months on all pan and tilts, scanners or preset lenses used in continuous motion applications (that is, preset scan, tour and auto scan modes).

Pelco will warrant all replacement parts and repairs for 90 days from the date of Pelco shipment. All goods requiring warranty repair shall be sent freight prepaid to Pelco, Clovis, California. Repairs made necessary by reason of misuse, alteration, normal wear, or accident are not covered under this warranty.

Pelco assumes no risk and shall be subject to no liability for damages or loss resulting from the specific use or application made of the Products. Pelco's liability for any claim, whether based on breach of contract, negligence, infringement of any rights of any party or product liability, relating to the Products shall not exceed the price paid by the Dealer to Pelco for such Products. In no event will Pelco be liable for any special, incidental or consequential damages (including loss of use, loss of profit and claims of third parties) however caused, whether by the negligence of Pelco or otherwise.

The above warranty provides the Dealer with specific legal rights. The Dealer may also have additional rights, which are subject to variation from state to state.

If a warranty repair is required, the Dealer must contact Pelco at (800) 289-9100 or (559) 292-1981 to obtain a Repair Authorization number (RA), and provide the following information:

1. Model and serial number
2. Date of shipment, P.O. number, Sales Order number, or Pelco invoice number
3. Details of the defect or problem

If there is a dispute regarding the warranty of a product which does not fall under the warranty conditions stated above, please include a written explanation with the product when returned. Method of return shipment shall be the same or equal to the method by which the item was received by Pelco.

RETURNS

In order to expedite parts returned to the factory for repair or credit, please call the factory at (800) 289-9100 or (559) 292-1981 to obtain an authorization number (CA number if returned for credit, and RA number if returned for repair).

All merchandise returned for credit may be subject to a 20% restocking and refurbishing charge. Goods returned for repair or credit should be clearly identified with the assigned CA or RA number and freight should be prepaid. Ship to the appropriate address below.

If you are located within the continental U.S., Alaska, Hawaii or Puerto Rico, send goods to:

Service Department
Pelco
3500 Pelco Way
Clovis, CA 93612-5699

If you are located outside the continental U.S., Alaska, Hawaii or Puerto Rico and are instructed to return goods to the USA, you may do one of the following:

If the goods are to be sent by a COURIER SERVICE, send the goods to:

Pelco
3500 Pelco Way
Clovis, CA 93612-5699 USA

If the goods are to be sent by a FREIGHT FORWARDER, send the goods to:

Pelco c/o Expeditors
473 Eccles Avenue
South San Francisco, CA 94080 USA
Phone: 650-737-1700
Fax: 650-737-0933

REVISION HISTORY

Manual #	Date	Comments
C636M	8/03	Original version.
C636M-A	10/03	Revised notes on pages 28 & 29. Revised Figures 22 and 60. Moved <i>Server State</i> section.
C636M-B	11/03	Added Caution to <i>Important Safeguards and Warnings</i> . Revised note on page 31.
C636M-C	3/04	Updated <i>Important Safety Instructions</i> . Updated <i>Database Backup and Repair</i> section. Added <i>Database Restoration</i> section. Updated <i>Warranty and Return Information</i> .
C636M-D	6/04	Revised manual to include DVD-RW/CD-RW drive and ATI Radeon 9600 PRO video card. Moved <i>Regulatory Notices</i> .
C636M-E	4/05	Added <i>Regulatory Notices</i> for the DX9100VSR. Updated <i>Warranty and Return Information</i> .

Pelco, the Pelco logo, Spectra, Genex, Esprit, Camclosure, and Legacy are registered trademarks of Pelco.
pcAnywhere is a trademark of Symantec.
Pentium is a registered trademark of Intel Corporation.

Windows is a registered trademark of Microsoft Corporation.
Radeon is a trademark of ATI Technologies Inc.
© Copyright 2005, Pelco. All rights reserved.



World Headquarters
3500 Pelco Way
Clovis, California 93612 USA

USA & Canada
Tel: 800/289-9100
Fax: 800/289-9150

International
Tel: 1-559/292-1981
Fax: 1-559/348-1120

www.pelco.com

ISO9001

United States | Canada | United Kingdom | The Netherlands | Singapore | Spain | Scandinavia | France | Middle East

Free Manuals Download Website

<http://myh66.com>

<http://usermanuals.us>

<http://www.somanuals.com>

<http://www.4manuals.cc>

<http://www.manual-lib.com>

<http://www.404manual.com>

<http://www.luxmanual.com>

<http://aubethermostatmanual.com>

Golf course search by state

<http://golfingnear.com>

Email search by domain

<http://emailbydomain.com>

Auto manuals search

<http://auto.somanuals.com>

TV manuals search

<http://tv.somanuals.com>