

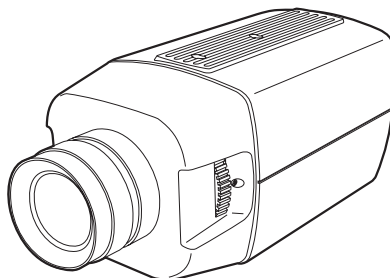

# Installation/Operation

## MC3610 and MC3710 Series Black-White Camera

**C2913M-F (08/05)**



Pelco Worldwide Headquarters • 3500 Pelco Way, Clovis, CA 93612-5699 USA • [www.pelco.com](http://www.pelco.com)  
USA & Canada: Tel 800/289-9100 • FAX 800/289-9150  
International: Tel: 1-559/292-1981 • FAX 1-559/348-1120

® Pelco, the Pelco logo, Spectra, Genex, Legacy, Esprit and Camclosure are registered trademarks of Pelco.

™ Endura and ExSite are trademarks of Pelco

™ DLP is a trademark of Texas Instruments, Inc.

™ SuperHAD CCD is a trademark of the Sony Corporation.

© Copyright 2005, Pelco. All rights reserved.

## CONTENTS

IMPORTANT SAFETY INSTRUCTIONS .....	4
REGULATORY NOTICES .....	5
DESCRIPTION .....	5
Models .....	5
CAMERA LAYOUT .....	6
INSTALLATION .....	6
Lens Mounting .....	6
Camera Mounting .....	7
CONNECTIONS .....	7
Video Connections .....	7
Power Connections .....	8
Genlock Connection (MC3710H Series Only) .....	10
RJ45-10 Connections .....	11
Service Connection .....	12
CAMERA SETUP .....	13
Lens Setup and Focus Procedures .....	13
Back Focus Adjustment .....	14
Switch Settings .....	15
Camera Synchronization .....	17
SPECIFICATIONS .....	18
WARRANTY AND RETURN INFORMATION .....	22

## LIST OF ILLUSTRATIONS

1	Camera Layout .....	6
2	AID/AIV Lens Connector .....	6
3	Camera Mounting .....	7
4	Genlock Daisy-chain Connection .....	10
5	RJ45-10 Connector .....	11
6	Service Connector .....	12
7	AGC and ESC Switch Settings .....	13
8	Back Focus Adjustment .....	14
9	Switch Settings .....	15

## LIST OF TABLES

A	Video Coaxial Cable Requirements .....	7
B	Wiring Distances for 5 VA Cameras (24 VAC/12 VDC) .....	9
C	RJ45-10 Pinouts .....	11

# IMPORTANT SAFETY INSTRUCTIONS

1. Read these instructions.
2. Keep these instructions.
3. Heed all warnings.
4. Follow all instructions.
5. Do not use this apparatus near water.
6. Clean only with dry cloth.
7. Do not block any ventilation openings. Install in accordance with the manufacturer's instructions.
8. Do not install near any heat sources such as radiators, heat registers, stoves, or other apparatus (including amplifiers) that produce heat.
9. Protect the power cord from being walked on or pinched particularly at plugs, convenience receptacles, and the point where they exit from the apparatus.
10. Only use attachments/accessories specified by the manufacturer.
11. Use only with the cart, stand, tripod, bracket, or table specified by the manufacturer, or sold with the apparatus. When a cart is used, use caution when moving the cart/apparatus combination to avoid injury from tip-over. 
12. Refer all servicing to qualified service personnel. Servicing is required when the apparatus has been damaged in any way, such as when the power supply cord or plug is damaged, liquid has been spilled or objects have fallen into the apparatus, the apparatus has been exposed to rain or moisture, the apparatus does not operate normally, or the apparatus has been dropped.
13. Apparatus shall not be exposed to dripping or splashing, and no objects filled with liquids, such as vases, shall be placed on the apparatus.
14. **WARNING:** To reduce the risk of fire or electric shock, do not expose this apparatus to rain or moisture.
15. Installation should be done only by qualified service personnel and conform to all local codes.
16. Unless the unit is specifically marked as a NEMA Type 3, 3R, 3S, 4, 4X, 6, or 6P enclosure, it is designed for indoor use only and it must not be installed where exposed to rain and moisture.
17. Use only installation methods and materials capable of supporting four times the maximum specified load.
18. **CAUTION:** These servicing instructions are for use by qualified personnel only. To reduce the risk of shock, do not perform any servicing other than that contained in the operating instructions unless you are qualified to do so.
19. Only use replacement parts recommended by Pelco.
20. Only power 12 VDC/24 VAC cameras from a UL Listed Class 2 power supply.
21. For outdoor use, an appropriate protective housing conforming to IP65 or better must be used. For UL, a UL Listed enclosure suitable for the application must be used.
22. DD/AI Lens Connector  
The maximum load for a direct drive lens must not exceed 25 mA  
The maximum load for an auto iris lens must not exceed 50 mA.



This symbol indicates that dangerous voltage constituting a risk of electric shock is present within this unit.



This symbol indicates that there are important operating and maintenance instructions in the literature accompanying this unit.

## CAUTION:

RISK OF ELECTRIC SHOCK.  
DO NOT OPEN

Please thoroughly familiarize yourself with the information in this manual prior to installation and operation.

## REGULATORY NOTICES

This device complies with Part 15 of the FCC Rules. Operation is subject to the following two conditions: (1) this device may not cause harmful interference, and (2) this device must accept any interference received, including interference that may cause undesired operation.

### RADIO AND TELEVISION INTERFERENCE

**MC3610H-6, MC3610H-6X, MC3610H-7, MC3710S-6, MC3710S-6X, MC3710S-7, MC3710H-6, MC3710H-6X and MC3710H-7 models:**

This equipment has been tested and found to comply with the limits of a Class B digital device, pursuant to Part 15 of the FCC Rules. These limits are designed to provide reasonable protection against harmful interference in a residential installation. This equipment generates, uses, and can radiate radio frequency energy and, if not installed and used in accordance with the instructions, may cause harmful interference to radio communications. However there is no guarantee that the interference will not occur in a particular installation. If this equipment does cause harmful interference to radio or television reception, which can be determined by turning the equipment off and on, the user is encouraged to try to correct the interference by one or more of the following measures:

- Reorient or relocate the receiving antenna.
- Increase the separation between the equipment and the receiver.
- Connect the equipment into an outlet on a circuit different from that to which the receiver is connected.
- Consult the dealer or an experienced radio/TV technician for help.

You may also find helpful the following booklet, prepared by the FCC: "How to Identify and Resolve Radio-TV Interference Problems." This booklet is available from the U.S. Government Printing Office, Washington D.C. 20402.

This Class B digital apparatus complies with Canadian ICES-003.

Cet appareil numérique de la classe B est conforme à la norme NMB-003 du Canada.

## DESCRIPTION

MC3610 and MC3710 Series cameras are black-white video cameras with a 1/3-inch CCD imager. All cameras have a direct drive/auto iris lens connector and adjustable back focus, and they accept C and CS lenses.

### Models

MC3610H-6 High resolution (570 TV lines), Exview HAD™ CCD, 0.04 lux at F1.2, EIA, 12 VDC/24 VAC  
MC3610H-6X High resolution (570 TV lines), Exview HAD™ CCD, 0.04 lux at F1.2, CCIR, 12 VDC/24 VAC  
MC3610H-7 High resolution (570 TV lines), Exview HAD™ CCD, 0.04 lux at F1.2, EIA, 110-240 VAC  
MC3610H-7X High resolution (570 TV lines), Exview HAD™ CCD, 0.04 lux at F1.2, CCIR, 110-240 VAC  
MC3710S-6 Standard resolution (380 TV lines), SuperHAD™ CCD, 0.06 lux at F1.2, EIA, 12 VDC/24 VAC  
MC3710S-6X Standard resolution (380 TV lines), SuperHAD™ CCD, 0.06 lux at F1.2, CCIR, 12 VDC/24 VAC  
MC3710S-7 Standard resolution (380 TV lines), SuperHAD™ CCD, 0.06 lux at F1.2, EIA, 110-240 VAC  
MC3710S-7X Standard resolution (380 TV lines), SuperHAD™ CCD, 0.06 lux at F1.2, CCIR, 110-240 VAC  
MC3710H-6 High resolution (570 TV lines), SuperHAD™ CCD, 0.07 lux at F1.2, EIA, Genlock, 12 VDC/24 VAC  
MC3710H-6X High resolution (570 TV lines), SuperHAD™ CCD, 0.07 lux at F1.2, CCIR, Genlock, 12 VDC/24 VAC  
MC3710H-7 High resolution (570 TV lines), SuperHAD™ CCD, 0.07 lux at F1.2, EIA, Genlock, 110-240 VAC  
MC3710H-7X High resolution (570 TV lines), SuperHAD™ CCD, 0.07 lux at F1.2, CCIR, Genlock, 110-240 VAC

# CAMERA LAYOUT

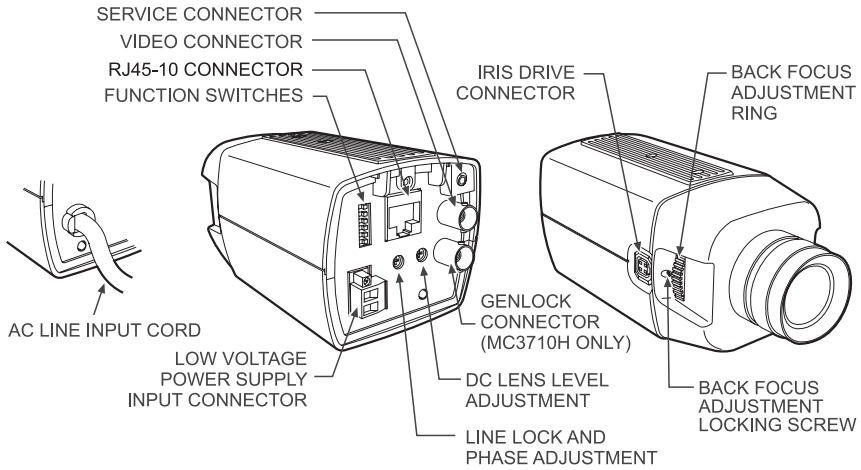

Figure 1. Camera Layout

## INSTALLATION

### Lens Mounting

MC3610 and MC3710 Series cameras can use fixed iris, manual iris, auto iris, or direct drive lenses. Cameras are factory-set for CS-mount lenses, but are easily adjusted for C-mount lenses.

1. **C-Mount Lens Only** - Loosen the two back focus locking screws. Rotate the back focus adjustment ring fully counterclockwise before installing the C-mount lens (refer to the section on *Back Focus Adjustment*).
2. Screw the lens onto the lens mount. Be careful to prevent dust from entering the space between the lens and the CCD element. If necessary, use clean, compressed air to remove any foreign matter.
3. **Auto Iris Lens Only** - Connect the auto iris lens to the four-pin iris drive connector located on the side of the camera. Pin connections for the iris drive connector are as follows.

Camera Connector

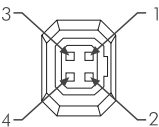

PIN	DC (AID) AUTO IRIS LENS	VIDEO (AIV) AUTO IRIS LENS
1	Control coil positive (+)	Not used
2	Control coil negative (-)	Lens positive supply
3	Drive coil negative (-)	Ground
4	Drive coil positive (+)	Video drive signal

Figure 2. AID/AIV Lens Connector

Maximum load:

50 mA video auto iris lens

25 mA direct drive lens



## Camera Mounting

Mounting points are provided on the top and bottom of the camera and are used to mount the camera on a bracket or tripod. They are designed to accept standard photographic mounting bolts (1/4-inch UNC-20). The mounting bracket must be capable of supporting the weight of the camera and its lens.

**NOTE:** Some installation codes dictate that the mounting bracket must be capable of supporting up to four times the combined weight of the camera and lens.

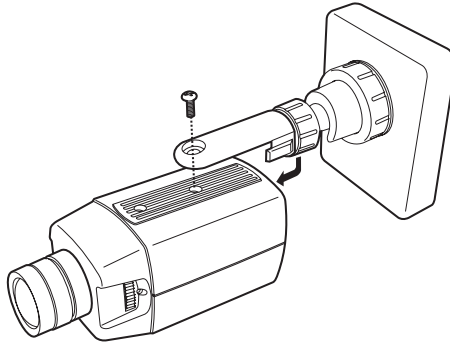

Figure 3. Camera Mounting

## CONNECTIONS

MC3610 and MC3710 Series cameras offer standard power and coax video connectors as well as an RJ45-10 connector that combines low voltage power and video (composite or UTP except MC3710S models which do not have a UTP output). These cameras also have a service connector allowing a video monitor to be connected locally to the camera using a composite video BNC cable.

### Video Connections

To obtain a video output, connect a video coaxial cable terminated with a 75Ω BNC connector to the BNC socket marked VIDEO OUT on the rear of the camera. Refer to Table A for the type of video coaxial cable to use.

Table A. Video Coaxial Cable Requirements

Cable Type*	Maximum Distance
RG59/U	750 ft (229 m)
RG6/U	1,000 ft (305 m)
RG11/U	1,500 ft (457 m)

- \* Minimum cable requirements:
  - 75 ohms impedance
  - All-copper center conductor
  - All-copper braided shield with 95% braid coverage

Another way to transmit video is over unshielded twisted pair wiring through the RJ45-10 connector. Refer to the *RJ45-10 Connections* section. When using the Genlock connector or outputting composite video through the BNC or RJ45-10, do not send UTP output to a passive UTP receiver. However it is acceptable to use an active UTP receiver for UTP output in combination with the other video connections.

## Power Connections

MC3610 and MC3710 Series cameras are available in AC high voltage and AC/DC low voltage types. The voltage required to operate the camera is clearly marked on the rear panel of the camera. The green POWER LED on the rear panel indicates that power is connected. Power low voltage cameras only from a UL Listed Class 2 isolated power supply. Power consumption is 4 watts.

### Mains Power Supply

Cameras that are intended to operate directly from the mains supply are fitted with a nondetachable power supply cord. The voltage of operation is 110 to 240 VAC at 50/60Hz.



**WARNING:** Refer to the wiring instruction label attached to the supply cord. For instances where the camera will be connected to a socket outlet, the camera should be connected to an easily accessible socket outlet near to the camera. For instances where the camera will be connected to the building installation, the building wiring should incorporate a readily accessible disconnect device, with a contact separation greater than three millimeters. This device should be fitted into the live conductor, if that is readily identifiable, or should be 2-pole. All installations shall be carried out in accordance with the locally applicable installation rules.



**WARNING:** Fuse (F1) should only be replaced by one of equivalent type and rating 1A (T) HRC 250V



**WARNING:** This camera is a Class 2 device and therefore does not have an earth connection in the power cord. The leakage current on these cameras is well within safe limits. However, it is advisable to connect the coaxial or RJ45-10 cable from the camera to the receiving equipment (such as a monitor or matrix) before applying power to the camera, so that this small leakage current has a low resistance path to earth.

### Low Voltage Power Supply

Cameras fitted with an automatic-switching low voltage power supply operate at 10.8 to 13.8 VDC (12 VDC -10% +15%) or 20.4 to 27.6 VAC (24 VAC  $\pm$ 15%) at 50/60Hz. Connections and polarity are indicated adjacent to the screw terminals on the rear panel.

Refer to Table B for the recommended wire gauge and wiring distances.



**WARNING:** When powering the camera via the screw terminals, ensure that the power connections to the RJ45-10 connector are not used, and that any connections to the RJ45-10 are not shorted together. The power supply must be a UL Listed Class 2 isolated type.



**CAUTION: AC Operation Only** - When wiring more than one camera to the same transformer, connect the same side of the transformer to the same terminal on all cameras. Failure to connect all of the cameras the same way will cause the cameras to be out of phase with each other and may produce a vertical roll when switching between cameras.



**Table B.** Wiring Distances for 5 VA Cameras (24 VAC/12 VDC)

The following are the recommended maximum distances for low voltage cameras. These distances are calculated with a 10 percent voltage drop. (Ten percent is generally the maximum allowable voltage drop for AC-powered devices.)

Wire Gauge		24 VAC		12 VDC	
AWG	mm <sup>2</sup>	Feet	Meters	Feet	Meters
24	0.25	224	68	56	17
22	0.35	356	108	89	27
20	0.5	567	172	141	42
18	1	902	274	225	68
16	1.5	1432	436	358	109
14	2.5	2285	696	571	174
12	4	3622	1103	905	275
10	6	5760	1755	1440	438

**EXAMPLE:** A camera that requires 5 VA and is installed 224 feet (68 m) from the transformer would require a minimum wire gauge of 24 AWG.

## Genlock Connection (MC3710H Series Only)

Genlock (short for generator lock) is a system that allows the synchronization of two or more cameras to a specific timing signal. The signal may come either from one of the cameras (a 1 V peak-to-peak video signal) or from an external generator (a standard sync plus blanking signal). Genlock synchronization allows you to switch the video source displayed on a monitor without noticeable jump or roll in the video.

There are two ways to use genlock as your synchronization source:

### Connect an individual camera.

1. Connect a video coaxial cable terminated with a 75  $\Omega$  BNC connector to the socket marked GENLOCK on the rear of the camera.
2. Connect the other end of the cable to the external sync generator or a 1 V peak-to-peak video signal from another camera.
3. Set the GL Termination DIP switch on the camera's back panel to 75  $\Omega$ .

### Create a daisy chain of cameras.

Two or more cameras can be genlocked together using 75  $\Omega$  BNC tee adapters and 75  $\Omega$  video coaxial cables as shown in figure 4. The GL Termination DIP switches for all of the cameras in the chain are set to **Hi Z** except for the final camera in the chain where it is set to 75  $\Omega$ .

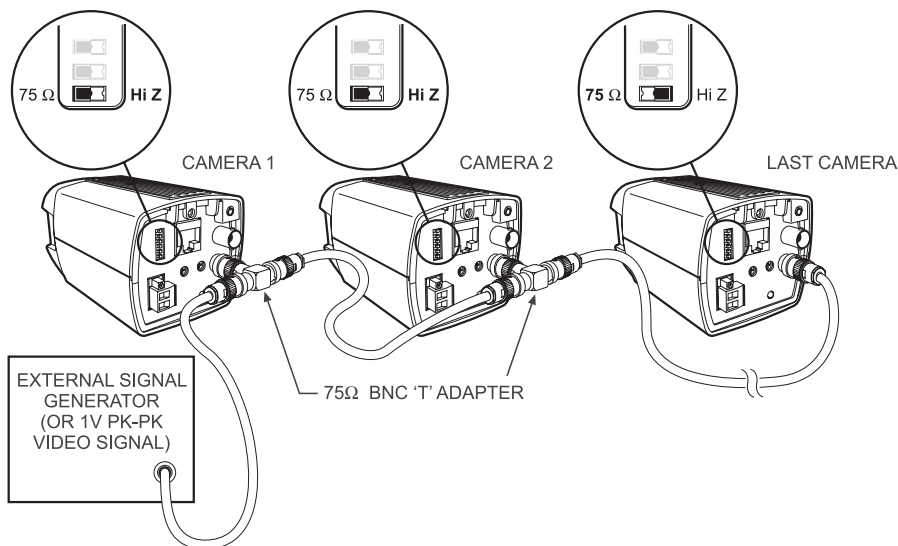

Figure 4. Genlock Daisy-chain Connection

**NOTE:** A signal connected to the genlock input automatically overrides all other synchronization settings.

## RJ45-10 Connections

The RJ45-10 connector allows video (composite and twisted pair except MC3710S models) and power connections to be made to the camera using a single Cat5-style cable.

**NOTE:** The PCM150 camera mount is designed for the MC3610 and MC3710 Series camera. It comes with preconfigured auxiliary connectors and cables as well as an easy-to-wire adapter plate.

Before installation, identify the RJ45-10 connector leads to be used. To create the connection you will need a Cat5 cable with the appropriate number of pairs and an 8-way or 10-way RJ45-10 connector. You will also need a crimping tool capable of cutting, stripping, and crimping RJ50 (10P10C) connectors.

Wire the cable and connectors according to Table C. (More information about wiring each pair of leads appears in the text below the table.) Then plug the auxiliary connector into the camera.

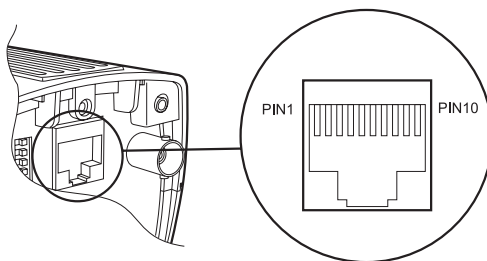

Figure 5. RJ45-10 Connector

Table C. RJ45-10 Pinouts

PINS		FUNCTION
8-WAY	10-WAY	
-	1	No connection
1	2	Composite video ground
2	3	Composite video
3	4	No connection
4	5	Twisted pair video output (-) †
5	6	Twisted pair video output (+) †
6	7	No connection
7	8	24 VAC *; 12 VDC (-)*
8	9	24 VAC *; 12 VDC (+)*
-	10	No connection

\* MC3610H-6, MC3610H-6X, MC3710S-6, MC3710S-6X, MC3710H-6 and MC3710H-6X models only

† All models except MC3710S

The following instructions apply to 10-way connectors. When using an 8-way connector, refer to table C.

### Composite Video Out

Pins 2 and 3 provide a composite video output signal.

**NOTE:** The RJ45-10 composite video out is only intended to be used to route the video signal to a break-out box where a conventional coaxial connection will be made.

To send composite video through the RJ45-10 connector:

1. Connect composite video out to pin 3.
2. Connect composite video ground to pin 2.

### Unshielded Twisted Pair (UTP)

Pins 5 and 6 allow video to be transmitted over unshielded twisted pair (UTP) wiring to equipment fitted with a suitable receiver (except MC3710S models). Ensure that connection polarity is observed in relation to the connected twisted pair receiver. To implement UTP, you must use 5-pair unshielded twisted cable, Cat5e, or an equivalent. The camera has a built-in transmitter for UTP. However, you must provide a UTP receiver. Your maximum cable distance depends on whether you install a passive or active receiver. When using the Genlock connector or outputting composite video through the BNC or RJ45-10, do not send UTP output to a passive UTP receiver. However it is acceptable to use an active UTP receiver for UTP output in combination with the other video connections.

To send UTP video through the RJ45-10 connector:

1. Connect UTP+ video output to pin 6.
2. Connect UTP- video output to pin 5.

### 24 VAC/12 VDC Power Connection

Pins 8 and 9 allow connection to a power supply of 10.8 to 13.8 VDC (12 VDC -10% +15%) or 20.4 to 27.6 VAC (24 VAC  $\pm$ 15%) at 50/60Hz. Correct connections and polarity must be observed.



**WARNING:** When powering the camera via the RJ45-10 connector, ensure that the power connections to the screw terminals on the rear of the camera are not used. The power supply must be a UL Listed Class 2 isolated type.

### Service Connection

The service connector allows a video monitor to be connected locally to the camera using a 2.5 mm plug to composite video BNC cable.

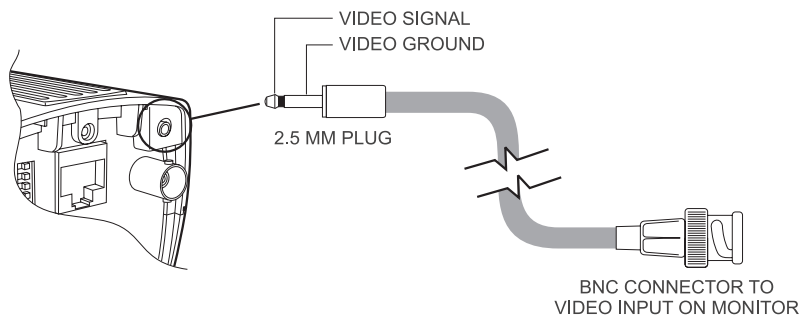

Figure 6. Service Connector

**NOTE:** Inserting the plug into the service connector disconnects video from the composite BNC connector on the rear panel of the camera.

## CAMERA SETUP

### Lens Setup and Focus Procedures

#### Video Drive or Direct Drive (DC) Auto Iris Lens

1. Set the ESC switch and AGC switch to OFF.
2. Adjust the lens for the optimum picture.  
**Video Drive.** Refer to the lens instructions and adjust the lens for the optimum picture (video output level of 1 V peak-to-peak).  
**Direct Drive.** Use an appropriate screwdriver to turn the lens level potentiometer (refer to Figure 1) fully clockwise. Next, slowly adjust the potentiometer counterclockwise until the optimum picture is obtained (video output level of 1 V peak-to-peak).
3. Set the AGC switch to ON.
4. To focus, fully open the iris by covering the lens with a suitable neutral density (ND\*) filter.
5. Select the scene to be viewed.
6. If the viewed scene is 6.5 feet (2 m) away or farther, set the lens focus to infinity (far).
7. Use the back focus adjustment ring (refer to the *Back Focus Adjustment* section) and focus on the selected scene.
8. Remove the ND filter and set the lens focus as required.

#### Fixed Lens

1. Set the ESC switch and AGC switch to ON.
2. To focus, set the lens focus to infinity (far) and view an image greater than 6.5 feet (2 m) away.
3. Focus the image with the back focus adjustment ring (refer to the *Back Focus Adjustment* section).
4. Set the lens focus as required.

#### Manual Iris Lens

1. Set the ESC switch and AGC switch to OFF.
2. To focus, open the iris fully and set the lens focus to infinity.
3. View an image greater than 6.5 feet (2 m) away.
4. Focus the image with the back focus adjustment ring (refer to the *Back Focus Adjustment* section).
5. Adjust the lens focus and set the iris for the best picture quality. The largest aperture gives the best light sensitivity, the smallest aperture the greatest depth of field.
6. Set the ESC switch and AGC switch to ON.

#### Zoom Lens

1. Set the lens focus to infinity (far) and fully open the iris by covering the lens with a suitable neutral density (ND\*) filter.
  2. Zoom out to the widest field of vision and view a distant object.
  3. Adjust the back focus adjustment ring until the object is in focus (refer to the *Back Focus Adjustment* section).
  4. Next zoom fully in and adjust the lens focus until the object is again focused.
- Repeat these steps until the full zoom range may be viewed with the minimum loss of focus.



Figure 7. AGC and ESC Switch Settings  
(White indicates switch position.)

**\*NOTE:** For best results outdoors use an ND3 (neutral density) filter.

## Back Focus Adjustment

The back focus adjustment is located at the front of the camera and is accessible from either side of the case.

To adjust the back focus:

1. Loosen the two back focus locking screws (one on each side).
2. Turn the back focus ring counterclockwise until the CCD sensor assembly is as far away from the back of the lens as possible.
3. Turn the back focus ring clockwise until focus is achieved.
4. When the back focus adjustment is satisfactory, tighten the locking screws. Do not over-turn or force the back focus adjustment ring.

**NOTE:** Always turn the back focus ring such that during focussing, the CCD sensor assembly is brought towards the back of the lens (that is, clockwise). If the point of best-focus is passed, repeat the back focus procedure from step 2.

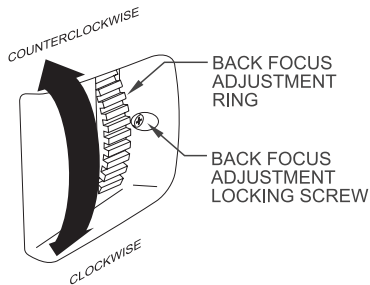

Figure 8. Back Focus Adjustment

## Switch Settings

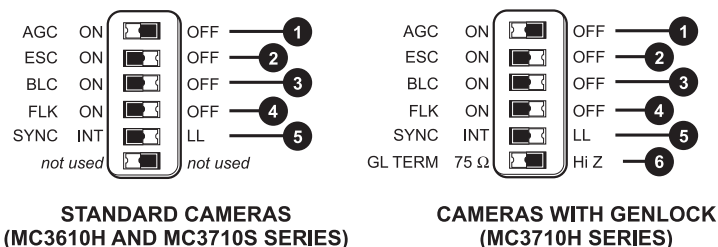

Figure 9. Switch Settings  
(White indicates default switch position.)

**NOTE:** Under most conditions, no setting of switches will be required. Please read the details of each switch before making any adjustments.

### AGC (Automatic Gain Control) - Switch Setting 1

Automatically adjusts the image to compensate for low levels of illumination. Choose between the following settings:

**ON** (Default setting) - Enables the AGC mode.

**OFF** - Disables the AGC mode.



### ESC (Electronic Shutter Control) - Switch Setting 2

The ESC feature compensates for an excessive light level by automatically adjusting shutter speed. Choose between the following settings:

**ON** - Enables the Electronic Shutter Control mode.

**OFF** (Default setting) - Disables the Electronic Shutter Control mode.



### BLC (Backlight Compensation) - Switch Setting 3

The BLC (Backlight Compensation) feature compensates for backlit scenes by enhancing objects in the center of the scene that would previously have been in silhouette. BLC will only function with a manual iris lens when the Electronic Shutter Control feature is switched on. For direct drive and auto iris lenses, BLC will still function even though the Electronic Shutter Control feature is switched off. Choose between the following settings:

**ON** - Enables the BLC mode.

**OFF** (Default setting) - Disables the BLC mode.



#### Flickerless - Switch Setting 4

The flickerless setting can reduce the flicker caused by certain lighting conditions. The Electronic Shutter Control must be off for the correct operation of the flickerless function.

Choose between the following settings:

**ON** - Enables the Flickerless mode.

**OFF** (Default setting) - Disables the Flickerless mode.

4  ON

4  OFF

#### INT/LL Synchronization Selection - Switch Setting 5

Line lock (LL) locks the frame rate to the power supply frequency. Eliminates vertical roll caused by multiple cameras connected to the same switching device. Each camera output is synchronized to the frequency of the power supply. Set the camera synchronization mode to one of the following:

**INT** - Disables line lock and cameras will synchronize internally. Regardless of the DIP switch setting, cameras switch to this mode when a DC power supply is detected.

**LL** (Default setting) - Line locks frame rate of cameras.

5  INT

5  LL

#### Genlock Termination (MC3710H Series only) - Switch Setting 6

In order for genlock synchronization to operate correctly, both ends of the genlock cable need to be terminated. Cameras may be connected in one of two ways:

- a) The genlock signal may be sent to each camera individually. In this case, the genlock termination DIP switch needs to be set to **75Ω**.
- b) The genlock signal may be sent to several cameras in a daisy-chain configuration, that is, one camera feeds the next and so on. In this case, the genlock termination DIP switch needs to be set to **Hi Z** for all of the cameras in the system except the last in the chain which should be set to **75Ω**.

6  75Ω

6  Hi Z



## Camera Synchronization

When using more than one camera power supply, a brief vertical roll may occur on the monitor when a camera view is switched. To eliminate this vertical roll, it is necessary for the cameras to be synchronized. If the cameras are connected to certain Pelco matrix products, the cameras will automatically lock to the pulse signal that is transmitted up-the-coax. If not, it will be necessary to synchronize manually.

**NOTE:** The genlock connection can be used to eliminate vertical roll problems on MC3710H cameras.

Cameras can be line locked or synchronized internally. Select the preferred method using the INT/LL DIP switch on the rear of the camera (refer to the *Switch Settings* section).

If a camera is connected to a DC power supply, the camera will switch to Internal (INT) mode, regardless of the DIP switch setting.

Internal (INT) mode should be selected when a noisy AC power supply is being used.

It may be necessary to have two people in communication when line locking cameras: one person at the camera and another person at the monitor to observe the vertical roll and the effect of any adjustments made at the camera.

To line lock the cameras, do the following:

1. Set the INT/LL DIP switch to LL.
2. Choose a reference camera to which all other cameras will be phased.
3. Select a camera and synchronize it to the reference camera, using the advance and retard buttons on the rear of the camera (refer to Figure 1) to adjust the point on the AC cycle at which the cameras trigger.
4. Each time an adjustment is made, switch back and forth between the camera you are adjusting and the reference camera. Repeat this process as many times as necessary until the roll between the cameras is no longer noticeable.
5. Adjust the phase of all other cameras by repeating steps 3 and 4. Always adjust to the reference camera selected in step 2.

**NOTE:** The preferred method for camera phase adjustment is to use a dual trace oscilloscope to align the vertical sync pulses of the reference camera to the selected camera or cameras.

## SPECIFICATIONS

### GENERAL

Imaging Device:	1/3-inch interline transfer CCD
Picture Elements	
MC3710H and MC3610H:	EIA 768 (H) x 494 (V); CCIR 752 (H) x 582 (V)
MC3710S:	EIA 510 (H) x 492 (V); CCIR 500 (H) x 582 (V)
Sensing Area:	6 mm diagonal
Scanning System	
EIA:	525 lines, 2:1 interlace
CCIR:	625 lines, 2:1 interlace
Synchronization System:	AC line lock/internal, Genlock (external, MC3710H Series only)
Horizontal Resolution	
MC3610H models:	570 TV lines
MC3710S models:	380 TV lines
MC3710H models:	570 TV lines
Iris Control:	Selectable on/off
Electronic Shutter Range	
EIA:	1/60-1/100,000 second
CCIR:	1/50-1/100,000 second
Auto Iris Lens Type:	DC/video drive (automatic sensing)
Minimum Illumination	
MC3610H models:	0.04 lux at F1.2, 40 IRE, AGC on
MC3710S models:	0.06 lux at F1.2, 40 IRE, AGC on
MC3710H models:	0.07 lux at F1.2, 40 IRE, AGC on
Signal-to-Noise Ratio:	>50 dB
Vertical Phase:	Adjustable +180° - 110°
Automatic Gain Control:	On/off switchable
Electronic Shutter Control:	On/off switchable
Backlight Compensation:	On/off switchable
Flickerless Mode:	On/off switchable
Internal Sync:	On/off switchable
Signal Processing:	Analog
Video Output:	1 Vp-p, 75 ohms
Gamma Correction:	0.45

### ELECTRICAL

Power Requirements	
Low Voltage Models:	24-28 VAC ± 10% or 12-36 VDC ± 10%
High Voltage Models:	110-240 VAC ± 10%
Power Consumption:	4 watts
Power Connector	
Low Voltage Models:	2-pin terminal strip, RJ45-10 connector
High Voltage Models:	Integral power cable
Video Connector:	Composite via BNC, composite and twisted-pair via RJ45-10 (except MC3710S models)
Service Connector:	2.5 mm jack for optional ICS090-SC service/monitor cable (compatible with any standard monitor BNC connector)
Lens Jack:	4-pin connector (miniature square)

## **MECHANICAL**

Lens Mount: C/CS mount (adjustable)  
Camera Mount: 1/4-inch UNC-20 screw, top or bottom of camera housing

## **ENVIRONMENTAL**

Operating Temperature: 14° to 122°F (-10° to 50°C)  
Storage Temperature: 14° to 158°F (-10° to 70°C)  
Operating Humidity: 20% to 80%, non-condensing  
Storage Humidity: 20% to 90%, non-condensing

## **PHYSICAL**

Dimensions: 5" L x 2.9" W x 2.6" H (12.8 x 7.2 x 6.7 cm)  
Weight (without lens): 0.8 lb (0.4 kg)

(Design and product specifications subject to change without notice).





## PRODUCT WARRANTY AND RETURN INFORMATION

### WARRANTY

Pelco will repair or replace, without charge, any merchandise proved defective in material or workmanship for a period of one year after the date of shipment.

Exceptions to this warranty are as noted below:

- Five years on FT/FR8000 Series fiber optic products.
- Three years on Genex® Series products (multiplexers, server, and keyboard).
- Three years on Camclosure® and fixed camera models, except the CC3701H-2, CC3701H-2X, CC3751H-2, CC3651H-2X, MC3651H-2, and MC3651H-2X camera models, which have a five-year warranty.
- Two years on standard motorized or fixed focal length lenses.
- Two years on Legacy®, CM6700/CM6800/CM9700 Series matrix, and DF5/DF8 Series fixed dome products.
- Two years on Spectra®, Esprit®, ExSite™, and PS20 Scanners, including when used in continuous motion applications.
- Two years on Esprit® and WW5700 series window wiper (excluding wiper blades).
- Two years (except lamp and color wheel) on Digital Light Processing (DLP™) displays. The lamp and color wheel will be covered for a period of 90 days. The air filter is not covered under warranty.
- Eighteen months on DX Series digital video recorders, NVR300 Series network video recorders, and Endura™ Series distributed network-based video products.
- One year (except video heads) on video cassette recorders (VCRs). Video heads will be covered for a period of six months.
- Six months on all pan and tilts, scanners or preset lenses used in continuous motion applications (that is, preset scan, tour and auto scan modes).

Pelco will warrant all replacement parts and repairs for 90 days from the date of Pelco shipment. All goods requiring warranty repair shall be sent freight prepaid to Pelco, Clovis, California. Repairs made necessary by reason of misuse, alteration, normal wear, or accident are not covered under this warranty.

Pelco assumes no risk and shall be subject to no liability for damages or loss resulting from the specific use or application made of the Products. Pelco's liability for any claim, whether based on breach of contract, negligence, infringement of any rights of any party or product liability, relating to the Products shall not exceed the price paid by the Dealer to Pelco for such Products. In no event will Pelco be liable for any special, incidental or consequential damages (including loss of use, loss of profit and claims of third parties) however caused, whether by the negligence of Pelco or otherwise.

The above warranty provides the Dealer with specific legal rights. The Dealer may also have additional rights, which are subject to variation from state to state.

If a warranty repair is required, the Dealer must contact Pelco at (800) 289-9100 or (559) 292-1981 to obtain a Repair Authorization number (RA), and provide the following information:

1. Model and serial number
2. Date of shipment, P.O. number, Sales Order number, or Pelco invoice number
3. Details of the defect or problem

If there is a dispute regarding the warranty of a product which does not fall under the warranty conditions stated above, please include a written explanation with the product when returned. Method of return shipment shall be the same or equal to the method by which the item was received by Pelco.

### RETURNS

In order to expedite parts returned to the factory for repair or credit, please call the factory at (800) 289-9100 or (559) 292-1981 to obtain an authorization number (CA number if returned for credit, and RA number if returned for repair).

All merchandise returned for credit may be subject to a 20% restocking and refurbishing charge.

Goods returned for repair or credit should be clearly identified with the assigned CA or RA number and freight should be prepaid. Ship to the appropriate address below.

If you are located within the continental U.S., Alaska, Hawaii or Puerto Rico, send goods to:

Service Department  
Pelco  
3500 Pelco Way  
Clovis, CA 93612-5699

If you are located outside the continental U.S., Alaska, Hawaii or Puerto Rico and are instructed to return goods to the USA, you may do one of the following:

If the goods are to be sent by a COURIER SERVICE, send the goods to:

Pelco  
3500 Pelco Way  
Clovis, CA 93612-5699 USA

If the goods are to be sent by a FREIGHT FORWARDER, send the goods to:

Pelco c/o Expeditors  
473 Eccles Avenue  
South San Francisco, CA 94080 USA  
Phone: 650-737-1700  
Fax: 650-737-0933



This equipment contains electrical or electronic components that must be recycled properly to comply with Directive 2002/96/EC of the European Union regarding the disposal of waste electrical and electronic equipment (WEEE). Contact your local dealer for procedures for recycling this equipment.

#### REVISION HISTORY

Manual #	Date	Comments
C2913M	05/04	Original version.
C2913M-A 0	7/04	Lens connector pin out changed.
C2913M-B	09/04	Clarified instructions for UTP use.
C2913M-C	11/04	Added UL warning for high-voltage models.
C2913M-D	11/04	Revised safety instructions.
C2913M-E	12/04	Revised back focus instructions and table C.
C2913M-F	08/05	WEEE directive added. Warranty and return information amended.



Worldwide Headquarters  
3500 Pelco Way  
Clovis, California 93612 USA

USA & Canada  
Tel: 800/289-9100  
Fax: 800/289-9150

International  
Tel: 1-559/292-1981  
Fax: 1-559/348-1120

**[www.pelco.com](http://www.pelco.com)**

**ISO9001**

United States | Canada | United Kingdom | The Netherlands | Singapore | Spain | Scandinavia | France | Middle East



## Free Manuals Download Website

<http://myh66.com>

<http://usermanuals.us>

<http://www.somanuals.com>

<http://www.4manuals.cc>

<http://www.manual-lib.com>

<http://www.404manual.com>

<http://www.luxmanual.com>

<http://aubethermostatmanual.com>

Golf course search by state

<http://golfingnear.com>

Email search by domain

<http://emailbydomain.com>

Auto manuals search

<http://auto.somanuals.com>

TV manuals search

<http://tv.somanuals.com>