

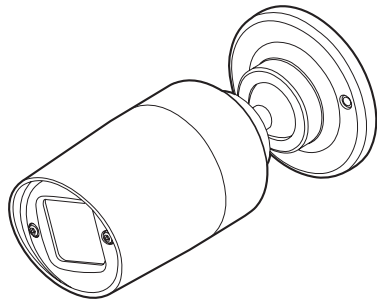

# Installation/Operation

## 300 Series Camclosure® Integrated Camera System

**C2408M-F (4/03)**



Pelco • 3500 Pelco Way • Clovis, CA 93612-5699 USA • [www.pelco.com](http://www.pelco.com)  
In North America and Canada: Tel (800) 289-9100 or FAX (800) 289-9150  
International Customers: Tel +1 (559) 292-1981 or FAX +1 (559) 348-1120

# CONTENTS

<u>Section</u>	<u>Page</u>
IMPORTANT SAFEGUARDS AND WARNINGS .....	3
DESCRIPTION .....	3
INSTALLATION .....	3
PREPARE WALL OR CEILING .....	4
CONNECT VIDEO AND POWER .....	5
ATTACH BASE .....	5
ADJUST CAMERA .....	6
ADJUSTMENTS (COLOR CAMERA ONLY) .....	6
VERTICAL PHASE (24 VAC OPERATION ONLY) .....	6
AUTO IRIS LEVEL ADJUSTMENT .....	7
SWITCH SETTINGS FOR VARIFOCAL LENS .....	7
SWITCH SETTINGS FOR FIXED FOCAL LENGTH LENS WITH AUTO IRIS .....	8
SWITCH SETTINGS FOR FIXED FOCAL LENGTH LENS WITHOUT AUTO IRIS .....	8
FOCUS ADJUSTMENT FOR FIXED FOCAL LENGTH LENS WITH AUTO IRIS .....	9
SPECIFICATIONS .....	10
REGULATORY NOTICES .....	10
PRODUCT WARRANTY AND RETURN INFORMATION .....	11

# IMPORTANT SAFEGUARDS AND WARNINGS

1. Read these instructions.
2. Keep these instructions.
3. Heed all warnings.
4. Follow all instructions.
5. Do not block any ventilation openings. Install in accordance with the manufacturer's instructions.
6. Do not install near any heat sources such as radiators, heat registers, stoves, or other apparatus (including amplifiers) that produce heat.
7. Only use attachments/accessories specified by the manufacturer.
8. Use only with the cart, stand, tripod, bracket, or table specified by the manufacturer, or sold with the apparatus. When a cart is used, use caution when moving the cart/apparatus combination to avoid injury from tip-over.
9. Refer all servicing to qualified service personnel. Servicing is required when the apparatus has been damaged in any way, such as power-supply cord or plug is damaged, liquid has been spilled or objects have fallen into the apparatus, the apparatus has been exposed to rain or moisture, does not operate normally, or has been dropped.
10. To reduce the risk of shock do not perform any servicing other than that contained on the operating instructions unless you are qualified to do so.
11. Installation should be done only by qualified personnel and conform to all local codes.
12. Unless the unit meets NEMA Type 3, 3R, 3S, 4, 4X, 6 or 6P standards, it is designed for indoor use only and must not be installed where exposed to rain and moisture.
13. Use only installation methods and materials capable of supporting four times the maximum specified load.
14. Use stainless steel hardware to fasten the enclosure to outdoor surfaces.
15. To prevent water leakage when installing an enclosure outdoors, apply sealant around the bolt holes between the enclosure and mounting surface and to the notch in the base of the enclosure.

## DESCRIPTION

The 300 Series Camclosure® integrated camera system is a track-light design that mounts to a wall or ceiling. The system incorporates a camera and lens package into a small, unobstructive, medium-security enclosure designed for areas subject to vandalism. The system is quick and easy to install in a variety of indoor or outdoor applications. It is ideal for residential, office, mall, hospital, school, parking garage, correction and detention, and other medium-security installations subject to vandalism.

## INSTALLATION

The following parts are supplied:

- 1 Camclosure integrated camera system
- 2 9-pin electrical connectors (12 VDC and 24 VAC)
- 1 Hollow screwdriver bit (1/8-inch)

# 1 Prepare Wall or Ceiling

Prepare the wall or ceiling according to one of the options shown below.

Mounting directly to wall or ceiling

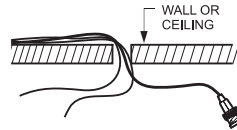

Mounting to a 4S electrical box with 404 plaster ring

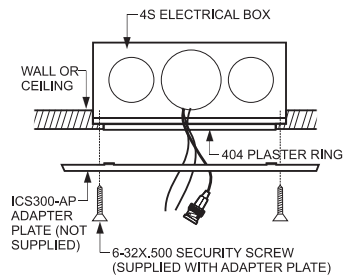

Mounting to ICS300-COND conduit adapter (not supplied)

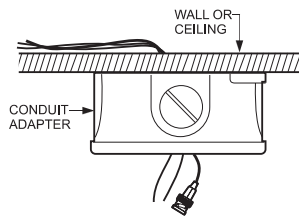

Mounting to a two-gang electrical box

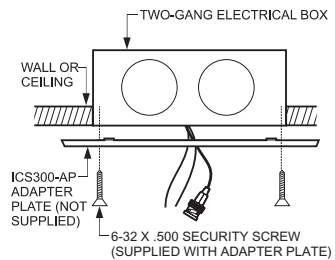

## 2 Connect Video and Power

1. Some indoor installations do not require a heater. If the installation does not require a heater, disconnect the heater wiring.
  - a. Remove the cover with the supplied 1/8-inch hollow screwdriver bit.
  - b. Remove the camera from the mounting bracket and unplug the four-pin heater connector in the base. The connector has orange, red, and black wires.
  - c. Reinstall the camera.
  - d. Reseat the O-ring on the cover and reinstall the cover.
2. Depending on the input voltage, wire either the 12 VDC or 24 VAC connector (supplied) to the input power wires. Plug the connector into the mating connector in the base.
3. Connect the video cable.



**WARNING:** To prevent damage to the camera or lens, the camera must be installed in the proper hole of the mounting bracket. If the camera is not installed in the correct hole, the window of the enclosure may be forced against the lens.

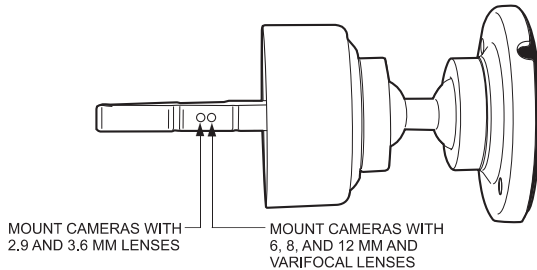

## 3 Attach Base

Release the base locking ring for access to the mounting holes.

Mounting hardware is not supplied if you attach the base directly to a wall or ceiling.

To attach the base to an adapter plate or conduit adapter, two 6-32 x 1.25-inch tamper-resistant screws are supplied with the adapters. Use the 1/8-inch hollow screwdriver bit supplied with the Camclosure.

**TIP** For waterproof installation, be sure the notch in the base is pointed down. Apply sealant around notch.

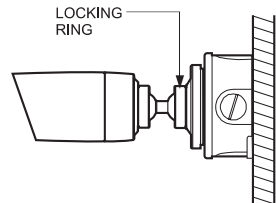
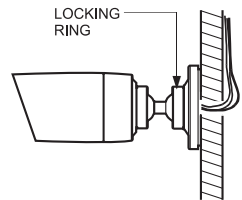
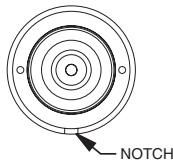

## 4 Adjust Camera

Turn on power to the camera and monitor. Release one or both locking rings, swivel the enclosure until the angle of the camera is correct, and tighten the locking rings.

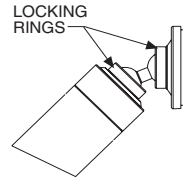

If you have a varifocal lens, remove the cover with the supplied 1/8-inch hollow screwdriver bit. Loosen the focal length and focus locking screws. Adjust according to scene detail. Retighten the screws. Reseat the O-ring on the cover and reinstall the cover.

### VARIFOCAL LENS

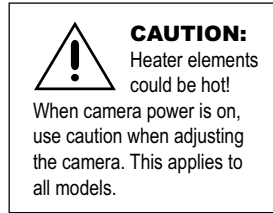
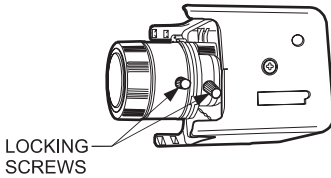

## ADJUSTMENTS (Color Camera Only)

If you have a color camera, it is set up at the factory and normally requires no adjustments. Sometimes, however, adjustments may be necessary.

1. Remove the cover using the supplied 1/8-inch hollow screwdriver bit.
2. Adjust the vertical phase, iris level, focus, or switch settings (refer to procedures below).
3. Reseat the O-ring on the cover and reinstall the cover.

## Vertical Phase (24 VAC Operation Only)

Adjustment is required if there is vertical roll when switching between two cameras.

1. Reverse the 24 VAC connections on one camera. If both cameras are connected to the same transformer, this should solve the problem.
2. If reversing the connections does not solve the problem, or if cameras are connected to different transformers, turn the adjustment screw (on the power board on the back of the camera assembly) on one camera (while switching as rapidly as possible between the two camera views) until the switching is clean and there is no vertical roll. If more than two cameras are out of synchronization with each other, choose one camera and synchronize all others to it.

### FIXED LENS

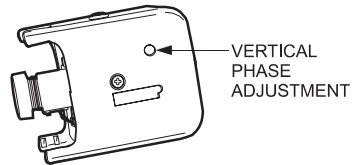

### VARIFOCAL LENS

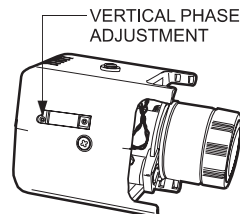

# Auto Iris Level Adjustment

If you have a varifocal lens or fixed focal length lens with an auto iris, you can adjust the iris level setting to increase or decrease brightness.

VARIFOCAL LENS

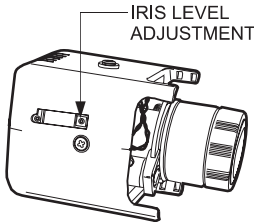

FIXED LENS

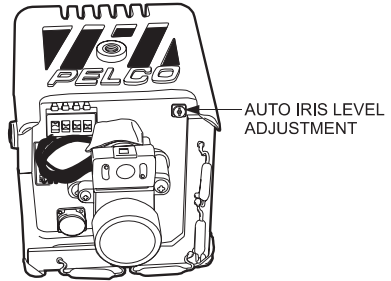

## Switch Settings for Varifocal Lens

The high resolution camera with varifocal lens and auto iris is configured at the factory for optimal performance in lighting conditions where auto iris is required. It is also configured with the shutter speed set at 1/60 (NTSC) or 1/50 (PAL) and AGC set at 6 dB of gain.

- |              |   |   |     |                            |
|--------------|---|---|-----|----------------------------|
| AE Functions | [ | 1 | AWB | Automatic white balance    |
|              |   | 2 | GAM | Gamma function             |
|              |   | 3 | AGC | Automatic gain control     |
|              |   | 4 | ESC | Electronic shutter control |
|              |   | 5 | BLC | Backlight compensation     |
|              |   | 6 | FL  | Flickerless                |
|              |   | 7 | AE  | Automatic exposure         |
|              |   | 8 |     | Not used                   |

FACTORY SETTINGS

1	2	3	4	5	6	7	8
■	■	■	■	■	■	□	■
□	□	□	□	□	■	□	□
OFF							

■ = SWITCH POSITION

### To enable automatic exposure

Turn on switch 7, and then turn on/off switch 4 for electronic shutter control, switch 5 for backlight compensation, and switch 6 for flickerless motion.

### To manually set and lock AWB

Place a white background in front of camera and turn off switch 1.

### For gamma correction

Switch to accurately reproduce scene brightness; when turned on,  $\gamma = 0.6$ , and when turned off,  $\gamma = 1.0$ .

### For gain control

Switch 3 On increases gain by 6 dB, and switch 3 Off increases gain by 18 dB.

### To enable auto iris and manually set shutter speed

Turn off switch 7; set switches 4, 5, and 6 for the desired shutter speed.

**CAUTION** Do not change the shutter speed unless you understand how changing the settings will affect the scene detail.

Shutter Speed	Switch Number and Position			
	7	6	5	4
1/60 (NTSC)	Off	On	On	On
1/50 (PAL)		On	On	On
1/100		Off	On	On
1/250		On	Off	On
1/500		Off	Off	On
1/1000		On	On	Off
1/2000		Off	On	Off
1/4000		On	Off	Off
1/10000		Off	Off	Off

## Switch Settings for Fixed Focal Length Lens with Auto Iris

Refer to the switch drawing. The switch is located next to the lens. Automatic backlight compensation (factory setting) is used under varying lighting conditions (such as outdoors) or fixed lighting conditions where there are no bright spots that darken other picture details. Manual backlight compensation is used in fixed lighting conditions to optimize the picture detail when there are bright spots.

ALC/ELC switch:	Always ALC
Y/DC switch:	Always DC
Auto backlight compensation:	BLC switch OFF ABL switch ON
Manual backlight compensation:	BLC switch ON ABL switch OFF

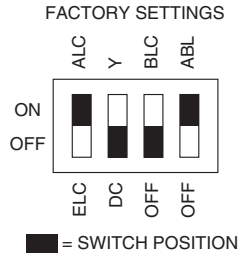

## Switch Settings for Fixed Focal Length Lens Without Auto Iris

Refer to the switch drawing. The switch is located next to the lens. Automatic backlight compensation (factory setting) is used under varying lighting conditions (such as outdoors) or fixed lighting conditions where there are no bright spots that darken other picture details. Manual backlight compensation is used in fixed lighting conditions to optimize the picture detail when there are bright spots.

ALC/ELC switch:	Always ELC
Y/DC switch:	Not used
Auto backlight compensation:	BLC switch OFF ABL switch ON
Manual backlight compensation:	BLC switch ON ABL switch OFF

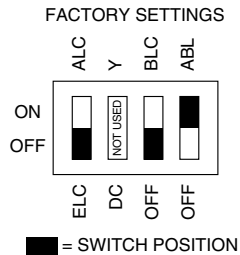



# Focus Adjustment for Fixed Focal Length Lens with Auto Iris

## CAUTION



Heater elements could be hot! When camera power is on, use caution when adjusting the camera.

To adjust the focus:

1. Loosen the locking screw on the bottom of the lens. To loosen the screw, it may be necessary to remove the heater board. Refer to the figure below and the accompanying steps.
2. Move the screw in the slot to bring the picture into focus.
3. Retighten the locking screw.
4. Replace the heater board if it was removed.
5. Reconnect the four-pin heater connector if it was unplugged.
6. Reinstall the camera if it was removed.

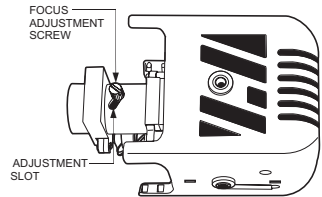

BOTTOM VIEW OF CAMERA WITH HEATER BOARD REMOVED

To remove the heater board (if the heater connector is unplugged already, go to step 4):

1. Remove the camera from the mounting bracket.
2. Disconnect the four-pin heater connector (red, orange, and black wiring) in the base.
3. Wait for the heater elements to cool if they are hot.
4. Apply pressure and press on the corner of the board.

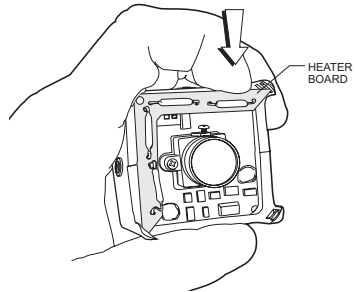

**WARNING:** To prevent damage to the camera or lens, the camera must be installed in the proper hole of the mounting bracket. If the camera is not installed in the correct hole, the window of the enclosure may be forced against the lens.

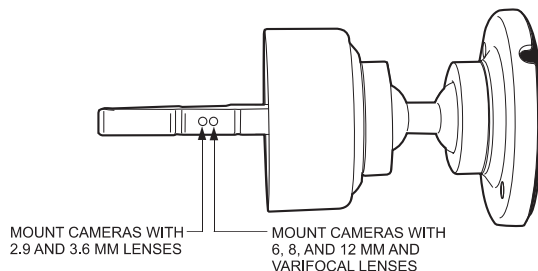

# SPECIFICATIONS

## Electrical

Input Voltage: 12 VDC or 24 VAC,  $\pm 10\%$   
Power  
Consumption: 13 watts or less  
Video  
Connector: BNC

Construction: Aluminum base and cover,  
steel camera mounting bracket  
Finish: Gray polyester powder coat  
Dimensions: 2.71 (diameter) x 7.79 (L) inches  
(6.88 x 19.79 cm)  
Environment: Low temperature, indoor/  
outdoor

## General

Pan/Tilt  
Adjustment: Manual; 180° pan; 180° tilt  
Rating: Meets NEMA Type 3R  
standards

Operating  
Temperature: -50° to 122°F (-46° to 50°C)  
De-ices to -10°F (-23°C)  
Weight: 1.45 lb (0.66 kg)  
Heater: Turns on at 50°F (10°C) and off  
at 80°F (27°C)

*(Design and product specifications subject to change without notice.)*

# Regulatory Notices

## FCC Class A (monochrome, EIA cameras only)

NOTE: This equipment has been tested and found to comply with the limits of a Class A digital device, pursuant to part 15 of the FCC rules. These limits are designed to provide reasonable protection against harmful interference when the equipment is operated in a commercial environment. This equipment generates, uses, and can radiate radio frequency energy and, if not installed and used in accordance with the instruction manual, may cause harmful interference to radio communications. Operation of this equipment in a residential area is likely to cause harmful interference in which case the user will be required to correct the interference at his own expense.

## FCC Class B (color, NTSC cameras only)

NOTE: This equipment has been tested and found to comply with the limits of a Class B digital device, pursuant to part 15 of the FCC rules. These limits are designed to provide reasonable protection against harmful interference in a residential installation. This equipment generates, uses, and can radiate radio frequency energy and, if not installed and used in accordance with the instructions, may cause harmful interference to radio communications. However there is no guarantee that the interference will not occur in a particular installation. If this equipment does cause harmful interference to radio or television reception, which can be determined by turning the equipment off and on, the user is encouraged to try to correct the interference by one or more of the following measures:

- Reorient or relocate the receiving antenna.
- Increase the separation between the equipment and the receiver.
- Connect the equipment into an outlet on a circuit different from that to which the receiver is connected.
- Consult the dealer or an experienced radio/TV technician for help.

## PRODUCT WARRANTY AND RETURN INFORMATION

### WARRANTY

Pelco will repair or replace, without charge, any merchandise proved defective in material or workmanship **for a period of one year** after the date of shipment.

Exceptions to this warranty are as noted below:

- Five years on FT/FR8000 Series fiber optic products.
- Three years on Genex® Series products (multiplexers, server, and keyboard).
- Three years on Camclosure® and fixed camera models, except the CC3701H-2, CC3701H-2X, CC3751H-2, CC3651H-2X, MC3651H-2, and MC3651H-2X camera models, which have a five-year warranty.
- Two years on standard motorized or fixed focal length lenses.
- Two years on Legacy®, CM6700/CM6800/CM9700 Series matrix, and DF5/DF8 Series fixed dome products.
- Two years on Spectra®, Esprit®, ExSite™, and PS20 scanners, including when used in continuous motion applications.
- Two years on Esprit® and WWW5700 Series window wiper (excluding wiper blades).
- Eighteen months on DX Series digital video recorders, NVR300 Series network video recorders, and Endura™ Series distributed network-based video products.
- One year (except video heads) on video cassette recorders (VCRs). Video heads will be covered for a period of six months.
- Six months on all pan and tilts, scanners or preset lenses used in continuous motion applications (that is, preset scan, tour and auto scan modes).

Pelco will warrant all replacement parts and repairs for 90 days from the date of Pelco shipment. All goods requiring warranty repair shall be sent freight prepaid to Pelco, Clovis, California. Repairs made necessary by reason of misuse, alteration, normal wear, or accident are not covered under this warranty.

Pelco assumes no risk and shall be subject to no liability for damages or loss resulting from the specific use or application made of the Products. Pelco's liability for any claim, whether based on breach of contract, negligence, infringement of any party or product liability, relating to the Products shall not exceed the price paid by the Dealer to Pelco for such Products. In no event will Pelco be liable for any special, incidental or consequential damages (including loss of use, loss of profit and claims of third parties) however caused, whether by the negligence of Pelco or otherwise.

The above warranty provides the Dealer with specific legal rights. The Dealer may also have additional rights, which are subject to variation from state to state.

If a warranty repair is required, the Dealer must contact Pelco at (800) 289-9100 or (559) 292-1981 to obtain a Repair Authorization number (RA), and provide the following information:

1. Model and serial number
2. Date of shipment, P.O. number, Sales Order number, or Pelco invoice number
3. Details of the defect or problem

If there is a dispute regarding the warranty of a product which does not fall under the warranty conditions stated above, please include a written explanation with the product when returned.

Method of return shipment shall be the same or equal to the method by which the item was received by Pelco.

### RETURNS

In order to expedite parts returned to the factory for repair or credit, please call the factory at (800) 289-9100 or (559) 292-1981 to obtain an authorization number (CA number if returned for credit, and RA number if returned for repair).

All merchandise returned for credit may be subject to a 20% restocking and refurbishing charge.

Goods returned for repair or credit should be clearly identified with the assigned CA or RA number and freight should be prepaid. Ship to the appropriate address below.

*If you are located within the continental U.S., Alaska, Hawaii or Puerto Rico, send goods to:*

Pelco Department  
Pelco  
3500 Pelco Way  
Clovis, CA 93612-5699

*If you are located outside the continental U.S., Alaska, Hawaii or Puerto Rico and are instructed to return goods to the USA, you may do one of the following:*

If the goods are to be sent by a COURIER SERVICE, send the goods to:

Pelco  
3500 Pelco Way  
Clovis, CA 93612-5699 USA

If the goods are to be sent by a FREIGHT FORWARDER, send the goods to:

Pelco c/o Expeditors  
473 Eccles Avenue  
South San Francisco, CA 94080 USA  
Phone: 650-737-1700  
Fax: 650-737-0933

Pelco, the Pelco logo, Spectra, Genex, Legacy, Esprit, and Camclosure are registered trademarks of Pelco.  
Endura and ExSite are trademarks of Pelco.  
©Copyright 2003, Pelco. All rights reserved.

## REVISION HISTORY

Manual #	Date	Comments
C2408M	11/99	Original version.
C2408M	1/00	Revised installation instructions. Added FCC notices.
C2408M-A	3/00	Added varifocal lens. Changed format.
C2408M-B	7/00	Viewing window redesigned, changed icon. Added agency logos for compliance certifications.
C2408M-C	1/01	Revised heater element caution.
C2408M-D	12/01	Manual revised to reflect product design revisions.
C2408M-E	1/03	Revised camera drawings to show new design.
C2408M-F	4/03	Added instructions for fixed lens with auto iris.

## Free Manuals Download Website

<http://myh66.com>

<http://usermanuals.us>

<http://www.somanuals.com>

<http://www.4manuals.cc>

<http://www.manual-lib.com>

<http://www.404manual.com>

<http://www.luxmanual.com>

<http://aubethermostatmanual.com>

Golf course search by state

<http://golfingnear.com>

Email search by domain

<http://emailbydomain.com>

Auto manuals search

<http://auto.somanuals.com>

TV manuals search

<http://tv.somanuals.com>