

**CM6800-48X8
Matrix Switcher/
Controller**

**Installation/
Operation Manual**

C1515M-A (11/01)

Pelco • 3500 Pelco Way • Clovis, CA 93612-5699 USA • www.pelco.com
In North America and Canada: Tel (800) 289-9100 or FAX (800) 289-9150
International Customers: Tel +1 (559) 292-1981 or FAX +1 (559) 348-1120

CONTENTS

Section	Page
IMPORTANT SAFEGUARDS AND WARNINGS	6
DESCRIPTION	7
MODELS	10
ASSOCIATED EQUIPMENT	10
INSTALLATION	11
MOUNTING	11
VIDEO SOURCES	12
CONTROL LINES	14
MONITORS	15
ALARMS	16
CONNECTING DEVICES THROUGH THE COMMUNICATION PORTS	17
KBD100, KBD200, AND KBD300 SERIES KEYBOARDS	20
M DEVICES	23
CONNECTING A PC	29
CONNECTING GENEX MULTIPLEXERS	30
LOCAL AUXILIARIES	31
SYSTEM START-UP	33
POWER-UP THE SYSTEM	33
INITIALIZE KEYBOARDS	33
CONFIGURE THE SYSTEM	33
TIME AND DATE	33
CAMERA TITLES	34
VIDEO SOURCES	34
ALARMS	34
COMMUNICATION PORTS	34
KBD960/KBR960 KEYBOARD	34
GENEX MULTIPLEXER	35
MONITOR COLOR ADJUSTMENT:	35
PROGRAM PRESETS	35
ADDITIONAL PROGRAMMING	35
PROGRAMMING THE CM6800	36
CUSTOMIZING THE CM6800	36
ACCESS PROGRAMMING MODE FROM THE CM6800	37
NAVIGATE AND SELECT OPTIONS/FIELD ENTRIES IN PROGRAMMING MODE	38
ABOUT CM6800	40
ACCESS (SYSTEM PARTITIONING)	40
ALARM CONTACTS	42
AUXILIARY OUTPUTS	49
CAMERA	50
EVENT TIMERS	51
LOGICAL CAMERA NUMBERS	53
MACROS	54
MACRO STATUS VIEW SCREEN	55
MONITOR DISPLAY	56
PASSWORD	58
PORTS (SERIAL/COM PORTS)	59
PRIORITY CONTROL	60
SEQUENCES	61
TIME AND DATE	62
PATTERNS, PRESETS, AND ZONES	62

OPERATION	63
OVERVIEW	63
OPERATING THE CM6800	63
SWITCH MONITORS	63
SELECT CAMERAS	64
CONTROL RECEIVERS	64
OPERATE SEQUENCES	65
RUN A MACRO	66
ACKNOWLEDGE AN ALARM	67
CALL A PRESET	67
CREATE AND RUN A PATTERN	68
OPERATE AUXILIARIES/RELAYS	68
CONTROL GENEX MULTIPLEXER AND GENEX MULTIPLEXER DISPLAYS ..	70
OPERATE SCANNING FUNCTIONS	70
DETECT VIDEO LOSS	70
DEFINE ZONES	70
APPENDIX	71
CM6800 DIP SWITCHES	71
MACRO COMMANDS	72
ASCII OPERATING COMMANDS	74
TROUBLESHOOTING	77
GAINING INITIAL CONTROL	77
SOFTWARE RESET	77
SOLUTIONS TO COMMON PROBLEMS	78
KBD960/KBR960 ICON/BUTTON LEGEND	79
GLOSSARY	80
SPECIFICATIONS	84
REGULATORY NOTICES	86
WARRANTY AND RETURN INFORMATION	86

LIST OF ILLUSTRATIONS

Figure	Page
1	CM6800 Application 7
2	Installing Rack Ears 11
3	Mounting the CM6800 Matrix Switcher/Controller 11
4	CM6800 Video Inputs 12
5	Connecting Terminated Video Sources 13
6	Connecting Looping Video Sources 13
7	PTZ Control Connections 14
8	Connecting Monitors 15
9	Connecting Alarms 16
10	Communication Port Connections and RJ-45 Connector Pin-Outs 17
11	CM6800 Communication Port Connections and Options 19
12	Data Cable Plugged into Local Keyboard 20
13	Data Cables Plugged into COM 5 and 6 20
14	Remote Keyboards 22
15	RJ-45 Cable Types 23
16	Connecting a KBD960/KBR960 to the CM6800 24
17	Connecting a Single ALM2064 Alarm Interface Unit 25
18	Connecting a Single REL2064 Relay Interface Unit 26
19	Connecting Multiple M Devices – Local Connection 27
20	Connecting Multiple M Devices – Remote Connection 28
21	PC Connection to DB9 Port 29
22	PC Connection to RJ-45 Port 29
23	Connecting Genex Multiplexers 30
24	Wiring the AUX 1 and 2 (Relay) Outputs 31
25	Wiring the F3 (TTL) Output 32
26	CM6800 Time/Date Stamp on Monitor 33
27	CM6800 Color Bars 35
28	CM6800 Password Screen 37
29	CM6800 Programming Main Menu 37
30	Access the About CM6800 Screen 40
31	Access the Keyboard to Monitor Access Screen 40
32	Access the Camera to Keyboard Access Screen 41
33	Access the Camera to Monitor Access Screen 41
34	Access the Internal or External Alarm Screen 45
35	Access the Video Loss Screen 47
36	Access the Alarm Group Screen 48
37	Access the Set Auxiliary Screen 49
38	Access the Camera Screen 50
39	Access the Daily Timer Screen 51
40	Access the Weekly Timer Screen 52
41	Access the Special Timer Screen 52
42	Access the Logical Camera Number Screen 53
43	Access the Macro Screen 54
44	Macro Status View Screen 55
45	Access the Monitor Screen 56
46	Access the Set Password Screen 58
47	Access the Port Screen 59
48	Access the Priority Screen 60
49	Access the Sequence Screen 61
50	Access the Scratchpad Sequence Screen 61
51	Access the Time and Date Screen 62
52	CM6800 DIP Switches – Factory Default Settings 71
53	DIP Switch Cover Plate 77
54	CM6800 DIP Switch 7 77
55	Icon/Button Legend 79

LIST OF TABLES

Table	Page
A Video Coaxial Cable Requirements	12
B Communication Port Devices and Wiring	18
C Default Port Settings	18
D Keyboard Addresses: KBD100/200/300 Series Keyboards	21
E Switch Settings—KBD200/300 Keyboards Only	21
F Default Port Settings	34
G CM6800 DIP Switch Settings	71
H Macro Commands	72
I Examples of ASCII Commands	74
J ASCII Commands	75
K Solutions To Common Problems	78

IMPORTANT SAFEGUARDS AND WARNINGS

1. Read, keep, and follow these instructions.
2. Heed all warnings.
3. There are no user-serviceable parts inside this unit. Only authorized service personnel may open the unit.
4. Installation and servicing should only be done by qualified service personnel and conform to all local codes.
5. **WARNING:** To reduce the risk of fire or electric shock, do not expose this unit to rain or moisture if this unit is designed for indoor use only.
6. Unless this unit is specifically marked as a NEMA Type 3, 3R, 3S, 4, 4X, 6 or 6P enclosure, it is designed for indoor use only and it must not be installed where exposed to rain or moisture.
7. Do not expose this unit to dripping or splashing. Do not place objects filled with liquids, such as vases, on this unit.
8. Do not block any ventilation openings. Install in accordance with the manufacturer's instructions.
9. The installation method and materials should be capable of supporting four times the weight of the unit and equipment.
10. Do not install near any heat source.
11. Only use attachments/accessories specified by the manufacturer.
12. Clean only with dry cloth.
13. Do not defeat the safety purpose of the polarized or grounding-type plug.
14. Protect the power cord from being walked on or pinched, particularly at plugs, convenience receptacles, and the point where they exit from the unit.
15. Unplug this unit during lightning storms or when unused for long periods of time.

The product and/or manual may bear the following marks:



This symbol indicates that dangerous voltage constituting a risk of electric shock is present within this unit.



This symbol indicates that there are important operating and maintenance instructions in the literature accompanying this unit.

CAUTION:
RISK OF ELECTRIC SHOCK. DO NOT OPEN.

Please thoroughly familiarize yourself with the information in this manual prior to installation and operation.

FOR QUALIFIED SERVICE PERSONNEL ONLY

1. Only use replacement parts recommended by Pelco.
2. After replacement/repair of this unit's electrical components, conduct a resistance measurement between line and exposed parts to verify the exposed parts have not been connected to line circuitry.
3. **CAUTION:** Danger of explosion if battery is incorrectly replaced. Replace only with the same or equivalent type. Battery should only be replaced by authorized service personnel.

DESCRIPTION

Pelco's CM6800 Matrix Switcher/Controller is a cross-point video matrix switcher. The CM6800 provides switching and control for 48 video inputs and eight monitor outputs from any one of up to 18 keyboards, PCs, and other devices. All 48 video inputs can be used to control other devices, such as multiplexers. Forty inputs allow for looping to other devices.

The CM6800 can be controlled from a local or remote keyboard, used with a multiplexer to display multiple camera views on a monitor, and programmed from a personal computer using the CM6800-MGR software package. The CM6800 can also be controlled with ASCII commands.

The CM6800 features menu-driven, password-protected programming. Programming can also be done remotely, with the CM6800-MGR software package. Programming menus are provided in six languages: English, French, German, Italian, Portuguese, and Spanish. Multiple ports are provided on the CM6800 for pan/tilt/zoom (PTZ) control, keyboards, and peripheral components. A single data line can accommodate various types of equipment, such as external alarm interface units and relay boxes.

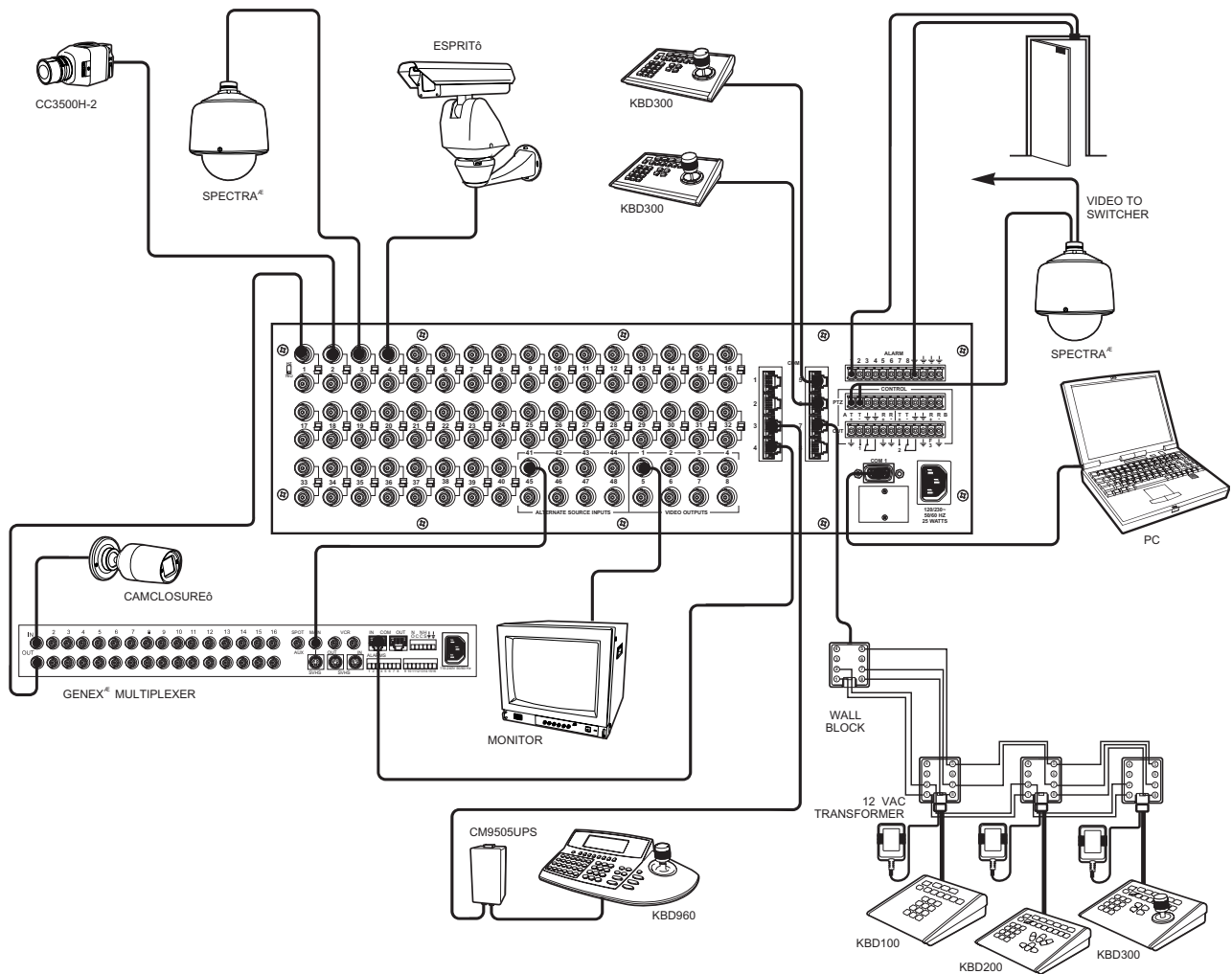

Figure 1. CM6800 Application

KEYBOARDS

Up to 16 keyboards from the KBD100/200/300 Series and 2 keyboards from the KBD960/KBR960 Series can be connected to the CM6800, allowing monitoring stations that share a common monitor to each have a keyboard. Camera positioning can be programmed and controlled from the KBD200/300 and KBD960/KBR960 Series keyboards. Keyboard types can be mixed in a system. Refer to *Associated Equipment* for keyboard descriptions.

SEQUENCES, MACROS, PRESETS, PATTERNS, AND ZONES

Special programmed operations include sequences, macros, and camera control, such as presets, patterns, and zones. **All programming (except the scratchpad sequence) is password-protected.**

A **sequence** allows operators to see a routine of 72 camera views on any system monitor over and over again. The sequence can be operated automatically or manually. The order in which the camera views appear and the time each view remains can be programmed.

The CM6800 also provides a **scratchpad sequence**, which allows a sequence to be run from an individual monitor. The scratchpad sequence can be accessed without entering the password-protected programming menus.

A **macro** is a sequence of commands or steps. When a macro is run, the steps programmed into that macro are performed. Macros can be operated automatically or manually. Automatic operation can be based on specific times or dates.

The following operations are available only with positionable cameras:

A **preset** allows operators to direct a PTZ (camera positioning system) to move to a predetermined scene on keyboard command or as a result of an alarm. In addition to moving the camera, a descriptive title can appear on the screen. The number of presets available is determined by the camera positioning system. (Presets are not available with the KBD100 keyboard.)

With a **pattern** operators can program a camera positioning system to move around its viewing area in a repeating pattern. The number and time length of patterns varies with different positioning systems. (Patterns are not available with the KBD100 keyboard.)

A **zone** is a user-defined, physical location to which (1) a label is attached and (2) a camera is associated. When the associated camera is panned through or remains within this defined zone, the zone label appears on the monitor. (Zones are not available with the KBD100 keyboard.)

INTERFACE CONTROL

The CM6800 interfaces with the following:

- Coaxitron® standard mode (15-bit) and extended mode (32-bit) protocol receivers
- Pelco's D and P protocol receivers (RS-422)
- Pelco's M protocol devices (RS-485)

PARTIONING AND PRIORITY

The CM6800 provides four ways to partition your system:

- Camera to Monitor: Cameras can be assigned to specific monitors for viewing.
- Keyboard to Monitor: Keyboards can be assigned to control specific monitors.
- Camera to Keyboard:
 - Viewing: Keyboards can be assigned view-only access to specific cameras (no PTZ control).
 - Control: Keyboards can be assigned PTZ control and viewing access to specific cameras.

The CM6800 provides eight levels of **priority** control. Each level defines the ability of a keyboard to control a camera positioning system and to access programming screens.

ALARM INPUTS

The CM6800 can accommodate 136 alarm inputs.

Eight internal alarm inputs are provided on the rear panel of the matrix switcher/controller. These internal alarm inputs are programmable to associate any camera to any input.

The CM6800 provides numerous alarm handling and display options. For example, alarms can:

- cause a system monitor display to switch automatically to the camera with the alarm.
- activate patterns or go to presets.
- operate auxiliary outputs.

Also, up to two ALM2064 Alarm Interface Units can be connected to the CM6800. Each alarm interface unit can handle up to 64 alarms, for a total of 128 external alarms.

AUXILIARY OUTPUTS

Three internal auxiliary outputs are provided on the back of the CM6800. Two are relay outputs, and one is an open collector (TTL) output. You can also connect up to two REL2064 Relay Interface Units for a maximum capacity of 128 auxiliaries.

Auxiliary outputs are activated at the keyboard (except KBD100).

POWER, MOUNTING METHODS

The CM6800 operates on 120V or 230V, 50/60 Hz. The case mounts in three rack units (5.25 inches or 13.34 cm) of vertical space in a universal mount, such as a 19-inch (48.26 cm) equipment bay, or to a wall or tabletop.

CONTINUOUS OPERATING DEVICE

The CM6800 is a self-contained video surveillance system designed specifically for use in security applications. As such, the CM6800 is intended for continuous duty operation. Once installed, there are no user or service technician items that require intervention which would require the system to go off-line or have the power turned off under normal operation. There are two methods for system programming: direct menu control and indirect control, using a Windows®-based setup program supplied by Pelco. Both of these methods are noninvasive and do not require the cycling of power in order for storage or execution of new software settings. The communication ports use standard low voltage interfaces such as RS-232, RS-422 and RS-485, and all connections and disconnections do not require rebooting or power cycling. Video connections or changes of termination state do not require rebooting or power cycling.

MODELS

CM6800-48X8 Matrix switcher/controller with 48 video inputs and 8 monitor outputs, 120/230V, 50/60 Hz

CM6800-48X8-X Matrix switcher/controller with 48 video inputs and 8 monitor outputs, 120/230V, 50/60 Hz

ASSOCIATED EQUIPMENT

KBD100 Desktop keyboard with full switching and programming capabilities, +12 VDC or 12V 50/60 Hz

KBD200 Desktop keyboard with full switching and programming capabilities, plus push-button control of PTZ functions, +12 VDC or 12V 50/60 Hz

KBD300 Desktop keyboard with full switching and programming capabilities, plus joystick control of PTZ functions, +12 VDC or 12V 50/60 Hz

KBD960 Full-function desktop variable-speed keyboard; 120V, 50/60 Hz

KBD960-X Same as KBD960, PAL-configured for 230V, 50/60 Hz operation

KBR960 Full-function rack mount variable-speed keyboard; 120V, 50/60 Hz

KBR960-X Same as KBR960, PAL-configured for 230V, 50/60 Hz operation

KBDKIT Wiring kit for connecting KBD100, KBD200, and KBD300 keyboards to remote keyboard port; includes two RJ-45 wall blocks and a transformer to convert 120V, 60 Hz to 12V, 60 Hz for keyboard power

KBDKIT-X Wiring kit for connecting KBD100, KBD200, and KBD300 keyboards to remote keyboard port; includes two RJ-45 wall blocks and a transformer to convert 230V, 50 Hz to 12V, 50 Hz for keyboard power

CM9505UPS Universal Power Supply for KBD960/KBR960 keyboards

MX4000 Genex® Series Multiplexer; available in color or monochrome duplex, and in color or monochrome simplex

CM9760-CDU-T Code distribution unit; 16-channel RS-422 transmit only (transmit wire and ground) distributor; primarily used for connecting up to 16 PTZ receivers in a "star" or "home run" configuration

ALM2064 Alarm interface unit, provides alarm monitoring capabilities for up to 64 alarm inputs, 100-240V, 50/60 Hz

REL2064 Relay interface unit, provides 64 relays for operating peripheral equipment, 100-240V, 50/60 Hz

CM9760-MDA Master distribution amplifier with time, date, and title, 120V, 60 Hz

INSTALLATION

NOTE: *There are no user-serviceable parts inside this unit. Only authorized service personnel may open the unit.*

Unpack and inspect all parts carefully. The following parts are supplied:

- 1 CM6800 Switcher/Controller
- 4 10-32 x .750-inch pan head screws
- 4 .500" OD nylon washers
- 1 Power cord
- 4 6-foot (1.8 m) straight data cables with RJ-45 connectors
- 1 6-foot (1.8 m) reversed data cable with RJ-45 connectors
- 4 RJ-45 wall block terminals

MOUNTING

1. Select a suitable location for the CM6800. It occupies 5.25 inches (13.34 cm) of vertical space, or three rack units (RUs), in a universal mount. The CM6800 must be within 6 feet (1.8 m) of a suitable electrical outlet.

Follow proper installation practices and leave 1 RU above and below the CM6800 for ventilation.

Do not connect the power until the installation is complete. Refer to the *System Start-Up* section.

2. The CM6800 is shipped with the rack ears installed at the front. Reposition as needed for your application. If the ears are not required, remove them.

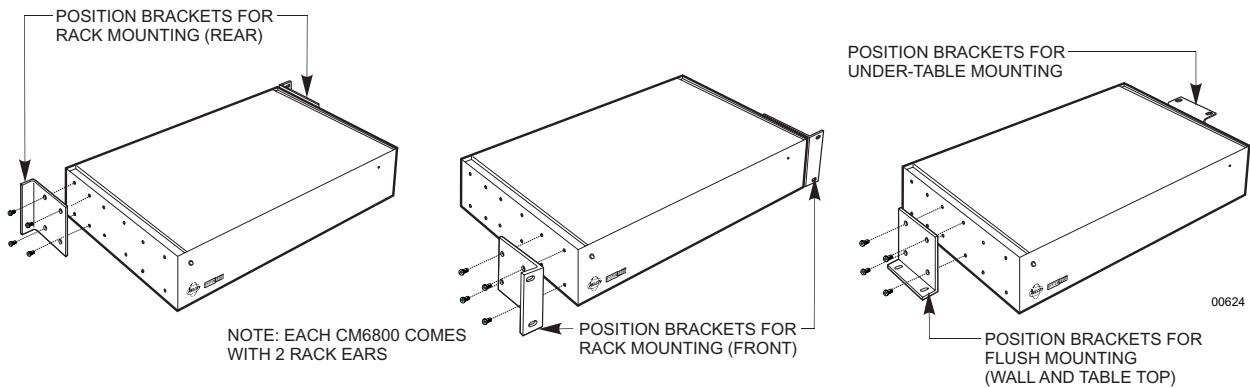
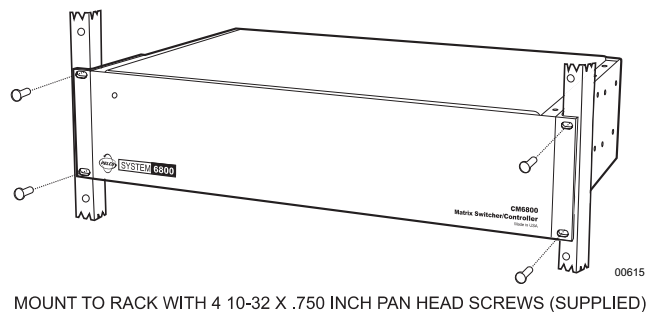

Figure 2. Installing Rack Ears

3. Use supplied pan head screws and washers to mount the CM6800 in a standard 19-inch (48.26 cm) equipment rack or wood or sheet metal screws to mount against a flat surface, according to your installation requirements.



MOUNT TO RACK WITH 4 10-32 X .750 INCH PAN HEAD SCREWS (SUPPLIED)

Figure 3. Mounting the CM6800 Matrix Switcher/Controller

VIDEO SOURCES

The CM6800 offers 48 full-function video inputs which support Coaxitron PTZ control and video loss detection. Forty video inputs, labeled 1 through 40, can be used for looping video connections with terminating and unterminating switches on the back panel. The eight alternate source inputs, labeled 41 through 48, are terminated inputs. They do not have loop-through connectors or selectable termination switches, but otherwise they offer the same functionality as video inputs 1 through 40.

All 48 video inputs also provide the ability to view and interface with other devices, such as Genex multiplexers. If control of the device connected to the video input is required, connect a data cable between the multiplexer and the CM6800. Refer to the *Connecting Genex Multiplexers* section for instructions on connecting and controlling video from a multiplexer.

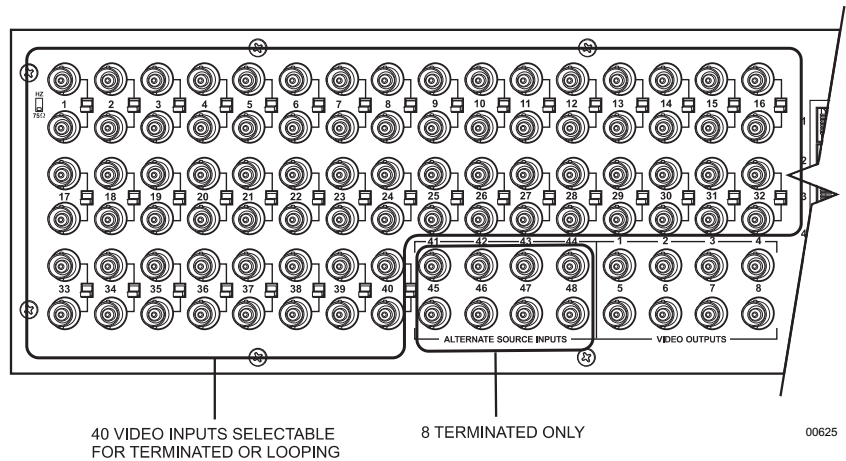

Figure 4. CM6800 Video Inputs

1. Connect video cables at the appropriate video input BNC receptacles on the back of the CM6800. For best results, use crimp-on BNCs only. Do not use screw-on BNCs; these typically do not provide adequate ground and signal connections.

Refer to Table A for video coaxial wiring requirements.

Table A. Video Coaxial Cable Requirements

Cable Type*	Maximum Distance
RG59/U	750 ft (229 m)
RG6/U	1,000 ft (305 m)
RG11/U	1,500 ft (457 m)

* Minimum cable requirements:
 75 ohms impedance
 All-copper center conductor
 All-copper braided shield with 95% braid coverage

- On video inputs 1 through 40, set the terminating switches according to your system requirements. Video inputs 41 through 48 cannot be used for loop-through connections.

Terminating switches are used to terminate or unterminate the video input. The factory default has the switches set in the terminated (75-ohm) position.

If you are connecting only a camera to an input, leave the switch in the terminated position.

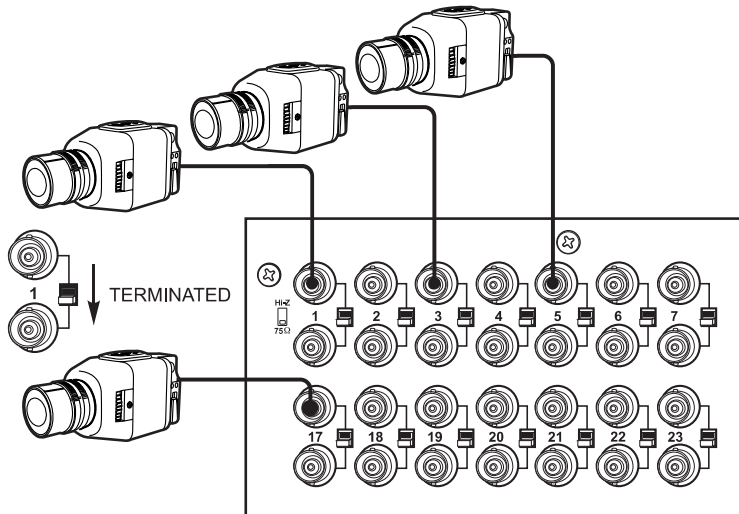

00626

Figure 5. Connecting Terminated Video Sources

If you are looping the input to another device, set the rear panel switch in the unterminated (Hi-Z) position. Terminate at the final device.

NOTE: The end point of any video cable run must be terminated in 75 ohms.

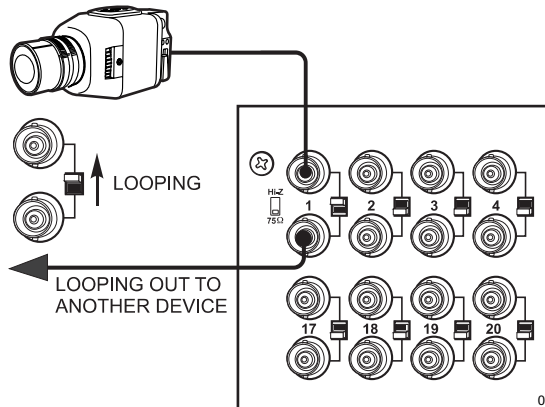

00627

Figure 6. Connecting Looping Video Sources

CONTROL LINES

NOTE: *D and P protocol receivers cannot be mixed on the same communication port but you can use D on one port and P on the other.*

You cannot connect a Coaxitron camera to the PTZ-A or PTZ-B ports. If your video sources are all controlled by Coaxitron, skip this section.

Connect camera control lines to receivers. If any of your video sources are using D or P protocol via RS-422 communications, they will connect at the PTZ-A and PTZ-B connectors on the back of the CM6800.

Daisy-chaining (going from one receiver to another) is recommended but not always possible. A maximum of 16 receivers can be daisy-chained from each port. If more than 32 receivers are required for your system, or if you do not want to daisy-chain the receiver connections, use the CM9760-CDU-T. You can connect up to four CM9760-CDU-T units to the CM6800-48X8.

NOTE: *After completing system installation and power-up, you must configure the CM6800 and the camera/receiver. Refer to the System Start-Up section.*

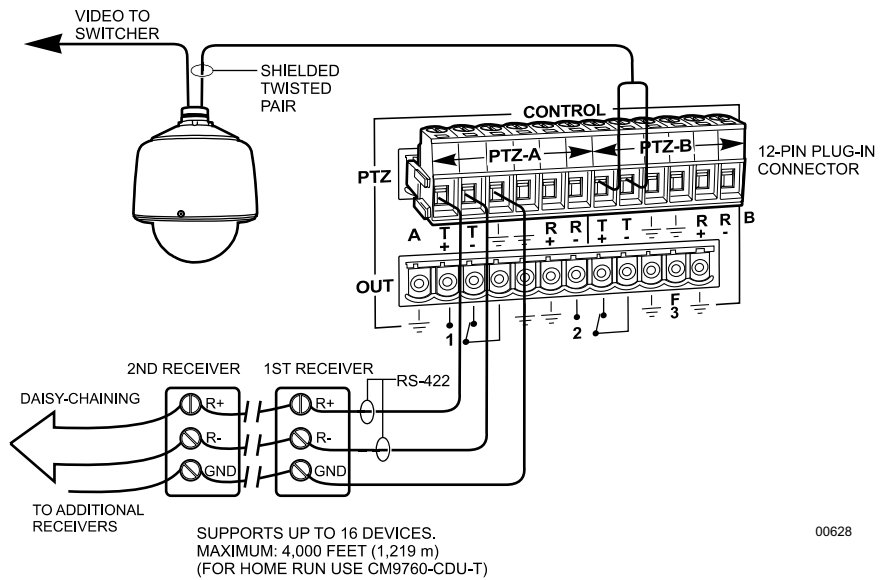

00628

Figure 7. PTZ Control Connections

MONITORS

The CM6800 supports eight monitors.

1. Install monitors according to the instructions provided with them.
2. Connect the monitor cables at the appropriate video output BNC receptacles on the back of the CM6800.
3. Terminate cables at the monitors. If you are looping to other devices, unterminate all but the last device.

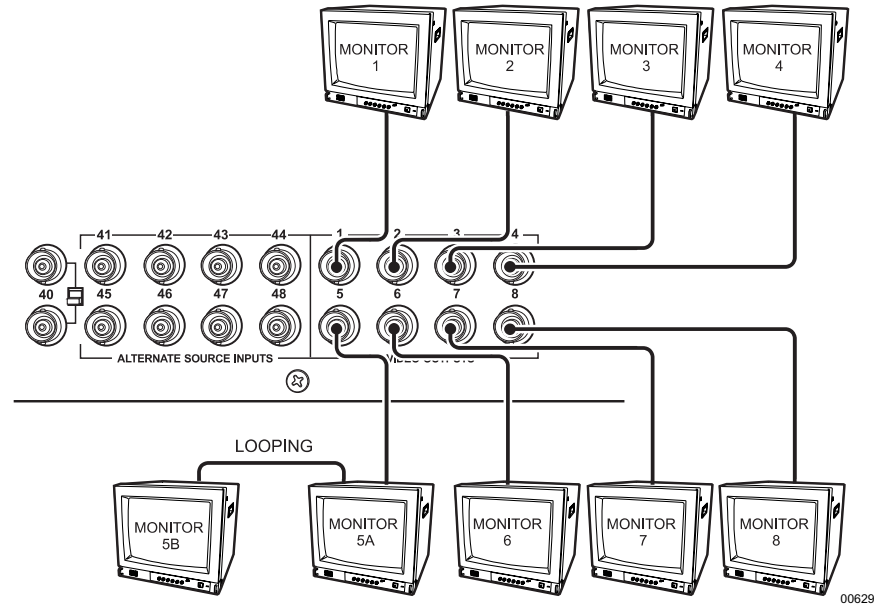

Figure 8. Connecting Monitors

ALARMS

The CM6800 provides numerous alarm handling options. Refer to the *Programming* section for a detailed description.

1. Connect wires from the sensors to the respective alarm input points on the connectors at the back of the CM6800. Each sensor requires two wires – one wire to the alarm input terminal and a return wire to one of the ground terminals on the connector. The CM6800 supports eight internal alarms.

Alarm sensors can be either N.O. (normally open) or N.C. (normally closed) contacts. The CM6800 is set to N.O. as a factory default.

2. If your system requires more than eight alarms, connect an ALM2064 unit to the system. Refer to the *M Devices* section.

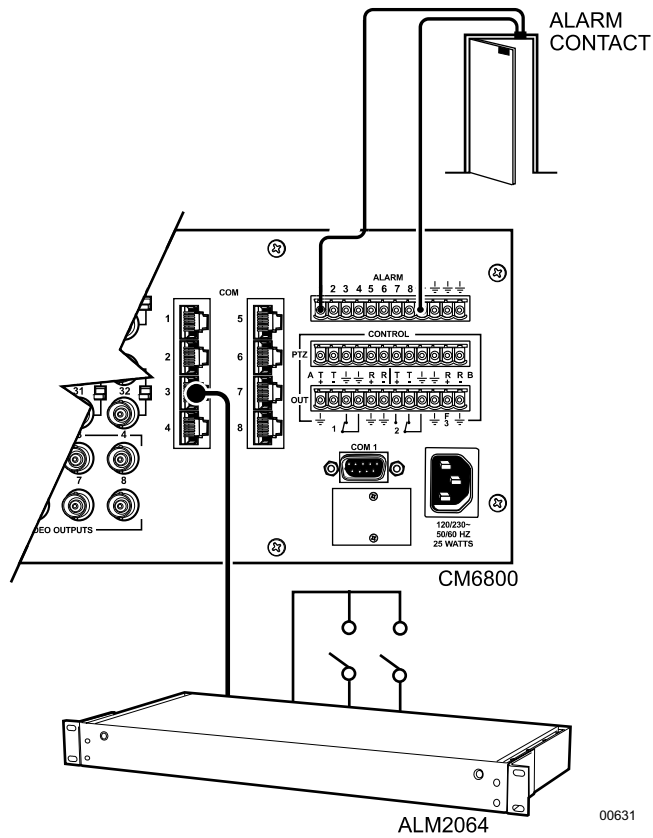

Figure 9. Connecting Alarms

CONNECTING DEVICES THROUGH THE COMMUNICATION PORTS

NOTE: Connection instructions for other peripheral devices, such as the CM9760-MDA or CM9760-CDU-T, are provided as Pelco Technical Tips, available from the Pelco web site or from a Technical Support representative (1-800-289-9100). For more information, go to www.pelco.com and select Resources. Then select Technical Tips.

The CM6800 Matrix Switcher/Controller provides eight communication ports on the rear panel for connecting peripheral components. You can connect a wide variety of devices, such as keyboards, a personal computer (for either the CM6800 MGR package or ASCII control), alarm and relay boxes, and multiplexers. Instructions are provided in this section for the most commonly used connections.

The CM6800 communication ports are labeled COM 1 through 8. Port 1 is available either as a DB9 connection, or as an RJ-45 connection. Ports 2 through 8 are RJ-45 connections. In the programming menus these are referred to as serial ports 1 through 8.

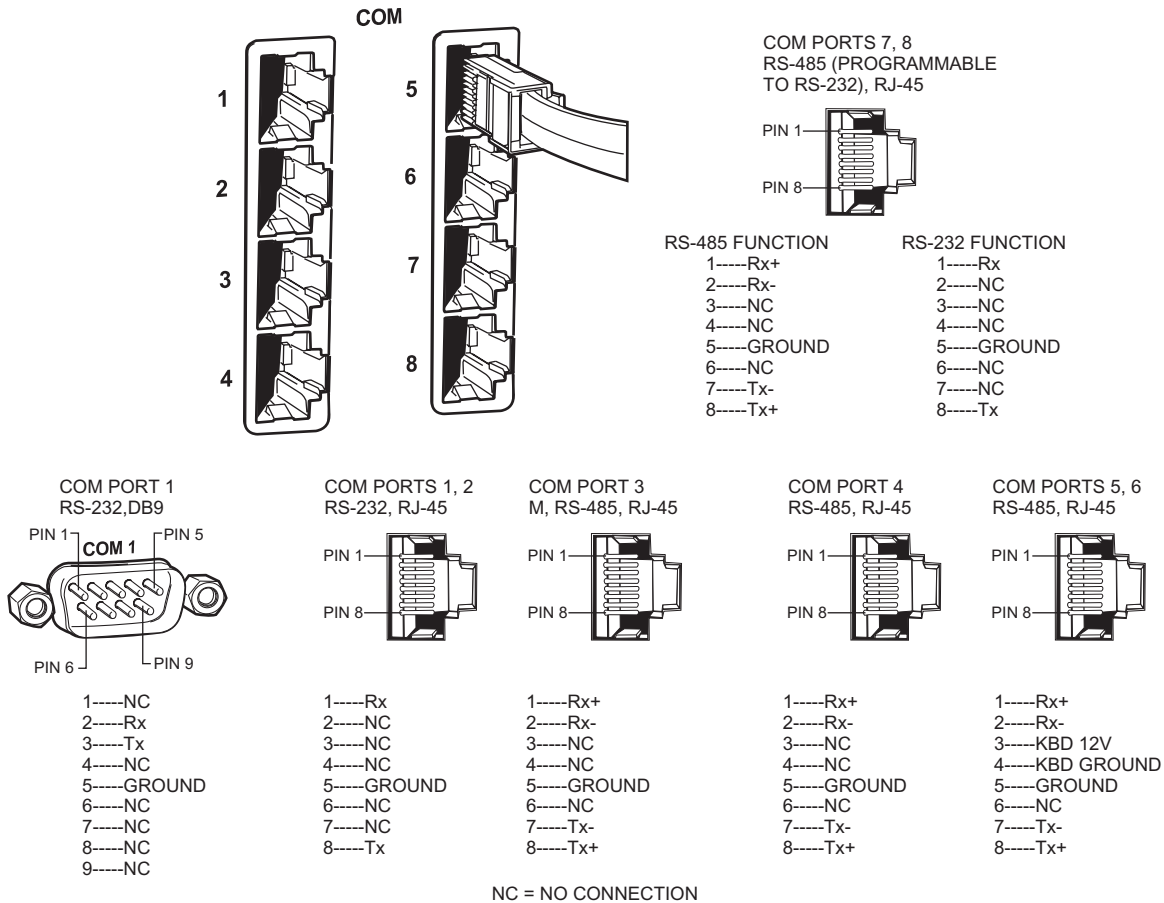

Figure 10. Communication Port Connections and RJ-45 Connector Pin-Outs

The communication ports are wired for either RS-232 or RS-485 (the wiring can be selected for COM 7 and 8). Refer to the following tables for the CM6800 default communication port settings. Some ports can be programmed for other devices; this will be done when you program the CM6800.

Table B. Communication Port Devices and Wiring

Port	Default Device	Wiring	Programmable to Other Device(s)
COM 1 (accessible with a DB9 connection or an RJ-45 connection)	PC Setup – CM6800MGR program	RS-232	ASCII device
COM 2	ASCII device	RS-232	No
COM 3	M devices — ALM2064, REL2064, KBD960	RS-485	No
COM 4	Genex multiplexer	RS-485	CM9760-MDA, ASCII
COM 5	Keyboard (direct powered) – KBD100, 200, & 300	RS-485 plus power	No
COM 6	Keyboard (direct powered) – KBD100, 200, & 300	RS-485 plus power	No
COM 7	ASCII device	RS-232 or RS-485	CM9760-MDA, keyboards (KBD100, 200, & 300)
COM 8	ASCII device	RS-232 or RS-485	MDA, keyboards (KBD100, 200, & 300)

Table C. Default Port Settings

NOTE: Refer to the Programming section for instructions on changing Serial Port settings.

Port	Default Settings
COM 1	MGR, RS-232, 56000 baud, no parity, 8 data bits, 1 stop bit
COM 2	ASCII, RS-232, 9600 baud, no parity, 8 data bits, 1 stop bit
COM 3	M, RS-485, 19200 baud, no parity, 8 data bits, 1 stop bit
COM 4	MUX, RS-485, 9600 baud, odd parity, 8 data bits, 1 stop bit
COM 5, 6	KBD-300, RS-485, 9600 baud, odd parity, 8 data bits, 1 stop bit
COM 7, 8	ASCII, RS-485, 9600 baud, no parity, 8 data bits, 1 stop bit

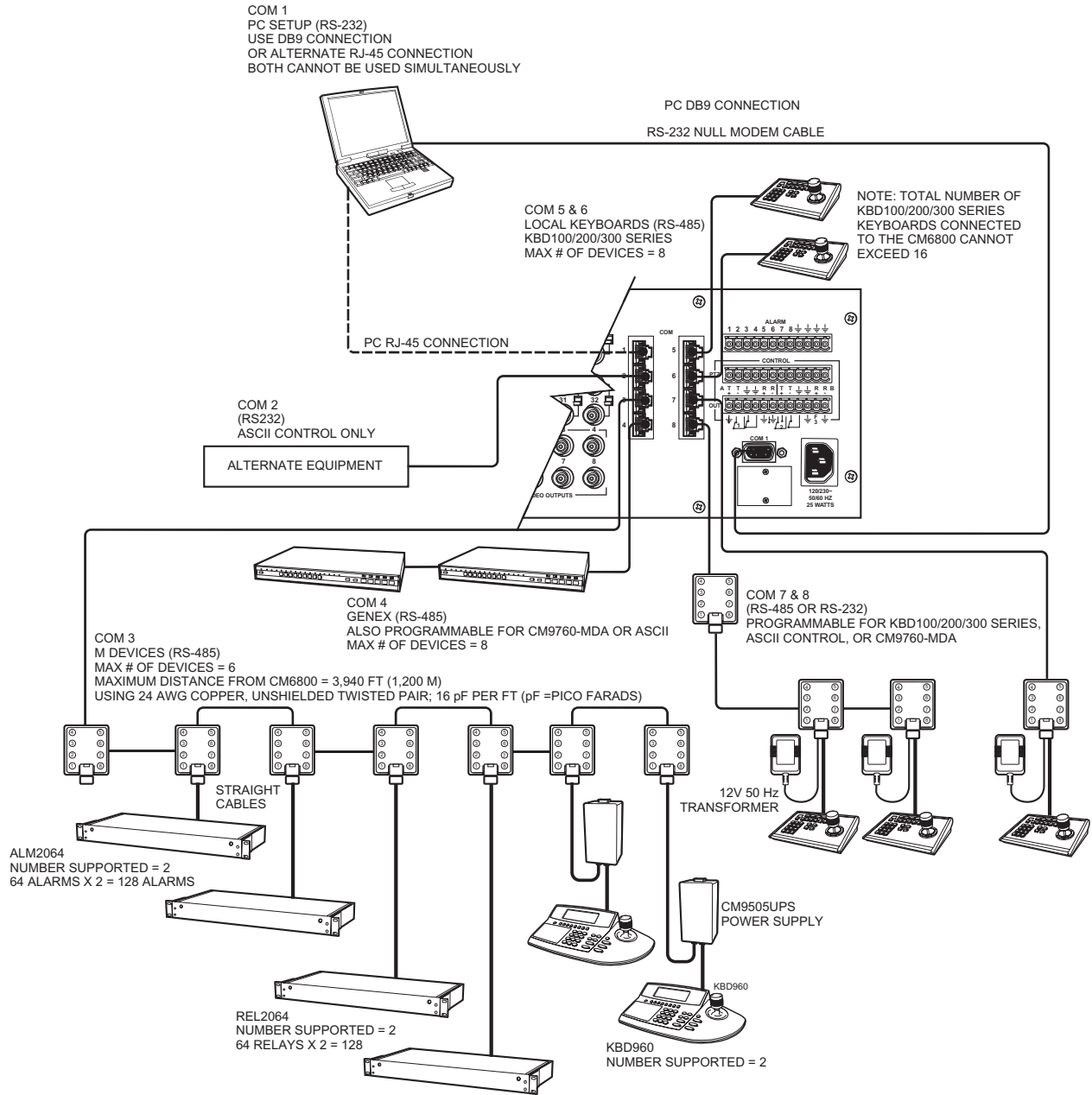

Figure 11. CM6800 Communication Port Connections and Options

KBD100, KBD200, AND KBD300 SERIES KEYBOARDS

You can connect up to eight KBD100/200/300 Series keyboards to any of the following ports:

- COM 5 (1 direct-powered keyboard or up to 8 remotely connected keyboards)
- COM 6 (1 direct-powered keyboard or up to 8 remotely connected keyboards)
- COM 7 (up to 8 remotely connected keyboards)
- COM 8 (up to 8 remotely connected keyboards)

The total number of KBD100/200/300 Series keyboards connected to the CM6800 cannot exceed 16.

KBD100, KBD200, and KBD300: Direct-Powered Keyboards

Use COM 5 and 6 (Serial Ports 5 and 6) for direct-powered local keyboards. Each port can power one KBD100/200/300 Series keyboard.

If you are connecting more than one keyboard to COM 5 or 6, a KBDKIT(-X) is required for each keyboard. Refer to the *KBD100, KBD200, and KBD300: Remote Keyboards* section.

1. Using the 25-foot (7.62 m) straight data cable supplied with the keyboard, plug one end into the RJ-45 connector on the rear of the keyboard.

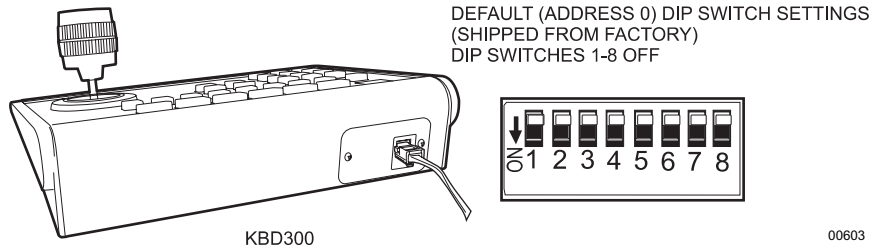

Figure 12. Data Cable Plugged into Local Keyboard

NOTE: If distance between CM6800 and keyboard exceeds 25 feet, use KBDKIT(-X).

2. Plug the other end of the data cable into either COM 5 or 6 on the CM6800.

MAXIMUM NUMBER OF KEYBOARDS POWERED BY COM 5 & 6: 1 PER PORT
 NOTE: THE TOTAL NUMBER OF KBD100/200/300 SERIES KEYBOARDS CONNECTED TO THE CM6800 CANNOT EXCEED 16.
 KBDKIT(-X) REQUIRED WHEN WIRING MORE THAN 1 KEYBOARD TO A PORT.

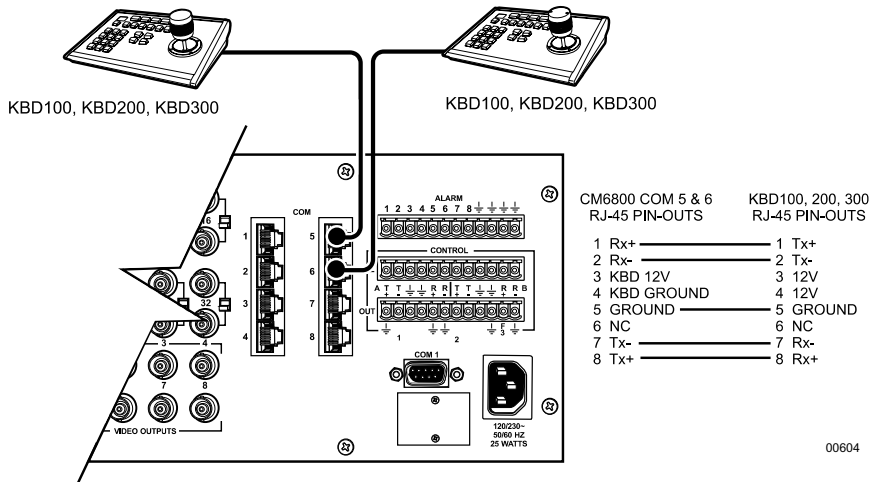

Figure 13. Data Cables Plugged into COM 5 and 6

3. Set the keyboard DIP switches for the desired address for the local keyboard (refer to Figure 12 and Table D).

Table D. Keyboard Addresses: KBD100/200/300 Series Keyboards

Keyboard	Address	Switch Settings			
		1	2	3	4
1	0	OFF	OFF	OFF	OFF
2	1	ON	OFF	OFF	OFF
3	2	OFF	ON	OFF	OFF
4	3	ON	ON	OFF	OFF
5	4	OFF	OFF	ON	OFF
6	5	ON	OFF	ON	OFF
7	6	OFF	ON	ON	OFF
8	7	ON	ON	ON	OFF

Table E. Switch Settings—KBD200/300 Keyboards Only

Keyboard	Switch			
	5	6	7	8
KBD200	OFF	OFF	OFF (NOT USED)	OFF
KBD300	OFF	ON or OFF*	OFF (NOT USED)	OFF

* Switch 6 enables/disables turbo pan (can be switched while keyboard is on).

NOTE: A KBDKIT or KBDKIT-X is required to connect remote keyboards. The KBDKIT consists of two RJ-45 wall blocks and one 120V, 60 Hz to 12V, 60Hz transformer. The KBDKIT-X has a 230V, 50 Hz to 12V, 50 Hz transformer. Use one wall block for each keyboard.

NOTE: If you do not connect keyboards to COM 7 or 8, either port can be used for a CM9760-MDA or an ASCII device. Connection instructions for CM9760-MDA are provided as a Pelco Technical Tip. Refer to the note on page 17. For ASCII devices, refer to the documentation that comes with the equipment.

KBD100, KBD200, and KBD300: Remote Keyboards

Use COM 5, 6, 7, or 8 for remote keyboard connections. Each port can support up to eight KBD100/200/300 Series keyboards. Do not exceed a total capacity of 16 keyboards connected to the CM6800.

If using COM 7 or 8, you will need to change the settings (the default setting is for an ASCII device.) Refer to the *Programming* section for instructions.

1. Select a suitable location for each keyboard and wall block. Wall blocks must be within 6 feet (1.8 m) of a suitable electrical outlet. Do not mount the wall blocks yet.
2. Connect each keyboard to a wall block, using the keyboard data cable supplied with the keyboard.
3. Remove the wall block covers and wire the connections between each wall block. Connect to a final wall block (which will be connected to the CM6800).

Communication to the keyboards is RS-485. Pelco recommends using four-conductor, shielded 18-gauge twisted pairs, such as Belden 9418 or similar cable, that meets or exceeds the basic requirements for EIA RS-485 applications.

4. At each wall block, wire the KBDKIT(-X) transformer to pins 3 and 4. Polarity is unimportant.
5. Replace the cover on the wall block. Secure the wall block to a suitable surface. A double-sided sticky pad is provided to mount the wall block.
6. Set the address switches for each keyboard according to Table D.
7. Connect the final wall block to COM 5, 6, 7, or 8 on the CM6800, using a straight data cable (supplied with the CM6800).

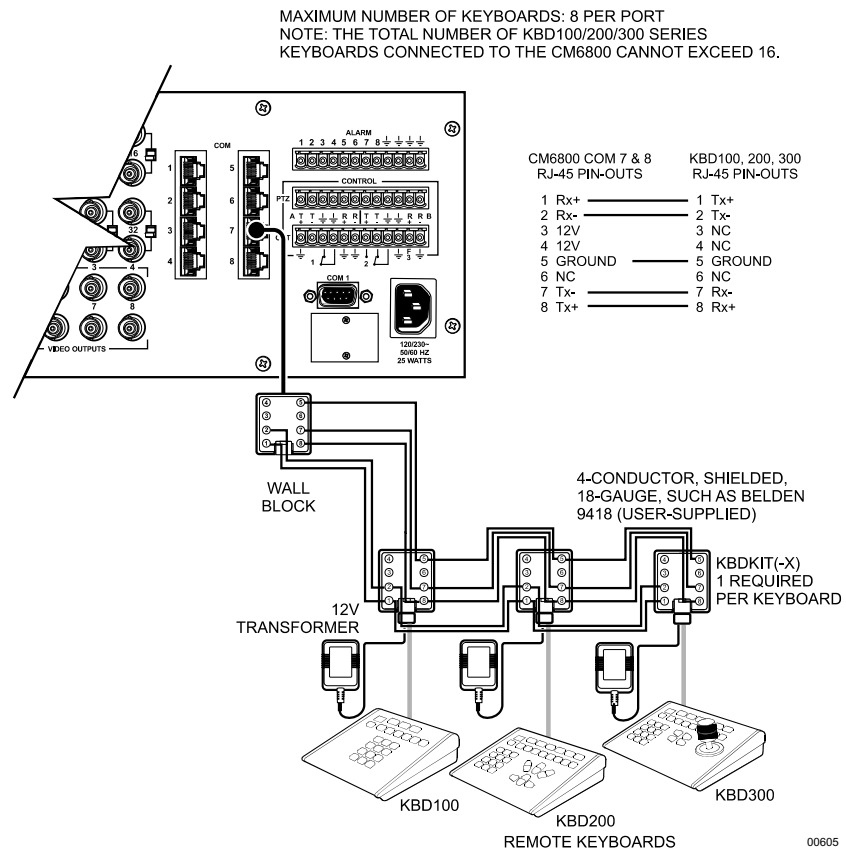

Figure 14. Remote Keyboards

M DEVICES

M protocol devices (KBD960/KBR960 keyboards, ALM2064 Alarm Interface Units, and REL2064 Relay Interface Units) can be connected to COM 3 on the CM6800.

If only one device is to be connected to COM 3, use the instructions for that device in the following sections.

If more than one device is to be connected to COM 3, refer to the *Multiple M Devices* section.

Connect M devices to the CM6800 with straight cables. Four straight cables and one reversed cable are supplied with the CM6800 (save the reversed cable for connecting a Genex Multiplexer, if applicable).

M Devices Addressing

Each M device connected to the CM6800 must have a unique local address within a range of 1-16. Use the hardware DIP switches to set the appropriate ALM2064 and REL2064 local addresses. Specify the appropriate KBD960/KBR960 local address through the keyboard Setup Mode after you complete the system installation (refer to the *System Start-Up* section).

For use with the CM6800, Pelco recommends numbering M devices in a sequential order. In a sample application, with two of each M device, you might assign local addresses as follows:

M device local addresses:	Default	Recommended for CM6800
KBD960/KBR960:	1	1, 2
REL2064:	1	3, 4
ALM2064:	1	5, 6

NOTE: If you wish to use the partitioning and priority features of the CM6800, you must number KBD960/KBR960 keyboards within a range of 1-8.

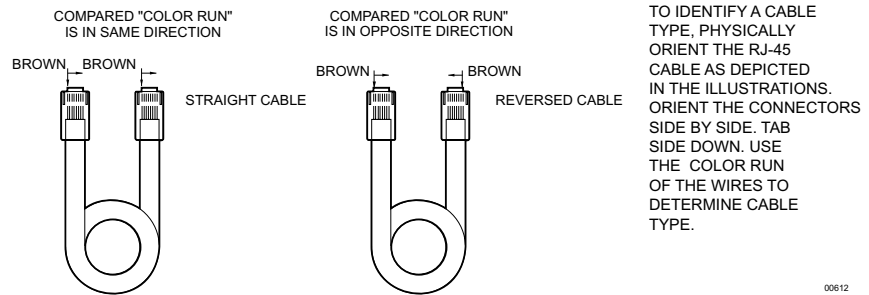

Figure 15. RJ-45 Cable Types

Connecting a Single KBD960/KBR960 Keyboard

To connect a single KBD960/KBR960 Keyboard to the CM6800:

1. Connect the keyboard to the CM9505UPS using the straight cable supplied with the keyboard.
2. Connect the CM9505UPS to COM 3 on the CM6800 using the 6-foot (1.8 m) straight data cable supplied with the CM6800.

NOTE: After completing system installation and power-up, you must configure the KBD960/KBR960 settings. Refer to the System Start-Up section.

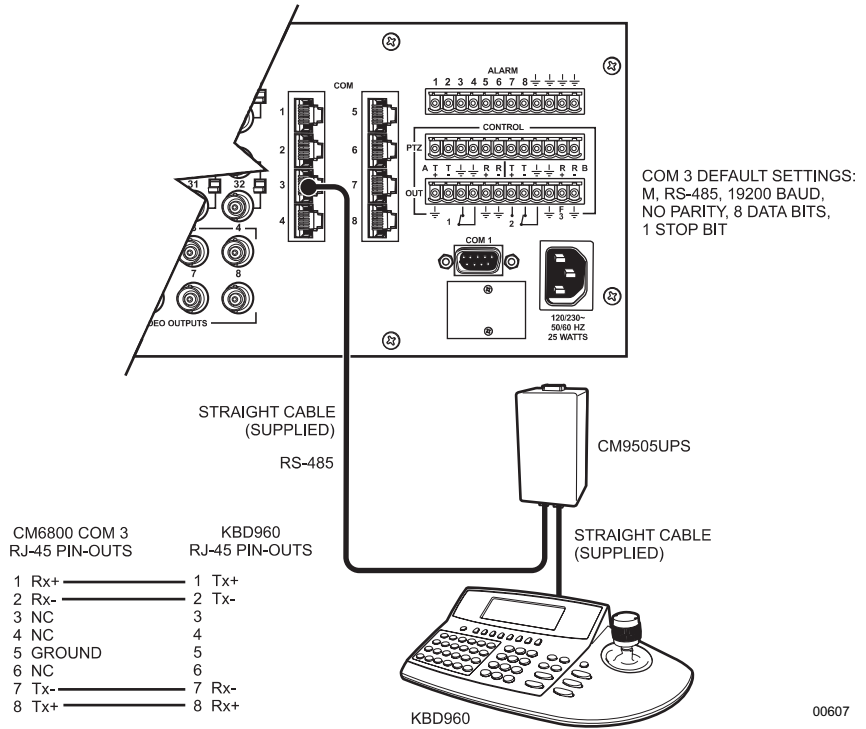

Figure 16. Connecting a KBD960/KBR960 to the CM6800

Connecting a Single ALM2064 Alarm Interface Unit

To connect a single ALM2064 Alarm Interface Unit:

1. Connect the ALM2064 OUT port to COM 3 on the CM6800 using the 6-foot (1.8 m) straight data cable supplied with the CM6800.
2. Set SW2, DIP switches 1-8 to the appropriate positions for the local address (default address setting is 1). Refer to the ALM2064 Alarm Interface Unit Installation/Operation Manual for instructions.

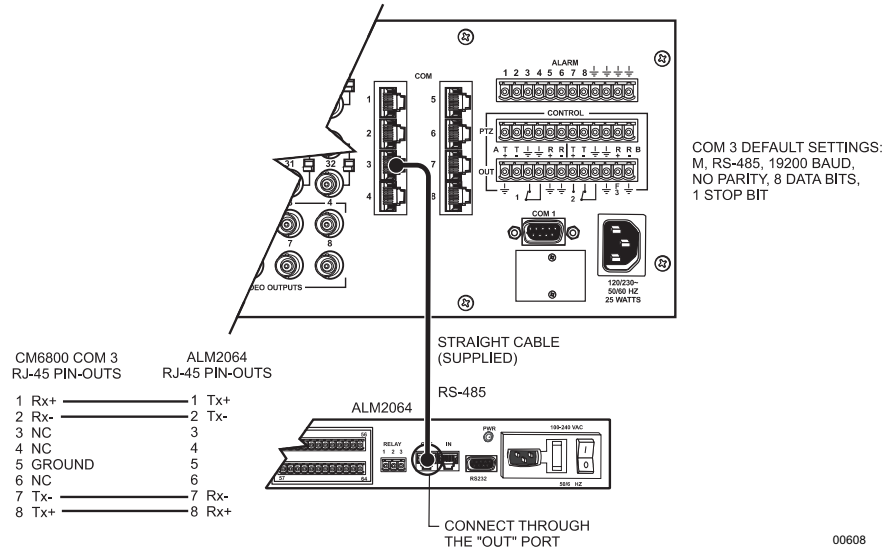

Figure 17. Connecting a Single ALM2064 Alarm Interface Unit

Connecting a Single REL2064 Relay Interface Unit

To connect a single REL2064 Relay Interface Unit:

1. Connect the REL2064 OUT port to COM 3 on the CM6800 using the 6-foot (1.8 m) straight data cable supplied with the CM6800.
2. Set SW2, DIP switches 1-8 to the appropriate positions for the local address (default address setting is 1). Refer to the REL2064 Relay Interface Unit Installation/Operation Manual for instructions.

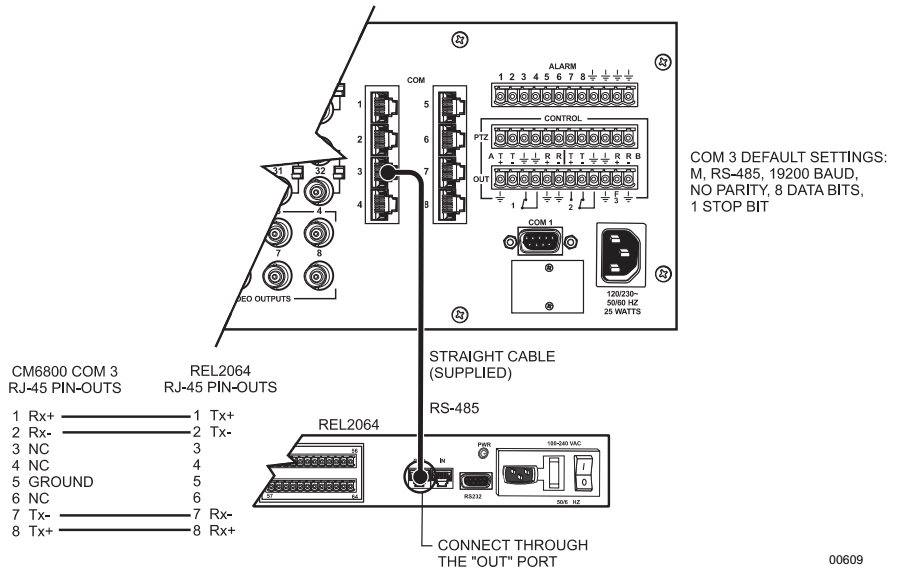

Figure 18. Connecting a Single REL2064 Relay Interface Unit

Multiple M Devices

Multiple M devices (KBD960/KBR960, ALM2064, and REL2064) can be connected to COM 3 on the CM6800, either as local devices or remote devices (when connecting two KBD960/KBR960 keyboards to the CM6800, you must use a remote connection).

MULTIPLE M DEVICES: LOCAL CONNECTION

1. If you are connecting a KBD960/KBR960, connect it to the CM9505UPS with the straight cable supplied with the keyboard. Then connect the CM9505UPS to the IN port on the next unit (either the ALM2064 or the REL2064) with a 6-foot (1.8 m) straight cable (supplied with the CM6800).
2. Connect each ALM2064 and REL2064 unit to the next unit with a 6-foot (1.8 m) straight cable (supplied with the CM6800) from the OUT port to the IN port on the next unit. You can connect a maximum of two ALM2064 units and two REL2064 units to the CM6800.
3. Connect the last unit to the CM6800 with a 6-foot (1.8 m) straight cable (supplied with the CM6800) from the OUT port to COM 3 on the CM6800.

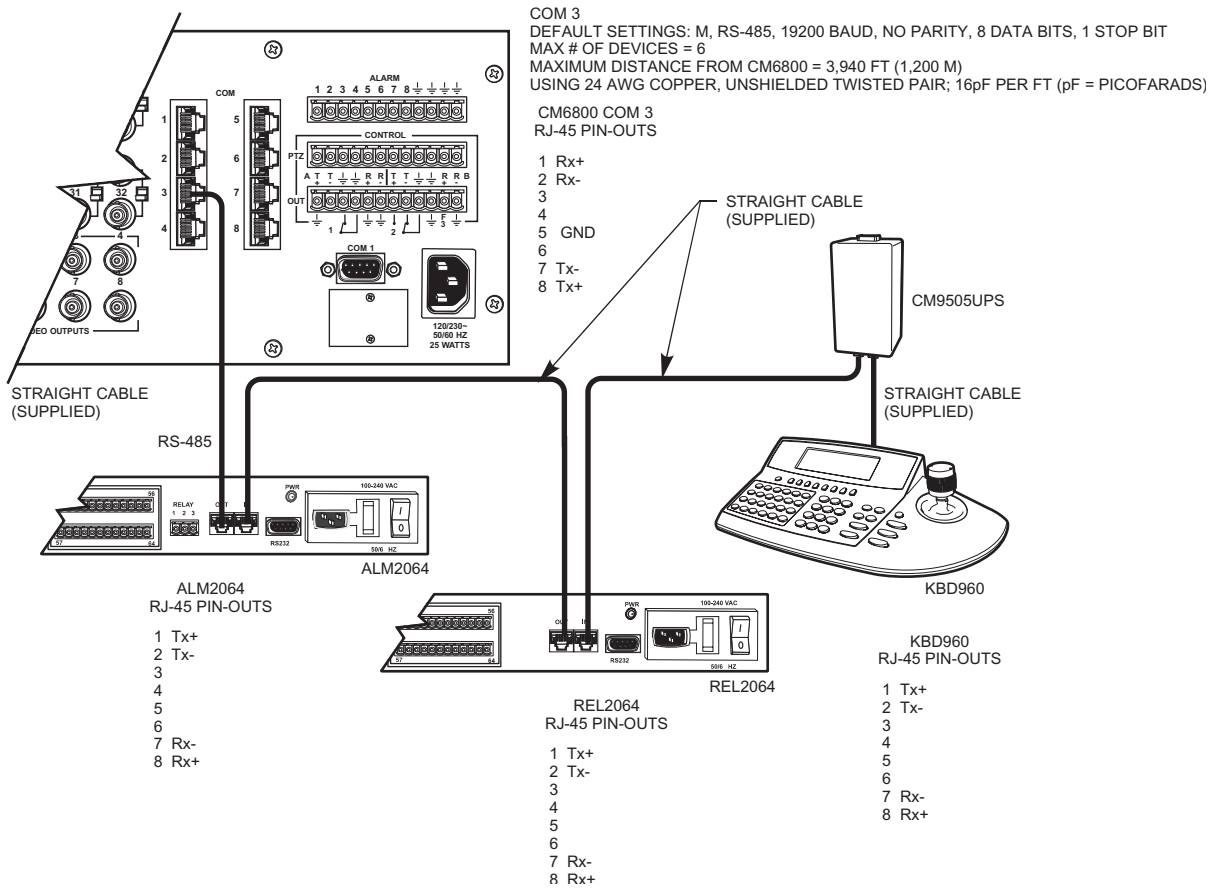

Figure 19. Connecting Multiple M Devices – Local Connection

MULTIPLE M DEVICES: REMOTE CONNECTION

Use a remote connection when the distance from the CM6800 is greater than 6-feet (1.8 m).

1. Connect each ALM2064 and REL2064 unit to a wall block with a 6-foot (1.8 m) straight cable (supplied with the CM6800). You can connect a maximum of two ALM2064 units and two REL2064 units to the CM6800.
2. If you are connecting a KBD960, connect it to the CM9505UPS with the straight cable supplied with the keyboard. Then connect the CM9505UPS to a wall block with a 6-foot (1.8 m) straight cable (supplied with the CM6800). You can connect a maximum of two KBD960 keyboards to the CM6800.
3. Connect the wall blocks to a final wall block. If additional wall blocks are needed, order part number CON12J008Z03G0Z.
4. Connect the terminal wall block to COM 3 on the CM6800 using a 6-foot (1.8 m) straight cable (supplied with the CM6800).

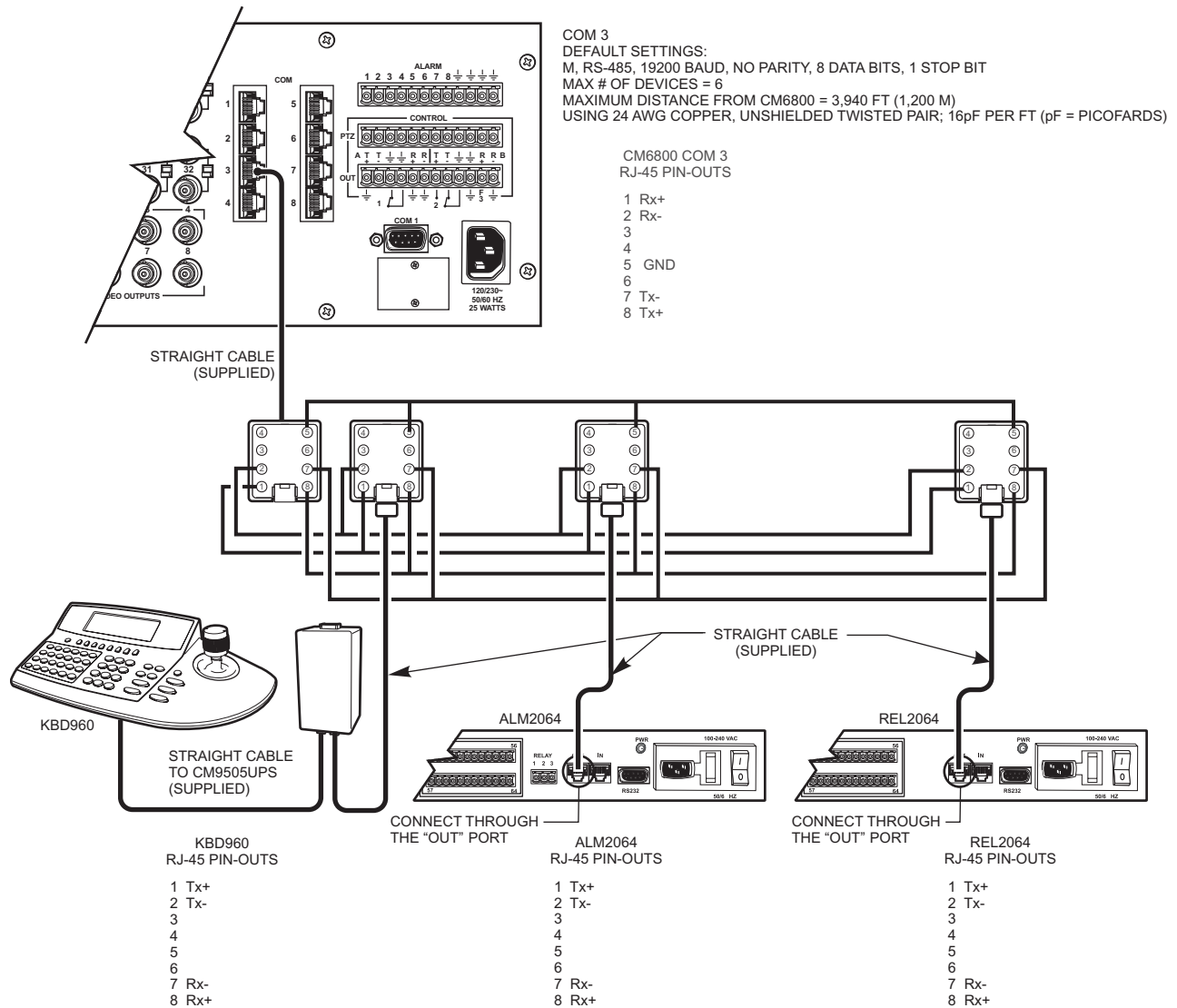

Figure 20. Connecting Multiple M Devices – Remote Connection

NOTE: You can also connect an ASCII device through COM 1, 2, 7, or 8. Using an ASCII device through COM 1 requires a change in serial port settings. Refer to the Programming section for instructions.

CONNECTING A PC

The CM6800 provides PC-based setup and programming software that facilitates complete switcher programming and configuration. Refer to the CM6800-MGR Quick Start Guide for instructions on using the software.

Connect a PC to the CM6800 to access the CM6800-MGR software or to download upgrades to the software. You can connect a PC to the CM6800 through either a DB9 port or an RJ-45 port. **You cannot use both ports simultaneously.**

1. Using a null modem cable (user-supplied), plug one end into the DB9 COM 1 port on the PC.
2. Plug the other end of the cable into the DB9 COM 1 port of the CM6800.

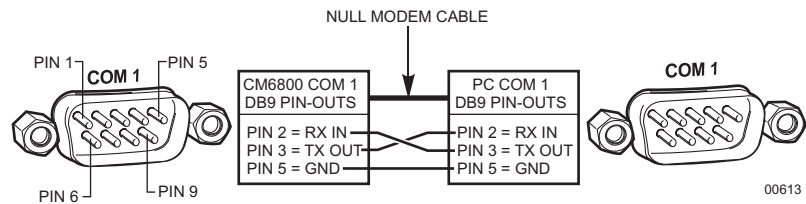

Figure 21. PC Connection to DB9 Port

OR

1. Using a modified null modem cable (user-supplied), connect the DB9 COM 1 port on the PC to an RJ-45 wall block (supplied with the CM6800 Matrix Switcher).

The modified null modem cable should be cut at one end, so that you can connect the wires directly to the wall block pins.

2. Using a 6-foot (1.8 m) data cable (supplied with the CM6800 Matrix Switcher), connect the wall block to the RJ-45 COM 1 port of the CM6800.

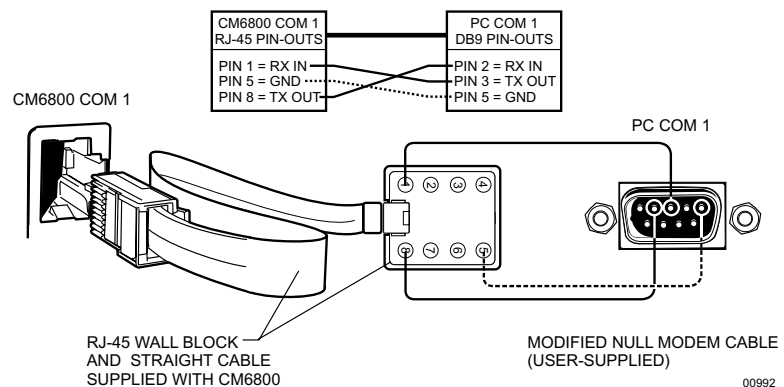

Figure 22. PC Connection to RJ-45 Port

NOTE: If you do not connect multiplexers to COM 4, you can connect a CM9760-MDA or an ASCII device through COM 4. Using either device requires a change in serial port settings. Refer to the Programming section.

CONNECTING GENEX MULTIPLEXERS

Use COM 4 to connect up to eight Genex Multiplexers to the CM6800.

1. Connect the COM IN port of the multiplexer to COM 4 on the CM6800, using the 6-foot (1.8 m) reversed data cable supplied with the CM6800.

One reversed cable and four straight cables are supplied with the CM6800. Use the reversed cable for connecting the Genex multiplexer to the CM6800.

A straight data cable is supplied with the Genex multiplexer. Use this cable for connecting a second Genex multiplexer to the first multiplexer, if necessary.

2. Connect the MAIN monitor output from the multiplexer to any of the 48 camera inputs on the CM6800.
3. Connect cameras to the multiplexer and then loop them to the CM6800. Refer to the MX4000 Genex Series Simplex and Duplex Multiplexers Installation/Operation Manual for detailed camera connection instructions. Terminate the video loop at the CM6800.
4. If required, you can connect a total of eight Genex multiplexers through COM 4. Daisy-chain the multiplexers by connecting a straight data cable from the COM OUT port on the first multiplexer to the COM IN port on the second multiplexer; connect the COM OUT port on the second multiplexer to the COM IN port on the third multiplexer. Continue to the eighth multiplexer, if necessary.

Refer to the *System Start-Up* section for additional configuration steps required when using a Genex Multiplexer.

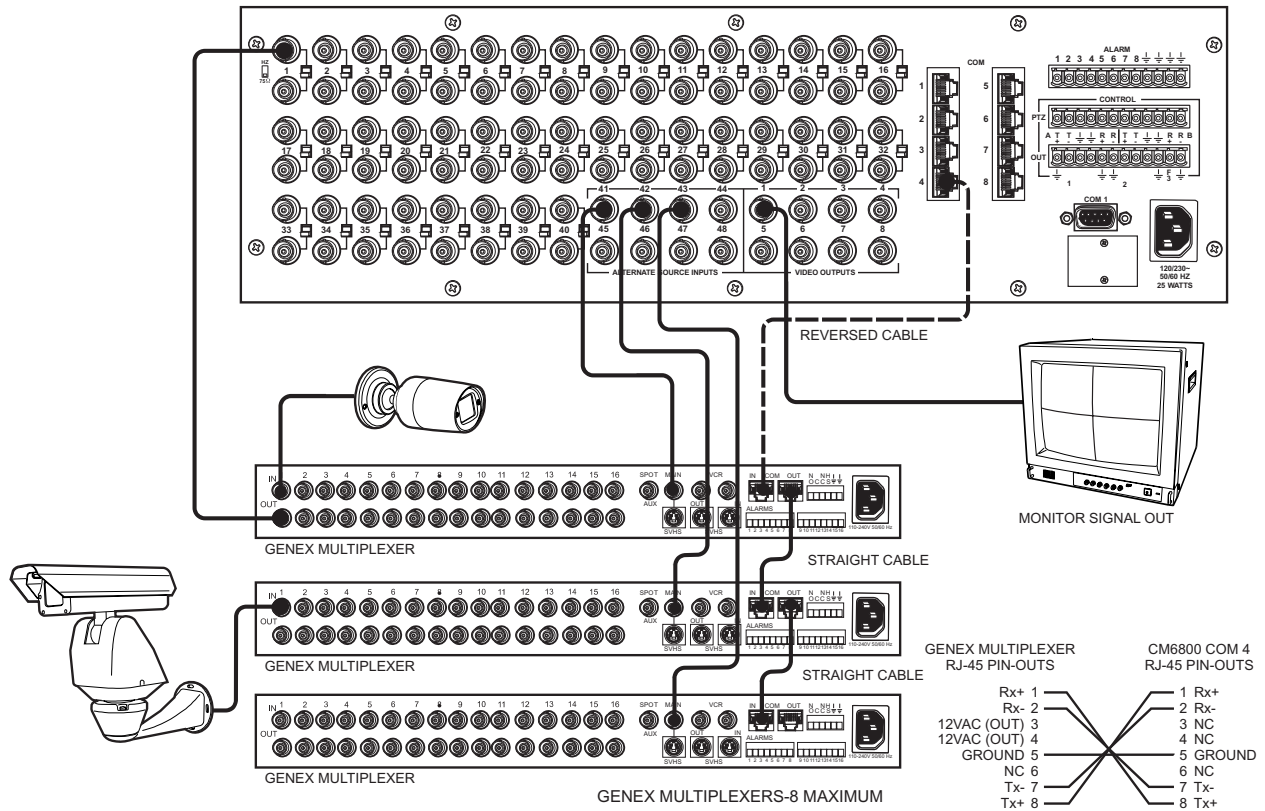

Figure 23. Connecting Genex Multiplexers

LOCAL AUXILIARIES

The CM6800 provides three local auxiliary (AUX) outputs on the rear panel for controlling VCRs, printers, and other devices. These outputs can be activated directly from a keyboard by using the F1, F2, and F3 function keys, or they can be activated by an alarm (determined by programming). Both relay contacts and TTL outputs are used.

In addition, you can connect up to two REL2064 Relay Interface Units to the CM6800. Note that since operation of the three internal auxiliary relays on the CM6800 will also operate the first three relays on the external unit, the maximum capacity of the system may be limited to 128 auxiliaries (depending on how you number the external relays). Refer to the *Connecting a Single REL2064 Relay Interface Unit* section for connection instructions.

CONNECTING RELAY CONTACTS - AUX 1 AND 2

AUX 1 and 2 are dry contact relay outputs. Refer to Figure 25 for wiring details. Terminal connections are provided for both normally open (N.O.) and normally closed (N.C.) contacts.

Do not exceed the voltage and current ratings for the relay contacts.

You will need to provide an external power source to operate your device. In most cases you will also need an external current limiting resistor. The formula for calculating the resistor value is given in Figure 25.

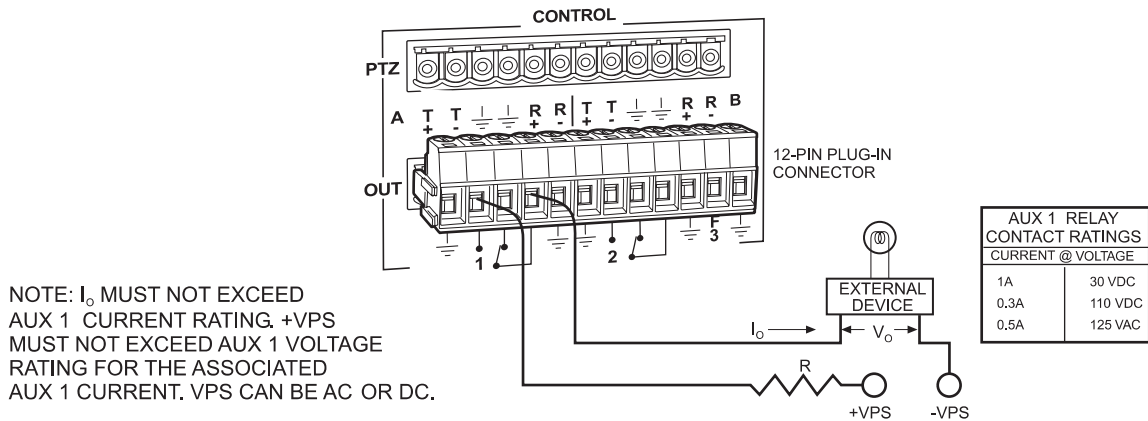

NOTE: I_o MUST NOT EXCEED AUX 1 CURRENT RATING. +VPS MUST NOT EXCEED AUX 1 VOLTAGE RATING FOR THE ASSOCIATED AUX 1 CURRENT. VPS CAN BE AC OR DC.

- I_o = OPERATING CURRENT OF THE EXTERNAL DEVICE.
- V_o = RATED OPERATING VOLTAGE OF THE EXTERNAL DEVICE.
- R = CURRENT LIMITING RESISTOR.
- +VPS = VOLTAGE OF THE EXTERNAL POWER SOURCE.
- VPS = NEGATIVE, COMMON OR GROUND TERMINAL OF EXTERNAL POWER SOURCE.

FORMULAS FOR R VALUES

$$R \text{ (OHMS)} = \frac{VPS - V_o}{I_o}$$

$$P \text{ (WATTS)} = (I_o)^2 \times R$$

*WIRING FOR NORMALLY OPEN TYPE CONTACTS SHOWN. FOR NORMALLY CLOSED TYPE CONTACT, MOVE WIRE FROM THE N.O. TERMINAL TO THE N.C. TERMINAL.

00617

Figure 24. Wiring the AUX 1 and 2 (Relay) Outputs

CONNECTING THE OPEN COLLECTOR OUTPUT – F3 (TTL)

F3 is a TTL open collector output. This output provides a path to ground to control the low voltage trigger input on many devices. It can control higher voltage control inputs via isolation relays. Refer to Figure 26 for wiring details.

Do not exceed the voltage and current ratings for the TTL output.

An external pull-up resistor is usually necessary. The formula for calculating the resistor value is given in Figure 26.

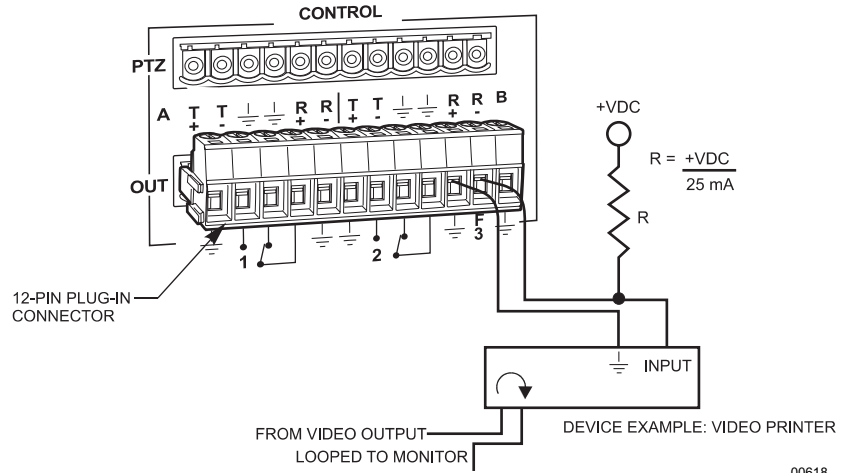

00618

+VDC = VOLTAGE OF THE EXTERNAL POWER SOURCE.

NOTE: +VDC SHOULD BE 5V OR GREATER, BUT NOT EXCEED 15V OR THE MAXIMUM RATED OUTPUT VOLTAGE FOR THE DEVICE INPUT. +VDC CAN ONLY BE DC.

Figure 25. Wiring the F3 (TTL) Output

SYSTEM START-UP

After completing the system installation, follow the procedure below to start proper system operation. Skip any "system-specific" steps that do not apply to your system setup.

POWER-UP THE SYSTEM

Plug the CM6800 power cord into a 120/230V, 50/60 Hz power source. Plug in and turn on all devices connected to the CM6800.

Once the system is powered-up you will see video from camera 1 and the following time/date stamp on all system monitors:

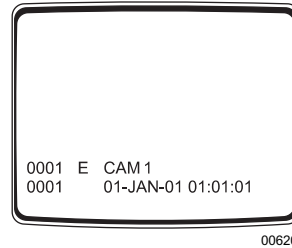

Figure 26. CM6800 Time/Date Stamp on Monitor

The time stamp will be advancing in one-second increments. Wait five seconds before proceeding.

INITIALIZE KEYBOARDS

You must specify a monitor for each keyboard after your first power-up or any time power is cycled to the keyboard or the CM6800.

Always allow five seconds to elapse before specifying a monitor.

1. Enter a number (1-8) corresponding to the monitor output that is feeding the monitor you are viewing.
2. Press the MON key. The keyboard LED displays the number you entered. This also confirms successful communication between the keyboard and the CM6800. If the keyboard LED does not display the monitor number, repeat 1 and 2.

If you are unable to select the monitor, refer to the *Troubleshooting* section.

CONFIGURE THE SYSTEM

If necessary, configure the CM6800 and associated equipment to your specific application. The CM6800 is shipped from the factory with default programming settings. If the defaults are acceptable, the CM6800 can be operated without any user programming. However, you may want to program the basic system settings, such as time and date, and camera titles. In addition, some or all of the following configuration steps may be necessary, depending on your system.

Configure the CM6800 through Programming mode. Refer to the *Programming* section for detailed instructions.

TIME AND DATE

Access the Time & Date programming screen to set the time and date, and select the time/date format option.

CAMERA TITLES

By default each camera is titled "CAM #" (# = camera number from 1-48). Access the Camera programming screen to change the camera titles.

VIDEO SOURCES

Extended Coaxitron protocol receivers can be operated without any programming changes. For other receiver control protocols, access the Camera programming screen to select the control type for the device connected to each video input. Control can be through standard mode Coaxitron, extended mode Coaxitron, RS-422 PTZ through Port A or Port B on the rear panel, or through a Genex Multiplexer.

For RS-422 PTZ control you must configure the CM6800:

- Access the Camera programming screen to identify the receiver control type (PTZ-A or PTZ-B) and to select the appropriate camera port address. The camera port address must match the address setting configured through the camera/receiver DIP switch settings.
- Access the Port programming screen to select the appropriate communication type (P or D) for serial ports 9 (PTZ-A) and 10 (PTZ-B). Default settings for PTZ-A and PTZ-B: PTZ-P, RS-422, 4800 baud, no parity, 8 data bits, 1 stop bit.

You must also configure the camera/receiver. Refer to the appropriate camera/receiver installation manual for configuration and address settings.

ALARMS

The CM6800 is shipped from the factory with the alarm contact enable field set to OFF. To use the alarm features, access the Alarm programming screens to enable the alarm contact.

COMMUNICATION PORTS

If you are using any communication port for a device not specified by the default setting, you must access the Port programming screen to change the settings.

Table F. Default Port Settings

Port	Default Settings
COM 1	MGR, RS-232, 56000 baud, no parity, 8 data bits, 1 stop bit
COM 2	ASCII, RS-232, 9600 baud, no parity, 8 data bits, 1 stop bit
COM 3	M, RS-485, 19200 baud, no parity, 8 data bits, 1 stop bit
COM 4	MUX, RS-485, 9600 baud, odd parity, 8 data bits, 1 stop bit
COM 5, 6	KBD-300, RS-485, 9600 baud, odd parity, 8 data bits, 1 stop bit
COM 7, 8	ASCII, RS-485, 9600 baud, no parity, 8 data bits, 1 stop bit
PTZ-A (Port 9)	PTZ-P, RS-422, 48 baud, no parity, 8 data bits, 1 stop bit
PTZ-B (Port 10)	PTZ-P, RS-422, 48 baud, no parity, 8 data bits, 1 stop bit

KBD960/KBR960 KEYBOARD

Configure the KBD960/KBR960 settings.

1. Set DIP switch 2 to the ON position.
2. Enter Setup Mode. Set the local address (1-8). (Note: the baud rate is set by default to 19200.) Each M device connected to the CM6800 must have a unique local address. Refer to the KBD960/KBR960 Keyboard Installation/Operation Manual for detailed setup instructions.
3. Return DIP switch 2 to the OFF position.
4. Press the EXIT icon on the keyboard LCD screen.

GENEX MULTIPLEXER

Access the Camera programming screen and specify MUX control for all cameras connected to the CM6800 through the Genex Multiplexer.

Access the CM6800 Camera programming screen to configure the following camera control options for each camera connected to the CM6800 through the Genex Multiplexer:

- CONTROL: MUX
- PORT ADDRESS: assign the appropriate address. The port address must match the "Unit ID" assigned through the Genex programming screens.

You must also configure the Genex Multiplexer. Refer to the MX4000 Genex Series Simplex and Duplex Multiplexers Installation/Operation Manual (C1920M-B) for instructions on accessing the Advanced System Setup programming screen. Select the following options:

- SPOT MONITOR DISPLAY: TRACK MAIN
- UNIT ID (must match the port address assigned through the CM6800)
- COMM. TYPE: SLAVE (each multiplexer connected to the CM6800 must be in slave mode)

MONITOR COLOR ADJUSTMENT:

Once you have connected all devices and powered the system, use the CM6800 color bars as a reference tool for adjusting the color on each monitor.

1. Enter 9999.
2. Press the CAM key. Broadcast quality color bars appear on the monitor.
3. Adjust color on each monitor as necessary until the color bars match the following color order on the monitor (for black and white monitors you can use the color bars to adjust brightness):

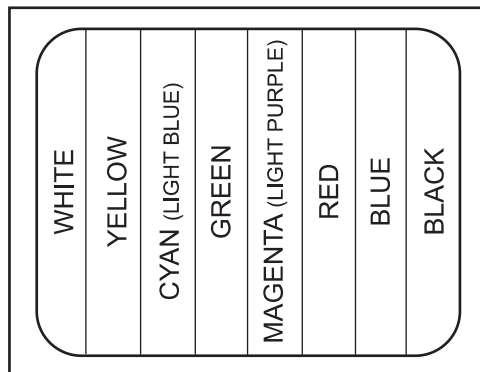

00630

Figure 27. CM6800 Color Bars

PROGRAM PRESETS

Program presets as necessary for your system. Refer to the appropriate keyboard manual for instructions.

ADDITIONAL PROGRAMMING

Refer to the *Programming* section for complete instructions on programming the CM6800.

PROGRAMMING THE CM6800

The CM6800 is shipped from the factory with default programming settings. If the defaults are acceptable, the CM6800 can be operated without any user programming. However, you may want to program the following basic system settings:

- Time and date
- Camera titles
- PTZ control via hardwire data connections
- Alarm contacts
Alarms must be enabled before they are functional.
- Access/Partitioning
All access is set to YES by factory default.
- Communication ports
If you connect your system as illustrated in the Quick Start Guide, you must change the settings for Port 7 or 8 in order to connect remote keyboards.

You can further customize your system with a wide range of programming options, such as:

- select the language displayed on programming screens
- establish monitor group sequences
- set monitor display options
- set alarm handling options
- assign logical camera numbering
- change password
- set auxiliary options

CUSTOMIZING THE CM6800

NOTE: The CM6800 allows system programming from only one monitor at a time. If programming from the CM6800-MGR is sent to the CM6800 at the same time that you are programming from a monitor screen, the system will exit the on-screen programming function.

Pelco provides two options for programming the CM6800 to your specifications:

- Password-protected, on-screen programming screens accessible directly from the Matrix Switcher
- PC-based CM6800-MGR software

Refer to the CM6800-MGR Quick Start Guide for instructions on accessing and using this software to program your system.

NOTE: Pelco strongly recommends uploading your programming settings to the CM6800-MGR to save settings in the event of an accidental reset.





ACCESS PROGRAMMING MODE FROM THE CM6800

NOTE: If you have not already done so, enter the monitor number and press the MON key to select the monitor. On the KBD960/KBR960, the Camera menu appears on the LCD display. Press  to exit the Camera menu.

KBD100/200/300 Keyboards

1. Press the PGM key.

KBD960/KBR960 Keyboards

1. Select .
2. Select .
3. Enter the Define PIN (Default: 1234).
4. Select .
5. Select .

The Password screen appears on the monitor.

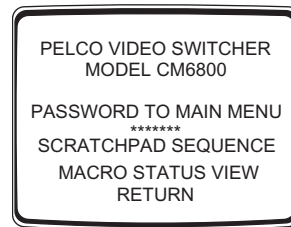
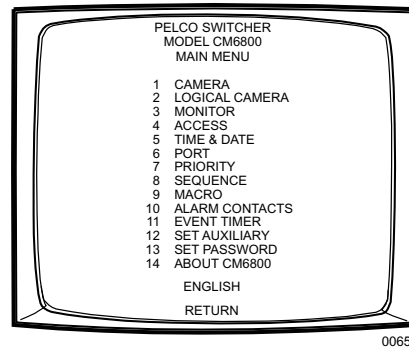

Figure 28. CM6800 Password Screen

At the ***** prompt, enter the DEFAULT PASSWORD: 2899100

The Main Menu appears.



00654

Figure 29. CM6800 Programming Main Menu



If necessary, select the appropriate language.

1. Navigate to the language displayed below the menu options.
2. Scroll through the languages and select the language appropriate for your system.

OPTIONS:
ENGLISH
ESPANOL
DEUTSCH
FRANCAIS
PORTUGUESE
ITALIANO

















3. Navigate to the RETURN field and navigate left or right to return to the Main Menu.

Exit Programming Mode





KBD100/200/300 Keyboards	KBD960/KBR960 Keyboards
<p>To return to active video you can:</p> <ul style="list-style-type: none"> Press the PGM key once while in the Main Menu. Press the PGM key twice from anywhere else in the programming screens. Navigate to the RETURN field and navigate left or right to return to the previous screen or menu. 	<p>To return to active video you can:</p> <ul style="list-style-type: none"> Select  once while in the Main Menu. Select  twice from anywhere else in the programming screens. Navigate to the RETURN field and navigate left or right to return to the previous screen or menu.

NAVIGATE AND SELECT OPTIONS/FIELD ENTRIES IN PROGRAMMING MODE

During programming, a menu appears on the monitor screen. The currently selected field blinks. Use the following keys or joystick on your keyboard to navigate the programming screens.

Function	Keyboard
Navigate programming screens.	KBD100 Use the sequence and macro keys. Left  Right  Up  Down 
	KBD200 Use the Pan/Tilt positioning keys. Left  Right  Up  Down 
	KBD300 Use the joystick. Left  Right  Up  Down 
	KBD960/KBR960 Use the joystick. (See above icons) OR Select the appropriate icon on the KBD960/KBR960 LCD SCREEN. Left  Right  Up  Down 
Access a screen from the Main Menu (or from a submenu).	All Keyboards 1. Navigate down to the desired menu option. 2. Navigate left or right to select the menu option. OR 1. Using the numerical keypad, enter the number of the menu option. 2. Press F1 on the KBD100/200/300 keyboard or select  on the KBD960/KBR960 keyboard.

TIP: To access a screen or enter a value, press a number key on the keyboard and then press F1 (KBD100/200/300) or select  (KBD960/KBR960).

Function	Keyboard
Scroll through options in programming fields.	<p>KBD100/200/300</p> <p>Use F1 and F2. Or (KBD300 only) use the joystick to navigate left or right.</p> <div style="display: flex; justify-content: center; gap: 20px;">   </div> <p>NOTE: The joystick does not scroll options in all fields.</p> <hr/> <p>KBD960/KBR960</p> <p>Select the  or  icons or use the joystick to navigate left or right.</p> <p>NOTE: The joystick does not scroll options in all fields.</p>
Select option in a programming field.	<p>All keyboards</p> <ol style="list-style-type: none"> 1. Scroll through the options until the appropriate entry appears in the field. 2. Navigate to the next field or press PGM to exit. <p>NOTE: On the Monitor and Time & Date screens you must apply the changes (refer to <i>Time & Date</i> or <i>Monitor</i> in this section).</p>
Enter a numerical value in an option field (not available in all fields).	<p>All keyboards</p> <ol style="list-style-type: none"> 1. Using the numerical keypad, enter a number within the range of valid options (example: to enter an internal alarm contact you must enter a number between 1 and 8). 2. Press F1 on the KBD100/200/300 keyboard or select  on the KBD960/KBR960 keyboard.
Access the HELP screen (Sequences, Macros, and Alarm Group screens).	<p>All keyboards</p> <ol style="list-style-type: none"> 1. Navigate to the HELP field. 2. Press F1.
Access the NEXT or PREVIOUS page of a list (not available on every screen).	<p>All keyboards</p> <ol style="list-style-type: none"> 1. Navigate to the NEXT or PREVIOUS field. 2. Press F1.
Exit a screen.	<p>All keyboards</p> <ol style="list-style-type: none"> 1. Navigate to the RETURN field. 2. Navigate left or right. <p>OR</p> <p>Press the PGM key to return to the previous screen or menu.</p>

ABOUT CM6800

The About CM6800 screen displays system version levels.

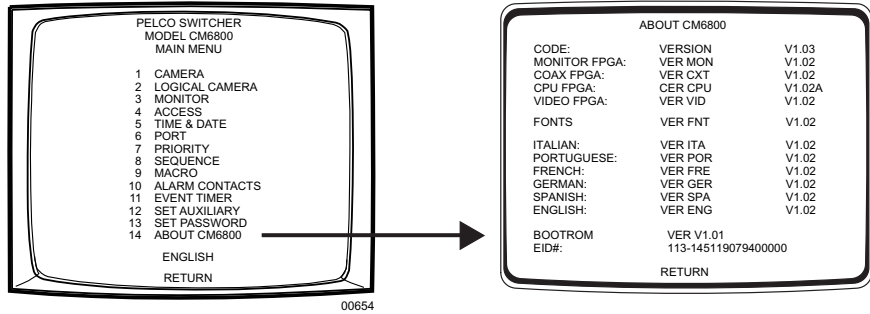

Figure 30. Access the About CM6800 Screen

NOTE: To use partitioning for keyboards, all keyboard addresses must be within a range from 1-8.

ACCESS (SYSTEM PARTITIONING)

The CM6800 supports the following system partitioning to control switching system access:

- Keyboard to Monitor: Restrict a keyboard from accessing selected monitors.
 - Camera to Keyboard: Restrict a keyboard from calling selected cameras to monitors. Or video viewing only; permit the viewing of selected cameras while preventing pan and tilt control.
 - Camera to Monitor: Restrict the viewing of selected cameras on selected monitors.
- All system access is set to YES by default.

Keyboard to Monitor Access

Use the Keyboard to Monitor Access screen to assign keyboards control of specific monitors.

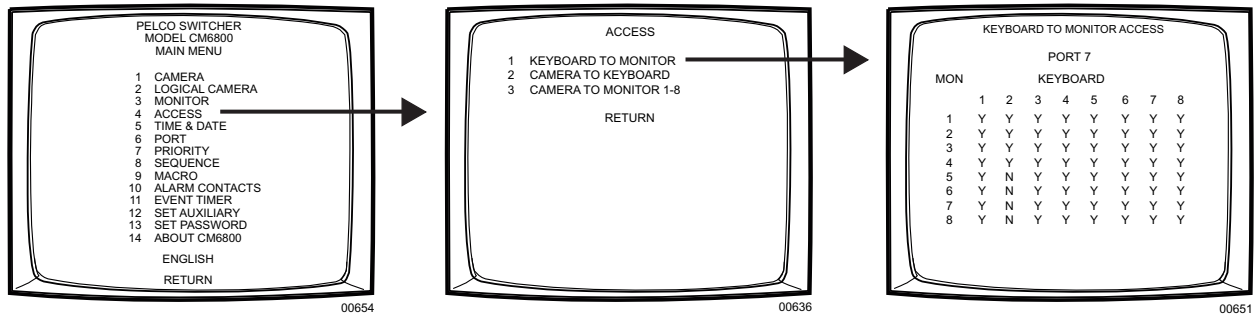

Figure 31. Access the Keyboard to Monitor Access Screen

NOTE: If you connect an ASCII keyboard/device to the CM6800 (COM port 1, 2, 4, 7, or 8), you can connect only one keyboard to a port. Specify access in the first column only (address 1).

PORT: Select the COM port number for which you are programming access control (1-8).

In each monitor row specify the access allowed for each keyboard (address 1-8) to control each specific monitor (1-8).

OPTIONS:
 Y = Yes; control is allowed
 N = No; control is not allowed

Camera To Keyboard Access

Use the Camera to Keyboard Access screen to assign keyboards full control or view-only control of specific cameras.

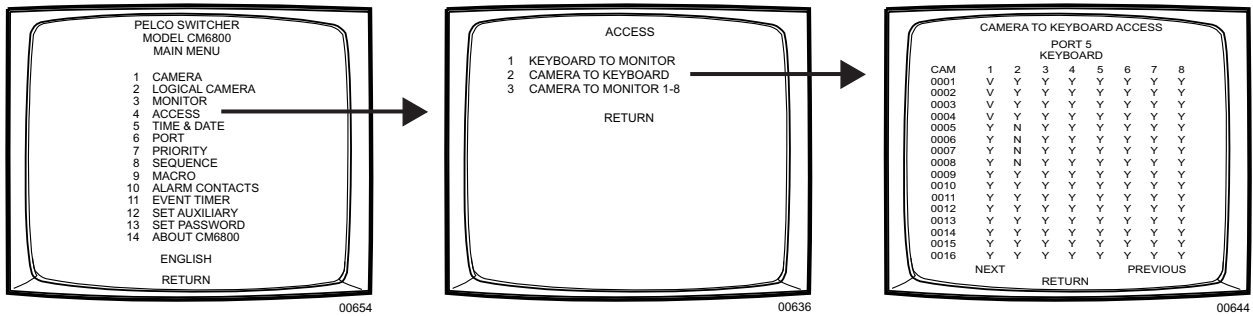

Figure 32. Access the Camera to Keyboard Access Screen

PORT: Select the COM port number for which you are programming access control (1-8); keyboards are identified by their physical connection to the switcher.

In each camera row specify the access allowed for each keyboard (address 1-8) to view and control the specific logical camera number; select NEXT or PREVIOUS to continue to the next group of camera numbers.

OPTIONS:

Y = Yes; viewing and control is allowed

N = No; viewing and control is not allowed

V = View only; camera can be viewed but not controlled

Camera To Monitor Access

Use the Camera to Monitor Access screen to assign monitors viewing access to specific cameras.

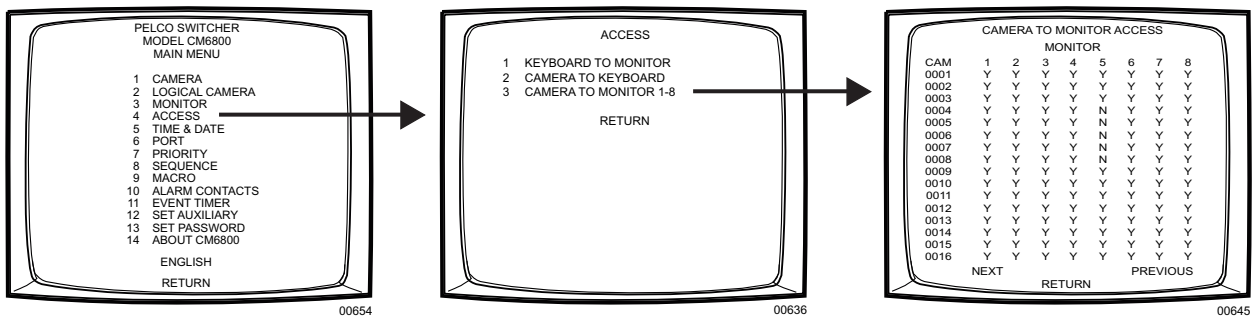

Figure 33. Access the Camera to Monitor Access Screen

In each camera row specify the access allowed for each monitor (1-8) to display the specific logical camera number; select NEXT or PREVIOUS to continue to the next group of camera numbers.

OPTIONS:

Y = Yes; camera can be viewed

N = No; camera cannot be viewed

NOTE: You cannot access the Alarm Contacts screen when an alarm is active. The message MONITOR: 00# IS IN ALARM. ACCESS IS DENIED appears (the appropriate monitor number appears in place of "00#").

ALARM CONTACTS

The CM6800 provides a wide variety of alarm handling and display options. Alarmed cameras can be displayed on one or several monitors as part of one or several alarm groups (each monitor can display only one alarm group.) You can also customize the system to handle alarms in the following ways:

- the order in which alarms are displayed
- automatic or manual acknowledgement of alarms
- activation of auxiliaries by alarms
- automatic activation of presets or patterns
- N.O. or N.C. operation
- priority assignment

Before programming alarm settings, verify that no automated system functions are set to run, such as a macro that would arm or disarm an alarm. Ensure that system operators do not arm or disarm any alarms while you are programming the alarm settings. If an alarm is triggered while you are in the CM6800 programming screens, or while programming a pattern, preset or zone, the system will exit the on-screen programming function and display the alarm on the appropriate monitor(s).

When programming an alarm to appear on a specific monitor, verify that the monitor has access to the camera view triggered by the alarm. Partitioning has priority over alarm programming, so if an alarm is cued to a monitor that does not have access to the appropriate cameras, the camera views cannot be monitored.

Alarm Contact Programming Tasks

To configure the CM6800 internal alarm contacts you must access the Alarm Contact screen to complete the following minimum tasks:

- Enable the alarm contact.
- Specify at least one camera step with a dwell greater than zero for each alarm contact.
- Assign the alarm to at least one alarm group.

The following alarm handling options are set by factory default:

- Acknowledgement type = manual
- Time out = 10 seconds
- Alarm sensor type = N.O. (normally open)
- Priority level = 0
- Alarm group display option = Block Build

To change these defaults, or to configure external alarm contacts, refer to the following sections for detailed programming instructions.

Alarm Group Display Options

To display on a monitor, an alarm must be assigned to an alarm group (A-H). Before programming alarms you may want to determine the alarm display format for each alarm group. An alarm can include up to eight steps, so eight camera views could display as a part of each alarm.

A priority alarm appears on system monitors before non-priority alarms, despite the order specified by the alarm group assignment. In the examples below, all alarms are at the same priority level. Refer to the PRIORITY description in *Program Internal and External Alarms*.

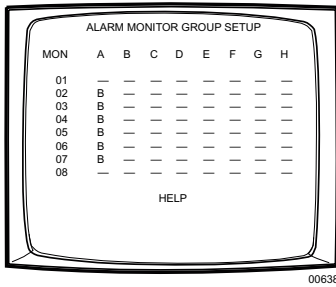

BLOCK BUILD

Alarmed cameras are displayed across a block of alarm monitors in a sequential order. All steps programmed for the alarm contact appear on the designated monitor.

Example: Eight alarms set to display on monitors 02-07 will appear in the following order:

Monitor	1st Display Cycle	Next Display Cycle	Acknowledging Alarms 1 & 2	Next Display Cycle
02 B	1st alarm	1st and 7th alarms cycle	Acknowledge 1st alarm	7th alarm
03 B	2nd alarm	2nd and 8th alarms cycle	Acknowledge 2nd alarm	8th alarm
04 B	3rd alarm	3rd alarm	3rd alarm	3rd alarm
05 B	4th alarm	4th alarm	4th alarm	4th alarm
06 B	5th alarm	5th alarm	5th alarm	5th alarm
07 B	6th alarm	6th alarm	6th alarm	6th alarm

New alarms display on the lowest monitor number with the fewest alarms cycling.

CHRONOLOGICAL PAIR: D AND Q

The oldest alarm of a specific group is displayed on one designated monitor, while all other alarms in the group are sequenced on the second designated monitor. All steps programmed for the alarm contact appear on the designated monitor.

Example: Four alarms set to display on monitors 04 and 05 will appear in the following order:

Monitor	1 Alarm	2 Alarms	3 Alarms	4 Alarms
04 D	1st alarm	1st alarm	1st alarm	1st alarm
05 Q		2nd alarm	2nd and 3rd alarms cycle	2nd, 3rd, and 4th alarms cycle

You must acknowledge alarms in a chronological pair from the display monitor (D). Then the next oldest alarm moves to the display monitor and the remaining alarms continue to cycle through the queue monitor (Q). This format requires you to acknowledge each alarm in the order in which they occur.

Acknowledging alarms in this example:

Monitor	1st Cycle	Next Cycle	Next Cycle	Next Cycle
04 D	Acknowledge 1st alarm	Acknowledge 2nd alarm	Acknowledge 3rd alarm	Acknowledge 4th alarm
05 Q	2nd, 3rd, and 4th alarms cycle	3rd and 4th alarms cycle	4th alarm	

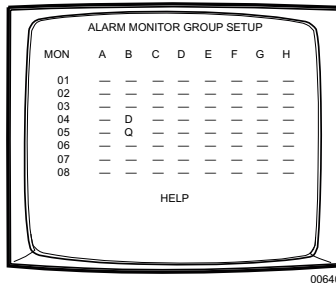

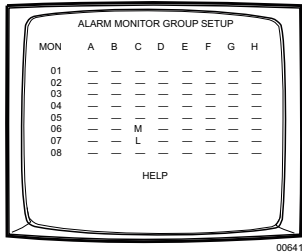

REVERSE CHRONOLOGICAL PAIR: M AND L

The most recent alarm of a specific group is displayed on one designated monitor, while all other alarms in the group are sequenced on the second designated monitor. All steps programmed for the alarm contact appear on the designated monitor.

Example: Four alarms set to display on monitors 06 and 07 will appear in the following order:

Monitor	1 Alarm	2 Alarms	3 Alarms	4 Alarms
06 M	1st alarm	2nd alarm	3rd alarm	4th alarm
07 L		1st alarm	1st and 2nd alarms cycle	1st, 2nd, and 3rd alarms cycle

You must acknowledge alarms in a reverse chronological pair from the display monitor (M). Then the next most recent alarm moves to the display monitor and the remaining alarms continue to cycle through the queue monitor (L). This format requires you to acknowledge each alarm in the reverse order from which they occurred.

Acknowledging alarms in this example:

Monitor	1st Cycle	Next Cycle	Next Cycle	Next Cycle
06 M	Acknowledge Alarm 4	Acknowledge Alarm 3	Acknowledge Alarm 2	Acknowledge Alarm 1
07 L	Alarms 1, 2, and 3 cycle	Alarms 1 and 2 cycle	Alarm 1	

SALVO SWITCHING

Multiple camera views within the alarm contact programming (the "steps") are displayed simultaneously as a group across a set of monitors. When a new alarm triggers, all monitors switch to the new alarm at the same time.

When programming a Salvo Group:

- Program the Salvo Group to display across a number of monitors equal to the number of steps in the alarm contact(s); for example if the alarm contact has six steps, set the Salvo Group to display on six monitors. If an alarm contact contains more steps than monitors defined for the Salvo Group, the additional steps do not appear on a monitor during the alarm.
- Each alarm contact assigned to the Salvo Group should contain the same number of steps.
- The Salvo Group switches based on the dwell time entered for the first step in the alarm contact.

Example: Two alarm contacts with three steps display on three monitors will appear as follows:

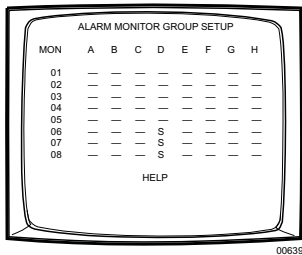

Monitor	1 Alarm	2 Alarms	Next Display Cycle	After Acknowledging 1st Alarm
06 S	1st alarm, step 1	2nd alarm, step 1	1st alarm, step 1	2nd alarm, step 1
07 S	1st alarm, step 2	2nd alarm, step 2	1st alarm, step 2	2nd alarm, step 2
08 S	1st alarm, step 3	2nd alarm, step 3	1st alarm, step 3	2nd alarm, step 3

Internal and External Alarms

Use the Internal Alarm screen to configure the eight internal alarm inputs on the rear panel of the matrix switcher/controller; internal inputs are programmable to associate any camera to any input. When an internal alarm is triggered, the alarm icon and an "I" appear on designated system monitors.

Use the External Alarm screen to configure the alarm inputs on external devices; up to 128 additional inputs are available by connecting up to two ALM2064 Alarm Interface Units. When an external alarm is triggered, the alarm icon and an "E" appear on designated system monitors.

The procedure for programming internal and external alarms is the same, except for selecting the alarm input type (the TYPE field on the Internal Alarm screen). Set the external alarm input type (N.O. or N.C.) through the ALM2064 Alarm Interface Unit. Refer to the ALM2064 Alarm Interface Unit Installation/Operation Manual for instructions.

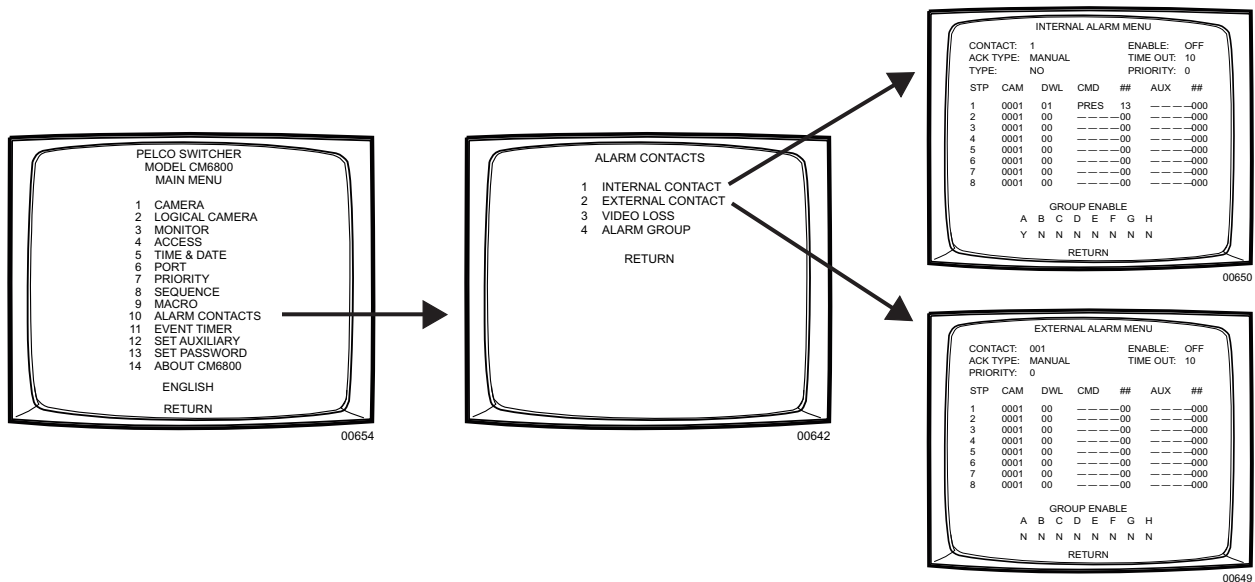

Figure 34. Access the Internal or External Alarm Screen

- CONTACT:** Select the alarm input number for programming.
- OPTIONS:**
Internal alarms: 1-8
External alarms: 1-128
- ENABLE:** Enable the alarm contact by selecting ON (Default = OFF); to complete the process of enabling an alarm contact, you must also
- set at least one camera with a dwell time greater than 0 (refer to the STP description),
 - assign the alarm contact to an alarm group (refer to the GROUP ENABLE description).
- ACK TYPE:** Select the alarm clearance type.
- OPTIONS:**
MANUAL = alarm must be acknowledged from a system keyboard
AUTO = alarm will time out automatically after the interval specified in the TIME OUT field

NOTE: *The auxiliaries on the rear panel of the CM6800 are activated by global auxiliary numbers 1, 2, and 3*

- TIME OUT:** Enter the amount of time (0-99 seconds) alarm remains active after the contact has cleared (AUTO alarms only).
- TYPE:** Select the alarm input type (Internal Alarms only).
- OPTIONS:**
 N.O. = normally open
 N.C. = normally closed
- PRIORITY:** Select the priority level of the alarm; a priority alarm appears on system monitors before a non-priority alarm.
- OPTIONS:**
 0 = non-priority
 1 = priority
- STP:** Each alarm contact can include up to eight steps to be activated as a result of this alarm. For each step select entries in the following fields as necessary.
- CAM:** Enter the logical number of the camera to be displayed; must be a valid logical number (0001-9998).
- DWL:** Enter the amount of time the camera view is displayed in an alarm sequence (0-99 seconds); to enable the alarm contact you must set at least one camera with a dwell time greater than 0.
- CMD and ##:** Select a camera operation; if you select a pattern or a preset, enter a valid pattern or preset number.
- OPTIONS:**
 PRES = preset
 PATT = pattern
 RSCN = random scan
 FSCN = frame scan
 SSCN = stop scan
- AUX and ##:** Select an auxiliary to be activated.
 Global = internal and external auxiliaries.
- OPTIONS:**
 GON = turn global auxiliary on (1-128)
 GOFF = turn global auxiliary off (1-128)
 CON = turn camera auxiliary on (1-8)
 COFF = turn camera auxiliary off (1-8)
- GROUP ENABLE:** Assign the alarm contact to one or more alarm groups (A through H).
- OPTIONS:**
 Y = include in group
 N = do not include in group

Video Loss Alarm

You can program the CM6800 to detect video loss from any camera input and indicate the loss through alarm mode – the alarm icon and a “V” (for video loss) appear on system monitors as specified by alarm group assignment.

Use the Video Loss screen to configure the system to display an alarm based on video loss.

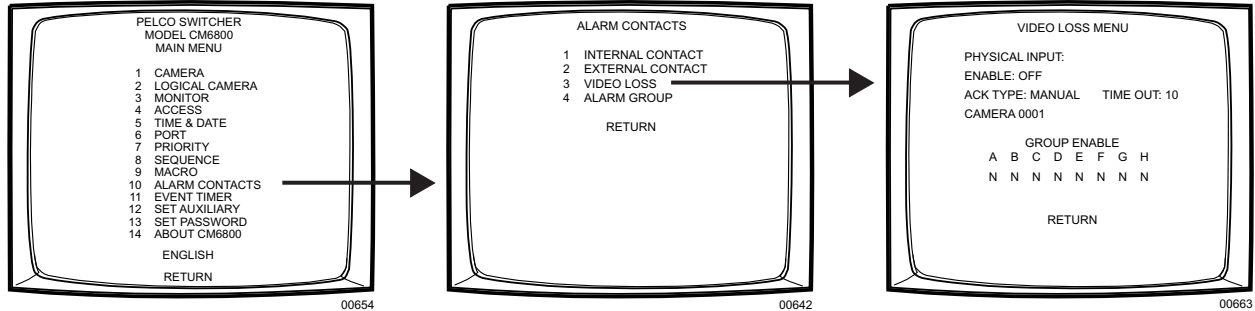

Figure 35. Access the Video Loss Screen

PHYSICAL INPUT: Select the physical input number; the logical camera number associated with the specific physical input appears on the screen below.

ENABLE: Enable video loss detection for the specific video input by selecting ON (Default = OFF); to complete the enable process, you must also assign the alarm contact to an alarm group (refer to the GROUP ENABLE description).

ACK TYPE: Select the video loss alarm clearance type.

OPTIONS:

MANUAL = alarm must be acknowledged from a system keyboard
 AUTO = alarm will time out automatically after the interval specified in the TIME OUT field

TIME OUT: Enter the amount of time (0-99 seconds) alarm remains active after the video has been restored (AUTO alarms only).

CAMERA 0001: The logical camera number associated with the physical input specified in the PHYSICAL INPUT field appears here.

GROUP ENABLE: Assign the video loss alarm to one or more alarm groups (A through H).

OPTIONS:

Y = include in group
 N = do not include in group

Alarm Groups

Use the Alarm Group screen to configure alarm groups to appear on system monitors. To display on a monitor, an alarm must be assigned to an alarm group.

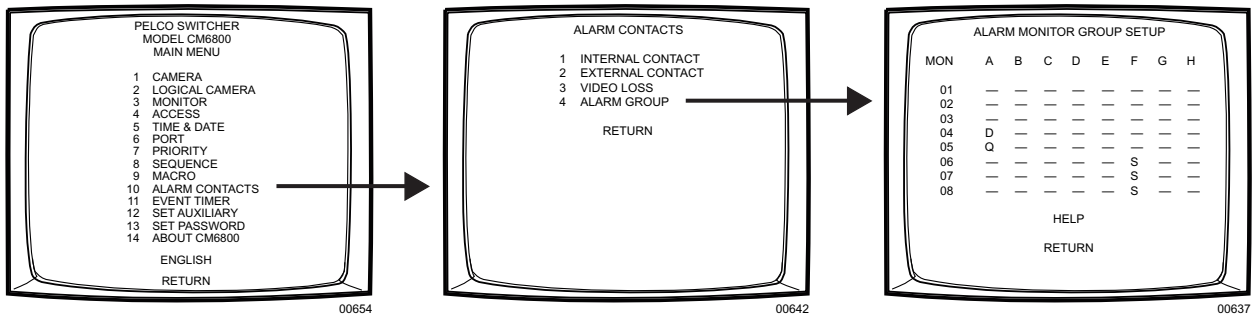

Figure 36. Access the Alarm Group Screen

Specify the display option for up to eight alarm groups (A through H). Refer to the Alarm Group Display Options in this section. If you make an error in assigning alarm groups, the message "ERROR IN GROUP" appears.

Display Option Entry	Display Option Type	Number of Monitors Displaying Each Alarm Group
B	block build	up to eight
D and Q	chronological pair	one display monitor (D), one queue monitor (Q)
M and L	reverse chronological pair	one display monitor (M), one queue monitor (L)
S	salvo switching	from two to eight

AUXILIARY OUTPUTS

The three local auxiliary (AUX) outputs on the rear panel of the CM6800 can be operated manually from a system keyboard or automatically in response to an alarm.

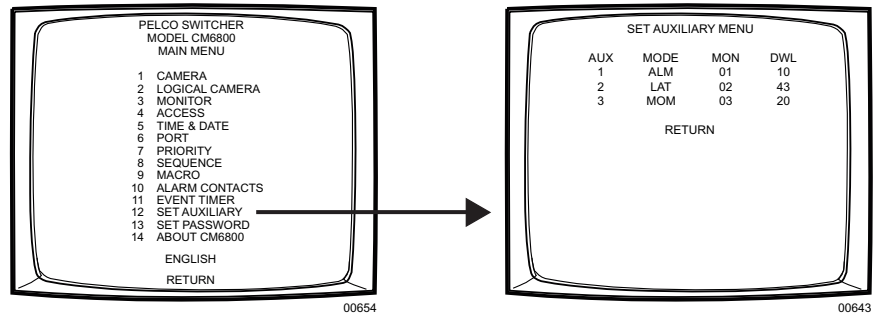

Figure 37. Access the Set Auxiliary Screen

MODE: For each auxiliary select the operation mode.

OPTIONS:

ALM = activate the auxiliary as a response to an alarm; if you select this mode, specify the monitor number and dwell time

LAT = latching operation

MOM = momentary operation

Specify values for the MON and DWL fields only when you select ALM in the MODE field.

MON: Specify the number of the monitor the auxiliary will follow (01-08).

DWL: Specify the amount of time the auxiliary will remain active after there is no longer an alarm displayed on a monitor (01-99 seconds). The alarm is displayed on a monitor until

- the alarm is acknowledged manually (if MANUAL is selected in the alarm contact ACK TYPE field),
- the alarm contact times out (if AUTO is selected in the alarm contact ACK TYPE field).

Refer to the ACK TYPE description in *Internal and External Alarms* and in *Video Loss Alarm*.

CAMERA

Use the Camera screen to configure settings for each camera connected to the CM6800.

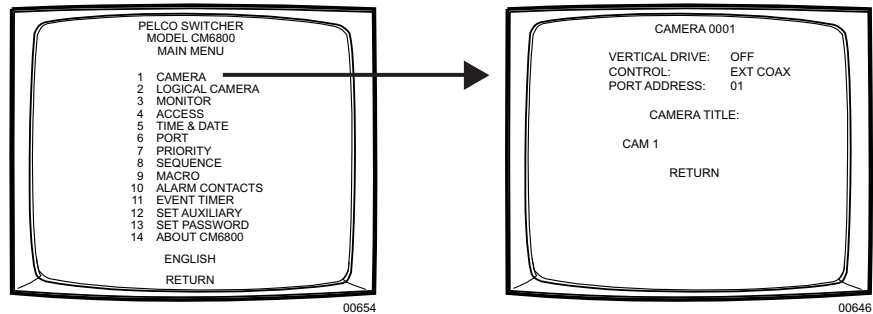

Figure 38. Access the Camera Screen

NOTE: The following Pelco cameras are compatible with the vertical drive option:

CC3500H-2
 CC3500S-2
 CC3600H-2
 CC3551H-2
 MC3600H-2
 MC3651H-2
 MC3500S-2

CAMERA: Select the logical number of the camera (video input) to be defined (0001-9998).

NOTE: To select logical numbers other than the default numbers (001 to 0048) you must first program the logical numbering in the Logical Camera screen. Refer to Logical Camera Numbers in this section.

VERTICAL DRIVE: Enable Vertical Drive (ON) to synchronize Pelco cameras that have the ability to accept a synchronization pulse via the coax cable.

CONTROL: Select the receiver control type for the device connected to this input; that is, the type of receiver communication you will use to control a camera's pan and tilt and lens (if applicable).

OPTIONS:
 EXT COAX: Coaxitron extended mode (32-bit)
 STD COAX: Coaxitron standard mode (15-bit)
 MUX: Genex multiplexer
 PTZ-A: RS-422 Control Port A
 PTZ-B: RS-422 Control Port B

NOTE: If you select PTZ-A or PTZ-B you must also specify the port address (in the following field) and program Serial Port 9 or 10 (refer to Ports in this section).

PORT ADDRESS: Required only for Genex multiplexer or RS-422 control.

Genex multiplexer: Select the address of the multiplexer (01-32); this address must match the unit ID specified through multiplexer programming. Refer to the MX4000 Genex Series Simplex and Duplex Multiplexers Installation/Operation Manual.

RS-422 cameras connected through PTZ-A or PTZ-B: Select the camera/device address for RS-422 control (01-32). The port address must match the address setting configured through the camera/receiver DIP switch settings.

CAMERA TITLE: The camera title (up to 20 alphanumeric characters) appears on the monitor during real-time camera display (refer to Monitor Display in this section). Use F1 and F2 to scroll through the characters; once you reach the desired character for a position, navigate to the next position. The default characters are 26 upper case letters and the numbers 0-9. You can add special characters, such as letters with accent marks used in other languages, through the CM6800-MGR (refer to the CM6800-MGR Quick Start Guide).

EVENT TIMERS

You can automate system operation to activate sequences or macros on specific monitors. Events can be scheduled on a daily or weekly basis, or on a specific date such as a holiday. If you set more than one timer to start at the same time, the timers will run in the following order of precedence: weekly, special, daily.

On each event timer screen:

- Two methods are provided for selecting the event time: scrolling through time values or entering a valid hour and minute.
- Each timer can activate either a macro or a sequence. Select a value for either the MACRO field or the SEQ field.
- A macro started by an event timer runs until the last step is completed (unless you specify a loop in the macro).
- A sequence started by an event timer runs continuously until another sequence or macro begins, or until a system operator selects a different camera.

Daily Timer

Use the Daily Timer screen to schedule up to 32 daily events.

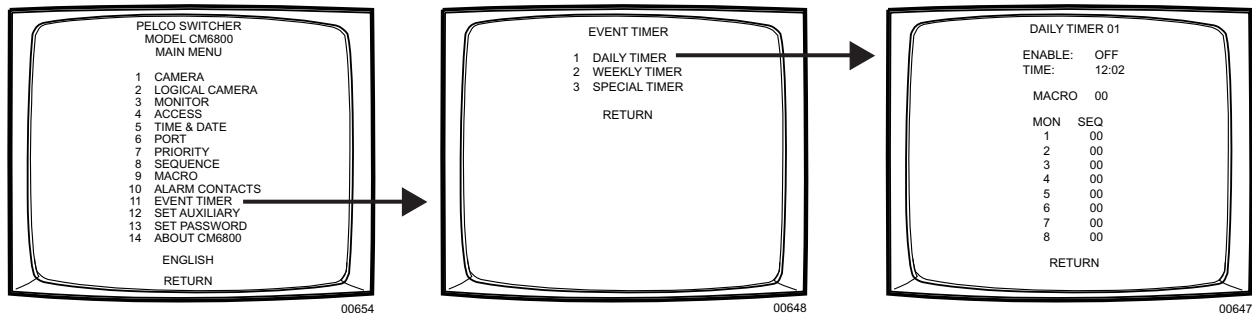

Figure 39. Access the Daily Timer Screen

- DAILY TIMER: Select the timer number (01-32).
- ENABLE: Enable (ON) or disable (OFF) the timer.
- TIME: Set the hour and minute at which the event is to begin (24-hour time).
- MACRO: To activate a macro, select a valid macro number (01-32).
- SEQ: To activate a sequence, select a valid sequence number (01-16) to run on a specific monitor.

Weekly Timer

Use the Weekly Timer screen to schedule up to 32 weekly events.

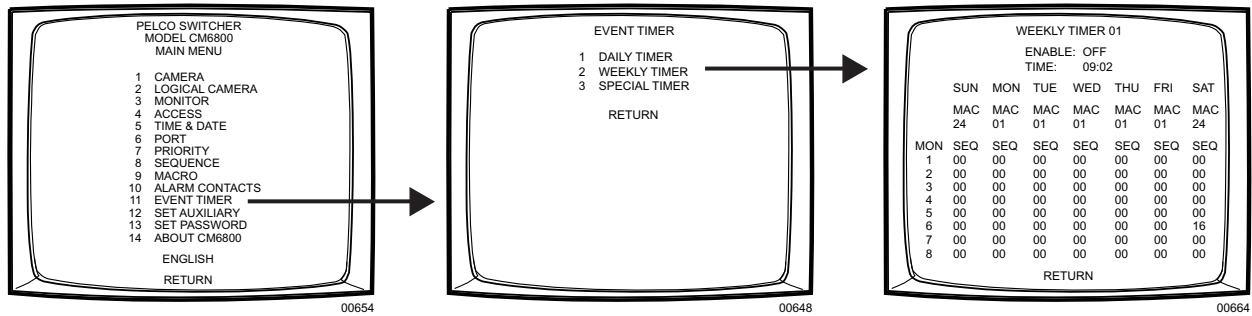

Figure 40. Access the Weekly Timer Screen

WEEKLY TIMER: Select the timer number (01-32).

ENABLE: Enable (ON) or disable (OFF) the timer.

TIME: Set the hour and minute at which the event is to begin (24-hour time).

MACRO: To activate a macro, in the column under the desired day of the week, select a valid macro number (01-32).

SEQ: To activate a sequence, in the column under the desired day of the week, select a valid sequence number (01-16) to run on a specific monitor.

Special Timer

Use the Special Timer screen to schedule up to 32 events on a specific date(s).

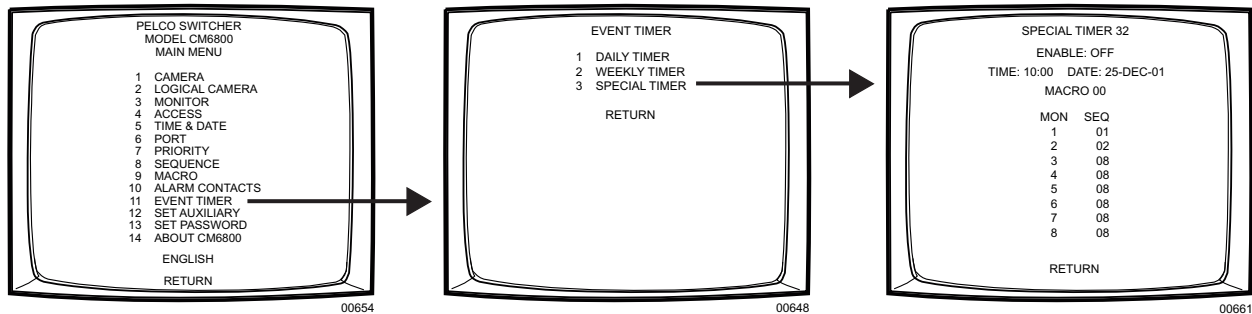

Figure 41. Access the Special Timer Screen

SPECIAL TIMER: Select the timer number (01-32).

ENABLE: Enable (ON) or disable (OFF) the timer.

TIME: Set the hour and minute at which the event is to begin (24-hour time).

DATE: Select the date on which the event is to begin (DD-MMM-YY).

MACRO: To activate a macro, select a valid macro number (01-32).

SEQ: To activate a sequence, select a valid sequence number (01-16) to run on a specific monitor.

LOGICAL CAMERA NUMBERS

A logical number is a user-selectable, variable number, and is always associated with an actual physical input. A physical input number represents an actual BNC input on the rear panel of the CM6800 and is a fixed number. Within the programming screens and at the operator level the logical number is the number used for reference.

Example of a logical numbering plan:

Physical input number	Location in store	Logical number
Cameras 1-5	First floor	11-15
Cameras 6-12	Second floor	21-27

Use the Logical Camera screen to assign new logical numbers as appropriate for your system.

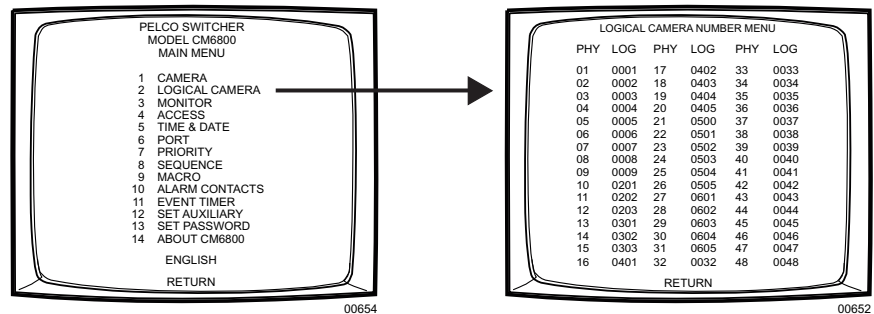

Figure 42. Access the Logical Camera Number Screen

PHY: The physical input number represents an actual BNC input on the rear panel of the CM6800 and cannot be changed.

LOG: Assign a valid logical number (0001-9998) to each physical camera input. A valid number is any number from 0001 to 9998 that has not already been assigned to a physical camera input.

Example: In Figure 43, physical camera input 22 is assigned a logical number of 0501. To view this camera an operator will do the following:

1. Enter 501.
2. Press the CAM key.

Using the new logical camera number:

If you change a logical camera number in the programming menus, you cannot control the camera until you select the camera number from the keyboard:

1. Enter the new logical camera number.
2. Press the CAM key.

The CM6800 automatically updates all other usages of the logical camera number, such as in sequences and macros.

MACROS

Macros simplify operator control by grouping multiple functions into a single command. Use the Macros screen to program up to 32 system macros.

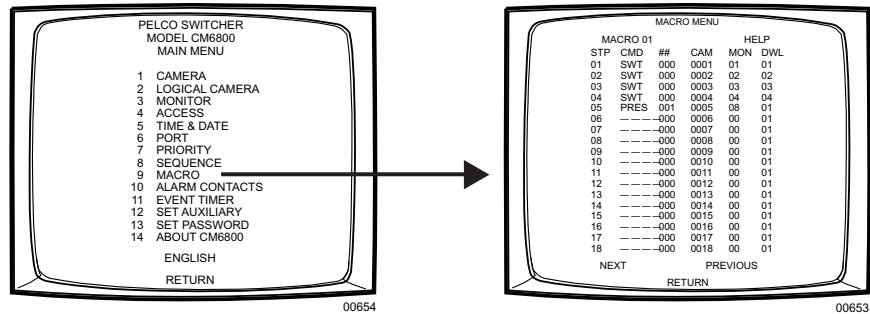

Figure 43. Access the Macro Screen

MACRO: Select the macro number you want to program (1-32).

STP: Each macro can include up to 72 steps. For each step select entries for the following fields as necessary:

CMD: Select a command. In addition, enter a valid number in the specified additional field(s); for example, if you select PATT, enter a pattern number in the Command # field, a camera number in the Camera field, and a monitor number in the Monitor field.

Refer to Table H in the *Appendix* for a description of each command and the additional fields required for each command.

##: If applicable, enter a valid number associated with the command selected.

CAM: If applicable, enter a logical camera number. To select logical numbers other than the default numbers (1 to 48), you must first program the logical numbering in the Logical Camera window. Refer to the *Logical Camera Numbers* section.

MON: If applicable, enter a monitor number.

DWL: If desired, enter a dwell time (1-99 seconds); the dwell time is the period the macro halts before continuing to the next step. The default dwell time is two seconds.

MACRO STATUS VIEW SCREEN

The Macro Status View screen provides a status view of each system macro (1-32). For each active macro the current status (RUN or HOLD) and the number of the next macro step is displayed. If a macro is not running, the status is IDLE and the step number is 00.

A system operator can display the Macro Status View screen without entering password-protected programming screens.

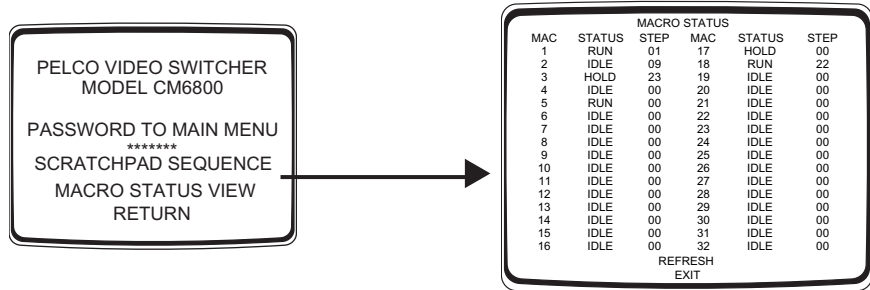

Figure 44. Macro Status View Screen

MONITOR DISPLAY

Use the Monitor screen to adjust monitor display settings for your system. You can adjust settings for the current monitor only (CURRENT) or for all system monitors (ALL).

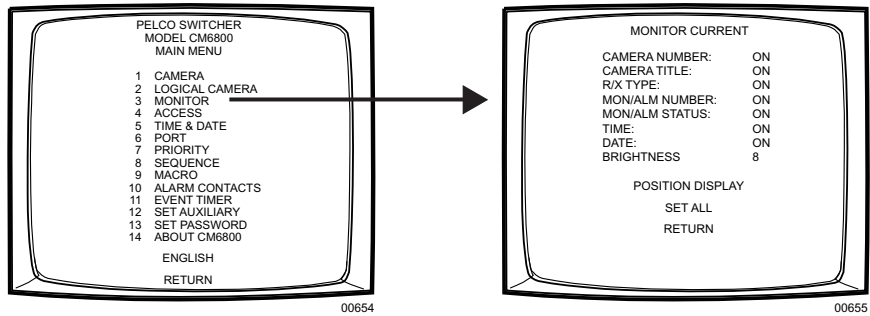
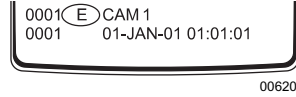
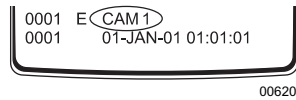
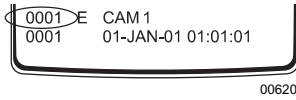

Figure 45. Access the Monitor Screen



MONITOR: Select CURRENT to program the monitor display for the monitor you are currently operating or ALL for all monitors connected to the CM6800.

If you select ALL, you must navigate left or right in the SET ALL field to apply programming changes (refer to the SET ALL field description).

CAMERA NUMBER: Enable (ON) or disable (OFF) on-screen display of the logical camera number.

CAMERA TITLE: Enable (ON) or disable (OFF) on-screen display of the camera title (maximum of 20 alphanumeric characters).

R/X TYPE: Enable (ON) or disable (OFF) on-screen display of the camera control type. The letter displayed on the monitor reflects the receiver control type selected in the CONTROL field on the Camera screen.

R/X TYPE DISPLAY VALUES:

- E = Coaxitron extended mode (32-bit)
- S = Coaxitron standard mode (15-bit)
- M = Genex multiplexer
- P = PTZ-P (RS-422 through Control Port PTZ-A or PTZ-B)
- D = PTZ-D (RS-422 through Control Port PTZ-A or PTZ-B)

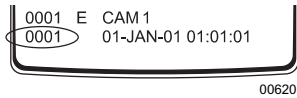

00620

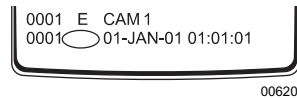

00620

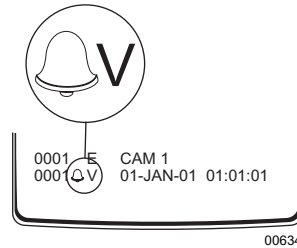

00634

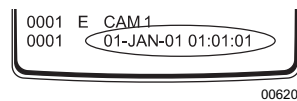

00620



00633

MON/ALM NUMBER: Enable (ON) or disable (OFF) on-screen display of the monitor/ alarm number. During normal operation, the monitor number appears in this field. The monitor number is a fixed number, representing an actual BNC output on the rear panel of the CM6800. When an alarm is active, the alarm number appears in this field. The alarm number represents an alarm contact – the physical alarm input number of an internal alarm contact, or the address of an external alarm contact as configured on the Alarm Interface Unit.

MON/ALM STATUS: Enable (ON) or disable (OFF) on-screen display of the monitor or alarm status.

MONITOR STATUS DISPLAY VALUES:

Blank = normal status
H = hold
S = sequence

NOTE: If an operator presses the HOLD key while an alarm appears on the monitor, the H does not appear. The alarm icon and alarm status value blink to indicate the HOLD status.

ALM STATUS DISPLAY VALUES:

I = internal alarm
E = external alarm
V = video loss alarm

TIME: Enable (ON) or disable (OFF) on-screen display of the time as programmed in the system.

DATE: Enable (ON) or disable (OFF) on-screen display of the date as programmed in the system.

BRIGHTNESS: Select the brightness level of the on-screen display (1-8; 8 = white characters, 1 = black characters; 2-7 = shades of gray).

If you select CURRENT in the MONITOR field, you can see the brightness level change as you scroll through the options.

If you select ALL in the MONITOR field, the changes do not take effect until you apply changes in the SET ALL field.

POSITION DISPLAY: Navigate left or right to select the Test Positioning Menu.

The real-time camera display appears with Test Positioning Menu text superimposed on the screen. Use the position keys or joystick to move the text to the desired position on the screen. The text moves one line or character position at a time.

Press the PGM key to exit the test positioning menu.

SET ALL: To apply monitor display changes to all system monitors (if you selected ALL in the MONITOR field) you must navigate left or right in the SET ALL field; otherwise monitor display settings are not changed.

If you selected CURRENT in the MONITOR field, navigating left or right in the SET ALL field has no effect.

PASSWORD

Use the Set Password screen to change the system password.

If you change the password and then forget the new one, you will have to reset the system to the factory defaults. All system programming will be lost. Pelco recommends uploading your programming settings to the CM6800-MGR before changing the password. This allows you to download the previous system settings, in the event of a system reset. If necessary, refer to the *Troubleshooting* section for the system reset procedure.

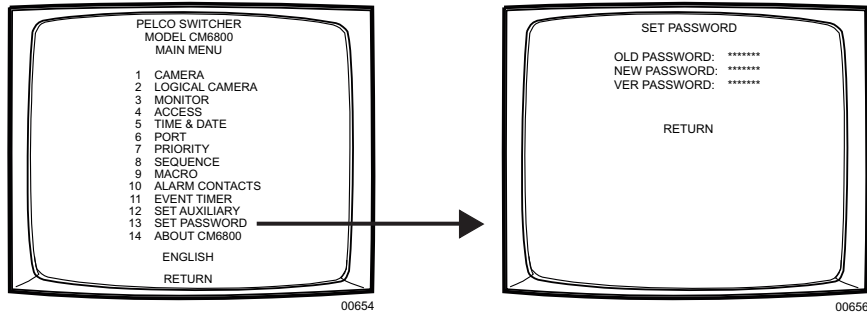

Figure 46. Access the Set Password Screen

OLD PASSWORD: Enter the current password (Default: 2899100). If you make a mistake entering the old password, the message "WRONG OLD PASSWORD. TRY AGAIN!" appears. Re-enter the old password correctly.

NEW PASSWORD: Using the numerical keypad, enter the new password. The password must be seven digits.

VER PASSWORD: Enter the new password again as a verification check. If you make a mistake entering the verification password, the message "VERIFIED PASSWORD DOESN'T MATCH" appears. Re-enter the verification password correctly.

Once the new password is accepted, the Main Menu appears.

PORTS (SERIAL/COM PORTS)

Use the Port screen to configure the settings for each device connected to a Serial/COM port on the rear panel of the CM6800.

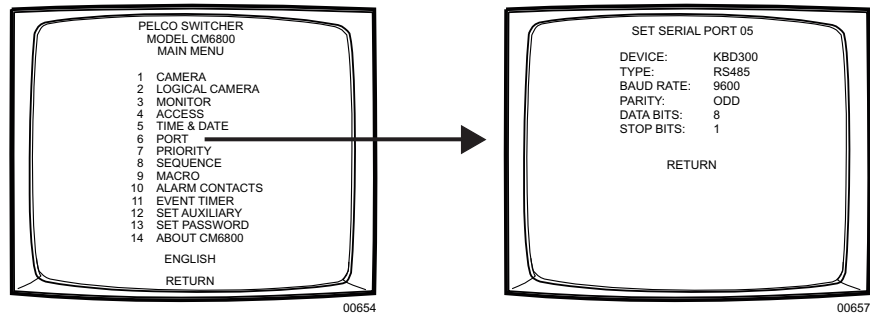

Figure 47. Access the Port Screen

NOTE: In the programming screens "KBD300" is used to refer to the KBD100, KBD200, and KBD300 keyboards.

SET SERIAL PORT: Select the number of the desired Serial Port/COM port (01-10).

The serial port numbers correspond to the communication ports on the CM6800 rear panel as follows:

Serial Port	Input on CM6800 rear panel
01	COM 1 NOTE: COM 1 can be accessed through a DB9 input or an RJ-45 port.
02-08	COM 2-8 RJ-45 inputs
09	PTZ-A control input
10	PTZ-B control input

DEVICE: Select the device connected to the COM port; the values in the TYPE, BAUD RATE, PARITY, DATA BITS, and STOP BITS fields change to the settings appropriate for the specific device.

TYPE: If necessary, and if allowed, select the desired communication type (RS-232, RS-422, or RS-485).

BAUD RATE: Select the desired baud rate.

PARITY: Select the desired parity type.

DATA BITS: This value cannot be changed.

STOP BITS: This value cannot be changed.

PRIORITY CONTROL

The CM6800 provides eight levels of priority control. Each level defines the ability of a keyboard to control a pan/tilt/zoom (camera positioning system) and to access programming screens.

Priority level applies system wide; a keyboard assigned priority level 2 on COM port 8 has a higher priority than a keyboard assigned priority level 4 on COM port 5. A higher level keyboard takes precedence over a lower level keyboard when the keyboards are issuing control commands.

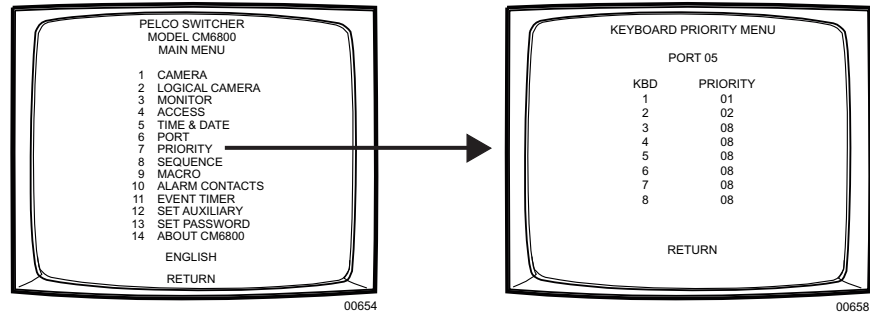

Figure 48. Access the Priority Screen

NOTE: You can connect only one ASCII keyboard/device per port on the CM6800 (COM port 1, 2, 4, 7, or 8). For ASCII keyboards priority control is based on the entry for keyboard 1.

- PORT: Select the COM port number for which you are programming priority control.
- PRIORITY: For each keyboard connected to the specified port, assign a priority level (01-08).
- OPTIONS:
 Level 1 = highest priority
 Level 8 = lowest priority
- Levels 1 - 4 have the ability to access programming screens. Levels 5-8 cannot access programming screens. The lowest level or keyboards located at the same level will access devices on first-come, first-served basis.

SEQUENCES

The CM6800 provides two types of sequences:

- An operator can program a **scratchpad sequence** from an individual monitor, without accessing password-protected programming screens.
- **System sequences** are password-protected and can run on any system monitor.

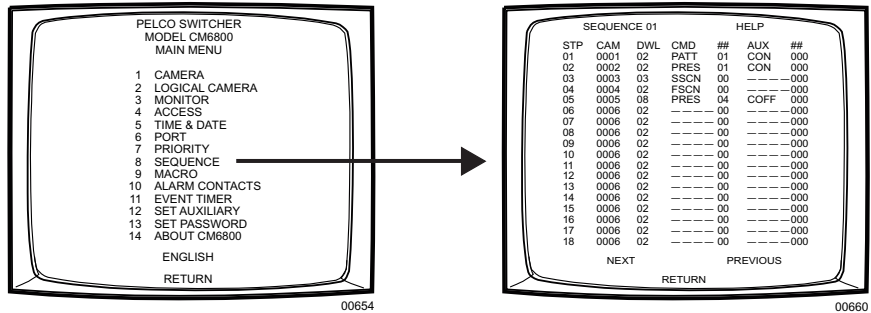

Figure 49. Access the Sequence Screen

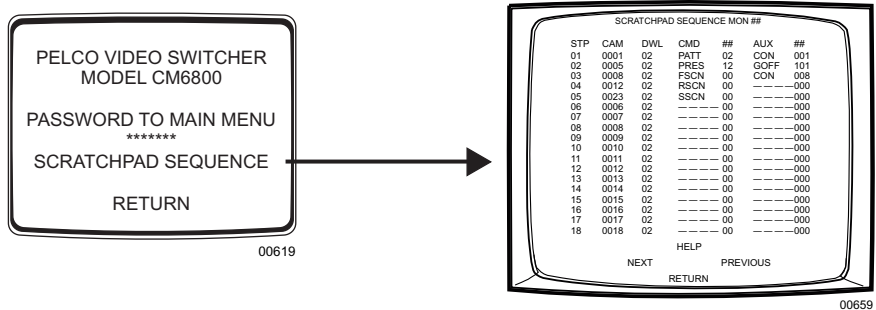

Figure 50. Access the Scratchpad Sequence Screen

- SEQUENCE: Select the sequence number you want to program (1-16).
- STP: Each sequence can include up to 72 steps. For each step select entries for the following fields as necessary:
- CAM: Enter the desired camera number (logical number).
- DWL: Enter the dwell time (01-99 seconds).
- CMD and ##: Select a command; if you select a pattern or a preset enter a valid pattern or preset number.
- OPTIONS:
 PRES = preset
 PATT = pattern
 RSCN = random scan
 FSCN = frame scan
 SSCN = stop scan
- AUX and ##: Select an auxiliary to be activated.
 Global = internal and external auxiliaries.

- OPTIONS:
 GON = turn global auxiliary on (1-128)
 GOFF = turn global auxiliary off (1-128)
 CON = turn camera auxiliary on (1-8)
 COFF = turn camera auxiliary off (1-8)

NOTE: The auxiliaries on the rear panel of the CM6800 are activated by global auxiliary numbers 1, 2, and 3.

TIME AND DATE

Use the Time and Date screen to set the system time and date settings. The time and date displayed on the monitor during real-time camera display is the time set in the memory through this screen. The system time and date information is kept current in battery-backed RAM. New time and date information will be set when you apply the changes (refer to the SET TIME & DATE field description).

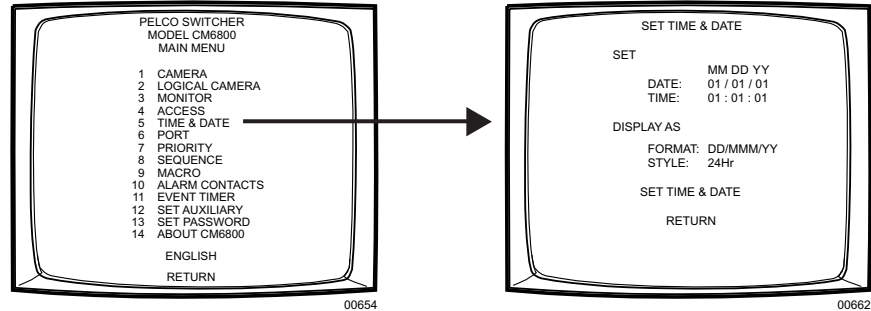

Figure 51. Access the Time and Date Screen

DATE: Select or enter the month, day, and year of the desired system date.

TIME: Select or enter the hour, minute, and second of the desired system time.

FORMAT: Select the on-screen date format.

- OPTIONS:**
 DD/MMM/YY
 MMM/DD/YY
 YY/MMM/DD
 DD/MM/YY
 MM/DD/YY
 YY/MM/DD

STYLE: Select the on-screen time format. This setting affects the on-screen time displayed on system monitors only. System functions programmed through the event timers (refer to Event Timers in this section) are based on 24-hour time settings.

- OPTIONS:**
 24Hr
 AM/PM (12 Hr)

SET TIME & DATE: You must navigate left or right in the SET TIME & DATE field to apply the changes.

PATTERNS, PRESETS, AND ZONES

Special characters added through the CM6800-MGR may not be available with your camera positioning system. Preset, pattern, and zone labels containing special characters will appear on the monitor with blanks in place of the special characters.

Refer to the Operation section for instructions on creating patterns. Refer to your keyboard manual for instructions on programming presets and zones.

OPERATION

OVERVIEW

A brief description of CM6800 operation is provided here. Refer to the following sections for detailed instructions and options.

Install the CM6800 and connect all system devices.	Refer to the <i>Installation</i> section.
Power-up the system.	Refer to the <i>System Start-up</i> section.
Switch monitor.	<ol style="list-style-type: none">1. Enter the monitor number.2. Press the MON key.
Select camera.	<ol style="list-style-type: none">1. Enter the camera number.2. Press the CAM key.
Control PTZ receivers.	Use the appropriate PTZ control keys or joystick (depending on the keyboard used). Extended Coaxitron protocol receivers can be operated without any programming changes. Other receiver control protocols require programming changes.
Call a preset.	Program the preset through the keyboard. <ol style="list-style-type: none">1. Enter the preset number.2. Press the PRESET key or Prst/Lock key (depending on the keyboard used).
System does not function.	Refer to the <i>Troubleshooting</i> section.

OPERATING THE CM6800

The CM6800 can be operated with a KBD100, KBD200, KBD300, KBD960, or KBR960 keyboard. Operation instructions are provided below, but you should become familiar with the detailed instructions provided in the appropriate keyboard manual.

The CM6800 can also be controlled with ASCII commands. Refer to the *ASCII Operating Commands* section.

SWITCH MONITORS



If you select a restricted monitor, the monitor does not switch; the keyboard LED displays the previously selected monitor number.

ALL KEYBOARDS

1. Enter the monitor number.
2. Press the MON key. The keyboard LED displays the selected monitor number.

SELECT CAMERAS

If you select a restricted camera view, the camera view does not appear on that monitor. The previously selected, unrestricted camera view remains on the monitor.

KBD100/200/300 KEYBOARDS	KBD960/KBR960 KEYBOARDS
1. Enter the camera number. 2. Press the CAM key. OR Press the PREV or NEXT key to scroll through the available cameras.	1. Enter the camera number. 2. Press the CAM key. OR Press the BWD or FWD key to scroll through the available cameras. OR From the Camera Menu, select  or  to scroll through the available cameras.

CONTROL RECEIVERS

Select a suitable camera and operate a PTZ function. A keyboard with “view-only” access can view the signal from the specified camera but cannot control the camera.

Extended Coaxitron protocol receivers can be operated without any programming changes. Other receiver control protocols require programming changes. Refer to the *Programming* section.

Receiver control is not available with the KBD100 keyboard.

KBD200 KEYBOARD

Pan/Tilt/Zoom	Lens Control: Focus, Iris
Press and hold the appropriate pan/tilt key until the camera reaches the desired position. To change the speed of movement, press a number (1-9) key first (1=slowest, 9=fastest). Press and hold the appropriate zoom key until the desired effect is seen. To change the speed of zoom, press a number (1-4) key and then press the WIDE key (1=slowest, 4=fastest).	Press and hold the appropriate lens control key until the desired effect is seen. To change the speed of focus, press a number (1-4) key, and then press the FAR key (1=slowest, 4=fastest).

KBD300 KEYBOARD













Pan/Tilt/Zoom	Lens Control: Focus, Iris
Move the joystick until the camera reaches the desired position. To increase the speed of movement, move the joystick farther from center. Twist the joystick clockwise to zoom in, counterclockwise to zoom out. To change the speed of zoom, press a number (1-4) key and then twist the joystick (1=slowest, 4=fastest).	Press and hold the appropriate lens control key until the desired effect is seen. To change the speed of focus, press a number (1-4) key, and then press the FAR key (1=slowest, 4=fastest).

KBD960/KBR960 KEYBOARDS













Pan/Tilt/Zoom	Lens Control: Focus, Iris
<p>Move the joystick until the camera reaches the desired position. To increase the speed of movement, move the joystick farther from center or press the T key to pan at turbo speed.</p> <p>Twist the joystick clockwise to zoom in, counterclockwise to zoom out. Or use the IN/OUT key to zoom in or out.</p>	<p>Use the NEAR/FAR key to focus near or far.</p> <p>Use the OPEN/CLS key to open or close the iris.</p>

OPERATE SEQUENCES

You can run a scratchpad sequence from an individual monitor or a system sequence on any monitor accessible from the keyboard. When running a sequence, any cameras not accessible to the keyboard will be bypassed.





KBD100/200/300 KEYBOARDS	KBD960/KBR960 KEYBOARDS
<p>Run a Sequence</p> <ol style="list-style-type: none"> 1. Enter a sequence number (1-16). Skip this step to run a scratchpad sequence. 2. Press and hold the NEXT or PREV key to move forward or backward through the sequence. <p>To move through the sequence one camera at a time: Press the NEXT key to move forward. Press the PREV key to move backward.</p>	<p>Run a Sequence</p> <ol style="list-style-type: none"> 1. Select . 2. Enter a sequence number (1-16 for a system sequence; 0 for the scratchpad sequence). 3. Select  to start the sequence. <p>OR</p> <ol style="list-style-type: none"> 1. Select . 2. Select  to enter the Sequence Menu. 3. Enter a sequence number (1-16). <p>OR</p> <p>Select  or  to scroll through available sequences.</p> <ol style="list-style-type: none"> 4. Select  or  to start the sequence. <p>NOTE: You can define a function key to run a sequence. Refer to the KBD960 Keyboard Installation/Operation Manual for instructions.</p>
<p>Pause a Sequence</p> <ol style="list-style-type: none"> 1. Press the HOLD key; monitor displays H. 2. Press the HOLD key to resume. 	<p>Pause a Sequence</p> <ol style="list-style-type: none"> 1. Select . 2. Select  or  to resume.
<p>Stop a Sequence</p> <ol style="list-style-type: none"> 1. Enter a camera number. 2. Press the CAM key. 	<p>Stop a Sequence</p> <ol style="list-style-type: none"> 1. Select . <p>OR</p> <ol style="list-style-type: none"> 1. Enter a camera number. 2. Press the CAM key.

RUN A MACRO

KBD100/200/300 KEYBOARDS	KBD960/KBR960 KEYBOARDS
<p>Run a Macro</p>	<p>Run a Macro</p>
<ol style="list-style-type: none"> 1. Enter the macro number. 2. Press the MACRO key. 	<ol style="list-style-type: none"> 1. Select .
<p>Stop a Macro</p>	<ol style="list-style-type: none"> 2. Enter a macro number.
<ol style="list-style-type: none"> 1. Enter the number of the running macro. 2. Press the MACRO key. 	<ol style="list-style-type: none"> 3. Select  to start the macro. <p>OR</p> <ol style="list-style-type: none"> 1. Select .
	<ol style="list-style-type: none"> 2. Select  to enter the Macro Menu.
	<ol style="list-style-type: none"> 3. Enter a macro number.
	<p>OR</p>
	<p>Select  or  to scroll through available macros.</p>
	<ol style="list-style-type: none"> 4. Select  or  to start the macro.
	<p>NOTE: You can define a function key to run a macro. Refer to the KBD960 Keyboard Installation/Operation Manual for instructions.</p>
	<p>Pause a Macro</p>
	<ol style="list-style-type: none"> 1. Select .
	<ol style="list-style-type: none"> 2. Select  or  to resume.
	<p>Stop a Macro</p>
	<ol style="list-style-type: none"> 1. Select .
	<p>OR</p>
	<ol style="list-style-type: none"> 1. Enter a camera number.
	<ol style="list-style-type: none"> 2. Press the CAM key.

ACKNOWLEDGE AN ALARM

When an alarm is triggered, an alarm icon appears on the monitors programmed to show that alarm.

KBD100/200/300 KEYBOARDS	KBD960/KBR960 KEYBOARDS
<ol style="list-style-type: none">1. Enter the monitor number.2. Press the MON key.3. Press the ACK key. The alarm is removed from the selected monitor.4. Repeat for each alarm.	<ol style="list-style-type: none">1. Select .2. Select  to reset the alarm on the individual monitor. <p>OR</p> <p>Select  to reset the alarm on all monitors.</p> <p>You can also select  to mute the alarm.</p> <p>NOTE: You can define a function key to acknowledge an alarm. Refer to the KBD960 Keyboard Installation/ Operation Manual for instructions.</p>







CALL A PRESET

Program the preset through the keyboard. Refer to the appropriate keyboard manual for instructions. Presets are not available with the KBD100 keyboard.

KBD200/300 KEYBOARDS	KBD960/KBR960 KEYBOARDS
<ol style="list-style-type: none">1. Enter the preset number.2. Press the PRESET key.	<ol style="list-style-type: none">1. Enter the preset number.2. Press the Prst/Lock key. <p>OR</p> <p>Select the PRST icon.</p>

CREATE AND RUN A PATTERN

Patterns are not available with the KBD100 keyboard.

KBD200/300 KEYBOARDS	KBD960/KBR960 KEYBOARDS
<p>Create a Long Pattern</p> <ol style="list-style-type: none"> 1. Enter a camera number. 2. Enter 1. 3. Press and hold the PATTERN key for two seconds. 4. The monitor will indicate the programming function is active. Move the camera position as desired for the pattern. 5. Press the ACK key to close the programming function. 	<p>Refer to the KBD960 Keyboard Installation/Operation manual for instructions on creating a pattern.</p> <ol style="list-style-type: none"> 1. Select  to display the Preset Menu. 2. Select  to start a pattern. <p>OR</p> <ol style="list-style-type: none"> 1. Select  to display the Preset Menu. 2. Enter 1. 3. Select  to run the first pattern of previously defined half-patterns. <p>OR</p> <ol style="list-style-type: none"> 1. Select  to display the Preset Menu. 2. Enter 2. 3. Select  to run the second pattern of previously defined half-patterns.
<p>Create a Short Pattern</p> <ol style="list-style-type: none"> 1. Enter a camera number. 2. Enter the short pattern number (2 or 3). 3. Press and hold the PATTERN key for two seconds. 4. The monitor will indicate the programming function is active. Move the camera position as desired for the pattern. 5. Press the ACK key to close the programming function. 	
<p>Run a Long Pattern</p> <ol style="list-style-type: none"> 1. Enter 1. 2. Press the PATTERN key. 3. Move the joystick or call a preset to stop the pattern. 	
<p>Run a Short Pattern</p> <ol style="list-style-type: none"> 1. Enter the short pattern number (2 or 3). 2. Press the PATTERN key. 3. Move the joystick or call a preset to stop the pattern. 	

OPERATE AUXILIARIES/RELAYS





Local auxiliaries are the outputs on the rear panel of the CM6800. External auxiliaries are available by connecting an REL2064 Relay Interface Unit to the CM6800 through COM port 3.

Operate a Local Auxiliary

KBD100/200/300 KEYBOARDS	KBD960/KBR960 KEYBOARDS
<p>Auxiliary 1 relay: Press F1 to activate/deactivate.</p> <p>Auxiliary 2 TTL output: Press F2 to activate/deactivate.</p>	<p>Auxiliary 1 relay: Press F12* to activate/deactivate.</p> <p>Auxiliary 2 TTL output: Press F24* to activate/deactivate.</p> <p>* F12 and F24 are the default auxiliary control function keys; user-selected function keys can be defined through the Key Define Menu. Refer to the KBD960 Keyboard Installation/Operation Manual for instructions.</p> <p>NOTE: If you connect REL2064 Relay Interface Units (up to two) to the CM6800, operation of the two relays on the rear panel of the CM6800-32X6 will also operate the first two relays on the first external unit (unless you number the external relays starting at 64).</p>





Operate an External Auxiliary

The CM6800 can control up to two REL2064 Relay Interface Units connected to the system. Each unit provides 64 relays. Refer to the REL2064 Relay Interface Unit Installation/Operation Manual for detailed information. External relays cannot be operated with the KBD100.

KBD200/300 KEYBOARD	KBD960/KBR960 KEYBOARDS
<p>The KBD200/300 keyboards (firmware version 4.2 and later) can operate external relays.</p> <p>Refer to the KBD200 Keyboard Installation/Operation Manual or the KBD300 Keyboard Installation/Operation Manual for instructions.</p> <p>NOTE: External relays cannot be operated with KBD200/300 keyboard firmware versions prior to 4.2.</p>	<ol style="list-style-type: none"> 1. Enter the GPI number for the appropriate relay output. 2. Press . 3. Press the desired AUX number icon to activate the relay and associated peripheral device. (Press  to access AUX 5-8.) 4. If  is highlighted, the operation is momentary. If  is not highlighted, the operation is latching. Refer to the KBD960 Keyboard Installation/Operation Manual for instructions.





Operate an Auxiliary in a Receiver

Auxiliary control is not available with the KBD100.

KBD200/300 KEYBOARDS	KBD960/KBR960 KEYBOARDS
<p>Press F4 to activate. Press F5 to deactivate.</p> <p>OR</p> <p>To control a momentary function:</p> <ol style="list-style-type: none"> 1. Enter the auxiliary number. 2. Press and hold F4, and then release. 	<p>From the Camera Menu, press ,</p> <p>and then release to control an AUX 1 momentary function on the selected camera.</p> <p>Press  to control an AUX 2 momentary function. Press  to access  through .</p>

CONTROL GENEX MULTIPLEXER AND GENEX MULTIPLEXER DISPLAYS

Multiplexer control is not available with the KBD100.

KBD200/300 KEYBOARDS	KBD960/KBR960 KEYBOARDS
<ol style="list-style-type: none"> 1. Enter the number of the multiplexer input. 2. Press the CAM key. 3. Press the SHIFT key. When the SHIFT LED is lit, the keyboard can be used to operate the following Genex multiplexer function keys: <ul style="list-style-type: none"> F1: Digital zoom F2: PIP display F3: Quad display F4: 9-screen display F5: 16-screen display <p>To select a camera through the multiplexer:</p> <ol style="list-style-type: none"> a. Enter the desired camera number (1-16, based on the camera assignments set through the multiplexer). b. Press the CAM key. 4. Press the SHIFT key to return to normal keyboard operation. <p>When the SHIFT LED is off, you can control the currently selected PTZ camera through the multiplexer.</p> <p>To return to camera selection controlled by the CM6800:</p> <ol style="list-style-type: none"> a. Select the desired camera number. b. Press the CAM key. c. Move the joystick as necessary. 	<ol style="list-style-type: none"> 1. Press  to access the MUX Control Menu. 2. Press  or  to scroll through the available MUX camera numbers. 3. Press  if necessary.  must be highlighted before the system can control Genex Multiplexer functions. 4. Move the joystick or press the appropriate MUX control icons as necessary for multiplexer operation. Refer to the KBD960 Keyboard Installation/Operation Manual for detailed operation instructions.

OPERATE SCANNING FUNCTIONS

Operation of the scanning functions depends on the kind of receiver or pan/tilt mechanism you have. Refer to the appropriate keyboard manual for detailed instructions on operating scanning functions.

DETECT VIDEO LOSS

The CM6800 detects video loss from any system camera. If video is lost from a camera, the CM6800 blue screen appears on any monitor viewing that camera. When video is restored to that camera, the camera view appears on the monitor(s) again. If the system is programmed for a video loss alarm, the alarm icon appears.

DEFINE ZONES

A zone is a user-defined, physical location to which (1) a label is attached and (2) a camera is associated. When the associated camera is panned through or remains within this defined zone the zone label appears on the monitor.

Refer to the appropriate keyboard manual for detailed instructions on defining zones.

APPENDIX

CM6800 DIP SWITCHES

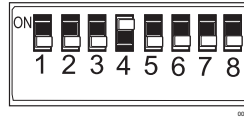

Figure 52. CM6800 DIP Switches – Factory Default Settings

Table G. CM6800 DIP Switch Settings

CM6800 DIP Switch		Factory Default
SW1	OFF (0) = NTSC ON (1) = PAL	CM6800-48X8: OFF CM6800-48X8-X: ON
SW2	RESERVED – must be in the OFF position for proper operation	OFF
SW3	RESERVED – must be in the OFF position for proper operation	OFF
SW4	RESERVED – must be in the ON position for proper operation	ON
SW5	RESERVED – must be in the OFF position for proper operation	OFF
SW6	RESERVED – must be in the OFF position for proper operation	OFF
SW7	SOFTWARE RESET TO FACTORY DEFAULTS CAUTION: Resetting the software restores the system to default settings. All user programming is lost.	OFF
SW8	RESERVED – must be in the OFF position for proper operation	OFF

MACRO COMMANDS

Table H provides a description of each macro command and the additional fields required for each command. Refer to the *Macro* section for instructions on programming macros.

Table H. Macro Commands

Command	Description	Specify	Field(s)
GON	Activate an auxiliary.	Auxiliary (1-128)	Command #
GOFF	Turn off an auxiliary.	Auxiliary (1-128)	Command #
Auxiliary Notes:			
<ul style="list-style-type: none"> • "Global" includes both internal and external auxiliaries. • Auxiliaries on the rear panel of the CM6800-32X6 Matrix Switcher are activated by global auxiliary numbers 1, 2 and 3. 			
CON	Activate a camera auxiliary.	Camera auxiliary (1-8)	Command #
		Camera (1-48)	Camera
		Monitor (1-8)	Monitor
COFF	Turn off a camera auxiliary.	Camera auxiliary (1-8)	Command #
		Camera (1-48)	Camera
		Monitor (1-8)	Monitor
SEQ	Start a sequence.	Sequence (1-16)	Command #
		Monitor (1-8)	Monitor
SWT	Switch a camera to a monitor.	Camera (1-48)	Camera
		Monitor (1-8)	Monitor
COPY	Copy a camera view to a monitor.	Monitor (1-8) to copy from	Command #
		Monitor (1-8) to copy to	Monitor
GO TO	Go to step number specified.	Step (1-72)	Command #
LOOP	Loop a macro.	0 = loop continuously 1-999 = loop the specified number of times	Command #
MACR	Start a specific macro.	Macro (1-32)	Command #
?AUX	Check a local auxiliary; if the auxiliary is active, the next step is executed; if the auxiliary is not active, the next step is skipped.	Local auxiliary (1-3)	Command #
END	Exit the macro; no further steps are executed.	None	None
MSWT	Switch a camera connected through the multiplexer.	Camera to switch (1-16)*	Command #
		Multiplexer input (1-48)	Camera
		Monitor (1-8)	Monitor
PIPB	Display multiplexer picture-in-picture view with the designated camera in the background.	Background camera (1-16)*	Command #
		Multiplexer input (1-48)	Camera
		Monitor (1-8)	Monitor
PIPF	Display multiplexer picture-in-picture view with the designated camera in the foreground.	Foreground camera (1-16)*	Command #
		Multiplexer input (1-48)	Camera
		Monitor (1-8)	Monitor

* For multiplexer functions, the camera number is the number of the video input on the multiplexer. The multiplexer input number is the number of the video input on the rear panel of the CM6800.

(Continued on next page)

Table H. Macro Commands (Continued)

Command	Description	Specify	Field(s)
PIPO	Turn off multiplexer picture-in-picture view.	Multiplexer input (1-48)	Camera
		Monitor (1-8)	Monitor
QUAD	Display multiplexer four-camera mode.	Camera group (1-4)*	Command #
		Multiplexer input (1-48)	Camera
		Monitor (1-8)	Monitor
NANO	Display multiplexer nine-camera mode.	Camera group (1-3)*	Command #
		Multiplexer input (1-48)	Camera
		Monitor (1-8)	Monitor
HEX	Display multiplexer sixteen-camera mode.	Multiplexer input (1-48)	Camera
		Monitor (1-8)	Monitor
ZOOM	Zoom multiplexer camera view.	1 = zoom once 2 = zoom twice	Command #
		Multiplexer input (1-48)	Camera
		Monitor (1-8)	Monitor
AAI	Arm internal alarm.	Internal alarm (1-8)	Command #
DAI	Disarm internal alarm.	Internal alarm (1-8)	Command #
AAE	Arm external alarm.	External alarm (1-128)	Command #
DAE	Disarm external alarm.	External alarm (1-128)	Command #
AAV	Arm video loss detection for a camera.	Physical camera number (1-32) OR Logical camera number	Command # Camera
DAV	Disarm video loss detection for a camera.	Physical camera number (1-32) OR Logical camera number	Command # Camera
PATT	Start a pattern.	Pattern (#)**	Command #
		Camera (1-48)	Camera
		Monitor (1-8)	Monitor
PRES	Start a preset.	Preset (#)**	Command #
		Camera (1-48)	Camera
		Monitor (1-8)	Monitor
RSCN	Start a random scan.	Camera (1-48)	Camera
		Monitor (1-8)	Monitor
FSCN	Start a frame scan.	Camera (1-48)	Camera
		Monitor (1-8)	Monitor
SSCN	Stop a scan.	Camera (1-48)	Camera
		Monitor (1-8)	Monitor

* Refer to the MX4000 Genex Series Simplex and Duplex Multiplexers Installation/Operation Manual for information on multiple camera displays.

** The number of patterns and presets available is determined by the camera positioning system. Refer to the appropriate camera positioning system manual.

ASCII OPERATING COMMANDS

ASCII protocol uses the ASCII character set to transmit and receive commands between a personal computer (PC) and the CM6800. The commands are readable but are not English.

ASCII commands control the pan and tilt mechanisms (fixed and variable speed), camera functions, auxiliary relays, and alarms.

The ASCII protocol communicates in a standard asynchronous, byte-oriented protocol that includes: 1 start bit, 8 data bits, 1 parity bit (odd parity), and 1 stop bit. The default communication rate is 9600 baud.

A lowercase "a" ends each command. The ASCII translator acknowledges accepted commands and rejected commands with the following responses:

AKa command accepted
 NAa command rejected or the ASCII translator does not recognize the command

If the command requires a numeric value, enter the number first.

Table I provides examples of ASCII commands. Table J lists all of the commands.

Table I. Examples of ASCII Commands

Functional Procedure	Commands	Result
Select a pan and tilt device labeled "CAMERA # 16" and switch it to monitor # 3.	3Ma16#a	Switch camera 16 to currently selected monitor 3.
Manipulate the pan and tilt device.	1Ma3#a 5Ma2#a3\va 47Ra33Da sa	Switch camera 3 to monitor 1. Go to camera 2, preset 3, on monitor 5. Pan right at speed 47, tilt down at speed 33. Stop all image motion.
Switch a camera.	1Ma3#a	Switch camera 3 to monitor 1.
Call a preset.	5Ma2#a3\va	Go to camera 2, preset 3, on monitor 5.
Pan and tilt.	47Ra33Da	Pan right at speed 47, tilt down at speed 33.

Table J. ASCII Commands

Number ranges are enclosed in brackets – do not enter the brackets. When you control a fixed speed pan and tilt, omit the speed information.

Desired Action	Command	Result
Select monitor	[1-9999]Ma	Calls a monitor to use for camera operation.
Select camera Next camera Previous camera	[1-9999]#a +a -a	Selects a camera to display on the current operating monitor. The NEXT key (+) and PREV key (-) commands switch to the next numbered camera in the system.
Start a sequence forward	[1-99]qa	Starts the selected sequence going forward (incrementing camera numbers).
Start a sequence backward	[1-99]ba	Starts the selected sequence going backward (decrementing camera numbers).
Hold a sequence	ea	Places the running sequence on hold, freezing the currently selected camera on the monitor. It lets you control the camera or switch. The sequence is still "armed" on the monitor, but inactive.
Hold a macro	[1-32]ea	Places the running macro on hold.
Pan left Pan right Stop pan left Stop pan right	[1-64]La [1-64]Ra ~La ~Ra	Moves the currently selected pan and tilt device left or right at the speed indicated. If you omit the speed, some devices move at their default speed and others move at their slowest possible speed. Speed information has no effect on fixed speed devices.
Tilt up Tilt down Stop tilt up Stop tilt down	[1-63]Ua [1-63]Da ~Ua ~Da	Moves the currently selected pan and tilt device up or down at the speed indicated. If you omit the speed, some devices move at their default speed and others move at their slowest possible speed. Speed information has no effect on fixed speed devices.
Zoom telephoto Zoom wide Stop zoom telephoto Stop zoom wide	Ta Wa ~Ta ~Wa	Makes the currently selected camera zoom in (close up view) or zoom out (wide view).
Focus near Focus far Stop focus near Stop focus far	Na Fa ~Na ~Fa	Changes the good focus range nearer or farther on the currently selected camera.
Iris open Iris close Stop iris open Stop iris close	Oa Ca ~Oa ~Ca	Opens (brighter image) or closes (darker image) the iris on the currently selected camera.
Stop all PTZ motion	sa	Stops all image motion (stops pan, tilt, zoom, focus, and iris). Does not stop a pattern.
Record pattern Execute pattern End pattern	[1-99]/a [1-99]pa [1-99]na	On receivers that do patterns, these commands let you record your motions and operations (for a limited time) and then have the system repeat them.
Go to preset position	[1-99]\a	Recalls a stored preset position.
Set preset with a label	la[string]!a [1-9999]^a	Sets a preset location with an embedded label, where the ASCII string must be UPPERCASE characters . The [string] is an alphanumeric label up to 20 characters long and [1-9999] is the associated preset number. NOTE: All transmitted characters must be ASCII.
Set preset without a label	[1-9999]^a	Sets a preset location without an embedded label.
Begin zone	[1-8](Begins a zone without a label.
Begin zone with a label	la[string]!a[1-8](Begins a zone with an embedded label. The ASCII string must be uppercase characters.
End zone	[1-8)]	Ends the zone program
Begin random scan Begin frame scan Stop scan	1@ 2@ ~@	These commands start and stop scans.

(Continued on next page)

Table J. ASCII Commands (Continued)

Desired Action	Command	Result
Auxiliary on Auxiliary off	[1-128]xa [1-128]~xa	Auxiliaries are relay outputs that can be controlled through the protocol 1-3 operate the AUX 1-2 and F3 auxiliaries on the rear panel of the CM6800 (and the first three auxiliaries on an external REL2064). 4-128 operate the external auxiliaries on up to two REL2064 Relay Interface Units.
Camera auxiliary on Camera auxiliary off	[1-8]Aa [1-8]Ba	Operates auxiliaries at the camera (receiver).
Start macro	[1-32]Sa	Starts the selected macro.
Stop macro	[1-32]Ha	Stops the selected macro.
Acknowledge alarm	[1-9999]!a	Acknowledges an existing alarm.
Arm internal alarm Arm external alarm Arm video loss alarm Disarm internal alarm Disarm external alarm Disarm video loss alarm	[1-8]Ji [1-128]Je [1-48]Jv [1-8]~Ji [1-128]~Je [1-48]~Jv	These commands arm and disarm system alarms.
Send camera title	[1-48]Ya[string]!a	Sends a camera title to the matrix switching system. You can only send one camera title at a time. Valid characters in the string are A-Z, a-z, space, and 0-9 in ASCII representation. Strings are limited to 20 characters.
Version	va	Returns the version number of the device.
Set date and time	ZaMM/DD/YY/HH: MM:Ssa	Sets the date and time. Since the date and time string could be confused with other commands, the command Za comes first. This puts the receiving device into a mode that can accept the specialized string. NOTE: All transmitted characters must be ASCII .

TROUBLESHOOTING

NOTE: *There are no user-serviceable parts inside the CM6800. Only authorized service personnel may open the unit.*

GAINING INITIAL CONTROL

If you are having problems gaining control of your system for the first time:

- Confirm that all system equipment is plugged in and has power.
- Confirm that each keyboard and peripheral device in your system has a unique local address. Refer to the *Switch Settings* section in the appropriate keyboard manual.
- Be sure data cables have not been mixed up.
- Cycle the data cable to the keyboard:
 1. Unplug the data cable from the rear of the keyboard.
 2. Plug the data cable back into the rear of the keyboard.
 3. **WAIT AT LEAST FIVE SECONDS.**
 4. Select a monitor.

If you still cannot gain control of the system:

- Confirm the wiring is correct and the user-supplied cable between wall jacks is appropriate for the application.
- Confirm that when the keyboard data cable is cycled, the keyboard LED flashes momentarily (indicating power).

If you still cannot gain control of the system, call Pelco's 24-hour technical support at 1-800-289-9100 or 1-559-292-1981.

SOFTWARE RESET

Pelco strongly recommends uploading system settings to the CM6800-MGR before the software reset – this will allow you to restore system settings after the software reset.

1. Remove the two screws and the DIP switch cover plate from the rear of the switcher.
2. Move DIP switch 7 to the ON position (to "0").
3. Cycle power.

The switcher will go through a software clear cycle and reset to factory defaults.

4. Move DIP switch 7 to the OFF position.

Failure to move DIP switch 7 to the OFF position could result in loss of system settings during a power outage.

5. Re-initialize keyboards by entering the monitor number and then pressing the MON key.

6. Download your previous system settings (revise settings as necessary) from the CM6800-MGR.



CAUTION:
Resetting the software restores the system to default settings.

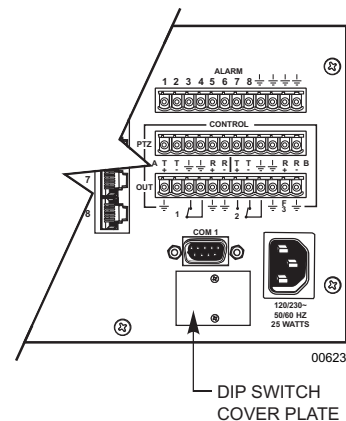

Figure 53. DIP Switch Cover Plate

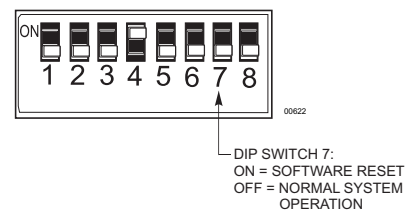

Figure 54. CM6800 DIP Switch 7

SOLUTIONS TO COMMON PROBLEMS

Refer to Table K for a list of common problems and their solutions.

Table K. Solutions To Common Problems

Problem	Remedy
CM6800 does not have power.	Make sure the power cord is plugged in.
You can see some cameras and not others from your location.	Confirm that the camera is properly connected and has power. The keyboard and monitor may have been denied access to the cameras.
The CM6800 does not respond to keyboard commands.	Confirm that the monitor the keyboard is addressing is the same as the monitor in front of you. Access to that monitor may be restricted from that keyboard. Select another monitor.
Pressing the PGM key displays a P on the keyboard LED, but the Password menu does not appear on the monitor. (KBD100/200/300 Keyboards only)	Confirm that the keyboard transformer is plugged in and all electrical connections are in order. Confirm that the monitor the keyboard is addressing is the same as the monitor in front of you.
Keyboards do not function after installation and initial power-up.	Confirm that all wiring is correct and that keyboards have power and are connected. Confirm that each keyboard has been set for a unique address.
Previous system control has been lost.	<p>SOLUTION 1 Initialize the keyboard:</p> <ol style="list-style-type: none"> 1. Enter the monitor number. 2. Press the MON key. <p>SOLUTION 2</p> <ol style="list-style-type: none"> 1. Unplug the data cable from the rear of the keyboard. 2. Plug the data cable back into the rear of the keyboard. 3. Wait five seconds. 4. Re-initialize the keyboard. <p>SOLUTION 3</p> <ol style="list-style-type: none"> 1. Power down the CM6800. 2. Power up the system. 3. Wait five seconds. 4. Re-initialize keyboards. <p>SOLUTION 4 Perform a software reset (refer to <i>Software Reset</i> in this section).</p> <p>CAUTION: <i>Resetting the software restores the system to default settings. All user programming is lost. Uploading system settings to the CM6800-MGR before the software reset allows you to restore system settings after the software reset.</i></p> <p>SOLUTION 5 Call Pelco's 24-hour technical support at 1-800-289-9100 or 1-559-292-1981.</p>
The unit malfunctions and you cannot restore it to satisfactory operation.	Perform a software reset (refer to <i>Software Reset</i> in this section). CAUTION: <i>Resetting the software restores the system to default settings. All user programming is lost. Uploading system settings to the CM6800-MGR before the software reset allows you to restore system settings after the software reset.</i>

KBD960/KBR960 ICON/BUTTON LEGEND

LOG OFF	JOYSTICK ADJUST	AUX 4, RELAY 4	MUX QUAD
LOG OFF YES	ADVANCE MENUS	AUX 5, RELAY 5	MUX NINE
LOG OFF NO	SERIAL PORT TEST	AUX 6, RELAY 6	MUX SIXTEEN
SETUP/DEFINE PIN	KEYBOARD DOWNLOAD	AUX 7, RELAY 7	MUX LIVE
SAVE SELECTION	KEYBOARD UPLOAD	AUX 8, RELAY 8	MUX CAMERA CONTROL
DELETE	TEST GRAPHIC PAGE 0	RESET ALARM	SEQUENCE MENU
MORE MENU	TEST GRAPHIC PAGE 1	RESET ALL ALARMS	CAMERA PRESET
EXIT	TEST GRAPHIC PAGE 2	MUTE	PATTERN
CAMERA SELECTION	TEST TEXT PAGE 0	ALARM	ZONE
MONITOR SELECTION	PARITY	GPI MENU	DEFINE MENU
SCROLL UP SCROLL FIELD UP	DIP SWITCH TEST	RELAY MOMENTARY	PROGRAM MENU
SCROLL DOWN SCROLL FIELD DOWN	DISPLAY BRIGHTNESS	MACRO SELECT	DEFINE NUMBER
PLAY FWD SCROLL RIGHT	COM PORT 1	DEVICES PAUSE	PROGRAMMING MENU
PLAY BWD SCROLL LEFT	COM PORT 2	STOP	
SCROLL OPTION UP	COM PORT 3	MUX MENU	
SCROLL OPTION DOWN	AUX 1, RELAY 1	MUX TAPE	
KEYBOARD SELECT	AUX 2, RELAY 2	MUX ZOOM	
KEYBOARD KEY TEST	AUX 3, RELAY 3	MUX PIC IN PIC	

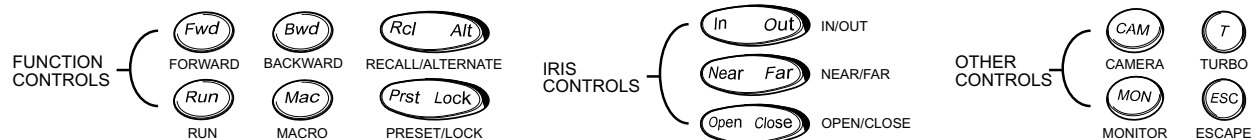

Figure 55. Icon/Button Legend

00665

GLOSSARY

<u>Term</u>	<u>Definition</u>
Access	The CM6800 allows you to restrict system control by (1) limiting the monitors or cameras a keyboard can access, or (2) limiting the cameras that can be viewed on a monitor.
Alarm display format	The CM6800 Matrix Switcher provides four formats for displaying alarmed cameras on system monitors: Block Build, Chronological Pair, Reverse Chronological Pair, and Salvo Group.
Alarm group	To display on a monitor, an alarm must be assigned to one or more alarm groups. The CM6800-48X8 Matrix Switcher provides eight alarm groups (A through H). The CM6800-32X6 Matrix Switcher provides six alarm groups (A through F). Refer to Alarm Groups and Alarm Group Display Options.
Alarm priority	A priority alarm appears on system monitors before a non-priority alarm. Refer to the Priority description under Internal and External Alarms.
ASCII	The binary, 7-bit, 128-character set implemented as the standard in communications.
Auxiliary	Output relays can be used to control external devices based on matrix switcher activities. External devices can include VCRs, alarm devices, and triggers for audio circuits.
Baud rate	In video, the greater the speed, the larger amount of information passed. In digital systems, this capacity is given in bits per second, or baud rates.
Bit	An abbreviation for "binary digit" - the smallest unit of information a computer can use. A bit is either a 1 or a 0 (a high or low voltage state).
Byte	An abbreviation for "binary term" - bytes are strings of bits, operated upon as a unit. A byte is equal to eight bits (256 possibilities) and is large enough to hold one character (like an "A" or the number "1".)
Camera auxiliary	Some cameras contain an auxiliary output relay, which can be used to operate a device connected to the relay.
Coaxitron	This is Pelco's "up the coax" control technology. Control signals are sent back up the coaxial cable that the video signal travels down on.
COM port	This is a communication port input on the rear panel of the matrix switcher.
Daisy-chain	This is a way of providing multiple connections in a series, from one source. A daisy-chain configuration connects multiple, linked devices from one output. When connecting PTZ cameras to a matrix switcher, for example, one set of cables connects the matrix switcher to each receiver, and then each receiver is connected to the next receiver.
Dwell	This is the amount of time something happens in the system, such as the amount of time a camera view displays on a monitor, or an auxiliary is on.

Event timer	The matrix switcher can automatically initiate macros or sequences based on time and date.
Extended Coaxitron	This is Pelco's Coaxitron control technology that uses 32 bits to send a command.
Frame scan	A three-second camera scan followed by a three-second pause.
Latching operation	The auxiliary device remains on until a command is given (by a system operator or system automation) to turn it off.
Logical camera number	A user-selectable, variable number, which is associated with an actual physical camera input on the rear panel of the matrix switcher.
Macro	A sequence of commands or steps. Macros can be operated automatically or manually. Automatic operation can be based on specific times or dates (set through the Event Timer).
Matrix switcher	This is also known as a cross-point switcher. The cross-points are actually electronic switches that select any video input onto any video output at any one time, preserving the video impedance matching. One video signal can simultaneously be selected on more than one output. More than one video input can be selected on one output, in a sequential switching between inputs (unless the input is routed through a multiplexer, which allows more than one input to be viewed on the output monitor at any one time).
Momentary operation	The auxiliary output operation is activated briefly and then turns off.
Multiplexer (MUX)	A multiplexer allows an operator to view more than one video signal (usually either four, nine or sixteen signals) at one time on a single monitor. A multiplexer can also send these multiple images to the video recorder, switching rapidly between image from each camera.
NTSC	The American color TV standard, used in North America, Japan, and a few other countries. It specifies 525 lines/screen, and 29-30 frames/sec.
Null modem cable	A null modem cable allows you to connect your PC to another nearby PC or serial device by "crossing over" (reversing) their respective pin contacts. (A null modem cable is limited to 30 feet in length.)
PAL	The color TV standard (50Hz) used by European, Asian, and some Latin American countries. It specifies 768 pixels/line, 576 lines/screen and 25 frames/sec.
Parity type	The parity bit is used to identify whether the bits being moved arrived successfully. Parity bit checking can be based on odd or even bits. No parity means that a parity bit is not transmitted or checked.
Partitioning (access)	The CM6800 allows you to restrict system control by (1) limiting the monitors or cameras a keyboard can access, or (2) limiting the cameras that can be viewed on a monitor.

Pattern	A pattern is a user-defined, viewable camera path with a definite beginning and end. The pattern can consist of any standard pan and tilt or lens command. Once defined, the pattern is easily activated by a system operator or through an automated event. The pattern will run continuously until it is deactivated. The number and time length of patterns varies with different positioning systems.
Physical input	A number representing an actual BNC camera input on the rear panel of the matrix switcher. This number cannot be changed.
Preset	A preset allows operators to direct a PTZ (camera positioning system) to move to a predetermined scene on keyboard command or as a result of an alarm. In addition to moving the camera, a descriptive title can appear on the screen. The type of camera positioning system determines the number of presets available.
Priority control	This is the level of priority a system keyboard has to control a PTZ camera positioning system and to access CM6800 Matrix Switcher on-screen programming menus.
PTZ	This is a camera positioning system with pan, tilt, and zoom capabilities.
Random scan	This is a camera scan moving in a random pattern.
RJ-45 wall block	This is a wall block with eight terminals for connecting RS-232, RS-422, and RS-485 communication lines. (This is Pelco part number CON12J00820360Z.)
RS-232	This is an Electronics Industry Association (EIA) interface standard used for data communication; the normal connection distance is 50 feet (15 m). Pelco uses this standard for communication from a controller to a PC or RS-232 network. The Pelco three-wire connection provides one wire for transmit, one wire for receive, and one wire for common.
RS-422	<p>This is an Electronics Industry Association (EIA) interface standard. Pelco uses this standard for communication from a controller to one or more camera receivers (on the same line); the maximum recommended distance is 4,000 feet (1,219 m).</p> <p>The four-wire connection provides two wires for transmit and two wires for receive. Pelco receiver/driver communication uses only the two transmit wires (commands are sent from the controller to the receiver only; the receiver does not "talk" back to the controller). Pelco keyboard communication uses all four wires.</p> <p>NOTE: <i>The electrical communication scheme used by Pelco is a direct-coupled method, not an AC-coupled method. Therefore, if the ground potential of the wire at its two end points is different (other than zero volts), an additional wire is required as a ground.</i></p>

RS-485	<p>This is an Electronics Industry Association (EIA) interface standard used for communication between multiple transmitters and receivers; the maximum recommended distance is 4,000 feet (1,219 m). The four-wire connection provides two wires for transmit and two wires for receive.</p> <p>NOTE: <i>The electrical communication scheme used by Pelco is a direct-coupled method, not an AC-coupled method. Therefore, if the ground potential of the wire at its two end points is different (other than zero volts), an additional wire is required as a ground.</i></p>
Scratchpad sequence	<p>A scratchpad sequence can be run on an individual system monitor, without entering the password-protected CM6800 Matrix Switcher on-screen programming menus. You can program scratchpad sequences from the CM6800 Matrix Switcher on-screen programming menus only, not from the CM6800-MGR software.</p>
Sequence	<p>Allows an operator to see a routine of 72 camera views on any system monitor, over and over again. The sequence can be operated automatically or manually. The order in which the camera views appear and the time each view remains can be programmed.</p>
Standard Coaxitron	<p>This is Pelco's Coaxitron control technology that uses 15 bits to send a command.</p>
Star configuration	<p>This is a way of providing multiple direct connections from one source. A star configuration uses a separate cable for each direct connection, with all of the cables connected to a central device. When connecting PTZ cameras to a matrix switcher, for example, the central device can be a code distribution unit, such as the CM9760-CDU-T. Each camera has a direct connection to the CM9760-CDU-T, which is the central device.</p>
Synchronize	<p>Since the CM6800 Matrix Switcher can be programmed from either the CM6800-MGR software or the CM6800 Matrix Switcher on-screen programming menus, you could potentially have different settings in the two programming sources. Pelco recommends transmitting any programming changes from the updated programming source so that the next time you make changes from either programming source, you will be modifying the current system settings. Refer to Transmitting Programming Settings.</p>
System keyboard	<p>This is a keyboard compatible with and connected to the matrix switcher, allowing a system operator manual control over the system.</p>
System reset	<p>This restores the system to the default settings, as shipped from the factory.</p>
Vertical drive/synchronization	<p>This option sends a timing pulse from the matrix switcher to a compatible camera. The camera aligns the vertical synchronization with the timing pulse.</p>
Zone	<p>A zone is a user-defined, physical location to which (1) a label is attached and (2) a camera is associated. When the associated camera is panned through or remains within this defined zone, the zone label appears on the monitor. With some camera systems, a zone can be blanked to prevent viewing while the camera is positioned in the zone.</p>

SPECIFICATIONS

GENERAL

Memory Protection:	Lithium battery, two weeks of data protection
Keyboards:	Eighteen: Sixteen KBD100/200/300 Series keyboards and two KBD960/KBR960 Series keyboards. (Switcher can provide power for two KBD100/200/300 Series keyboards. Additional keyboards will require a remote power supply.)
Receiver/Dome Control:	Coaxitron and RS-422
Alarm Inputs:	Eight individually programmable for N.O. or N.C. on rear panel (plus an additional 128, via ALM2064, Alarm Interface Units, providing a total of 136 possible)
Control Outputs on Rear Panel	
AUX 1, 2:	Two relays (SPDT), rated at 0.5 amp @ 125V, 1 amp @ 30 VDC, 60 milliohms contact resistance
F3:	One open collector (TTL); 15 VDC maximum, 25 mA maximum
Additional Outputs:	Two REL2064, Relay Interface Units, may be connected to expand relay outputs to a maximum of 128
Communication Ports:	Eight data ports, two PTZ control ports, all programmable by the user; two ports provide power for keyboards

ELECTRICAL

Input Power:	120V or 230V, 50/60Hz
Power Consumption:	25W

SWITCHER CHARACTERISTICS

Video Inputs, Looping:	40 BNC, terminating or looping (individually selectable per camera), .5 to 2.0 Vp-p composite video, video loss detection
Video Inputs, Terminating:	Eight, BNC, terminating, .5 to 2.0 Vp-p composite video, video loss detection
Video Outputs:	Six or eight outputs, BNC
Switching Type:	Cross-point video matrix, NTSC and PAL compatible
Switching Method:	Vertical interval switching
Switching Time:	Less than 16 milliseconds (typical)

VIDEO

Bandwidth:	15 MHz
Frequency Response:	Flat to 8 MHz, ± 1 dB to 13 MHz
Signal-to-Noise Ratio:	-50 dB (peak-to-peak vs. RMS noise)
Adjacent Channel Crosstalk:	-55 dB typical at 3.58 MHz
Differential Gain:	0.03% typical
Differential Phase:	0.24° typical
Gain:	Unity (± 1 dB)
DC Output:	Zero volts

CHARACTER GENERATION

Character Type:	White with black outline; adjustable brightness
Camera Identification:	Two lines, twenty-character title, plus camera number, monitor number, date (four formats) and time (24-hour or AM/PM formats)
Programmable:	On-screen, menu-driven
Character Set:	128 ASCII characters

ENVIRONMENTAL

Ambient Operating Temperature:	20° to 120°F (-7° to 49°C)
Humidity:	10-90% non-condensing

MECHANICAL

Dimensions:	17.40 (W) x 5.25 (H) x 12.25 (D) inches (without rack ears) (44.20 x 13.34 x 31.12 cm)
Mounting:	Factory-configured for EIA rack mount (3 RU); rack ears can be removed for versatile wall mount or freestanding applications
Unit Weight:	12.7 lb (5.76 kg)

(Design and product specifications subject to change without notice.)

REGULATORY NOTICES

This equipment has been tested and found to comply with the limits of a Class B digital device, pursuant to part 15 of the FCC rules. These limits are designed to provide reasonable protection against harmful interference in a residential installation. This equipment generates, uses, and can radiate radio frequency energy and, if not installed and used in accordance with the instructions, may cause harmful interference to radio communications. However there is no guarantee that the interference will not occur in a particular installation. If this equipment does cause harmful interference to radio or television reception, which can be determined by turning the equipment off and on, the user is encouraged to try and correct the interference by one or more of the following measures:

- Reorient or relocate the receiving antenna.
- Increase the separation between the equipment and the receiver.
- Connect the equipment into an outlet on a circuit different from that to which the receiver is connected.
- Consult the dealer or an experienced radio/TV technician for help.

PRODUCT WARRANTY AND RETURN INFORMATION

WARRANTY

Pelco will repair or replace, without charge, any merchandise proved defective in material or workmanship **for a period of one year** after the date of shipment.

Exceptions to this warranty are as noted below:

- Five years on FT/FR8000 Series fiber optic products.
- Three years on Genex® Series products (multiplexers, server, and keyboard).
- Three years on Camclosure® and fixed camera models, except the CC3701H-2, CC3701H-2X, CC3751H-2, CC3651H-2X, MC3651H-2, and MC3651H-2X camera models, which have a five-year warranty.
- Two years on standard motorized or fixed focal length lenses.
- Two years on Legacy®, CM6700/CM6800/CM9700 Series matrix, and DF5/DF8 Series fixed dome products.
- Two years on Spectra®, Esprit®, ExSite™, and PS20 scanners, including when used in continuous motion applications.
- Two years on Esprit® and WW5700 Series window wiper (excluding wiper blades).
- Eighteen months on DX Series digital video recorders, NVR300 Series network video recorders, and Endura™ Series distributed network-based video products.
- One year (except video heads) on video cassette recorders (VCRs). Video heads will be covered for a period of six months.
- Six months on all pan and tilts, scanners or preset lenses used in continuous motion applications (that is, preset scan, tour and auto scan modes).

Pelco will warrant all replacement parts and repairs for 90 days from the date of Pelco shipment. All goods requiring warranty repair shall be sent freight prepaid to Pelco, Clovis, California. Repairs made necessary by reason of misuse, alteration, normal wear, or accident are not covered under this warranty.

Pelco assumes no risk and shall be subject to no liability for damages or loss resulting from the specific use or application made of the Products. Pelco's liability for any claim, whether based on breach of contract, negligence, infringement of any rights of any party or product liability, relating to the Products shall not exceed the price paid by the Dealer to Pelco for such Products. In no event will Pelco be liable for any special, incidental or consequential damages (including loss of use, loss of profit and claims of third parties) however caused, whether by the negligence of Pelco or otherwise.

The above warranty provides the Dealer with specific legal rights. The Dealer may also have additional rights, which are subject to variation from state to state.

If a warranty repair is required, the Dealer must contact Pelco at (800) 289-9100 or (559) 292-1981 to obtain a Repair Authorization number (RA), and provide the following information:

1. Model and serial number
2. Date of shipment, P.O. number, Sales Order number, or Pelco invoice number
3. Details of the defect or problem

If there is a dispute regarding the warranty of a product which does not fall under the warranty conditions stated above, please include a written explanation with the product when returned.

Method of return shipment shall be the same or equal to the method by which the item was received by Pelco.

RETURNS

In order to expedite parts returned to the factory for repair or credit, please call the factory at (800) 289-9100 or (559) 292-1981 to obtain an authorization number (CA number if returned for credit, and RA number if returned for repair).

All merchandise returned for credit may be subject to a 20% restocking and refurbishing charge.

Goods returned for repair or credit should be clearly identified with the assigned CA or RA number and freight should be prepaid. Ship to the appropriate address below.

If you are located within the continental U.S., Alaska, Hawaii or Puerto Rico, send goods to:

Service Department
Pelco
3500 Pelco Way
Clovis, CA 93612-5699

If you are located outside the continental U.S., Alaska, Hawaii or Puerto Rico and are instructed to return goods to the USA, you may do one of the following:

If the goods are to be sent by a COURIER SERVICE, send the goods to:

Pelco
3500 Pelco Way
Clovis, CA 93612-5699 USA

If the goods are to be sent by a FREIGHT FORWARDER, send the goods to:

Pelco c/o Expeditors
473 Eccles Avenue
South San Francisco, CA 94080 USA
Phone: 650-737-1700
Fax: 650-737-0933

REVISION HISTORY

Manual #	Date	Comments
C1515M	5/01	Original version.
	8/01	Updated certifications.
C1515M-A	11/01	Revised manual to describe updated functionality in the software.

Pelco, the Pelco logo, Camclosure, Esprit, Genex, Legacy, and Spectra are registered trademarks of Pelco. Windows is a registered trademark of Microsoft Corporation. Endura and ExSite are trademarks of Pelco.

© Copyright 2001, Pelco.
All rights reserved.

Free Manuals Download Website

<http://myh66.com>

<http://usermanuals.us>

<http://www.somanuals.com>

<http://www.4manuals.cc>

<http://www.manual-lib.com>

<http://www.404manual.com>

<http://www.luxmanual.com>

<http://aubethermostatmanual.com>

Golf course search by state

<http://golfingnear.com>

Email search by domain

<http://emailbydomain.com>

Auto manuals search

<http://auto.somanuals.com>

TV manuals search

<http://tv.somanuals.com>