

OWNER'S MANUAL

PYLE[®] PLCD27

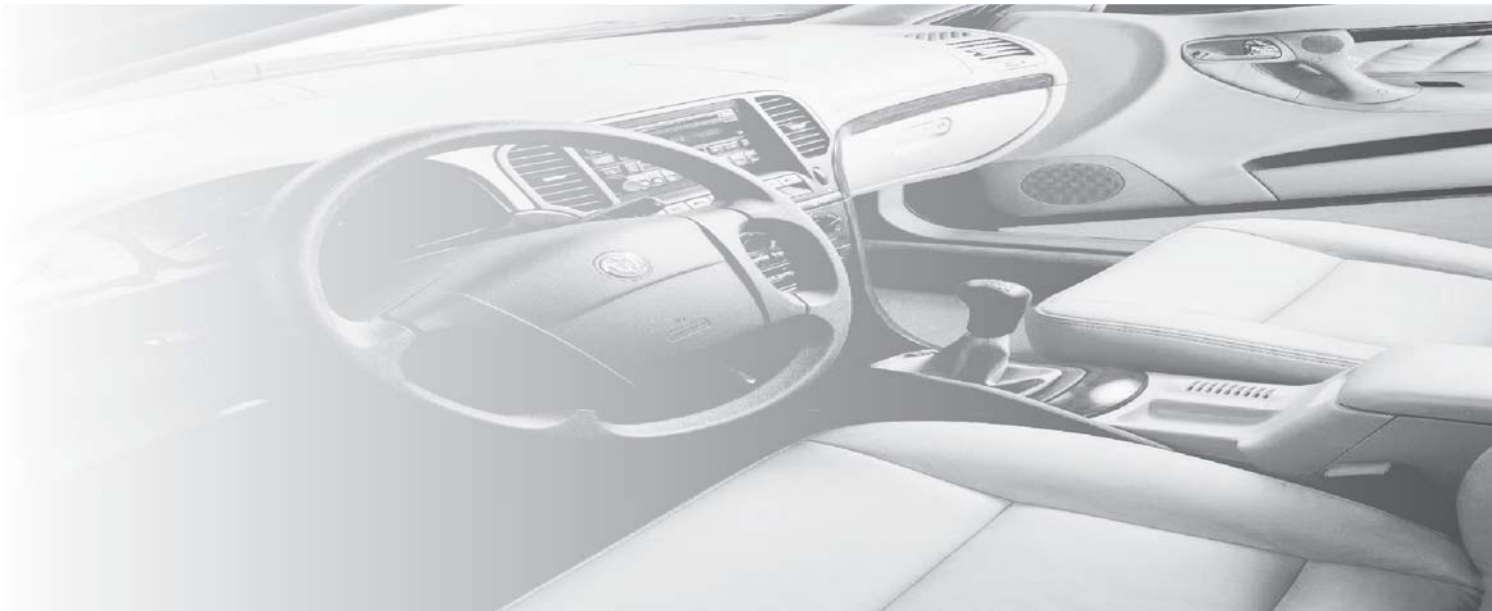

CD PLAYER

■ C a r A u d i o H i f i S y s t e m

Contents

Safety precautions.....2

General features.....3

- Power
- Volume
- play/pause
- eject
- clock
- loud
- release

General features.....5

- Volume setting
- bass setting
- treble setting
- balance setting
- fader setting

Play operation.....6

- Top
- scan
- repeat
- random
- stop

Radio operation.....7

- Band
- Band tuner
- Direct access tuning

Remote control.....8

Accessories9

Wiring diagram10

- Radio wiring
- Speaker wiring

Installation11

- Install the unit
- Removing the unit

Specifications12

Trouble shooting13

Safety precautions

▲ WARNING

To prevent injury of fire, take the following precautions:

- Insert the unit until it is firmly locked to the main unit, otherwise it may fall out of place when jolted
- When extending the ignition, memory back up or ground cable, use diameter of 0.75mm(AWG18) or more automotive grade cable to avoid wire deterioration or damage to the wire coating.
- To prevent short circuit, never put or leave any metallic object into the unit.
- If you smell or see smoke, turn off the power immediately and consult your dealer.
- Be careful not to drop or shock the unit strongly, it may break or crack because it contains glass parts.

▲ CAUTION

To prevent damage to the machine, take the following precautions:

- Be sure the unit is connected to a 12V DC power with a Negative Ground
- The unit is only designed for use with 4 speakers. Do not combine output for use with 2 speakers. Do not ground negative speaker leads to the chassis ground
- Do not open the top cover and do not install the unit in place where it is exposed to direct sunlight (including the faceplate), in order to avoid high heat or humidity, water splash over it or dust.
- Do not touch the terminals of the units.
- If you have difficulty in installing this unit in your vehicle. Please contact your dealer.
- If the unit seems not work properly press the reset button to reset the memory of the unit.

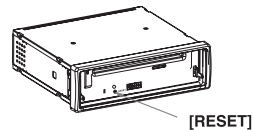

Attaching panel

Attach the front panel by fixing the left side of it into this unit as 1 showing. Then push the right side of panel towards into connecting plug as 2 showing.

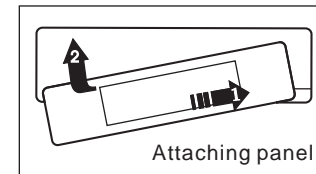

Power/volume/play/pause

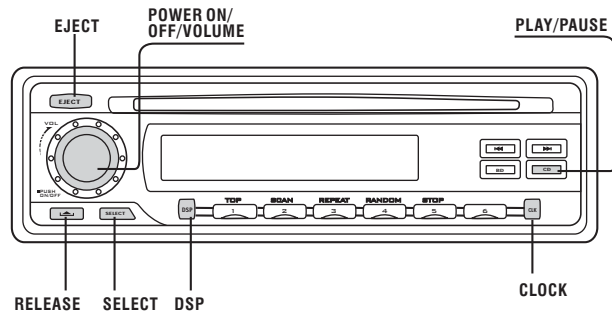

Power

Turning ON the power

Press the [PWR]button.

Press to turn on the unit power, Press the button to turn off the unit.

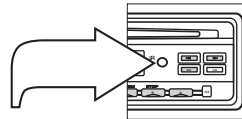

Volume

Increasing volume

Rotate the [VOL+]button

Decreasing

Rotate the [VOL-]button

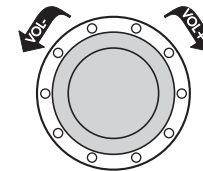

Play/pause

Play

Press the [CD]button

Pause

Press again the [CD]button

If a disc has already been loaded, CDIN would be shown on the display, press this button to start play disc even though the unit is in Radio mode. When disc is playing, press this button to pause the disc, press again to resume the normal play.

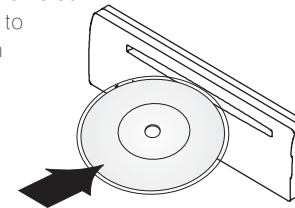

Eject/clock/loud/DSP/Release

Eject

Out

Press the [**▲**] button, if having a disc in the unit. The disc will be ejected out.

In

Press the [**▲**] button again, the disc will be load in.

 In beam mode, press the “BD” button can enter radio mode. If the disc in the slot, press the “EJECT” button to eject the disc form the slot and automatically be switched to the radio mode.
In radio mode, if push a disc into slot, the disc will automatic insert and begins to play. If the disc in the slot, press “PLAY/PAUSE” button to play the disc again.

Clock

Press CLK can display time. Time will display even power off.
Long Press CLK for 3 second will into clock set mode.

Hour

Press [**▶▶**] button to adjust the hour.

Minute

Press [**◀◀**] button to adjust the minute.

Quit clock set mode

If there no operation in 5 second, it will quit clock set mode.

LOUD/DSP

LOUD

Long press the “DSP” button to emphasize the bass output, press it again to resume the normal listening.

DSP

Short press this button to “DSP” :
Press “DSP” button once, “ROCK” will bicker on display.
Press “DSP” button twice, “POP” will bicker on display.
Press “DSP” button third, “CLASS” will bicker on display.

Release

 press the "**⏏**" button to release faceplate.

Speaker setting

Speaker mode

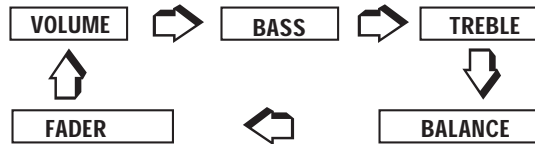

▲ NOTE

In press mode, VOL is sel function

● Volume set mode

Press “SEL” button once, display shows “VOL”, then rotate the volume “+” button to adjust volume level up. Rotate the volume “-” button to adjust volume level down.

VOL 10

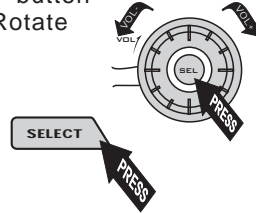

● Bass set mode

Press “SEL” button twice, display shows “BAS”, then rotate the volume “+” button to adjust bass level up. Rotate the volume “-” button to adjust bass level down.

BAS -6

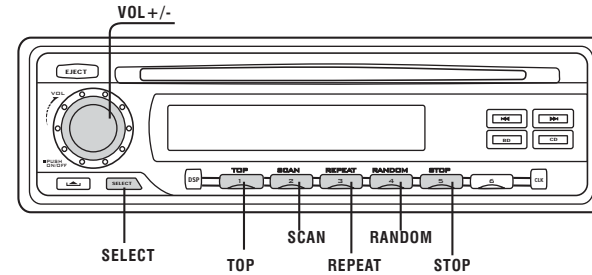

● Treble set mode

Press “SEL” button third, display shows “TRE”, then rotate the volume “+” button to adjust treble level up. Rotate the volume “-” button to adjust treble level down.

TRE 5

● Balance set mode

Press “SEL” button fourth, display shows “BAL”, then rotate the volume “+” button to adjust left speaks level. Rotate the volume “-” button to adjust right speaks level.

BAL 4

● Fader set mode

Press “SEL” button fifth, display shows “FAD”, then rotate the volume “+” button to adjust front speaks level. Rotate the volume “-” button to adjust back speaks level.

FAD -3

Play control

Top

Press [TOP]button

-  Select the first track directly
In CD mode,press this button, the first track will play.

Repeat

Press [RPT]button

-  Press the button once to repeat the same track continuously,
Press the button twice to repeat the disc continuously,
“RPT” will appear on the LCD display.

Random

Press [RDM]button

-  Press this button to play all the track in random order. “RDM”
will appear on the display. Press it again to stop random playing.
This button is invalid if the unit is in “PBC On” mode.

Scan

Press [SCN]button

-  Press this button once for TRACK INTRODUCTION, the first
ten seconds of each track on the disc will play. To confirm
the track number. Press it again while playing on the desired
track. “SCAN” will appear on the display. Press it again to
stop it.

Stop

Press [STOP]button

-  Press this button once to stop play music .

Radio operation

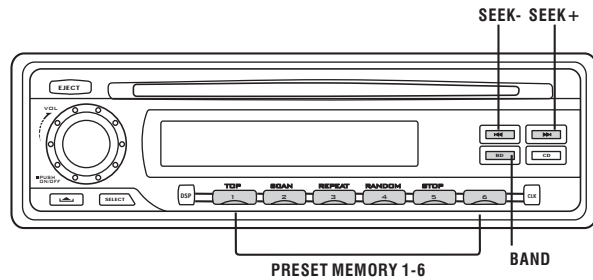

Tune

In radio mode:
manual tuning:

- short press ►► button it can select higher frequency station.
- Short press ◄◄ can select lower frequency station.

Auto loading tuning:

- the long press ►► button it can automatically select higher frequency station. And the long press ◄◄ it can automatically select lower frequency station.

Band

Selecting band

- Press BAND button to select among three FM or two AM bands. (FM1-FM2-FM3-AM1-AM2)

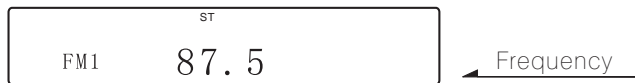

Remote control

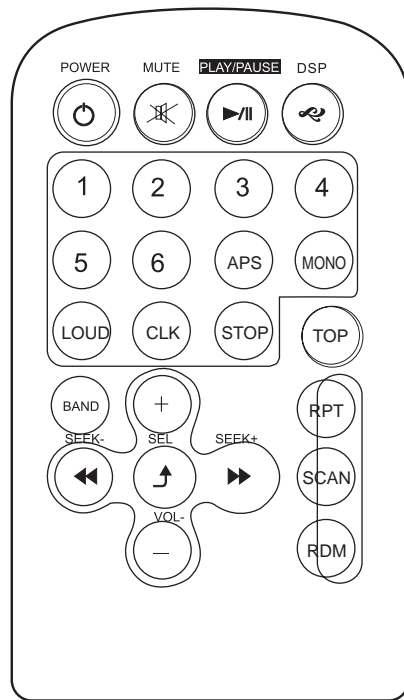

Loading and replacing the battery

Use one lithium battery (CR2025) insert the batteries with the + and - poles aligned properly. Following the illustration inside the case.

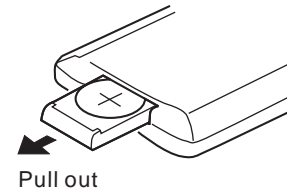

WARNING

Store unused batteries out of the reach of children. Contact a doctor immediately if the battery is accidentally swallowed.

Do not set the remote on hot places such as above the dashboard.

Basic operation

Turning ON the power

Press the [POWER] button.

Press to turn on the unit power, Press the button to turn off the unit.

Basic operations of remote

Volume

Increasing volume
Press the [+]loud VOL

Increasing volume
Press the [-]low VOL

Play/pause

Play
Press the [▶] button

Pause
Press the [⏸] button again

Radio control

Page(7)





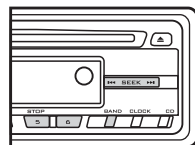
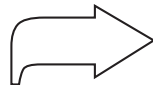



CAUTION

Remote operation the same of mainframe.



Window of Remote

Accessories

External view		External view	
..... Number of items	 Number of items	
①		⑤	
②		⑥	
③		⑦	
④		⑧	
1	1
1	1
1	1
2	1



The use of any accessories except of those provided might result in damage to the unit .make sure only to use the accessories shipped with the unit ,as shown above.

Wiring diagram

Follow this easy wiring diagram in order to enable you to install the new or existing RADIO and SPEAKER wiring system.

Be sure the unit is connected to a 12 volts battery with negative ground. Good ground connections eliminate most electrical noise problem and require tight with the metal vehicle chassis. remove plastic, paint or dust for good electrical contact.

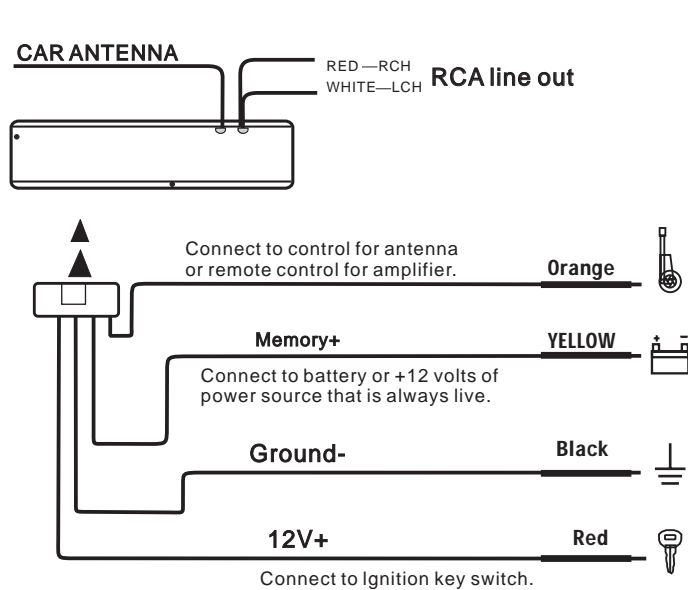

SPEAKER WIRING

The unit is only designed for the use with 4 speakers system, it can only be connected with speakers rated in the load impedance range from 4 to 8 ohms. Load impedance less than 4 ohms could damage the unit.

Never combine (BRIDGE) the outputs for use with 2 speakers, and Never ground any Negative speaker to the chassis ground.

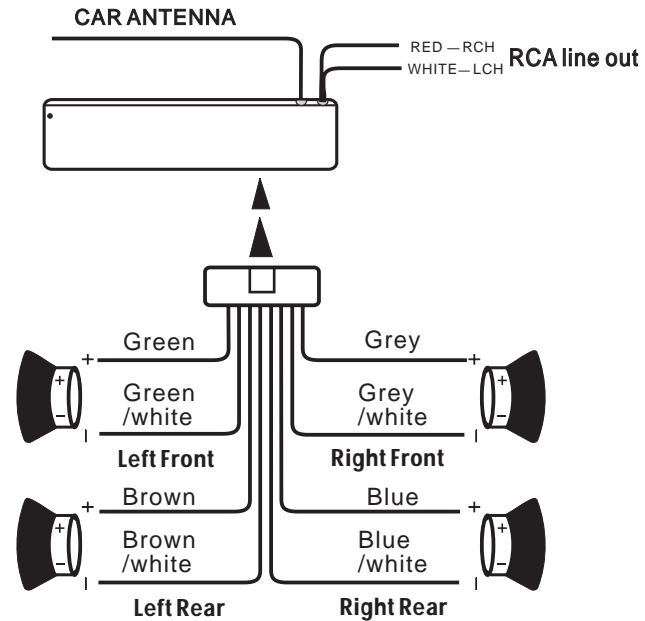

Installation

Before installing the receiver permanently, fit it in the approximate place in your car. Connect the equipment according to the speakers and electrical connections. When your system is operated properly, (preferably with the car engine running), follow the instructions for permanent installation of your system.

INSTALL THE UNIT

- 1) Install half sleeve, can be with or without adapter. It will fit better with adapter.
- 2) Bend over some tabs where possible to secure the half sleeve inside of dash.
- 3) Support strap to be strutted under dash, secure this strip to avoid skipping of disc.

REMOVING THE UNIT

- 1) Insert removal wrench into the small gap on the right side of the unit and pull the unit slightly out on the same side, then release the wrench. Repeat the same action for the left side. By now, you can remove the unit and unplug the wires connector.

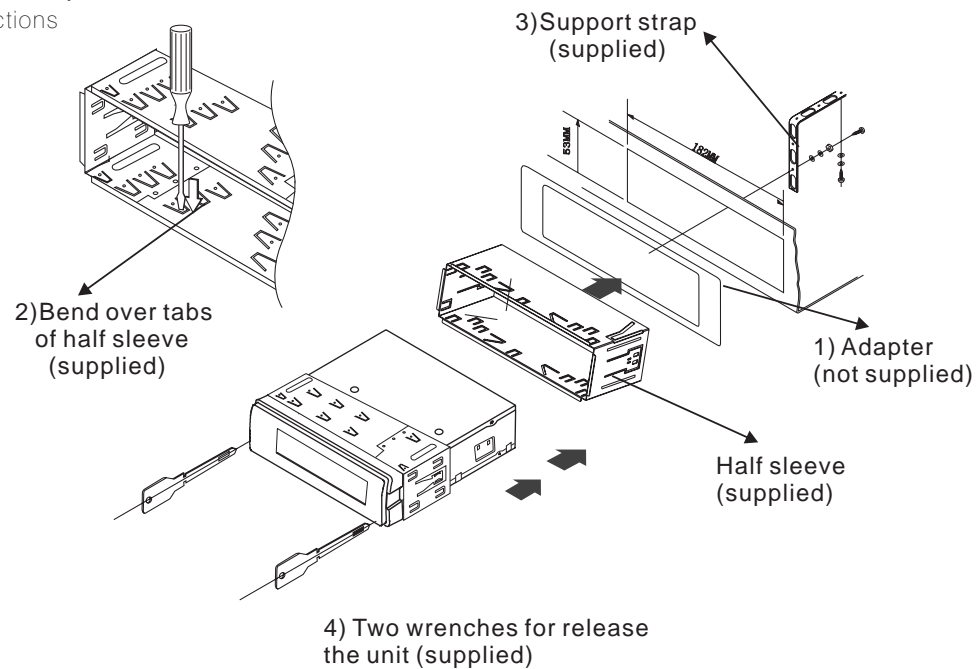

Specifications

Specifications subject to change without notice.

CD PLAYER

Signal/Noise ratio.....70dB
Frequency response.....20Hz-20KHz(+3dB)
Channel separation.....> 45dB
Dual D/A converter.....16Bit

FM Tuner

Tuning range.....USA:87.5-108MHz
(100KHz step)
EUROPE:87.5-108.0MHz
(50KHz step)
FM usable sensitivity(S/N=30dB).....< 12dB
Stereo separation.....> 45dB

AM Tuner

Tuning range.....USA:520-1720KHz
(10KHz step)
EUROPE:522-1620KHz
(9KHz step)
AM sensitivity.....28dB

GENERAL

Operating power.....12 Volts DC,negative
ground
%10THD output wiring.....Designed for using four
speakers only front and rear
channels cannot be combined
in use with 2speakers.
Load impedance.....compatible 4 to 8 ohm
speakers
Fuses.....1 amp and 10 amp
Dimensions.....178mm(L)x50mm(W)
x150mm(H)
Weight.....2.5Kgs

Troubleshooting guide

What might seem to be a malfunction in your unit may just be the result of slight misoperation or miswiring. Before calling service, first check the following table for possible problems.

?The power does not turn ON.

- ✓ The fuse has blown.

 Install half sleeve, can be with or

?NO Sound.

- ✓ The cable connect incorrectness.

 Exactitude connect of the cable.

?Noise on Radiopoor recepiton

- ✓ Antenna and Antenna Cable.

 Check antenna and antenna cable, the antenna base must be grounded and connected with good condition, repace antenna or antenna cable if needed.

?Noise on both Radio and CD

- ✓ Poor ground,dirty or corroded at the car Battery posts

 Check the black wire for proper grounding clean and tighten ground connection.

?No/Poor sound on one or more speakers

- ✓ Speakers or speaker wiring or volume, Balance and Fader setting

 Check the speaker wiring and test the speakers all in good condition check the setting of volume, Balance and Fader controls.

?CD sound skips

- ✓ Installation the unit angle is greater than 45° ,or mounting is not fixed and the back strap is not secure.

 Adjust the unit with mounting angle less than 45° and make sure the unit is mounted securely and tighten with the back strap(supplied)

?Unit completely inoperative, no Light and Sound

- ✓ Incorrect wire connection, Power RED/YELLOW or Ground wire or Blown fuse

 Check the Red wire to + 12 Volts with key Ignition witch, yellow wire to + 12 Volts battery and black wire to ground. Check Fuse with red/yellow wire, or check the fuse block on your car.

CD PLAYER

C a r A u d i o H i f i S y s t e m

Free Manuals Download Website

<http://myh66.com>

<http://usermanuals.us>

<http://www.somanuals.com>

<http://www.4manuals.cc>

<http://www.manual-lib.com>

<http://www.404manual.com>

<http://www.luxmanual.com>

<http://aubethermostatmanual.com>

Golf course search by state

<http://golfingnear.com>

Email search by domain

<http://emailbydomain.com>

Auto manuals search

<http://auto.somanuals.com>

TV manuals search

<http://tv.somanuals.com>