

# PYLE®

## PLCD55

# INSTRUCTION MANUAL

---

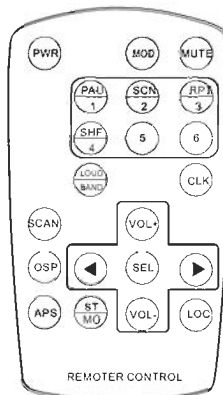
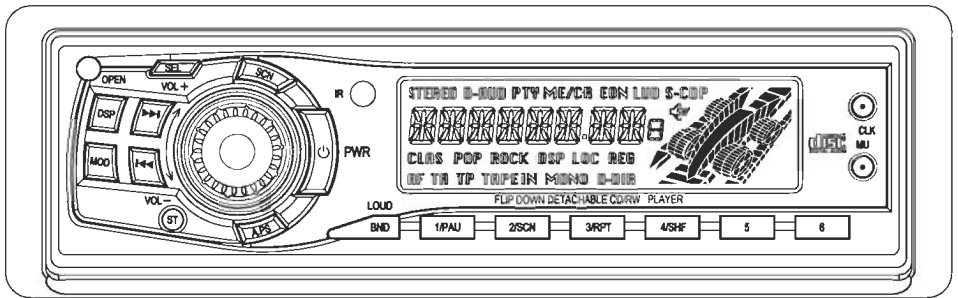

ANTI-THEFT FLIP DOWN DETACHABLE PANEL  
AUTO-LOADING CD COMPACT DISC PALYER  
AM/FM DIGITAL PLL TUNING RADIO  
WITH INFRARED REMOTE CONTROLLER

# BASIC OPERATION

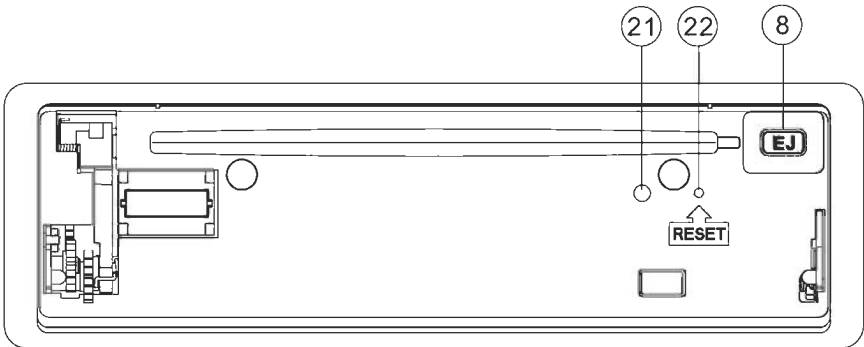
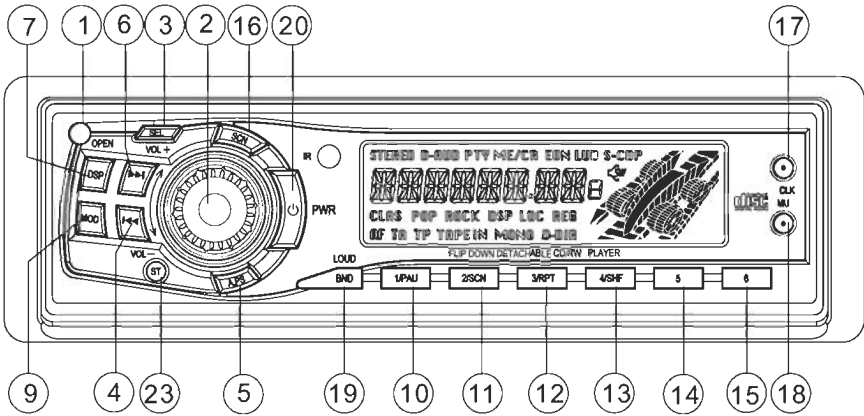

CDC CONNECTOR  
OR AUX CABLE

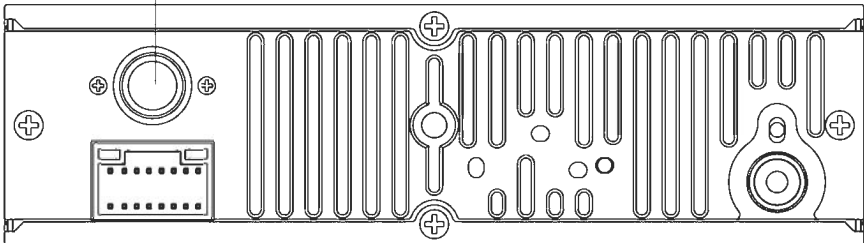

# BASIC OPERATION

## 1. OPEN BUTTON

Press it to flip down the front panel then you can insert the CD disc into the CD compartment or press EJ button to eject the disc.

## 2-3.SEL( AUDIO MODE SELECT)/ VOL+/- KNOB

Press SEL button to change the mode in the sequence of:



- A.The volume level can be adjusted at any time by rotating the audio level + or - knob as select mode has been initially defaulted at volume mode.
- B.The volume level is also obtained by stepping through the SEL button until the function VOL is displayed and then rotate vol+ or - knob to adjust the sound level.
- C.Press SEL button to select the BAS,TRE ,BAL,FAD mode then rotate vol+/-knob to adjust the level of them.
- D.Press SEL button hold for more than 2 seconds and select vol+ or - knob can have a beep sound.

## 4.6.TRACK UP /DOWN BUTTONS

- A. During CD mode, press ►► button allow you to track forwards. Hold it to skip forwards.
- B. During RADIO mode, press and hold ►► or ◄◄ for more than 2 seconds you can manual search channel. Then press ►► or ◄◄ ,you can have auto search channel.

## 5.APS BUTTON

IN RADIO MODE:

When short pressing, the radio searches for each preset station.

When the field strength level is more than the threshold level of stop level, the radio is holding at that preset number for few secretary with releasing mute, and than searches again. In FM band, FM 1, FM 2 and FM 3 is checked one at a time. When long pressing (more than 1 second),the radio searches from the current frequency and checks the signal strength level until 1 cycle search is finished. And then 6 strongest stations are preset to the corresponding preset number. The AS operation is implemented in the each band of selected band. When the AS operation is finished, the radio executes the preset scan.

## 7.DSP BUTTON

Press it to switch between 4 preset equalizer curves: FLAT,CLAS,POP M,ROCK M. The sound quality will be changed.

## 8.EJECT BUTTON

Press it to eject the disc from the disc slot .

## 9.MODE BUTTON

Press it repeatedly to select CDP, AUX and RADIO mode in sequence and circulation.

For **SUB WOOFER** function(optional), press and hold for more than 2 seconds can have WOOFER Mode.

For MP3 playing, this button can act as the digit 7 key.

## 10-11-12-13-14-15. PRESET MEMORY BUTTONS

A.To memorize the current frequency, press any one of the six preset Buttons hold for more than 2 seconds.

B.To recall the preset memory, press one of the preset buttons [1-6].

# BASIC OPERATION

---

- C). In CDP mode, press 1PAU button to pause CDP playing, press it again to resume CDP playing.
- D). In CDP mode, press 2SCN button to play the first 10 seconds part of each song, press it again to stop scanning and retain playing the song currently selected.
- E). In CDP mode, press 3RPT button to play the current track repeatedly. Press it again to cancel this mode.
- F). In CDP mode, press 4SHF button to play the track in random order. Press it again to cancel this mode.

## 16.SCAN BUTTON

Press it to scan up by one channel step with station detection. If a valid signal has detected, the current frequency is blinked with in 5 seconds, then press it again to stop scan and remain the current frequency; otherwise, the unit continue to scan up by one channel step with station detection 5 seconds later.

## 17.CLOCK BUTTON

Press it to display time on LCD for few seconds. Press it hold and then press **◀◀** or **▶▶** button to adjust hour or minute.

## 18.MUTE BUTTON

Press it to eliminate the sound immediately.

## 19.BAND BUTTON

Press it to select your desired radio band and the band which is selected will be displayed on LCD. Press it hold for more than 2 seconds can have LOUD mode.  
LOUD MODE:

When reduce the volume to half level, press it to enhance the bass effect.

## 20.POWER BUTTON

Press it to turn on or off the unit.

## 21.FLASHING LED

If the front panel is not on the main unit, LED will be flashing.

## 22.RESET

RESET button is placed on the housing and must be activated with either a ballpoint pen or thin metal object. The RESET button is to be activated for the following reasons:

- Initial installation of the unit when all wiring is completed.
- All the function buttons do not operate.
- Error symbol on the display.

Note: If press RESET button, the unit can't work yet, please use a cotton swab soaked in isopropyl alcohol to clean the socket on the back of the front panel.

## 23.ST BUTTON

Press ST button to stereo reception for radio stations.

# ELECTRIC CONNECTION

## WIRING CONNECTION

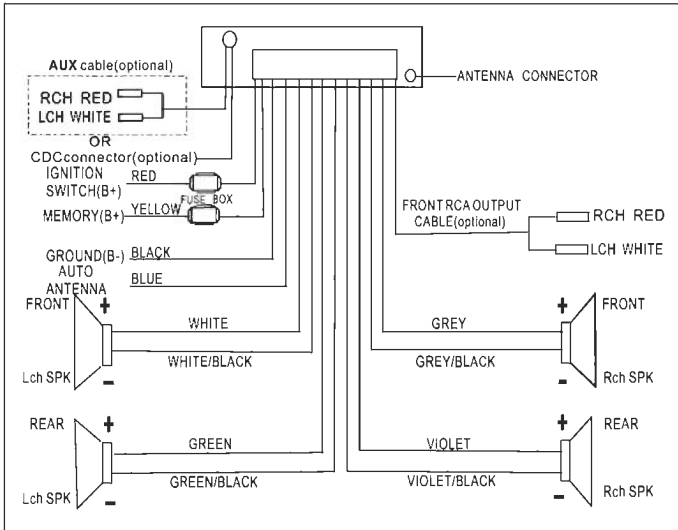

### NOTE:

In spite of having any kinds of speaker system, must use 4 ohms impedance of speaker to reduce the distortion during high volume level.

# INSTALLATION

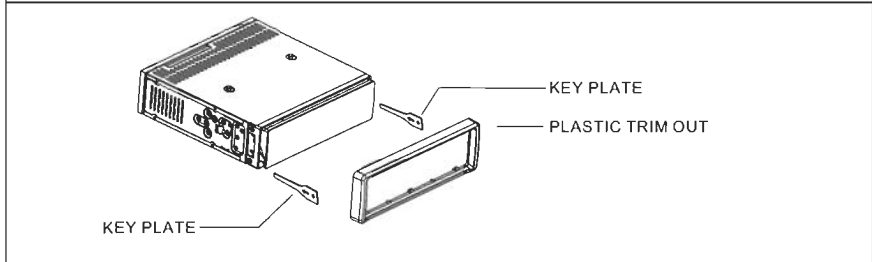
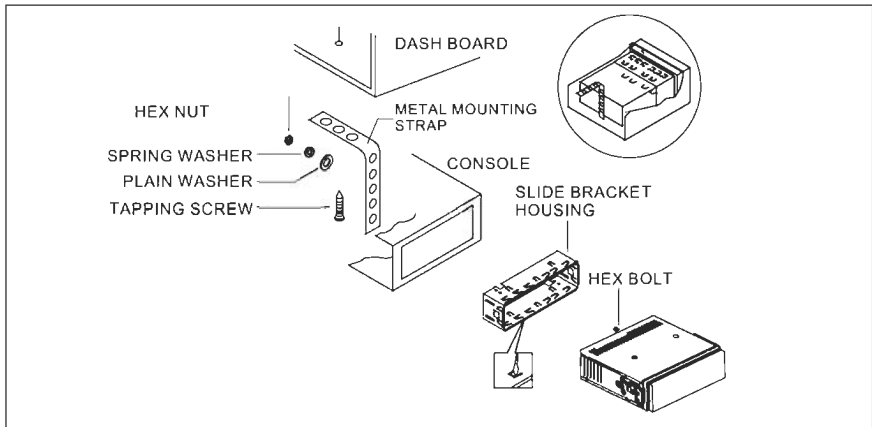

1. WHILE INSTALLING THE FRONT PANEL, PLEASE MOUNT THE LEFT SIDE FIRST, AND MAKE THE DIRECTION HOLE ON THE FRONT PANEL AIM AT THE LEFT GUIDE ON THE UNIT
2. THAN PUSH THE RIGHT SIDE TO MOUNT THE RIGHT GUIDE

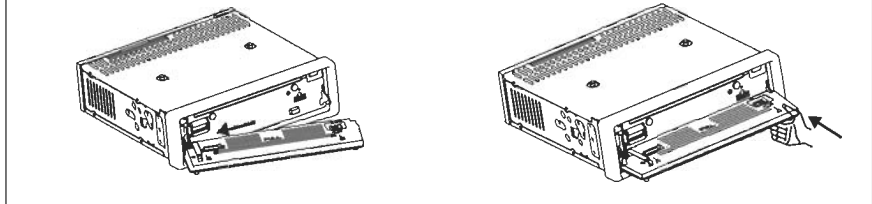

3. PUSH IT TO INSTALL THE FRONT PANEL COMPLETELY .

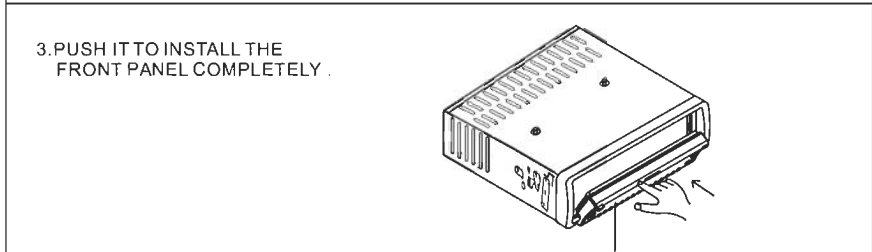

# INSTALLATION

**CAUTION: DO NOT INSTALL THE DETACHABLE PANEL BEFORE CONNECTING THE WIRE.**

1. The unit is designed for negative terminal of the battery which is connected to the vehicle metal. Please confirm it before installation.
2. If the car interior is extremely hot, as after being parked in the sun, do not use the player until the car has been driven for a while to cool off the interior.
3. Press the OPEN button to flip down the front panel (see fig.1), Slide the guide knob to remove the right side first, then take away the front panel. (see fig.2) and put it in the protective case (see fig.3) for safe keeping.
4. Install the front panel back in to its bracket and then push it back to the position for playing (see fig.4).

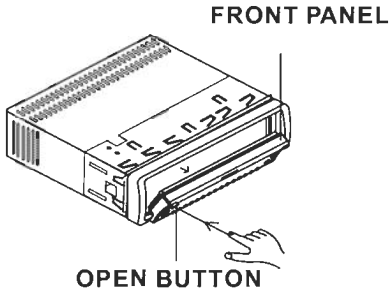

**(FIG.1)**

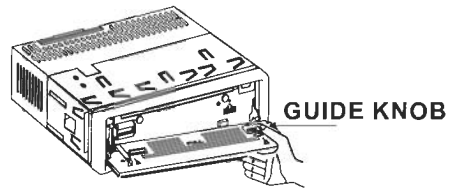

**(FIG.2)**

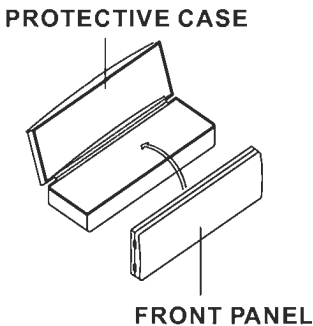

**(FIG.3)**

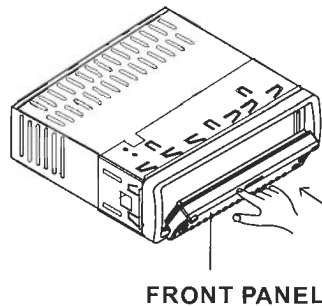

**(FIG.4)**

# NOTES

---

## DISC PLAY:

### CLEANING DISCS

Before playing, clean the disc with a clean, lint-free.  
Flip the disc in the direction of the arrow.

### NOTE 1:

Do not use so solvents such as benzine, thinners. Commercially available cleaners or anti static spray damage the unit.

Insert a disc with the label surface down. Doing so may damage the unit.

### NOTE 2:

Do not try to insert another disc when one has been already inserted.  
Doing so may damage the unit.

Handle the disc by its edge. And to keep the disc clean, do not touch the surface.

Do not stick paper or tape on the disc.

Do not expose the disc to direct sunlight or heat sources such as hot air ducts.  
Or leave it in a car parked in direct sunlight where there can be a considerable rise in temperature.

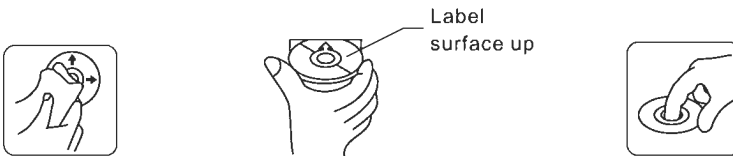

## PREPARING THE REMOTE CONTROL

### INSERTING THE BATTERIES

1. Open the battery compartment cover.
2. Insert the new batteries. Make sure that the positive and negative terminals of the batteries are oriented indicated.
3. Close the cover

### USING THE REMOTE CONTROL

Face the remote control towards the player front face IR mark (remote control signal receiver).

Operation angle: About  $\pm 30$  degree in each the direction of the front of the IR mark.

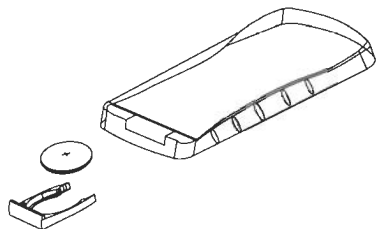



# SPECIFICATIONS

---

## GENERAL

POWER REQUIREMENT.....DC 12V

CURRENT CONSUMPTION.....5A

POWER OUTPUT.....4 X 7W

...

## RADIO SECTION

	For 3 Bands (Europe)	For 2 Bands (Europe)	For 2 Bands (U.S.A.)
	FM	FM	FM
FREQUENCY RANGE	87.5 to 108 MHz	87.5 to 108 MHz	87.5 to 107.9 MHz
USABLE SENSITIVITY.....			3uV
I.F FREQUENCY.....			10.7MHz

	MW	MW	AM
FREQUENCY RANGE	522 to 1620 KHz	522 to 1620 KHz	530 to 1710 KHz

	LW(OPTION)
FREQUENCY RANGE	144 to 288 KHz

## LINE-OUT [OPTION]

OUTPUT.....500mV @ FM 10% THD POWER

## CD PLAYER

SYSTEM.....COMPACT DISC AUDIO SYSTEM

USABLE DISC.....COMPACT DISC

SIGNAL FORMAT.....SAMPLING FREQUENCY 44.1KHz

NO OF QUANTIZATION BITS 1 BIT

FREQUENCY CHARACTERISTICS.....5-40Hz-5dB 10K-20KHz-5dB

SIGNAL TO NOISE RADIO.....70dB [1KHz] [IEC-A NETWORK]

NUMBER OF CHANNELS.....2 STEREO

CHASSIS DIMENSIONS.....184[W] X 54 [H] 170[D]

# TROUBLE SHOOTING

Before going through the check list, check wiring connection. If any of the problems persist after check list has been made, consult your nearest service dealer.

SYMPTOM	CAUSE	SOLUTION
NO POWER	The car ignition switch is not on	If the power supply is properly connected to the car accessory terminal, switch the ignition key to "ACC"
	The fuse is blown	Replace the fuse
DISC CANNOT BE LOADED OR EJECTED	Presence of disc inside the player.	Remove the disc in the player, then put a new one
	Inserting the disc in reverse direction	Insert the compact disc with the label facing upward
	The disc is extremely dirty or defective	Clean the disc or try to play a new one
	Temperature inside the car is too high	Cool off or until the ambient temperature return to normal
	Condensation	Leave the player off for an hour then try again
NO SOUND	Volume is in minimum	Adjust volume to a desired level
	Wiring is not properly connected	Check wiring connection
SOUND SKIPS	The installation angle is more than 30 degrees	Adjust the installation angle less than 30 degrees
	The disc is extremely dirty or defective disc	Clean the compact disc, then try to play a new one
THE OPERATION KEYS DO NOT WORK	The built-in microcomputer is not operating properly due to noise	Press the RESET button. Front panel is not properly fixed into its place
THE RADIO DOES NOT WORK	The antenna cable is not connected	Insert the antenna cable firmly
	The signals are too weak	Select a station manually

## Free Manuals Download Website

<http://myh66.com>

<http://usermanuals.us>

<http://www.somanuals.com>

<http://www.4manuals.cc>

<http://www.manual-lib.com>

<http://www.404manual.com>

<http://www.luxmanual.com>

<http://aubethermostatmanual.com>

Golf course search by state

<http://golfingnear.com>

Email search by domain

<http://emailbydomain.com>

Auto manuals search

<http://auto.somanuals.com>

TV manuals search

<http://tv.somanuals.com>