

OWNER'S MANUAL



C a r A u d i o H i f i S y s t e m

PYLE[®] PLD128

DVD/VCD/CD/MP3 PLAYER

Contents

Safety Precautions.....	2	Play Operation.....	8
Electric Connection.....	3	Play/Pause	
Reception collection		Random	
Speaker collection		Repeat	
Installation.....	4	Stop	
Install the unit		PBC	
Remove the unit		Radio Operation.....	9
General Features.....	5	Band	
Power		Band tuner	
Volume		Remote Control.....	10
Eject		Loading and Replacing the battery	
Release		Basic operation	
Mode		Specifications.....	18
N/P		Trouble Shooting.....	19
Clock			
Speaker setting.....	7		
Volume setting			
Bass setting			
Treble setting			
Balance setting			
Fader setting			

Safety precautions

▲ CAUTION

To prevent injury or fire, Please take the following precautions:

- Do not operate when driving.
- To prevent electric, etc, Please do not let the metal goods (silver, coin, tools...) fall into the installation.
- If you smell or see smoke, turn off the power immediately and consult our dealer.
- Be careful not to drop or shock the unit strongly.
- Do not touch the liquid crystal to avoid the life hurt. If the clothes is stained with it, Please clean it immediately by soap.
- For your driving safety, please link your brake detecting wire with low power level, and keep it controlled by manual brake switch. when driving a car, the brake wire shall be high power level and now, unit can not play DVD or VCD disc.

▲ WARNING

To prevent damage to the machine, Attaching panel: take the following precautions:

- Be sure the unit is connected to a 12V DC power with a Negative Ground.
- Do not install the unit in places where it is exposed to direct sunlight, high heat or humidity, water splash or dust.
- To change fuse, please use the same one in specification and capacity.
- When changing fuse, please do it after pulling down power wires to avoid short circuit.
- If the unit seems not work in proper situation, please press the reset button to resume the function.

Attach the front panel by fixing the left Side of it into this unit as 1 showing. Then push the right side of panel towards into connecting plug as 2 showing.

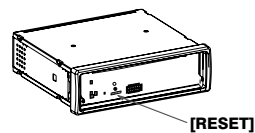
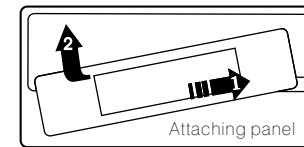

Electric Connection

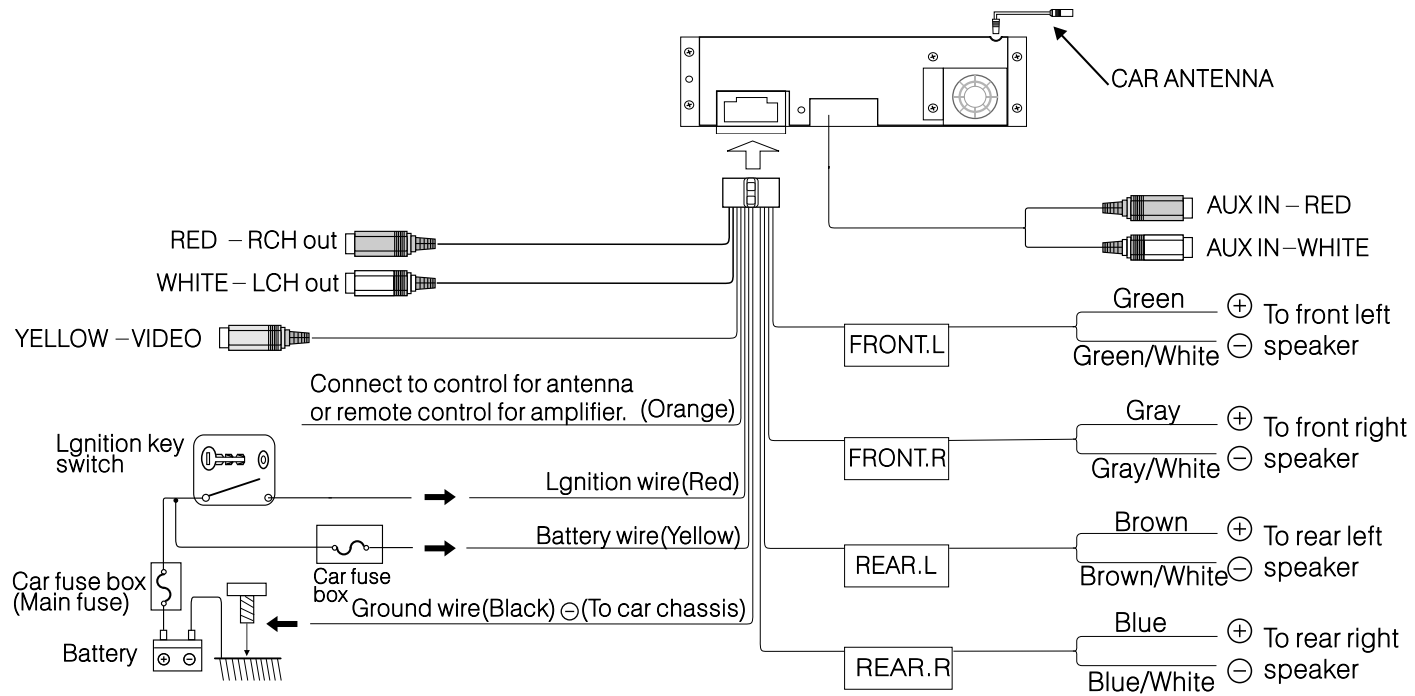

Installation

Before installing the receiver permanently, fit it in the approximate place in your car, and connect the equipment according to the speakers and electrical connections. When your system is operated properly, (preferably with the car engine running), follow the instructions for permanent installation of your system.

INSTALL THE UNIT

- 1) Install half sleeve, can be with or without adapter. It will fit better with adapter.
- 2) Bend over some tabs to secure the half sleeve inside of dash.
- 3) Support strap to be strutted under dash, secure this strip to avoid skipping of disc.

REMOVE THE UNIT

- 1) Insert removal wrench into the small gap on the right side of the unit and pull the unit slightly out on the same side, then release the wrench. Repeat the same action for the left side. By now, you can remove the unit and unplug the wires connector.

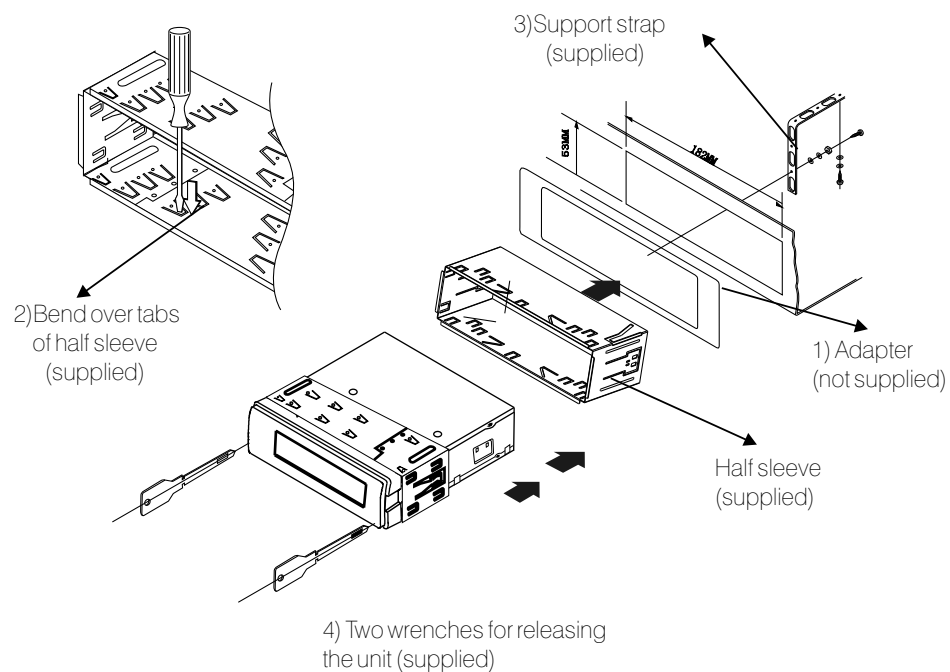

General Features

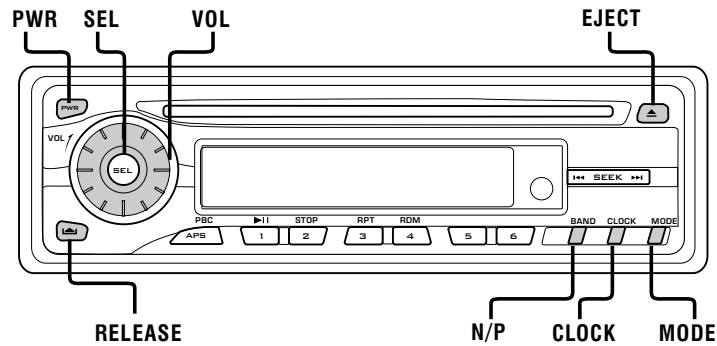

Power

ON/OFF

Press the [PWR] button to turn on/off the unit.

Volume

Increasing volume

Rotate the SEL/VOL button in clockwise direction.

Decreasing

Rotate the SEL/VOL button in anticlockwise direction.

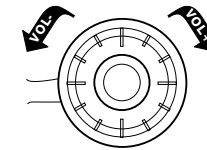

Eject

Out

Press the [▲] button to eject the disc out of the unit .

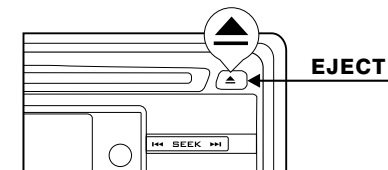

Release

press the "▲" button to release faceplate.

General Features

MODE

Selecting radio and play

 Press the [MODE] key.
(If mode with AUX IN and TV, the function is below:
press MD(MODE) to select:

RADIO ► DISC ► TV ► AUX IN ► RADIO

2 If without AUX IN and TV, press MD that is:

RADIO ► DISC ► RADIO

N/P

 In PLAY mode, press the [BAND] button to exchange between the PAL and NSTC.

Clock

Short press CLK can display time even power off.
Long Press CLK for 3 seconds will enter set mode.

Hour

Press the [CLOCK] button until the hour number blinking then rotate the VOL button to set the hour.

Minute

Press the [CLOCK] button until the hour number blinking then press the [CLOCK] again until the minute number blinking and rotate the VOL button to set the minute.

Quit clock set mode

there is no operation in 5 seconds, it will quit clock set mode.

Speaker setting

Speaker mode

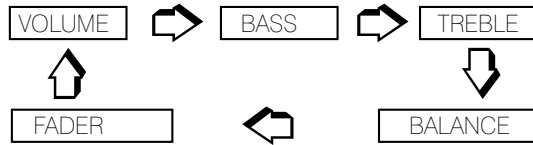

• Volume set mode

Press SEL button once, display will show VOL on, then rotate the button in clockwise direction to increase volume level; rotate the button in anticlockwise direction to decrease volume level.

VOL 10

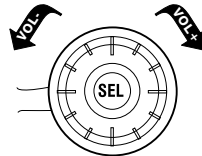

• Bass set mode

Press SEL button twice, display will show BAS on, then rotate the button to adjust bass level up/down in different direction.

BAS -6

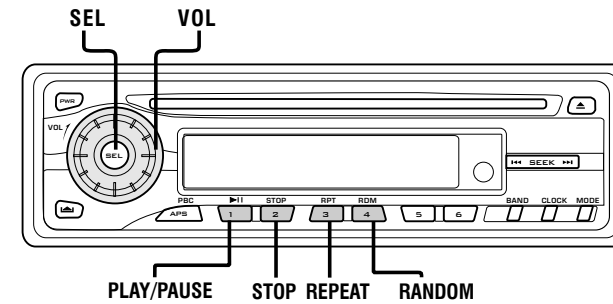

• Treble set mode

Press SEL button third, display will show TRE on, then rotate the button to adjust treble level up/down in different direction.

TRE 5

• Balance set mode

Press SEL button fourth, display will show BAL on, then rotate the button to adjust left and right speakers level up/down in different direction.

BAL 4

• Fader set mode

Press SEL button fifth, display will show FAD on, then rotate the button to adjust front and rear speakers level up/down in different direction.

FAD -3

Play control

Play/pause

Play

If with DISC in unit, Press the [▶||] to pause music.

Pause

Press the [▶||] button again, come back DISC playing.

 If a disc is loaded, a sector sign will show on the display.

Random

Press [RDM] button

 Press this button to play all the track in random order. Press it again to stop random playing. This button is invalid if the unit is in PBC On mode.

Repeat

Press [RPT] button

 Press the button to repeat the same track continuously, RPT will appear on the LCD display. Press the button again to come back normal playing.

Stop

Press [STOP] button

 Press STOP button to stop music, and press ▶|| button to start playing from track one.

PBC

Press [PBC] button

 If the disc is VCD 2.0 version or above, press this button to toggle the PBC function.

Radio Operation

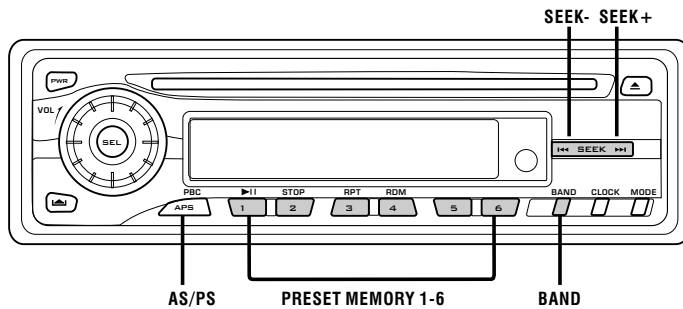

Tuner

manual tuning:

- short press ►► button it can select higher frequency station.
- Short press ◄◄ can select lower frequency station.

Auto loading tuning:

- the long press ►► button it can automatically select higher frequency station. And the long press ◄◄ it can automatically select lower frequency station.

Select station

Press [APS]button

- Seek Tune:
In FM (FM1 FM2 FM3) or AM(AM1 AM2) playing mode, long press "APS" button, it can seek and store strong frequency station automatically in to 1-6 memory buttons.
FM can be memorized 18 stations. AM can be memorized 12 stations.

Band

Selecting band

- Press BAND button to select among three FM or two AM bands.
(FM1-FM2-FM3-AM1-AM2)

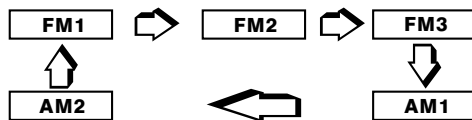

Remote control



Loading and replacing the battery

Use one lithium battery(CR2025)
Insert the batteries with the + and - poles aligned properly.
Following the illustration inside the case.

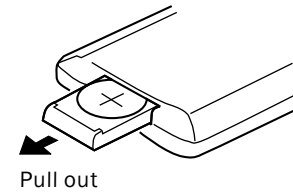

▲ WARNING

Store unused batteries out of the reach of children. Contact a doctor immediately if the battery is accidentally swallowed.

Do not set the remote on hot places such as the above dashboard.

Basic operation

POWER

Press this button to turn on/off the unit.

CLK

Press this button can show the time,and long press to enter clock adjustment.

MODE

Press this button can select needed receiving and playing mode.

EQ

Press this button can select mode as POPS,JAZZ,ROCK,DSP OFF.

SEEK+/SEEK-

Press this button can manually search tune,fast,back and track searching control.

SEL

Repeatfully press this button can select needed mode.

BAND P/N

Under receiving position,press this button can select band; under VCD,DVD position,press this button can select automatic,PAL or NTSC.

VOL+/VOL-

Press this button can increase or decrease volume.

LOC/RDM

Under receiving position,press this button can do far and close switch;under VCD,CD playing,press this button can play randomly.

■ Stop ▶|| Play/pause

■ Press this button to stop playing.

▶|| Press this button can switch between play and pause.Under stop state, similarly press it to play.

ST/PROG

Under receiving state,press this button can select stereo or single track;under playing state,it can do programme play cooperating with STOP button.

Basic operation

PBC

When playing VCD,OK disc,press this button can show all the programme menu,and can cooperate numeral buttons to select programmes.

[←] [→] [↑] [↓] [ENTER]

Under DVD mode, press this button can move cursor in up,down,left and right directions after entering SETUP Menu.Press ETR button can confirm selected item.

AMS/RPT

Under receiving state,press this button can scan memory stations.Long press it can automatically scan and store them.

SETUP

Under playing mode,press this button can open SETUP Menu.

ZOOM

Press this button can zoom picture.

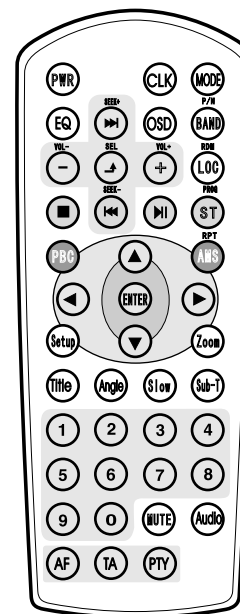

TITLE

Under VCD mode,press this button to enter Menu selection same as PBC.

Under DVD mode,press this button to return to the top of Menu.

Basic operation



ANGLE

Under DVD mode,press this button can change visual angle.

SLOW

Under VCD mode,press this button can advance slowly.
Under DVD mode,press this button can advance and back off slowly.

SUBTITLE 0-10+

Under DVD mode,press this button can switch dialogue language.

Press this button can directly select track and chapter,and 1-6 buttons can select presetted stations.

AUDIO

Under VCD mode,press this button can switch track.
Under DVD mode,press this button can switch dialogue language.

MUTE

Press this button to turn off volume out ,and again to resume.

OSD

Press this button can show play time, surplus time.

Basic operation

Setup Menu for Universal Capability

Press SETUP, screen will show system setup menu as follows:

- Press[▲] [▼] select Menu
- Press[◀] return to Menu
- Press[▶] Enter Menu
- Press[ENTER] to confirm

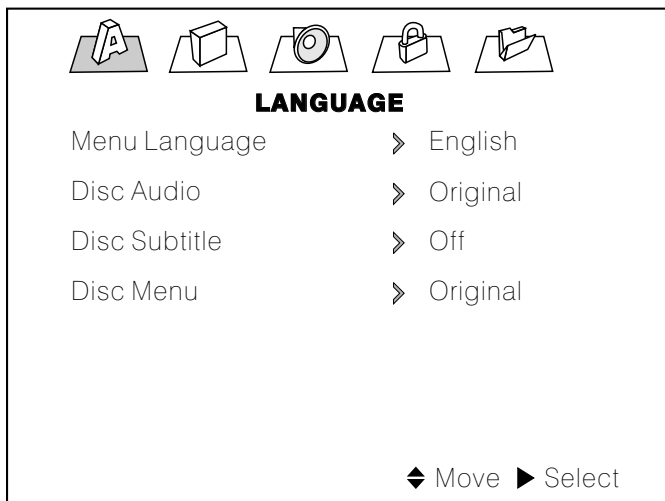

Display Setup Menu

- Press[▲] [▼] select Menu
- Press[◀] return to Menu
- Press[▶] Enter Menu
- Press[ENTER] to confirm

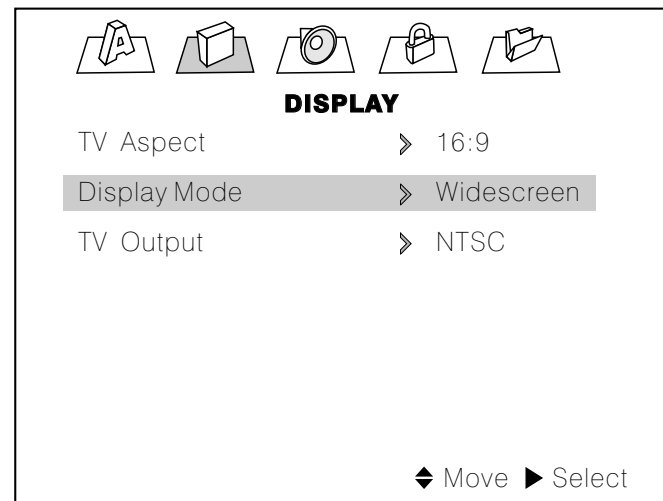

Basic operation

Audio Setup Menu

- Press[▲] [▼]select Menu
Press[◀] return to Menu
Press[▶] Enter Menu
Press[ENTER] to confirm

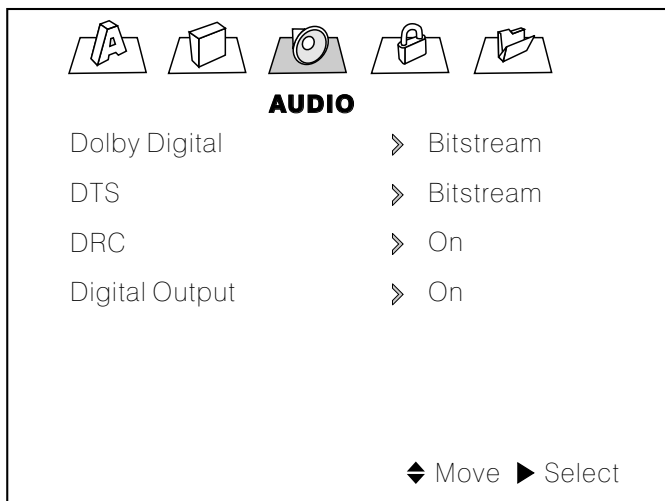

Lock Setup Menu

- Press[▲] [▼]select Menu
Press[◀] return to Menu
Press[▶] Enter Menu
Press[ENTER] to confirm

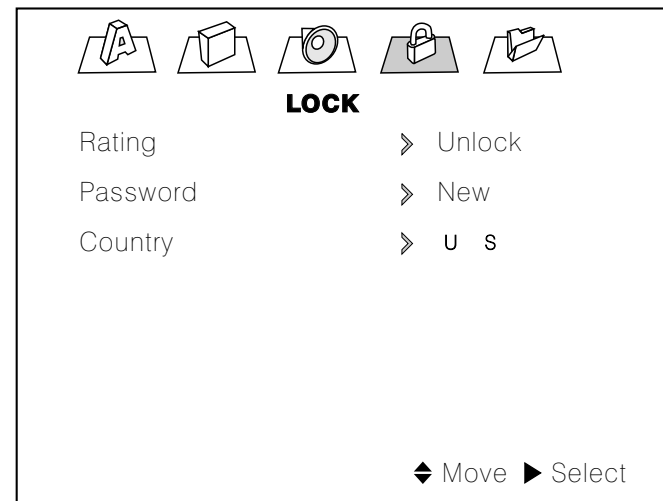

Basic operation

Others Setup Menu

- Press[▲][▼]select Menu
- Press[◀]return to Menu
- Press[▶]Enter Menu
- Press[ENTER]to confirm

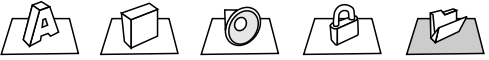

OTHERS





Load Defanit	➤ Select
Screen Saver	➤ On

◆ Move ▶ Select

Mp3 menu

Insert MP3 disc, and TV will show menu as follows:

Music

<div style="border-bottom: 1px solid black; padding-bottom: 5px;"> List </div> <table style="width: 100%; border-collapse: collapse;"> <tr><td style="border-bottom: 1px dashed black;">1-001</td><td style="border-bottom: 1px dashed black;">MP3</td></tr> <tr><td style="border-bottom: 1px dashed black;">2-002</td><td style="border-bottom: 1px dashed black;">MP3</td></tr> <tr><td style="border-bottom: 1px dashed black;">3-004</td><td style="border-bottom: 1px dashed black;">MP3</td></tr> <tr><td style="border-bottom: 1px dashed black;">XXXXX</td><td style="border-bottom: 1px dashed black;">XXX</td></tr> <tr><td style="border-bottom: 1px dashed black;">XXXXX</td><td style="border-bottom: 1px dashed black;">XXX</td></tr> <tr><td style="border-bottom: 1px dashed black;">XXXXX</td><td style="border-bottom: 1px dashed black;">XXX</td></tr> </table>	1-001	MP3	2-002	MP3	3-004	MP3	XXXXX	XXX	XXXXX	XXX	XXXXX	XXX	   	<div style="border-bottom: 1px solid black; padding-bottom: 5px;"> Program </div> <table style="width: 100%; border-collapse: collapse;"> <tr><td style="border-bottom: 1px solid black;"> </td></tr> <tr><td style="border-bottom: 1px solid black;"> </td></tr> <tr><td style="border-bottom: 1px solid black;"> </td></tr> <tr><td style="border-bottom: 1px solid black;"> </td></tr> <tr><td style="border-bottom: 1px solid black;"> </td></tr> <tr><td style="border-bottom: 1px solid black;"> </td></tr> </table>						
1-001	MP3																			
2-002	MP3																			
3-004	MP3																			
XXXXX	XXX																			
XXXXX	XXX																			
XXXXX	XXX																			
▶ 0:01:44 #2/135																				
\001 _____MP3																				

In this menu, the right is the submenu of the left, and it can cooperate remote control [◀][▶][▲][▼] buttons to select wanted contents and programmes and press ENTER to confirm.

Accessories

External view

..... **Number of items**



.....1



.....2

External view

..... **Number of items**



.....1



The use of any accessories except of those provided might result in damage to the unit .Make sure only to use the accessories shipped with the unit ,as shown above.

Specifications

Specifications subject to change without notice.

CD PLAYER

Signal/Noise ratio.....70dB
Frequency response.....20Hz-20KHz(+3dB)
Channel separation.....>45dB
Dual D/A converter.....16Bit

FM Tuner

FM 65-74MHz
Tuning range.....EUROPE:87.5-108.0MHz
(50KHz step)
USA:87.5-108MHz
(100KHz step)
FM usable sensitivity(S/N=30dB).....<12dB
Stereo separation.....>45dB

AM Tuner

Tuning range.....EUROPE:522-1620KHz
(9KHz step)
USA:520-1720KHz
(10KHz step)
AM sensitivity.....28dB

GENERAL

Operating power.....12 Volts DC,negative
ground
%10THD output wiring.....Designed for using four
speakers only front and rear
channels cannot be combined
in use with 2speakers.
Load impedance.....compatible 4 to 8 ohm
speakers
Fuses.....10 amp
Dimensions.....178mm(L)x50mm(W)
x150mm(H)
Weight.....2.5Kgs

Trouble shooting guide

What might seem to be a malfunction in your unit may just be the result of slight misoperation or miswiring. Before calling service, first check the following table for possible problems.

?The power does not turn ON.

✓ The fuse has blown.

 Confirm whether the lead short circuit, then replace fuse with same capacity.

?NO Sound.

✓ The cable connect incorrectness.

 Exactitude connect of the cable.

?Noise on Radio or poor reception

✓ Antenna and Antenna Cable.

 Check antenna and antenna cable, the antenna base must be grounded and connected with good condition, replace antenna or antenna cable if needed.

?Noise on both Radio and CD

✓ Poor ground, dirty or corroded at the car Battery posts

 Check the black wire for proper grounding clean and tighten ground connection.

?No/Poor sound on one or more speakers

✓ Speakers or speaker wiring or volume, Balance and Fader setting

 Check the speaker wiring and test the speakers all in good condition check the setting of volume, Balance and Fader controls.

?CD sound skips

✓ Installation the unit angle is greater than 45°, or mounting is not fixed and the back strap is not secure.

 Adjust the unit with mounting angle less than 45° and make sure the unit is mounted securely and tighten with the back strap (supplied)

?Unit completely inoperative, no Light and Sound

✓ Incorrect wire connection, Power RED/YELLOW or Ground wire or Blown fuse

 Check the Red wire to +12 Volts with key Ignition switch, yellow wire to +12 Volts battery and black wire to ground. Check Fuse with red/yellow wire, or check the fuse block on your car.

OWNER'S MANUAL

Before installation and operating the unit please read
this manual thoroughly and retain
it for future reference

Free Manuals Download Website

<http://myh66.com>

<http://usermanuals.us>

<http://www.somanuals.com>

<http://www.4manuals.cc>

<http://www.manual-lib.com>

<http://www.404manual.com>

<http://www.luxmanual.com>

<http://aubethermostatmanual.com>

Golf course search by state

<http://golfingnear.com>

Email search by domain

<http://emailbydomain.com>

Auto manuals search

<http://auto.somanuals.com>

TV manuals search

<http://tv.somanuals.com>