

PYLE

Multi Media Mobile Audio System

PLDMN65

OPERATIONAL MANUAL



Thank you for buying this product.

Please read through these operation instruments so you will know how to operate your model properly. After reading please keep this booklet in safe place for future reference.

1 Before You Start

- Important Safeguards 4
- About this manual 4
- Precautions 5
- Maintenance 8
- Location & function of the controls 7
- Remote control 8
- Specifications 10

2 Installation

- Wiring Connections 11
- Install the Unit 12

3 Common Operations

- Reset the Unit 13
- Turning the Unit On/Off 13
- Volume Control 13
- Changing Widescreen Mode 13
- Setting the Sound Characteristics 13
- EQ Setting 13
- Turning Loudness On 14
- Eject a Disc 14
- Open the Monitor 14
- Angle Setting 14
- Mute Function 14
- Clear 14
- Mode Selector 14
- Sensor 14

4 Main Menu

- Main Menu Setup 15
- Audio Adjust 15
- Video Adjust 16
- Source Setup 17
- Others 18

5 DVD

- Playing a DVD 20
- Selecting Tracks Fast 20
- Repeat Playing 20
- Stop the Playback 20
- Pause the Playback 20
- Selecting Tracks F.F/F.REW 21
- System Switch 21
- Slow Motion Playback 21
- Increase Picture Size 21
- On Screen Display 21
- Setting the Playback Time 21
- Changing the Viewing Angle 22
- Changing Audio Language 22
- Changing the Subtitle Language 22
- Selecting Menu 23
- Set Up Menu 23

Simple Troubleshooting Guide

The following checklist is helped to solve the problems which you meet when using the unit. Please double check and make sure if the connection and the procedure of the operation is properly before using the checklist below .

Problem	Cause/Solution
No power.	<ul style="list-style-type: none"> • Check and make sure whether the fuse is blown, replace with the proper value if necessary.
Some errors occur in the LCD or no function when pressing the button.	<ul style="list-style-type: none"> • Press RESET button.
Unable to receive stations.	<ul style="list-style-type: none"> • Check and make sure whether the antenna is inserted or the antenna is properly connected, if so, insert the antenna or connect it properly.
Poor effect on receiving a station.	<ul style="list-style-type: none"> • Antenna may not be the proper length. Make sure the antenna is fully extended or broken; if broken, replace the antenna with a new one. • The antenna is poorly grounded, check and make sure the antenna is properly grounded at its mounting location. .
CDs cannot be loaded.	<ul style="list-style-type: none"> • A CD is loaded in the mechanism.
Sound skips.	<ul style="list-style-type: none"> • The CD is dirty or damaged.
No images.	<ul style="list-style-type: none"> • The Video line from main unit to the TV is not connected properly.
Images skip.	<ul style="list-style-type: none"> • Improper setting of the color system. Set the color system to "PAL" or "NTSC" according to the connected television.

Note:

If any of the problem persist after check list had been made, consult your nearest service dealer. Never attempt to disassemble your unit by yourself.

MO/ST Selector

During radio status, you can press **6** **ST** button on the remote control to select **Mono** mode or **Stereo** mode.

Stereo reception is charged when “steer” appears.

It is switched to **MONO** mode when “mono” appears.

Notes:

- * Pressing **AUD** on the head unit performs the same function.
- * Switch to **MONO** compulsively to improve the listening quality when weak signal.

Scanning/Memorizing Stations Automatically

During radio status, you can press **4** **AMS** button on the remote control to scan each stored station 5 seconds respectively which stored in **23** Number Buttons (from 1 to 6). You can press the corresponding Number Buttons or **AMS** button when your desired station is charged. And it starts playing that station.

When press and hold **4** **AMS** button for more than 2 seconds, it will activate automatically memory storing function. The radio automatically selects a station and has it stored in any one of the **23** **Number Buttons (from 1 to 6)**.

Notes:

- * The unit can be stored up to 6 stations for each band.
- * Pressing **AMS** button on the head unit also performs the same function.

Number Buttons

During radio status, press **Number Buttons** to receive the stored stations.

During radio status, **Number Buttons (from 1 to 6)** **23** can help you store your favorite station. You can follow the steps as below:

- 1 When receiving a station, press and hold any one of the **Number Buttons (from 1 to 6)** until the number appears on the **LCD**, which indicates that station is already stored in the corresponding number button.
- 2 Press **4** **AMS** button to receive stations automatically, and store them in 1 to 6 number respectively.
- 3 Press and hold another number button more than 2 seconds when listening in a station in one number button's, the station will be stored in that number button.

Note:

- * It is only valid on remote control.

6 Mp3

Playing a Mp3 Disc 32
 Selecting Tracks F.F/FREW 32
 Mp3 Menu Mode 32
 Repeat Playing 33
 Playing Tracks at Random 33
 Number Buttons 33
 Stop Playing 33
 Pause the Playback 33
 Skip Backward/Forward/F.F/FREW the Playback 33
 On Screen Display 33

7 VCD/CD

Playing a VCD/CD Disc 34
 Selecting Tracks F.F/FREW 34
 Repeat Playing 34
 Playing Tracks at Random 34
 Number Buttons 34
 Stop Playing 34
 Pause the Playback 35
 Skip Backward/Forward/F.F/FREW the Playback 35
 System Switch 35
 Slow Motion Playback 35
 Increase Picture Size 35
 On Screen Display 35
 Setting the Playback Time 36
 Scanning Tracks Automatically 36
 Program Playing 36
 Selecting Channel 36
 Selecting Title 36

8 Listening to the Radio

Band Selector 37
 Manual/Automatic Tuning 37
 DX/LOC Selector 37
 MO/ST Selector 38
 Scanning/Memorizing Stations Automatically 38
 Number Buttons 38

9 Additional Information

Simple Troubleshooting Guide 41

IMPORTANT SAFEGUARDS About this manual

- 1 Be sure to connect the color coded leads according to the diagram. Incorrect connections may cause the unit to malfunction or damage the vehicle's electrical system.
- 2 Be sure to connect the speaker (-) leads to the speaker (-) terminal. Never connect the left and right channel speaker cables each other or to the vehicle body.
- 3 Make sure all the connections are completely correct before turning on your unit.
- 4 When replacing the fuse(s), the replacement must be of the same amperage as shown on the fuse holder.
- 5 Do not block vents or radiator panels. Blocking them will cause heat to build up inside and may result in fire.
- 6 To lest the driver distract his attention from, please install the unit in an apt place.
- 7 Using the unit after starting the engine, otherwise the unit can not be started, because the electric energy of battery was used up.
- 8 The unit must be screened from direct sunlight, or the electric energy of battery will be wasting for the high temperature.
- 9 Do not use the unit in extreme high temperature or such low temperature conditions, and also avoid humidity and direct sunlight.
- 10 Take care of the magnetism of the unit. Do no put the credit card, cassette or watch around the unit, or they would be broken or some information in them lose.
- 11 To lest disturb the video frequency, keep far away from the unit when using your phone.
- 12 Do not put the remote control under high temperature or where the sun strikes it, or else the control remote can not work normally.

This unit features a number of sophisticated functions ensuring superior operation. All the functions have been designed for the easiest possible use, but many are not self-explanatory. This manual will help you understand the functions and operations of the unit. This manual main explains **remote control operation**. However, in addition to those functions related with DVD/VCD/CD/MP3 operation that can only be operated by the remote control, there are also functions can be operated by the buttons provided for the main unit.

Listening to the radio

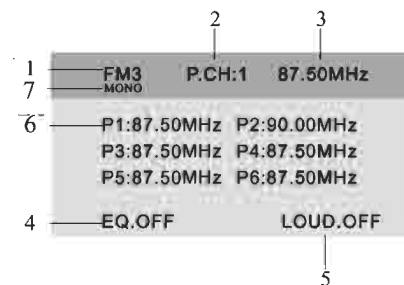

- 1 **Band Indicator**
Shows which band the radio is tuned to.
- 2 **Preset Number Indicator**
Shows what preset has been selected.
- 3 **Frequency Indicator**
Shows which frequency the tuner is tuned.
- 4 **EQ Indicator**
Shows the EQ Setting of the radio.
- 5 **MBP Indicator**
Shows that MBP is on or off.
- 6 **The 6 stations of the current band.**
- 7 **To show the current channel is MONO or STEREO.**

Band Selector

During radio status, repeatedly press **5** BAND button to select bands in the following order:

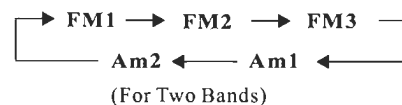

Note:

- * Press BAND button on the head unit performs the same function.

Manual/Automatic Tuning

Manual Tuning: Press **20** (▶▶ or ◀◀) button on the remote control continuously to select a station downward or upward respectively.

Automatic Tuning: Press and hold **20** (▶▶ or ◀◀) button for more than 3 seconds, the radio searches a station downward or upward automatically, respectively. And plays when it finds a station.

Note:

- * Press ▶ and ◀ button on the head unit performs the same function.

DX/LOC Selector

During radio status, press **5** LOC button to select strong or weak station reception. "LOC" appears on the display and only local station is available. when it disappears both distance and local stations can be received.

Notes:

- * The function is only valid in searching stations.
- * Pressing LOC on the head unit performs the same function.

Setting the Playback Time

During VCD/CD playback, Press **2** **GOTO** to set the playback time, "--: --: --" appear on the monitor, input the time what you wish by pressing the number button. For example, input "20:00", the play will begin from the 20th minute of the disc.

Note:

- * The function is only valid on remote control.

Scanning Automatically

During VCD/CD playback, Press **4** **AMS** to play the first 10 seconds of each track. Press it again to play the track which is scanning.

Notes:

- * The function is only valid under all disc repeat status..
- * Pressing AMS on the head unit performs the same function.

Program Playing

During VCD, CD mode, you can set the program order to play. Follow the steps as bellow:

press **13** **PROG** button, select your desired tracks by using **Number Buttons**, press **27** **Enter** to enter. After selecting all tracks, press **27** **Enter** to play followed the order you set. Press **13** **■** to cancel program playing.

Selecting Channel

During VCD/CD status, repeatedly press **23** **AUDIO** button to select the following channels:

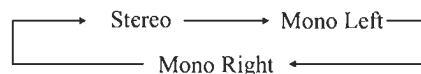

Selecting the corresponding channel to set the different sound characters.

Note:

- * Pressing AUD on the head unit performs the same function.

Title Selector





During VCD status, Press **3** **TITLE** button to return the root menu of the disc, the TFT displays all the tracks of the disc. You can also press **27** or **23** button to choose the desired tracks.

Notes:

- * Pressing **6** button on the head unit performs the same function.
- * Under PBC ON status, press stop button to return to the root menu.
- * The function is valid for VCD 2.0 version disc.

PRECAUTIONS

This unit can play the following discs only:

Type of disc	Label on the disc	Recorded material	Size of disc
DVD		Sound and moving pictures	12cm
VCD		Sound and moving pictures	12cm
CD		Sound only	12cm
MP3		Sound only	12cm

NOTE: The unit is compatible with VCD1.0/2.0/3.0 version and DVCD disc.

- **Do not attempt to modify the unit, modifying the unit may cause an accident.**
- **Stop the vehicle before carrying out any operation that could interfere with your driving.**
- **Do not work in extremely high or low temperature. Be sure the temperature inside the vehicle is between +60° C and -10° C before turning on your unit .**
- **To enjoy optimum sound and images while playing, handle the discs as follows:**

—Do not use your CDs with paste residue or ink attached.



—Do not use CDs with labels or stickers attached, which may leave a sticky residue while beginning to peel off.
(Shown as the picture)



—Clean the discs with an optional cleaning cloth. Wipe each disc from the center out.
(Shown as the picture)

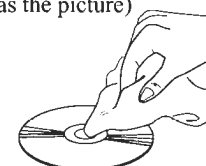

—Handle the disc by its edge to keep the disc clean, and do not touch the surface.



Besides playing the discs above, the unit also can be connected to TV, CD Changer and other connector. Please refer to the details on page 17 before you playing them.

Maintenance

Replacing the Fuse

Make sure the amperage matches the specified value when replacing the fuses. If the fuse is blown, check the power connection and replace with a new one. If the same problem occurs, it would be subjected to the malfunction in-house. In such cases, please consult the nearest service dealer.

▲ Warning

Never use the fuse with the rated amperage more than that supplied to your unit, otherwise it will damage the unit.

Replacing the Battery

When the range of the operation of the card remote control becomes short or no functions while operating. Replace the lithium battery with a new button cell (CR2025). Make sure the battery polarity before replace.

Gently pull out the Battery Holder while pressing the Stopper.

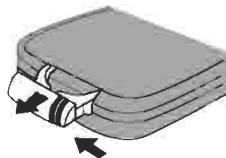

Put the button-type battery with mark(+) upward into the Battery Holder.

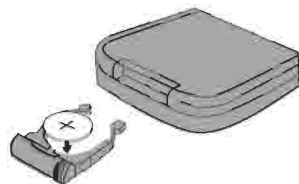

Insert the Battery Holder into the Remote Control.



Precautions on Using Lithium Battery

Always keep the lithium battery beyond children's reach. In case swallowed, see a doctor immediately.

Cleaning the battery with a dry cloth, to ensure its perfect connected.

Make sure the proper polarity when loading with the battery.

To prevent short circuit, do not use metal tweezers to clip the battery.

▲ Warning!

Improperly handling the battery may result in hazardous explosion. It cannot be charged, disassembled or thrown into a fire.

Pause the Playback

During VCD/CD playback, press **17** **||** to switch between play and stop.

■ Note:

* This function is operated by using the remote control.

Skip backward/forward/F.F /F.REW the playback

Press **20** (**◀** or **▶**) on remote control to perform fast reward or fast forward.

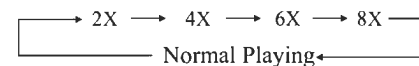

■ Note:

* Pressing **◀** and **▶** on the head unit perform the same function.

System Switch

During VCD/CD mode, Press **11** **P/N** on remote control to set the TV standard to PAL or NTSC or AUTO system.



■ Note:

* The function is only valid on remote control.

Slow motion playback

During VCD mode, press **16** **||** to slow forward. There are 3 speeds as follow:.

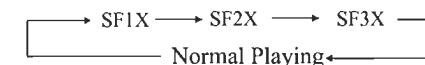

■ Note:

* The function is only valid on remote control.

Increase the size of the picture

During VCD mode, Press **9** **ZOOM** to increase the picture in size. There are 3 sizes.

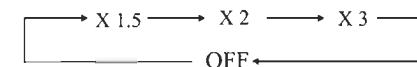

■ Note:

* The function is only valid on remote control.

On Screen Display

During VCD/CD status, repeatedly press **8** **OSD** button on the card remote control, the display as follow:

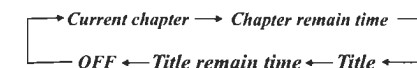

Press and hold **8** **OSD** to display the current setup.

■ Note:

* The function is only valid on remote control.

Playing a VCD/CD

Insert a VCD/CD disc into the slot, the unit will automatically switch on, if a MP3 disc is loaded, press SRC to start the playback.

Note:

- * You can eject a VCD/CD disc by pressing ▲ on the base or ▲ on the remote control.

Selecting Tracks Fast

During VCD/CD playback, firstly press ② ⏮ to replay the current track, press ② ⏮ again to play the backward track, Press ② ⏭ to play next track.

Note:

- * Pressing ▲ and ▼ button on the head unit also performs the same operation.

Repeat Playing

During VCD/CD playback, repeatedly press ⑮ RPT to perform replaying function, the order is:

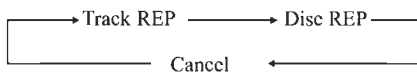

Note:

- * This function is operated by using the remote control.

Playing Tracks at Random

During VCD/CD playback, pressing ⑮ RDM button on the remote control to play any track at random under the directory which you select. Press it again to return to normal playing.

Note:

- * This function is operated by using the remote control.

Number Buttons

Press one of ⑳ Number Buttons(0~9) to select a track, press ENTER to play immediately, or it will be played automatically after 5 seconds.

Note:

- * This function is operated by using the remote control.

Stop Playing

During VCD/CD playback, firstly Press ⑰ ■ button to stop playing, press ⑳ to replay.

Note:

- * Pressing ENTER on the head unit also performs the same function.

Location of the Controls

Front Panel



- | | |
|---|---|
| <p>① POW/SRC Button
Briefly pressing to select radio mode or playback mode, hold and press it to turn the unit on or off.</p> <p>② BAND/EJECT Button
Briefly pressing to select the bands; hold and press to eject or insert a disc.</p> <p>③ +/- Button
Press to increase or decrease number or angle by using SELECT button at the same time..</p> <p>④ SELECT Button</p> <p>⑤ MUTE/SETUP Button
Briefly press to cut down the sound output; during DVD mode, hold and press to exit the setting menu.</p> <p>⑥ [◀/▶]/[▲/▼]/ENTER
Briefly Pressing ENTER also performs the function of play; press and hold to enter the root menu.</p> <p>⑦ AMS Button
Press to activate AMS function.</p> | <p>⑧ LOC Button
Press to select distant or local station.</p> <p>⑨ WID Button
Press to select 16:9 or 4:3 wide screen.</p> <p>⑩ AUD Button
Press to select language or channel.</p> <p>⑪ EQ Button</p> <p>⑫ LOU Button</p> <p>⑬ RESET Button
Press to reset the unit.</p> <p>⑭ REMOTE Infrared Sensor</p> <p>⑮ Disc Loading Slot
Insert a disc directly when the TFT is slant-wise.</p> |
|---|---|

Remote Control

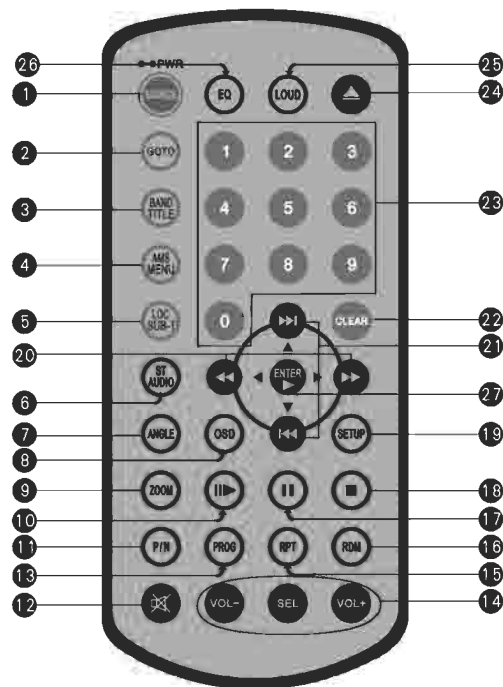

Tips:
For more information as to replacing battery, please refer to “Replacing the Battery” on page 6 .

Repeat Playing

During Mp3 playback , repeatedly press **15 RPT** to perform replaying function, the order is:

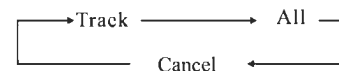

Note:

* This function is operated by using the remote control.

Playing Tracks at Random

During MP3 playback, pressing **16 RDM** button on the remote control to play any track at random under the directory which you select. Press it again to return to normal playing.

Note:

* This function is operated by using the remote control.

Number Buttons

Press one of **23 Number Buttons(0~9)** to select a track, press ENTER to playing, or the track will be played automatically after 5 seconds..

Note:

* This function is operated by using the remote control.

Stop Playing

During Mp3 playback, firstly Press **18 ■** button to stop playing, press **27** to replay.

Note:

* Pressing ENTER on the head unit also performs the same function.

Pause the Playback

During Mp3 playback, press **17 ||** to switch between play and stop.

Note:

* This function is operated by using the remote control.

Skip backward/forward/F.F /F.REW the playback

Press **20 (◀ or ▶)** on remote control to perform fast reward or fast forward.

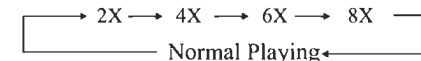

Note:

* Pressing ◀ and ▶ on the head unit perform the same function.

On Screen Display

During Mp3 playback, repeatedly press **8** OSD, the TFT will display as follow:

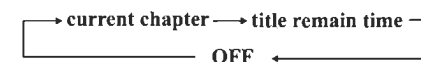

press and hold **8** OSD button to display the current status.

Note:

* This function is operated by using the remote control.

Playing a Mp3 Disc

Insert a Mp3 disc into the slot, the unit will automatically switch on, if a MP3 disc is loaded, press SRC to start the playback.

Note:

- * You can eject a MP3 disc by pressing **▲** on the base or **▲** on the remote control.

MP3 Menu Mode

- * Insert a MP3 disc, the TV screen will display the picture as following :

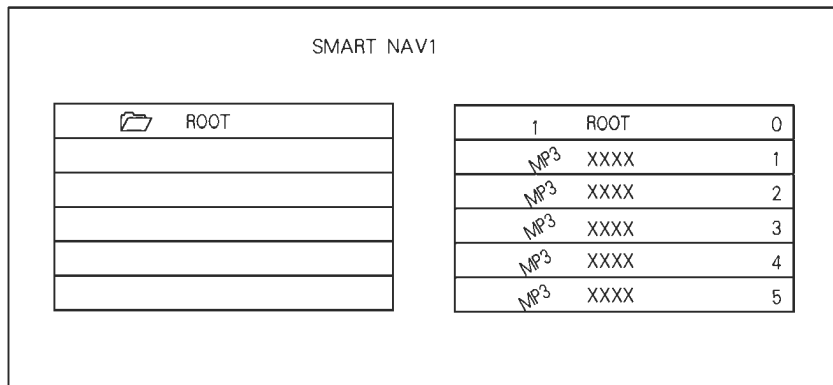

In this picture, the left menu is the sub-menu of the right one, pressing **Number Buttons** to select tracks; If you'd like to select tracks director or quickly, please press **18 [■]** firstly, then press **27 [◀][▶][▲][▼]**, and then press **27 [ENTER]** button to enter what you do.

Selecting Tracks Fast

During Mp3 playback, firstly press **27 ▲** to play the current track from start, press it within 3 seconds to play the backward track; Press **27 ▼** to play next track.

Note:

- * Pressing **▲** and **▼** button on the head unit also performs the same operation.

- 1 SOURCE/POWER
- 2 GOTO (playing time/track)
- 3 BAND/TITLE
- 4 AMS/MENU
- 5 LOC/SUB -T
- 6 ST/AUDIO
- 7 ANGLE
- 8 OSD
- 9 ZOOM
- 10 **II▶** (Slow Forward/Reward)
- 11 P/N
- 12 **⊗** Mute
- 13 PROG(Program playing)
- 14 VOL+/VOL-/SEL
- 15 RPT(Repeat Playing)
- 16 RDM (Playing Tracks at Random)
- 17 **II** (Pause/Play)
- 18 **■** (Stop Playing)
- 19 SETUP
- 20 **◀▶**(F.F/F.R)
- 21 **◀▶**(Previous/Next Track)
- 22 CLEAR
- 23 0~9 Number Buttons
- 24 **▲** (Eject Button)
- 25 LOUD
- 26 EQ
- 27 **◀/▶/▲/▼/ENTER** (Left/Right/Up/Down ENTER)

Specifications

General

Power Requirement	14.4V DC (11-16V allowable)
Load Impedance	4Ω
Max. Power Output	60W X 4
Tone Controls	±10dB Bass 100Hz Treble 10KHz
Dimensions	Approx. 253.1 x 178 x 99.3 mm (d/w/h)
Mounting Dimensions	Approx. 203.5 x 178 x 99.3 mm (d/w/h)
Weight	Approx. 3.05kg

FM Section

Tuning Range	87.5-107.9(MHz) (America)
IF Range	10.7MHz
Usable Sensitivity (-30dB)	10dBuV
Signal-to-noise Ratio	60dB
Stereo Separation	30dB (1KHz)
Frequency Response	40-12KHz

AM Tuner Section

Frequency Range	530-1710 (KHz) (America)
IF Range	450KHz
Usable Sensitivity (-20dB)	28dBuV

VCD/CD Player Section

VCD Signal System	AUTO/PAL/NTSC
Frequency Response	20Hz to 20KHz
Signal-to-noise Ratio	65dB
Separation	60dB(1KHz)
Distortion	0.3%

DVD Player Section

DVD Signal System	AUTO/PAL/NTSC
Number of channel	2 channels
Dynamic Range	60dB
Signal-to-Noise Ratio	73dB
Wow and Flutter	Less than measurable limit

Note:

Due to continuous product improvement, specifications and design are subject to change without prior notice.

--- Preferences page ---

PASSWORD Example showing how to set password :

(1. Press ▲ or ▼)

(2. Press ►, ▲ or ▼ and then press ENTER)

---PREFERENCES PAGE---

TV TYPE
AUDIO
SUBTITLE
DISC MENU
LOCALE
PARENTAL
PASSWORD
DEFAULTS

MAIN PAGE

---PREFERENCES PAGE---

TV TYPE
AUDIO
SUBTITLE
DISC MENU
LOCALE
PARENTAL
PASSWORD
DEFAULTS

CHANGE

CHANGE PASSWORD

* The default password is 8888.

DEFAULTS Example showing how to set defaults :

(1. Press ▲ or ▼)

(2. Press ►, ▲ or ▼ and then press ENTER)

---PREFERENCES PAGE---

TV TYPE
AUDIO
SUBTITLE
DISC MENU
LOCALE
PARENTAL
PASSWORD
DEFAULTS

MAIN PAGE

---PREFERENCES PAGE---

TV TYPE
AUDIO
SUBTITLE
DISC MENU
LOCALE
PARENTAL
PASSWORD
DEFAULTS

RESET

LOAD FACTORY SETTINGS

--- Preferences page ---

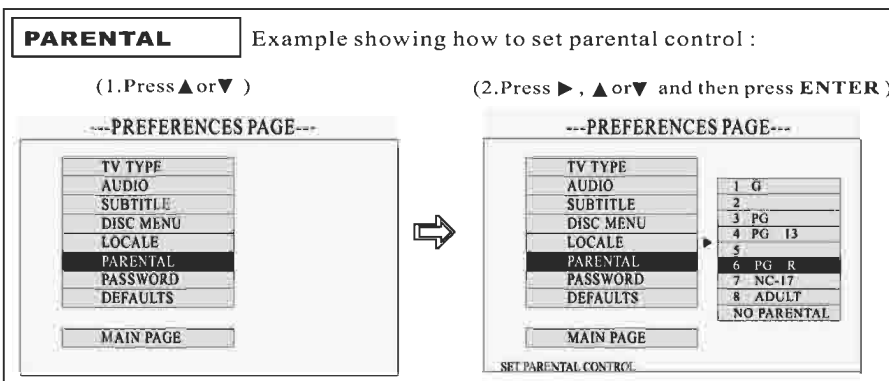
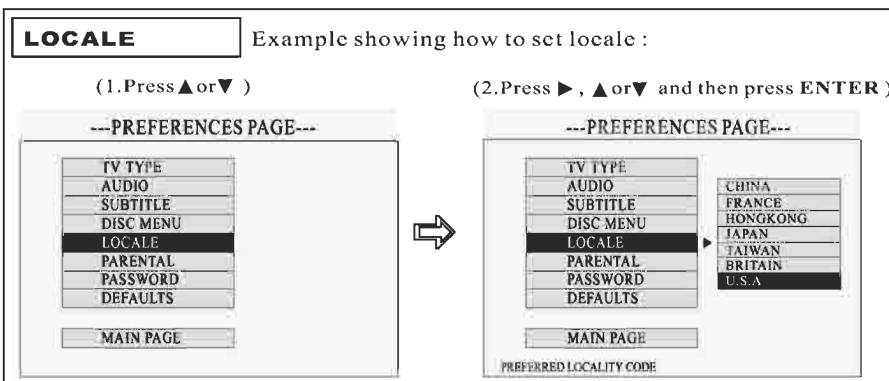
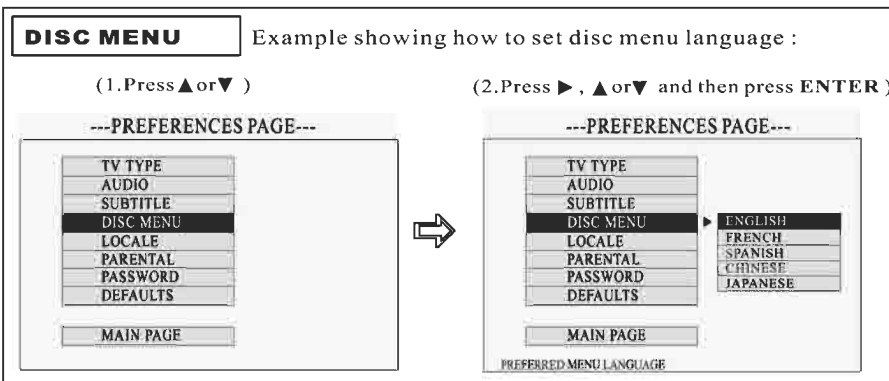

Wiring Connection

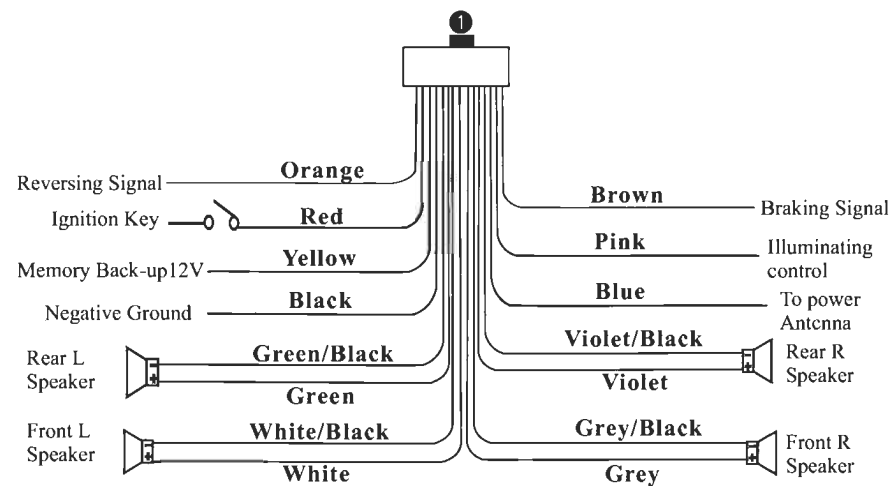
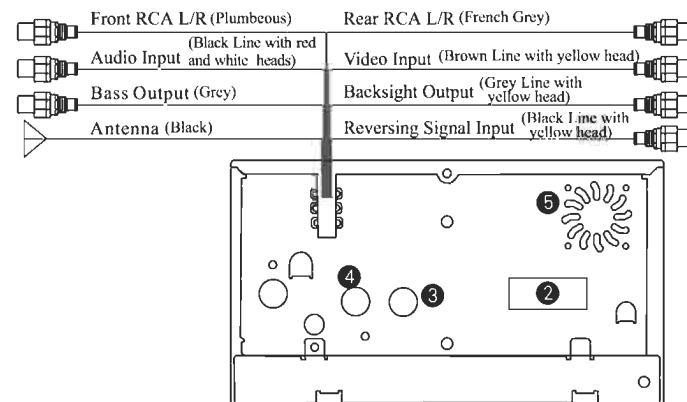

- ① Output Plug(Male)
- ② Output Socket(Female)
- ③ TV Receptor
- ④ Changer Receptor
- ⑤ Fan Window

Install the Unit

Installation Method

Installation using the screw holes at the sides of the unit.

Select a position where the screw holes of the mounting bracket supplied with the car and the screw holes of the main unit become aligned (are fitted), and tighten the screws (see at 2 places on each side). And then fasten them to the car.

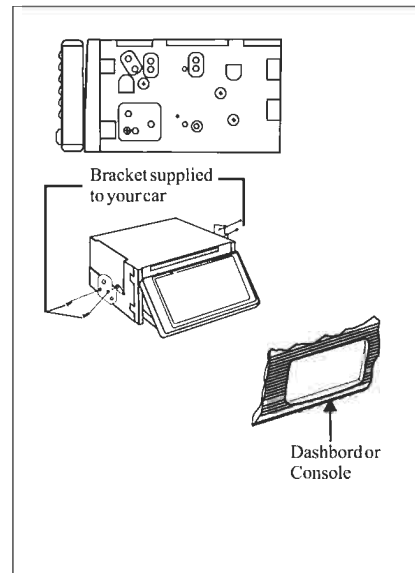

--- Preferences page ---

TV TYPE Example showing how to set Tv type :

(1. Press ▲ or ▼)

(2. Press ►, ▲ or ▼ and then press ENTER)

--- PREFERENCES PAGE ---

TV TYPE
AUDIO
SUBTITLE
DISC MENU
LOCALE
PARENTAL
PASSWORD
DEFAULTS
MAIN PAGE

→

--- PREFERENCES PAGE ---

TV TYPE	► MULTI SYSTEM
AUDIO	NTSC
SUBTITLE	PAL
DISC MENU	
LOCALE	
PARENTAL	
PASSWORD	
DEFAULTS	
MAIN PAGE	

PREFERENCES

AUDIO Example showing how to set audio language :

(1. Press ▲ or ▼)

(2. Press ►, ▲ or ▼ and then press ENTER)

--- PREFERENCES PAGE ---

TV TYPE
AUDIO
SUBTITLE
DISC MENU
LOCALE
PARENTAL
PASSWORD
DEFAULTS
MAIN PAGE

→

--- PREFERENCES PAGE ---

TV TYPE	► ENGLISH
AUDIO	FRENCH
SUBTITLE	SPANISH
DISC MENU	CHINESE
LOCALE	JAPANESE
PARENTAL	
PASSWORD	
DEFAULTS	
MAIN PAGE	

PREFERRED AUDIO LANGUAGE

SUBTITLE Example showing how to set subtitle :

(1. Press ▲ or ▼)

(2. Press ►, ▲ or ▼ and then press ENTER)

--- PREFERENCES PAGE ---

TV TYPE
AUDIO
SUBTITLE
DISC MENU
LOCALE
PARENTAL
PASSWORD
DEFAULTS
MAIN PAGE

→

--- PREFERENCES PAGE ---

TV TYPE	► ENGLISH
AUDIO	FRENCH
SUBTITLE	SPANISH
DISC MENU	CHINESE
LOCALE	JAPANESE
PARENTAL	OFF
PASSWORD	
DEFAULTS	
MAIN PAGE	

PREFERRED SUBTITLE LANGUAGE

---Audio Setup page---

COMPRESSION Example showing how to set dynamic range compression:

(1. Press ▲ or ▼)

(2. Press ►, ▲ or ▼ and then press ENTER)

Dynamic Range Compression

LPCM OUTPUT Example showing how to set LPCM output to 48k or 96k:

(1. Press ▲ or ▼)

(2. Press ►, ▲ or ▼ and then press ENTER)

SET LPCM OUTPUT TO 48K OR 96K

Reset the Unit

Operating the unit for the first time or after replacing the car battery, you must reset the unit.

Remove the front panel at first, and then Press (8) **RESET** button on the base with a pointed object, (such as a ballpoint pen) to set the unit to initial status.

Notes:

- * When some errors occur on the display, you can also press **RESET** button to resume to normal, and it will erase the clock setting and some memorized functions.
- * This function can only be operated by the head unit.

Turning the Unit On/Off

Press (1) **PWR** button to turn on the unit, hold and press it to turn off the unit.

Note:

- * Pressing PWR button on the head unit also performs the same operation.

Volume Control

Press (14) **VOL+** button to increase the sound level and press (14) **VOL-** button to decrease the sound level.

Note:

- * Pressing +/- button on the head unit also performs the same operation.

Changing Widescreen Mode

Press (9) **WID** button to select the widescreen mode: 16:9 or 4:3.

Note:

- * This function can only be operated by the head unit.

Setting the Sound Characteristics

Repeatedly press (14) **SEL** button to select the desired mode in the following order:



After selecting the desired mode, you can adjust the current level by pressing (14) **VOL** buttons.

Notes:

- * Pressing +/- button on the head unit also performs the same operation.
- * The function of **SEL/VOL+/VOL-** on remote control is the same as the corresponding button on the head unit, respectively.

EQ Setting

While listening to the popular music, classic music or rock music, you can select the corresponding preset modes to adjust the sound quality perfectly by using (26) **EQ** button.

Repeatedly pressing (26) **EQ** button to choose the following modes in turn:

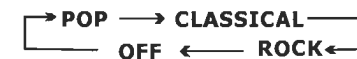

The default setting is OFF.

Note:

- * Pressing EQ button on the head unit also performs the same operation.

Turning Loudness On/Off /My Best Position(MBP)

Briefly press **LOUD** button activate loud function. You can press this button to increase the low frequency, which can improve sensitivity for your ears. Press it again to quit this function.

Note:

- * Pressing LOU or Main Menu Setup on the head unit also performs the same operation.

Eject a Disc

Press and hold **EJ** button, eject or insert a disc when the TFT slanted. Press it again, the TFT will return to the initial status.

Note:

- * Pressing **▲** on the remote control performs the same function.

Angle Setting

Hold and press **SEL** button until the **ANGLE** appears on LCD, Press **+** to adjust monitor backward by definite angle, press **-** to adjust it forward.

Notes:

- * when adjusting the monitor angle, please press this button, or the monitor would be broken.
- * Pressing **(VOL+/VOL-/SEL)** on remote control also perform the same function.

Mute Function

Press **MUTE** button to shut off the sound output. And “**ⓧ**” appears on the LCD. Press it again to resume to previous volume level.

Note:

- * Pressing MUTE on the head unit also performs the same operation.

Clear

If input some wrong selection, press **CL-EAR** button to clear it.

Note:

- * This function is only valid on remote control.
- * This function is valid in radio status and playback mode.

Mode Selector

Press **SOURCE** button to select radio mode or playback mode.

Note:

- * Pressing SOURCE on the head unit also performs the same operation.

Infrared Sensor:

Receptor **⑥** on the head unit for the card remote commander.

---Audio Setup page---

AUDIO OUT Example showing how to set audio output:

(1. Press **▲** or **▼**)

---AUDIO SETUP---

AUDIO OUT
OP MODE
DUAL MONO
COMPRESSION
LPCM OUTPUT

MAIN PAGE

Audio Related

(2. Press **▶**, **▲** or **▼** and then press **ENTER**)

---AUDIO SETUP---

AUDIO OUT	▶ ANALOG
OP MODE	SPDIF/RAW
DUAL MONO	SPDIF/PCM
COMPRESSION	
LPCM OUTPUT	

MAIN PAGE

AUDIO RELATED

OP MODE Example showing how to set operational mode:

(1. Press **▲** or **▼**)

---AUDIO SETUP---

AUDIO OUT
OP MODE
DUAL MONO
COMPRESSION
LPCM OUTPUT

MAIN PAGE

Operational mode Setup

(2. Press **▶**, **▲** or **▼** and then press **ENTER**)

---AUDIO SETUP---

AUDIO OUT	▶ LINE OUT
OP MODE	RF REMOD
DUAL MONO	
COMPRESSION	
LPCM OUTPUT	

MAIN PAGE

OPERATIONAL MODE SETUP

DUAL MONO Example showing how to set stereo mode:

(1. Press **▲** or **▼**)

---AUDIO SETUP---

AUDIO OUT
OP MODE
DUAL MONO
COMPRESSION
LPCM OUTPUT

MAIN PAGE

DUAL MONO (1-1) SETUP

(2. Press **▶**, **▲** or **▼** and then press **ENTER**)

---AUDIO SETUP---

AUDIO OUT	▶ STEREO
OP MODE	L-MONO
DUAL MONO	R-MONO
COMPRESSION	MIX-MONO
LPCM OUTPUT	

MAIN PAGE

DUAL MONO (1-1) SETUP

---General page---

Captions Example showing how to set closed caption on/off:

(1. Press ▲ or ▼) (2. Press ►, ▲ or ▼ and then press ENTER)

---GENERAL PAGE---

TV DISPLAY
PIC MODE
ANGLE MARK
CAPTIONS
SCREEN SAVER

MAIN PAGE

Closed caption

---GENERAL PAGE---

TV DISPLAY
PIC MODE
ANGLE MARK
CAPTIONS ► ON
SCREEN SAVER OFF

MAIN PAGE

CLOSED CAPTION

SCR Saver Example showing how to set screen saver on/off:

(1. Press ▲ or ▼) (2. Press ►, ▲ or ▼ and then press ENTER)

---GENERAL PAGE---

TV DISPLAY
PIC MODE
ANGLE MARK
CAPTIONS
SCREEN SAVER

MAIN PAGE

Screen Saver

---GENERAL PAGE---

TV DISPLAY
PIC MODE
ANGLE MARK
CAPTIONS
SCREEN SAVER ► ON
SCREEN SAVER OFF

MAIN PAGE

SCREEN SAVER SETUP

Set up Main Menu

Press and hold **SETUP** on the remote control or **ENTER** on the head unit, the setting picture appears as follow:

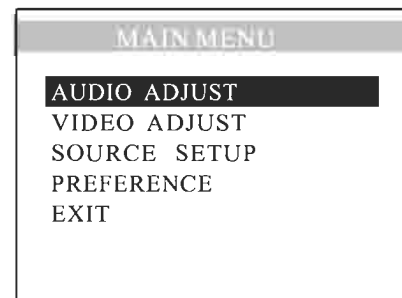

The main menu includes 5 selections above, press ▲ or ▼ button to select the requisite item, then hit **ENTER** to set it; press ▲ or ▼ button to reach **EXIT**, press **ENTER** to exit setting.

▣ **Note:**

* Press and hold **SETUP** or press **MENU** on the head unit to set up this menu; during setting also can press [▲][▼][►][◀]/**ENTER** button on the remote control or the head unit.

1.Audio Adjust

After Selecting **AUDIO ADJUST**, press **ENTER** to enter the setting system:

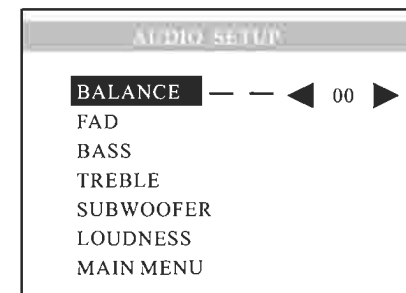

You can adjust **BALANCE**, **FAD**, **BASS**, **TREBLE**, **SUBWOOFER**, **LOUDNESS**. For example, press [▲][▼] to select **FAD**, and then press **ENTER**, the setting menu will appear as follow:

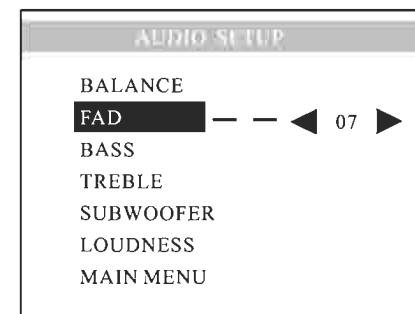

Press [►] to remove the cursor to ◀ 07 ▶ press [▲][▼] to increase or decrease the size, and then press **ENTER**.

▣ **Note:**

* Adjusting the other items perform the same operation.

2.Video Adjust

Selecting VIDEO ADJUST in main menu, press ENTER to enter setting system.

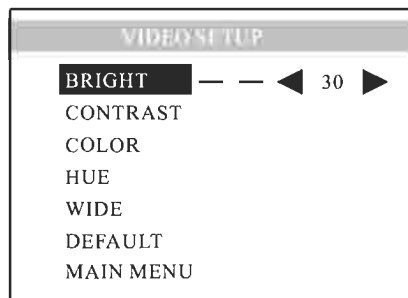
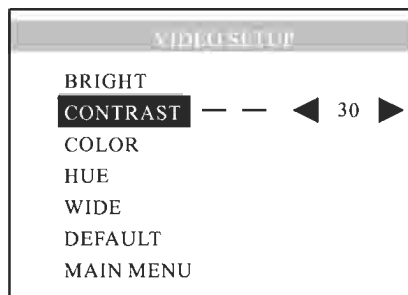

Image Adjust

Adjusting the CONTRAST : press [▲] or [▼] to select CONTRAST, then press ENTER, the setting menu appears as follow:



Press [▶] to remove the cursor to ◀ 30 ▶, press [▲] or [▼] to increase or decrease the contrast, and then press ENTER.

Adjusting the other items perform the same operation.

Note:

- * During DVD status, the signal is RGB; COLOR and HUE are the best status, no change.

Default

There are 4 items to adjust image directly: **VIVID,STANDARD,SOFT,USER**. The DEFAULT setting is **STANDARD** when adjusting BRIGHT, CONTRAST,COLOR, HUE. Press [▲][▼][▶][◀] to select, and then press ENTER.

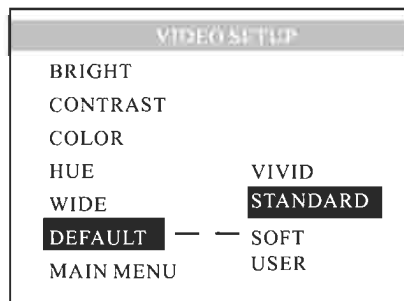
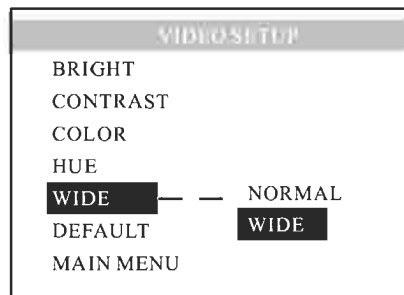

Image Format Selection

Selecting WIDE in VIDEO ADJUST. Show as:



Press [▶] to remove the cursor to NORMAL, and press ENTER, the image size is 4:3, remove the cursor to WIDE and press ENTER, the size is 16:9.

---General page---

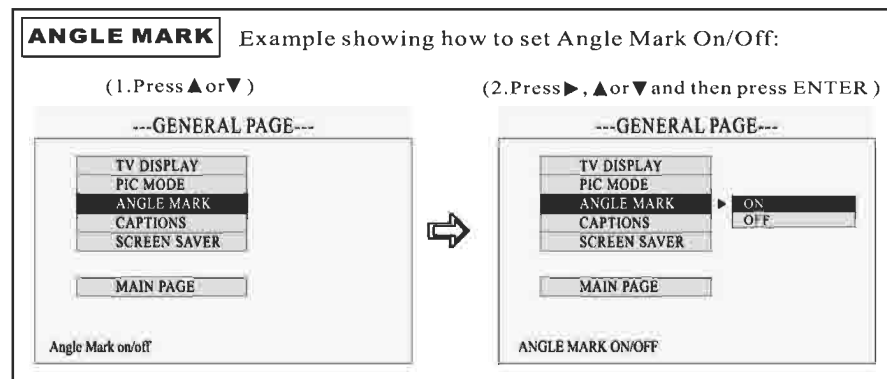
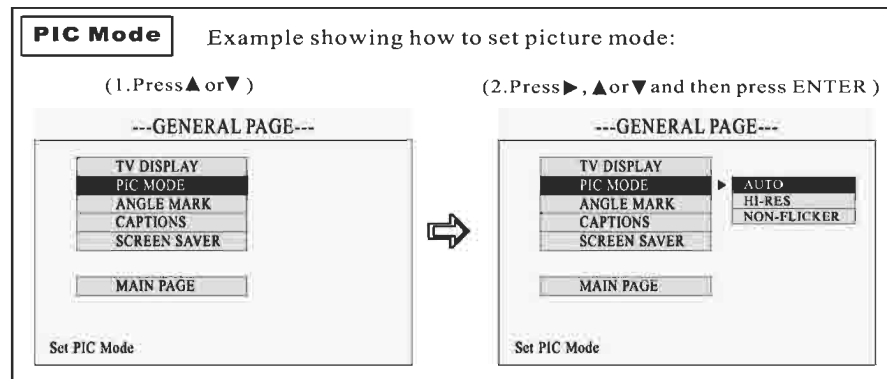
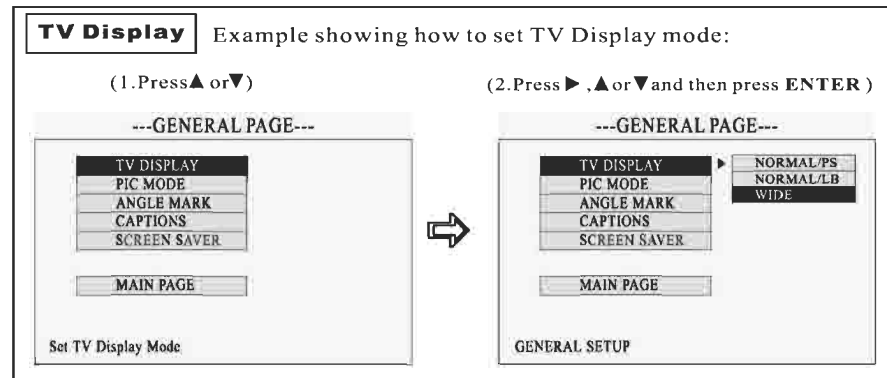

Setup Audio page

(Briefly press **SETUP**, the screen will display system setting picture as follows:)

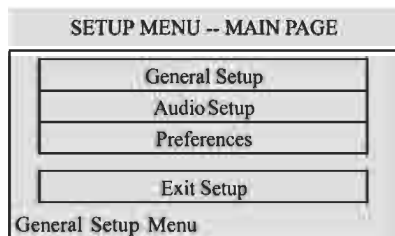

(Press **▲** or **▼**, and then press **ENTER**)

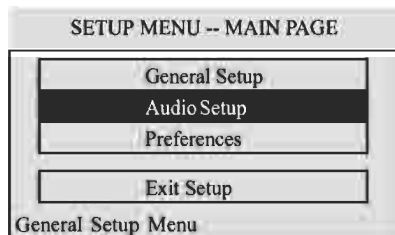

Audio Setup Menu appears

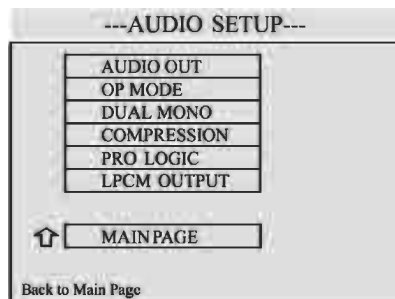

Setup Preferences page

(Firstly press **STOP**, and then briefly press **setup**, the screen will display system setting picture as follows:)

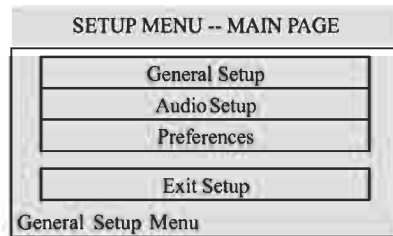

(Press **▲** or **▼**, and then press **ENTER**)

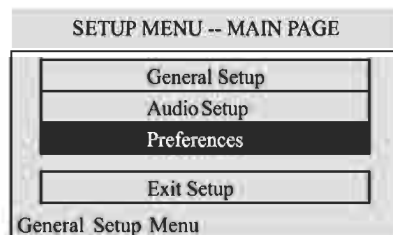

Preferences Menu appears

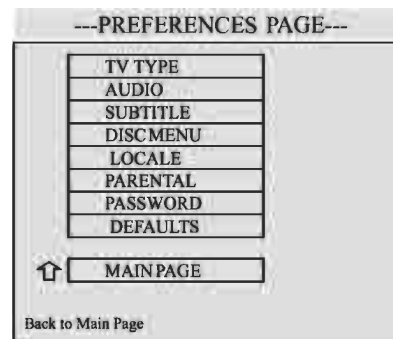

3.Source Setup

Selecting **SOURCE SETUP** in main menu, press **ENTER** to enter setting system.

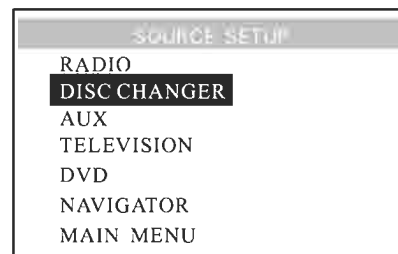

This menu can set up the above items by pressing **[▶]** and **[▼]** and **ENTER**. If you set one of them **OFF**, the function is invalid. During playback mode, you can not set it **OFF**.

Turn On/Off Radio Setting

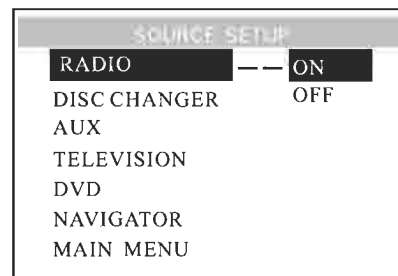

Turning on or off the radio can be set in this menu, the default setting is **ON**.

DISC CHANGER Setup

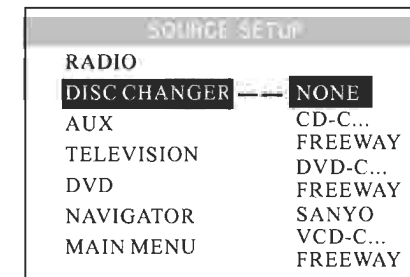

When under **NONE** default mode, the disc changer can not be played. Select the corresponding type before playing disc changer, when playing **CD CHANGER**, please select **CD-C**; when playing **DVD CHANGER**, please select **DVD-C**; when playing **VCD CHANGER**, select **VCD-C**. Press **[▶]** firstly, then press **[▼]** to set, press **ENTER** to confirm.

Auxiliary Setup

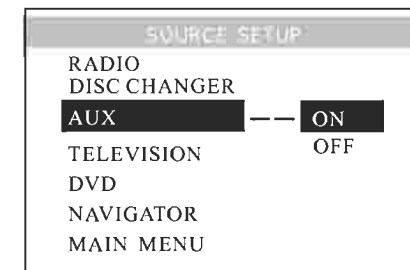

Setting the **AUX** on or off in this menu, the default is **ON**. If the **AUX** function is off, you can set it **OFF**. Press **[▶]** firstly, then press **[▼]**, press **ENTER** lastly.

TELEVISION ON/OFF

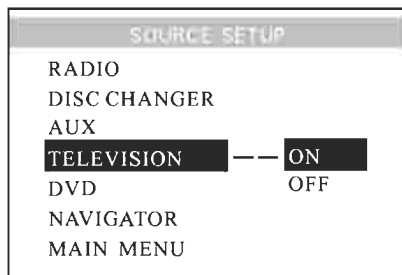

To set Television ON/OFF in this menu, the default setting is ON.

DVD ON/OFF

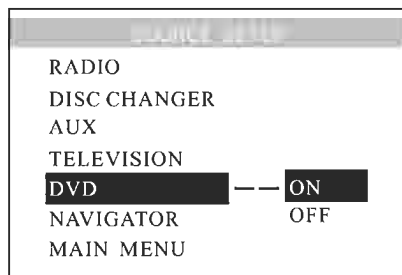

To set DVD ON/OFF in this menu, the default setting is ON.

5.PREFERENCE SETUP

Select PREFERENCE, then press ENTER.

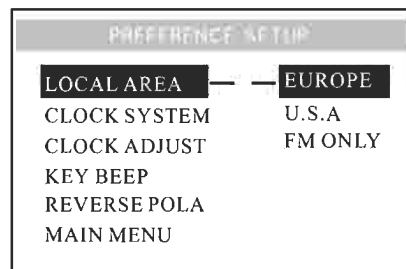

To set the above items by pressing [▶] and [▼] and ENTER.

LOCAL AREA SETUP

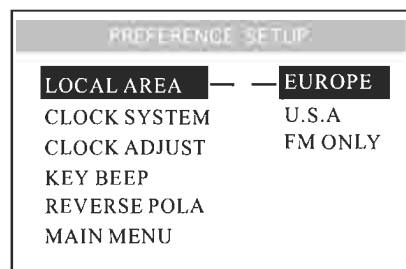

To set LOCAL AREA in this menu, the default setting is EUROPE.

Selecting MENU

- 1 Selecting Menu: During DVD status, press **4** MENU to return to the root menu, all of the chapters will appear on monitor. You can press **27** or **23** button to select your desired chapter.
- 2 Selecting Title: During DVD status, press **3** TITLE to return the title menu, all of the titles will appear on monitor. You also can press **27** or **23** button to select your desired chapter.

■ Note:

- * Pressing **6** button on the head unit also performs the same operation.

SET UP GENERAL MENU

Briefly press **19** SET UP on remote control or press and hold **5** SET on the head unit, main menu and sub-menu will appear on TFT, pressing **27** [▲] [▼] [▶] [◀] on remote control or **6** [▲] [▼] [▶] [◀] on head unit to select your desired items, then press **27** ENTER on remote control or **6** ENTER on head unit to confirm.

■ Notes:

- * The selections are the preferred options that will be chosen if they are available on a disc. If the disc that is inserted does not have the preferred option then the disc's own preference will be used.
- * Regarding **SETUP MENU**, please refer to the following pages for more details.
- * Some functions vary depending on the types of models or formats of the disc.

Setup General page

(Briefly press SETUP, the screen will display system setting picture as follows:)

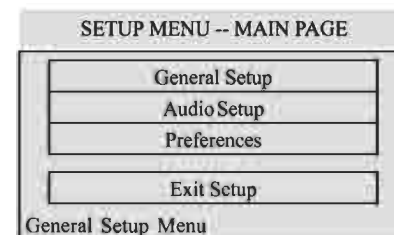

(Press ▲ or ▼, and then press ENTER)

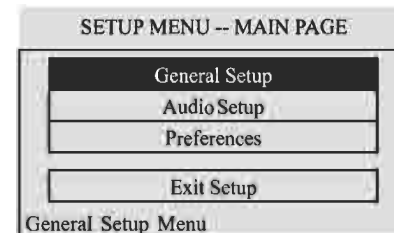

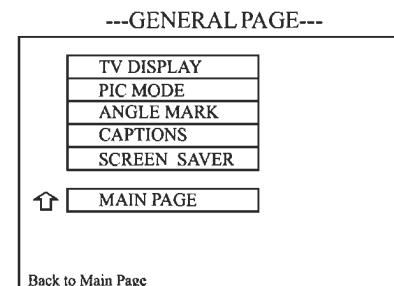

General Setup Menu appears









Playing a DVD

Insert a DVD disc into the slot , the unit will automatically switch on, if a DVD disc is loaded, press **SRC** on the remote control to start the playback.



Note:

- * You can eject a DVD by pressing  button on the base or  on the remote control.

Selecting Tracks Fast

During DVD playback, press   to play the backward track, firstly press   to replay the previous track. Press   again within 3 seconds to play next track.

Note:

- * Pressing  and  button on the head unit also performs the same operation.

Repeat Playing

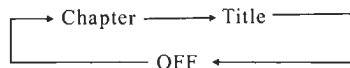

During DVD playback, press  **RPT** on the remote control to perform replaying function when you need to repeat the track you like. The order is:



Note:

- * This function is only valid on remote control.

Stop the playback

During DVD playback, firstly press  to stop playing, then press  on the remote control to replay.

Note:

- * Pressing **ENTER** button on the head unit also performs the same operation.



Pause the Playback

During DVD playback, press  **||** to switch between play and pause; During stop mode, press this button to resume playback mode.

Note:



- * The function is only valid on remote control.

Skip backward/forward/F.F /F.REW the playback

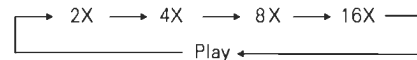
Press  or  on remote control to perform fast reward or fast forward. Each pressing will change as follow:



Note:

- * Pressing  and  button on the head unit also perform the same operation.

System Switch

During playback mode, Press  **P/N** on remote control to set the TV standard to PAL or NTSC or AUTO system.

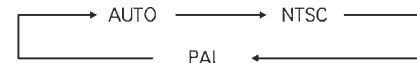

Note:

- * The function is only valid on remote control.

Slow motion playback

During DVD mode, press  **|||** to slow forward or slow backward. The following is:

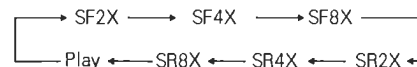

Note:

- * The function is only valid on remote control.

Increase the size of the picture

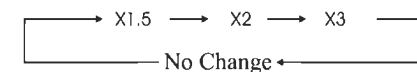

During DVD mode, Press  **ZOOM** to increase the picture in size. There are 3 sizes, Each pressing increases the size until the maximum size is reached.



Note:

- * The function is only valid on remote control.

On Screen Display

During DVD status, repeatedly press  **OSD** button on the card remote control, the display shows "*current chapter, title/ title remain time/chapter elapsed time/chapter remain time*". Hold and press  to display the current set-up.

Note:

- * The function is only valid on remote control.

Free Manuals Download Website

<http://myh66.com>

<http://usermanuals.us>

<http://www.somanuals.com>

<http://www.4manuals.cc>

<http://www.manual-lib.com>

<http://www.404manual.com>

<http://www.luxmanual.com>

<http://aubethermostatmanual.com>

Golf course search by state

<http://golfingnear.com>

Email search by domain

<http://emailbydomain.com>

Auto manuals search

<http://auto.somanuals.com>

TV manuals search

<http://tv.somanuals.com>