

PYLE[®]

PLDTF5M

OWNER'S MANUAL

Mobile Audio System

www.pyleaudio.com

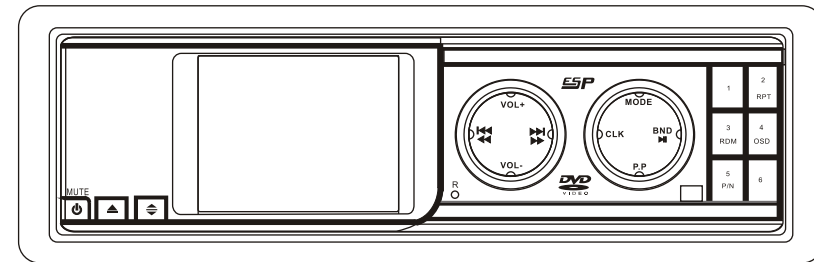

- **PLL Synthesizer Stereo Radio**
- **Digital Compact Disc Player**
- **Automatically Memory storing**
- **Hiding Panel**
- **Preset Equalization**
- **Auxiliary Input Funxtion**
- **Remote Control**

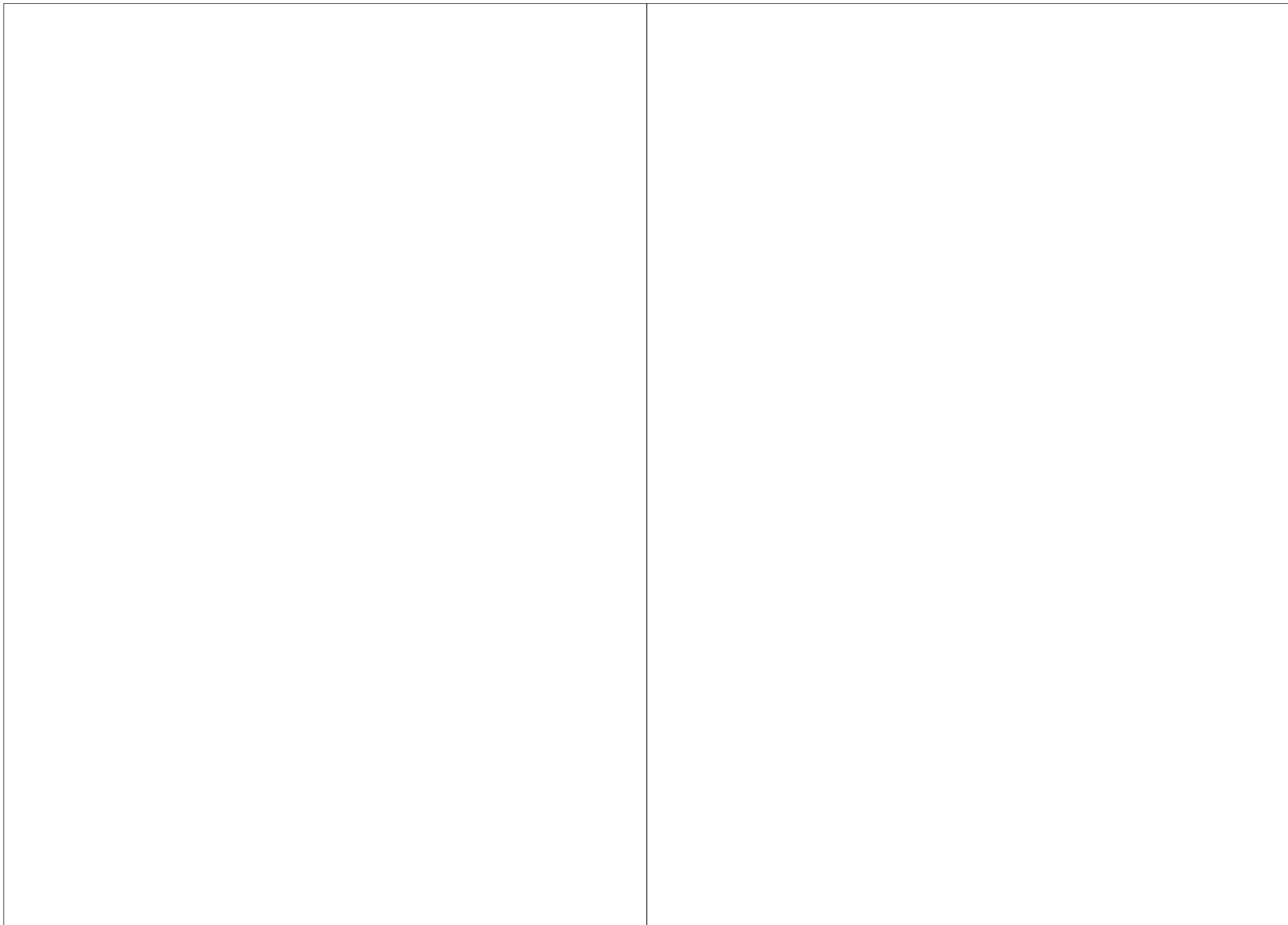

Characteristics And Specifications

CHARACTERISTICS

FM

Frequency range	: 87.5-108.0MHz
Intermediate frequency	: 10.7MHz
Practicality neat (S/N 30dB)	: less than 22dB
Stereo separation	: more than 25dB

AM

Frequency range	: 522-1620KHz
Intermediate frequency	: 450KHz
Practicality neat (S/N 20dB)	: less than 48dB

SPECIFICATIONS

Power	: DC12-13.8V, -earth
Dimensions	: 178(L)X160(W)X50(H)MM

NOTICE: The specification and design of this product are subject to changes without prior notice.

Contents

Safety Precaution.....	2
User Guide.....	3
Function Characteristic	4
Disc Handling And Maintenance	5
Playable Disc	6
Wiring Connection.....	7
Panel's Diagram	8
Remote Control's Diagram.....	9
The Panel Button's Function Instructions	10~11
Basic Operations	12~16
MP3 Functions.....	17
DVD Video Control.....	18
DVD-VR Control.....	19
VCD Control.....	20
Advanced Operations.....	21-23
Troubleshooting.....	24-25
Installation.....	26
Anti-Theft System	27
Characteristics And Specifications.....	28

Safety Precaution



Caution:

The lightning flash with an arrowhead symbol, within an equilateral triangle, is intended to alert the user to "dangerous voltage" and to prevent from a risk of electronic shock.



Warning:

To reduce the risk of electric shock, don't open the cabinet. Refer servicing to qualified personnel only.



The exclamation point within an equilateral triangle is intended to alert the user to important operating and maintenance (servicing).

WARNING: Do not use this DVD player where contact with or immersion in water is possible. Not for use in Marine Apps.

WARNING: Do not use in high temperature areas, there is the danger of fire.

WARNING: The unit should be connected only to a power supply of the type described in the operating instructions or as marked on the unit. If you are not sure of the type of power supply have a qualified dealer install this unit.

WARNING: Do not open the cabinet or touch any parts in the inner mechanism. Consult your local dealer for technical service if the opening is required.

NOTE: To ensure proper use of this product, please read this Instruction Manual carefully and retain for further reference.

Anti-Theft System

This unit is equipped with a detachable panel. Panel can be detached and taken with you, helping to deter theft.

Removing the Panel

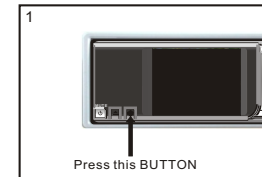

1. Press " " button front panel slide to the angle of 15 degrees.

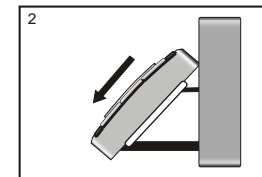

2. Press again to resume to original mode. When the front panel slides to the angle of 15 degrees, the front panel can be taken out by hand, after that, the slide panel bracket is automatically back to original position and the unit is switched off.

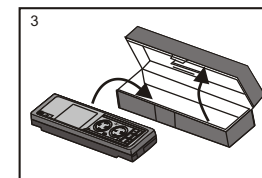

3. Place the panel into the case and take it with you when you leave the car.

Installation the Panel

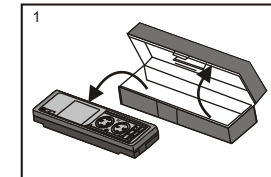

1. Take out the front panel from the case.

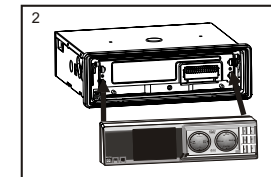

2. Install the front panel back to the bracket. Notice: First the one side of the front panel to the bracket, then press another side, when you heard a sound, it means that it is installed correctly.

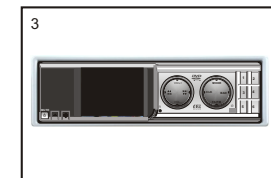

3. When the panel is installed into the unit, press the POWER button to turn on.

Installation

CAUTION:

1. Always use an experienced installation technician.
2. The location of the player must not obstruct the driver.
3. Do not install the player in excessive dusty, shakable, high-temperature or humid condition.

Note : these conditions will adversely affect the player's operation.

4. Follow the player connecting diagram, using the appendixes provided with the unit.

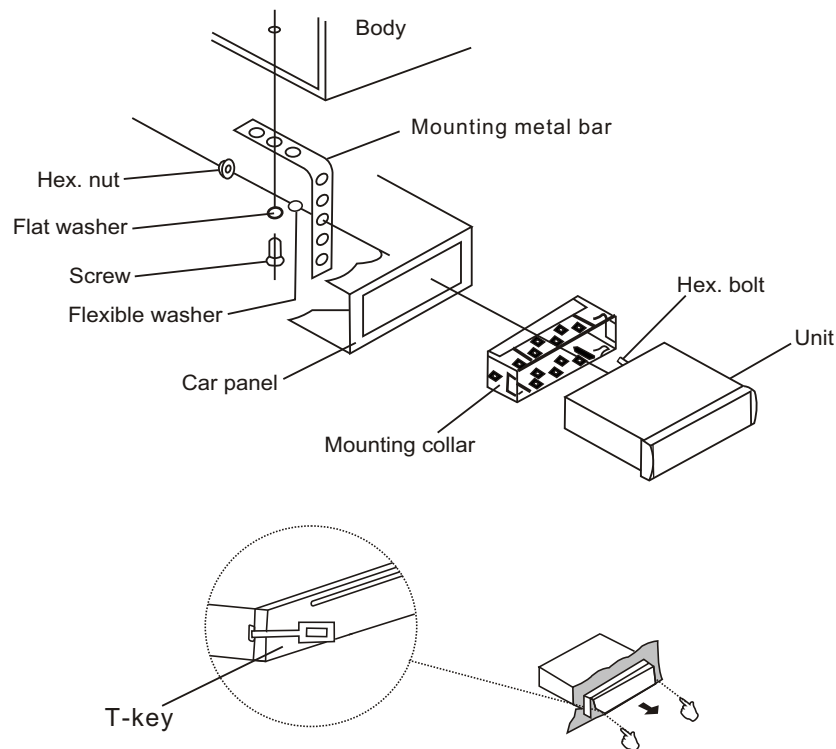

Follow the arrowhead direction to take out the unit with T-key.

User Guide

1. Before operating this product, please read this instruction manual and the attached information carefully.
2. This product is used at the 12-13.8 V D.C. Ground. In the condition of the negative ground connect with the metal body of car, it is safe to operate.
3. Do not use the fuse whose rating amperage is over that of the appendix's.
4. Do not use the loudspeaker whose resistance is lower than 4Ω in order not to damage the unit.
5. To ensure the product is in normal operation, it must be far away from water, dust and magnetic reflection region.
6. When playing discs, be sure the symbol side must be upward, otherwise it cannot play properly.
7. During high speed operation, if the disc has serious scratches and breaks or rough surface, the life of the optical laser head may be shorten. Please pay attention to the following points:
 - 1) Do not use discs with poor quality;
 - 2) Store and use the DVD discs carefully;
 - 3) Do not write on the discs with an ink-pen or other writing materials, nor Mark on them;
 - 4) When playing DVD disc, do not take it out randomly;
 - 5) When a disc is inserted into this products, do not try to insert another Disc into this product;
 - 6) When taking out the playing disc, do not touch the recording surface of the disc;
 - 7) Do not expose the disc under direct sunlight or high temperature.
8. When wiping discs, please move the cloth from the center hole towards the outer edge. Attention: do not use chemical solution or common cleanser.
9. Fix the unit in the steady parts. If you have parked your car in hot or cold situations, wait until the temperature in the car becomes normal before operating the unit.
10. The electronic antenna of your car fixed will rise automatically when you operate it, if it has.
11. In rainy day or wet area, dew may be coated on the laser lens of this product, which cannot work properly, if this happens. In this case, please take out the disc and keep this product stop working for one hour until the steam vapored, then this unit can resume to normal operation.
12. If this product is out of order, please shut off the power sources immediately and contact with authorized repairman in time. Do not disassemble it by yourself.

Function Characteristic

DVD Player Features

1. Fully Compatible

Fully compatible with most of the discs on the market.

Please refer to the list on page 5 for details.

2. Intelligent Disc Upgrade

Support the intelligent disc upgrade function to keep up with the market competition.

3. Single Chip

Integrate the servo and MPEG2 chips to enhance the stability and achieve the high-performance level.

4. Unique HDCD Function Support

Support HDCD function. HDCD, the abbreviation of High Definition Compatible digital, which is a recording/playing technology that improves the CD audio quality. It is able to restore 20 Bits audio data truly to enhance the quality and quantity of the digital audio in the highest level. At the same time, it is also compliant with the ordinary audio data of the CDDA format.

5. Support Picture CD and Photo CD

The unit is compatible with the Picture-CD and Photo CD player, without requiring other support from additional software. It will activate the media player menu to process automatically. (In other words, playing automatically.)

6. Support DVD Audio

The unit is fully compatible with the high-quality audio DVD Audio discs, without requiring the support from additional software. It will enable the end-users to enjoy an excellent audio effect.

7. Support DVD-R

The unit is compatible with the DVD-VR discs recorded by the DVD player equipped with the recording function.

8. Car back video input function

This unit includes car back video input function. (When car back camera connects this player), during the operation of car backing, this player changes from play mode to car back video input mode automatically. Then the screen shows you back view, it protects you more safety.

Troubleshooting

<i>Problem</i>	<i>Action</i>
Operations	
<i>Remote Control does not work properly.</i>	<ul style="list-style-type: none"> ▶ Remove the obstacle between DVD player and Remote Control. ▶ The operating distance of Remote Control is too far from the sensor of DVD video player. Operate it within the valid distance.
<i>Remote Control does not work properly.</i>	<ul style="list-style-type: none"> ▶ Point the Remote Control at the sensor of the DVD video player. ▶ If the batteries in Remote Control are exhausted, please replace them with new ones.
<i>Fails to play disc</i>	<ul style="list-style-type: none"> ▶ No disc is inserted. (No disc symbol appears on screen) Please insert the disc to play. ▶ The disc is placed upside down. Turn it over, place it correctly (disc label upward). ▶ The disc is dirty. Please clean it. ▶ There may be humidity inside the unit. Please turn on the power and for 30 minutes in no disc running mode.
<i>The player fails to play from the beginning.</i>	<ul style="list-style-type: none"> ▶ Because the playing mode is in Program/Random / Repeat mode, press these relative function buttons again to return to playing mode. (Please refer to the Advanced operations part.) ▶ While the DVD Title/Chapter or DVD Setup menu is displaying on monitor, or while playing VCD with PBC function, the Installation menu will be displayed on monitor.
<i>Stop playing automatically</i>	<ul style="list-style-type: none"> ▶ Some discs have memorized the pause command automatically in the original record. So the unit will stop playing automatically at this memorized command part.
<i>Dying</i>	<ul style="list-style-type: none"> ▶ It is a normal phenomenon that the unit dying occasionally during operation. Press RESET button to restart the unit.

Troubleshooting

What appears to be trouble is not always serious, when you meet following problems in using, please check the following points before calling a service.

Problem	Action
POWER	
<i>The power supply has disconnected.</i>	▶ Please check whether the DC power has been connected correctly.
PICTURE	
NO PICTURE	▶ Please check whether the disc has been inserted correctly. ▶ Please check whether the disc format.
<i>Picture Distortion</i>	▶ The disc is too dirty and needs cleaning.
SOUND	
NO SOUND	▶ If the unit is playing in Fast-forward or Pause mode, press <i>Play</i> to return to normal playing mode. ▶ If the unit is playing in fast-backward mode, press <i>Play</i> to return to normal speed playing mode. ▶ When the unit is in System Setting Menu/ Program Menu, press <i>System Setting /PRG Play</i> button to exit this mode. Or press <i>Play</i> to return to normal playing mode. ▶ If the unit is in Mute mode, please press <i>Mute</i> again to ensure the normal sound playing. ▶ If the sound track 2 of S-VCD has not been recorded, there will be no sound output when the track 2 is selected. Open the Control Menu, and select track 1 in the audio caption to play.
<i>Noise</i>	▶ The disc is dirty and needs cleaning. ▶ If the CD playing is DTS standard format, the noise can't come from Digital output option or interphase.
<i>No Stereo Effect</i>	▶ Check whether the digital output is turned on. ▶ Press <i>Stereo</i> to select stereo output.

Disc Handling And Maintenance

Disc Using

- 1 To keep the disc clean, please hold the disc edge only, do not touch its surface.
- 2 Do not stick the label or adhere things on the disc.

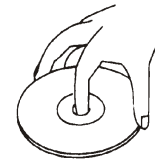

Correct



Incorrect

- 3 Do not expose the disc into direct sunshine or near the hot sources.
- 4 After playing, please store it into the disc box.

Disc Cleaning





- 1 Before playing, wipe the disc with a clean cloth, from the centre hole towards the outer edge.



- 2 Never use alcohol, thinner, cleaning fluid, static electricity prevention liquids or any other solvent to clean discs.

Playable Disc

This unit can play DVD, S-VCD, VCD, CD, MP3 etc. format discs.

Disc types	Disc symbols	Recorded Contents	Disc Sizes	Playing time
DVD		Audio+Video (Motion Picture)	12cm	About 2 hours (single side disc) About 4 hours (double sides disc)
S-VCD	SVCD	Audio+Video (Motion Picture)	12cm	About 45 minutes
VCD		Audio+Video (Motion Picture)	12cm	About 74 minutes
CD		Audio	12cm	About 74 minutes
MP3		Audio	12cm	About 600 minutes

NOTICE:

Some DVD, S-VCD, VCD discs playing operation may be limited by the software designer's special regulation, please refer to the instruction manual of disc. This unit can play recorded discs (CD-R, CD-RW) too, but it depends on the quality and recorded situation, some kinds of discs cannot play in this unit.

PAY ATTENTION :

This player cannot playback diameter 8cm disc. To avoid damage of it, please do not insert and play the above mentioned disc by this player.

Advanced Operations

- If the new password is entered successfully, press *Up/Down* to change the parental control rating level.
This Rating setting includes 9 levels, details please refer to the *Parental Control* section.
- 3. The parental control function is only valid after the parental lock setting is performed the disc eject operation.
- 4. The *Password* item is used to set the new password or change the old one. Before you enter this option, the system will request you to input the old password first. The new password will be accepted only when the old one is input correctly. (This unit's omnipotence code is 3351.)

Other Settings

It can resume all settings to the default value.

Advanced Operations

adjustment has 2 options for your setting: 4:3 and 16:9. This option is used to display image due to the panavision on the normal TV set. The option will display in 16:9 Full-screen mode, when the DVD player is connected with the TV and open the Full-screen mode.

- The *Display Mode* item can be modified only when the *TV Display* mode is set to 4:3. Two options are provided: *Mailbox* and *Plane-scan*.
 - Mailbox:** This option will display the panoramic movie in a smaller portion of the screen. And the movie might appear with black bars both at the top and the bottom of the screen now.
 - Pan-scan:** This option refers to pictures where the left and right edges of the picture are cut off to fit the whole screen size. It is the default display mode of normal TV set.

This mode will be selected when the picture is displayed in panoramic view and complete scan format.

AUDIO Setup

- You can operate as following:
 - Press *Up/Down* to move among different options.
 - Press *Left/Right* to change the options.
 - Press *ENTER* to go back to the Audio Setup page.
- The *Dynamic Range Compression*

(*DRC*) It is divided into 2 options: ON and OFF. When the option is set up ON, the dynamic range will compress by reducing treble and increasing soft sounds, making a clear volume even at a low level.

- The 2.0 multichannel surrounding stereo audio output is set up via the *2.0 Speaker Setup*. This option is used to set on the speaker volume and position adjustment. You can enjoy the best sound quality if the distance between you and each speaker is equal. After you press certain option and enter, you will see the speaker setup page.

LOCK Setup

- You will enter the *Lock Setup* page, which is used to set the *Parental Control*.
- The *Rating option* is used to set the rate.
 - Before you enter this *Rating option*, the system will request you to input the password first. If the password entered is correct, you can change the parental control rating level.
 - If you haven't set any password for Parental Control, the system will request you to input a new password.
 - If you make a mistake on password and haven't pressed *ENTER* to confirm, you can press *DELETE* button and enter your 4 digital password again.

Wiring Connection

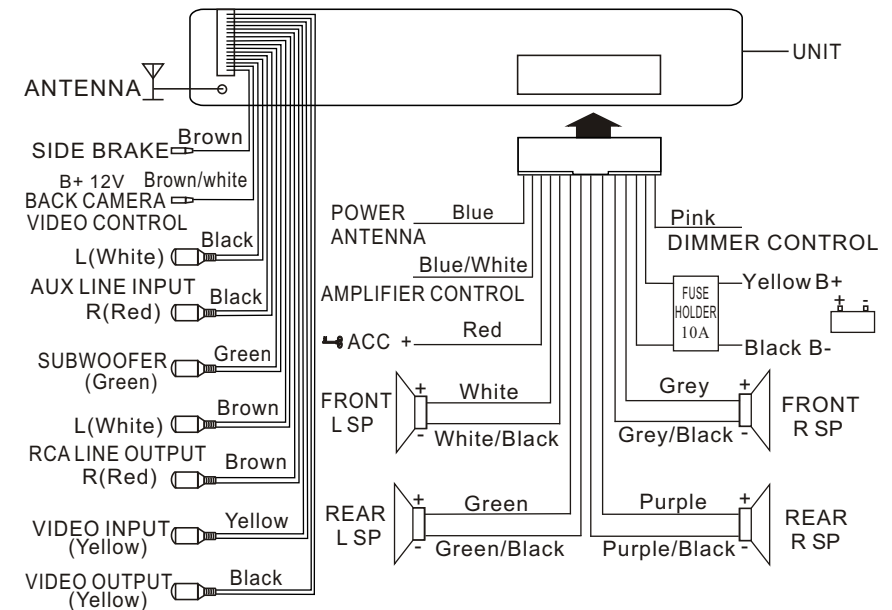

Panel's Diagram

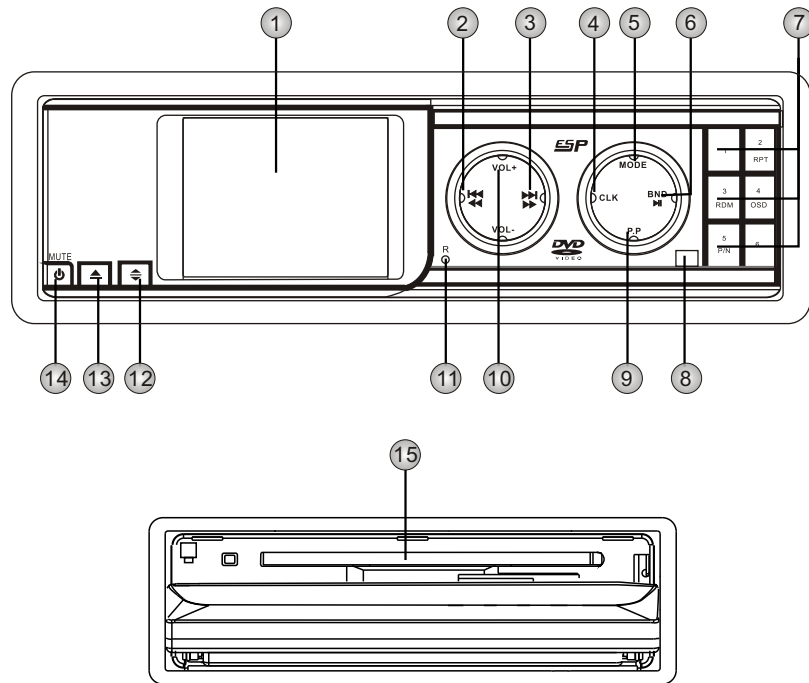

- | | |
|---|--------------------------------------|
| 1. LCD | 9. Brightness control |
| 2. Radio searching down/DVD last song & fast-backward | 10. Volume control & function button |
| 3. Radio searching up/DVD next song & fast-forward | 11. Reset button |
| 4. Clock display button | 12. Angle adjustment |
| 5. Radio/video switch | 13. Discs eject button |
| 6. Band & Play/pause button | 14. Power on/off & mute button |
| 7. Radio preset(1-6) | 15. Disc slider window |
| 8. Remote control receiver | |

Advanced Operations

The Features in Playing VCD Discs

For VCD discs, it supports a special function: *Programmed Playing*, which is not available in DVD discs. It allows you to enter the song number in which you want the disc to play.

1. The program playing function is only valid when the PBC is off or the unit is in stopping or returning to stop mode.
2. Please refer to the relational details instruction of audio operations part to know more on how to set up the program playing for VCD discs.

System Setup Menu

Press *Setup* button on remote control to pop-up the System Setup Menu when the unit is under stop/ playing mode.

- When the cursor is located at the top of the screen, press *Left/Right* arrow head buttons to switch between different pages.
- Press the *Down* arrow head button to move to the setup page, and *Up/Down* arrow head buttons to select the options that you want to change.
- Press *Right* arrowhead button on the selected caption to unfold the option list. Press *Up /Down* arrowhead buttons to change the selection up and down, then *ENTER* to confirm.

Setting up the Audio Language

1. You will first see the *LANGUAGE* menu page if the Setup Menu has been set up.
2. The *Menu Language* is used to select the setup menu and OSD (On-screen Display) language used in disc playing and instructing operation processes.

The language selection includes: Chinese, English, French, German, Spanish, Italian, Korean, Polish.

3. Disc Audio: When you begin to play a DVD disc, this unit will select its default valid language automatically. Notice: if the language annal in the disc is not available in the language list of disc menu, the original default language annal of the disc will be used.

If the disc matches with the playing language appointed, the language appointed will be selected.

4. The functions of Disc Subtitle and Disc Menu are similar to that of the *Disc Audio*. They are used to set a default playing language for the DVD subtitle and Menu display language.

DISPLAY Setup

1. You will enter the *DISPLAY* Setup Menu page.
2. TV Aspect: Depending on the types of your television, The image

VCD Control

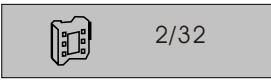
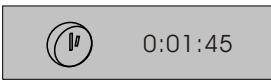
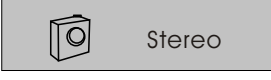
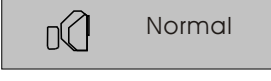
Items	Icon Symbols	Functions (Press Up/Down to select the items needed.)	Selecting Methods
Chapter Control		Display the current chapter number and the total number of the disc chapters. Users can jump to the chapter number needed.	Press ◀/▶ or <i>digital</i> button to select the Chapter (Track) needed directly.
Time Control		Display the time that the disc has elapsed. You can input the desired time from which you want to start playing directly. The time searching function is valid only to the current song.	Press <i>digital</i> button to select time needed, then <i>Enter</i> to confirm.
Audio Control		Display the current audio language used. You can also switch to other audio languages desired.	Press ◀/▶ to select <i>Stereo/Right/Left</i> sound channel.
Sound Control		Display the current audio mode. You can select between normal mode and 3D surrounding effect mode.	Press ◀/▶ to change the <i>Audio</i> mode.

Note: Press ▲ to move upward, and ▼ to downward.

Remote Control's Diagram

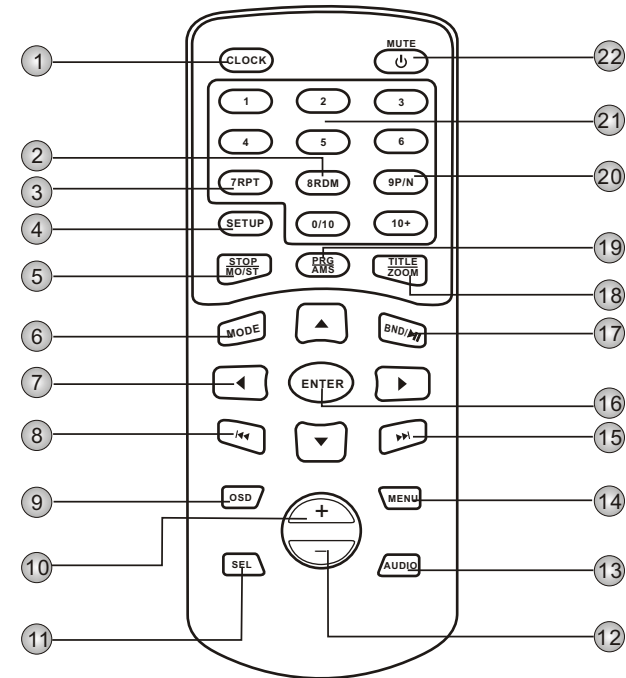

- | | |
|--|--|
| 1. Clock display button | 12. Volume down |
| 2. Random button | 13. Language menu |
| 3. Repeat button | 14. Menu button |
| 4. Set up button | 15. Radio searching up / DVD next song & fast-forward |
| 5. Radio/stereo&DVD/stop button | 16. Confirm button |
| 6. Radio/video interchange | 17. Band & Play/pause button |
| 7. Direction button ▲/▶/▼/◀ | 18. Title/zoom button |
| 8. Radio searching down/ DVD last song & fast-backward | 19. Radio / auto-memory & scan storage and DVD/programme |
| 9. On screen display | 20. PAL/NTSC switch |
| 10. Volume up | 21. Digital button 1-9, 0/10,10+ |
| 11. Sel [Volume control & Loud-adjust] button | 22. Power ON/OFF & mute button |

The Panel Button's Function Instructions

- **Power on/off & mute button**

Press this button once to turn on the player. In turn on mode, press short to activate the selecting mode of mute on/off; press and hold for more than 2 seconds to turn off the player.

- **Discs eject button (▲)**

In disc playing mode, Press it to eject a CD, and change to radio mode automatically. After ejecting the disc, it will enter again automatically if not take it out in 10 seconds, but not playing.

- **Reset button (R)**

Press to reset all the settings to the default.

- **Radio searching up / DVD next song & fast-forward (▶▶)**

1 In RADIO mode, press '▶▶' to adjust the receiver frequency up. Press and hold it for more than 2 seconds to search up automatically.

2 In displaying mode, press '▶▶' to select the next track.

3 In playback mode, press it continuously for more than 2 seconds as fast forward function. DVD playback consists 4 speeds: X2, X4, X16, X100. Playback VCD / SVCD consists 3 speeds: X2, X4, X8. Press playback button again, player resume to normal playback operation.

- **Radio searching down/ DVD last song & fast-backward (◀◀)**

1 In RADIO mode, press '◀◀' to adjust the receiver frequency down.

Press and hold it for more than 2 seconds to search down automatically.

2 In displaying mode, press '◀◀' to select the last track.

3 In playback mode, press it continuously for more than 2 seconds as fast backward function. DVD playback consists 4 speeds: X2, X4, X16, X100.

Playback VCD / SVCD consists 3 speeds: X2, X4, X8. Press playback button again, player resume to normal playback operation.

- **Band & Play/pause button (BAND/▶▶)**

In Radio mode, push down the button to select needed band [FM1, FM2, FM3, AM1, AM2, AM3].



In disc playing mode, press this button to switch to Disc playing mode. When playing the disc, press it to pause playing, press again to resume playing.

- **Clock display button (CLK)**

1. Press to enter time display mode, press again to exit this mode.



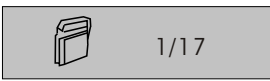
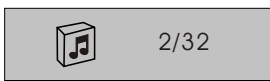
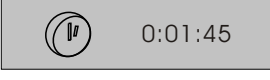
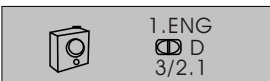

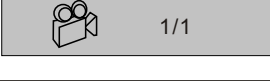
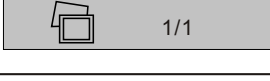
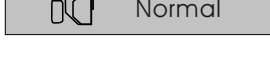
2. In time display mode, press 'SEL' button to enter second setting status, second digital flashes, depress 'VOL +/-' to adjust the second. Press "SEL" again to enter minute setting status, depress 'VOL +/-' to adjust. Press 'SEL' another time to enter hour setting status, depress 'VOL +/-' to adjust. Press it again to exit the hour mode, press another times to exit time display mode.

DVD-VR Control

Items	Icon Symbols	Functions (Press Up/Down to select the items needed.)	Selecting Methods
Group Control		Display the current group number and the total number of the disc groups. Users can jump to the group number needed.	Press ◀ / ▶ or <i>digital</i> button to select the Title needed directly.
Track Control		Display the current track number and the total number of the disc tracks. Users can jump to the track number needed.	Press ◀ / ▶ or <i>digital</i> button to select the Track needed directly.
Time Control		Display the time that the disc has elapsed. You can input the desired time from which you want to start playing directly.	Press <i>digital</i> button to select Time needed, then <i>Enter</i> to confirm.
Audio and digital audio output Control		Display the current audio language used and the digital audio output. You can also switch to other audio languages needed and digital audio outputs.	Press ◀ / ▶ to select <i>Language</i> and <i>Audio output</i> .
Subtitle Control		Display the current subtitle language used. You can also switch to other subtitle languages needed.	Press ◀ / ▶ to switch the <i>Subtitle</i> .
Angle Control		Display the current angle when playing AVTT. You can also switch to other angles.	Press ◀ / ▶ to change the <i>Angle</i> .
Page Control		Display the current page number when playing AOTT. You can also switch to other pages.	Press ◀ / ▶ to change the <i>Page</i> .
Sound Control		Display the current audio mode. You can select between normal mode and 3D surrounding effect mode.	Press ◀ / ▶ to change the <i>Audio mode</i> .

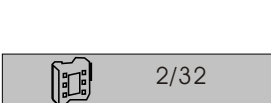
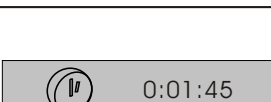
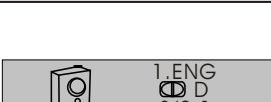
Note: Press ▲ to move upward, and ▼ to downward.

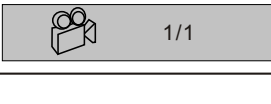
DVD Video Control

Items	Icon Symbols	Functions (Press Up/Down to select the items needed.)	Selecting Methods
Title Control		Display the current title number and the total number of the disc titles. Users can jump to the title number needed.	Press ◀/▶ or <i>digital</i> button to select the Title needed directly.
Chapter Control		Display the current chapter number and the total number of the disc chapters. Users can jump to the chapter number needed.	Press ◀/▶ or <i>digital</i> button to select the Chapter needed directly.
Time Control		Display the time that the disc has elapsed. You can input the desired time from which you want to start playing directly.	Press <i>digital</i> button to select Time needed, then <i>Enter</i> to confirm.
Audio and Digital Audio Output Control		Display the current audio language used and the digital audio output. You can also switch to other audio languages needed and digital audio outputs.	Press ◀/▶ to select <i>Language and Audio output</i> .
Subtitle Control		Display the current subtitle language used. You can also switch to other subtitle languages needed.	Press ◀/▶ to switch the <i>Subtitle</i> .
Angle Control		Display the current angle. You can also switch to other angles.	Press ◀/▶ to change the <i>Angle</i> .
Sound Control		Display the current audio mode. You can select between normal mode and 3D surrounding effect mode.	Press ◀/▶ to change the <i>Audio mode</i> .

Note: Press ▲ to move upward, and ▼ to downward.

The Panel Button's Function Instructions

• Volume control & function button

- A) Press 'VOL+/-' button, increase or decrease the volume.
- B) press front panel 'SEL' menu function, then press 'VOL+/-' button once, screen shows VOL menu, within 5 seconds press '◀◀' '▶▶' again, screen show following menu:

→ BASS → TREBLE → FADER → LOUD
 └ BRIGHTNESS ← CONTRAST ← COLOR ←

ATTENTION:

COLOR → CONTRAST → BRIGHTNESS, these 3 function operate in DVD & VCD mode only.

- Press '▶▶' button selects menu downward, press '◀◀' button selects menu upward. When selected certain a menu, press 'VOL+/-' for adjustment.

• Brightness control(PP)

Press it adjust tint & brightness, pictures can be switched in DAYLIGHT/NORMAL/USER/NIGHT mode.

• Radio preset 1-6

- 1 In radio mode, from 1-6, press and hold any one button for more than 2 seconds to store the radio program to the memory you are listening.
- 2 In radio mode, from 1-6, press any one button to call out the memory.
- 3 In disc playing mode, press '2RPT' once means Single song/Full disc/Menu repeat, shut off it if you do not use this function.
- 4 In disc playing mode, press '3RDM' once means Random playing, shut off it if you do not use this function.

- 5 In disc playing mode, press '4OSD' button shows function control menu. Menu select refer to DVD video control section.
- 6 In DVD/VCD mode, press '5P/N' means interchange between the PAL/NTSC system.

• Radio/video Switch(MODE)

1. In radio mode, press M MODE' button to switch in different playing modes. This operation will be invalid if there is no disc in the unit.
2. In any mode, press and hold it for more than 2 seconds to video/AUX input mode.

• Angle adjustment (◀▶)

This player include 5 multi angles position, press '◀▶' button once angle adjust approximately 15 degrees, press '◀▶' more than 3 seconds front panel resume to in initial position press this button is no operation.

• LCD

Display all selected functions.

• Disc slider window

Insert the disc into slider, CD will begin to play, and the name and number of the song will appear too.

Basic Operations

Turn on the DVD player

First, press the **POWER/MUTE** button to turn on the unit.

Notice:

1. Press **POWER/MUTE** button once to turn on the unit. In turn on mode, press short to switch on the sound channel output, press and hold it for more than 2 seconds to turn off the unit.
2. When the unit is off, press **POWER/MUTE** to replay the disc. It can memorize the last play mode, which belongs to DVD, VCD or CD.
3. You can end the standby state in power disconnecting mode.

Warning!

The unit is set with the screen saver function. When the unit is in pause mode, and no operations are performed within 5 minutes, it will enter **Screen Saver** mode automatically. when you begin to operate the unit again, screen saver will stop and return to normal mode automatically.

EJECT BUTTON

1. Press **EJECT** to pop-up the disc.
2. Input the disc into the disc tray.

Notice:

If the position inputted is improper, disc or the unit function may be damaged.

- When the tray heads out, insert the disc. Insert the disc with label upward.
- Please make sure only one disc is inserted once.
- If there is a disc in it, do not try to insert another.

- If the format of the disc inserted is recognized by the unit, the TV screen will show the corresponding disc symbol, and the unit will begin to play automatically.
- If the format of inserted disc is not recognized by the unit, the unit will change to radio mode automatically the monitor will show a disc symbol with a question mark on the top right corner of the screen.

Basic Playing

1. **⏸ (PLAY/PAUSE)**: Press it to pause the playing disc. Press **⏸** to enter pause mode, when the unit is playing a disc, press again to resume playing.
2. **⏩ (fast-forward)**: Press **⏩** and hold more than 2 seconds in playing mode, the playing content will start fast-forward. Press **⏩** continuously to increase the playing speed. In **⏩** mode, the picture on screen will move fast, and the sound will be interrupted. There are 4 speed levels for DVD discs playing: X2, X4, X16, X100. And 3 speed levels for discs except for DVD: X2, X4, X8. Press **PLAY** to resume normal playing.
3. **⏮ (fast-backward)**: Press **⏮** and hold more than 2 seconds in playing mode, the playing content will start fast-backward. Press **⏮** continuously to decrease the playing speed. In **⏮** mode, the picture on screen will move slow, and the sound will be interrupted. There are 4 speed levels for DVD discs playing: X2, X4, X16, X100. And 3 speed levels for

MP3 Functions

MP3 adopts to a standard which is the newest compressed technique of video digital playing, one disc can store more than 600 types of music, or more than 160 songs, and have the same quality as CD.

DISC PLAYING

Use the digital button to select the song playing directly.

1. According to the basic operating process, insert the disc correctly, the player will start to search the disc information, and then show the message on the screen.
2. If you select songs in the same file, please press the digital button directly to choose the song number to play. Example: to select the 108th song.

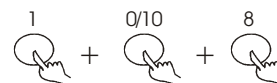

Press "PLAY" button to confirm.

3. If you select songs in different files: press screen show button once to select song in next file, press language channel button to select last file.

SELECTING THE SONG BY MENU

1. Insert the disc, wait until the player searching finished, TV screen will display the main MENU.

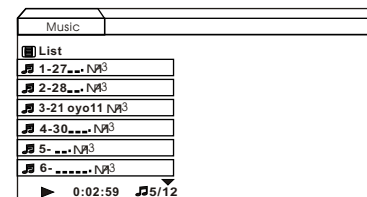

2. In playing, you can choose the song that you like.
3. Press **▲** button on remote control to search the last songs.
4. Press **▼** button on remote control to search the next songs.
5. Press Play/Pause button to confirm, the player will play the song selected a few seconds later.

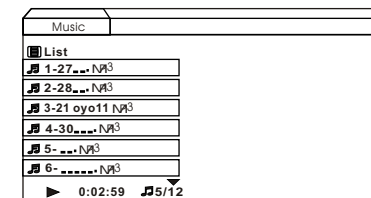

- The other functions, please refer to the basic operating part.
- When the song number selected is over 10, for example, to select the 18th, press digital button 1 first, then 8, it can play the 18th song then.

Basic Operations

Radio/auto-memory & scan storage/programme

- In radio mode, press this button on remote control to use auto-memory and scan storage function.
- In MP3 or CD playing mode, press 'PRG' to enter programming dialogue.
- In VCD playing mode, press stop button first, then 'PRG' button to program.
Press ▲ / ▼ / ◀ / ▶ direction buttons to select the track, and then ENTER to confirm after selecting the song.

Icons:

Music	
List	Program
1-27...MP3	
2-28...MP3	
3-21 oyo11 MP3	
4-30...MP3	
5-...MP3	
6-...MP3	
▶ 0:02:59 5/12	

Icon symbol	Function
	Means selecting the playing song;
	Means selecting the current list;
	Means deleting the programmed song which is playing now;
	Means deleting all the songs that have programmed already.

TITLE/ZOOM BUTTON

- In playback mode, press remote control ZOOM button as enlarge picture function, then press ▲ ▶, ▼ ◀ select the desired angle. Press first time enlarge picture 2 times, press twice enlarge picture 4 times, press third time, screen shows "Normal Picture" symbol, picture resume to original size.
- Press short to activate selecting title function, press digital button to select the song that you want to play.

Basic Operations

discs except for DVD:X2, X4, X8.
Press *PLAY* to resume normal playing.

- ◀◀ (LAST SONG):
Press ◀◀ on remote control in 3 seconds before a chapter or track playing, the playing content will jump to previous one and continue to play automatically.
Press ◀◀ after a chapter or track has played for over 3 seconds, the playing content will jump to the beginning of the previous chapter or track and continue to play automatically.
Press and hold ◀◀ on remote control for more than 2 seconds to start fast-backward.
- ▶▶ (NEXT SONG):
Press ▶▶ on front panel, the playing content will jump to the next chapter or track and continue to play automatically.
Press and hold ▶▶ on remote control for more than 2 seconds to start fast-forward.

Advanced Operations

REPEAT PLAY

RPT: Press 2 *RPT* button if you want to repeat playing the whole disc or a specific track/chapter of the disc.

- Press 2 *RPT* to switch among different repeat modes.
- When 2 *RPT* is pressed, the results of repeating may differ due to the disc types. Refer to the diagram below:

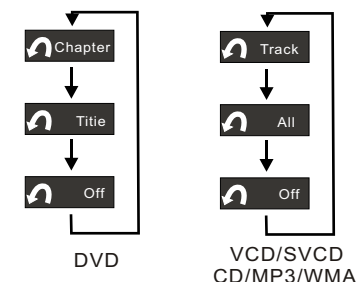

Using DVD Video Menu

When you insert a *DVD* disc into the *DVD* player and start to play:

- The unit will start to play from the beginning of the disc automatically, and then pop-up the *MENU*.
- Press ▲ / ▼ / ◀ / ▶ on *MENU* to move the highlight.
- Press *Enter* on selected option to confirm.

Language Channel button

In displaying mode, press this button to switch in different sound channels, which changes as follows:

Left channel → Right channel → Stereo

In radio mode, press this button once to turn on the key-press sound, press it again to turn off the key-press sound.

VCD/SVCD PBC MENU

Some *VCD* and *S-VCD* discs (especially Karaoke discs) have some menus. They are used to select the contents

Basic Operations

you want to enjoy. This type of menu can also be called *PBC (Playback Control)*.

MENU SET-UP

When playing this type of discs:

1. Press the MENU button long to setup PBC.
2. Press the digital buttons to enter the segment of the track you want to play. If the segment or track has two digits, please input the two digits continuously.

Warning!

If no operations are executed within 10 seconds after the PBC MENU is displayed, the unit will continue to play from the first track.

Select button

Press 'SEL' button to select the volume mode to adjust as following:

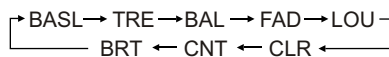

1. BAS adjustment
Press 'SEL' button once, BAS will be activated, then depress VOL '+/-' button to adjust the bass output.
2. TRE adjustment
Press 'SEL' button twice, TRE will be activated, then depress VOL '+/-' button to adjust the treble output.
3. BAL
Press 'SEL' button three times, BAL will be activated, then depress VOL '+/-' button to adjust left or right sound channel output.

4. FAD
Press 'SEL' button four times, FAD will be activated, then depress VOL '+/-' button to adjust front or rear louder-speaker output.
5. LOU
Press 'SEL' button five times, LOU will be activated, then depress VOL '+/-' button to adjust LOUDON to increase Loudness, and LOU OFF to decrease.
6. Adjust the video effect in VCD, DVD reading mode. Press 'SEL' button six times, CLR will activate this function, then depress VOL '+/-' button to adjust the display colour.

Press 'SEL' button seven times, CNT will activate this function, then depress VOL '+/-' button to adjust the display contrast degree. Press 'SEL' button eight times, BRT will activate this function, then depress VOL '+/-' button to adjust the display brightness. If you do not perform any operation after press 'SEL', it will exit this function automatically.

CONTROL OPERATION

1. Press OSD button to pop-up the Control Menu.
2. The On-Screen display function is valid only in DVD/DVDAudio/DVD-VR/VCD discs, and the display results may differ among some types of disc.

Basic Operations

N/P/AUTO

In order to get the best display effect of image. You must adjust the signal system to make it match with TV set.

1. There are three kinds of TV colour signal systems to select: NTSC, PAL or AUTOMATISM mode.
2. Press 5P/N every time it will select a kind of TV colour signal system conversion among NTSC, PAL and AUTOMATISM mode.

RANDOM PLAYING

1. Press 3RDM every time, the unit will execute random playing disc automatically.
2. In random playing mode, press it again to resume normal playing mode.

Warning!

This function is only valid in VCD, S-VCD and CD discs. When shut off PBC function, random playing is valid only in VCD/S-VCD discs.

DIGITAL BUTTON

In radio mode

1. Press and hold any one button 1-6 on remote control for over 2 seconds to store the radio stations to the memory you are listening.
2. From 1-6, press any one button to call out the memory.

In disc playing mode

1. Digital buttons are used to select the songs. If certain segment or track has two digits, please input two digits continuously. '10+' is only valid in

VCD mode.

2. In disc playing mode, press and hold '7RPT' button long means Single song repeat / Full disc repeat / Catalogue repeat. Press long again to shut off this function.
3. In disc playing mode, press and hold '8RDM' button long means Random playing. Press long again to shut off this function.
4. In DVD or VCD mode, press and hold '9P/N' more than 2 seconds means interchange between PAL/NTSC systems.

CLOCK DISPLAY BUTTON

1. Press to enter time display mode, press again to exit this mode.
2. In time display mode, press 'SEL' button to enter second setting status, second digital flashes, depress 'VOL '+/-' to adjust the second. Press 'SEL' again to enter minute setting status, depress 'VOL '+/-' to adjust. Press "SEL" another time to enter hour setting status, depress 'VOL '+/-' to adjust. Press it again to exit the hour mode, press another time to exit time display mode.

RADIO/STEREO/STOP BUTTON

1. In disc playing mode, press this button on remote control to stop playing.
2. In radio mode, press this button means sound channels changing function.

Free Manuals Download Website

<http://myh66.com>

<http://usermanuals.us>

<http://www.somanuals.com>

<http://www.4manuals.cc>

<http://www.manual-lib.com>

<http://www.404manual.com>

<http://www.luxmanual.com>

<http://aubethermostatmanual.com>

Golf course search by state

<http://golfingnear.com>

Email search by domain

<http://emailbydomain.com>

Auto manuals search

<http://auto.somanuals.com>

TV manuals search

<http://tv.somanuals.com>