

PYLE

OWNER'S MANUAL

PLDTN68

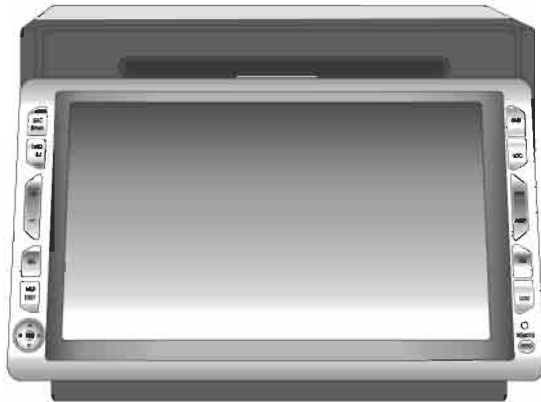

6.5" SLIDEDOWN INDASH MONITOR WITH BUILT IN TV
CAR DVD/ VCD/ CD/ WMA/ MP3 PLAYER/ RECEIVER

www.pyleaudio.com

Contents

Thank you for buying this product.

Please read through these operation instruments so you will know how to operate your model properly. After reading please keep this booklet in safe place for future reference.

1 Before You Start

- Important Safeguards* 4
- About this manual* 4
- Precautions* 5
- Maintenance* 6
- Location & function of the controls* 7
- Remote control* 8
- Specifications* 10

2 Installation

- Wiring Connections* 11
- Install the Unit* 12

3 General Operations

- Reset the Unit* 13
- Turning the Unit On/Off* 13
- Volume Control* 13
- Changing Widescreen Mode* 13
- Setting the Sound Characteristics* 13
- EQ Setting* 13
- Turning Loudness On* 14
- Eject a Disc* 14
- Open the Monitor* 14
- Angle Setting* 14
- Mute Function* 14
- Screen Saver* 14
- Clear* 14
- Mode Selector* 14
- Sensor* 14

4 Main Menu

- Main Menu Setup* 15
- Audio Setup* 15
- Video Setup* 16
- Source Setup* 17
- Preference Setup* 18

5 DVD

- Playing a DVD* 20
- Selecting Tracks Fast* 20
- Repeat Playing* 20
- Stop the Playback* 20
- Pause the Playback* 20
- Skip backward/forward* 20
- System Switch* 21
- Slow Motion Playback* 21
- Increase Picture Size* 21
- On Screen Display* 21
- Setting the Playback Time* 21
- Changing the Viewing Angle* 21
- Changing Audio Language* 22
- Changing the Subtitle Language* 22
- Selecting Menu* 22
- Set Up Menu* 22

Contents

6 MP3

- Playing a MP3 Disc* 28
- Selecting Tracks FF/F.REW* 28
- Repeat Playing* 28
- Number Buttons* 28
- Selecting the Mp3 Track* 28
- Stop Playing* 28
- Pause the Playback* 30
- Skip Backward/Forward/FF/F.REW the Playback* 30
- On Screen Display* 30

7 VCD/CD

- Playing a VCD/CD Disc* 31
- Selecting Tracks FF/F.REW* 31
- Repeat Playing* 31
- Playing Tracks at Random* 31
- Number Buttons* 31
- Stop Playing* 31
- Pause the Playback* 31
- Skip Backward/Forward/FF/F.REW the Playback* 31
- System Switch* 32
- Slow Motion Playback* 32
- Increase Picture Size* 32
- On Screen Display* 32
- Setting the Playback Time* 32
- Selecting Channel* 33
- PBC selector* 33
- Program playing* 33

8 Tuner

- Band Selector* 34
- Manual/Automatic Tuning* 34
- DX/LOC Selector* 34
- Selecting The stored Station* 34
- MO/ST Selector* 35
- Scanning/Memorizing Stations Automatically* 35
- Number Buttons* 35
- On Screen Display* 35

9 TV

- TV Display* 36
- Selecting Channel* 36
- Selecting Channel up and down* 36
- Searching Manual* 36
- Step* 36
- TV Menu Setup* 36

10 Additional Information

- Simple Troubleshooting Guide* 37

Before You Start

IMPORTANT SAFEGUARDS About this manual





- 1 **Be sure to connect the color coded leads according to the diagram. Incorrect connections may cause the unit to malfunction or damage the vehicle's electrical system.**
- 2 **Be sure to connect the speaker (-) leads to the speaker (-) terminal. Never connect the left and right channel speaker cables each other or to the vehicle body.**
- 3 **Make sure all the connections are completely correct before turning on your unit.**
- 4 **When replacing the fuse(s), the replacement must be of the same amperage as shown on the fuse holder.**
- 5 **Do not block vents or radiator panels. Blocking them will cause heat to build up inside and may result in fire.**
- 6 **To lest the driver distract his attention from, please install the unit in an apt place.**
- 7 **Using the unit after starting the engine, otherwise the unit can not be started, because the electric energy of battery was used up.**
- 8 **The unit must be screened from direct sunlight, or the electric energy of battery will be wasting for the high temperature.**
- 9 **Do not use the unit in extreme high temperature or such low temperature conditions, and also avoid humidity and direct sunlight.**
- 10 **Take care of the magnetism of the unit. Do no put the credit card, cassette or watch around the unit, or they would be broken or some information in them lose.**
- 11 **To lest disturb the video frequency, keep far away from the unit when using your phone.**
- 12 **Do not put the remote control under high temperature or where the sun strikes it, or else the control remote can not work normally.**

This unit features a number of sophisticated functions ensuring superior operation. All the functions have been designed for the easiest possible use, but many are not self-explanatory. This manual will help you understand the functions and operations of the unit. This manual main explains **remote control operation**. However, in addition to those functions related with DVD/VCD/CD/MP3 operation that can only be operated by the remote control, there are also functions can be operated by the buttons provided for the main unit.

Before You Start

PRECAUTIONS

This unit can play the following discs only:

Type of disc	Label on the disc	Recorded material	Size of disc
DVD		Sound and moving pictures	12cm
VCD	 	Sound and moving pictures	12cm
CD		Sound only	12cm
MP3		Sound only	12cm

NOTE: The unit is compatible with VCD1.0/2.0/3.0 version and DVCD disc.

- **Do not attempt to modify the unit, modifying the unit may cause an accident.**
- **Stop the vehicle before carrying out any operation that could interfere with your driving.**
- **Do not work in extremely high or low temperature. Be sure the temperature inside the vehicle is between +60° C and -10° C before turning on your unit .**
- **To enjoy optimum sound and images while playing, handle the discs as follows:**

—Handle the disc by its edge to keep the disc clean, and do not touch the surface.



—Do not use your CDs with paste residue or ink attached.



—Do not use CDs with labels or stickers attached, which may leave a sticky residue while beginning to peel off.
(Shown as the picture)



—Clean the discs with an optional cleaning cloth. Wipe each disc from the center out.
(Shown as the picture)

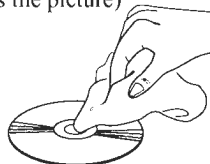

Besides playing the discs above, the unit also can be connected to TV, CD Changer and other connector. Please refer to the details on page 17 before you playing them.

Maintenance

Replacing the Fuse

Make sure the amperage matches the specified value when replacing the fuses. If the fuse is blown, check the power connection and replace with a new one. If the same problem occurs, it would be subjected to the malfunction. In such cases, please consult to the nearest service dealer.

▲ Warning

Never use the fuse with the rated amperage more than that supplied to your unit, otherwise it will damage the unit.

Replacing the Battery

When the range of the operation of the card remote control becomes short or no functions while operating. Replace the lithium battery with a new button cell (CR2025). Make sure the battery polarity before replace.

Gently pull out the Battery Holder while pressing the Stopper.

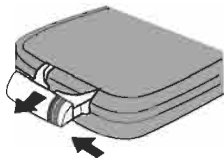

Put the button-type battery with mark(+) upward into the Battery Holder.

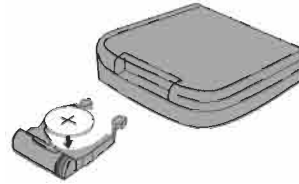

Insert the Battery Holder into the Remote Control.

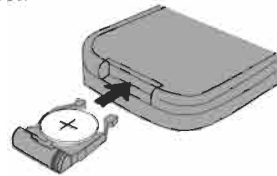

Precautions on Using Lithium Battery

Always keep the lithium battery beyond children's reach. In case swallowed, see a doctor immediately.

Cleaning the battery with a dry cloth, to ensure its perfect connected.

Make sure the proper polarity when loading with the battery.

To prevent short circuit, do not use metal tweezers to clip the battery.

▲ Warning!

Improper handle with the battery may lead to explosion. It cannot be charged, disassembled or thrown into a fire.

Before You Start

Location of the Controls

Front Panel

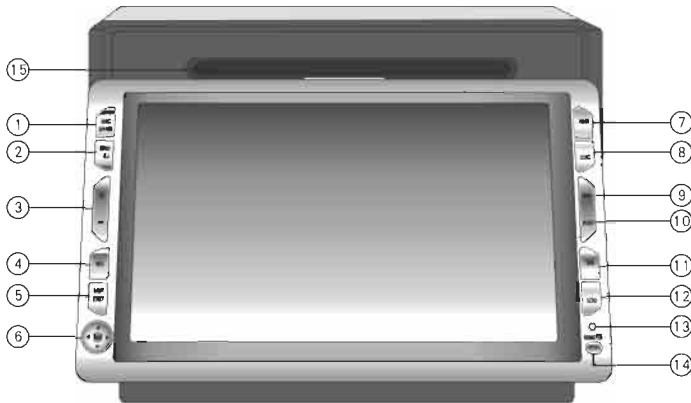



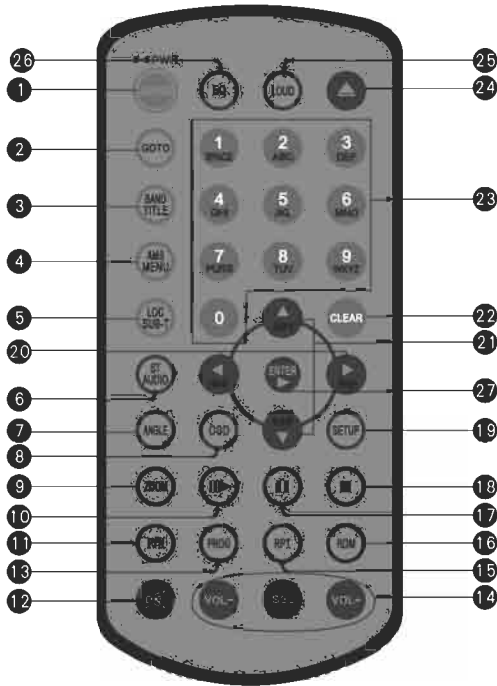





- ① **PWR/SRC Button**
Briefly pressing to select radio mode or play-back mode, hold and press it to turn the unit on or off.
- ② **BAND/EJECT Button**
Briefly pressing to select the bands; hold and press to eject or insert a disc.
- ③ **+/- Button**
Press to increase or decrease number or angle by using SELECT button at the same time.
- ④ **SELECT Button**
Briefly pressing it with +/- button to perform selective function, keep pressing it to turn on or turn off the screen saver.
- ⑤ **MUTE/SETUP Button**
Briefly press to cut down the sound output; during DVD mode, hold and press to exit the setting menu.
- ⑥ **⏪/⏩/⏴/⏵/ENTER**
Briefly Pressing ENTER also performs the function of play; press and hold to enter the root menu.
- ⑦ **AMS Button**
Press to activate AMS function.
- ⑧ **LOC Button**
Press to select distant or local station.
- ⑨ **WID Button**
Press to select 16:9 or 4:3 wide screen.
- ⑩ **AUD Button**
Press to select language or channel.
- ⑪ **EQ Button**
- ⑫ **LOU Button**
- ⑬ **RESET Button**
Press to reset the unit.
- ⑭ **REMOTE Infrared Sensor**
- ⑮ **Disc Loading Slot**
Insert a disc directly when the TFT is slant-wise.

Remote Control**Tips:**

For more information as to replacing battery, please refer to **Replacing the Battery** on page 6.

Before You Start

- 1 SOURCE/POWER
- 2 GOTO (playing time/track)
- 3 BAND/TITLE
- 4 AMS/MENU
- 5 LOC/SUB -T
- 6 ST/AUDIO
- 7 ANGLE
- 8 OSD
- 9 ZOOM
- 10  (Slow Forward/Reward)
- 11 P/N (System Adjusting)
- 12  Mute
- 13 PROG(Program playing)
- 14 VOL+ /VOL- /SEL
- 15 RPT(Repeat Playing)
- 16 RDM (Playing Tracks at Random)
- 17  (Pause/Play)
- 18  (Stop Playing)
- 19 SETUP (Briefly pressing it to set the current mode, keep pressing it to set the root menu.)
- 20  (F.F/F.R)
- 21  (Previous/Next Track)
- 22 CLEAR
- 23 0~9/A~Z(Number/Letter) Buttons
- 24  (Eject Button)
- 25 LOUD
- 26 EQ
- 27  (Left/Right/Up/Down ENTER)

Specifications

General

Power Requirement	14.4V DC (11-16V allowable)
Load Impedance	4Ω
Max.Power Output	60W X 4
Tone Controls	±10dB Bass 100Hz Treble 10KHz
Dimensions	Approx.253.1 x 178 x99.3 mm (d/w/h)
Mounting Dimensions	Approx.203.5 x178x99.3 mm (d/w/h)
Weight	Approx.3.05kg

FM Section

Tuning Range (Optional)	87.5-108(MHz) (Europe) 87.5-107.9(MHz) (U.S.A.)
IF Range	10.7MHz
Usable Sensitivity (-30dB)	10dBuV
Signal-to-noise Ratio	60dB
Stereo Separation	30dB (1KHz)
Frequency Response	40-12KHz

AM Tuner Section

Frequency Range (Optional)	522-1620(KHz) (Europe) 530-1710(KHz) (U.S.A.)
IF Range	450KHz
Usable Sensitivity (-20dB)	28dBuV

VCD/CD Player Section

VCD Signal System	AUTO/PAL/NTSC
Frequency Response	20Hz to 20KHz
Signal-to-noise Ratio	60dB
Separation	60dB(1KHz)
Distortion	0.3%

DVD Player Section

DVD Signal System	AUTO/PAL/NTSC
Number of channel	2 channels
Dynamic Range	60dB
Signal-to-Noise Ratio	60dB

Note:

Due to continuous product improvement, specifications and design are subject to change without prior notice.

Before You Start

Wiring Connection

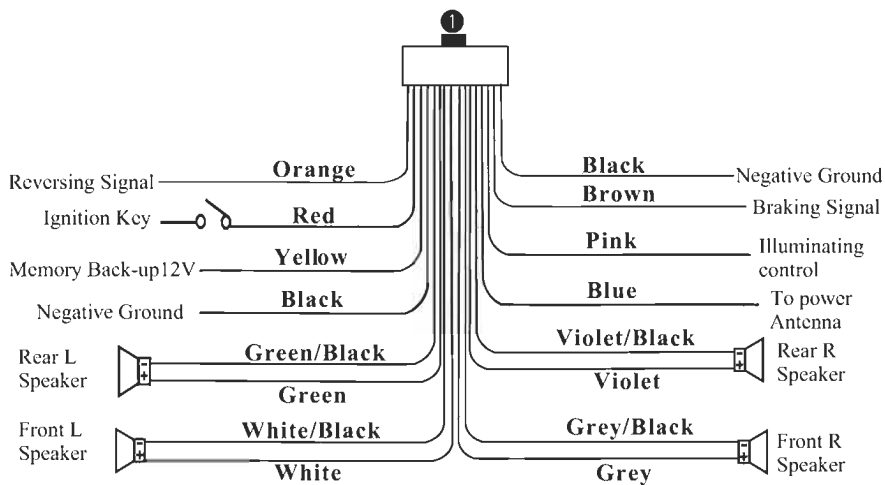
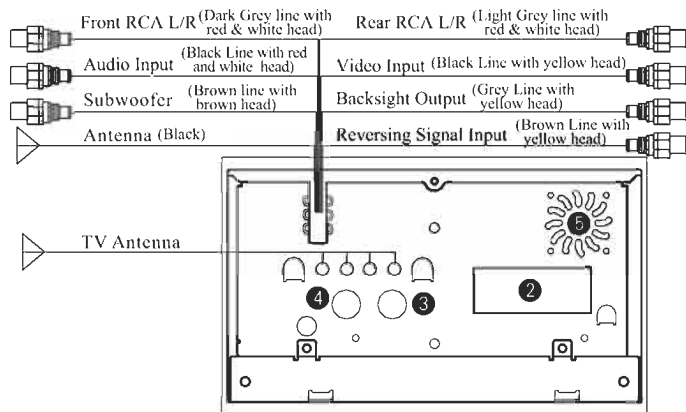

- ① Output Plug(Male)
- ② Output Socket(Female)
- ③ TV Receptor (optional)
- ④ Changer Receptor (optional)
- ⑤ Fan Window

Note:

* The brown wire is connected with brake signal; to make sure the safety, the programs can be seen on the monitor after braking the car, but the menu and RCA output are free of it. If you do not want to use this function, connect it with the negative pole.

Install the Unit

Installation Method

Installation using the screw holes at the sides of the unit.

Select a position where the screw holes of the mounting bracket supplied with the car and the screw holes of the main unit become aligned (are fitted), and tighten the screws (see at 2 places on each side). And then fasten them to the car.

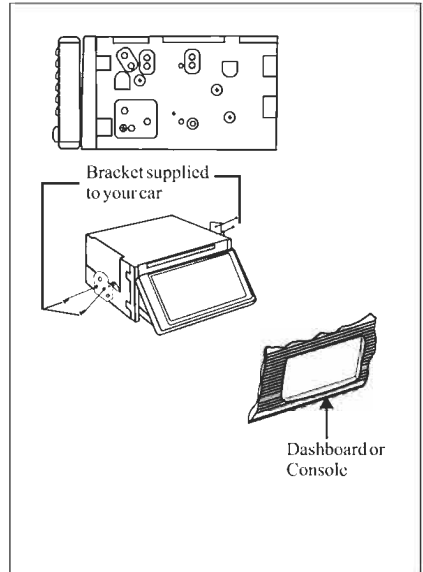

General Operations

Reset the Unit

Operating the unit for the first time or after replacing the car battery, you must reset the unit.

Remove the front panel at first, and then Press **⑬ RESET** button on the base with a pointed object, (such as a ballpoint pen) to set the unit to initial status.

▣ Notes:

- * When some errors occur on the display, you can also press **RESET** button to resume to normal, and it will erase the clock setting and some memorized functions.
- * This function can only be operated by the head unit.

Turning the Unit On/Off

Press **① PWR** button to turn on the unit, hold and press it to turn off the unit.

▣ Note:

- * Pressing **PWR** button on the head unit also performs the same operation.

Volume Control

Press **⑭ VOL+** button to increase the sound level and press **⑭ VOL-** button to decrease the sound level.

▣ Note:

- * Pressing **+/-** button on the head unit also performs the same operation.

Changing Widescreen Mode

Press **⑨ WID** button to select the wide-screen mode: 16:9 or 4:3.

▣ Note:

- * This function can only be operated by MAIN MENU.

Setting the Sound Characteristics

Repeatedly press **⑭ SEL** button to select the desired mode in the following order:



After selecting the desired mode, you can adjust the current level by pressing **⑭ VOL** buttons.

▣ Notes:

- * Pressing **+/-** button on the head unit also performs the same operation.
- * The function of **SEL/VOL+/VOL-** on remote control is the same as the corresponding button on the head unit, respectively.

EQ Setting

While listening to the popular music, classic music or rock music, you can select the corresponding preset modes to adjust the sound quality perfectly by using **⑳ EQ** button.

Repeatedly pressing **⑳ EQ** button to choose the following modes in turn:



The default setting is OFF.

▣ Note:

- * Pressing **EQ** button on the head unit also performs the same operation.

Turning Loudness On/Off

Briefly press **LOUD** button activate loud function. You can press this button to increase the low frequency, which can improve sensitivity for your ears. Press it again to quit this function.

Note:

- * Pressing LOU or Main Menu Setup on the head unit also performs the same operation.

Eject a Disc

Press and hold **EJ** button, eject or insert a disc when the TFT slanted. Press it again, the TFT will return to the initial status.

Note:

- * Pressing **▲** on the remote control performs the same function.

Angle Setting

Hold and press **SEL** button until the **ANGLE** appears on LCD, Press **+** to adjust monitor backward by definite angle, press **-** to adjust it forward.

Notes:

- * when adjusting the monitor angle, please press this button, or the monitor would be broken.
- * Pressing **(VOL+/VOL-/SEL)** on remote control also perform the same function.

Mute Function

Press **MUTE** button to shut off the sound output. And “” appears on the LCD. Press it again to resume to previous volume level.

Note:

- * Pressing MUTE on the head unit also performs the same operation.

Screen Saver

Press and hold **SEL** button to activate the screen saver in the modes other than VCD/DVD/AUX. And the screen will turn to black. Press the **SEL** button again to resume to the normal.

Note:

- * Keep pressing **SEL** on the head unit performs the same function.
- * To select the SCREEN SAVER option in the root menu performs the same function.

Clear

If input some wrong selection, press **CL-EAR** button to clear it.

Note:

- * This function is only valid on remote control.
- * This function is valid in radio status and playback mode.

Mode Selector

Repeatedly briefly press **SOURCE** button to select radio mode or playback mode.

Note:

- * Pressing SRC on the head unit also performs the same operation.

Infrared Sensor:

Receptor **IR** on the head unit for the card remote commander.

Main Menu

Set up Main Menu

Press and hold **SETUP** on the remote control or **ENTER**, the setting picture appears as follow:

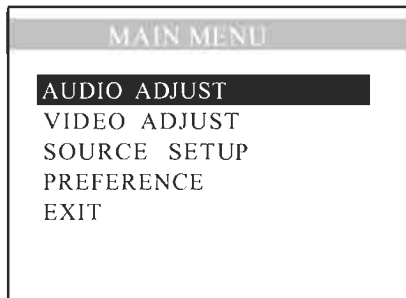

The main menu includes 5 selections above, press **▲** or **▼** button to select the requisite item, then hit **ENTER** to set it; press **▲** or **▼** button to reach **EXIT**, press **ENTER** to exit setting.

Note:

* Press and hold **SETUP** or press **MENU** on the head unit to set up this menu; during setting also can press **[▲]** **[▼]** **[▶]** **[◀]**/**ENTER** button on the remote control or the head unit.

1.Audio Setup

After Selecting **AUDIO SETUP**, press **ENTER** to enter the setting system:

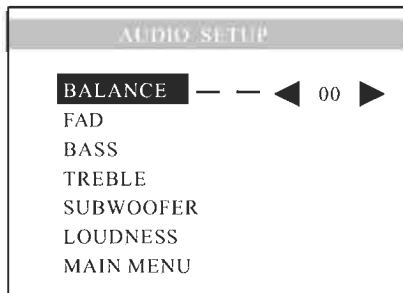

You can adjust **BALANCE**, **FAD**, **BASS**, **TREBLE**, **SUBWOOFER**, **LOUDNESS**. For example, press **[▲]** **[▼]** to select **FAD**, and then press **ENTER**, the setting menu will appear as follow:

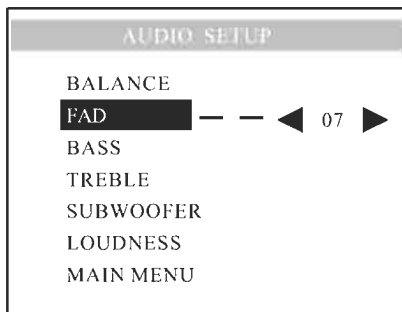

Press **[▶]** to remove the cursor to **◀ 07 ▶** press **[▲]** **[▼]** to increase or decrease the size, and then press **ENTER**.

Note:

* Adjusting the other items perform the same operation.

2.Video Setup

Selecting VIDEO SETUP in main menu, press **ENTER** to enter setting system.

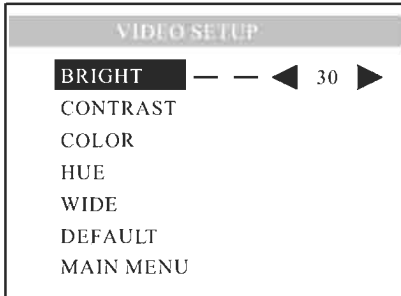
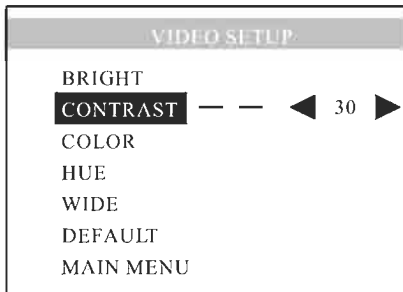

Image Adjust

Adjusting the CONTRAST : press[▲]or [▼] to select CONTRAST, then press **ENTER**, the setting menu appears as follow:



Press [▶] to remove the cursor to ◀ 30 ▶, press [▲] or [▼] to increase or decrease the contrast, and then press **ENTER**.

Adjusting the other items perform the same operation.

Note:

- * During DVD status, the signal is RGB; COLOR and HUE are the best status, no change.

Default

There are 4 items to adjust image directly: **VIVID,STANDARD,SOFT,USER**. The **DEFAULT** setting is **STANDARD** when adjusting BRIGHT, CONTRAST,COLOR, HUE. Press [▲][▼][▶][◀] to select, and then press **ENTER**.

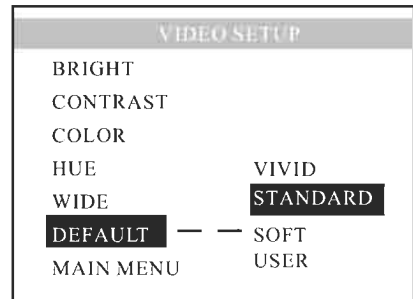
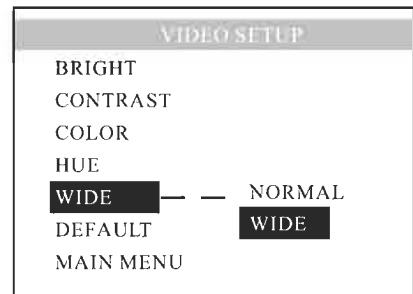

Image Format Selection

Selecting WIDE in VIDEO ADJUST. Show as:



Press [▶] to remove the cursor to NORMAL, and press **ENTER**, the image size is 4:3, remove the cursor to WIDE and press **ENTER**, the size is 16:9.

Main Menu

3. Source Setup

Selecting SOURCE SETUP in main menu, press **ENTER** to enter setting system.

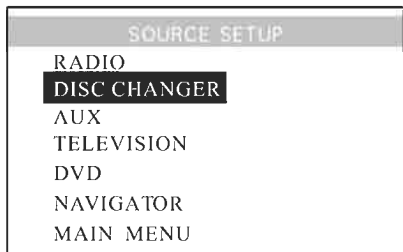

This menu can set up the above items by pressing [▶] and [▼] and ENTER. If you set one of them OFF, the function is invalid. For example, during RADIO OFF pressing **SOURCE** button can not activate tuning. During playback mode, you can not set it OFF.

Note:

- * If the unit contains the disc changer, DISC CHANGER will appear in this menu.

Turn On/Off Radio Setting

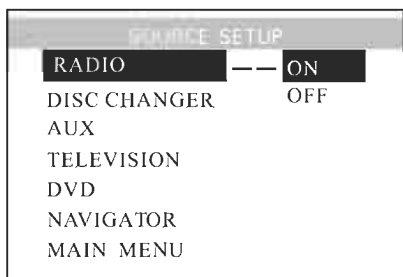

Turning on or off the radio can be set in this menu, the default setting is ON.

DISC CHANGER Setup

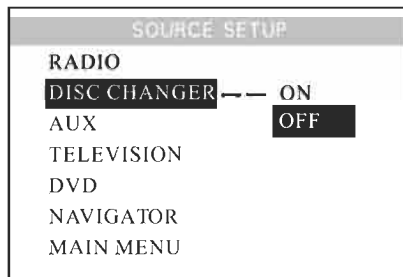

When under NONE default mode, the disc changer can not be played. Select the corresponding type before playing disc changer, when playing CD CHANGER, please select CD-C; when playing DVD CHANGER, please select DVD-C; when playing VCD CHANGER, select VCD-C. Press [▶] firstly, then press [▼] to set, press **ENTER** to confirm.

Auxiliary Setup

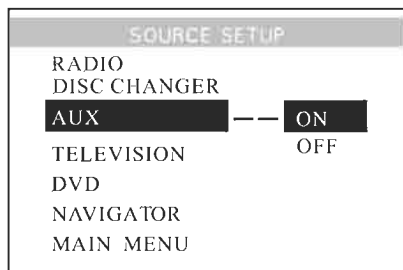

Setting the AUX on or off in this menu, the default is ON. If the AUX function is off, you can set it OFF. Press [▶] firstly, then press [▼], press **ENTER** lastly.

TELEVISION ON/OFF

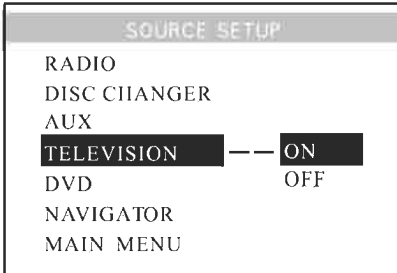

To set Television ON/OFF in this menu, the default setting is ON.

DVD ON/OFF

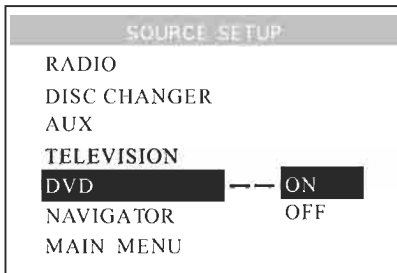

To set DVD ON/OFF in this menu, the default setting is ON.

4.PREFERENCE SETUP

Select PREFERENCE, then press ENTER.

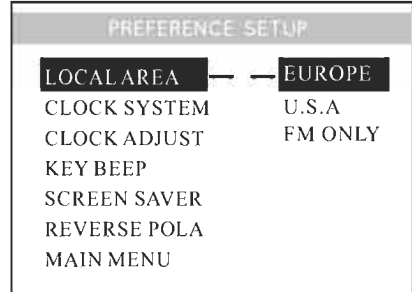

To set the above items by pressing [▶] and [▼] and ENTER.

LOCAL AREA SETUP

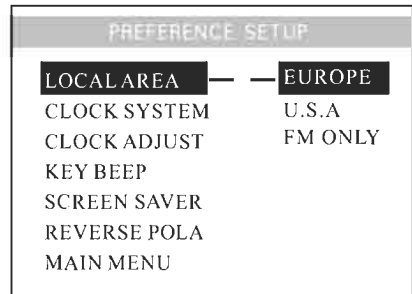

To set LOCALAREA in this menu, the default setting is EUROPE.

Main Menu

🔧 Clock System

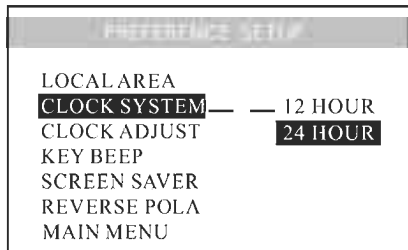

Setting CLOCK SYSTEM in this menu, according to the desired setting 12 HOUR or 24 HOUR, the default setting is 24 HOUR. Press [▶] firstly, then press [▼] to set, press ENTER lastly.

🔧 Clock Adjust

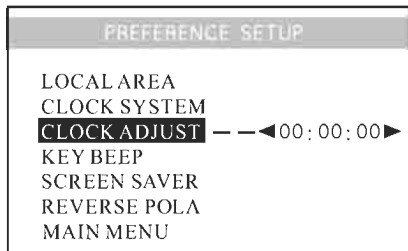

Setting CLOCK ADJUST in this menu, according to adjusting time, Press [▶] firstly, then press [▲] or [▼] to set, press ENTER lastly.

🔧 KEY BEEP

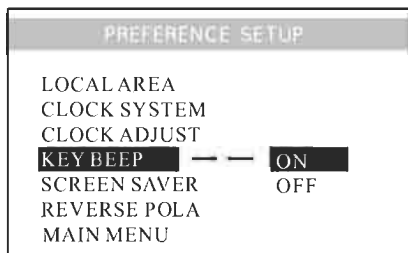

To set key beep in this menu on or off, the default setting is ON, Press [▶] firstly, then press [▲] or [▼] to set, press ENTER lastly.

🔧 SCREEN SAVER

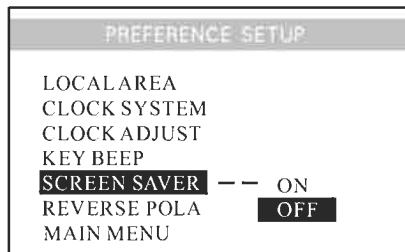

To set screen saver in this menu on or off other than VCD/DVD/AUX modes. To set it on, the screen will turn to black, the default setting is OFF. Press [▶] firstly, then press [▲] or [▼] to set, press ENTER lastly.

🔧 Reverse Pola

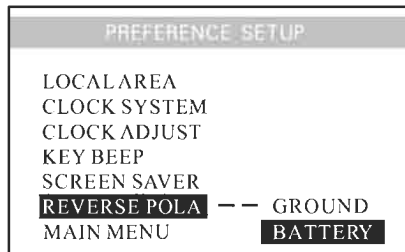

Setting REVERSE POLA in this menu. The signal is +12V when you back a car, please set BATTERY; if the signal is 0V, please set GROUND. Press [▶] firstly, then press [▼] to set, press ENTER lastly.





Playing a DVD

Insert a DVD disc into the slot , the unit will automatically switch on, if a DVD disc is loaded, press **SOURCE** to start the playback.



Note:

- * You can eject a DVD by pressing EJ button on the base or  on the remote control.

Selecting Tracks Fast

During DVD playback, press  to play the backward track, firstly press   to replay the previous track. Press  again within 3 seconds to play next track.

Note:

- * Pressing  and  button on the head unit also performs the same operation.

Repeat Playing

During DVD playback, press  **RPT** on the remote control to perform replaying function as followings:

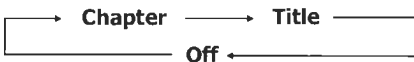

Note:

- * This function is only valid on remote control.
- * The default setting is Disc Repeat.





Number Buttons

Press one of  **Number Buttons(0~9)** to select a track, it will be played automatically.

Note:

- * The function is only valid on remote control.
- * Press  **CLEAR** to clear the mistake input.

Stop the playback

During DVD playback, firstly press   or  on the remote control to replay. Press  again to quit playing completely.

Note:

- * The function is only valid on remote control.



Pause the Playback

During DVD playback, press  to switch between play and stop; During stop mode, press this button to resume playback mode.

Note:



- * The function is only valid on remote control.

Skip backward/forward/F.F /F.REW the playback

Press  () on remote control to perform fast reward or fast forward. Each pressing will change as follow:



Note:

- * Press  or  on the head unit performs the same function.

DVD

System Switch

During playback mode, Press **11** P/N on remote control to set the TV standard to PAL or NTSC or AUTO system.

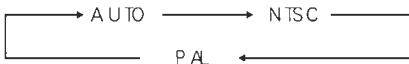

Note:

- * The function can be operated by selecting the DVD MENU SETUP.

Slow motion playback

During DVD mode, press **10** **11** to slow forward or slow backward. There are speeds as follow:

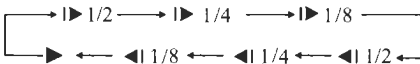

Note:

- * The function is only valid on remote control.

Increase the size of the picture

During DVD mode, Press **9** **ZOOM** to increase the picture in size. There are sizes as follow, Each pressing increases the size until the maximum size is reached.

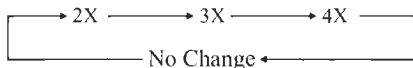

Note:

- * The function is only valid on remote control.
- * To remove the image by pressing **27** button.

On Screen Display

During DVD status, brief press **8** **OSD** button the display shows:

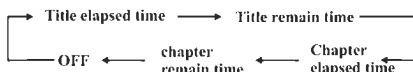

Press and hold **8** **OSD** to display the current setup.

Note:

- * The function is only valid on remote control.

DVD Playback Setting

During DVD mode, press **2** **GOTO** button to set the playing time, when the TFT display : *title/chapter/sound/captions/angle/title time/chapter time/repeat playing/time option*. Press **27** [**▲**] [**▼**] to select the options, press ENTER to set the status. Then press **NUMBER BUTTONS** or **27** [**▶**] [**◀**] to set the current status.

Note:

- * This function is operated by using the remote control.



Changing the viewing angle (Multi-angle)

With DVDs featuring multi-angle (scenes shot from multiple angles) recordings, you can press **7** **ANGLE** to switch among viewing angles during playback.

Selection options switch as follows:

ANGLE 1 — **ANGLE 2** — **ANGLE 3**

Notes:

- * This function is operated by using the remote control.
- * This function only operates with DVDs featuring multi-angle recordings.
- * The " mark on a DVD's package indicates it features multi-angle scenes. The number in the " mark indicates the number of angles from which scenes were shot.
- * It is invalid to pressing ANGLE during fast forward/fast reverse or pause.

Changing audio language (Multi-audio)

DVDs can provide audio playback with different language. With DVDs featuring multi-audio recordings, you can press **6** **AUDIO** to switch between language and audio systems during playback.

Selection options switch as follows:

AUDIO 1 — AUDIO 2 — AUDIO 3

■ Note:

- * This function is operated by using the remote control.
- * This function only operates with DVDs featuring multi-audio recordings.
- * The number in the “

Changing the subtitle language (Multi-subtitle)

With DVDs featuring multi-subtitle recordings. You can press **5** **SUB-T** to switch between subtitle languages during playback.

Selection options switch as follows:

Subtitles 1 — Subtitles 2 — Subtitles OFF

■ Note:

- * This function is operated by using the remote control.
- * This function only operates with DVDs featuring multi-subtitle recordings.
- * The number in the “

Selecting MENU

- 1 **Selecting Menu:** During DVD status, press **4** **MENU** to return to the root menu, all of the chapters will appear on monitor. You can press **27** or **23** button to select your desired chapter.
- 2 **Selecting Title:** During DVD status, press **3** **TITLE** to return the title menu, all of the titles will appear on monitor. You also can press **27** or **23** button to select your desired chapter.

■ Note:

- * The function is only valid on remote control.

DVD SETUP MENU

Briefly press **19** **SET UP** on remote control or press and hold **11** **MENU** on the head unit, main menu and sub-menu will appear on TFT, pressing **27** [**▲**] [**▼**] [**▶**] [**◀**] on remote control or **6** [**▲**] [**▼**] [**▶**] [**◀**] on head unit to select your desired items, then press **27** **ENTER** on remote control or **6** on head unit to confirm.

■ Notes:

- * The selections are the preferred options that will be chosen if they are available on a disc. If the disc that is inserted does not have the preferred option then the disc's own preference will be used.
- * Regarding **SETUP MENU**, please refer to the following pages for more details.
- * Some functions vary depending on the types of models or formats of the disc.
- * Press **19** **SETUP** on the remote control to exit the menu setup.

--General Setup Page--**TV Display**

Example showing how to set TV Display mode:

(Press ▲ or ▼)

--General Setup Page--

TV Display	Wide
Angle Mark	On
OSD Lang	Eng
Captions	Off
Screen Saver	On

Go To General Setup Page



(Press ►, ▲ or ▼, then press ENTER)

--General Setup Page--

TV Display	Wide	Normal/PS
Angle Mark	On	Normal/LB
OSD Lang	Eng	Wide
Captions	Off	
Screen Saver	On	

Set TV Display mode

Angle Mark

Example showing how to set picture mode:

(Press ▲ or ▼)

--General Setup Page--

TV Display	Wide
Angle Mark	On
OSD Lang	Eng
Captions	Off
Screen Saver	On

Go To General Setup Page



(Press ►, ▲ or ▼, then press ENTER)

--General Setup Page--

TV Display	Wide	
Angle Mark	On	On
OSD Lang	Eng	Off
Captions	Off	
Screen Saver	On	

Set Angle Mark

OSD Lang

Example showing how to set language mode:

(Press ▲ or ▼)

--General Setup Page--

TV Display	Wide
Angle Mark	On
OSD Lang	Eng
Captions	Off
Screen Saver	On

Go To General Setup Page



(Press ►, ▲ or ▼, then press ENTER)

--General Setup Page--

TV Display	Wide	
Angle Mark	On	
OSD Lang	Eng	English
Captions	Off	中文
Screen Saver	On	

Set OSD Language

--General Setup Page--**Captions**

Example showing how to set captions on/off:

(Press ▲ or ▼)

--General Setup Page--

TV Display	Wide
Angle Mark	On
OSD Lang	Eng
Captions	Off
Screen Saver	On

Go To General Setup Page



(Press ►, ▲ or ▼, then press ENTER)

--General Setup Page--

TV Display	Wide	
Angle Mark	On	
OSD Lang	Eng	
Captions	Off	On
Screen Saver	On	Off

Closed Captions

Screen Saver

Example showing how to set Screen Saver on/off:

(Press ▲ or ▼)

--General Setup Page--

TV Display	Wide
Angle Mark	On
OSD Lang	Eng
Captions	Off
Screen Saver	On

Go To General Setup Page



(Press ►, ▲ or ▼, then press ENTER)

--General Setup Page--

TV Display	Wide	
Angle Mark	On	
OSD Lang	Eng	
Captions	Off	
Screen Saver	On	On
		Off

Screen Saver

--Dolby Digital Setup--

Dual Mono Example showing how to set stereo mode:

(Press ▲ or ▼)

--Dolby Digital Setup--

Dual Mono
Dynamic

Go To Dolby Digital Setup

⇒

(Press ►, ▲ or ▼, then press ENTER)

--Dolby Digital Setup--

Dual Mono	Stereo
Dynamic	L-Mono
	R-Mono
	Mix-Mono

Dual Mono (1+1) Setup

Dynamic Example showing how to set dynamic range compression:

(Press ▲ or ▼)

--Dolby Digital Setup--

Dual Mono
Dynamic

Go To Dolby Digital Setup

⇒

(Press ►, ▲ or ▼, then press ENTER)

--Dolby Digital Setup--

Dual Mono	--- FULL --- 3/4 --- 1/2 --- 1/4 --- OFF
Dynamic	

Set DRC off

---Preference page---

TVType Example showing how to set TV type:

(Press ▲ or ▼)

--Preference Page--

TV Type	Auto
Audio	Eng
Subtitle	Eng
Disc Menu	Eng
Parental	
Password	
Default	

Go To Preference Page

⇒

(Press ►, ▲ or ▼, then press ENTER)

--Preference Page--

TV Type	Auto	PAL
Audio	Eng	Auto
Subtitle	Eng	NTSC
Disc Menu	Eng	
Parental		
Password		
Default		

Set TV Standard

Audio Example showing how to set Audio language:

(Press ▲ or ▼)

--Preference Page--

TV Type	Auto
Audio	Eng
Subtitle	Eng
Disc Menu	Eng
Parental	
Password	
Default	

Go To Preference Page

⇒

(Press ►, ▲ or ▼, then press ENTER)

--Preference Page--

TV Type	Auto	
Audio	Eng	English
Subtitle	Eng	
Disc Menu	Eng	
Parental		
Password		
Default		

Preferred Audio Language

Subtitle Example showing how to set subtitle language:

(Press ▲ or ▼)

--Preference Page--

TV Type	Auto
Audio	Eng
Subtitle	Eng
Disc Menu	Eng
Parental	
Password	
Default	

Go To Preference Page

⇒

(Press ►, ▲ or ▼, then press ENTER)

--Preference Page--

TV Type	Auto	
Audio	Eng	
Subtitle	Eng	English
Disc Menu	Eng	Off
Parental		
Password		
Default		

Preferred subtitle Language

---Preferences page--

Disc Menu

Example showing how to set Disc Menu Language:

(Press ▲ or ▼)

--Preference Page--

TV Type	Auto
Audio	Eng
Subtitle	Eng
Disc Menu	Eng
Parental	
Password	
Default	

Go To Preference Page



(Press ►, ▲ or ▼, then press ENTER)

--Preference Page--

TV Type	Auto	
Audio	Eng	
Subtitle	Eng	
Disc Menu	Eng	English
Parental		
Password		
Default		

Preferred Menu Language

Parental

Example showing how to set parental control:

(Press ▲ or ▼)

--Preference Page--

TV Type	Auto
Audio	Eng
Subtitle	Eng
Disc Menu	Eng
Parental	
Password	
Default	

Go To Preference Page



(Press ►, ▲ or ▼, then press ENTER)

--Preference Page--

TV Type	Auto	2	G ▲
Audio	Eng	3	PG
Subtitle	Eng	4	PG 13
Disc Menu	Eng	5	PGR
Parental		6	R
Password		7	NC 17
Default		8	Adult
			Off

Set Parental Control

Password

Example showing how to set password, and the default pas sword is 8888.

(Press ▲ or ▼)

--Preference Page--

TV Type	Auto
Audio	Eng
Subtitle	Eng
Disc Menu	Eng
Parental	
Password	
Default	

Go To Preference Page



(Press ►, ▲ or ▼, then press ENTER)

--Preference Page--

TV Type	Auto	
Audio	Eng	
Subtitle	Eng	
Disc Menu	Eng	
Parental		
Password		Change
Default		

Change Password

---Preferences page---

Default Example showing how to set load factory setting:

(Press ▲ or ▼)

--Preference Page--

TV Type	Auto
Audio	Eng
Subtitle	Eng
Disc Menu	Eng
Parental	
Password	
Default	

Go To Preference Page

(Press ►, ▲ or ▼, then press ENTER)

--Preference Page--

TV Type	Auto
Audio	Eng
Subtitle	Eng
Disc Menu	Eng
Parental	
Password	
Default	Reset

Load Factory Setting

MP3

Playing a Mp3 Disc

Insert a MP3 disc into the slot, the unit will automatically switch on, if a MP3 disc is loaded, press SOURCE to start the playback. During MP3 playback, the moving playing information displays on LCD. When playing a disc included PIC file, first press **18** ■ , then press [▲][▼] to select the option.

▣ Note:

- * You can eject a disc by pressing EJ on the base.

Selecting Tracks Fast

During Mp3 playback, press **21** ▲ to play the backward track, Press **21** ▼ to play next track.

▣ Note:

- * Pressing ▲ and ▼ button on the head unit also performs the same operation.

Repeat Playing

During Mp3 playback, press **15** RPT to replay the current track, press it again to cancel this function.

▣ Note:

- * This function is operated by using the remote control.
- * The default setting is catalog Repeat.

Number Buttons

Press one of **23** Number Buttons(0~9) to select a track to play automatically.

▣ Note:

- * This function is operated by using the remote control.
- * Press **22** CLEAR to clear the mistake input.

Selecting the MP3 Track

During Mp3 mode, firstly press **2** GOTO and the TFT shows:---. Then press **23** NUMBER BUTTONS to input the Mp3 track's Number to play it.; secondly press GOTO button, and the TFT shows : --:-- , now input the desired Number to play the current track at this point, If there are some mistakes, press **22** CLEAR to clear them.

▣ Note:

- * This function is operated by using the remote control.

Stop Playing

During Mp3 playback, Press **18** ■ to stop the playback.

▣ Note:

- * This function is operated by using the remote control.

Pause the Playback

During Mp3 playback, press **17** **||** to switch between play and stop.

Note:

- * This function is operated by using the remote control.

Skip backward/forward/F.F /F.REW the playback

Press **20** (**◀◀** or **▶▶**) on remote control to perform fast reward or fast forward.

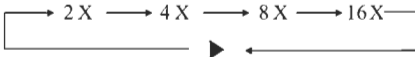

Note:

- * Press **◀** or **▶** on the head unit performs the same function.

On Screen Display

Hold and press **8** OSD button to display the current status.

VCD/CD

Playing a VCD/CD

Insert a VCD/CD disc into the slot, the unit will automatically switch on, if a disc is loaded, press SOURCE to start the playback.

Note:

- * You can eject a disc by pressing EJ on the base or \blacktriangle on the remote control.

Selecting Tracks Fast

During VCD/CD playback, firstly press 21 \lll to replay the current track, press 21 \lll again to play the backward track, Press 21 \ggg to play next track.

Note:

- * Pressing \blacktriangle and \blacktriangledown button on the head unit also performs the same operation.

Repeat Playing

During VCD/CD playback, repeatedly press 15 **RPT** to perform replaying function, first press it to replay the current track, press it again to cancel this function.

Note:

- * This function is operated by using the remote control.
- * The default setting is Disc Repeat.

Playing Tracks at Random

During VCD/CD playback, pressing 16 **RDM** button on the remote control to play any track at random under the directory which you select. Press it again to return to normal playing.

Note:

- * This function is operated by using the remote control.

Number Buttons

Press one of 23 **Number Buttons(0~9)** to select a track to play automatically.

Note:

- * This function is operated by using the remote control.
- * Press 22 **CLEAR** to clear the mistake input.

Stop Playing

During VCD/CD playback, firstly Press 18 \blacksquare button then press 27 or 17 to replay, press 18 \blacksquare again to stop the playback.

Note:

- * This function is operated by using the remote control.

Pause the Playback

During VCD/CD playback, press 17 **II** to switch between play and stop.

Note:

- * This function is operated by using the remote control.

Skip backward/forward/F.F /F.REW the playback

Press 20 (\lll or \ggg) on remote control to perform fast reward or fast forward.



Note:

- * Press \blacktriangleleft or \blacktriangleright on the head unit performs the same function.

System Switch

During VCD mode, Press **11** P/N on remote control to set the TV standard to PAL or NTSC or AUTO system.



Note:

- * The function is only valid on remote control.

Slow motion playback

During VCD mode, press **16** **1/2** to slow forward or slow backward. There are speeds as follow:.

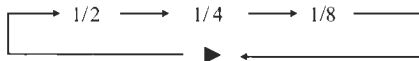

Note:

- * The function is only valid on remote control.

Increase the size of the picture

During VCD mode, Press **9** **ZOOM** to increase the picture in size. There are sizes as follow, Each pressing increases the size until the maximum size is reached.

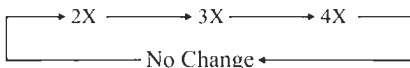

Note:

- * The function is only valid on remote control.
- * To remove the image by pressing **27** button.

On Screen Display

During VCD/CD status, brief press **8** **OSD** button the display shows:

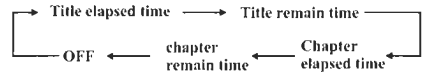

Press and hold **8** **OSD** to display the current setup.

Note:

- * The function is only valid on remote control.

Setting the Playback Time

During CD playback, firstly press **2** **GOTO**, and TFT shows : *disc playback time:--:--*, press your desired time of the playback by using number buttons.

Secondly press **GOTO** button, *the tracks time* appears on TFT, also input your desired numbers to play the current time of your selection.

During VCD mode, press **2** **GOTO** button to set the playing time, when the TFT display : *title/chapter/sound/captions/angle/title time/chapter time/repeat playing/time option*. Press **27** [**▲**] [**▼**] to select the options, press **ENTER** to set the status. Then press **23** **NUMBER BUTTONS** or **27** [**▶**] [**◀**] to set the current status.

Note:

- * This function is operated by using the remote control.

Selecting Channel

During VCD status, repeatedly press **23** AUDIO button to select the following channel:

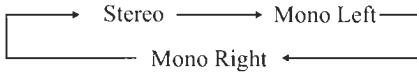

Selecting the corresponding channel to set the different sound characters.

Note:

- * Press the AUD button on the head unit performs the same function

PBC Selector

During VCD status, firstly press **3** TITLE button, the PBC playback starts and the menu of entire disc appears on LCD. And then you can select your desired track by using **27** or **23**. When a track is playing, you can press MENU to return to the menu, if you would like to end the track and select others. To cancel PBC playing, press **3** TITLE button again.

Note:

- * PBC playing confirms to version 2.0 or above disc only.

Program Playing

During VCD/CD mode, press **13** PROG, the TFT displays the program menu. Pressing **NUMBER BUTTONS** to select the track Number and then press **27** to move the cursor to **START**, press **ENTER** to start program playing; move the cursor to EXIT and press **ENTER** to exit the program playing. Move the cursor to **⏮** and press **ENTER** to the last page; move the cursor to **⏭** and press **27** **ENTER** to the next page. During this process, press **18** ■ or press **PROG** to cancel the program playing.

Note:

- * The function is only valid on remote control.

Listening to the radio

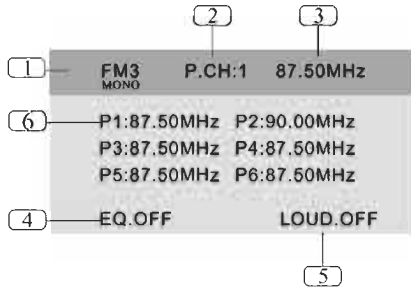

1 Band Indicator

Shows which band the radio is tuned to.

2 Preset Number Indicator

Shows what preset has been selected.

3 Frequency Indicator

Shows which frequency the tuner is tuned.

4 EQ Indicator

Shows the EQ Setting of the radio.

5 MBP Indicator

Shows that MBP is on or off.

6 The 6 stations of the current band.

Band Selector

During radio status, repeatedly press **3** BAND button to select bands in the following order:

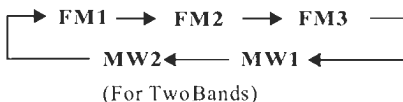

Note:

- * Press BAND on the head unit performs the same function.

Manual/Automatic Tuning

Manual Tuning: Press **20** (▶▶ or ◀◀) button on the remote control continuously to select a station downward or upward respectively.

Automatic Tuning: Press and hold **20** (▶▶ or ◀◀) button for more than 3 seconds, the radio automatically searches a station downward or upward respectively and plays when it finds a station.

Note:

- * Press ▶ and ◀ button on the head unit performs the same function.

DX/LOC Selector

During radio status, press **5** LOC button to select strong or weak station reception.

“LOC” appears on the display and only local station is available. when it disappears both distance and local stations can be received.

Note:

- * Press LOC button performs the same function.
- * The function is invalid in AM tuning.

Selecting the Stored Station

During radio status, press **27** ▲ button to select the stored station upward, press ▼ to select the stored station downward.

Note:

- * Press ▲ or ▼ button on the head unit performs the same function.

MO/ST Selector

During radio status, you can press **6** **ST** button on the remote control to select **MONO** mode or **STEREO** mode.

Stereo reception is charged when “steoer” appears.

It is switched to **MONO** mode when “mono” appears.

▣ Note:

- * It is only valid on remote control.
- * Switch to MONO compulsively to improve the listening quality when weak signal.
- * It is only valid in FM tuning.

Scanning/Memorizing Stations Automatically

During radio status, you can press **4** **AMS** button on the remote control to scan each stored station 5 seconds respectively which stored in **23** Number Buttons (from 1 to 6). You can press the corresponding Number Buttons or AMS button when your desired station is charged. And it starts playing that station.

When press and hold **4** **AMS** button for more than 2 seconds, it will activate automatically memory storing function. The radio automatically selects a station and has it stored in any one of the **23** **Number Buttons (from 1 to 6)**.

▣ Note:

- * The unit can be stored up to 6 stations for each band.
- * Press AMS button performs the same function.

Number Buttons

During radio status, press **Number Buttons** to receive the stored stations.

During radio status, **Number Buttons (from 1 to 6)** **23** can help you store your favorite station. You can follow the steps as below:

- 1 When receiving a station, press and hold any one of the **Number Buttons (from 1 to 6)** until the number appears on the **LCD**, which indicates that station is already stored in the corresponding number button.
- 2 Press **4** **AMS** button to receive stations automatically, and store them in 1 to 6 number respectively.
- 3 Press and hold another number button more than 2 seconds when listening in a station in one number button's, the station will be stored in that number button.

▣ Note:

- * It is only valid on remote control.

On Screen Display

During radio status, keep pressing **8** **OSD** to display the current mode; briefly pressing it to switch between RDS setup and preset frequencies.

TV Display

Press OSD to display the current TV information

Selecting Channel

Selecting channel 1-9 can just press NUMBER BUTTONS 1-9 to select .Selecting channel 10-30,first press GOTO and then press the NUMBER BUTTON to select.

- ▣ Note:
- * This function can only be operated by remote control.
 - * Only channel 1-30can be selected.

Selecting Channel up and downw

Press ▲ can select cannel upwards.
Press ▼ can select cannel downwards.

- ▣ Note:
- * Press ▲/▼ on the head unit performs the same function.

Searching Manual

Press ► can search manual upwards.
Press ◀ can search manual downwards.

- ▣ Note:
- * Press ►/◀ button on the head unit performs the same function.

Step

Longly press ►/◀ can operate the STEP function.Press ◀ step upwards.Press ► step downwards.The Step function can make the image be in the best.

- ▣ Note:
- * Longly press ⑥ ►/◀ button performs the same function.

TV MENU SETUP

In the TV mode,press ②/⑥ ENTER button can enter the TV MENU

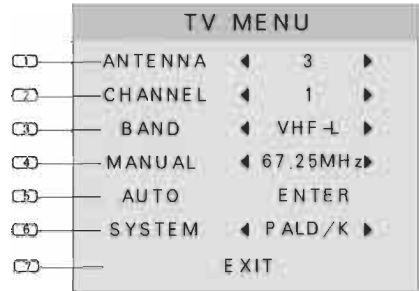

In the MENU press ▲/▼ select,press ►/◀ setup.

① Selecting ANTENNA

Selecting ANTENNA 1,ANTENNA 2 ANTENNA 3,ANTENNA 4,ANTENNA 5 .

② Selecting Channel

Selecting Channel 1-30.

③ Selecting Band

Selecting Band VHF-L/VHF-H/UHF.

④ Selecting /Searching Band

Longly press ►/◀ can select band.
Shortly press ►/◀ can select band.

⑤ Auto Search

Press Enter into the Auto Search function that it can auto search and store.

⑥ Selecting System

There are PAL D/K,PALM,PALN, PALB/G,PALI,NTSC M,SECAM D/K, SECAM B/G System can be selected.

⑦ Exit

Simple Troubleshooting Guide

The following checklist might help to solve the problems which you meet when using the unit. Please double check and make sure if the connection and the procedure of the operation is properly before using the checklist below .

Problem	Cause/Solution
No power.	<ul style="list-style-type: none">• Check and make sure whether the fuse is blown, replace with the proper value if necessary.
Some errors occur in the LCD or no function when pressing the button.	<ul style="list-style-type: none">• Press RESET button.
Unable to receive stations.	<ul style="list-style-type: none">• Check and make sure whether the antenna is inserted or the antenna is properly connected, if not, insert the antenna or connect it properly.
Poor effect on receiving a station.	<ul style="list-style-type: none">• Antenna may not be the proper length. Make sure the antenna is fully extended; if broken, replace the antenna with a new one.• The antenna is poorly grounded, check and make sure the antenna is properly grounded at its mounting location. .
CDs cannot be loaded.	<ul style="list-style-type: none">• A CD is loaded in the mechanism.
Sound skips.	<ul style="list-style-type: none">• The CD is dirty or damaged.
No images.	<ul style="list-style-type: none">• The Video line from main unit to the TV is not connected properly.
Images skip.	<ul style="list-style-type: none">• Improper setting of the color system. Set the color system to "PAL" or "NTSC" according to the connected television.

Note:

If any of the problem persist after check list had been made, consult your nearest service dealer. Never attempt to disassemble your unit by yourself.



Due to continuous product improvement, the operations are subject to run the model.

Free Manuals Download Website

<http://myh66.com>

<http://usermanuals.us>

<http://www.somanuals.com>

<http://www.4manuals.cc>

<http://www.manual-lib.com>

<http://www.404manual.com>

<http://www.luxmanual.com>

<http://aubethermostatmanual.com>

Golf course search by state

<http://golfingnear.com>

Email search by domain

<http://emailbydomain.com>

Auto manuals search

<http://auto.somanuals.com>

TV manuals search

<http://tv.somanuals.com>