

**PYLE®**

**PLDVD65IN**

# **OWNER'S MANUAL**

## **Mobile Video System**

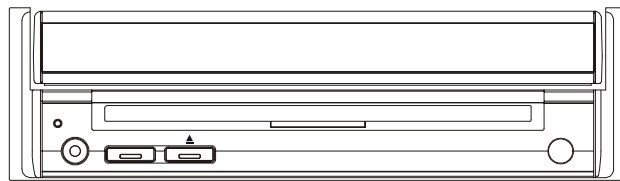
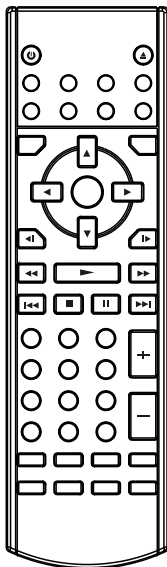

- **Vertical Adjustable And Horizontal Rotatable Panel**
- **6.5 Inch Color TFT Monitor**
- **DVD/CD/MP3**
- **Multi-subtitle Languages Function**
- **Multi-audio Languages Function**
- **Multi-angle Function**
- **Parental Control**
- **Remote Control**

**[www.pyleaudio.com](http://www.pyleaudio.com)**

## CONTENTS

---

<b>Safety Information</b> .....	<b>4</b>
<b>Disc Notes</b> .....	<b>5</b>
<b>Installation</b> .....	<b>6</b>
<b>The Player</b> .....	<b>9</b>
Front View .....	9
Back View .....	10
<b>Electrical Connection</b> .....	<b>11</b>
<b>Remote Control</b> .....	<b>12</b>
Location and Function of Keys .....	12
Preparing the Remote Control .....	14
<b>Loading/ Ejecting a disc</b> .....	<b>15</b>
Loading a disc .....	15
Ejecting a Disc .....	15
<b>Operation</b> .....	<b>16</b>
Basic Operation .....	16
Disc (DVD, VCD, CD, MP3) Operation .....	18
RGB Operation .....	22
<b>Setup</b> .....	<b>23</b>
Initial Setup .....	23
General Setup .....	23
Speaker Setup .....	25
Audio Setup.....	25
Preferences Setup .....	26
Defaults Table .....	29
<b>Trouble Shooting</b> .....	<b>30</b>
<b>Specifications</b> .....	<b>32</b>

## FEATURES

### Compatible with NTSC DVD (Video CD)

This player can play discs recorded in either NTSC format.

- A single LSI chip now integrates all major DVD playback circuit functions including MPEG2 decoder, video D/A converter, and audio decoders.
- L/R stereo analog audio outputs for connection to existing head unit aux inputs. Video output is composite video.
- Supplied remote handles multi-function software (multi-language audio-track/subtitle, multi-angle, multi-story, etc.), plus all basic functions.

### USE THIS PRODUCT SAFELY

This set has been designed and manufactured to assure personal safety. Improper use can result in electric shock or fire hazard. The safeguards incorporated in this unit protect you if you observe the following procedures for installation, use and servicing. This unit doesn't contain any parts that can be repaired by the user.

#### When Driving

Keep the volume level low enough to be aware of road and traffic conditions.

#### When Car Washing

Do not expose the product to water or excessive moisture. This could cause electrical shorts, fire or other damage.

#### When Parked

Parking in direct sunlight can produce very high temperatures inside your vehicle. Give the interior a chance to cool down before starting playback.

#### Use the Proper Power Supply

This product is designed to operate with a 12 volt DC, negative ground battery system (the regular system in a North American car).

#### Protect the Disc Mechanism

Avoid inserting any foreign objects into the slot of this player.

Failure to observe this may cause malfunction due to the precise mechanism of this unit.

#### Use Authorized Service Centres

Do not attempt to disassemble or adjust this precision product. Please refer to the Service Centre list included with this product for service assistance.

#### For Installation

The unit should be installed in a horizontal position with the front end up at a convenient angle, but not more than 30°.

#### Protect the monitor mechanical

- The monitor is operated automatically. Do not draw the monitor out or turn it upward or downward manually. Otherwise, the mechanism construction may be harmed to some degree.
- When you operate the monitor with the remote handset, do not touch the monitor by your hands. It may harm your fingers.

## **SAFETY INFORMATION**

---

### **CAUTION:**

MOBILE DVD PLAYER IS A CLASS I LASER PRODUCT. HOWEVER THIS MOBILE DVD PLAYER USES A VISIBLE/INVISIBLE LASER BEAM WHICH COULD CAUSE HAZARDOUS RADIATION EXPOSURE IF DIRECTED. BE SURE TO OPERATE THE MOBILE DVD PLAYER CORRECTLY AS INSTRUCTED. USE OF CONTROLS OR ADJUSTMENTS OR PERFORMANCE OF PROCEDURES OTHER THAN THOSE SPECIFIED HEREIN MAY RESULT IN HAZARDOUS RADIATION EXPOSURE. DO NOT OPEN COVERS AND - DO NOT REPAIR YOURSELF. REFER SERVICING TO QUALIFIED PERSONNEL.

### **WARNING:**

- TO REDUCE THE RISK OF FIRE OR ELECTRIC SHOCK, DO NOT EXPOSE THIS EQUIPMENT TO RAIN OR MOISTURE.
- TO REDUCE THE RISK OF FIRE OR ELECTRIC SHOCK, AND ANNOYING INTERFERENCE, USE ONLY THE RECOMMENDED ACCESSORIES.
- THIS DEVICE IS INTENDED FOR CONTINUOUS OPERATION.

This product incorporates copyright protection technology that is protected by method claims of certain U.S. patents and other intellectual property rights owned by Macrovision Corporation and other rights owners. Use of this copyright protection technology must be authorized by Macrovision Corporation, and is intended for home and other limited viewing uses only unless otherwise authorized by Macrovision Corporation. Reverse engineering or disassembly is prohibited.

### **REGION MANAGEMENT INFORMATION**

Region Management Information:  
This Mobile DVD Player is designed and manufactured to respond to the Region Management Information that is recorded on a DVD disc. If the Region number described on the DVD disc does not correspond to the Region number of this Mobile DVD Player, this Mobile DVD Player cannot play this disc.

## DISC NOTES

### Disc formats supported by this player



**DVD**  
12 cm disc  
(Single-sided disc only)



**VIDEO CD**  
12 cm disc



**CD**  
12 cm disc



**MP3**  
12 cm disc

### Discs which cannot be played with this player

- DVD-ROM
- DVD-R/DVD-RAM
- CDV
- CD-G

### Handling and Cleaning

- Dirt, dust, scratches and warping disc will cause misoperation.
- Do not place stickers or make scratches on discs.
- Do not warp discs.
- A disc should always be kept in its case when not in use to prevent from damaging.
- Do not place discs in the following places:
  1. Direct sunlight
  2. Dirty, dusty and damp areas
  3. Near car heaters
  4. On the seats or dashboard

### Disc Cleaning

Use a dry soft cloth to wipe the surface. If the disc is quite dirty, use a soft cloth slightly moistured with isopropyl (rubbing) alcohol. Never use solvents such as benzine, thinner or conventional record cleaners as they may mar the surface of the disc.

### Note:

A disc may become somewhat scratched (although not enough to make it

unusable) depending on your handle it and conditions in the usage environment. Note these scratches are not an indication of any problem with the player.

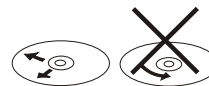
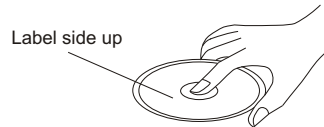

Wipe the disc from center toward the outside edge

### Preparing New Discs with Rough Spots

A new disc may have rough edges on its inside and outside edges. If a disc with rough edges is used, the proper setting will not be performed and the player will not play the disc. Therefore, remove the rough edges in advance by using a ball point pen or pencil as shown on the right. To remove the rough edges, press the side of the pen or pencil against the inside and outside edges of the disc.

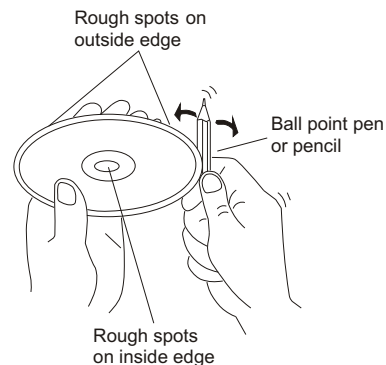

## INSTALLATION

### Notes:

- Choose the mounting location where the unit will not interfere with the normal driving function of the driver.
- Before finally installing the unit, connect the wiring temporarily and make sure it is all connected up properly and the unit and the system work properly.
- Use only the parts included with the unit to ensure proper installation. The use of unauthorized parts can cause malfunctions.
- Consult with your nearest dealer if installation requires the drilling of holes or other modifications of the vehicle.
- Install the unit where it does not get in the driver's way and cannot injure the passenger if there is a sudden stop, like an emergency stop.
- If installation angle exceeds 30° from horizontal, the unit might not give its optimum performance.

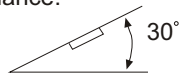

- Avoid installing the unit where it would be subject to high temperature, such as from direct sunlight, or from hot air, from the heater, or where it would be subject to dust, dirt or excessive vibration.

### DIN FRONT/REAR-MOUNT

This unit can be properly installed either from "Front" (conventional DIN Front-mount) or "Rear" (DIN Rear-mount installation, utilizing threaded screw holes at the sides of the unit chassis). For details, refer to the following illustrated installation methods.

### DIN FRONT-MOUNT (Method A)

#### Installation Opening

This unit can be installed in any dashboard having an opening as show below:

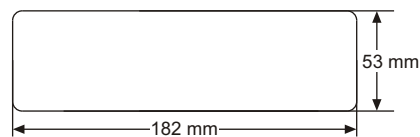

#### Installing the unit

Be sure you test all connections first, and then follow these steps to install the unit.

1. Make sure the ignition is turned off, and then disconnect the cable from the vehicle battery's negative (-) terminal.
2. Disconnect the wire harness and the antenna.
3. Lift the top of the outer trim ring then pull it out to remove it.
4. The two supplied keys release tabs inside the unit's sleeve so you can remove it. Insert the keys as far as they will go (with the notches facing up) into the appropriate slots at the middle left and right sides of the unit. Then slide the sleeve off the back of the unit.

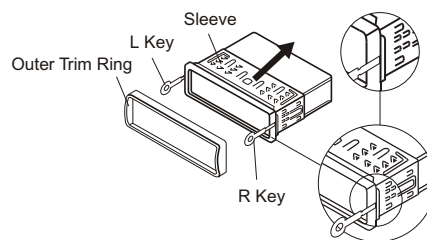

5. Mount the sleeve by inserting the sleeve into the opening of the dashboard and bend open the tabs located around the sleeve with a screwdriver. Not all tabs will be able to make contact, so examine which ones will be most effective. Bending open the appropriate tabs behind the dashboard to secure the sleeve in place.

## INSTALLATION

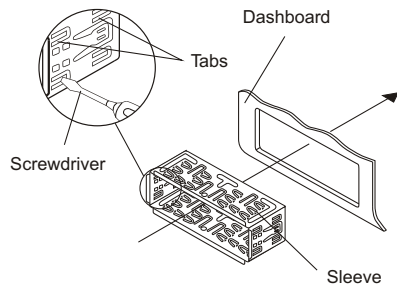

6. Reconnect the wire harness and the antenna and be careful not to pinch any wires or cables.
7. Slide the unit into the sleeve until it locks into place.
8. To further secure the unit, use the supplied metal strap to secure the back of the unit in place. Use the supplied hardware (Hex Nut (M5mm) and Spring Washer) to attach one end of the strap to the mounting bolt on the back of the unit. If necessary, bend the metal strap to fit your vehicle's mounting area. Then use the supplied hardware (Tapping Screw (5x25mm) and Plain Washer) to attach the other end of metal strap to a solid metal part of the vehicle under the dashboard. This strap also helps ensure proper electrical grounding of the unit.

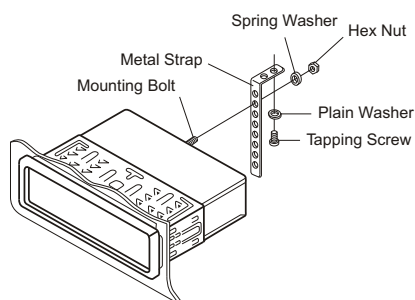

9. Reconnect the cable to the vehicle battery's negative (-) terminal. Then replace the outer trim ring.

### Removing the unit

1. Make sure the ignition is turned off, and then disconnect the cable from the vehicle battery's negative (-) terminal.
2. Remove the metal strap attached the back of the unit (if attached).
3. Lift the top of the outer trim ring then pull it out to remove it.
4. Insert both of the supplied keys into the slots at the middle left and right sides of the unit, then pull the unit out of the dashboard.

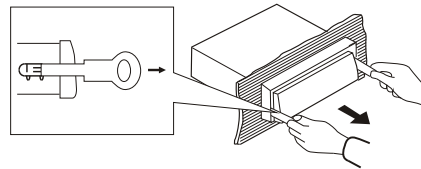

## INSTALLATION

---

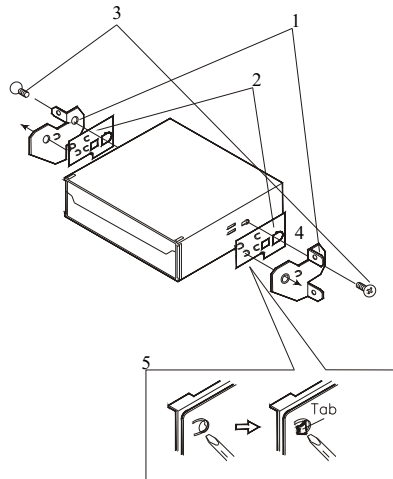

### DIN FRONT-MOUNT (Method B)

1. Factory radio mounting bracket
2. Car radio mounting bracket
3. Screw
4. After aligning the car radio mounting bracket with the factory radio mounting bracket, tighten the screws (5x5mm) at 2 places on each side.
5. When fix factory radio mounting bracket with the screws, use a standard-tipped screwdriver to bend open the tabs of the car radio mounting bracket to make them fit into the holes in the factory radio mounting bracket.



## THE PLAYER

---

### FRONT VIEW

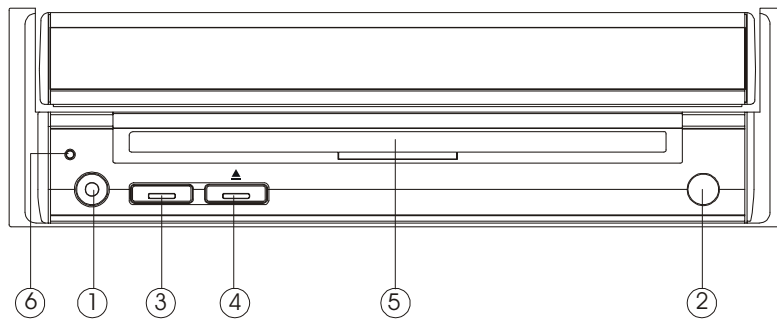

### When the monitor stretching out:

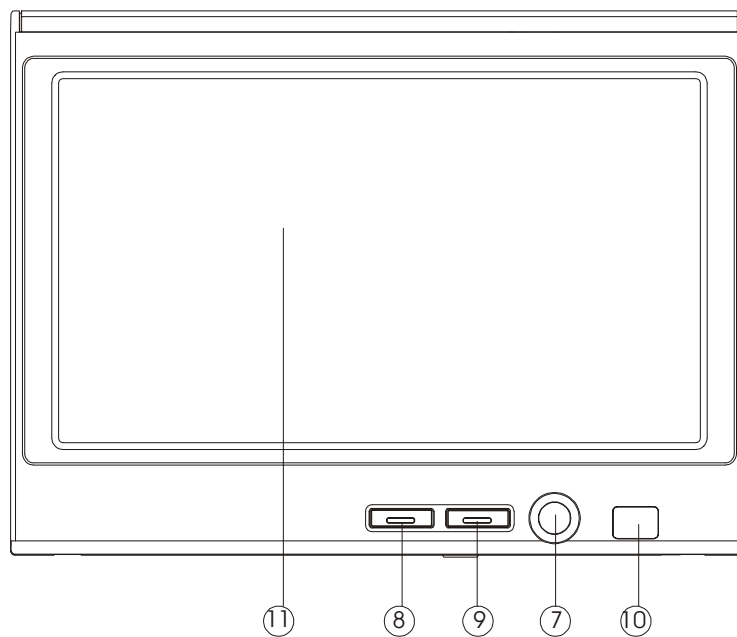

- |                                       |  |
|---------------------------------------|--|
| 1. POWER                              | 7. PICTURE                               |
| 2. Remote sensor (on the front panel) | 8. VOLUME -                              |
| 3. OPEN/CLOSE                         | 9. VOLUME +                              |
| 4. ▲ (EJECT)                          | 10. Remote sensor (on the monitor panel) |
| 5. Disc Slot                          | 11. 6.5 INCH COLOR TFT MONITOR           |
| 6. Reset Button                       |  |

## THE PLAYER

---

### BACK VIEW

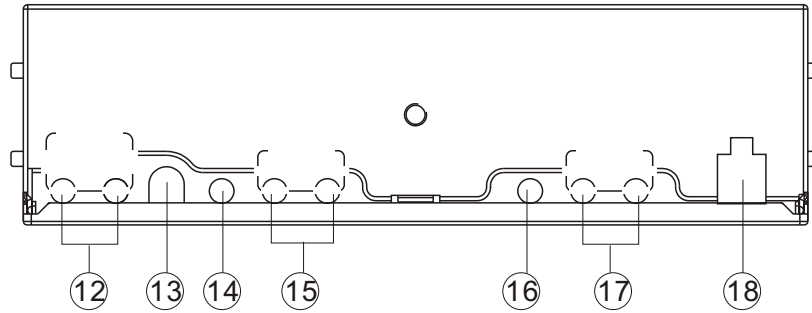

- |                          |                         |
|--------------------------|-------------------------|
| 12. AUDIO/VIDEO INPUT 1  | 16. DIGITAL AUDIO       |
| 13. RGB SYSTEM           | 17. AUDIO/ VIDEO OUTPUT |
| 14. REMOTE SOCKET        | 18. DC 12V IN           |
| 15. AUDIO/ VIDEO INPUT 2 |                         |

## ELECTRICAL CONNECTION

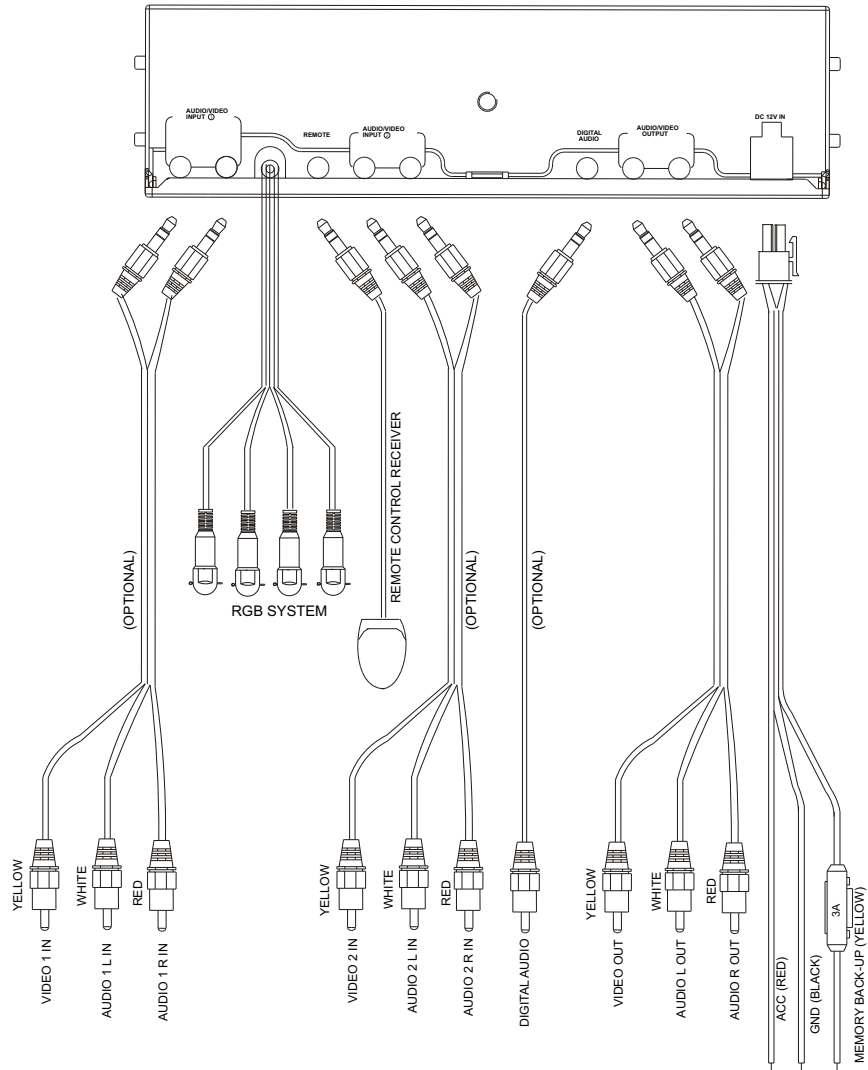

## REMOTE CONTROL





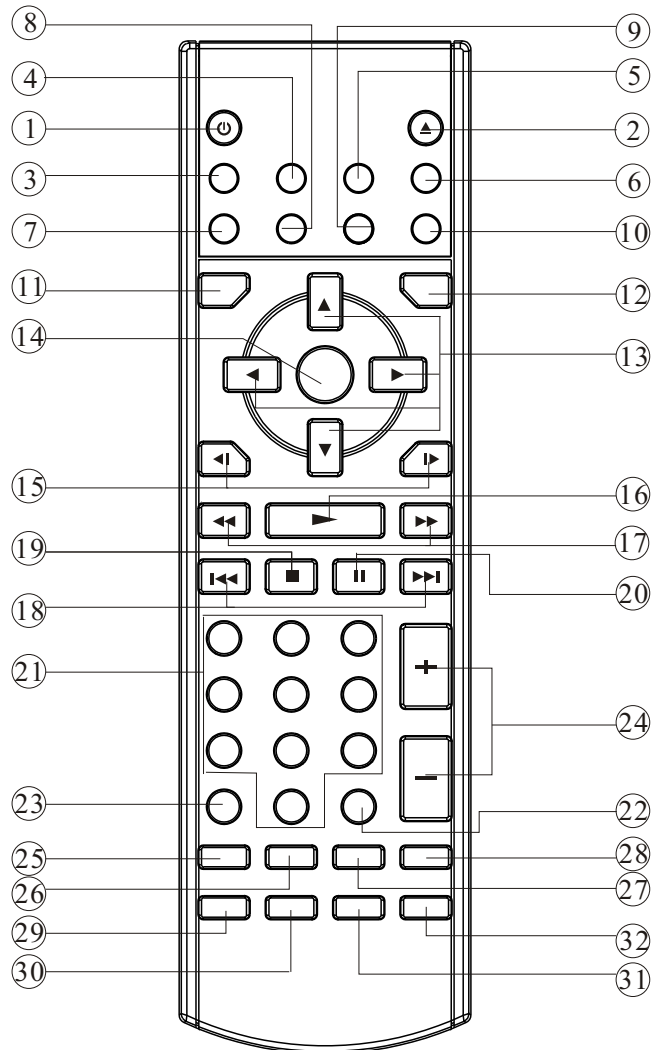

















---

### LOCATION AND FUNCTION OF KEYS



## REMOTE CONTROL

---

1.  POWER Press POWER to turn the unit ON or OFF.
2. EJECT Press to eject the disc.
3. OPEN/CLOSE Press to open/close the monitor .
4. SUBTITLE Changing of the SUBTITLE language on multi-subtitle language DVD disc.
5. ANGLE Changing of the view angle on multi-angle DVD disc.
6. DISPLAY Display statistical disc information during playback.
7. MODE Changing between DVD, AV1,AV2, and RGB mode
8. SETUP Display the SETUP menu.
9. PAL/NTSC Switch between PAL mode and NTSC mode.
10. AUDIO Changing of the AUDIO soundtrack on multi-audio soundtrack DVD disc. Changing of the sound mode of the VCD/CD disc.
11. TITLE Display the TITLE menu that is stored in DVD disc.
12. MENU Display the root menu that is stored on the DVD disc.
13.  /  ,  /  In case of MENU mode,  /  ,  /  , buttons served as cursor buttons to select item left/right, ahead/back.
14. ENTER Confirm the Track/Chapter selected with the numeric buttons or selected with the cursor buttons on TV screen.
15.  /  Changing for slow forward/ reverse playback motion
16.  Press to play the disc.
17.  /  Press  to search forward rapidly &  to search reverse rapidly.
18.  /  Press  to skip to the next track & press  to skip back one track.
19.  Press it to stop playback.
20.  Press it to pause playback.
21. 0 - 9 Numeric buttons
22. 10+ Increments number by (10,20,30,...etc), cooperatively used with numeric buttons.
23. CLEAR When you input a number in error, press the button to clear it.
24. VOLUME+/- Press VOLUME+/- button to increase or decrease the volume level.
25. ZOOM Allows the picture to be increased in size.
26. PANEL+ Press to turn the monitor upward at fine steps.
27. GOTO Disc search button, cooperatively used with numeric buttons.
28. PBC Changing between PBC ON and PBC OFF on the VCD disc.
29. PROGRAM Allows the track played in the order you programmed.
30. PANEL- Press to turn the monitor downward at fine steps.
31. REPEAT Switch the Repeat mode of discs.
32. A-B A-B repeat allows a passage to be repeated continuously.

## REMOTE CONTROL

---

### Preparing the Remote Control

#### Inserting the Batteries

1. Open the battery compartment cover.
2. Insert the new batteries. Make sure that the positive and negative terminals of the batteries are oriented as indicated.
3. Close the cover  
Battery: Two AAA size battery.

#### Using the Remote Control

Point the remote control towards the remote control signal receiver on the player front face.

Operation angle: About  $\pm 30$  degree in each the direction of the front of the remote sensor.

## LOADING/EJECTING A DISC

---

### Loading a Disc

1. Turn the ignition on the accessory position.
2. Press the **POWER** button (1).
3. Insert the disc with printed side facing up into the disc slot (2).
4. The player starts playback automatically.

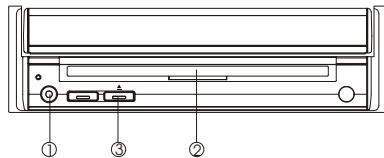

### Ejecting a Disc

Press ▲ (**EJECT**) button (3) to eject the disc.

## OPERATION

### BASIC OPERATION

#### Turnig the player on/off

Press the **POWER** button on the front panel or **⏻ (POWER)** button on the remote control to turn the player on or off.

#### Open/Close the Monitor and Angle Adjustment

- Press **OPEN/CLOSE** button on the front panel or point the remote control to the remote sensor on the front panel and press **OPEN/CLOSE** button on the remote control, the monitor will stretch automatically .

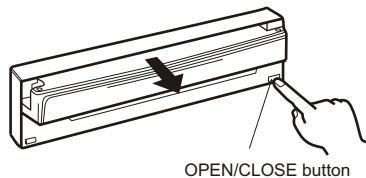

Fig.1

When the monitor stretches to a certain location, it will turn upward automatically and stop at vertical position.

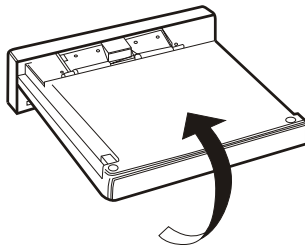

Fig.2

- Adjusting the viewing angle.  
When the monitor doesn't move, you can press **PANEL+** or **PANEL-** button on the remote control to turn the monitor upward or downward at fine steps to get a desired viewing angle. And you can rotate the monitor left and right from the central viewing position at a certain angle range manually.

Don't rotate the monitor forcibly to avoid mechanical damage.

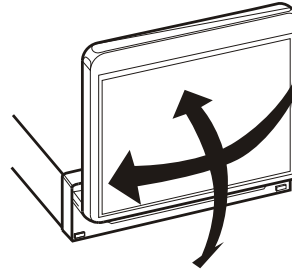

Fig.3

- Return the monitor to the central viewing position, then press **OPEN/CLOSE** button on the front panel or press **OPEN/CLOSE** button on the remote control, the monitor will turn downward automatically .

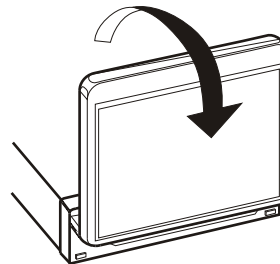

Fig.4

When the monitor turns downward to a certain angle, it will draw in.

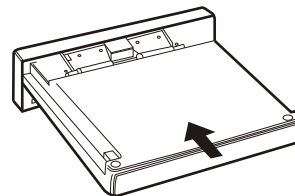

Fig.5



## OPERATION

### Remote Sensor

There is a remote sensor on the front panel. On the monitor, there is another remote sensor to receive remote control signal. You can point the remote control handset to the remote sensor on the front panel (when the monitor doesn't stretch out) or the remote sensor on the monitor panel (when the monitor stretches out) and press function keys on the remote control to control the DVD unit.

The unit is also connected to an external remote receiver (See the electrical connection diagram above), and the function is the same with the remote sensor on the front panel or on the monitor panel.

#### Notes:

- The external remote receiver is placed near the monitor for the best to receive remote signal easily.
- If the angle of the monitor from vertical exceeds  $\pm 30^\circ$  (Especially the distance exceeds 3m.), controlling the DVD unit through the remote sensor on the front panel cannot get good effect. You are suggested to use the external remote receiver

### 6.5 Inch TFT Display

When the monitor stretches out, the 6.5 inch color TFT display can show the current state of the unit.

### Volume Level Adjustment

Press **VOLUME+/-** on the monitor panel of the unit or **VOLUME +/-** on the remote control to increase or decrease the volume level.

### Mode Selection

press **MODE** button on the remote control to select among DVD, AV1, AV2 and RGB mode.

### Reset

Reset button is placed on the front panel and must be activated with either

a ballpoint pen or thin metal object. The reset button is to be activated for the following reasons:

- Initial installation of the unit when all wiring is completed.
- All the function buttons do not operate.
- Error symbol on the display.

### Picture mode Adjustment

Press **PICTURE** button on the monitor panel, the picture mode will show on the display, repeatedly press **PICTURE** button to select among BRIGHT, CONTRAST, COLOR, TINT (For the unit with NTSC system) and SCREEN.

(For the unit with NTSC system):

PICTURE	
BRIGHT	32
CONTRAST	32
COLOR	32
TINT	32
SCREEN	16:9



Press **VOLUME+/-** buttons on the monitor panel or **VOLUME+/-** buttons on the remote control to adjust the selected item. The corresponding value will show on the display.

## OPERATION

### DISC (DVD, VCD, CD, MP3) OPERATION

#### Switching to DVD mode

press **MODE** button on remote to select DVD mode.

#### Stopping Play

- Briefly press the ■ (Stop) button to stop the unit playback, when the ► (Play) button is pressed, normal playback will continue.
- Press ■ (Stop) button twice to stop the playback and go back to initial Track/Chapter.

#### Rapid Forward/Rapid Reverse

Press ►► & ◀◀ during play. Each time the button is pressed, the speed of rapid forward/reverse changes according to the disc as follow.

DVD:

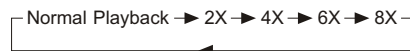

VCD/CD:

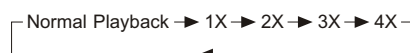

MP3:



#### Skipping Track

Press ►► / ◀◀ button on the remote control during playback.

Press ►► to skip to next track, and ◀◀ to back one track.

**Note:** For some VCD2.0 discs (PBC-playback control), ►► / ◀◀ buttons may be unavailable.

#### Slow Motion Play

Press II / ◀I during play.

Each time the button is pressed, the speed of slow forward/reverse changes according to the disc as follow.

DVD:

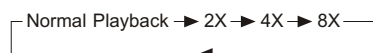

#### Pause (still picture)

Pressing II on the remote control during playback will stop play temporary. To return to normal playback, press ► on the remote control.

#### Repeat Function

FOR DVD:

Press the **REPEAT** button to select repeat mode as follow.



FOR VCD/CD:

Press the **REPEAT** button to select repeat mode as follow.



1. Continuously repeat at the current chapter/track, when selected REP-ONE mode.
2. Select REP-ALL mode to continuously repeat all chapter/track on the current disc.
3. When the player finishes playback of the current disc last chapter/track, it will stop and display the elapsed time. When REPEAT OFF mode is selected, REP-ONE & REP-ALL disappears from screen display.
4. REPEAT feature does not support VCD2.0 (with PBC ON).

#### A-B

A-B repeat allows a passage to be repeated continuously. Press **A-B** button at the start of the required passage, then press **A-B** button again at the end of the passage. To revert to normal playing, press **A-B** button again. Each time the button is pressed, the screen will display as follows:

A TO B SET A → A TO B SET B → A TO B CANCELLED

## OPERATION

### Disc Search (GOTO)

FOR DVD

Press **GOTO** button twice, the screen will display the following message:

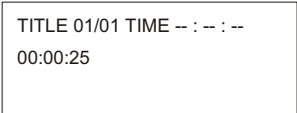

```
TITLE 01/01 TIME -- :-- :--
00:00:25
```

You can select the item you want to watch through TIME setting by using numeric buttons and ENTER key. FOR CD/VCD (WITH PBC OFF): Press **GOTO** button once, the screen will display the following message:

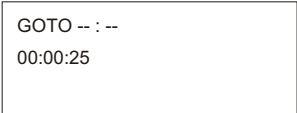

```
GOTO -- :--
00:00:25
```

Use numeric buttons to input the time directly.

### Zoom

Allows the picture to be increased in size. Press **ZOOM** to toggle among 1.5 scale, 2.0 scale and 3.0 scale.

During Zoom mode, press **▲/▼**, **◀/▶** buttons to move pictures up, down, left or right direction.

### Program

For CD/VCD (WITH PBC OFF)/DVD (WITH PBC OFF):

In stop mode, press **PROGRAM** button, the screen will display "PROGRAM P00:00" For example: press numeric button 4 "PROGRAM P01:04" appears, it means track 4 will be played first, then press numeric button 6 and "PROGRAM P02:06" appears. Press the different numeric button to select the corresponding track, and then you can program tracks to your need. If you want to complete program setting, press **▶** button or **ENTER** button to play tracks in programmed order.

For MP3:

In stop mode, press **PROGRAM** button, the screen will display "PROGRAM P00:0000" and the program method is the

same as described above. If you want to complete program setting, press **■ (Stop)** button first then press **▶** button to play tracks in programmed order. In stop mode press **PROGRAM** button to exit program mode and "PROGRAM OFF" appears. If you set WITH MENU in SMART NAV item in PREFERENCES PAGE, you can use **▲/▼**, **◀/▶** buttons to select PROGRAM PXXX mode or track number and press **ENTER** button to confirm it.

### On-Screen Display Function

Press the **DISPLAY** button during playback to display the contents of the current disc on the screen.

Example:

DVD:

(1) Press **DISPLAY** for the first time:



```
TITLE 01/03 CHAPTER 002/025
00:02:25
```

Title Number, Total Title Number, Chapter Number, Total Chapter Number of this Title of the disc currently being played will be shown on the screen, along with the elapsed time.

(2) Press **DISPLAY** for the second time:

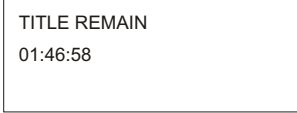

```
TITLE REMAIN
01:46:58
```

(3) Press **DISPLAY** for the third time:



```
CHAPTER ELAPSED
00:00:24
```

(4) Press **DISPLAY** for the fourth time:

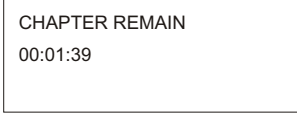

```
CHAPTER REMAIN
00:01:39
```

## OPERATION

(5) Press **DISPLAY** for the fifth time:  
The message on the screen will be cleared.

VCD:

(1) Press **DISPLAY** for the first time:

```
SINGLE ELAPSED
00:00:25
```

(2) Press **DISPLAY** for the second time:

```
SINGLE REMAIN
00:03:15
```

(3) Press **DISPLAY** for the third time:

```
TOTAL ELAPSED
00:00:25
```

(4) Press **DISPLAY** for the fourth time:

```
TOTAL REMAIN
00:40:35
```

(5) Press **DISPLAY** for the fifth time:  
The message on the screen will be cleared.

CD:

(1) Press **DISPLAY** for the first time:

```
SINGLE ELAPSED
00:00:25

TOTALTRACK : 14
TRACK : - 01
```

(2) Press **DISPLAY** for the second time:

```
SINGLE REMAIN
00:03:15

TOTALTRACK : 14
TRACK : - 01
```

(3) Press **DISPLAY** for the third time:

```
TOTAL ELAPSED
00:00:25

TOTAL TRACK : 14
TRACK : - 01
```

(4) Press **DISPLAY** for the fourth time:

```
TOTAL REMAIN
00:40:35

TOTAL TRACK : 14
TRACK : - 01
```

(5) Press **DISPLAY** for the fifth time:  
The message on the screen will be cleared.  
MP3 (When set to NO MENU in SMART NAV item):

(1) Press **DISPLAY** for the first time:

```
CHAPTER ELAPSED 00:00:25

TOTALTRACK : 123
TRACK : - 01
```

(2) Press **DISPLAY** for the second time:

```
CHAPTER REMAIN 00:04:25

TOTALTRACK : 123
TRACK : - 01
```

(3) Press **DISPLAY** for the third time:  
The message on the screen will be cleared.

Press the **DISPLAY** button during DVD, AV1, mode or AV2 mode, "DVD", "AV1" or "AV2" will appear on the screen display for about five seconds.

## OPERATION

---

### Multi-audio Language Function

#### For DVD:

Press **AUDIO** on the remote control during playback. Each time the button is pressed, the audio soundtrack language changes on sequential order.

#### Notes:

- The language number is different according to the disc.
- Some disc only contain one language soundtrack.
- When no different language soundtrack are recorded,  will be displayed at screen left top corner.

#### For VCD/CD:

Press **AUDIO** during playback. It is possible to switch the sound between monaural and stereo sound.



### MENU Function (For DVD Only)

Press **MENU** button while the disc is playing and the disc root menu will be displayed. You can navigate with the remote control navigation keys and select a feature with the **ENTER** key.

### TITLE Menu Function (For DVD only)

If the DVD has multiple titles recorded on the disc. It can select preferred title from the title menu to start playback.

- Press **TITLE** during playback. The title menu is display.
- Press the cursor button shown in screen diplay, select preferred title by the cursor button and confirm by **ENTER** key.

### Multi-subtitle Language Function (For DVD only)

Press **SUB-TITLE** during playback. Each time the button is pressed, the subtitle language changes in sequential order.

#### Notes:

- The language number is different according to the disc.

- Some discs only contain one subtitle language.
- When no different subtitle language are recorded,  will be displayed at screen left top corner.

### Multi-angle Function (For DVD only)

Press **ANGLE** during playback. Each time the button is pressed, the angle changes in sequential order

#### Notes:

- The angle number is different according to the disc.
- The function only works for discs having scenes recorded at different angles.
- When no different angle are recorded,  will be displayed at screen left top corner.

## OPERATION

### Smart navigation MP3 Disc Play

MP3 disc is playing as the format of FOLDER.

For example:

SMART NAVI	
ROOT	
CD01	MP3 001 PLUMT
CD02	MP3 002 RZID
CD03	MP3 003 ASCIS
CD04	MP3 004 DCYI
CD05	MP3 005 BFZ
PLAY MODE	DISC

In stop mode, Use ▲ / ▼, ◀ / ▶ on the remote control to select the item or folder (such as CD01, CD02...) and press **ENTER** button on the remote control to confirm, then select the desired track (such as 001 PLUMT, 002 RZID...) on the current folder to play. Pressing **REPEAT** button repeatedly can select three kinds of repeat play modes.

REP-ONE:

Play the same song over and over again.

FOLDER REP:

Play all songs in the current directory in sequence, over and over again.

FOLDER:

Play all songs in the current directory once.

When select PLAY MODE, press ▲ / ▼ to change between the following mode:

SINGLE → REP-ONE → FOLDER → FOLDER REP →

DISC SCAN → **DISC** → DISC REP → RANDOM →

SHUFFLE ON → PROGRAM PXXX

During playback, use ►► or ◀◀ to skip an item ahead or back.

◀◀ : Rapid reverse, ►► : Rapid advance

Note: The FOLDER cannot be selected during playing. It can be selected after ■ (Stop) button pressed.

### RGB OPERATION

#### Switching to RGB mode

When you connect the RGB terminals on the back of the DVD unit to the corresponding RGB system, then Press **MODE** button on remote control to select RGB mode, the RGB signal will appear on the screen.

**Note:** When you press **MODE** button to select RGB mode and there hasn't any RGB signal input, then there is nothing to display on the screen.

## SETUP

### INITIAL SETUP

SETUP MENU --- MAIN PAGE

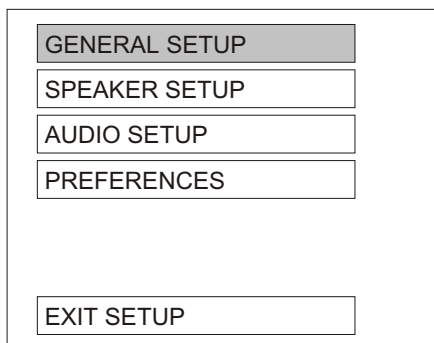

1. Press **SETUP** on the remote control in the STOP mode. (Press the **■** button twice to ensure that the player is in STOP mode.)
2. The initial SETUP menu is displayed.
3. Select the preferred item by using the **▲ / ▼** buttons.
4. Press ENTER button.
  - a. **GENERAL SETUP**  
This setup page includes all the item of TV display & Audio output feature. For details please refer to **GENERAL SETUP MENU**.
  - b. **SPEAKER SETUP**  
This is to activate the audio output from DOLBY AC3 5.1 DOWNMIX to 2 channel mode. Please refer to **SPEAKER SETUP MENU**.
  - c. **AUDIO SETUP**  
This setup page includes all the items for AUDIO. Please refer to **AUDIO SETUP MENU**.
  - d. **PREFERENCES SETUP**  
This setup page includes all the configuration of support feature For details please refer to **PREFERENCES SETUP MENU**.

### GENERAL SETUP

--- GENERAL PAGE ---

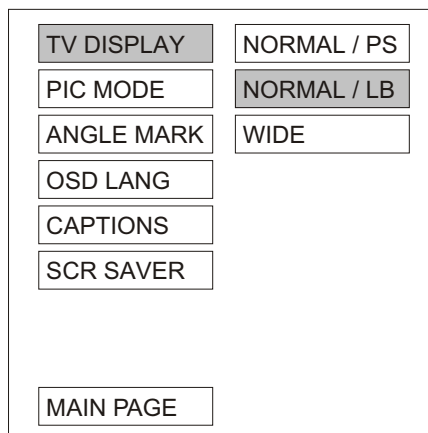

Video Material	TV Screen			
	4:3			Wide (16:9)
	Normal	Pan Scan	Letterbox	
4:3				
16:9				

#### TV display setup

This is to select the appropriate TV aspect ratio (4:3 or 16:9) according to the connected TV set.

#### Normal/PS (For 4:3 TV)

Played back in the PAN & SCAN style. (If connected to wide-screen TV, the left and right edges are cut off.)

#### Normal/LB (For 4:3 TV)

Played back in letterbox style. (If connected to wide-screen TV, black bands appear at top and bottom of the screen.)

#### Wide (For 16:9 TV)

Select when a wide-screen TV set is connected.

## SETUP

--- GENERAL PAGE ---

TV DISPLAY	
PIC MODE	AUTO
ANGLE MARK	HI-RES
OSD LANG	N-FLICKER
CAPTIONS	
SCR SAVER	
MAIN PAGE	

### PIC mode setup

Select AUTO, the player PIC mode will depend on DVD disc.  
Select HI-RES format for best image resolution.  
Select N-FLICKER format on image or picture with noise or distortion.

--- GENERAL PAGE ---

TV DISPLAY	
PIC MODE	
ANGLE MARK	
OSD LANG	ENGLISH
CAPTIONS	FRENCH
SCR SAVER	GERMAN
	SPANISH
MAIN PAGE	

### OSD LANG type setup

Select the preferred OSD (On Screen Display) language by using the ▲ / ▼ buttons.

--- GENERAL PAGE ---

TV DISPLAY	
PIC MODE	
ANGLE MARK	ON
OSD LANG	OFF
CAPTIONS	
SCR SAVER	
MAIN PAGE	

### ANGLE MARK display setup

If it is set to ON, when the multi-angle DVD disc is playing, "∞" (the angle mark) will appear on the screen; if it is set to "OFF" the mark will not appear.

--- GENERAL PAGE ---

TV DISPLAY	
PIC MODE	
ANGLE MARK	
OSD LANG	
CAPTIONS	ON
SCR SAVER	OFF
MAIN PAGE	

### CAPTIONS setup

When play DVD disc, activate the CAPTIONS feature by selecting ON and the captions (such as the actor dialogue) appear on the screen; deactivate this feature by selecting OFF and the captions will not appear.



## SETUP

--- GENERAL PAGE ---

TY DISPLAY	
PIC MODE	
ANGLE MARK	
OSD LANG	
CAPTIONS	
SCR SAVER	ON
	OFF
MAIN PAGE	

### SCR SAVER setup

Select the SCR SAVER ON/OFF.

### SPEAKER SETUP

--- SPEAKER SETUP PAGE ---

DOWNMIX	LT/RT
	STEREO
MAIN PAGE	

This is to activate the audio output from DOLBY AC3 5.1 DOWNMIX to 2 channel mode. Select the preferred SPEAKER connection by using the cursor buttons.

- Select the LT/RT to activate the Dolby surround compatible output.
- Select the STEREO to activate simple stereo mode.

### AUDIO SETUP

--- AUDIO SETUP ---

AUDIO OUT	ANALOG
OP MODE	SPDIF/RAW
DYNAMIC	SPDIF/PCM
LPCM OUTPUT	
MAIN PAGE	

### AUDIO OUT

- Select ANALOG mode to activate analog audio output.
- Select SPDIF/RAW mode to activate raw digital audio output. And the digital audio format depends on the disc record format.
- Select SPDIF/PCM mode to activate PCM digital audio output.

--- AUDIO SETUP ---

AUDIO OUT	
OP MODE	LINE OUT
DYNAMIC	RF REMOD
LPCM	
MAIN PAGE	

### OP MODE

- LINE OUT: Line out mode, with digital dialog normalization.
  - RF REMOD: RF remodulation mode, with heavy compression and digital dialog normalization.
- It is recommended to select LINE OUT mode.

## SETUP

### --- AUDIO SETUP ---

AUDIO OUT											
OP MODE											
<b>DYNAMIC</b>											
LPCM OUTPUT											
	<table border="1"> <tr> <td>┌───┐</td> <td>FULL</td> </tr> <tr> <td>├───┤</td> <td>6/8</td> </tr> <tr> <td>├───┤</td> <td>4/8</td> </tr> <tr> <td>├───┤</td> <td>2/8</td> </tr> <tr> <td>└───┘</td> <td>OFF</td> </tr> </table>	┌───┐	FULL	├───┤	6/8	├───┤	4/8	├───┤	2/8	└───┘	OFF
┌───┐	FULL										
├───┤	6/8										
├───┤	4/8										
├───┤	2/8										
└───┘	OFF										
MAIN PAGE											

#### Dynamic Range Control

Select DYNAMIC and adjust the dynamic range of a Dobby Digital encoded program. There are 8 steps between full compression and off compression.

### --- AUDIO SETUP ---

AUDIO OUT			
OP MODE			
DYNAMIC			
<b>LPCM OUTPUT</b>	<table border="1"> <tr> <td>LPCM 48K</td> </tr> <tr> <td><b>LPCM 96K</b></td> </tr> </table>	LPCM 48K	<b>LPCM 96K</b>
LPCM 48K			
<b>LPCM 96K</b>			
MAIN PAGE			

#### LPCM OUTPUT

Select the LPCM (Line Pause Code Modulation) OUTPUT between LPCM 48K and LPCM 96K. The higher the sampling frequency is, the better the output audio quality is. It is recommended to select LPCM 96K

### PREFERENCES SETUP

#### --- PREFERENCES PAGE ---

<b>TV TYPE</b>	<b>AUTO</b>
AUDIO	NTSC
SUBTITLE	PAL
DISC MENU	
PARENTAL	
PASSWORD	
DEFAULTS	
SMART NAV	
MAIN PAGE	

#### TV type setup

This player can play discs recorded in either NTSC format.

Select NTSC format, when the unit is connected to NTSC TV.

Select AUTO format, the player TV output format will be according to the DVD disc format.

#### --- PREFERENCES PAGE ---

TV TYPE	
<b>AUDIO</b>	<b>ENGLISH</b>
SUBTITLE	FRENCH
DISC MENU	SPANISH
PARENTAL	CHINESE
PASSWORD	JAPANESE
DEFAULTS	GERMAN
SMART NAV	
MAIN PAGE	

#### AUDIO language setup

Select the preferred AUDIO soundtrack by using the cursor buttons.

## SETUP

--- PREFERENCES PAGE ---

TV TYPE	
AUDIO	ENGLISH
SUBTITLE	FRENCH
DISC MENU	SPANISH
PARENTAL	CHINESE
PASSWORD	JAPANESE
DEFAULTS	GERMAN
SMART NAV	OFF
MAIN PAGE	

### SUBTITLE language setup

Select the preferred SUBTITLE language by using the cursor buttons.

--- PREFERENCES PAGE ---

TV TYPE	1 G
AUDIO	2
SUBTITLE	3 PG
DISC MENU	4 PG 13
PARENTAL	5
PASSWORD	6 PG-R
DEFAULTS	7 NC-17
SMART NAV	8 ADULT
MAIN PAGE	NO_PARENTAL

### PARENTAL

Select suitable parental guidance by the cursor buttons and confirm by pressing ENTER button.

--- PREFERENCES PAGE ---

TV TYPE	
AUDIO	
SUBTITLE	
DISC MENU	ENGLISH
PARENTAL	FRENCH
PASSWORD	SPANISH
DEFAULTS	CHINESE
SMART NAV	JAPANESE
MAIN PAGE	GERMAN

### DISC MENU language setup

Select the preferred DISC MENU language by using the cursor buttons.

--- PREFERENCES PAGE ---

TV TYPE	
AUDIO	
SUBTITLE	
DISC MENU	
PARENTAL	
PASSWORD	CHANGE
DEFAULTS	
SMART NAV	
MAIN PAGE	

### PASSWORD

Select CHANGE and press ENTER button. Type the old password (The initial factory code is 3308) and key in 4 characters password now you want to use, and retype again to confirm key in correctly.

## SETUP

--- PREFERENCES PAGE ---

TV TYPE	
AUDIO	
SUBTITLE	
DISC MENU	
PARENTAL	
PASSWORD	
DEFAULTS	RESET
SMART NAV	
MAIN PAGE	

### DEFAULTS

Select reset to revert to factory initial settings.

--- PREFERENCES PAGE ---

TV TYPE	
AUDIO	
SUBTITLE	
DISC MENU	
PARENTAL	
PASSWORD	
DEFAULTS	NO MENU
SMART NAV	WITH MENU
MAIN PAGE	

### SMART NAV

If select WITH MENU mode, when play a MP3 disc, the smart navigation menu will appear on the screen, then the user can select a track to play according to the menu hint.

If select NO MENU mode, when play a MP3 disc, there is no menu to display and it starts to play directly.

The user can adjust this item according to one's need.

## SETUP

---

**DEFAULTS TABLE**

General Setup	TV Display	Normal/LB
	PIC Mode	AUTO
	Angle Mark	ON
	OSD Language	English
	Captions	ON
	SCR Saver	ON
Speaker Setup	Downmix	Stereo
Audio Setup	Audio Out	SPDIF/RAW
	OP Mode	Line Out
	Dynamic	FULL
	LPCM Output	LPCM 96K
Preferences	TV Type	AUTO
	Audio	English
	Subtitle	English
	DISC Menu	English
	Parental	NO_Parental
	Password	3308
	Smart NAV	With Menu

## TROUBLE SHOOTING

---

If it appears that your DVD unit is faulty, first consult this checklist. It may be that something simple has been overlooked.

**Under no circumstances should you try to repair the player yourself, as this will invalidate the warranty. Only qualified service personnel can remove the cover or service this player.**

### NO POWER

- Check if the on/off button on the front of the player is set to on.
- Check if AC or DC power plug of the mains unit is properly connected.
- Check if there is power at the AC or DC outlet.

### NO PICTURE

- Check if the mode is set to proper state, such as DVD mode, AV1 mode, AV2 mode and RGB mode.
- Check the video connection.

### DISTORTED PICTURE

- Check the disc for fingerprints and clean with soft cloth, wiping from centre to edge.
- Sometimes a small amount of picture distortion may appear. This is not a malfunction.

### THE PICTURE IS OVER DARK, OVER BRIGHT OR HAS NO COLOR

- Press **PICTURE** button on the monitor panel, then press **VOLUME+** button **VOLUME-** button to increase or decrease the level of the corresponding item (BRIGHT, CONTRAST, COLOR or TINT) to proper value, then you can get an optimum picture effect.

### COMPLETELY DISTORTED PICTURE

- The disc format is not according to the TV-set used (NTSC).

### NO COLOR IN PICTURE

- The disc format is not according to the TV-set used (NTSC).

### DISC DOES NOT PLAY

- Ensure the disc label is upwards.
- Clean the disc.
- Check if the disc is defective by trying another disc.

### NO SOUND

- Check audio connections.
- If using a HIFI amplifier, try another sound source.
- Check if the volume is minimum, and adjust the **VOLUME+** to increase the volume level.

### DISTORTED SOUND FROM HIFI AMPLIFIER

- Check to make sure that no audio connections are made to the amplifier phono input.

### NO RETURN TO START-UP SCREEN WHEN DISC IS REMOVED

- Press **POWER** to turn off the unit, then press it again to turn on the unit.
- Press reset button on the front of the DVD unit.

### THE PLAYER DOES NOT RESPOND TO THE REMOTE CONTROL

- Aim the remote control directly at the sensor on the front of the player.
- Avoid all obstacles which may interfere with the signal path.
- Inspect or replace the remote control batteries.

### DISTORTED OR B/W PICTURE

- The disc format is not according to the TV-set used (NTSC).

### NO AUDIO AT DIGITAL OUTPUT

- Check the digital connections.
- Check the Digital Audio menu to make sure that the digital output is correctly set.

## **TROUBLE SHOOTING**

---

- Check if the audio format of the selected audio language matches your receiver's capabilities.

### **BUTTONS DO NOT WORK**

- Turn the player off and on with the power on/off button on the front of the player.
- Press Reset button on the front of the DVD unit.

## SPECIFICATIONS

---

### DVD

Supply voltage	: 12V DC (11V-15V), test voltage 14.4V, negative ground
Current consumption	: Less than 2A
Signal system	: Compositive video 1.0Vp-p 75 $\Omega$
Discs played	: (1) DVD-VIDEO disc 5" (12 cm) single-sided, single-layer 5" (12 cm) single-sided, double-layer (2) Compact disc (CD-DA/CD-R/CD-RW/MP3) (3) 5" (12 cm) Video CD
Audio output level	: 10k $\Omega$ (2 ch 2.0 Vrms)
Audio signal output characteristics	: (1) Frequency response 20 Hz-20 kHz (2) S/N ratio 80 dB (JIS) (3) Wow and Flutter Below measurable limits
Monitor Screen Size	: 6.5"TFT
Resolution	: 1440x234 dots

### Note:

Specifications and design are subject to modification, without notice, due to improvements in technology.

**This product incorporates copyright protection technology that is protected by method claims of certain U.S. patents and other intellectual property rights owned by Macrovision Corporation and other rights owners. Use of this copyright protection technology must be authorized by Macrovision Corporation, and is intended for home and other limited viewing uses only unless otherwise authorized by Macrovision Corporation. Reverse engineering or disassembly is prohibited.**



**[www.pyleaudio.com](http://www.pyleaudio.com)**

88-V1952-02

## Free Manuals Download Website

<http://myh66.com>

<http://usermanuals.us>

<http://www.somanuals.com>

<http://www.4manuals.cc>

<http://www.manual-lib.com>

<http://www.404manual.com>

<http://www.luxmanual.com>

<http://aubethermostatmanual.com>

Golf course search by state

<http://golfingnear.com>

Email search by domain

<http://emailbydomain.com>

Auto manuals search

<http://auto.somanuals.com>

TV manuals search

<http://tv.somanuals.com>