

DVD Player Operating Instructions

PLDVMP4



NOTES: Any change to the design and specifications will not be advised.

Before attempting to connect,
or operating this product.
Please read the instructions completely

The design and manufacture of this product takes personal safety in to consideration. However, any improper operation may result in personal injury, electric shock, fire and other hazard. So please adhere to following precautions.

Operating precautions

The vehicle headrest is an integral part of a vehicle's passenger safety system. Always adjust the headrest height and position for the optimum safety and comfort of the front seat occupants, as per the vehicle manufacturer's instructions, before you install your unit.

The unit carry Case is designed to be attached to the rear of two forward facing adjacent seats. For safety it is recommended that the unit carry case is strapped securely in place and comes with a comprehensive securing strap system for this purpose. Please refer to page 5.

It is also recommended that the lower section of the unit Carry Case is zipped half way up the carry bag when access is not required, the player can be controlled by directing the Remote Control towards the Screen.

Legal

The law states that the Screen must NOT be visible by the driver, whilst the vehicle is moving. The Screen is NOT intended for use in the front of the vehicle where the driver may see it.

Installation of the equipment into a portion of the vehicle that could impair or distract the driver is improper and dangerous.

Safety precautions

To prevent the risk of electric shock do not remove the cover or back of the components within the unit product. No user serviceable parts inside, refer servicing to qualified service personnel.

To prevent fire or shock hazard, do not expose his appliance to rain, moisture or liquid of any kind.

1、 **DVD features** ----- 1

2、 **Names of parts** ----- 2

 2.1 Frontal panel ----- 2

 2.2 Rear panel ----- 2

 2.3 Remote control ----- 3

3、 **Preparation before operation** ----- 4

 3.1 Unpacking and check ----- 4

 3.2 Assembling batteries of remote control ----- 4

 3.3 Connections ----- 5

4、 **Basic operations** ----- 8

 • Play ----- 9

 • Mute ----- 9

 • Stop playing EJECT ----- 9

 • The use of remote sensor ----- 9

5、 **Frequent operations** ----- 10

 • Select part to be played with menu ----- 10

 • Play fast forward ----- 10

 • Play fast backward ----- 11

 • Slowplay ----- 11

 • Skip to next chapter/track ----- 11

 • Skip to previous chapter/track ----- 11

 • Select track ----- 11

 • Repeat play ----- 12

 • Select subtitle Language ----- 12

 • Program play ----- 12

6、 **System setting** ----- 13

 Using the on-screen info display ----- 13

 DVD disc info display ----- 13

 MP4 disc info display ----- 13

 Audio CD info display ----- 13

 Video display ----- 13

 Video disc info display ----- 13

 Selecting a title ----- 14

 Selecting a chapter ----- 14

 Selecting subtitle ----- 14

 Changing the audio language ----- 15

 Using the repeat feature ----- 15

Repeating titles chapters repeat AB or tracks	16
AB repeat	16
Using the bookmark feature	16
Creating a bookmark	17
Using a bookmark	17
Clearing a bookmark	17
Changing the camera angle	18
Random	18
VCD playback control	19
Playing MP4 disc	19
Viewing JPEG files	20
Slide show	21
Creating a bookmark	22
Path items	22
Play mode menu	22
Random play	23
The lock menu	23
Locking your DVD player	24
Changing your password	25
The display menu	26
TV system	27
The sound menu	28
Digital output	28
Languages menu	29
Audio	30
Subtitles	30
7、 Remote control functions	31
8、 Technical terms	35
9、 Troubleshooting	35
10、 Specification	36

1. DVD features

It provides this multi-media disc player high-resolution image with, high-quality sound and surround sound effect. The DVD player can play not only DVD discs of various versions, but also MP4, VCD, SUPER-VCD, DVCD, CD, MP3, etc.

Features

1. It is compatible to DVD, MP4, VCD, SUPER-VCD, DVCD, CD, MP3, etc.
2. Multi language onscreen menu.
3. High quality image with over 500 lines horizontal resolution.

Other features

1. Dts digital output, provides high-fidelity stereo interface.
2. Multi-language support. DVD supports up to 32-language caption and 8-language dub.
3. Multi-angle. The user can select different angle at their option to watch, e.g. closer angle, full view, etc.
4. Multi-image ratio. multi-image ratio mode enables the product to match different types of TV screen.

Resume

There are 2 options to resume the playback:

1. When you play discs, the first press of Stop button goes to the Resume play. You can press Play button to play the last point you stop.
2. When you load DVD disc that was viewed on the player and Open the tray, the player remembers the last point when playback was stopped. As soon as the player reads the disc, the player will start to play the last point when you stop.

2. Names of parts

2.1 Front panel

- 1.POWER ON/OFF
- 2.DISK TRAY
- 3.OPEN/CLOSE
- 4.PAUSE/PLAY
- 5.STOP
- 6.PHONE

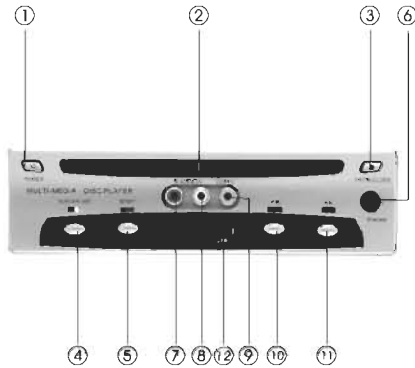

- 7.AUDIO R
- 8.AUDIO L
- 9.VIDEO
- 10.BACKWARD
- 11.FORWARD
- 12.USB INPUT

2.2 Rear panel

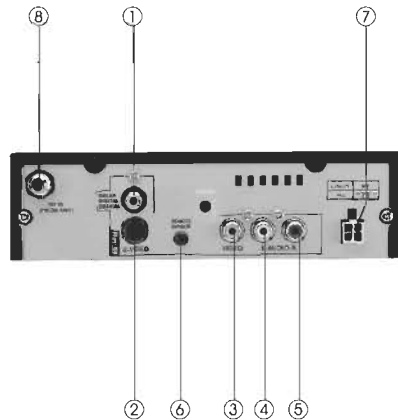

- 1.COAXIAL
- 2.S-VIDEO
- 3.VIDEO
- 4.AUDIO L
- 5.AUDIO R
- 6.REMOTE SENSOR INPUT
- 7.POWER
- 8.RF IN

NOTE:

THE ⑧ (RF IN) TERMINAL USED ONLY DVD WITH TV TUNER MODEL.

2.3 Remote control

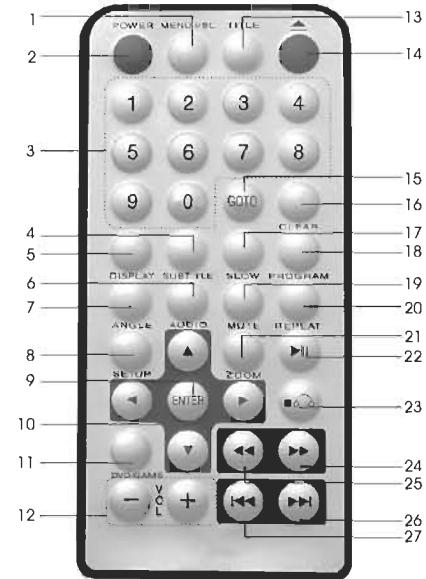









- | | |
|---------------------------|---------------|
| 1.MENU PBC | 14.EJECT |
| 2.POWER | 15.GOTO |
| 3.NUMBER | 16.CLEAR |
| 4.SUBTITLE | 17.SLOW |
| 5.DISPLAY | 18.PROGRAM |
| 6.AUDIO | 19.MUTE |
| 7.ANGLE | 20.REPEAT |
| 8.SETUP | 21.ZOOM |
| 9.ENTER/SELECT | 22.PLAY PAUSE |
| 10.DIRECTION KEYS | 23.STOP |
| 11.DVD/GAME(DVD/TV/ GAME) | 24.FORWARD |
| 12.VOLUME | 25.BACKWARD |
| 13.TITLE | 26.NEXT |
| | 27.PREVIOUS |

3. Preparation before operation

3.1 Unpacking and check

Check for the following Accessories:

-  Remote control 1
-  choke 1
-  Hanger 2
-  Screw
-  Battery 2
-  Audio/Video cord
-  Owner's manual 1
-  Remote sensor

3.2 Assembling batteries of remote control

Open battery compartment, Insert two 7#A batteries, make sure to match "+" and "-" of the batteries to the marks in the battery compartment. While operating remote control, please point it to the frontal panel of the DVD player.



3.3 Connections

The video signal is output through s-video or video output terminal, while audio signal is output by mixing channel terminal, coaxial terminal, dts signal is only output through or coaxial terminal. There are many solutions to connect TV and this product, user can select one according to the condition of the apparatus to be connected. However, be aware to shut off all power prior connection.

DVD+TV

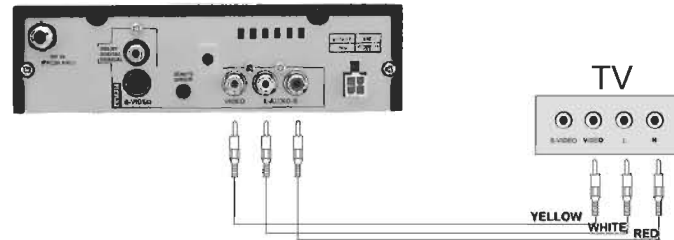

S-video terminal

Plug one end of S-video cable into S-VIDEO socket in back panel of the product, the other end into TV S-VIDEO socket, then connect audio cable to TV (notes:do not connect video cable) . See diagram blow.

DVD player+TV

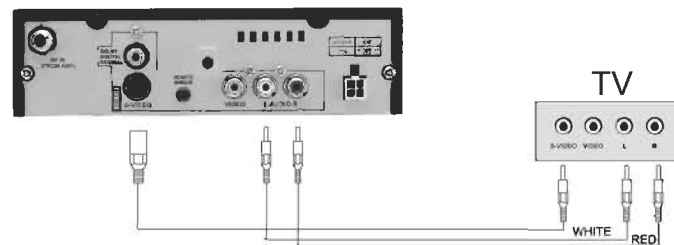

Preparation before operation

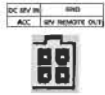

When you turn off the car's power supply by key (ACC), the unit will be turn off and can remember the latest picture. When you turn on the IGNITION SWITCH again and play DVD, the unit will play from the memory point.

When you turn off the car's power supply by key (ACC), and want to take away the disc, you can turn on the unit's power supply by push [POWER] on the unit or remote control, and take away disc, then turn off the unit's power supply. If you forget turning off the unit's power supply, the unit can turn off automatically after 30second.

12V remote out

It provides the power of DC 12V/0.5A when power of the product is on. If you turn off power of the product, it will have no output.

Note:

It is recommended to connect to car battery.

DVD+AC

Power connection drawing while operating in room
Connect AC adaptor to +12V input

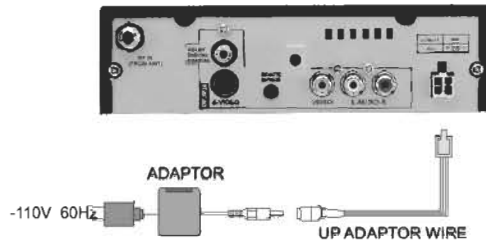

DVD+CHOKE

Power connection for automotive application

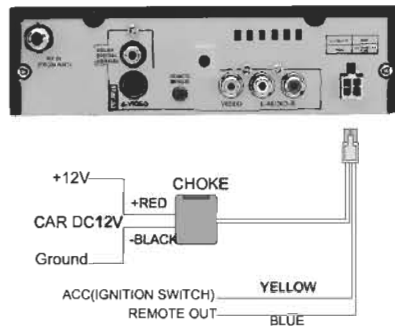

Preparation before operation

DVD+AMP

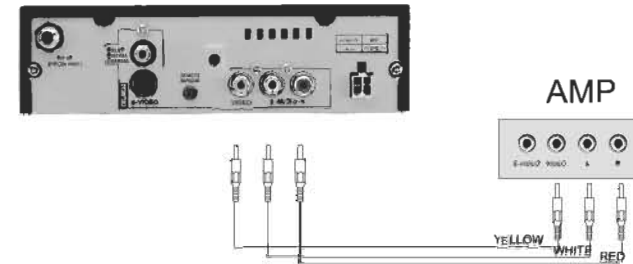

DVD WITH TV TUNER + ANTENNA (THIS CONNECTED ONLY USE IN DVD WITH TV TUNER MODEL)



4. Basic operation

If you have connected the product to TV, all power lines have been plugged into receptacles, and loaded the batteries into remote control, so you can play the player.

- Turn on TV power
- If you have connected amplifier, you should also turn it on, and select proper amplifier mode according to the type of discs to be played.

Play

1. Push [POWER] in the player.

- Control TV remote control to shift TV to proper video input mode (VIDEO IN).

2. Push open/close eject player or [EJECT] buttons on the remote control to the tray.

- Load a disc in the tray, with label side upward (see following figure), place single disc in the tray,

3. Push [▶II] PLAY/PAUSE

- The player will close the tray automatically and begin to read it, It can identify different disc format then display it on the screen of DVD frontal panel, afterwards if automatically plays disc, If directory or menu picture display in the screen, you can push the direction buttons [UP], [DOWN], [LEFT] and [RIGHT] buttons in the remote control to move lighting band to desired track, You can directly push number buttons to select track.

While playing push [▶II] to pause the

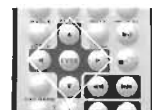

playback, push [▶II] again to resume play

Mute (available to analog audio output Signal only)

Push [MUTE] to silence the sound of the player, press it again to return to normal state.

Stop playing EJECT

1. Push [EJECT]

- unload the disc until the tray is ejected. After stopping playing, unload the disc until the tray is ejected.

2. Push [EJECT] to close the tray

3. Press [POWER] to turn off the player.

- Then turn off power of all connected equipment.

The use of REMOTE SENSOR

If you want to put the DVD player in where you can not see, please insert REMOTE SENSOR in the REMOTE SENSOR INPUT, and put REMOTE SENSOR on where you can see in automobile, you can control the DVD player so long as let REMOTE CONTROL toward REMOTE SENSOR.

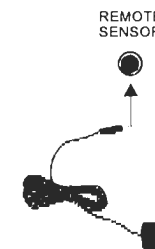

Attention:

① While playing if you find the picture is not shown in full screen or some part hidden or black and white image occur, you need to the system, please select right TV system (PAL or NTSC). Please refer to instructions of [SYSTEM] IN CHAPTER 6 or examples in chapter 6.

② When the symbol shows in TV screen, it signifies invalid operation or your operation is not accepted by the player.

5. Frequent operation

We will introduce some regular operations of different types of function, the user can perform one or more operations as you like, In addition chapter 7 details purposes and operations of all buttons

Select part to be played with menu

If DVD disc to be played has menu, when PBC state is on you can display the menu by pushing [MENU/PBC] or [TITLE], whereon you select a popular part to play. you can operate following procedures

1. Push [MENU/PBC]

The screen display menu picture, the content to be selected varies with different disc.

2. Push [UP], [DOWN], [LEFT], [RIGHT]

Move the lighting band to the desired item or Made by pushing these buttons

3. Push [ENTER] to confirm selecting the item

This moment the screen may display a submenu. You can also push [UP], [DOWN], [LEFT], [RIGHT] to confirm selecting the push [ENTER] to confirm the selection

Play fast forward

While playing you can push [FF] button to play fast forward. Four speed are available to play forward, press it once the speed grows by one shift, when the speed reaches maximum speed, press [FF] again to return to normal state.

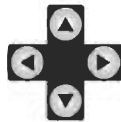
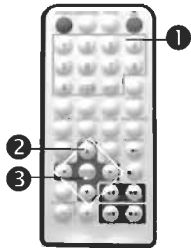

Play fast backward

While playing you can push [FB] button to play fast backward. Four speed are available to play backward, press it once the speed grows by one shift, when the speed reaches maximum speed, press [FB] again to return to normal state.

Slow play

While playing push [SLOW] to play slowly at different speed. You can play slow forward or backward, three shift speed are available for either of them. Push [SLOW] once, press it once the speed decreases by one shift, finally it returns to normal state.

Skip to next chapter/track

While playing push [NEXT] button.

Skip to previous chapter/track

While playing push [PREV] button.

Select track

There are more than one operation procedure available

A. Push [NEXT] or [PREV] to skip to the next or the previous track and play.

B. For those discs with track numbered directly push number buttons to enter the No. of desired track to play. If the moment the screen displays ①, so there may be three possible reasons: (1) the track in the disc is not numbered; (2) the number entered beyond the scope; (3) PBC is on (push [PBC] to shift PBC state);

C. Select among the song track list (refer to the next chapter).

Repeat play

While playing you can push [REPEAT] to select different repeat content.





Select subtitle Language (subject the Type of disc)

For DVD disc, you can push [SUBTITLE] to select the language of caption.e.g. English. Press it once, the screen will display available language alternatively.

Program play (subject to the type of Disc)

When PBC is off, in the stopping state:

1. Push [PROGRAM]

The screen display following figure, programming operation is available.

6. System setting

Using the On-Screen Info Display

The on-screen Info Display contains many playback features. To see the Info Display, press the INFO button on the remote while a disc is playing (the Info Display appears across the top of the screen). Each feature is illustrated with an icon. Use the left and right arrow buttons to move through the different icons in the Info Display. When an icon is highlighted, use the up and down arrow buttons on the remote to scroll through the choices displayed in the text box under the icons. You can only access the Info Display when you're playing a disc. Also, the Info Display features are only available if the disc was created with that particular feature. If one of the icons is "grayed out," the Info Display feature isn't available for the disc you're playing. The invalid symbol appears on the screen when you press a button that doesn't have any function. To make the Info Display disappear from the screen, press INFO on the remote.



DVD Disc Info Display

Title Chapter Subtitle Audip Repeat Bookmark Angle Time display



any function. To make the Info Display disappear from the screen, press INFO on the remote.

MP4 Disc Info Display

File Track Subtitle Audip Repeat Time display



Audio CD Info Display

Track Play mode Time Display



Video Disc Info Display

Track Playback Audio Repeat Time Display





Selecting a Title

Some discs contain more than one title. Each title is divided into chapters. To select a title:

1. While the disc is playing, press INFO on the remote (the Info Display appears).
2. If the Title icon on the Info Display isn't highlighted, press the right/left arrow buttons to highlight it.
3. Use the number button(s) on the remote to enter the title number or press the up/down arrow buttons to go to the next or previous title. Note: Some discs only have one title.



Selecting a Chapter

A title can be divided into individual chapters (similar to tracks on a CD). To skip to a specific chapter:

1. While a disc is playing, press INFO on the remote (the Info Display appears).
2. Press the right arrow button until the chapter icon is highlighted.
3. Press the number button(s) on the remote to enter the chapter you want to play enter 2 digits (for example, to go to chapter 4, press 0 and then press 4). The movie starts playing at the beginning of the chapter you entered. Note: The Chapter feature won't work if the disc isn't formatted with separate chapters.



Selecting Subtitle

By default, subtitles are off. To turn subtitles on:

1. While a disc is playing, press INFO (the Info Display appears).
2. Press the right arrow button until the Subtitle icon is highlighted.
3. Press SUBTITLE to turn on subtitles (the subtitles appear at the bottom of the screen)
4. To change the subtitle language, press the up or down arrow button repeatedly to see what subtitle languages are available (the subtitle language options appear in the box at the bottom of the Info Display).
5. To turn subtitles off, press the SUBTITLE button again.

Notes: Changing the subtitle language with the Info Display will only affect the disc you are currently playing. When the disc is removed or the player is turned off, the subtitle language will revert to the language setting specified through the DVD player's main menu. If the disc

doesn't contain the language you want to use, the disc's default language is automatically selected. Some discs are programmed to only allow you to access the subtitle feature through the disc's menu.

Changing the Audio Language

If the disc was created with different language tracks (recorded in different languages), you can change the language while you're playing the disc.

1. While a disc is playing, press INFO (the info display appears).
2. Press the right arrow button until the Audio icon is highlighted.
3. Press the down arrow button on the remote to scroll through the available audio languages.
4. When the language you want to use is highlighted, press the OK button (the dialog plays in the language you selected).

Notes:

The language feature only works if the disc was created with multiple language tracks. If the disc doesn't contain the language you selected, the disc will play in the default language. When you choose an audio language during disc playback, you only override the audio language setting in the DVD player's main menu temporarily. The audio language can also be changed through the DVD player menu.

Using the Repeat Feature

By default Repeat feature is Off. There are three Repeat options:

- Title repeats the title that is playing
- Chapter repeats the chapter that is playing
- A-B repeats a segment of the disc that you select.

You can select the Repeat Feature by pressing Repeat button to switch between the Title Repeat, Chapter Repeat, A-B repeat or turn the Repeat off.



REPEAT

Repeating Titles, Chapters, Repeat AB or Tracks

1. While a disc is playing, press INFO (the Info Display appears).
2. Press the right arrow button until the Repeat icon is highlighted.
3. Press the up or down arrow button to scroll through the different Repeat options Repeat title, Repeat chapter, Repeat AB, and Repeat off (the modes will appear at the bottom of the Info Display).
4. To turn off the Repeat feature, press the up or down arrow button repeatedly until Repeat Mode: Off appears.

AB Repeat

AB Repeat lets you define a specific segment on the disc that you want to repeat. To watch a scene over and over:

1. Follow steps 1 and 2 above.
2. Use the arrow buttons to get Repeat Mode: AB. Press Enter to set A point appears at the bottom of the Info Display. Press Enter when the disc gets to the beginning point of the segment (the A point) that you want to repeat.
3. Allow the disc to play to the end of the segment you want to repeat. Don't fast forward the disc has to play in standard playback mode to set the B point (the end point of the segment). Press Enter to set the B point (the segment will play repeatedly until you turn off the Repeat feature).
4. To turn off the Repeat feature, highlight the Repeat icon, and press the up arrow button on the remote until Repeat Mode: Off appears at the bottom of the Info Display.

Note: Repeat is also cancelled when you eject the disc from the player.

Using the Bookmark Feature

The Bookmark feature lets you mark a point on the disc so that when you turn the player off and back on (without having ejected the disc), you can quickly start playing the disc from a bookmarked point. There are 6 bookmarks.



This is the Bookmark Banner. The disc with two arrows represents an available bookmark. Select the arrow icon to start playback from the bookmarked place on the disc. Select the trashcan icon to delete the bookmark. The icon that shows a disc with two arrows represents an available bookmark.

Creating a Bookmark

1. Highlight the Bookmark icon on the Info Display. Press Enter (the Bookmark Banner appears).
2. Highlight an unused bookmark. When the disc reaches the scene you want to mark, press the OK button on the remote (the bookmark icon changes to two icons side-by-side: an arrow and a trash can). To play the disc from the bookmarked scene, highlight the arrow and press the OK button. To delete the bookmark, highlight the trash can and press Enter.
3. To remove the Info Display and/or Bookmark Banner, press the INFO button on the remote.

Using a Bookmark

1. While you're playing a disc, press the INFO button on the remote (the Info Display appears).
2. Press the right arrow button to highlight the Bookmark icon, and press Enter (the Bookmark Banner appears).
3. Use the arrow buttons on the remote to highlight the play arrow icon that's next to the bookmarked scene you want to activate.
4. Press Enter (the disc starts playing from the bookmarked scene).

Clearing a Bookmark

The bookmarks are erased each time you remove a disc from the player and/or when the power is turned off.

1. While you're playing a disc, press the INFO button on the remote (the Info Display appears).
2. Press the right arrow button to highlight the Bookmark icon, and press Enter (the Bookmark Banner appears).
3. Use the arrow buttons on the remote to highlight the trashcan icon that's next to the bookmarked scene you want to delete, and press Enter (the bookmark is cleared, and the trashcan icon changes back to an unused bookmark icon).



Trash Can



Unused Bookmark Icon



Changing the Camera Angle

Some discs contain multiple angles of a particular scene or sequence. If the disc only has one angle, this feature won't work. Currently, very few discs have this feature.

1. While a disc is playing, press ANGLE on the remote. If the disc wasn't created with multiple angles, (the invalid symbol) appears. If the disc contains multiple angles, the Angle icon appears with the current angle number and the number of angles available. For example, 1/4 indicates that Angle 1 is displayed and there are 4 different angles available.
2. Press the ANGLE button again to go to the second camera angle. Press ANGLE again to go to the third angle, etc.
3. To resume normal playback, scroll through the camera angles until you get to Angle Off.

Using the Play Mode Feature

Play Modes are available from the Info Display when you're playing an audio CD. The Play Mode feature lets you set up the order in which you want the tracks on the CD to play. There are three Play Modes:

Standard: the tracks play in the same order as listed on the CD (starting with track 1). This is the default play mode.

Random: the tracks on the CD play in a random order.

Program: the tracks play in the order you designate. To use the Program play mode, you must set up the order in which you want the tracks to play in the DVD player's main menu system.

Random

1. While you're playing a disc, press INFO (the Info Display appears).
2. Press the left or right arrow button to highlight the Play Mode icon.
3. Press the down arrow button until Play Mode: Random appears at the bottom of the Info Display (the tracks start playing in random order). To switch back to Standard Playback, follow steps 1 through 3 above until Play Mode: Standard appears underneath the Info Display icons.

Note: The player defaults to Standard Playback whenever you put a new CD into the DVD player.

Program

The Program Play Mode is only available after you set up a program. You must create your program (playlist) in the Edit Program menu before you can access the Program Play menu. (Please refer to Page 23)

VCD Playback Control

This function is only available for Video-CD version 2.0 or higher. The PBC operation may differ by disc, therefore, refer to the instructions for each disc.

1. While you're playing a disc, press INFO (the Info Display appears).
2. Press the left or right arrow button to highlight the Play Mode icon.
3. Press the down arrow button to switch between PBC on and PBC off.

Playing MP4 Disc

The MP4 Display



Start MP4 Playback and Select Files

1. select the file that you want to open press "ENTER" display the detail information.
2. select the file you want to play, press "ENTER" select the file then press "play".
3. during play, press or select the file that you want to play.

Playing MP3 Disc

The MP3 Display



Start MP3 Playback and Select Folders and Songs

The MP3 menu appears automatically when you insert an MP3 disc into the player.

- 1.To open a folder, use the arrow buttons on the remote to highlight the folder and press Enter (the songs in the folder appear).
- 2.Use the up/down arrow buttons to highlight the song you want from the song list. To start playing the highlighted song, press Enter.
- 3.During the playback, you can use ◀ ▶ ▲ ▼ arrow buttons for movement to select a title/song, then press Enter button to confirm.

Viewing JPEG files

Start JPEG picture playback as MP3 operation method mentioned above. This DVD player plays the JPEG picture one by one automatically.

Zoom

Under the status of playback, the picture can be zoomed. After ZOOM button is pressed, a red frame appears. Press ZOOM button can adjust the size of the frame. Press buttons to adjust the place of the frame. Press the ENTER button to enlarge the picture in the frame.

Rotate

Under the status of playback or Zoom, the picture can be rotated. Press ◀ ▶ buttons to rotate 90 degrees anti-clockwise or clockwise.

Title Show

Under the status of playback, press the TITLE button to enter the Title Show mode. Under the Title Show mode, the screen can show nine pictures at the same time. Press the or button to go the previous or next nine pictures. Press the ◀ ▶ ▲ ▼ button to select a picture. Press the ENT button to start the playback of the selected picture.

Slide Show

The slide show feature displays pictures (JPEG files) in the order you have them on the disc, beginning with the picture you select from the file list.

- 1.Insert the disc into the player. A file list is displayed. Use the arrow buttons on the remote to highlight a JPEG file from the list. Press Enter to select it (the Speed Selection menu appears).
- 2.Use the up or down arrow buttons on the remote to highlight how fast you want the slide show to play.
- 3.Press Enter (the slide show begins). The pictures will be displayed in a continuous loop.
- 4.To stop the slide show, press the STOP button. During the slide show, press INFO to display the file list. You can select a different picture.

The DVD player menu system is not the same as the disc menu or the Info Display. The DVD player menu comes up when there is no disc playing. If you are playing a disc, press STOP on the remote control to stop playback and bring up the DVD player menu.

Path Items



A path menu item has an arrow on the right side to let you know this item is a path to MORE options. To see the path menu options, highlight the menu item and press ENTER. The next set of menu choices appears to the right of the menu item. Use the arrow buttons on the remote to navigate through the menu system. Press the ENTER button to select highlighted items. To make the menu disappear from the screen, press ◀ button to go back to the path menu.

Play Mode Menu

Discs are formatted to play chapters (or tracks on audio CDs) in a certain (standard) order. If you'd like to play chapters in a different order, you can use the Play Mode feature. You must have a disc in the player with the disc tray closed in order to access all of the Play Mode items.



Standard Play

The DVD player's default play mode is standard, meaning the chapters and tracks on a disc play in the order listed on the disc starting with chapter (or track) 1.

Random Play

The Random option plays a disc's chapters in random order. If there is more than one title, the title with the most chapters is selected. If there is more than one title and all titles have an equal amount of chapters, the first title is selected. If each title has only one chapter each, the titles/chapters will be played in random order.

- 1.If you're playing a disc, press STOP to stop playback.
- 2.Press the down arrow button to highlight the Play Mode menu.
- 3.Press the arrow down button to highlight Random.
- 4.Press Enter.
- 5.To stop Random playback, press STOP twice. To resume normal playback, press PLAY.

Program Play

You must create your program (playlist) in the Edit Program menu before you can access the Program Play menu. By selecting Program Play in the Play Mode menu you're telling the DVD player to play the disc in the order you created in the Edit Program menu.

Edit Program

1. If you're playing a disc, press STOP (the main menu appears).
2. Press the down arrow button to highlight Play Mode, and press Enter.
3. Press the down arrow button until Edit Program is highlighted, and press Enter.
4. Use the number buttons on the remote control to enter the chapter (or track) you want to play first.
5. Repeat step 4 until you've programmed all of the chapters you want to play.
6. Press Enter to start programmed playback.
7. To stop Program Play, press STOP twice. To resume normal playback, press PLAY.

The Lock Menu

You can set up ratings limits and lock your player in order to control the type of content people watch on your DVD player. The padlock icon on the Lock menu indicates whether the player is locked or unlocked.

🔒 Locked: You need to enter the password in order to play discs that have a higher rating than what you've allowed. When the player is locked, nobody can access the Lock menu without entering the password.

🔓 Unlocked: No password required to play discs. Even if you've set ratings limits, they won't be enforced when the player is unlocked.

Locking your DVD player



- 1.If you're playing a disc, press STOP (the DVD player's main menu appears).
- 2.Press the down arrow button until Lock is highlighted, and press Enter (the Lock menu items appear).
- 3.Since Lock Player is highlighted, just press the OK button on the remote (the Enter Password screen appears).
- 4.Use the number buttons on the remote control to enter your password and press Enter (Confirm Password appears). Enter the same numbers you entered before and press Enter (you return to the main menu with the lock icon locked to indicate that the player is locked). Once the player is locked, you'll need to enter the password everytime you access the Lock menu.

Unlocking your DVD player

- 1.If you're playing a disc, press STOP (the DVD player's main menu appears).
- 2.Press the down arrow button until Lock is highlighted, and press Enter (the Enter Password screen appears).
- 3.Use the number buttons to enter the password you created, and press Enter (the Lock menu items appear).
- 4.Press the down arrow button until Unlock Player is highlighted, and press Enter. If asked, enter your password to confirm that you want to unlock the player (the screen goes back to the Lock menu with the padlock icon unlocked to indicate that the player is unlocked).

Changing Your Password



You can change your password, but the player must be locked.

- 1.If a disc is playing, press STOP (the main menu appears).
- 2.Press the down arrow button until Lock is highlighted, and press Enter. If asked, enter your current password (the Lock menu items appear).
- 3.Press the down arrow button to highlight Change Password, and press Enter (the Enter New Password screen appears).
- 4.Use the number buttons on the remote to enter the four-digit number that you want to use as your new password, and press Enter (you will be prompted to enter your new password again to confirm). Enter your password, and press Enter.

Setting Ratings Limits

The Rating Limits feature lets you determine what types of discs can be played in the player, and what types of discs will require a password to override the rating limit that you've set. In the U.S., the ratings feature is based on the ratings set up by the MPAA (Motion Pictures Association of America) such as R, PG, G, etc.

To set Ratings for Rated Titles:

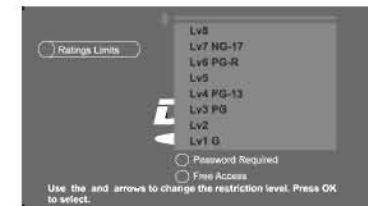

The Ratings Limits menu pertains to discs that contain movies that have an MPAA (Motion Pictures Association of America) rating assigned to them (R, PG-13, PG, G, etc.).

1. From the main menu, highlight Lock and press Enter (enter your password if asked).
2. Highlight Ratings Limits and press Enter (the 8-level rating list appears).
3. Use the up and down arrow buttons to move the bar to the highest rating you find acceptable. Ratings that won't require a password (free access) appear under the bar. Ratings that will require a password, appear above the bar.
4. Press Enter.
5. To return to the main menu, press the left arrow button until the main menu appears on the screen.

The Display Menu

The Display menu contains the settings that affect how a disc's content looks on your TV and the brightness of the display that's on the front of the DVD player.

TV Image

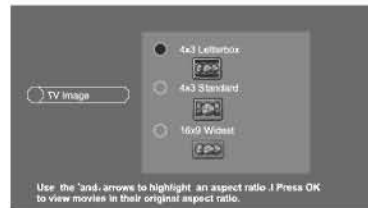

The TV Image menu adjusts the way a movie appears on your TV. Standard TVs are 4 x 3 format. Depending on the type of television you have, you may want to adjust the screen setting (also called the aspect ratio).

1. With the player on (no disc playing), press MENU (the main menu appears).
2. Use the up/down arrow buttons to highlight Display. Press the OK button (the Display choices appear).
3. TV Image is already highlighted. Press the OK button (the TV Image options appear).
4. Use the up/down arrow buttons to highlight your choice (the options are explained below), and press Enter to select.



4 x 3 Pan & Scan format. 4 x 3 Letterbox format. 16 x 9 format.

4 x 3 Pan & Scan Choose this setting if you want the movie to fill the entire screen of your TV. This might mean that parts of the picture (the left and right edges) won't be seen. Most discs produced in a widescreen format can't be cropped in this fashion. This means the black bars will appear at the top and the bottom of the screen.

4 x 3 Letterbox Choose this setting if you want to see movies in their original aspect ratio (height- to-width ratio). You'll see the entire frame of the movie, but it will take up a smaller portion of the screen vertically. The movie might appear with black bars at the top and bottom of the screen.

16 x 9 Choose this setting if your DVD player is connected to a widescreen TV. If you choose this setting and you don't have a widescreen TV, the images on the screen might appear distorted due to vertical compression. If you play a disc recorded in 4 x 3 format on a widescreen TV, the left and right side of the screen will appear black.

TV System



This feature lets you choose the right video output to match your equipment.

NTSC The DVD player will output in NTSC format regardless of what format the disc was designed for.

PAL The DVD player will output in PAL format regardless of what format the disc was designed for.

The Sound Menu

The Sound menu lets you adjust the player's settings to match the equipment that you connected to your DVD player, and to use the Sound features of the player.



Digital Output



If you connected your DVD player to a receiver via the DIGITAL AUDIO OUT jack (COAXIAL) on the back of the player, choose the type of receiver (or decoder) you have. If the menu isn't on the screen, press the STOP button (the main menu appears).

1. Use the up/down arrow buttons to highlight Sound. Press Enter.
2. Use the up/down arrows to highlight the Digital Output option. Press Enter. (the options appear)
3. Use the up/down arrow buttons to highlight your selection. Press Enter to select Dolby Digital/DTS output.
4. Press the left arrow button to return to the Sound menu or press MENU to exit the menu system.

Note: This player doesn't have DTS decoder. If you want to play DTS audio, DVD player to a receiver and select DTS output.

Stereo

To turn the Stereo feature on: Highlight the Stereo, press Enter Button, On appears next to the Stereo. To turn it off, press the OK button, Off appears next to the Prologic ?.

Note: To adjust the speakers setting, make sure the Stereo should be set to Off.

Languages Menu



The Languages menu enables you to set preferred language options for the DVD player's menu system, disc menus, the dialog (audio) of titles, and the subtitles.

Player Menus

You can change the language of the DVD player's on- screen menus.

1. From the Main Menu, (player on, no disc playing), highlight Languages and press the OK button on the remote (the Languages options appear).
2. If Player Menus isn't already highlighted, press the up arrow button on the remote control to highlight it, and press Enter (the languages appear).
3. Press the down (or up) arrow buttons to highlight the language in which you want the menus to appear, and press Enter (the Languages menu appears with your choice next to the Player Menu option).

Disc Menus

- 1.You can set your language preference for disc menus (a disc's menu is separate from the DVD player menu).
- 2.From the Main Menu, (player on, no disc playing), highlight Languages and press the OK button on the remote (the Languages options appear).
- 3.Press the down arrow button on the remote to highlight Disc Menus, and press Enter (the languages appear).
- 4.Press the down (or up) arrow buttons to highlight the language in which you want the disc menus to appear, and press Enter (the Languages menu appears with your choice next to the Disc Menu option).

Audio

You can set your language preference for movies (titles) you play in your DVD player the language in which you'll hear the dialogue when you're playing a movie.

Notes: Discs are created differently. The DVD player can't override some language preferences. If a disc's software was created to play the movie (title) in a preferred language, the preference you set might be ignored. Also, if the language isn't available on the movie you're playing, the disc's default language will be chosen.

Subtitles

You can set your language preference for the subtitles you see on the screen while playing a disc.

Notes: You must turn on the Subtitle feature in order for them to appear when you're playing a disc. If the disc wasn't created with subtitles, you won't be able to use the Subtitle feature. If the disc wasn't created with the Subtitle language you choose in the Subtitles menu, the disc's default subtitle language will be chosen.

- 1.From the Main Menu, (player on, no disc playing), highlight Languages and press the OK button on the remote (the Languages options appear).
- 2.Press the down arrow button on the remote to highlight Subtitles, and press Enter (the languages appear).
- 3.Press the down (or up) arrow buttons to highlight the language in which you want the subtitles to appear, and press Enter (the Languages menu appears with your choice next to the Subtitles option).

7. Remote control functions

This chapter will detail the functions and operation of all the buttons on the remote control.

Most operation procedures were discussed in detail previously, in chapters 4 and 5.

7.1 [▶||]

When the DVD player is stopped, paused, in slow play, fast forward, or fast reverse state, you can press [▶||] to resume normal playback. Press [▶||] again, the DVD player will be pause, press [▶||] again, to resume normal playback.

7.2 [TITLE] (function is disc dependant)

Press [TITLE] to display the title menu included on the specific disc loaded. Once the disc menu is displayed, you can press [UP], [DOWN], [LEFT], [RIGHT] to move the cursor to select the desired item, then press [ENTER] to select the option to be played, or the subsequent sub-menu to be selected.

7.3 [PROGRAM]

This function will work for music Cds only. Press [PROGRAM] to set the specific track playing order.

7.4 [OPEN][CLOSE]

Press the [▲] button once. The disc will be ejected. Press it again to reload the disc.

7.5 [REPEAT]

Press this button to repeat either the chapter, title or disc.

7.6 [ZOOM]

While playing, press the [ZOOM] button to zoom in upon the current image on screen. Press once to enlarge the image by 1 times, press twice to enlarge it by 2 times, press it three times to enlarge by 4 times, press it a fourth time to resume normal view playback.

7.7 [MENU/PBC]

While playing a DVD, press this button to display the disc menu. (This varies with the type of disc loaded). Press this button to change the playback control (PBC) state. For DVD/SVCD discs, the disc must be stopped to change this state.

7.8 [▶▶] (function is disc dependant)

While playing a DVD disc, press this button to skip to the next chapter; while playing SVCD or other disc types, press this button to skip to the next track

7.9 [ANGLE] (function is disc dependant)

While playing a DVD disc with multi-angle function, press [ANGLE] to play the video from different angles of your choice. Pressing the button repeatedly will toggle through the different angles available upon the disk, one by one.

7.10 [MUTE]

Press this button to silence the sound coming from the analog audio outputs to the monitor or TV.

7.11 [▶▶▶]

Press this button to fast forward the playback silently. Press it repeatedly to advance at different speeds and then finally return to normal playback.

7.12 [◀◀]

Press this button to fast reverse the playback silently. Press it repeatedly to reverse at different speeds and then finally return to normal playback.

7.13 [SLOW]

Press this button to play in slow motion silently. The film can be played in slow motion in the forward or backward direction. Press the button repeatedly to toggle through the various slow motion speeds and directions, finally returning to the normal playback state.

7.14 [DISPLAY]

Press this button to display disc playback information. e. g. the current playing time, remaining time, etc.

7.15 [◀◀◀]

While playing a DVD disc, press this button to skip to the previous chapter; while playing SVCD and other disc types, press this button to skip to the previous track.

7.16 [ENTER]

Press this button to execute the entered or selected item.

7.17 [UP], [DOWN], [LEFT], [RIGHT]

With the disc menu or SETUP MENU on screen, you can press these buttons to move the cursor, around the screen options.

7.18 NUMBER BUTTONS

The [0], [1].... [9] number buttons are used to enter numbers, e.g. CD track number, DVD chapter Number etc.

7.19 [GOTO]

Select the time that you want to play.

7.20 [CLEAR]

When entering the desired CD program track number, press [CLEAR] to cancel any numbers entered in error.

7.21 [SETUP]

Pressing this button enters the SETUP MENU. See earlier in this manual for specific for details. NOTE: The disc must be stopped, in order to gain access to the "PREFERENCES" sub-menu.

7.22 [■ ◂ ◃]

While playing a disc, press this button once to stop playback. Pressing play subsequently, will continue playback from the original film location. Pressing this button twice will completely stop playback and cancel the previous film playback location memory.

7.23 [SUBTITLE]

Press this button to select the desired subtitle language from the disc, e.g. English, French, OFF etc. Press this button repeatedly to toggle through the options available. (This feature works only for discs with multiple subtitles encoded upon it).

7.24 [AUDIO]

Press this button to select the desired language from the disc, e.g. English, French etc. Press this button repeatedly to toggle through the options available. (This feature works only for discs with multiple languages encoded upon it).



1	2	3	4
5	6	7	8
9	0	∞∞	

7.25 [DVD/GAME]

Press the [DVD/GAME] button and the DVD player will turn to the "GAME" state. You can utilise the LINE INPUT socket on the front panel to input a signal from a games machine/ camcorder etc. The input connection cable is supplied with your Voyager-one for this purpose.

7.26 [VOL+, VOL-]

Press VOL+ to increase volume, press VOL- to lower volume.

NOTE: DVD WITH TV TUNER MODEL, THE [DVD/GAME] KEY IS EXCHANGED BY [DVD/TV/GAME]

1. Push [DVD/TV/GAME] one time, the unit will turn to ``TV`` state, then push [SETUP], and choose AUTO SEARCH, push [RIGHT] of direction key, and choose ON by direction key. Then push [RIGHT]. This time, the unit will search and remember TV program automatically.
2. You can choose TV program by [UP] and [DOWN] of direction key.
3. You can choose TV program by number key.
For example, if you want to choose 18 CH, please push [10] then push [8].
4. You can tune finely by [LEFT] and [RIGHT] of direction key.
5. Push [DVD/TV/GAME] again, the unit will turn to ``Input`` state, you can watch other program or play game by LINE INPUT on front panel.

8. Technical terms

TITLE: For DVD disc it is defined as a long complete segment of image or music or a movie. Each title has a number that makes it easy to search.

TRACK: The image or music of a VCD or CD. Each track has a number for search.

CHAPTER: It is smaller than title among the units of a DVD, it is defined as a long complete segment of image or music or a movie. A title is made up of several chapters, and each chapter has a number for search.

CAPTION: The literature in TV screen bottom, generally it is translation or dialogue, also recorded in the disc.

ANGLE: For some DVD discs, they record pictures filmed from different angles, the user can watch a same picture from different angles at your option.

9. Troubleshooting**Nosound**

- Check if the unit is connected securely with other systems including amplifier or TV;
- Make sure you operate the TV or amplifier correctly.
- Make sure the system setting is correct.

Disc cannot be played

- Make sure the disc has been properly in the tray.
- Check whether there is only disc in the tray.
- Make sure the disc is clean

Remote control does not work

- Remove barriers from the remote control. Replace the batteries with new ones.
- Point the remote control at the remote control sensor of the unit.
- Check whether the batteries energy is sufficient.

Twisting image

Specifications

Check whether the disc is scratched or there is dirt whereof.

This player is controlled by micro computer, if any trouble occurs, please turn off the power, reopen it till 10 minutes later, when there is no trouble the moment, you can normally operate the player.

Button does not work

This may be caused by unstable electricity current or other abnormal trouble, please turn off the power, reopen it till 10 minutes later.

10. Specifications

Playable discs: DVD/SVCD/DVCD/VCD1.0, 1.1, 2.0 (micro laser video/audio disc) CD - DA (common music laser CD), MP3 audio disc, CD-R, CD-RW

Video format: MPEG1, MPEG2;

Audio format: MPEG1, MPEG2, PCM, DOLBY DIGITAL, analog stereo,

Signal output: video signal: NTSC or PAL
video: 1.0Vp-p
audio: mix stereo 2Vp-p

Functional operation: please refer to chapter 7.

Output interface: RCA output, high-resolution system (S-VIDEO) output, coaxial digital output

Power voltage: DC 9.5-24V

Power consumption: 15W

Frequency response: DVD: 20Hz-20KHz

Audio signal/noise ratio: ≥ 90 dB

Weight: 1.2kg

Product dimension: 178x168x50(mm)

Accessories: audio/video cable, remote control (with batteries), user's manual, video CABLE.



Notes:

Any change to the design and specifications will not be advised.

How to deal with disk

How To Deal With Disk

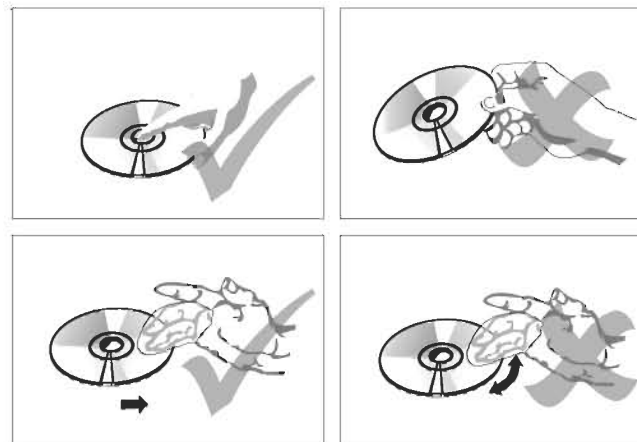

How to hold disk

Don't touch the face carving information.

When there are stains on the face of disk

wipe gently with a wet cloth and then with a dry one.

When a disk is brought from a cold environment to a hot one, there could be steam on the face of disk. wipe with a dry, soft, smooth cloth before using.

Attention

Don't write on the labeled side.

Don't use pickup cleaning preparation, phenyl, chemical solution, dispersing solution, anti-static electricity solution or any other kind of solutions to clean disk

Don't stick label or glue-based note on disk (Don't use disks with remaining glue or damaged gluey label)

Don't use scratching-preventing materials or cover, unless it is assigned to use on this machine.

Don't put or store disk at following environments. straight under the sunshine. /at moist or dusty places at the exit of hot air or beside heating installation.



Free Manuals Download Website

<http://myh66.com>

<http://usermanuals.us>

<http://www.somanuals.com>

<http://www.4manuals.cc>

<http://www.manual-lib.com>

<http://www.404manual.com>

<http://www.luxmanual.com>

<http://aubethermostatmanual.com>

Golf course search by state

<http://golfingnear.com>

Email search by domain

<http://emailbydomain.com>

Auto manuals search

<http://auto.somanuals.com>

TV manuals search

<http://tv.somanuals.com>