

OWNER'S MANUAL

Mobile Audio System

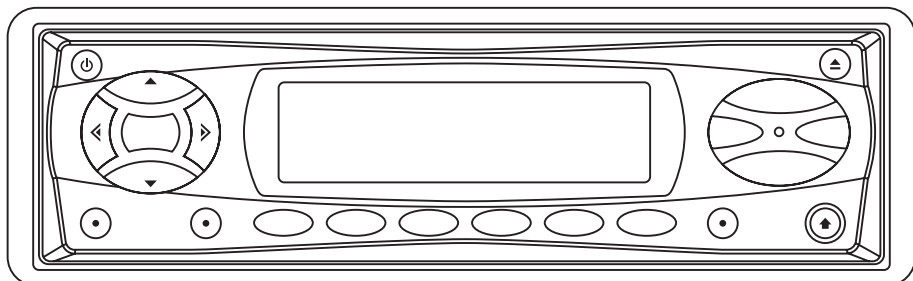

- **PLL Synthesizer Stereo Radio**
- **Digital Compact Disc Player**
- **XM Ready Function**
- **Automatic Memory Storing**
- **Slide Down Detachable Panel**
- **Direct Track Access**
- **Program CD Tracks**
- **CD Changer Control**
- **Auxiliary Input Function**
- **Wired Commander Control**



CONTENTS

- Installation3**
 - DIN Front-Mount.....3
 - Installing the unit.....3
 - Removing the unit.....4
- Using the Detachable Front Panel5**
- Wiring Connection6**
- Operation.....10**
 - General Operation10
 - Radio Operation13
 - XM Operation13
 - CD Operation14
 - CDC Operation15
- Specification.....17**
- Trouble Shooting.....18**

INSTALLATION

Notes:

- The unit can be installed on the vehicle or the ships.
- Choose the mounting location where the unit will not interfere with the normal driving function of the driver.
- Before finally installing the unit, connect the wiring temporarily and make sure it is all connected up properly and the unit and the system work properly.
- Use only the parts included with the unit to ensure proper installation. The use of unauthorized parts can cause malfunctions.
- Consult with your nearest dealer if installation requires the drilling of holes or other modifications of the vehicle or the ship.
- Install the unit where it does not get in the driver's way and cannot injure the passenger if there is a sudden stop, like an emergency stop.
- If installation angle exceeds 30° from horizontal, the unit might not give its optimum performance.

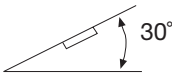

- Avoid installing the unit where it would be subject to high temperature, such as from direct sunlight, or from hot air, from the heater, or where it would be subject to dust, dirt or excessive vibration.

TAKE OUT SCREWS BEFORE INSTALLATION

Before install the unit, please remove the two screws.

Take out screws before installation

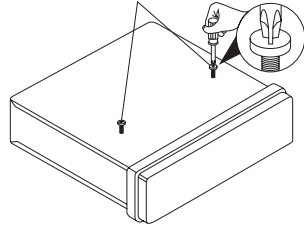

NOTE: If this unit is installed on the ship, you should use two pieces of plastic film (30mmX20mm) supplied with the unit to seal the two holes after remove the screws. And this will be waterproof.

DIN FRONT-MOUNT

Installing the unit

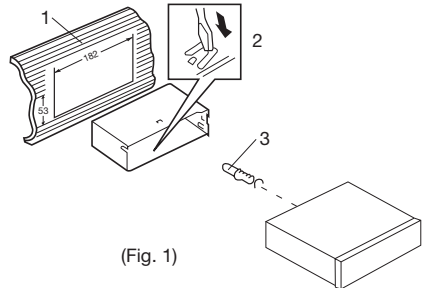

1. Dashboard
2. Holder
After inserting the holder into the dashboard, select the appropriate tab according to the thickness of the dashboard material and bend them inwards to secure the holder in place.
3. Screw

INSTALLATION

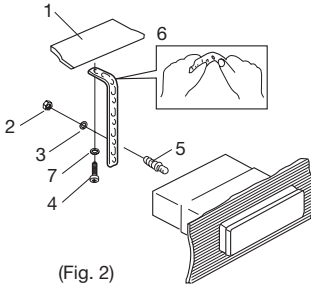

(Fig. 2)

1. Dashboard
2. Nut (5mm)
3. Spring washer
4. Screw (5x25mm)
5. Screw
6. Strap
7. Plain washer

Be sure to use the strap to secure the back of the unit in place. The strap can be bent by hand to the desired angle.

Removing the unit

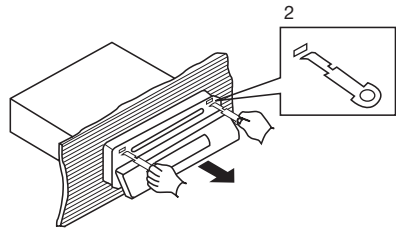
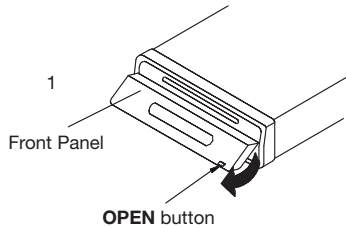

1. Before removing the unit, press the **OPEN** button to slide down the front panel.
2. Lever
Insert the levers supplied with the unit into the grooves in the housing as shown in figure until they click. Pulling the levers makes it possible to remove the unit from the dashboard.

USING THE DETACHABLE FRONT PANEL

To Detach the Front Panel

1. Press the **OPEN** button, the front panel will slide down.

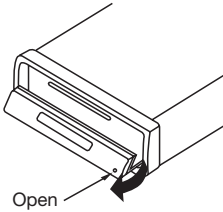

2. When the front panel slides down, press the bottom button of the front panel upward and pull it out from the panel bracket.

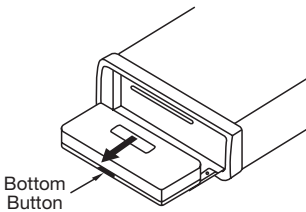

3. For safekeeping, store the front panel in the supplied protective case immediately after being removed.

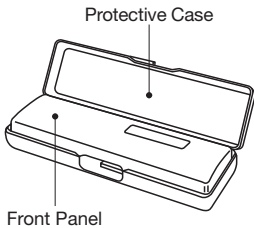

To Reinstall the Front Panel

1. When the panel bracket is in slide down position, insert the front panel into the panel bracket and push the front panel from the middle to slide it up.

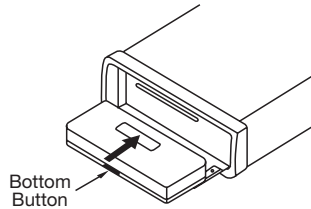

WIRING CONNECTION

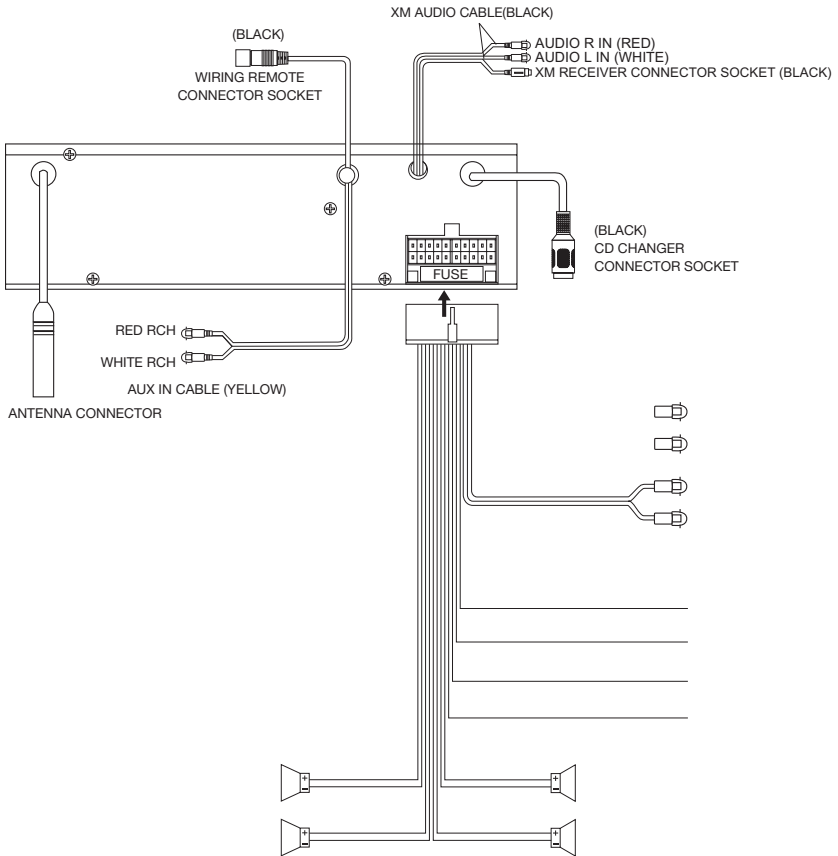

OPERATION

CONTROL & FUNCTIONS KEYS

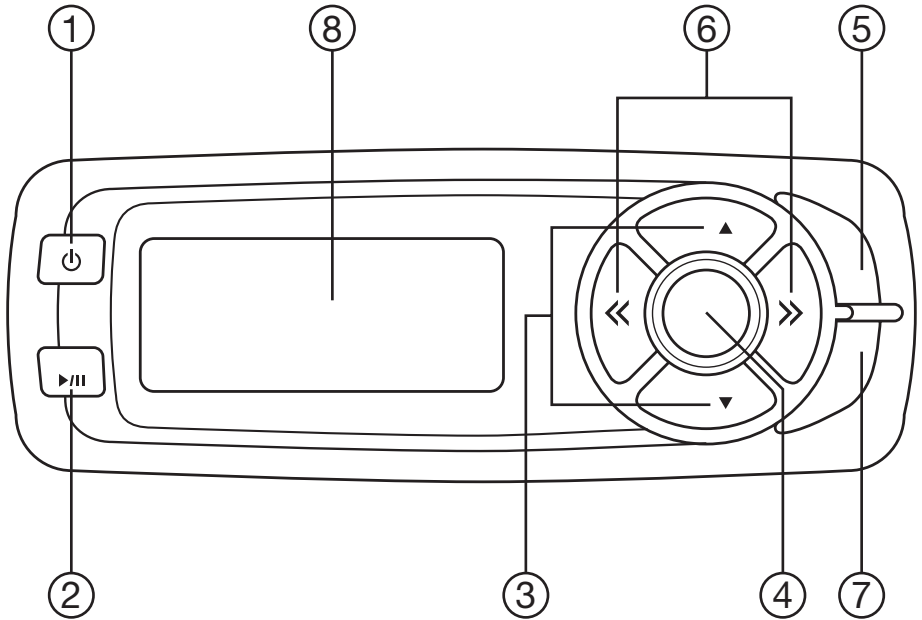

This unit is a marine rated wired remote control made using a modified controller or similar layout. It is capable of operation specified functions on the marine AM/FM/CD receiver. The body, buttons, controls and display need to be UV and water-resistant. It includes an LCD and an illumination circuit. The flat body should be watertight and the circuit board clear coated.

1 Power button

Press the  button (1) shortly to turn on/off the head unit.

Press  button (1) for more than 3 seconds, the button is operated to initial volume control button. When system power turns on, the volume is set to initial volume level.

2 MUTE button

In RADIO/AUX IN mode, press **MUTE**  button (2) to activate mute function and "MUTE" will appear on the display. Press the button once again to release mute function and return the volume to the last position before it was muted.

In CD/CDC mode, press  **MUTE** button (2) to pause CD/CDC player. Press it again to resume play.

3 VOLUME +/- buttons

Press VOL  /  buttons (3) to increase/decrease volume level.

OPERATION

4 **MODE SELECTION button**

Press the **MODE** button (4) to step sequentially through the following sources: e.g. radio mode to CD mode to CDC mode to AUX in mode.

5 **BAND SELECTION button**

Press the **BAND** button (5) to step sequentially through the following bands: FM1, FM2, FM3, AM1, AM2.

6 **TRACK/SEARCH/TUNE buttons**

- **STATION SELECTION (FOR RADIO OPERATION)**

Press **>>/<<** buttons (6) shortly to activate automatic seek function. Press for more than 3 seconds until "**MAN**" appears on the display, the manual tuning mode is selected. If both buttons have not pressed for several seconds, they will return to seek tuning mode and "**AUTO**" appears on the display.

- **SELECT TRACKS (FOR CD OR CDC OPERATION)**

Press the **>>/<<** buttons (6) shortly to move to the following track or the previous track.

Press the **>>/<<** buttons (6) for more than 3 seconds to activate fast forward or rewind of the disc. Disc play starts from when you release the button.

7 **SHIFT/SCAN button**

- **SCAN (FOR RADIO OPERATION)**

Press **SHIFT/SCAN** button (7) to scan through strong stations in the current band. Radio pauses for five seconds at each strong station. At each time the frequency is flashing on the display. Press **SHIFT/SCAN** button (7) again to listen to current station.

- **SELECT DISC (FOR CDC OPERATION)**

During CDC operation, press **SHIFT/SCAN** button (7) to shift mode. And then "**SHIFT**" will appear on the display. At shift mode, press **>>/<<** buttons (6) to select next disc or previous disc. If there is not any operation for several seconds, it will exit shift mode automatically.

8 **Liquid Crystal Display**

Exhibit the number, the current disc and the current track, and other activated functions on the display (8).

INSTALLATION

INSTALLATION HARDWARE
HOLDER

BASE

REMOTE
MOUNTING BRACKET



X1

X1

X1

SCREW ($\varnothing 4 \times 50$)

NUT

X2

X2

INSTALLATION DIAGRAM

1. First insert the hooks on the base into the slots of the holder to install the base to the holder.
2. Select the proper object, then place the remote mounting bracket on the base and let the object go through the base and the mounting bracket.

3. Align the screw holes on the holder with the screw holes on the base and the screw holes on the bracket, then use the two screws ($\varnothing 4 \times 50$) and nuts to fix the bracket, the base and holder to the proper location.

4. Last install the remote control to the holder. See below, align the four hooks on the holder with the four slots on the remote control.

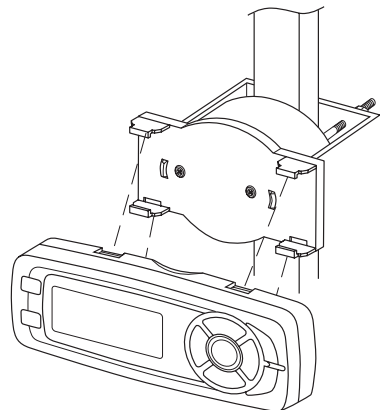

OPERATION

LOCATION OF KEYS

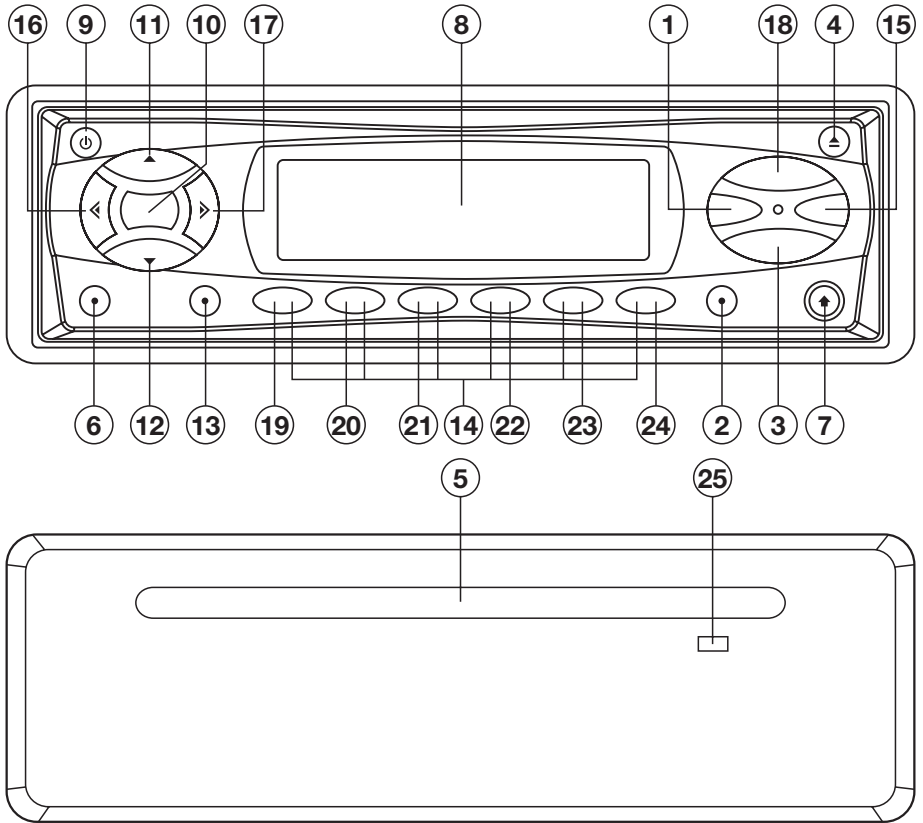

- | | |
|---------------------------|--------------------------|
| 1. DISP | 14. M1~M6 Preset buttons |
| 2. AS/PS/ELAPSE | 15. LOUD/DIM |
| 3. ►/ /MUTE | 16. CH ◀ |
| 4. ▲ EJ | 17. CH ▶ |
| 5. DISC SLOT | 18. BAND/ENTER |
| 6. MODE | 19. M1 MEM (CAT ▼) |
| 7. OPEN | 20. M2 PGM (CAT ▲) |
| 8. LIQUID CRYSTAL DISPLAY | 21. M3 RPT |
| 9. PWR | 22. M4 SHF |
| 10. SEL/MENU | 23. M5 SCN |
| 11. VOL ▲ | 24. M6 |
| 12. VOL ▼ | 25. Reset Button |
| 13. SHIFT/SCAN/XM-MOD | |

OPERATION

GENERAL OPERATION

SWITCHING ON/OFF THE UNIT

Pressing **PWR** button (9) to switch on or turn off the unit. When system power turns on, the system is returned to previous mode.

FACEPLATE RELEASE

Press **OPEN** button (7) to slide down the removable faceplate.

SOUND ADJUSTMENT

Press **SEL/MENU** button (10) shortly to change audio mode through volume, bass, treble, balance, and fader modes. Press **VOL ▲** button (11) or **VOL ▼** button (12) to adjust the selected mode. When the currently displayed function has not been adjusted for several seconds, the mode shall return to volume position and display will return to normal radio, CD or CDC display.

→ Volume → Bass → Treble → Balance → Fader →

Volume

Press **SEL/MENU** button (10) one time. Adjust volume level by **VOL ▲** button (11) or **VOL ▼** button (12).

Notes:

The unit is initially set to volume mode.

Bass

Press **SEL/MENU** button (10) two times. Adjust bass level by **VOL ▲** button (11) or **VOL ▼** button (12).

Treble

Press **SEL/MENU** button (10) three times. Adjust treble level by **VOL ▲** button (11) or **VOL ▼** button (12).

Balance

Press **SEL/MENU** button (10) four times. Adjust sound balance between left and right speakers by **VOL ▲** button (11) or **VOL ▼** button (12).

Fader

Press **SEL/MENU** button (10) five times. Adjust sound balance between front and rear speakers by **VOL ▲** button (11) or **VOL ▼** button (12).

MENU SELECTION FUNCTION

Hold press **SEL/MENU** (10) for several seconds to enter menu select function, then step short press **SEL/MENU** (10) to

select different set mode and separately to press **VOL ▲** button (11) or **VOL ▼** button (12) to select your requisite as following order.

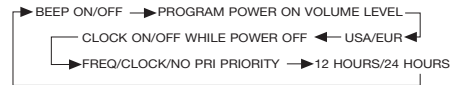

For detailed operations, please see below:

BEEP ON/OFF

Hold press **SEL/MENU** button (10) for several seconds, when BEEP ON/OFF appears, press **VOL ▲** button (11) or **VOL ▼** button (12) to select BEEP on or BEEP OFF. When beep on, the beep is generated when every button is pressed. When beep off, the beep is disabled when press any button.

Program power on volume level

Hold press **SEL/MENU** button (10) for several seconds, when BEEP ON/OFF appears, press **SEL/MENU** button (10) shortly one time to select “program power on volume level” mode. And then you can press **VOL ▲** button (11) or **VOL ▼** button (12) to select the level when the unit turns on.

USA/EUR

Hold press **SEL/MENU** button (10) for several seconds, when BEEP ON/BEEP OFF appears, press **SEL/MENU** button (10) shortly two times to select “USA/EUR” mode. And then you can press **VOL ▲** button (11) or **VOL ▼** button (12) to select USA or European radio frequency spacing.

- USA radio spacing is 200k for FM and 10k for AM. This is the default frequency spacing.
- European radio spacing is 50k for FM and 9k for AM.

CLOCK ON/OFF while power off

Hold press **SEL/MENU** button (10) for several seconds, when BEEP ON/OFF appears, press **SEL/MENU** button (10) shortly three times to select “clock on/off while power off” mode. And then you can press **VOL ▲** button (11) or **VOL ▼** button (12) to select if the clock is to be displayed while power off.

FREQ/CLOCK/NO PRI priority

Hold press **SEL/MENU** button (10) for several seconds, when BEEP ON/OFF appears, press **SEL/MENU** button (10) shortly four times to select

OPERATION

“FREQ/CLOCK/NO PRI priority” mode. And then you can press **VOL ▲** button (11) or **VOL ▼** button (12) to select frequency priority or clock priority or no priority.

- When select Frequency Priority:
The frequency will appear on the unit all the while. Pressing **DISP** button (1) while in Frequency Priority will temporarily display clock and then returns to frequency display.
- When select Clock Priority:
The clock will appear on the unit all the while. Pressing **DISP** button (1) while in Clock Priority will temporarily display selected station frequency (in RADIO mode) or track number (in CD/CDC mode) and then returns to clock display.
- When select No Priority:
When the frequency appears on the unit, pressing **DISP** button (1) will display clock and it will not return to frequency display until **DISP** button (1) pressed again. When the clock appears on the unit, pressing **DISP** button (1) will display frequency information.

12hours/24hours

Hold press **SEL/MENU** button (10) for several seconds, when BEEP ON/OFF appears, press **SEL/MENU** button (10) shortly five times to select “12hours/24hours” mode. And then you can press **VOL ▲** button (11) or **VOL ▼** button (12) to set 24 hours mode or 12 hours mode.

- When the currently displayed function has not been adjusted for several seconds, it will exit menu set mode.
- When you have set CLOCK ON during power off state, LCD backlight will be turn on together.

DISPLAY INFORMATION

When pressed quickly, the **DISP** button (1) changes the display as follows.

- In AM/FM mode:
-> Frequency ->CLOCK ->
- In XM mode:
-> Channel Name -> Artist Name ->
Song Title -> Category Name -> CLOCK ->
- In CD mode:
-> CD ->CLOCK ->
- In CDC (or AUX) mode:
->CDC (or AUX)->CLOCK ->

Each display time is 5 seconds, the display will return to the first position after 5 seconds.

SET THE CLOCK

Press the **DISP** button (1) shortly until the clock is shown on the LCD display. Then hold down **DISP** button (1) until the clock flashes. Then press the **CH ▶** button (17) clockwise to change hours or rotate the **CH ◀** button (16) to change minutes.

MUTE

In radio/XM/AUX IN mode, press **▶/II /MUTE** button (3) to mute audio level. Press the button again to release mute function.

LOUDNESS

Press **LOUD (DIM)** button (15) shortly to reinforce the bass output and display will show “LOUD”. Press it again to release this function.

MODE SELECTION

Press **MODE** button (6) to sequence through primary operating modes in the following order: radio >XM > CD> CDC> AUX. If playback media (CD) is not loaded into mechanism, CD mode will be skipped. If CDC is not connected to head unit, CDC mode will be skipped. If XM receiver connector is disconnected to XM head unit, XM mode will be skipped.

LIQUID CRYSTAL DISPLAY

Exhibit current frequency and activated functions on the display (8).

ILLUMINATION

Press **LOUD (DIM)** button (15) for more than 2 seconds to adjust the brightness of the LCD display backlight.

RESET FUNCTION

Reset button (25) must be activated with either a ballpoint pen or thin metal object. The reset button is to be activated for the following reasons:

- Initial installation of the unit when all wiring is completed.
- All the function buttons do not operate.
- Error symbol on the display.

Note: If press reset button (25), the unit can't work yet, please use a cotton swab soaked in isopropyl alcohol to clean the socket on the front panel.

RECOVERING INITIAL VALUE

In radio (AM/FM) mode, press **MODE** button (6) for more than three seconds, the display will appear “EEP INIT”, and all settings recover factory value.

OPERATION

RADIO OPERATION

SWITCHING TO RADIO MODE

Press **MODE** button (6) shortly to select radio mode, the radio mode appears in the display together with the memory band and frequency.

SELECTING THE FREQUENCY BAND

At radio mode, press **BAND/ENTER** button (18) shortly to select the desired band.

The reception band will change in the following order:



SELECTING STATION

Press **CH** ◀ button (16) or **CH** ▶ button (17) shortly to activate automatic seek function. Press for more than 3 seconds until “**MANUAL**” appears on the display, the manual tuning mode is selected. If both buttons have not been pressed for several seconds, they will return to seek tuning mode and “**AUTO**” appears on the display.

AUTOMATIC MEMORY STORING & PRESET SCAN

- Automatic memory storing
Press **AS/PS** button (2) for several seconds, the radio searches from the current frequency and checks the signal strength until one cycle search is finished. And then 10 strongest stations are stored into the corresponding preset number button
- Preset Scan
Press **AS/PS** button (2) shortly to scan all station presets saved in memory.

STATION STORING

The preset buttons (14) can be used to store 10 stations in each band (FM 1, FM 2, FM 3 and AM1, AM2) for convenient access to your favorite stations.

- Programming stations
 1. Select the desired band, then tune in the station you want to store in memory.
 2. Press and hold one of the preset buttons (14) for more than 2 seconds

until the corresponding preset button number appears. Repeat steps 1 and 2 to program additional stations.

- Quick tuning
Select the desired band, then press one of the ten preset buttons (14).

SCAN

Press **SHIFT/SCAN** button (13) to set function to scan mode, which scanning to higher frequency station with receivable signal and keep on each station for several seconds.

XM OPERATION

SWITCHING TO XM MODE

Shortly press **MODE** button to select XM mode.

SELECTING USER-PRESET CHANNEL

In XM mode, the XM user-preset channel group is toggled cyclically through the group by quickly pressing the **BAND** button.

The channel will change in the following order:

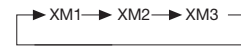

SELECTING CHANNEL UP/DOWN

Press the **CH** ◀ / ▶ buttons to select the channel up or down.

SEARCHING SCHANNEL

When the **AS/PS** button is shortly pressed, the unit searches for each user preset channel from XM1, XM2 to XM3. When an available channel is detected, the channel will be held at that preset number and played about 5 seconds. After that, it will search for another available channel.

DIAGNOSTIC MODE

Press and hold **AS/PS** button for over 5 seconds will enter diagnostic mode and display “STATE1”, then press channel UP/DOWN key to select each state as below:

->STATE1->STATE2->STATE3->STATE4
->STATE5->STATE6->STATE7-> STATE8
->STATE9

Short press **AS/PS** button will exit diagnostic mode.

OPERATION

STORING PRESET CHANNELS

The preset buttons can be used to store channels for convenient access to your favorite channels.

- Programming channels
- 1. Select the desired channel you want to store in memory.
- 2. Press and hold one of the preset buttons for more than 2 seconds until the corresponding preset button number appears. Repeat steps 1 and 2 to program additional channels.
- Quick tuning
- Shortly press one of the preset buttons to select a preset channel directly.

MODE SELECTION

Press **XM-MOD** button to switch CATEGORY mode, DIRECT mode, or NORMAL mode. Its sequence is as follows:

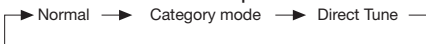

When category mode is selected, the CATEGORY appears on the display and the function is activated.

When Category mode is released, the CATEGORY disappears. When Direct mode is engaged, "DIRECT" of alphanumeric display is turned on.

Select category and tune UP/DOWN within selected category

Use M1 button or M2 button to select desired category and press BND/ENT button to confirm.

In CATEGORY mode, channels can be tuned by press **CH** ◀ button (16) or **CH** ▶ button (17) within the same category.

How to direct tune

Press **XM-MOD** to select DIRECT MODE.

1. In direct mode, display shows "CH000" channel number. (Hundred Digit flashing on/off)
2. Use **CH** ▶ button, **CH** ◀ button or directly press numeric buttons(0-9) to select hundred digit.
3. Press **XM-MOD** button to confirm entry of the hundred digit and the 10s digit is flashing on/off.
4. Use **CH** ▶ button, **CH** ◀ button or directly press numeric buttons (0-9) to select 10s digit.
5. Press **XM-MOD** button to confirm entry of the 10s digit and the 1s digit is flashing on/off.

6. Use **CH** ▶ button, **CH** ◀ button or directly press numeric buttons(0-9) to select 1s digit.
7. Press **BAND** button to confirm direct tune. If selected a nonexistent channel, after the channel number was entered, each digit will be converted to dashes for 2s, then the display will return to the previous channel and settings.

CD OPERATION

SWITCHING TO CD MODE

If there is no CD inserted in the driver: Gently insert the CD with the printed side uppermost into the CD compartment until you feel some resistance. The CD is drawn into the driver automatically. CD playback begins.

If a CD is already inserted in the driver: Keep pressing **MODE** button (6) shortly until the CD mode display appears.

EJECTING A DISC

Press ▲ (EJECT) button (4) to stop CD playing and eject the disc from the disc slot (5).

PAUSING PLAYING

Press ▶|| /MUTE button (3) to pause CD player. Press it again to resume play.

SELECTING TRACKS

Press **CH** ◀ button (16) or **CH** ▶ button (17) to move to the previous track or the following track. Track number shows on display.

Hold press **CH** ◀ button (16) or **CH** ▶ button (17) to fast reverse or fast forward. Disc play starts from when you release the button.

DIRECT TRACK ACCESS

Pressing number buttons 0~9(14) (i.e. 19~28) can activate DIRECT TRACK ACCESS according to your need. For example, press button (19), and "T-01" will be flashing on the display. Then press button (20), "T-12" will appear and track 12 will be selected to play. If you don't press any button when "T-01" is flashing. After several seconds, "T-01" doesn't flash and track 1 is selected to play. If

OPERATION

you select a track number that doesn't belong to the current disc, "NO TR" will appear on the display.

REPEATING THE SAME TRACK

Hold press **RPT** button (21) for several seconds to continuously repeat the same track. Hold press it again to stop repeat.

PLAYING ALL TRACKS IN RANDOM

Hold press **SHF** button (22) for several seconds to play all tracks on CD in random order. Hold press again to cancel the function.

PREVIEWING ALL TRACKS

Hold press **SCN** button (23) for several seconds to play first several seconds of each track on the current disc. Hold press again to stop intro and listen to track.

PROGRAM CD TRACKS

Use Program function to select up to 32 tracks to play in any order. Program works by allowing you to select a track number for each spot in the playing sequence. A CD must be inserted and in CD playing mode to use Program.

- How to program CD tracks.
- 1. Hold press **MEM** button (19) for several seconds to enter Program mode, then "PGM" stars flashing and "P-01" icon appear on the display.
- 2. Press **CH** ◀ button (16) or **CH** ▶ button (17) to choose track number. For example, select track 6, then press **MEM** button (19) shortly to memorize it and "P-02" will appear on the display. So track 6 will be played first. Thus, you can also press **CH** ◀ / ▶ buttons (17) and (16) to choose track number 10 and press **MEM** button shortly, then "P-03" will appear. So track 10 will be secondly played. Repeat these operations, and you can program CD tracks to your need. If you completed program setting, hold press **PGM** button (20) for several seconds to play CD in programmed order.
Note: Using Program function can only select up to 32 tracks to play in any order. When you have selected 32

tracks to be programmed. "FULL" will appear on the display.

- When the CD is played in programmed order by hold pressing **PGM** button (20) for several seconds, hold pressing it again for several seconds will exit PGM mode.
- When the disc is playing in programmed order, hold pressing **MEM** button (19) for several seconds will cancel the all programmed content and "CLEAR" appears on the display.
- If you don't press **MEM** button (19) to carry out program setting, then hold press **PGM** button (20) for several seconds, "NO-PGM" will appear.

TRACK/TIME DISPLAY

Press **AS/PS** button (2) to show running time/remain time of track.

CDC OPERATION

You can connect a CD changer to the unit with CDC operation version only. Information on handing CDs, inserting CDs and operating the CD changer can be found in the operating instructions supplied with your CD changer.

SWITCHING TO CDC MODE

Keep pressing **MODE** button (6) shortly until the CDC mode display appears. Playback begins with the first CD that the CD changer detects.

PAUSING PLAYING

Press ▶/II/MUTE button (3) to pause CDC player. Press it again to resume play.

SELECTING TRACKS

Press **CH** ◀ button (16) or **CH** ▶ button (17) to move to the previous track or the following track. Track number shows on display.

Hold press **CH** ◀ button (16) or **CH** ▶ button (17) to fast reverse or fast forward. Disc play starts from when you release the button.

OPERATION

DIRECT TRACK ACCESS

Pressing number buttons 0~9(14) (i.e. 19~28) can activate DIRECT TRACK ACCESS according to your need. For example, press button (19), and "T-01" will be flashing on the display. Then press button (20), "T-12" will appear and track 12 will be selected to play. If you don't press any button when "T-01" is flashing. After several seconds, "T-01" doesn't flash and track 1 is selected to play. If you select a track number that doesn't belong to the current disc, "NO TR" will appear on the display.

REPEATING THE SAME TRACK

Hold press **RPT** button (21) for several seconds to continuously repeat the same track. Hold press it for several seconds again to stop repeat.

PLAYING ALL TRACKS IN RANDOM

Hold press **SHF** button (22) for several seconds to play all tracks on the current disc in random. Hold press it for several seconds again to cancel the function.

PREVIEWING ALL TRACKS

Hold press **SCN** button (23) for several seconds to play first several seconds of each track on current disc. Hold press it again for several seconds to stop intro scan and listen to track.

TRACK/TIME DISPLAY

Press **AS/PS (ELAPSE)** button (2) to show running time of track.

SELECTING DISC

Press **SHIFT/SCAN** button (13) to shift mode and then "SHIFT" will appear on the display. At shift mode, press **CH** ◀ button (16) or **CH** ▶ button (17) to select previous disc or next disc. If there isn't any operation for several seconds, it will exit shift mode automatically. At shift mode, you can also press number button 0~9 (14) (i.e. 19~28) to select the disc directly. If you select 3# disc (press button (21), and there isn't a disc in the 3# slot, "NO CD" will appear.

DISC NOTE

A. Notes on discs:

1. Attempting to use non-standard shape discs (e.g. square, start, heart) may damage the unit. Be sure to use round shape CD discs only for this unit.
2. Do not stick paper or tape etc., onto the label side or the recording side of any discs, as it may cause a malfunction.
3. Dirt, dust, scratches and warping discs will cause misoperation.

B. Notes on CD-Rs (recordable CDs)/CD-RWs (rewritable CDs):

1. Be sure to use discs with following marks only for the unit to play:



2. The unit cannot play a CD-R and CD-RW that is not finalized. (Please refer to the manual of your CD-R/CD-RW recorder or CD-R/CD-RW software for more information on finalization process).
 3. Depending on the recording status, conditions of the disc and the equipment used for the recording, some CD-Rs/CD-RWs may not be played on this unit. (See *1)
- *1: To have more reliable play back, please see following recommendations:
- a. Use CD-RWs with speed 1x to 4x and write with speed 1x to 2x.
 - b. Use CD-Rs with speed 1x to 8x and write with speed 1x to 2x.
 - c. Do not play a CD-RW which has been written for more than 5 times.

SPECIFICATION

GENERAL

Power Supply Requirements	: DC 12 Volts, Negative Ground
Chassis Dimensions	: 178 (W) x 178 (D) x 50 (H) mm
Tone Controls	
- Bass (at 100 Hz)	: ± 10 dB
- Treble (at 10 KHz)	: ± 10 dB
Maximum Output Power	: 4 x 50 Watts
Current Drain	: 15 Ampere (max.)

CD PLAYER

Signal to Noise Ratio	: More than 60 dB
Channel Separation	: More than 50 dB
Frequency Response	: 40 Hz - 18 KHz

RADIO

FM

Frequency Coverage	: 87.5 to 107.9 MHz
IF	: 10.7 MHz
Sensitivity (S/N = 30 dB)	: 3 μ V
Stereo Separation	: > 30 dB

AM

Frequency Coverage	: 530 to 1720 KHz
IF	: 450 KHz
Sensitivity (S/N = 20 dB)	: 32 dBu

TROUBLE SHOOTING

Before going through the check list, check wiring connection. If any of the problems persist after check list has been made, consult your nearest service dealer.

Symptom	Cause	Solution
No power.	The car ignition switch is not on.	If the power supply is connected to the car accessory circuits, but the engine is not moving, switch the ignition key to "ACC".
	The fuse is blown.	Replace the fuse.
Disc cannot be loaded or ejected.	Presence of CD disc inside the player.	Remove the disc in the player, then put a new one.
	Inserting the disc in reverse direction.	Insert the compact disc with the label facing upward.
	Compact disc is extremely dirty or defective disc.	Clean the disc or try to play a new one.
	Temperature inside the car is too high.	Cool off or until the ambient temperature return to normal.
	Condensation.	Leave the player off for an hour or so, then try again.
No sound.	Volume is in minimum.	Adjust volume to a desired level.
	Wiring is not properly connected.	Check wiring connection.
Sound skips.	The installation angle is more than 30 degrees.	Adjust the installation angle less than 30 degrees.
	The disc is extremely dirty or defective disc.	Clean the compact disc, then try to play a new one.
The operation keys do not work.	The built-in microcomputer is not operating properly due to noise.	Press the RESET button. Front panel is not properly fixed into its place.
The radio does not work. The radio station automatic selection does not work.	The antenna cable is not connected.	Insert the antenna cable firmly.
	The signals are too weak.	Select a station manually.

Free Manuals Download Website

<http://myh66.com>

<http://usermanuals.us>

<http://www.somanuals.com>

<http://www.4manuals.cc>

<http://www.manual-lib.com>

<http://www.404manual.com>

<http://www.luxmanual.com>

<http://aubethermostatmanual.com>

Golf course search by state

<http://golfingnear.com>

Email search by domain

<http://emailbydomain.com>

Auto manuals search

<http://auto.somanuals.com>

TV manuals search

<http://tv.somanuals.com>