

OPERATING INSTRUCTIONS

PYLE®



PLST70

Touch Screen 7" Motorized TFT/LCD Monitor With AM/FM-MPX Radio

OPERATING INSTRUCTIONS — **English**

WWW.PYLEAUDIO.COM

Welcome!

Thank you for purchasing our company digital media player!
To operate the unit correctly, please read the owner's manual carefully before using the unit. Keep these instructions and retain this booklet for future reference.

CONTENTS

Notes on Installation	3
Wiring Diagram	4
Introduction for Key board	5
Instruction for buttons	6
Location of the Remote Control	10
Remote Control Operation	11
Installation	17
Specification	18
Simple Troubleshooting Guide	19

Notes on installation

- ☞ The unit is designed for **12V DC**, negative ground operation system only. Before installing the unit, make sure your vehicle is connected to **DC 12V** negative ground electrical system.
- ☞ The negative battery terminal must be disconnected before making connections, which can reduce damaging the unit due to short circuit.
- ☞ Be sure to connect the color coded leads correctly according to the diagram. Incorrect connections may cause the unit malfunction or damage the vehicle's electrical system.
- ☞ Be sure to connect the speaker (-) leads to the speaker (-) terminal. Never connect the left and right channel speaker cables each other or to the vehicle body.
- ☞ Do not block vents or radiator panels. Blocking them will cause heat to build up inside and may result in fire.

- ☞ After the completion of the installation and begin to play the unit(including replacing the battery),please press the **RESET** button on the front panel with pointed objects (such as ball-point pen)to set the unit to initial status.

Wiring Diagram

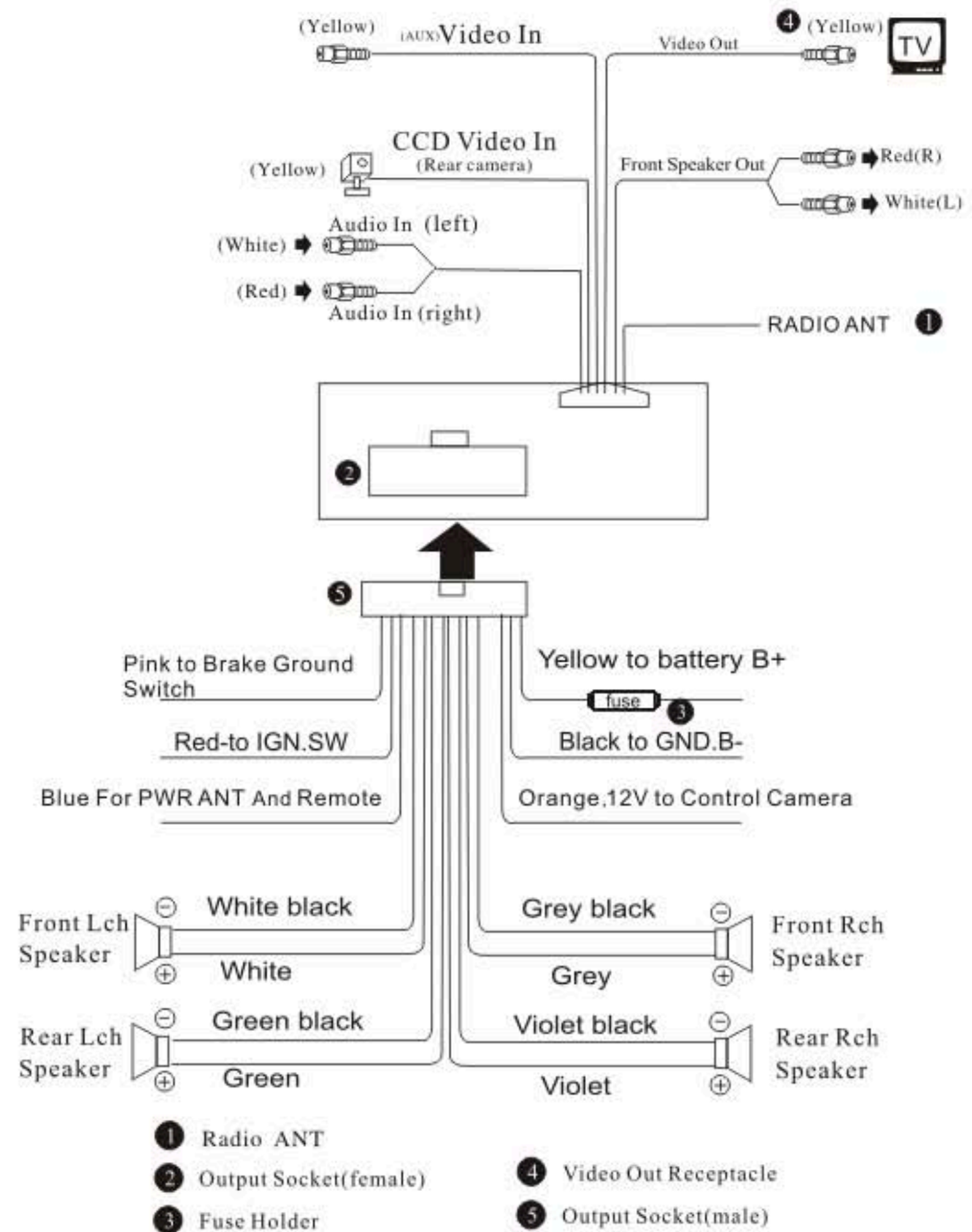

Introduction for Key board

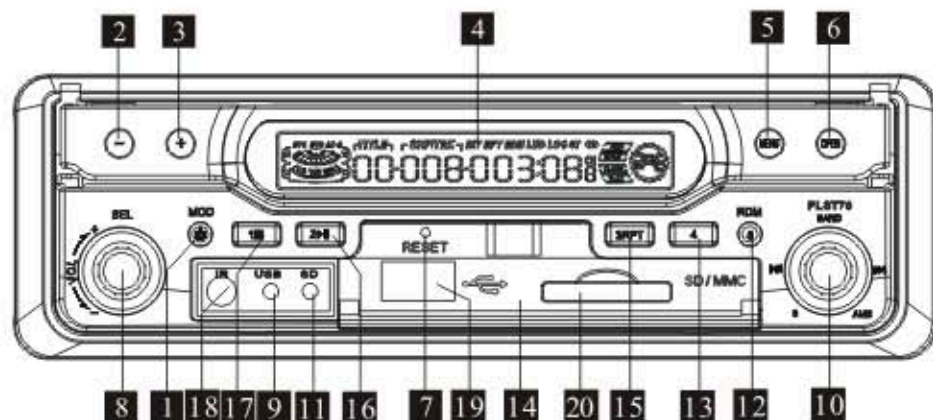

- | | |
|-----------------------------|---------------------------|
| 1. Power On/Off/Mode | 11. SD(LED Flash) |
| 2. Adjust Angle- | 12. Memory5/RDM |
| 3. Adjust Angle+ | 13. Memory4 |
| 4. LCD Display Window | 14. USB/SD Protection lid |
| 5. Screen/setting | 15. Memory3 / REPT |
| 6. Open TFT Screen | 16. Memory2/ Play/Pause |
| 7. Reset Button | 17. Memory1/Stop |
| 8. VOL/SEL | 18. Remote Sensor |
| 9. USB/LED | 19. USB Insert |
| 10. Ams / ◀ ▶ /Band/Memory6 | 20. SD Insert |

Instruction for buttons

- 1) Power On/Off/Mode
Press the button for less than 1 sec to switch on the power and depress the button for 3seconds to Switch off the power. when the set is on, press the button to select the Radio /Aux Sequentially. When insert USB or SD, press MODE to switch to USB or SD mode. The playing will be starting.
- 2) Adjust Angle-
Press the button to adjust the TFT Panel angle to your need
- 3) Adjust Angle+
Press the button to adjust the TFT Panel angle to your need
- 4) LCD Display Window
- 5) Screen/setting
- 6) Open TFT Screen
Press this button once the TFT Panel will be opened automatically and Press again to close the TFT Panel
- 7) Reset Button
Press the reset button on the control panel by using a ball-point pen or a similar tool. This will reset the built-in microcomputer
- 8) VOL/SEL Button
Rotate this button for increasing or decreasing the volume level. Press and hold for 1 second., the VOL/BAS/TRE/BAL/FADER will be on display by order. Rotate the button to select your desired sound level.
- 9) USB LED indication.
When insert USB, LED will turn on.
- 10) 1) AMS/|◀|▶|/Band/6 Memory/Button
During the Radio Mode, press BAND key to select FM1, FM2, FM3, MW1, MW2. Press |◀| key or |▶| key once to scan the frequency. Press and hold the key to start the auto scan. Press AMS button for Introduction of station. Press Memory 6
During playing MP3/MP4, press and hold |◀| for next track and |▶| for upper track. Press Band to display TV system NTSC, PAL by order.

Instruction for buttons



TFT Panel control

At the Radio mode, Touch the screen once, the TFT control Manual will be displayed on screen. Press the function icon or rotate the encoder key to adjust the sound/Picture to your desired level.

FMI: Current Channel

Repeat touch FM1 button to make a change for the wave band: FM1-- > FM2 --> FM3-- > AM1-- >AM2

1 : 87.5 2: 90.10 3: 98.10 4: 106.10 5: 107.90 6: 87.50 is pre-keep channel,these buttons is very convenient to let you choose the relative channel quickly, like when you click 3: 98.10,the unit's channel is 3: 98.10.

AMS: Automatic Scan/ Memory station

Press AMS button to scan /display the memory station by 10 seconds from 1-6 station, when start AMS function, the frequency flashes continuously until the appropriate station, then play the radio station by press 1-6 number key accordingly or AMS key.

When play AMS up than 3 seconds, will start the auto memory function, the radio will select the station automatically and store it on the number buttons. Remark: The machine at most store 6 stations per each frequency, pls refer to the number button operation to use number key.

Instruction for buttons

⏪ ⏩ : MTR/ETR

MTR: Press ⏪/⏩ to choose the different station up or down.

ETR: Press ⏪/⏩ up than 3 seconds, the radio will scan the stations up or down, and stays on the station when have program.

Play version

When play version, touch the middle of the screen by hand or sth else then will display:

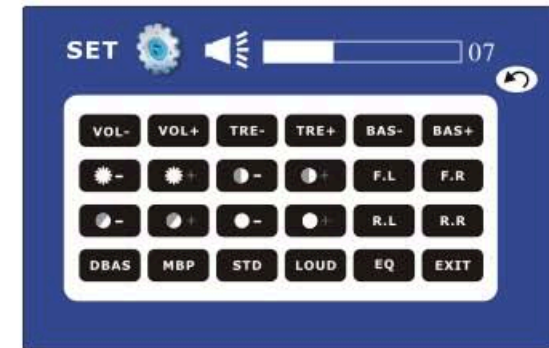

TFT Panel control

At the DVD mode, Touch the screen once, the TFT control Manual will be displayed on screen.

Press the function icon or rotate the encoder key to adjust the sound/Picture to your desired level.

Instruction for buttons

11) SD LED indicator.

When insert SD, LED will turn on.

12)Memory 5/ RDM

During radio mode, Press this button to preset the station memory for memory 5. during playing press it to random play.

13) Memory 4

While radio mode, Press this button preset the station memory for memory 4.

14) USB,SD protection lid

15) Memory3/ RPT

While radio mode, Press this button preset the station memory for memory 3. During the playing MP3, press this button to display PRT1, PRTDIR, OFF by order.

16) Memory 2/PLAY/PAUSE

While radio mode, Press this button preset the station memory for memory 2. During the playing MP3/MP4, press this button to switch to play or pause.

17)Memory 1/Stop

While radio mode, Press this button preset the station memory for memory 1. During the playing MP3/MP4, press this button to stop.

18)Remote Sensor

19) USB Insert

20) SD Insert

Location of the Remote Control

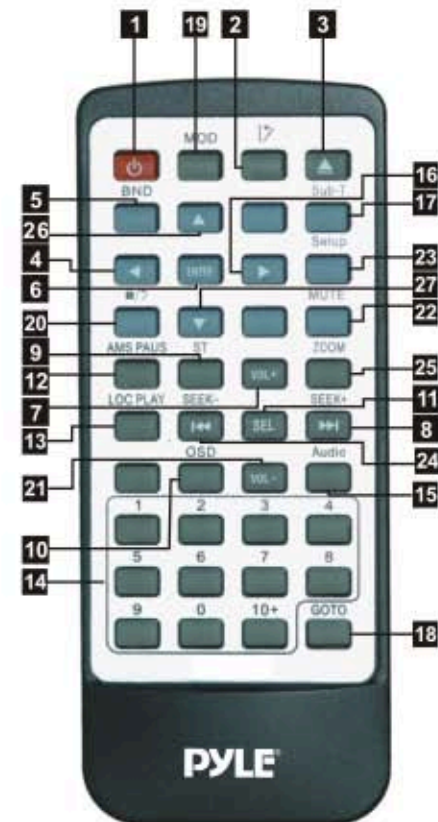

- | | |
|--|--|
| 1 Power On/Off | 14 Number keys |
| 2 Panel Angle Adjust | 15 Audio |
| 3 Open TFT Screen | 16 Direction Right |
| 4 Direction Left | 17 Sub-Title |
| 5 Band AM/FM | 18 Goto / Europe and America frequency switch |
| 6 Confirm | 19 Radio/USB/AUX |
| 7 Volume Up | 20 Stop/Resume |
| 8 Seek/Next Track | 21 Volume down |
| 9 Stereo | 22 Audio Mute |
| 10 MP3/MP4 On Screen Display | 23 SetUp |
| 11 Audio Selection Vol/Bal/TRF Bass/Fader | 24 Seek/Previous Track |
| 12 Auto Memory Scan/Hold | 25 Zoom |
| 13 Loccl/Distance/Play | 26 Direction UP |
| | 27 Direction Down |

Remote Control Operation

Replacing the battery

★ When the range of the operation of the card remote control becomes short or no functions while operating. Replace the battery with a new button cell. Make sure the battery polarity before replace.

1. Pull out the Battery Holder while pressing the Stopper ①

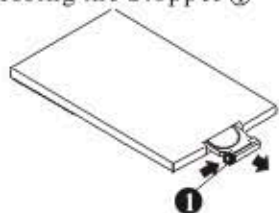

2. Put the button-type battery(+) mark upward into the Battery Holder.

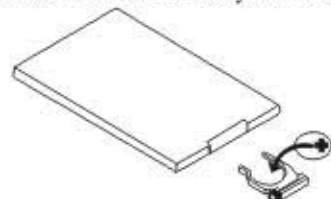

3. Insert the Battery Holder into the Remote Control.

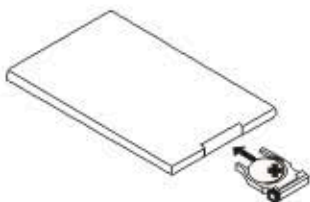

★ Note: Some models are not equipped with remote control, you should ignore the contents about remote control.

★ Power On/Off

— Press **1** (⏻) button to turn On/Off the power.

★ Panel Angle Adjust

— Press **2** (↗) button to adjust the TFT Panel angle to your need
Press the button to adjust the TFT Panel angle to your need

★ Open TFT Screen

— Press **3** (▲) button once the TFT Panel will be opened automatically and Press again to close the TFT Panel

★ Direction Left

— Press **4** (Δ/▽/◀/▶) to select your desired menu, then press **6** (ENTER) or press the play button **2** (▶) to confirm.

Note: This function works in main menu mode only. refer to page 13.

★ Band AM/FM

— During radio mode, press **5** (BAND) to switch Receiving band.

— At the playing mode, when it stops, press **5** (BAND) to switch NISC or PAL and AUTO

— During TV mode, press this button PAL/NTSC to switch

Remote Control Operation

★ Volume Up

— Press **7** (VOL+ or VOL-) button to increase or decrease the volume level respectively.

★ Seek/Next Track

— During radio mode, continuously press **8** (⏮ or ⏭) button to manual search a station downward or upward respectively; press and hold **8** (⏮ or ⏭) button, the radio will automatically search a station downward or upward respectively until it finds a station.

— During the playing mode, press **8** (⏮ or ⏭) to choose upward or downward. press and hold **8** (⏮ or ⏭) button to fast rewind or fast forward for you to reach your desired track quickly When discontinuously.

★ Stereo

During the radio mode, press **9** (ST) button to change the sound to left/right speaker or stereo mode.

★ MP4 On Screen Display

— During MP3, MP4 Mode, press **10** (OSD) button for the first time, The display shows single track elapsed time, single track left time or entire disc left time, press it again, the display shows MP3, MP4 Mode. and the track being played and the amount of the whole item.

When playing radio, press OSD for a long time, then press VOL+ or VOL- to adjust hour, then press SEL, press VOL+ or VOL- to adjust minute. If you don't operate this function, 5 seconds will return.

★ Audio Selection Vol/Bal/TRe/Bass/Fader

Press the **11** (SEL) button to increase or decrease the volume, Balance, Treble, Bass, Fader control levels.

★ Auto Memory Scan/TV Scan/Hold

During playing mode, firstly press **12** (AMS/PAUS) to stop the current track, press it again to continue playback.

Press **12** (AMS) button to scan each stored station 5 seconds respectively which stored in **14** (1-6) number buttons. When AMS mode is carried out, You also can press the corresponding number button or AMS button when your desired station is charged. It starts playing that station.

Press and hold **12** (AMS) button for more than 3 seconds to activate automatically memory storing function. The radio automatically selects a station and has it stored in any one of the number buttons **14** (1-6).

★ Loccl/Distance/Play

— During the playing mode, press **13** (LOC) button to show "play".
— During radio mode, press this button "LOC" will be shown on the display.

Remote Control Operation

★ Number keys

— During radio mode, you can select one of the 6 stored stations on each hand by pressing any one of the **number button 14**.

— During the playing mode, you can select any track directly by using **14 number button** (0~10+). For example, if you need the fifteenth track, you can first press button 10+ and then press button 5, the corresponding track (15)th will be played.

Note: When button 10+ is first pressed, it works as 10+. It works as 20+ when pressed at the second time, the third time ...30+...and the like.

XXXXXXXXXXXXXXXXXXXXXXXXXXXX

★ Audio

— During the playing mode, continuously press **15** (Audio) can change the sound to left / right speaker or stereo mode.

XXXXXXXXXXXXXXXXXXXXXXXXXXXX

★ Subtitle Selector

— During DVD file mode, press **17** (SUB-T) button to switch the menu to China or English.

XXXXXXXXXXXXXXXXXXXXXXXXXXXX

★ Setting CDs Playback Time

— In VCD format file, MP3 mode, press **18** (GOTO) key and set the time when you begin to play the track, and the television will display the

time --:--. Enter your desired time by pressing number button **14** (0~10+). For example, enter: **25:00**, press enter it will automatically start playing the track from point of the twenty-fifth minutes in the disc.

— In DVD format file playing mode, press **18** (GOTO) key once and input a desired track number, then press **13** key to play the DVD File from the position corresponding to the track number selected.

— In DVD format file playing mode, press **18** (GOTO) key and twice input a desired time to play the DVD File from the position corresponding to the time selected. For example, press **18** (GOTO) key and the television will display the time --:--. Enter your desired time by pressing number button **14** (0~10+) Then press **13** button, it will automatically start playing the track from point of your desired time in the disc.

— During radio mode, press this button to switch frequency, then press ENTER to confirm.

XXXXXXXXXXXXXXXXXXXXXXXXXXXX

★ Radio/USB/AUX

— Press **19** (MODE) button to switch to Radio/SD or USB /AUX, in turn, Insert USB/SD card then press mode enter into playing state automatically.

XXXXXXXXXXXXXXXXXXXXXXXXXXXX

Remote Control Operation

English

XXXXXXXXXXXXXXXXXXXXXXXXXXXX

★ Stop/Resume

— In MPEG4 mode, press **20** (STOP) button to suspend the playback and "Pre Stop" shown on TV, press it again to stop the playback.

XXXXXXXXXXXXXXXXXXXXXXXXXXXX

★ SET UP KEY

— In playing mode, press **23** key (Setup), menu will be showed on Screen. (see the picture)

Pressing **7** (ENTER) key to confirm after selecting your desired content: SYSTEM SETUP: TV system, video, TV type, password, rating, default the system can display N T S C, PAL, AUTO, when selecting tv system (shown as picture)



the system can display interface S-VIDEO, when selecting video (shown as picture)



the system can display 4:3ps, 4:3LB, 16:9 to adjust the size of tv, when selecting tv type (shown as picture)



It can set up password when selecting password (Shown as picture)

The password option is initialized locked, and you cannot set the ratings limit or change the password. In order for the Ratings feature work, the password mode must be turned on. If you want to set the ratings limit, you will need to enter the default password, which is 0000, then press Enter to confirm. To change the password, you will be prompted for the old password, then be prompted for a new. Enter a 4-digit number (this is your password).



the system can display Kid to Adult 8 options, when selecting Rating



the system can display restore, when selecting DEFAULT (Shown as picture)



Remote Control Operation

English

LANGUAGE SETUP: OSD language, audio lang, subtitle lang, menu lang, exit setup

the system can display English, Germany, Spaish, Franch, Portuguese, Latin, Italian for options when selecting OSD language (Shown as picture)



the system can display English, Germany, Spaish, Franch, Portuguese, Latin, Italian for options when selecting audio lang (Shown as picture)



the system can display English, Germany, Spaish, Franch, Portuguese, Latin, Italian for options when selecting subtitle (Shown as picture)



the system can display English, Germany, Spaish, Franch, Portuguese, Latin, Italian for options when selecting menu lang (Shown as picture)



the system can display WINCEN EU, WINWEST EU, ISOWEST EU, ISOCEN EU, CYRILLIC TURKISH for options when selecting DIVX LANG (Shown as picture)



Please select exit option for exit.

AUDIO SETUP: audio out, key, exit setup the system can display spdif/off, spdif/raw, spdif/pcm, when selecting audio out. (Shown as picture)



It can adjust the size when selecting key (Shown as picture)



VIDEO SETUP: brightness, contrast, hue saturation, sharpness, exit setup

It can adjust the brightness when selecting Brightness (Shown as picture)



It can adjust the contrast when selecting contrast (Shown as picture)



It can adjust the hue when selecting Hue. (Shown as picture)

Remote Control Operation

English

You can choose DYIVAMIC RANGE including FULL, 6/8, 4/8, and 2/8 when selecting DYIVAMIC RANGE. (Shown as picture)



The system will offer STEREO, MONO L, MONO R and MIX MONO (Shown as picture)



* ZOOM KEY

— In MPEG4 playing mode, press **25** (ZOOM) key once for 2x Mode, twice for 3x Mode, third time for 4x Mode, fourth time for 1/2x, five times for 1/3x, six times for 1/4x, seven times to off

Note: NO ZOOM function CD/MP3 playing mode.



It can adjust the saturation when selecting Saturation. (Shown as picture)



It can adjust the sharpness when selecting Sharpness. (Shown as picture)



DIGITAL SETUP: op mode, dynamic range, dual mono, exit setup.

The system will offer LINE OUT and RF REMOD to choose when selecting OP MODE. (Shown as picture)



Installation

Parts List (The numbers in the list are keyed to those in the instructions.)

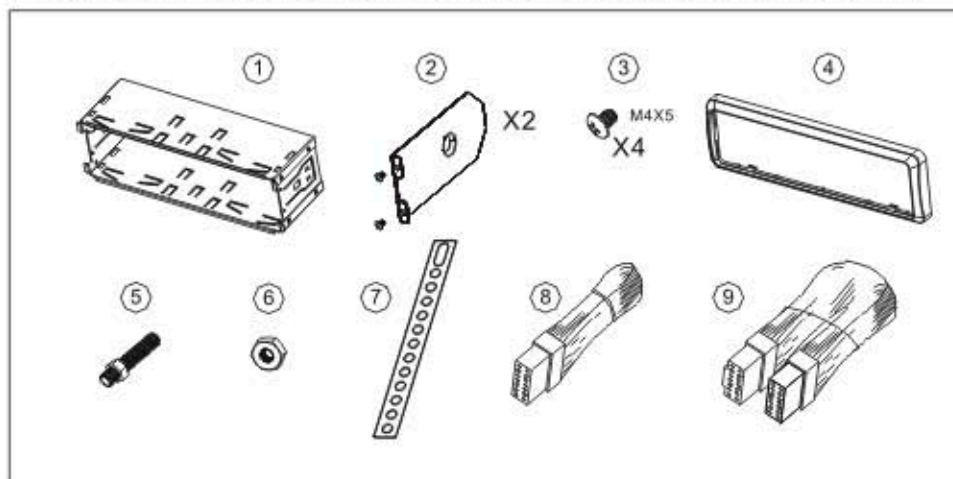

Mounting Example



Specification

General

Power Requirements.....	14.4VDC
Load Impedance.....	4Ω
Max. Power Output.....	80Wx4
Tone Controls.....	±8dB(Bass 100Hz, Treble 10KHz)
Dimensions.....	Approx.192x178x50mm(dxwxh)
Mounting Dimensions.....	Approx.169x182x53mm(dxwxh)
Weight.....	Approx. 2.2 kg

Video Section

Video System.....	AUTO/PAL/NTSC
Mounting Angle.....	0 to +/-30°
Video System.....	4:3 Letter Box and 4:3 Pan Scan
Video Output level.....	1.0Vp-p 75 ohms
Horizontal Resolution.....	500

Audio Section

Maximum Output level.....	2Vrms(+/-3dB)
Frequency Response.....	20 to 20KHz
Signal-to-noise Ratio.....	85dB
Separation.....	80dB

AM Tuner Section

Frequency Range.....	522-1620(Europe/China),530-1710(U.S.A)
IF Range.....	450KHz
Usable Sensitivity(-20dB).....	25dB

FM Tuner Section

Tuning Range.....	87.5-108(Europe/China),87.5-107.9(U.S.A)
IF Range.....	10.7MHz
Usable sensitivity (-30dB).....	15dB
Signal-to-noise Ratio.....	60dB
Stereo Separation.....	30dB(1KHz)
Frequency Response.....	30-15000Hz

★ Note: Due to continuous product improvement, specifications and design are subject to change without notice.

Simple Troubleshooting Guide

Problem	Cause/Solution
No power	★ Check and make sure whether the fuse is blown, replace with the proper value if necessary.
Some errors occur in the LCD or no function when pressing the button.	★ Press the RESET button.
Unable to receive stations.	★ Check and make sure whether the antenna is inserted or the antenna is properly connected. if so, insert the antenna or connect it properly.
Poor effect on receiving a station.	<ul style="list-style-type: none"> ★ Antenna may not be the proper length. Make sure the antenna is fully extended or broken: if broken. Replace the antenna with a new one. ★ The broadcasting signal is too weak. ★ The antenna is poorly grounded, check and make sure the antenna is properly grounded at its mounting location.
ACDs cannot be loaded.	★ ACDs is loaded in the mechanism.

★ Note: If any of the problem persist after check list has been made, consult your nearest service dealer. Never attempt to disassemble your unit by yourself.

Free Manuals Download Website

<http://myh66.com>

<http://usermanuals.us>

<http://www.somanuals.com>

<http://www.4manuals.cc>

<http://www.manual-lib.com>

<http://www.404manual.com>

<http://www.luxmanual.com>

<http://aubethermostatmanual.com>

Golf course search by state

<http://golfingnear.com>

Email search by domain

<http://emailbydomain.com>

Auto manuals search

<http://auto.somanuals.com>

TV manuals search

<http://tv.somanuals.com>