

## OWNER'S MANUAL

### Mobile Audio/Video System

---

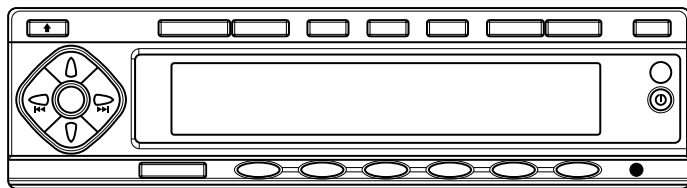
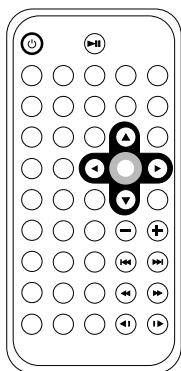

- **Digital Audio Out-Coaxial**
- **PLL Synthesizer Stereo Radio**
- **DVD Player**
- **Automatic Memory Storing**
- **Fold Down Detachable Panel**
- **Preset Equalization**
- **Multi-subtitle Languages Function**
- **Multi-audio Languages Function**
- **Multi-angle Function**
- **Parental Control**
- **Remote Control**

# FEATURES

## **Compatible with PAL DVD (Video CD) and NTSC DVD (Video CD)**

This player can play discs recorded in either PAL or NTSC format.

- A single LSI chip now integrates all major DVD playback circuit functions including MPEG2 decoder, video D/A converter, and audio decoders.
- L/R stereo analog audio outputs for connection to existing head unit aux inputs. Video output is composite video.
- Supplied remote handles multi-function software (multi-language audio-track/subtitle, multi-angle, multi-story, etc.), plus all basic functions.

## **Use Authorized Service Centres**

Do not attempt to disassemble or adjust this precision product. Please refer to the Service Centre list included with this product for service assistance.

## **For Installation**

The unit should be installed in a horizontal position with the front end up at a convenient angle, but not more than 30°.

# USE THIS PRODUCT SAFELY

## **When Driving**

Keep the volume level low enough to be aware of road and traffic conditions.

## **When Car Washing**

Do not expose the product to water or excessive moisture. This could cause electrical shorts, fire or other damage.

## **When Parked**

Parking in direct sunlight can produce very high temperatures inside your vehicle. Give the interior a chance to cool down before starting playback.

## **Use the Proper Power Supply**

This product is designed to operate with a 12 volt DC, negative ground battery system (the regular system in a North American car).

## **Protect the Disc Mechanism**

Avoid inserting any foreign objects into the slot of this player.

Failure to observe this may cause malfunction due to the precise mechanism of this unit.

# CONTENTS

---

<b>Safety Information</b> .....	<b>4</b>
<b>Disc Notes</b> .....	<b>5</b>
<b>Installation</b> .....	<b>6</b>
<b>Using the Detachable Front Panel</b> .....	<b>9</b>
<b>Wiring Connection</b> .....	<b>10</b>
<b>Location and Function of Keys</b> .....	<b>11</b>
The Player .....	11
Remote Control.....	12
<b>Remote Control</b> .....	<b>14</b>
Preparing the Remote Control .....	14
<b>Loading/Ejecting a disc</b> .....	<b>14</b>
Loading a disc .....	14
Ejecting a disc.....	14
<b>Operation</b> .....	<b>15</b>
Basic Operation .....	15
Radio Operation.....	16
Disc (DVD/VCD/CD/MP3) Operation .....	17
CDC Operation .....	22
DVD Changer Operation .....	22
AV IN Operation .....	23
<b>Setup</b> .....	<b>24</b>
Initial Setup .....	24
General Setup .....	24
Speaker Setup .....	26
Audio Setup .....	26
Preferences Setup .....	27
Defaults Table .....	30
<b>Trouble Shooting</b> .....	<b>31</b>
<b>Specifications</b> .....	<b>32</b>

# SAFETY INFORMATION

---

## CAUTION:

MOBILE DVD PLAYER IS A CLASS I LASER PRODUCT. HOWEVER THIS MOBILE DVD PLAYER USES A VISIBLE/INVISIBLE LASER BEAM WHICH COULD CAUSE HAZARDOUS RADIATION EXPOSURE IF DIRECTED. BE SURE TO OPERATE THE MOBILE DVD PLAYER CORRECTLY AS INSTRUCTED. USE OF CONTROLS OR ADJUSTMENTS OR PERFORMANCE OF PROCEDURES OTHER THAN THOSE SPECIFIED HEREIN MAY RESULT IN HAZARDOUS RADIATION EXPOSURE. DO NOT OPEN COVERS AND - DO NOT REPAIR YOURSELF. REFER SERVICING TO QUALIFIED PERSONNEL.

## WARNING:

- TO REDUCE THE RISK OF FIRE OR ELECTRIC SHOCK, DO NOT EXPOSE THIS EQUIPMENT TO RAIN OR MOISTURE.
- TO REDUCE THE RISK OF FIRE OR ELECTRIC SHOCK, AND ANNOYING INTERFERENCE, USE ONLY THE RECOMMENDED ACCESSORIES.
- THIS DEVICE IS INTENDED FOR CONTINUOUS OPERATION.

This product incorporates copyright protection technology that is protected by method claims of certain U.S. patents and other intellectual property rights owned by Macrovision Corporation and other rights owners. Use of this copyright protection technology must be authorized by Macrovision Corporation, and is intended for home and other limited viewing uses only unless otherwise authorized by Macrovision Corporation. Reverse engineering or disassembly is prohibited.

## Region Management Information

Region Management Information: This Mobile DVD Player is designed and manufactured to respond to the Region Management Information that is recorded on a DVD disc. If the Region number described on the DVD disc does not correspond to the Region number of this Mobile DVD Player, this Mobile DVD Player cannot play this disc.

# DISC NOTES

## Disc formats supported by this player



**DVD**  
12 cm disc



**Video CD**  
12 cm disc



**CD**  
12 cm disc



**MP3**  
12 cm disc

### Handling and Cleaning

- Dirt, dust, scratches and warping discs will cause misoperation.
- Do not place stickers or make scratches on discs.
- Do not warp discs.
- A disc should always be kept in its case when not in use to prevent from damaging.
- Do not place discs in the following places:
  1. Direct sunlight
  2. Dirty, dusty and damp areas
  3. Near car heaters
  4. On the seats or dashboard

### Disc Cleaning

Use a dry soft cloth to wipe the surface. If the disc is quite dirty, use a soft cloth slightly moistured with isopropyl (rubbing) alcohol. Never use solvents such as benzine, thinner or conventional record cleaners as they may mar the surface of the disc.

#### Note:

A disc may become somewhat scratched (although not enough to make it unusable) depending on your handle it and conditions in the usage environment. Note these scratches are not an indication of any problem with the player.

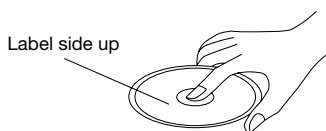

Label side up

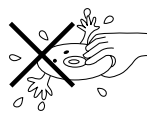

Do not touch the underside of the disc



Do not bend

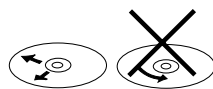

Wipe the disc from center toward the outside edge

### Preparing New Discs with Rough Spots

A new disc may have rough edges on its inside and outside edges. If a disc with rough edges is used, the proper setting will not be performed and the player will not play the disc. Therefore, remove the rough edges in advance by using a ball point pen or pencil as shown on the right. To remove the rough edges, press the side of the pen or pencil against the inside and outside edges of the disc.

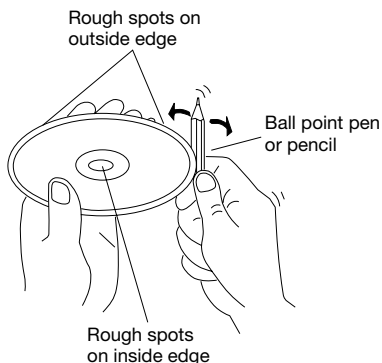

# INSTALLATION

## Notes:

- Choose the mounting location where the unit will not interfere with the normal driving function of the driver.
- Before finally installing the unit, connect the wiring temporarily and make sure it is all connected up properly and the unit and the system work properly.
- Use only the parts included with the unit to ensure proper installation. The use of unauthorized parts can cause malfunctions.
- Consult with your nearest dealer if installation requires the drilling of holes or other modifications of the vehicle.
- Install the unit where it does not get in the driver's way and cannot injure the passenger if there is a sudden stop, like an emergency stop.
- If installation angle exceeds 30° from horizontal, the unit might not give its optimum performance.

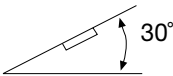

- Avoid installing the unit where it would be subject to high temperature, such as from direct sunlight, or from hot air, from the heater, or where it would be subject to dust, dirt or excessive vibration.

## DIN FRONT/REAR-MOUNT

This unit can be properly installed either from "Front" (conventional DIN Front-mount) or "Rear" (DIN Rear-mount installation, utilizing threaded screw holes at the sides of the unit chassis). For details, refer to the following illustrated installation methods.

## DIN FRONT-MOUNT (Method A) Installation Opening

This unit can be installed in any dashboard having an opening as shown below:

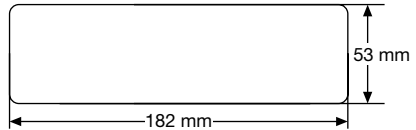

## Installing the unit

Be sure you test all connections first, and then follow these steps to install the unit.

1. Make sure the ignition is turned off, and then disconnect the cable from the vehicle battery's negative (-) terminal.
2. Disconnect the wire harness and the antenna.
3. Press the release button on the front panel and remove the control panel (see the steps of "removing the front panel").
4. Lift the top of the outer trim ring then pull it out to remove it.
5. The two supplied keys release tabs inside the unit's sleeve so you can remove it. Insert the keys as far as they will go (with the notches facing up) into the appropriate slots at the middle left and right sides of the unit. Then slide the sleeve off the back of the unit.

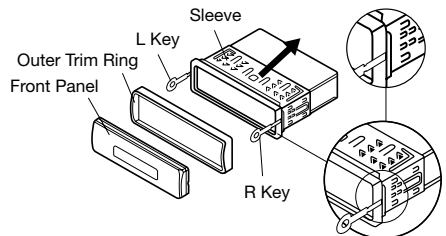

# INSTALLATION

6. Mount the sleeve by inserting the sleeve into the opening of the dashboard and bend open the tabs located around the sleeve with a screwdriver. Not all tabs will be able to make contact, so examine which ones will be most effective. Bending open the appropriate tabs behind the dashboard to secure the sleeve in place.

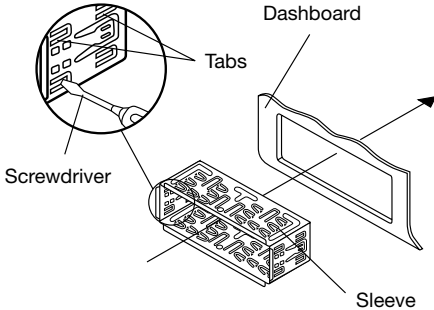

7. Reconnect the wire harness and the antenna and be careful not to pinch any wires or cables.
8. Slide the unit into the sleeve until it locks into place.
9. To further secure the unit, use the supplied metal strap to secure the back of the unit in place. Use the supplied hardware (Hex Nut (M5mm) and Spring Washer) to attach one end of the strap to the mounting bolt on the back of the unit. If necessary, bend the metal strap to fit your vehicle's mounting area. Then use the supplied hardware (Tapping Screw (5x25mm) and Plain Washer) to attach the other end of metal strap to a solid metal part of the vehicle under the dashboard. This strap also helps ensure proper electrical grounding of the unit.  
Note to install the short threading terminal of the mounting bolt to the back of the unit and the other long threading terminal to the dashboard.

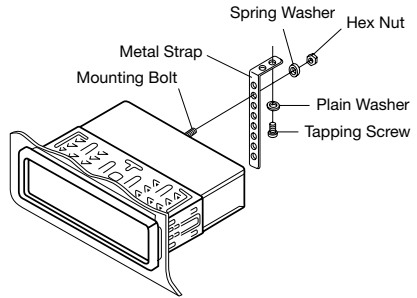

10. Reconnect the cable to the vehicle battery's negative (-) terminal. Then replace the outer trim ring and install the unit's front panel. (see the steps of "installing the front panel").

## Removing the unit

1. Make sure the ignition is turned off, then disconnect the cable from the vehicle battery's negative (-) terminal.
2. Remove the metal strap attached the back of the unit (if attached).
3. Press the release button to remove the front panel.
4. Lift the top of the outer trim ring then pull it out to remove it.
5. Insert both of the supplied keys into the slots at the middle left and right sides of the unit, then pull the unit out of the dashboard.

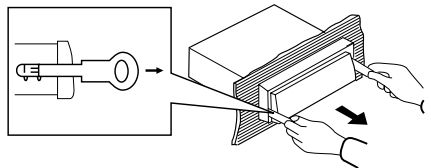

# INSTALLATION

## **DIN REAR-MOUNT (Method B)**

If your vehicle is a Nissan, Toyota, follow these mounting instructions.

Use the screw holes marked T (Toyota), N (Nissan) located on both sides of the unit to fasten the unit to the factory radio mounting brackets supplied with your vehicle.

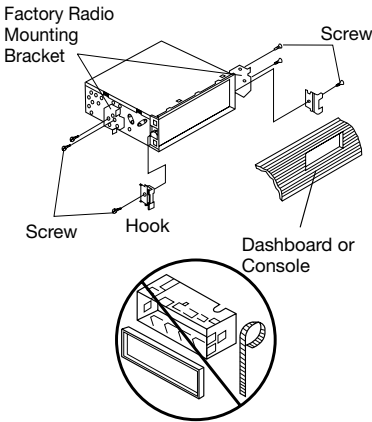
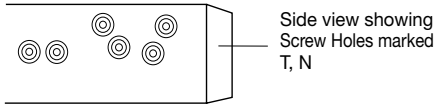

To fasten the unit to the factory radio mounting brackets.

1. Use a screwdriver to loose the hook's screws of the front left and right sides of the unit and remove the hooks.
2. Align the screw holes on the bracket with the screw holes on the unit, and then tighten the screws (5x5mm) on each side.

Note: the outer trim ring, sleeve and the metal strap are not used for method B installation.



# USING THE DETACHABLE FRONT PANEL

## To Detach the Front Panel

1. Press the **OPEN** button (OPEN) , then the front panel will be folded down.

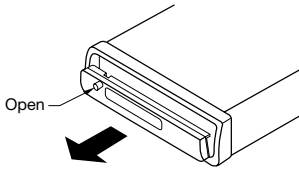

2. Remove the front panel by pulling its middle-hand side outward.

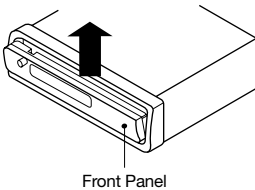

3. For safekeeping, store the front panel in the supplied protective case immediately after being removed.

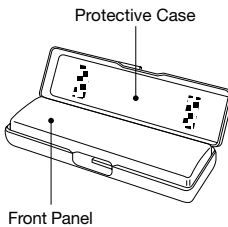

4. Push the front metal plate into the main body. A 'click' sound should be heard.

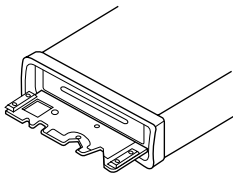

## To Reinstall the Front Panel

1. When the metal plate is folded down, insert the front panel into the metal plate then push them into the main body. A 'click' sound should be heard.

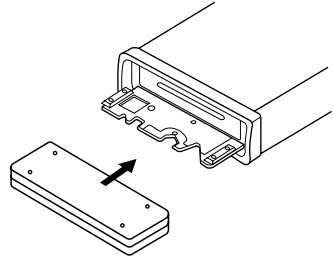

2. Note that if the front panel fails to lock in position properly, pressing control button may not function and display may be missing some segments. Press the **OPEN** button and then reinstall the front panel again.

## Precautions when Handling

1. Do not drop the front panel.
2. Do not put pressure on the display or control buttons when detaching or reinstalling the front panel.
3. Do not touch the contacts on the front panel or on the main unit body. It may result in poor electrical contact.
4. If any dirt or foreign substances adhered on the contacts, they can be removed with a clean and dry cloth.
5. Do not expose the front panel to high temperatures or direct sunlight in anywhere.
6. Keep away any volatile agents (e.g. benzene, thinner, or insecticides) from touching the surface of the front panel.
7. Do not attempt to disassemble the front panel.

# WIRING CONNECTION

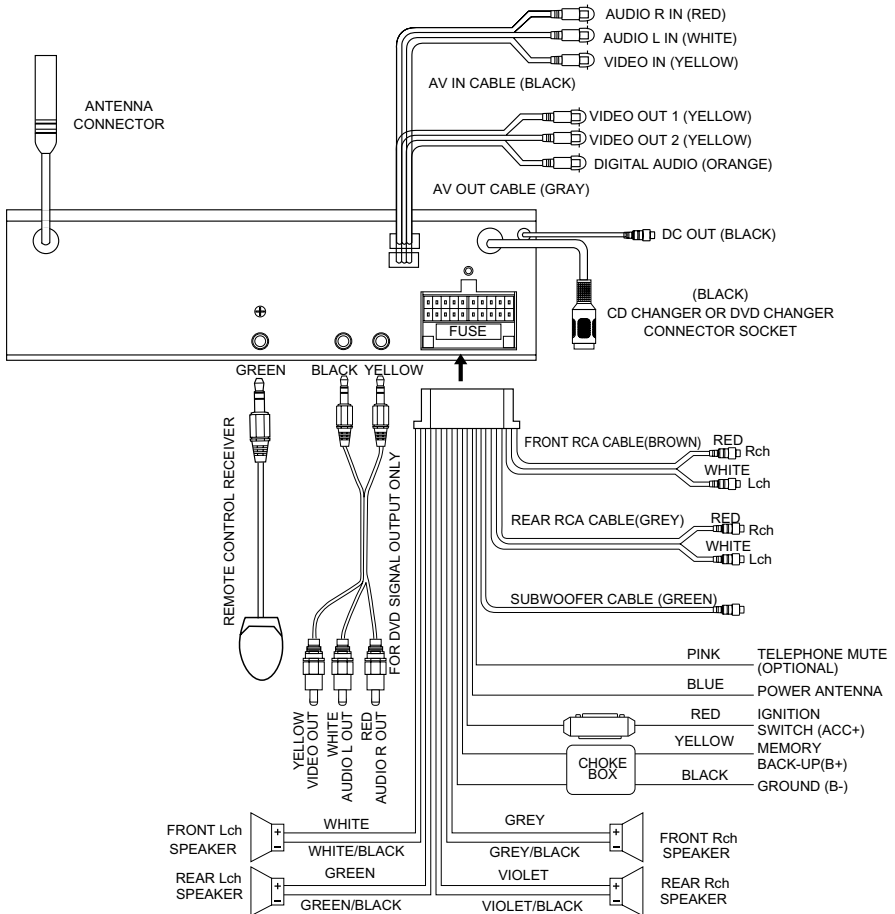

## MUTE WHILE TELEPHONING

If your unit is connected to a mobile telephone through the telephone mute line, the car radio's volume will be muted as soon as you "pick up" the telephone. "TEL MUTE" flashes in the display.

# LOCATION AND FUNCTION OF KEYS

## THE PLAYER

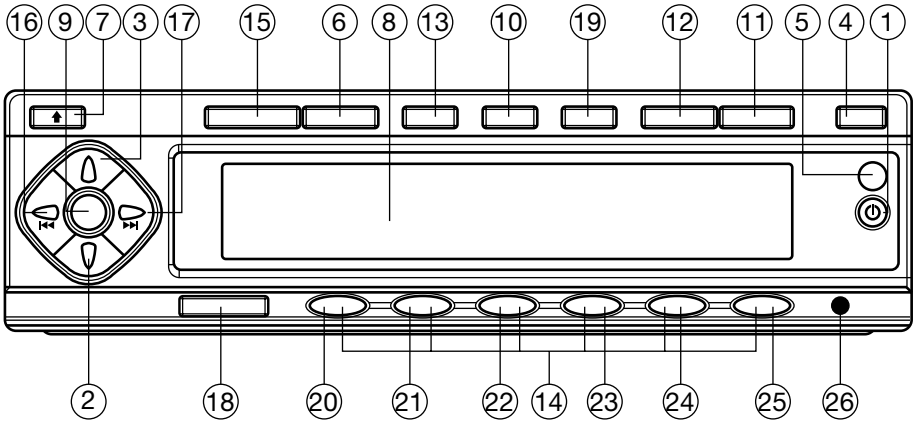

- 1. ⏻ (PWR/ILL)
- 2. ▲
- 3. ▼
- 4. DISP
- 5. IR
- 6. MODE/(SW)
- 7. OPEN
- 8. Vacuum Fluorescent Display
- 9. MUT/ENT
- 10. ST/LOC/TITLE
- 11. VOL+
- 12. VOL-
- 13. MENU/BAND
- 14. 1-6 preset buttons
- 15. SMART
- 16. ⏪
- 17. ⏩
- 18. AMS/ STOP
- 19. SEL
- 20. ▶||
- 21. SCN
- 22. RPT
- 23. SHF
- 24. CD-
- 25. CD+
- 26. Reset button

**When remove the front panel:**

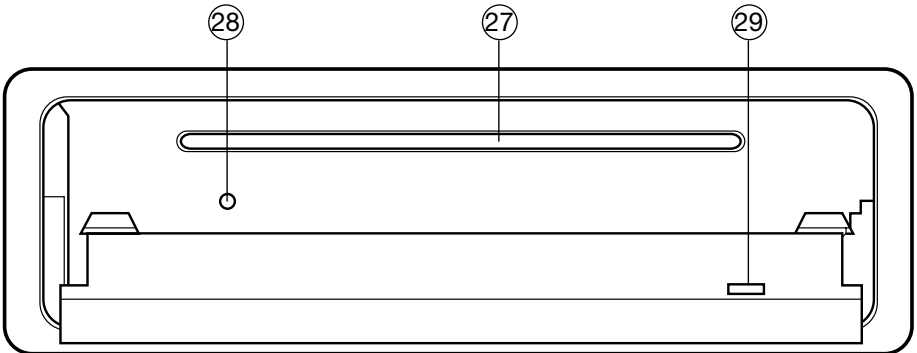

- 27. Disc Slot
- 28. LED
- 29. Eject button





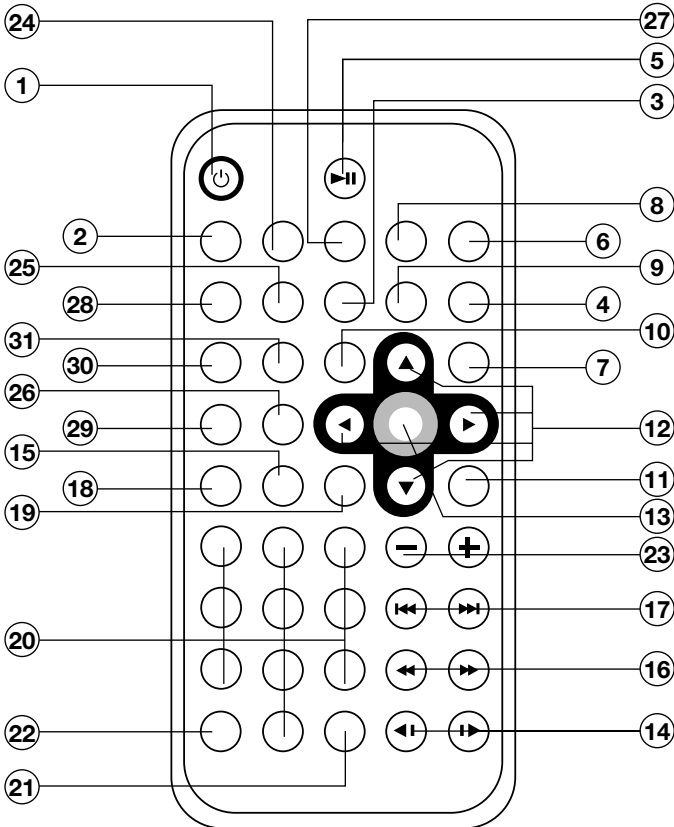















# LOCATION AND FUNCTION OF KEYS

## REMOTE CONTROL



# LOCATION AND FUNCTION OF KEYS

---

1.  POWER/ILL Press it to turn the unit on.  
When system is on, press shortly to control the brightness of VFD.  
Press it for several seconds to turn off the unit.
2. SMART (DISC) In DVD mode, press it shortly to enter SMART MODE function.  
(For details, refer to the following text).  
In DVD changer mode, press DISC button to select another disc.
3. A-B A-B repeat allows a passage to be repeated continuously.
4. ANGLE Changing of the view angle on multi-angle DVD disc.
5.  Press to play/pause the disc.
6. MODE (SW) Changing between radio mode, disc (DVD/VCD/CD/MP3) play mode, CDC mode and AV IN mode.  
Press it for several seconds to toggle sub-woofer output. Press it for several seconds again to release this mode.
7. ZOOM Allows the picture to be increased in size.
8. MUTE Press to mute the sound.
9. SUBTITLE Changing of the SUBTITLE language on multi-subtitle language DVD disc.
10. SETUP Display the SETUP menu.
11. SEL Press to select the desired adjustment mode. Then press VOL+/- to change settings.
12.  In case of menu mode, ,  buttons served as cursor buttons to select item left/right, ahead/back.
13. OK Confirm the Track/Chapter selected with the numeric buttons or selected with the cursor buttons on screen display.
14.  Changing for slow playback motion (For VCD/DVD).
15. ST (TITLE) Display the TITLE menu that is stored in DVD disc.  
In radio mode, press it shortly to select mono or stereo mode. Press and hold it for a long time to select between local and distant stations.
16.  Press  to search forward rapidly &  to search reverse rapidly.  
In radio mode, press  /  shortly to increase or decrease frequency by one step of channel spacing.
17.  /  Press  to skip to the next track & press  to skip back one track.  
In radio mode, press  /  shortly to activate automatic seek function. When hold for several seconds until "MANUAL" appears, the manual tuning mode is selected.  
When the clock flashing, use  /  to adjust the minutes or hours.
18. AUDIO Press the button to change the AUDIO soundtrack on multi-audio soundtrack DVD disc. Press the button to change the sound mode of the VCD discs.
19. EQ Press it to select the equalization mode, such as FLAT, CLAS, POP, ROCK.
20. 0-9 Numeric buttons
21. PBC Changing between PBC ON and PBC OFF on the VCD disc.
22. GOTO Disc search button, cooperatively used with numeric buttons.
23. VOLUME+/- Press VOLUME+/- button to increase or decrease the volume level.
24. DISPLAY Display statistical disc information during playback.  
Press it to display the clock, hold down the button until the clock flashes, then use  /  to adjust the minutes or hours.
25. REPEAT Switch the Repeat mode of discs.
26. P/N Switch between PAL mode and NTSC mode.
27. PROGRAM Allows the track played in the order you programmed (For MP3/CD).
28. SHUFFLE Allows the track played in random order (NOT for DVD).
29. RESUME When in stop mode, press the button, the play can be resumed from the stop point.
30. AMS (STOP) In radio mode, press for several seconds to enter into automatic memory storing function; press shortly to scan preset station. During disc playing, press it to stop disc playback.
31. BND (MENU) In DVD mode, display the root menu that is stored on the DVD disc or return to disc menu on the VCD discs.  
In radio mode, press it to select desired band.

# REMOTE CONTROL

---

## Preparing the Remote Control Inserting the Batteries

1. Open the battery compartment cover.
  2. Insert the new battery. Make sure that the positive and negative terminals of the battery are oriented as indicated.
  3. Close the cover.
- Battery: a button cell lithium battery (CR2025 3V)

## Using the Remote Control

Point the remote control towards the player front face remote sensor **IR** (remote control signal receiver).

Operation angle: About  $\pm 30$  degree in each the direction of the front of the remote sensor.

# LOADING/EJECTING A DISC

---

## Loading a Disc

When all connections have completed, you can load a disc as follow:

1. Turn the ignition on to the accessory position.
2. Press the **PWR/ILL** button on the front panel or **POWER/ILL** button on the remote control to turn on the unit.
3. Press **OPEN** button on the front panel to fold down the panel.

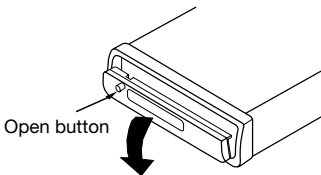

4. Insert the disc with printed side facing up into the disc slot.
5. The player will start playback automatically.

## Ejecting a Disc

When the front panel is folded down, press **▲** button on the back of the front panel to eject the disc.

# OPERATION

## BASIC OPERATION

### SWITCHING ON/OFF THE UNIT AND ILLUMINATING

Press **PWR/ILL** button on the front panel or **POWER/ILL** button on the remote control to turn on the unit. When system is on, press **PWR/ILL** or **POWER/ILL** button shortly to control the brightness of VFD. Press the button for several seconds to turn off the unit.

### FACEPLATE RELEASE

Press **OPEN** button on the front panel to detach the removable faceplate.

### SOUND ADJUSTMENT

Press **SEL** button on the front panel of the unit or on the remote control to select the desired adjustment mode. The adjustment mode will change in the following order:

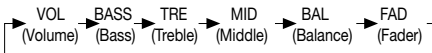

By pressing the **VOL+/-** buttons on the front panel or **VOLUME +/-** buttons on the remote control, it is possible to adjust the desired sound quality.

### SET THE CLOCK

Press the **DISP** button on the front panel or **DISPLAY** button on the remote control, the clock is shown on the display. Then hold down the **DISP** button or **DISPLAY** button until the clock flashes. Then press **▶▶** button on the front panel or **▶▶** button on the remote control to change minutes; press **◀◀** on the front panel or **◀◀** button on the remote control to change hours.

### MUTE

Press and hold **MUT/ENT** button on the front panel for several seconds or press **MUTE** button on the remote control to mute down the sound instantly. Press it again to resume sound output.

### EQUALIZATION

Press **EQ** button on the remote control to turn on equalization function and to select desired audio mode. There are five kinds of mode as below:

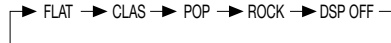

### SUBWOOFER

Press **MODE (SW)** button on the front panel or on the remote control for several seconds to toggle sub-woofer output. Press it for several seconds again to release this mode.

### MODE SELECTION

Press **MODE** button on the front panel of the unit or **MODE** button on the remote control to select among radio, disc (DVD/VCD/CD/MP3) play mode, CDC mode and AV IN mode.

### VACUUM FLUORESCENT DISPLAY

Exhibit current frequency and activated functions on the display of the front panel.

### FLASHING LED

If the front panel does not install in the main unit, the LED will be flashing.

### REMOTE SENSOR

Point the remote control handset to the remote sensor **IR**. Press the function keys on the handset to control the system.

### RESET FUNCTION

**RESET** button must be activated with either a ballpoint pen or thin metal object. The **RESET** button is to be activated for the following reasons:

- Initial installation of the unit when all wiring is completed.
- All the function buttons do not operate.
- Error symbol on the display.

Note: if press **RESET** button, the unit can't work yet, please use a cotton swab soaked in isopropyl alcohol to clean the socket on the front panel.

# OPERATION

## RADIO OPERATION

### SWITCHING TO RADIO MODE

Press **MODE** on the front panel or **MODE** on the remote control to select radio mode, the radio mode appears in the display together with the memory band and frequency.

### SELECTING THE FREQUENCY BAND

During radio mode, shortly press **MENU (BAND)** button on the front panel or **BND (MENU)** button on the remote control to select the desired band. The reception band will change in the following order:

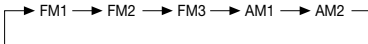

### SELECTING STATION

Press **▶▶** / **◀◀** buttons on the remote control or **▶▶** / **◀◀** buttons on the front panel shortly to activate automatic seek function. Press and hold **▶▶** / **◀◀** buttons for several seconds until “MANUAL” appears on the display, the manual tuning mode is selected.

Then shortly press **▶▶** / **◀◀** buttons to increase or decrease frequency by one step of channel spacing, hold the buttons longer for fast tuning. If both buttons have not been pressed for several seconds, it will return to seek tuning mode and “AUTO” appears on the display.

Shortly press **◀◀** / **▶▶** buttons on the remote control or **▲** / **▼** buttons on the front panel to increase or decrease frequency by one step of channel spacing. The frequency is updated correspondingly on display.

### LOCAL/DISTANT

Press and hold **ST/LOC/TITLE** button on the front panel or **ST/TITLE** button on the remote control for several seconds to select between local and distant stations. Local setting for reception of strong station, and a distant setting for reception of weaker stations. This function is effect during AUTO SEEK operation.

### AUTOMATIC MEMORY STORING & PROGRAM SCANNING

- Automatic memory storing  
Press and hold **AMS** button on the front

panel or on the remote control for several seconds, the radio searches from the FM1 the initial frequency and checks the signal strength until one cycle search is finished. And then 6 strongest stations are stored into the corresponding preset number button.

- Program scanning  
Press **AMS** button shortly to scan preset station.

### STATION STORING

Press any one of the preset buttons (1 to 6) on the front panel to select a station, which had been stored in the memory. Press this button for several seconds, current station is stored into the number button.

### MONO/STEREO

Press **ST/LOC/TITLE** button on the front panel or **ST/TITLE** button on the remote control shortly to select mono or stereo mode. You can sometimes improve reception of distant stations by selecting mono operation.

### SCAN

Press **MUT/ENT** button on the front panel shortly to set function to scan mode, which scanning to higher frequency station with receivable signal and keep on each station for several seconds.



# OPERATION

## DISC (DVD/VCD/CD/MP3) OPERATION STOPPING PLAY

- Briefly press the **AMS/STOP** button on the front panel or **AMS (STOP)** button on the remote control to stop the unit playback, when the **▶||** button is pressed, normal playback will continue.
- Press **AMS/STOP** button or **AMS (STOP)** button twice to stop the playback and go back to initial Track/Chapter.

## RAPID FORWARD/RAPID REVERSE

Press **▶▶** & **◀◀** during play. Each time the button is pressed, the speed of rapid forward/reverse changes according to the disc as follow:

FOR DVD/MP3:

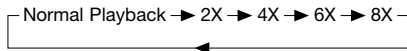

FOR VCD/CD:

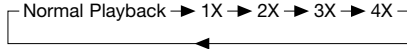

## SKIPPING TRACK

Press **▶|** / **|◀** buttons on the front panel or **▶|** / **|◀** buttons on the remote control during playback.

Press **▶|** to skip to next track, and **|◀** to back one track.

Note: For some VCD 2.0 discs (PBC-playback control), **▶|** / **|◀** buttons may be unavailable.

## SLOW MOTION PLAY

Press **◀|** / **|▶** button on the remote control during play.

Each time the button is pressed, the speed of slow forward changes according to the disc as follow:

FOR DVD:

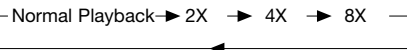

FOR VCD:

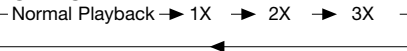

## PAUSING PLAYING

Pressing **▶||** on the remote control or on the front panel during playback will stop play temporary. To return to normal playback, press **▶||** once again.

## REPEATING PLAYING

FOR DVD:

Press **RPT** button on the front panel or **REPEAT** button on the remote control to select repeat mode as follow:



FOR VCD/CD:

In stop mode, press **RPT** button or **REPEAT** button to select repeat mode as follow:



1. Continuously repeat at the current chapter/track, when selected REP-ONE mode.
2. Select REP-ALL mode to continuously repeat all chapter/track on the current disc.
3. When the player finishes playback the current disc last chapter/track, it will stop display the elapsed time. When selected REPEAT OFF mode, REP-ONE & REP-ALL disappear at screen display.
4. REPEAT feature does not support VCD2.0 (with PBC ON).

## PBC FUNCTION

While the VCD disc is playing, press **MENU (BAND)** button on the DVD unit or **PBC** button on the remote control to change between PBC ON and PBC OFF on the VCD disc.

## ZOOM FUNCTION

Allows the picture to be increased in size. Press **ZOOM** button on the remote control to toggle among 1.5 scale, 2.0 scale and 3.0 scale.

When the scale is 3 times, press **ZOOM** button again to cancel the zoom function.

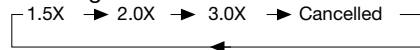

During Zoom mode, press **▲** / **▼**, **◀** / **▶** buttons to move pictures up, down, left or right direction.

## REPEATING PLAYING A PASSAGE

A-B repeat allows a passage to be repeated continuously. Press **A-B** button

# OPERATION

on the remote control at the start of the required passage, then press **A-B** button again at the end of the passage. To revert to normal playing, press **A-B** button again. Each time the button is pressed, the screen will display as follows:

A TO B SET A → A TO B SET B → A TO B CANCELLED

## TIME SEARCH (GOTO)

FOR DVD

Press **GOTO** button on the remote control twice, the screen will display the following message:

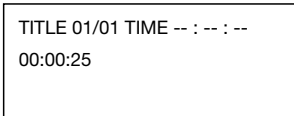

TITLE 01/01 TIME -- : -- : --  
00:00:25

You can select the item you want to watch through TIME setting by using numeric buttons and **MUT/ENT** button on the front panel or **OK** button on the remote control.

FOR CD/VCD (WITH PBC OFF):

Press **GOTO** button once, the screen will display the following message:

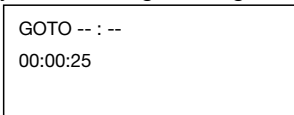

GOTO -- : --  
00:00:25

Use numeric buttons to input the time directly.

## PLAYING IN RANDOM ORDER (ONLY FOR VCD/CD/MP3)

Press **SHF** on the front panel or **SHUFFLE** button on the remote control, track selection will be made in random order. The display screen will show "SHUFFLE ON" on the screen. Then press **▶||** button to start SHUFFLE playback. Press **SHF** button or **SHUFFLE** button again in stop mode, "SHUFFLE OFF" appears and release the mode.

## PREVIEWING PLAYING (ONLY FOR VCD/CD/MP3)

Press **SCN** button on the front panel to play first several seconds of each track on the current disc. Press again to stop intro and listen to track.

## PLAYING IN PROGRAMMED ORDER

For CD/VCD (WITH PBC OFF):

Press the **STOP** button twice to ensure that the player is in STOP mode. Then press **PROGRAM** button, the screen will display "PROGRAM P00:00". For example: press numeric button 4, "PROGRAM P01:04" appears, it means track 4 will be played first, then press numeric button 6 and "PROGRAM P02:06" appears. Press the different numeric button to select the corresponding track, and then press **OK** button to confirm. If there isn't any operation, it will confirm the inputs automatically after five seconds. Then press **▶||** button or **OK** button to exit program mode and play tracks in programmed order.

When playing in programmed order, press **STOP** button twice, then press **PROGRAM** button, and then press **OK** button, it will play in normal order. For MP3:

In stop mode, press **PROGRAM** button, the screen will display "PROGRAM P00:0000" and the program method is the same as described above. If you want to complete program setting, press **AMS/STOP** button first then press **▶** button to play tracks in programmed order. In stop mode press **PROGRAM** button to exit program mode and "PROGRAM OFF" appears.

If you set WITH MENU in SMART NAV item in PREFERENCES PAGE, you can use **▲/▼**, **◀/▶** buttons to select PROGRAM PXXX mode or track number and press **OK** button to confirm it.

# OPERATION

## ON-SCREEN DISPLAY FUNCTION

Press the **DISPLAY** button during playback to display the contents of the current disc on the screen.

Example:

FOR DVD:

(1) Press **DISPLAY** for the first time:

```
TITLE 01/03 CHAPTER 002/025
00:02:25
```

Title Number, Total Title Number, Chapter Number, Total Chapter Number of this Title of the disc currently being played will be shown on the screen, along with the elapsed time.

(2) Press **DISPLAY** for the second time:

```
TITLE REMAIN
01:46:58
```

(3) Press **DISPLAY** for the third time:

```
CHAPTER ELAPSED
00:00:24
```

(4) Press **DISPLAY** for the fourth time:

```
CHAPTER REMAIN
00:01:39
```

(5) Press **DISPLAY** for the fifth time:

The message on the screen will be cleared.

FOR VCD:

(1) Press **DISPLAY** for the first time:

```
SINGLE ELAPSED
00:25 01/13
```

(2) Press **DISPLAY** for the second time:

```
SINGLE REMAIN
03:15 01/13
```

(3) Press **DISPLAY** for the third time:

```
TOTAL ELAPSED
00:25 01/13
```

(4) Press **DISPLAY** for the fourth time:

```
TOTAL REMAIN
40:35 01/13
```

(5) Press **DISPLAY** for the fifth time:

The message on the screen will be cleared.

FOR CD:

(1) Press **DISPLAY** for the first time:

```
SINGLE ELAPSED
00:00:25

TRACK: 01/14
```

(2) Press **DISPLAY** for the second time:

```
SINGLE REMAIN
00:03:15

TRACK: 01/14
```

(3) Press **DISPLAY** for the third time:

```
TOTAL ELAPSED
00:00:25

TRACK: 01/14
```

# OPERATION

- (4) Press **DISPLAY** for the fourth time:

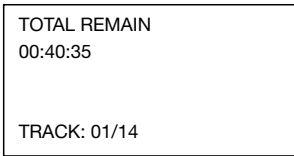

- (5) Press **DISPLAY** for the fifth time:  
The message on the screen will be cleared.

FOR MP3:

- (1) Press **DISPLAY** for the first time:

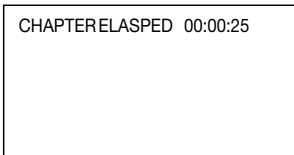

- (2) Press **DISPLAY** for the second time:

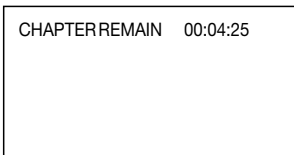

- (3) Press **DISPLAY** for the third time:  
The message on the screen will be cleared.

## MULTI-AUDIO LANGUAGE FUNCTION

### For DVD:

Press **AUDIO** button on the remote control during playback. Each time the button is pressed long, the audio soundtrack language changes on sequential order.

Notes:

- The language number is different according to the disc.
- Some discs only contain one language soundtrack.
- When no different language soundtrack are recorded,  will be displayed at screen left top corner.

### For VCD:

Press **AUDIO** button on the remote control during playback. It is possible to switch the sound between mono and stereo sound.



## MENU FUNCTION (For DVD ONLY)

Press **MENU (BAND)** button on the DVD unit or **BND (MENU)** button on the remote control while the disc is playing and the disc root menu will be displayed. You can navigate with the remote control navigation keys and select a feature with the **MUT/ENT** button on the DVD unit or **OK** button on the remote control.

## TITLE MENU FUNCTION (FOR DVD ONLY)

If the DVD has multiple titles recorded on the disc. It can select preferred title from the title menu to start playback.

1. Press **ST/LOC/TITLE** button on the front panel of the DVD unit or **ST/TITLE** button on the remote control during playback.
  - The title menu is display.
2. Select preferred title by the cursor button and confirm by **MUT/ENT** button on the DVD unit or **OK** button on the remote control.

## MULTI-SUBTITLE LANGUAGE FUNCTION (FOR DVD ONLY)

Press **SUBTITLE** during playback. Each time the button is pressed, the subtitle language changes in sequential order.

Notes:

- The language number is different according to the disc.
- Some discs only contain one subtitle language.
- When no different subtitle language are recorded,  will be displayed at screen left top corner.

## MULTI-ANGLE FUNCTION (FOR DVD ONLY)

Press **ANGLE** during playback. Each time the button is pressed, the angle changes in sequential order.

Notes:

- The angle number is different according to the disc.
- The function only works for discs having scenes recorded at different angles.
- When no different angle are recorded,  will be displayed at screen left top corner.

# OPERATION

## SMART MODE FUNCTION

In DVD mode, press **SMART** button on the DVD unit or **SMART** button on the remote control shortly during disc playback to activate SMART MODE function and "SMART MODE" appears on the display of the DVD unit. When press **MODE** button to switch to radio or AV IN mode or CDC mode, the front speakers will output the corresponding radio audio signal or audio signal of the AV source or audio signal of the CDC source, and the rear speakers will be muted. In any mode (radio or AV IN or CDC), the DVD disc is playing and the video out 1 and 2 jacks output the video signal of DVD all the while.

When you press **SMART** button or **SMART** button shortly during disc playback to activate SMART MODE function. In any mode, press and hold **SMART** button or **SMART** button for several seconds, "SMART MODE" will be flashing. When you press **MODE** button to switch to radio or AV IN mode or CDC mode, the front speakers will output the corresponding radio audio signal or audio signal of the AV source or audio signal of the CDC source, and the rear speakers will be muted.

But when switch to AV IN mode or CDC, the video out 1 and 2 jacks will not output the video signal of DVD source any more. In AV IN mode, these two jacks output the video signal of AV IN source and in CDC mode, there isn't any video signal to output from the two video output jacks.

When SMART MODE is activated, press **MODE** button to switch to DVD mode, press **SMART** button or **SMART** button to release this function.

## SMART NAVIGATION IN MP3 DISC PLAY

MP3 disc is playing as the format of FOLDER.

For example:

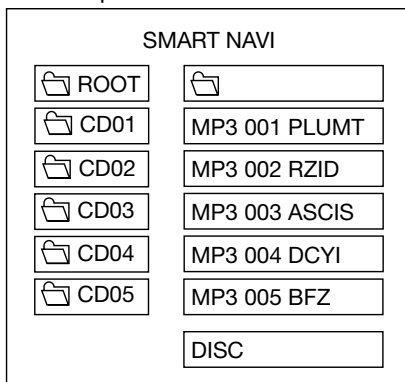

In stop mode, use **▲/▼/◀/▶** on the remote control to select the item or folder (such as CD01, CD02...), and press **MUT/ENT** button on the DVD unit or **OK** button on the remote control to confirm, then select the desired track (such as 001 PLUMT, 002 RZID...) on the current folder to play.

Pressing **RPT** button on the front panel or **REPEAT** button on the remote control repeatedly can select two kinds of repeat play mode.

**REP-ONE**: Play the same song over and again.

**FOLDER REP**: Play all songs in the current directory in sequence, over and again.

**FOLDER**: Play all songs in the current directory once.

When **PLAY MODE** is selected, press **▲/▼** to change between the following mode:

SINGLE → REP-ONE → FOLDER → FOLDER REP →

DISC SCAN → **DISC** → DISC REP →

SHUFFLE ON → PROGRAM PXXX

Pressing **SHF** on the front panel or **SHUFFLE** button on the remote control to play tracks in random order. Press **SHF** button or **SHUFFLE** button again to release the mode.

During playback, use **▶▶/◀◀** to skip an item ahead or back.

**◀◀**: Rapid reverse, **▶▶**: Rapid advance

Note: The **FOLDER** cannot be selected during playing. It can be selected after

**AMS (STOP)** button pressed.

# OPERATION

---

## CDC OPERATION

You can connect a CD changer to the unit with CDC operation version only. Information on handling CDs, inserting CDs and operating the CD changer can be found in the operating instructions supplied with your CD changer.

## SWITCHING TO CDC MODE

Keep pressing **MODE** button on the DVD unit shortly or **MODE** button on the remote control until the CDC mode display appears. Playback begins with the first CD that the CD changer detects.

## SELECTING TRACKS

Press **◀◀** button on the DVD unit to move to the previous track; press **▶▶** button on the DVD unit to move to the following track. Track number shows on display. Hold **◀◀** button or **▶▶** button to fast reverse or fast forward. CD play starts from when you release the button.

## PAUSING PLAYING

Press **▶||** button on the DVD unit or on the remote control to pause CDC player. Press it again to resume play.

## PREVIEWING ALL TRACKS

Press **SCN** button on the DVD unit shortly to play first several seconds of each track on current disc. Press and hold **SCN** button on the DVD unit for several seconds to play first several seconds of the first track on each disc in the CD magazine. Press it again to stop intro and listen to track.

## REPEATING INDIVIDUAL TRACKS OR WHOLE CDs

Press **RPT** button on the DVD unit shortly to continuously repeat the same track. Press and hold **RPT** button on the DVD unit for several seconds to continuously repeat all tracks on the current disc. Press it again to stop repeat.

## PLAYING ALL TRACKS IN RANDOM

Press **SHF** button on the DVD unit shortly to play all tracks on the current disc in random order. Press and hold **SHF** button on the DVD unit for several

seconds to select a disc in random and play the selected disc in random order. Press it again to cancel the function.

## SELECTING DISC

Press **CD-** button on the DVD unit to select previous disc and **CD+** button on the DVD unit to select next disc.

## DVD CHANGER OPERATION

You can connect a DVD changer to the unit with DVD changer operation version only. Information on handling DVDs, inserting DVDs and operating the DVD changer can be found in the operating instructions supplied with your DVD changer.

## SWITCHING TO CDC MODE

Keep pressing **MODE** button on the DVD unit shortly or **MODE** button on the remote control until the CDC mode display appears. Playback begins with the first DVD that the DVD changer detects.

## SELECTING TRACKS

Press **◀◀** button on the DVD unit to move to the previous track; press **▶▶** button on the DVD unit to move to the following track. Track number shows on display. Hold **◀◀** button or **▶▶** button to fast reverse or fast forward. DVD play starts from when you release the button.

## PAUSING PLAYING

Press **▶||** button on the DVD unit or on the remote control to pause DVD changer player. Press it again to resume play.

## PREVIEWING ALL TRACKS

Press **SCN** button on the DVD unit shortly to play first several seconds of each track on current disc. Press and hold **SCN** button on the DVD unit for several seconds to play first several seconds of the first track on each disc in the DVD magazine. Press it again to stop intro and listen to track.

# OPERATION

---

## REPEATING INDIVIDUAL TRACKS OR WHOLE CDs

Press **RPT** button on the DVD unit shortly to continuously repeat the same track. Press and hold **RPT** button on the DVD unit for several seconds to continuously repeat all tracks on the current disc. Press it again to stop repeat.

## PLAYING ALL TRACKS IN RANDOM

Press **SHF** button on the DVD unit shortly to play all tracks on the current disc in random order. Press and hold **SHF** button on the DVD unit for several seconds to select a disc in random and play the selected disc in random order. Press it again to cancel the function.

## SELECTING DISC

Press **SMART (DISC)** button on the remote control to select another disc in the DVD changer unit.

## AV IN OPERATION

When you connect another audio/video system to the unit through the AV IN terminals on the back of the unit, press **MODE** button on the front panel or **MODE** on the remote control to select AV IN mode.

# SETUP

## INITIAL SETUP

SETUP MENU --- MAIN PAGE

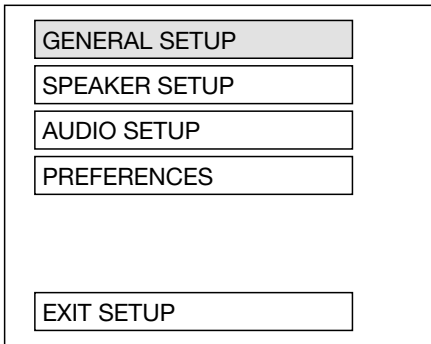

1. Press **SETUP** on the remote control or on the DVD unit in the stop mode. (Press the stop button twice to ensure that the player is in STOP mode.)
2. The initial SETUP menu is displayed.
3. Select the preferred item by using the **▲ / ▼** buttons.
4. Press **MUT/ENT** on the front panel or **OK** button on the remote control.
  - a. **GENERAL SETUP**  
This setup page includes all the item of TV display & Audio output feature. For details please refer to **GENERAL SETUP MENU**.
  - b. **SPEAKER SETUP**  
This is to activate the audio output from DOLBY AC3 5.1 DOWNMIX to 2 channel mode. Please refer to **SPEAKER SETUP MENU**.
  - c. **AUDIO SETUP**  
This setup page includes all the items for AUDIO. Please refer to **AUDIO SETUP MENU**.
  - d. **PREFERENCES SETUP**  
This setup page includes all the configuration of support feature. For details please refer to **PREFERENCES SETUP MENU**.

## GENERAL SETUP

--- GENERAL PAGE ---

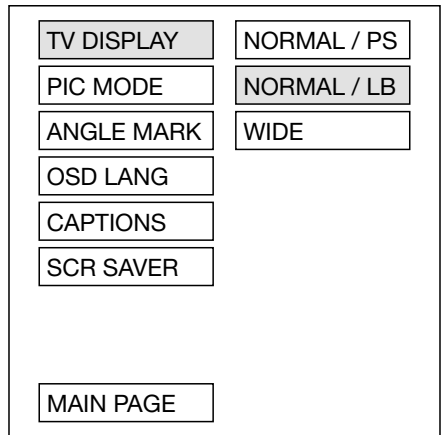

Video Material	TV Screen			
	4:3			Wide (16:9)
	Normal	Pan Scan	Letter-box	
4:3				
16:9				

### TV display setup

This is to select the appropriate TV aspect ratio (4:3 or 16:9) according to the connected TV set.

#### Normal/PS (For 4:3 TV)

Played back in the PAN & SCAN style. (If connected to wide-screen TV, the left and right edges are cut off.)

#### Normal/LB (For 4:3 TV)

Played back in letterbox style. (If connected to wide-screen TV, black bands appear at top and bottom of the screen.)

#### Wide (For 16:9 TV)

Select when a wide-screen TV set is connected.



# SETUP

--- GENERAL PAGE ---

TV DISPLAY	
PIC MODE	AUTO
ANGLE MARK	HI-RES
OSD LANG	N-FLICKER
CAPTIONS	
SCR SAVER	
MAIN PAGE	

## PIC mode setup

Select AUTO, the player PIC mode will depend on DVD disc.  
Select HI-RES format for best image resolution.  
Select N-FLICKER format on image or picture with noise or distortion.

--- GENERAL PAGE ---

TV DISPLAY	
PIC MODE	
ANGLE MARK	
OSD LANG	ENGLISH
CAPTIONS	FRENCH
SCR SAVER	GERMAN
	ITALIAN
	PORTUGUESE
MAIN PAGE	SPANISH

## OSD LANG type setup

Select the preferred OSD (On Screen Display) language by using the ▲ / ▼ buttons.

--- GENERAL PAGE ---

TV DISPLAY	
PIC MODE	
ANGLE MARK	ON
OSD LANG	OFF
CAPTIONS	
SCR SAVER	
MAIN PAGE	

## ANGLE MARK display setup

If it is set to ON, when the multi-angle DVD disc is playing,  (the angle mark) will appear on the screen; if it is set to OFF, the mark will not appear.

--- GENERAL PAGE ---

TV DISPLAY	
PIC MODE	
ANGLE MARK	
OSD LANG	
CAPTIONS	ON
SCR SAVER	OFF
MAIN PAGE	

## CAPTIONS setup

When play DVD disc, activate the CAPTIONS feature by selecting ON and the captions (such as the actor dialogue) appear on the screen; deactivate this feature by selecting OFF and the captions will not appear.

# SETUP

--- GENERAL PAGE ---

TV DISPLAY	
PIC MODE	
ANGLE MARK	
OSD LANG	
CAPTIONS	
SCR SAVER	ON
	OFF
MAIN PAGE	

## SCR SAVER setup

Select the SCR SAVER ON/OFF.

## AUDIO SETUP

--- AUDIO SETUP ---

SPDIF	OFF
OP MODE	ON
LPCM OUTPUT	
DYNAMIC	
MAIN PAGE	

### SPDIF

This is to activate the digital audio output on or off.

## SPEAKER SETUP

--- SPEAKER SETUP PAGE ---

DOWNMIX	LT/RT
	STEREO
MAIN PAGE	

This is to activate the audio output from DOLBY AC3 5.1 DOWNMIX to 2 channel mode. Select the preferred SPEAKER connection by using the cursor buttons.

- Select the LT/RT to activate the Dolby surround compatible output.
- Select the STEREO to activate simple stereo mode.

--- AUDIO SETUP ---

SPDIF	
OP MODE	LINE OUT
LPCM OUTPUT	RF REMOD
DYNAMIC	
MAIN PAGE	

### OP MODE

- LINE OUT: Line out mode, with digital dialog normalization.
- RF REMOD: RF remodulation mode, with heavy compression and digital dialog normalization.

It is recommended to select LINE OUT mode.

# SETUP

## --- AUDIO SETUP ---

SPDIF	
OP MODE	
LPCM OUTPUT	
DYNAMIC	LPCM 48K
	LPCM 96K
MAIN PAGE	

### LPCM OUTPUT

Selecting LPCM (Line Pause Code Modulation) OUTPUT between LPCM 48K and LPCM 96K.

The higher the sampling frequency is, the better the output audio quality is. It is recommended to select LPCM 96K.

## --- AUDIO SETUP ---

SPDIF	
OP MODE	
LPCM OUTPUT	
DYNAMIC	
	FULL
	6/8
	4/8
	2/8
	OFF
MAIN PAGE	

### DYNAMIC RANGE CONTROL

Select DYNAMIC and adjust the dynamic range of a Dobyly Digital encoded program. There are 8 steps between full compression and off compression.

## PREFERENCES SETUP

### --- PREFERENCES PAGE ---

TV TYPE	AUTO
AUDIO	NTSC
SUBTITLE	PAL
DISC MENU	
PARENTAL	
PASSWORD	
DEFAULTS	
SMART NAV	
LOGO	
MAIN PAGE	

### TV type setup

This player can play discs recorded in either PAL or NTSC format.

Select NTSC format, when you connected to NTSC TV.

Select PAL format, when you connected to PAL TV.

Select AUTO format, the player TV output format will be according to the DVD disc format.

### --- PREFERENCES PAGE ---

TV TYPE	
AUDIO	ENGLISH
SUBTITLE	FRENCH
DISC MENU	SPANISH
PARENTAL	CHINESE
PASSWORD	JAPANESE
DEFAULTS	GERMAN
SMART NAV	ITALIAN
LOGO	PORTUGUESE
MAIN PAGE	

### AUDIO language setup

Select the preferred AUDIO soundtrack by using the cursor buttons.

# SETUP

--- PREFERENCES PAGE ---

TV TYPE	
AUDIO	ENGLISH
SUBTITLE	FRENCH
DISC MENU	SPANISH
PARENTAL	CHINESE
PASSWORD	JAPANESE
DEFAULTS	GERMAN
SMART NAV	ITALIAN
LOGO	PORTUGUESE
MAIN PAGE	OFF

## SUBTITLE language setup

Select the preferred SUBTITLE language by using the cursor buttons.

--- PREFERENCES PAGE ---

TV TYPE	1 G
AUDIO	2
SUBTITLE	3 PG
DISC MENU	4 PG 13
PARENTAL	5
PASSWORD	6 PG-R
DEFAULTS	7 NC-17
SMART NAV	8 ADULT
LOGO	NO PARENTAL
MAIN PAGE	

## PARENTAL

Select suitable parental guidance by the cursor buttons and confirmed by pressing **ENT** button on the DVD unit or **OK** button on the remote control.

--- PREFERENCES PAGE ---

TV TYPE	
AUDIO	
SUBTITLE	ENGLISH
DISC MENU	FRENCH
PARENTAL	SPANISH
PASSWORD	CHINESE
DEFAULTS	JAPANESE
SMART NAV	GERMAN
LOGO	ITALIAN
MAIN PAGE	PORTUGUESE

## DISC MENU language setup

Select the preferred DISC MENU language by using the cursor buttons.

--- PREFERENCES PAGE ---

TV TYPE	
AUDIO	
SUBTITLE	
DISC MENU	
PARENTAL	
PASSWORD	CHANGE
DEFAULTS	
SMART NAV	
LOGO	
MAIN PAGE	

## PASSWORD

Select CHANGE and press **ENT** or **OK** button. Type the old password (The initial factory code is 3308) and key in 4 characters password now you want to use, and retype again to confirm key in correctly.

# SETUP

--- PREFERENCES PAGE ---

TV TYPE	
AUDIO	
SUBTITLE	
DISC MENU	
PARENTAL	
PASSWORD	
DEFAULTS	RESET
SMART NAV	
LOGO	
MAIN PAGE	

## DEFAULTS

Select reset to revert to factory initial settings.

--- PREFERENCES PAGE ---

TV TYPE	
AUDIO	
SUBTITLE	
DISC MENU	
PARENTAL	
PASSWORD	
DEFAULTS	NO MENU
SMART NAV	WITH MENU
LOGO	
MAIN PAGE	

## SMART NAV

If selected WITH MENU mode, when playing an MP3 disc, the smart navigation menu will appear on the screen, then the user can select a track to play according to the menu hint.

If selected NO MENU mode, when playing an MP3 disc, there is no menu to display and it starts to play directly.

The user can adjust this item according to one's need.

--- PREFERENCES PAGE ---

TV TYPE	
AUDIO	
SUBTITLE	
DISC MENU	
PARENTAL	
PASSWORD	
DEFAULTS	ORIG LOGO
SMART NAV	CUST LOGO
LOGO	
MAIN PAGE	

## LOGO

Select ORIG LOGO (original picture when the unit turns on) or CUSTLOGO (customer-set picture when the unit turns on).

Note: The CUST LOGO must be in the JPEG format. Load the picture disc into the drive of the DVD unit, when you select the desired picture, press ►|| button then press TITLE button, the current picture will be stored in the unit and "LOGO IS COPIED" will appear on the screen.

# SETUP

---

## DEFAULTS TABLE

General Setup	TV Display	Normal/LB
	PIC Mode	AUTO
	Angle Mark	ON
	OSD Language	English
	Captions	ON
	SCR Saver	ON
Speaker Setup	Downmix	Stereo
Audio Setup	SPDIF	OFF
	OP Mode	Line Out
	Dynamic	FULL
	LPCM Output	LPCM 96K
Preferences	TV Type	AUTO
	Audio	English
	Subtitle	English
	DISC Menu	English
	Parental	NO Parental
	Password	3308
	Smart NAV	With Menu
	Logo	ORIG Logo

# TROUBLE SHOOTING

---

If it appears that your DVD unit is faulty, first consult this checklist. It may be that something simple has been overlooked.

**Under no circumstances should you try to repair the player yourself, as this will invalidate the warranty. Only qualified service personnel can remove the cover or service this player.**

## **NO POWER**

- If the power supply is connected to the car accessory circuits, but the engine is not moving, switch the ignition key to "ACC".
- Check if the fuse is blown. Then replace the new fuse.
- Check if the on/off button on the front of the player is set to on.

## **NO PICTURE**

- Check if the monitor or TV is switched on.
- Check if select proper mode, such as Disc Play mode and AV mode.
- Check the video connection.

## **DISTORTED PICTURE**

- Check the disc for fingerprints and clean with soft cloth, wiping from centre to edge.
- Sometimes a small amount of picture distortion may appear. This is not a malfunction.

## **COMPLETELY DISTORTED PICTURE**

- The disc format is not according to the TV-set used (PAL/NTSC).

## **NO COLOR IN PICTURE**

- The disc format is not according to the TV-set used (PAL/NTSC).

## **DISC DOES NOT PLAY**

- Ensure the disc label is upwards.
- Clean the disc.
- Check if the disc is defective by trying another disc.

## **NO SOUND**

- Check audio connections.
- If using a HIFI amplifier, try another sound source.

## **DISTORTED SOUND FROM HIFI AMPLIFIER**

- Check to make sure that no audio connections are made to the amplifier phono input.

## **THE PLAYER DOES NOT RESPOND TO THE REMOTE CONTROL**

- Aim the remote control directly at the sensor on the front of the player.
- Avoid all obstacles which may interfere with the signal path.
- Inspect or replace the remote control battery.

## **DISTORTED OR B/W PICTURE**

- The disc format is not according to the TV-set used (PAL/NTSC).

## **NO AUDIO AT DIGITAL OUTPUT**

- Check the digital connections
- Check the Digital Audio menu to make sure that the digital output is correctly set.
- Check if the audio format of the selected audio language matches your receiver's capabilities.

## **BUTTONS DO NOT WORK**

- Press Reset button on the housing of the DVD unit.

## **THE RADIO DOES NOT WORK**

- Check if the antenna cable is connected firmly.

## **THE RADIO STATION AUTOMATIC SELECTION DOES NOT WORK**

- If the signals are too weak, select a station manually.

# SPECIFICATIONS

---

## GENERAL

Power Supply Requirements	: DC 12Volts, Negative Ground
Chassis Dimensions	: 178 (W) x 160 (D) x 50 (H)
Tone Controls	
- Bass (at 100 Hz)	: $\pm 10$ dB
- Treble (at 10 KHz)	: $\pm 10$ dB
Maximum Output Power	: 4 x 40 watts
Current Drain	: 15 Ampere (max.)

## DVD PLAYER

Signal to Noise Ratio	: More than 55 dB
Channel Separation	: More than 45 dB
Frequency Response	: 20 Hz - 20 kHz

## RADIO

### FM

Frequency Coverage	: 87.5 to 108MHz
IF	: 10.7 MHz
Sensitivity (S/N = 30 dB)	: 4 $\mu$ V
Stereo Separation	: > 25 dB

### AM

Frequency Coverage	: 530 to 1710 KHz
IF	: 450 KHz
Sensitivity (S/N = 20 dB)	: 36 dBu



# SPECIFICATIONS

---

<b>Supply voltage:</b>	Compositive video 1.0Vp-p 75Ω
<b>Discs played:</b>	(1) 5" (12 cm) DVD-VIDEO disc
	(2) Compact disc (CD-DA/CD-R/CD-RW/MP3)
	(3) 5" (12 cm) VIDEO CD

**Note:**

Specifications and design are subject to modification, without notice, due to improvements in technology.

**CAUTION:**

- To avoid electric shock, this unit must not be exposed to dripping water or water splash.
- Minimum distances around the apparatus for sufficient ventilation.
- The ventilation should not be impeded by covering the ventilation openings with items, such as newspapers, table-cloths, curtains, etc.
- No naked flame sources, such as lighted candles, should be placed on the apparatus.
- The use of apparatus in tropical and/or moderate climates.
- Before scrapping the appliance, remove the batteries and place them in the appropriate battery collection container.

**This product incorporates copyright protection technology that is protected by method claims of certain U.S. patents and other intellectual property rights owned by Macrovision Corporation and other rights owners. Use of this copyright protection technology must be authorized by Macrovision Corporation, and is intended for home and other limited viewing uses only unless otherwise authorized by Macrovision Corporation. Reverse engineering or disassembly is prohibited.**







## Free Manuals Download Website

<http://myh66.com>

<http://usermanuals.us>

<http://www.somanuals.com>

<http://www.4manuals.cc>

<http://www.manual-lib.com>

<http://www.404manual.com>

<http://www.luxmanual.com>

<http://aubethermostatmanual.com>

Golf course search by state

<http://golfingnear.com>

Email search by domain

<http://emailbydomain.com>

Auto manuals search

<http://auto.somanuals.com>

TV manuals search

<http://tv.somanuals.com>