



PRINTEKMOBILE™

MtP300 Series

Operator's Manual

Printek, Inc.
1517 Townline Road
Benton Harbor, MI 49022

269-925-3200

www.printek.com

Printek Part Number 6044 Rev. D

FCC Part 15 Class B

This device complies with Part 15 of the FCC Rules. Operation is subject to the following two conditions: (1) this device may not cause harmful interference, and (2) this device must accept any interference received, including interference that may cause undesired operation.

This equipment has been tested and found to comply with the limits for a Class B digital device, pursuant to Part 15 of the FCC rules. These limits are designed to provide reasonable protection against harmful interference in a residential installation. This equipment generates, uses and can radiate radio frequency energy and, if not installed and used in accordance with the instructions, may cause harmful interference to radio communications. However, there is no guarantee that interference will not occur in a particular installation. If this equipment does cause harmful interference to radio or television reception, which can be determined by turning the equipment off and on, the user is encouraged to try to correct the interference by one or more of the following measures:

- Reorient or relocate the receiving antenna.
- Increase the separation between the equipment and the receiver.
- Connect the equipment into an outlet on a circuit different from that to which the receiver is connected.
- Consult the dealer or an experienced radio/TV technician for help.

This equipment complies with Canadian and FCC radiation exposure limits set forth for an uncontrolled environment. This equipment is in direct contact with the body of the user under normal operating conditions. This transmitter must not be co-located or operating in conjunction with any other antenna or transmitter.

Part 15.21 Caution: Changes or modifications not expressly approved by Printek, Inc. could void the user's authority to operate the equipment.

Bluetooth Equipped Models:

This equipment contains either an OEM Serial Port Adapter from connectBlue with FCC ID: PVH070101 or a Printek, Inc. Bluetooth module with FCC ID: 0113900444.

Wi-Fi Equipped Models:

This equipment contains an OEM Wireless LAN Node Module from DPAC Technologies with FCC ID: RTTABDB-SEDP. This device has shown compliance with the conducted emissions limits in 15.107, 15.207, or 18.307 adopted under FCC 02-157 (ET Docket 98-80).

Battery Disposal

Only dispose of used batteries according to your local regulations. If you do not know your local regulations, the Rechargeable Battery Recycling Corporation (RBRC) is a non-profit organization created to promote recycling of rechargeable batteries. For more information visit www.rbrc.org.



Acknowledgments:

Printek is a registered trademark of Printek, Inc.

Bluetooth is registered trademark of Bluetooth SIG, Inc.
O'Neil is a trademark of O'Neil Product Development, Inc.
Zebra, ZPL-II and Comtec are registered trademarks of Zebra Technologies
Palm OS is a trademark of PalmSource, Inc.
PrintBoy is a registered trademark of Bachmann Software
PrinterCE is a registered trademark of Fieldsoftware Products
Wi-Fi is a registered trademark of the Wi-Fi Alliance
Windows is a registered trademark of Microsoft Corporation
All other trademarks are the property of their respective owners.

© 2004, 2005 By Printek, Inc., 1517 Townline Road, Benton Harbor, MI 49022. All rights reserved.

This manual is based on printer firmware version 2.9. Specifications are subject to change without notice.



Read all setup and operating instructions before proceeding with operation.

Do not operate in an enclosure unless properly ventilated. Make sure no ventilation openings are blocked or obstructed, which may result in the printer overheating.

Do not operate near a heat source.



Lesen Sie vor der Inbetriebnahme die Aufbau- und Bedienungsanleitung.

Betreiben Sie den Drucker nicht in einem kleinen, geschlossenen Raum, es sei denn dieser wird ordnungsgemäß belüftet. Achten Sie darauf, dass die Lüftungen nicht blockiert oder versperrt sind, denn dies kann zum Überhitzen des Druckers führen.

Nehmen Sie den Drucker nicht in der Nähe einer Wärmequelle in Betrieb.



No user-serviceable parts inside. Refer service or repairs to a qualified service professional.

Use of genuine Printek replacement parts is required to warrant proper, safe operation.

Any alteration or modification of this device voids the user warranty and may make the product unsafe to operate.

The print head and motors get hot during use. Wait until they cool before touching them.

Make certain the printer is disconnected from AC power before removing any covers or performing any required cleaning or maintenance.

Connecting this printer to an ungrounded receptacle can result in electrical shock.

Never place the printer near inflammable or explosive substances. Do not operate near liquid or spill liquid into the printer at any time.



Enthält keine Teile, die vom Bediener instandgesetzt werden können. Bitte wenden Sie sich bei Instandsetzung oder Reparatur an qualifiziertes Kundendienstpersonal.

Die Verwendung von echten Printek Ersatzteilen ist notwendig, um ordnungsgemäßen, sicheren Betrieb zu gewährleisten.

Änderungen oder Modifikationen dieses Geräts machen die Garantie ungültig und können den sicheren Betrieb des Produkts gefährden.

Während des Druckens werden Druckerkopf und Motoren heiß. Warten Sie, bis sich die Teile abgekühlt haben, bevor Sie sie berühren.

Vergewissern Sie sich, dass der Drucker nicht mehr an die Stromquelle angeschlossen ist, bevor Sie Abdeckungen abnehmen oder das Gerät reinigen bzw. warten.

Schließen Sie diesen Drucker nicht an eine ungeerdete Steckdose an; dies kann zum Elektroschock führen.

Setzen Sie den Drucker niemals in die Nähe von feuer- oder explosionsgefährlichen Stoffen. Betreiben Sie den Drucker nicht in der Nähe von Flüssigkeiten und lassen Sie keine Flüssigkeiten in den Drucker gelangen.

TABLE OF CONTENTS

Introduction	1
Getting Started	3
Battery Installation and Charging	3
Installing Media	4
Turning the Printer On and Off	5
Performing A Printer Self Test	5
Host Interface Set Up	6
Belt Loop System	7
Daily Operation	9
Introduction	9
Control Panel	9
Removing Printed Output	10
Battery Charging	11
Using the Magnetic Card Reader	12
Fault Messages	13
Printer Configuration	15
Introduction To Setup	15
Setup Basics	15
Entering Setup	16
Selecting Menus	16
Exiting Setup	16
Setup Menu Summary	17
Format Menu	18
Interface Menu	22
Serial Interface	22
IrDA Interface	24
Bluetooth Interface	25
Wi-Fi Interface	27
Options Menu	31
Interfacing To A Host Computer	33
RS-232C Serial Interface	33
IrDA Interface	34
Bluetooth® Interface	34
Wi-Fi® Interface	35
Power Considerations	37
Standby Operation	37
Auto Power Down	37
Operation Without A Battery	37
Maintenance and Troubleshooting	39
Cleaning	39
Battery Care	40
Charging the Battery	40
Additional Battery and Safety Information	40
Testing the Power Supply and Battery	41
Troubleshooting	42
Error Messages	42
Other Problems	43
Obtaining Service	44

Table of Contents

Advanced Setup Features.....	45
Print & Font Samples.....	47
Specifications.....	51
Printer Specifications.....	51
Media Specifications.....	53
Supplies and Accessories.....	55
Glossary of Terms.....	57

Introduction

Thank you for purchasing a Printek MtP300 Series Mobile Thermal Printer. The MtP300 Series offer a variety of configurations to suit any printing environment.

All models support media up to 3.12 inches wide and include “black mark” sensing capabilities on the printed side of the media. The MtP300 LP also supports rear black mark sensing and label gap sensing. All models are equipped with a Serial RS-232C port and will support one additional, optional interface. The interfaces available are IrDA, Bluetooth, and Wi-Fi.

Each printer is shipped with a battery, a belt loop system, a Quick Start Guide, and one roll of receipt paper.

This manual has been written for the end user and contains information needed for the set up and everyday use of the printer. It also contains information regarding preventative maintenance and how to obtain service if needed.

The information in this manual is arranged in the following sections:

Getting Started contains the minimum steps required to get the printer set up and able to communicate with your host system.

Daily Operation describes the activities that are likely to be encountered under normal operation by most users.

Printer Configuration contains detailed information on all the features available in the Setup menus.

Interfacing To A Host Computer provides basic information related to connecting the printer to a computer via the standard RS-232C Serial port or one of the optional IrDA, Bluetooth, or Wi-Fi interfaces.

Power Considerations provides information regarding operation on the internal battery or from an external supply.

Maintenance and Troubleshooting contains information on how to care for your printer to keep it working at peak performance. This section also includes a list of printer error messages and suggestions on how to solve problems.

Advanced Setup Features contains additional information for systems administrators.

Print & Font Samples offers examples of printed output and character mapping for the standard fonts.

Specifications provides detailed information regarding performance, media specifications, and options available for your MtP300 Series printer.

Glossary of Terms is a reference for terminology used within this manual and in the computer and printer industry.

Getting Started

Battery Installation and Charging

Note: You must charge the battery for at least 2½ hours prior to the first use.

The battery for your MtP300 printer is shipped in an “uncharged” state. The battery must be charged using the following instructions prior to using the printer for the first time. Maximum battery capacity is not reached until after completing a minimum of three complete charge and discharge cycles.

Please refer to Figure 1 and insert the battery by sliding it into the battery compartment until the release lever on the battery “snaps” into place.

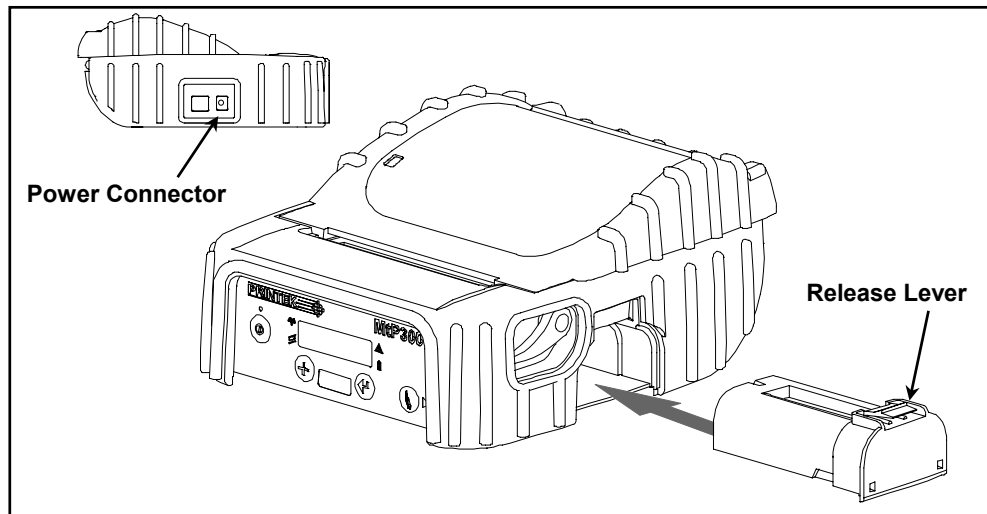



Figure 1 - Battery Installation and Power Connector

Connect an optional power supply to the appropriate input source, and then connect the output of the power supply to the printer’s Power Connector. The  Battery Indicator will turn on and remain on until the battery is fully charged. This may take up to 2½ hours.

Caution: Use only Printek power supplies designed specifically for your MtP300 printer. Using a different power supply may cause damage to the printer and will not be covered by the printer’s warranty. Printek power supplies are available for use with 100-240VAC/50-60Hz and for 12/24VDC vehicle applications.

Installing Media

Each printer comes supplied with a roll of receipt paper. For your convenience, the printers feature a paper supply indicator as shown in Figure 2. The indicator changes from all green to all red as the paper supply is used.

Note: For maximum performance and optimum print quality, use only genuine Printek media in your MtP300 Series printer.

To install media, you must release the paper door by moving the Paper Door Release in the direction shown in Figure 2 and then lift the paper door to expose the paper compartment.

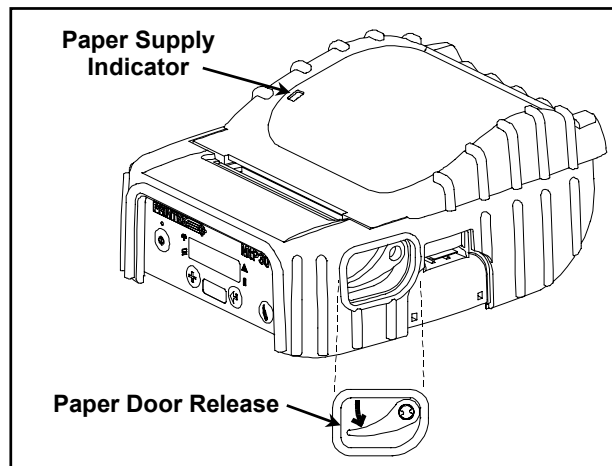

Figure 2 - Opening Paper Door

Refer to Figure 3 and locate the movable media support. Move the support in the direction shown and then locate the media between the supports and release the movable support.

Note: Make sure that the roll spins freely on the media supports.

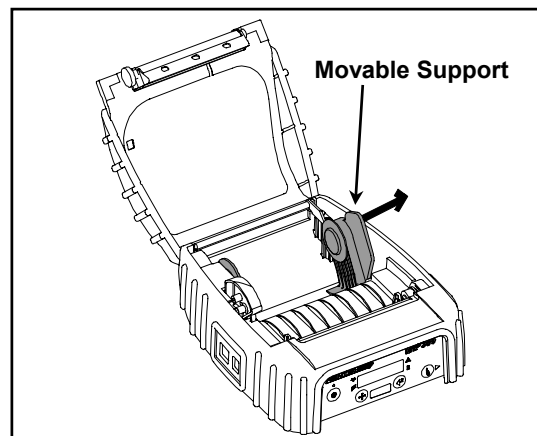

Figure 3 - Media Support

Refer to Figure 4 and unroll enough paper to allow it to lay through the print head as shown, and close the paper door.

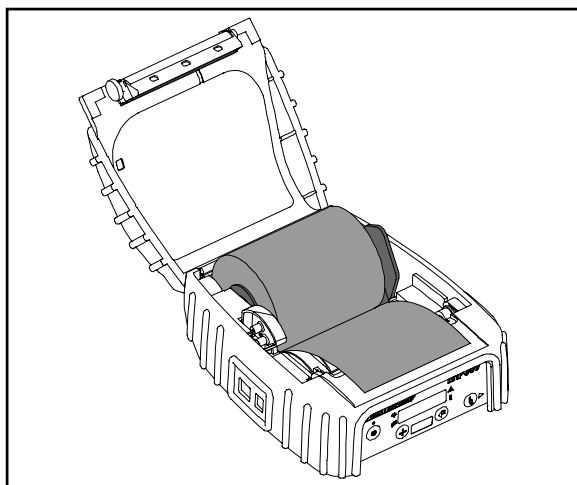





Figure 4 - Paper Laying Through Print Head

You may now press the  Paper Feed Button to advance the paper a few inches and then tear it off in preparation for printing.

Turning the Printer On and Off

To turn the printer on, simply press the  Power Button. If you continue to hold the Power Button, the printer will display the printer's model number. After the button is released, the printer will continue its power up initialization and then display the name of the current Format (default is "Format 1") on the top line. The bottom line will display a battery symbol at the right hand end of the line that indicates the current condition of the battery.



To turn the printer off, press and hold the  Power Button. The printer will display "Printer Off" and then power down after the button is released.

Performing A Printer Self Test

Two self test printouts are available – the standard printout which prints the items listed below, and an extended printout which also prints any graphic images or logos that are stored in the printer.

- The printer's firmware revision level and release date.
- The current Setup Menu values for the following menus:
 - The currently selected Format(s)
 - The Options Menu settings.
- The type of optional interface, if installed, and which interface is currently selected.
- The presence of the optional Magnetic Card Reader, if installed.
- The current battery voltage.
- Print head temperature.

- A list of any graphic images or logos that have been stored.
- A sample bar code.
- Printer serial number.
- A print head test pattern.

To print the standard printout, press and hold the  Paper Feed button while turning on the printer with the  Power Button (press and release the power button, but continue to hold the paper feed button) until the printer displays “Printing Current Menu Values”, and then release the  Paper Feed button.

If the printer has any graphic images/logos stored, “Press Paper Feed To Print Logos” will be displayed. Pressing and releasing the  Paper Feed button will cause the images to be printed at the bottom of the standard printout.







Host Interface Set Up

Prior to using your printer with a computer application, check the interface settings to be sure they match those required by your host system.

Each printer is equipped with a Serial RS-232C interface which is selected by default. Additionally, the printer may also be equipped with either an IrDA interface, Bluetooth interface, or Wi-Fi interface. The model description on the serial number label will indicate if one of the optional interfaces is installed. The factory defaults for the basic settings for each interface are listed below.

<u>Interface</u>	<u>Factory Default Interface Settings</u>
Serial RS-232C	Printek Emulation, 57,600 Baud, 8 Data Bits, 1 Stop Bit, No Parity, No Handshake
IrDA	Printek Emulation. No other set up required.
Bluetooth	Printek Emulation, Pairing Mode = Paired, Security Disabled, PIN = “0” Bluetooth Name = “MtP300-SerialNumber”.
Wi-Fi	Connect to any SSID, Infrastructure, WEP = None, DHCP enabled, TCP tunnel port 8023, Channel = 1, DHCP Name = MtP300-SerialNumber.

If the above settings do not sufficiently match your host system, the following instructions describe how to access the Interface Set Up Menu.

1. Make sure the printer is powered off. If the printer is on, press and hold the  Power Button until “Printer Off” is displayed to turn the printer off.
2. Press and hold the  Enter Button.
3. Continue to hold the Enter Button and turn the printer on. Continue holding the  Enter Button until “Menus Active” is displayed.
4. Press the  Advance Button until “Interface Menu” is displayed. If necessary, you may toggle between the Serial interface and the optional interface (if installed) by pressing the  Increment Button. Note that the interface that is displayed is the interface that will be used when you exit set up mode.
5. Press the  Enter Button to advance to the first set up feature for the interface that was displayed in step 4. Only the features that pertain to the interface displayed/selected in step 4 will be available.

6. You may continue to step through additional set up features by pressing the ◀ Enter Button.
7. When you have finished setting the parameters to match you host system, press the ▶ Advance Button until “Exit Menu” is displayed.
8. Press the ◀ Enter Button to save the changes and exit the Setup Mode.
9. Your printer is now configured and ready to communicate with your host system.

Belt Loop System

The belt loop system consists of two parts – a knob located on the bottom of the printer and a belt loop strap with a click on connector

To use the belt loop system, slide your belt through the strap of the belt loop and then insert the knob located on the bottom of the printer into the slot of the belt loop connector. Pull down on the printer until you hear a click. The printer is now secure and can safely hang down beside your hip.

To release the printer, press in on the two latches on the sides of the connector and pull the printer and knob up and clear of the slot.

Note: Do not force or pull the printer from the connector without pressing in on the two latches.

Daily Operation

Introduction

For normal daily use, most users will only need to turn the printer on and off, load paper, and recharge the battery at the end of the day. The following sections describe these simple activities and provide additional information regarding the use of the MtP300.

Control Panel

The MtP300 Series printers are designed for simple operation with an easy to use control panel. As shown in Figure 5, the control panel consists of an LCD Display, five indicators, and four pushbuttons.

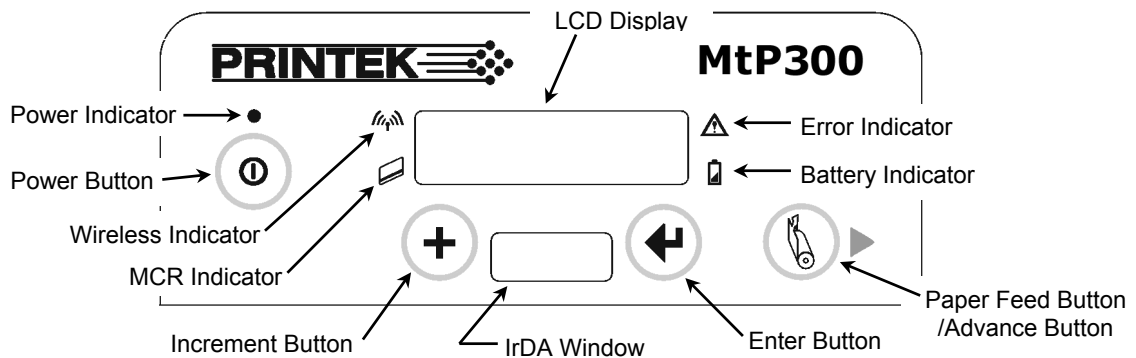







Figure 5 - Control Panel

In normal daily use, most users will only use the  Power Button/Indicator and perhaps the  Paper Feed Button, and observe any messages that may appear on the LCD Display. The purpose and functionality of all of the buttons and indicators are listed below.

-  Power Button – Used to turn the printer on or off.
-  Paper Feed /Advance Button – Advances paper the distance set by the FFeed Distance feature for the currently selected Format. (Default = 1.2608" (32mm). Also used to clear Check Paper error conditions.
-  Increment Button – Used in printer configuration menus to change the value of the currently selected feature. (May also be used to access a stored command file – see the *MtP Series & FieldPro Programmer's Manual* for more information.)

- ↵ Enter Button – Used in printer configuration menus to advance to the next setup feature. May also be used to print the settings and connection information for the currently selected interface.
- ⓘ Power Indicator – ON indicates that the power is on and that the printer is in normal power mode. SLOW FLASH indicates that the printer is in Setup mode and not accepting data. SHORT FLASH indicates that the printer has entered the power saving standby mode and will wake upon receipt of data or when the ⓘ Power Button or 📄 Paper Feed Button is pressed.
- 📶 Wireless Indicator – Indicates that an optional Bluetooth or Wi-Fi interface is installed, enabled and is currently connected or receiving data.
- 📄 MCR Indicator – Indicates that the optional Magnetic Card Reader has been enabled and is ready for the user to swipe a card.
- ⚠ Error Indicator – Indicates that an error has occurred as described on the LCD Display.
- 🔋 Battery Indicator – ON indicates that the battery is currently being charged. FLASHING indicates that the battery capacity is low and the battery needs to be recharged.

Removing Printed Output

In most cases, the host application program will issue a Form Feed that will eject the paper so that all the printed information is fed out of the printer and the receipt or label is ready to be torn off. If all the printing is not yet out of the printer and the host has finished sending data to the printer, the paper may be positioned for tearing by simply pressing the 📄 Paper Feed Button.

To tear the paper, pull the paper against the tear bar at a slight angle as shown in Figure 6, and then continue to pull the paper in the direction shown to tear it off.

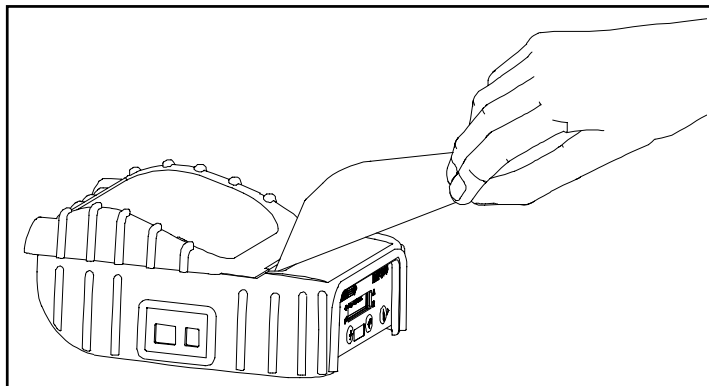

Figure 6 - Tearing Off Printed Output

Battery Charging

The MtP300 contains battery monitoring and charging circuitry so that the battery may be charged while still in the printer. Charging the battery in the printer requires an optional power supply. Printek offers power supplies for use with 100-240VAC/50-60Hz and 12/24VDC for vehicle applications.

Optional external battery chargers are also available so that you can have fully charged batteries “standing by” when needed.

The printer’s battery status is displayed in the lower right corner of the front panel LCD Display. The status is displayed as a battery shape which indicates the relative capacity that remains as indicated below.

Fully Charged  Discharged

To charge the battery inside the MtP300, connect the power supply to the appropriate source, and connect the output of the supply to the printer’s power connector shown in Figure 7.

Caution: Use only Printek power supplies to power your printer and charge batteries. Other power supplies may damage the electronics and printing mechanism. Damage caused by use of a non-Printek power supply will not be covered by the printer’s warranty.

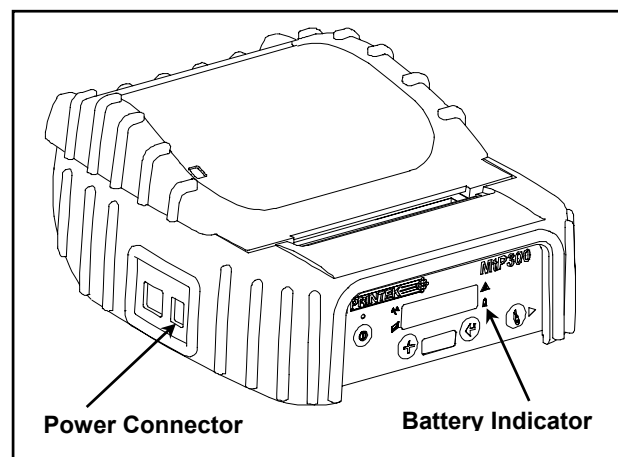



Figure 7 - MtP300 Power Connector & Battery Indicator

When the power supply is connected, the printer’s charging circuitry will determine if the battery currently requires charging and if so, will turn on the  Battery Indicator until the battery has reached sufficient charge. Depending on the condition of the battery, charging may take up to 2½ hours to complete.

Leaving the power supply connected to the printer will cause the printer to continuously monitor the condition of the battery and keep the battery charged.

For more information regarding battery charging, battery life, and battery disposal, refer to “Battery Care” on page 40.

Using the Magnetic Card Reader

The optional Magnetic Card Reader (MCR) is used by some applications to read information from credit cards, drivers licenses, etc.

When the host system sends a request to the MtP300 to enable the Magnetic Card Reader, “Swipe Card Now” will be displayed and the  MCR Indicator will flash to indicate that the card may now be passed through the MCR slot, or “swiped”. Refer to Figure 8 for the card orientation.

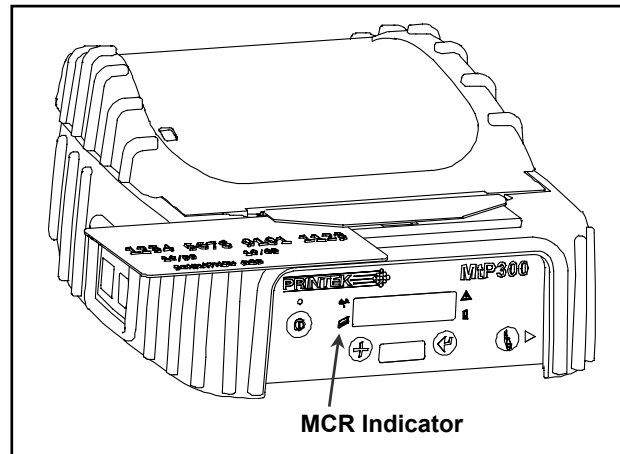





Figure 8 - Using The Magnetic Card Reader

If the card is read successfully, a short beep will sound, “Card Read Ok” will be displayed and the  MCR Indicator will stop flashing and remain on briefly to indicate success as the data is sent to the host system.

If the card is not read successfully, a longer error tone will sound, “Card Not Read” will be displayed and the  Error Indicator will also begin to flash. If the read operation is not cancelled by the host application within a few seconds, the  Error Indicator will stop flashing and the printer will return to the “Swipe Card Now” mode. At this time the card may be swiped again to attempt a successful read.

The length of time allowed before the timeout is specified by the host application program. Once a timeout occurs, the  Error Indicator will turn on momentarily and “MCR Timeout” will be displayed.

Fault Messages

Check Paper



This message is displayed and the  Error Indicator flashes whenever the printer runs out of print media. This may also occur if there has been a paper jam that prevents paper from feeding into the print head. To clear the error, first clear the jam and/or install new media. For information on how to replace the media supply or to check for a possible jam, please refer to “Installing Media” on page 4 in the Getting Started section of this manual.

Next, momentarily press the  Paper Feed Button to resume printing.

Note: If the printer has firmware version 2.8 or later, pressing the  Paper Feed Button will cause the printer to perform a Form Feed and then reprint the last print job. If the entire job does not print as expected, the host program may need to be modified to make use of the printer’s buffer commands. Please refer to the *MtP Series & FieldPro Programmer’s Manual* for more information.

It is also possible that a false paper error may be detected when using “black mark” sensing on preprinted forms. This condition should not occur unless the size of the black mark on the form is larger than the size allowed for in the host application program. Please refer to the *MtP Series & FieldPro Programmer’s Manual* for more information.

Paper Door Open

This message is displayed and the  Error Indicator flashes when the printer is attempting to print and the Paper Door is not fully closed. To correct this error, make sure that the media is loaded properly, close the Paper Door, and momentarily press the .

Printer Configuration

Introduction To Setup

The MtP300 Series printers feature an easy to use control panel “Setup” menu system for setting permanent configuration parameters. These menus offer many useful and necessary features, but are typically only used when first setting up the printer. They are rarely used in normal everyday operation. The values that are set are used as the “defaults” whenever the printer is turned on or reset by the host system. Application programs often send commands that may override any of these values.

As an alternative to using the Setup Menus described below, you may also use the “MtP Setup” remote configuration utility. This utility runs on a Windows Desktop system and connects to the printer’s serial port.

Setup Basics

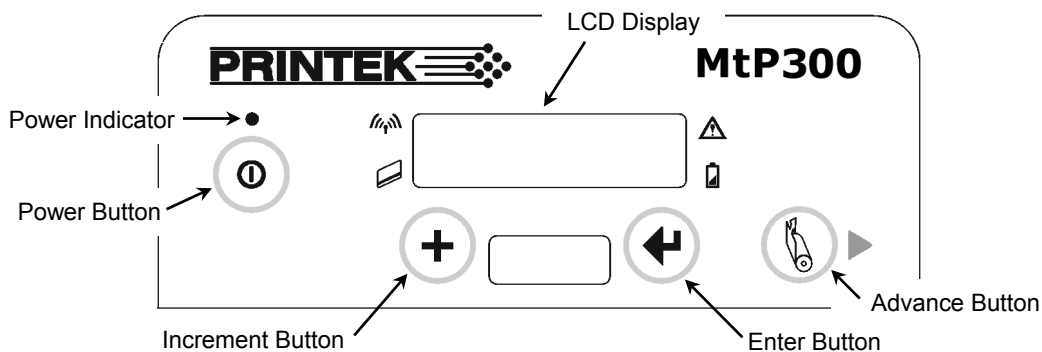

Figure 9 - MtP300 Control Panel

When in Setup, the top line of the LCD Display shows the name of the menu or the name of a “feature” within the menu. The bottom line of the display shows the current value that is set to be used for the item displayed on the top line.

The Setup menus operate as a “What You See Is What You Get” system. This means that whenever you view or change any of the menu choices available, the value showing when you proceed to the next item or exit Setup is the value the printer will use after you exit Setup. Note that when exiting Setup, you may elect to discard any changes.

Entering Setup

To enter Setup, press and hold the ◀ Enter Button while turning on the printer with the Ⓚ Power Button. Continue to hold the Enter Button until “**Menus Active**” appears on the LCD Display. After releasing the ◀ Enter Button, “**Entering Setup Menus**” will be displayed momentarily before advancing to the “**FORMAT MENU**”. While in Setup Mode, the power indicator will blink slowly.

Selecting Menus

Once Setup Mode has been successfully entered, the “**FORMAT MENU**” is the first menu displayed. Note that while in Setup Mode, the Ⓚ Paper Feed Button now operates as an ▶ Advance Button. To advance to the **INTERFACE MENU** or **OPTIONS MENU**, or to **Exit Setup**, press the ▶ Advance Button until the desired menu is displayed. With a few exceptions which are described where appropriate, pressing the ▶ Advance Button will always advance you to the next menu.

Detailed explanations on how to navigate each of the menus and use their features follow.

Exiting Setup

Setup may be exited by pressing the ▶ Advance Button until “**Exit Setup**” is displayed on the top line of the LCD Display, and “**Save Changes**” is displayed on the bottom line. To save any changes you have made and exit Setup press the ◀ Enter Button. If feature values were changed, “**Exiting Menus Saving Changes**” will be displayed. If no values were changed, “**Exiting Menus No Changes**” will be displayed.

If you do not want to save the changes you have made, press the + Increment Button to display “**Discard Changes**” on the bottom line and then press the ◀ Enter Button. “**Exiting Setup No Changes**” will be displayed.

After Setup is exited and any changes saved, the printer will reset and reinitialize itself to adopt any changes that may have been made. Note that when this reset occurs, any data that may have been in the input buffer will be discarded.

Setup Menu Summary

The following table is a summary of the features and possible values available in the Format, Interface, and Options Menus. This table may be used to help locate a particular item, or as a “quick reference” for the Setup menu system.

Setup Menu Summary

Format Menu	Interface Menu				Options Menu
Format <i>n</i>	Serial	IrDA	Bluetooth	Wi-Fi	
Format Name Up to 16 Characters Font 4.2, 5.5, 10.2, 10.7, 16.9, 18.5, 20.3 SansSerifA; 12.7, 13.5, 14.5, 15.6, 16.9*, 18.5, 20.3, 22.6, 25.4 Courier Spacing 0 - 10, 3* Left Margin 0* - 1.0244" Right Margin 0* - 1.2608" Print Contrast -75 to +125, 0* (+35* for LP Models) Max Paper Speed 0.32 to 3.30* ips (2.30* for LP Models) Form Feed Distance 0 – 2.5216", 1.2608* (Mark Sensing for LP Models) Mark Sensing Front*, Back, Gap (Back* for LP Models) Mark Sensitivity -10 to +10, 0* Gap Sensitivity -10 to +10, 0* Tear to Mark Dst -0.7092" to 1.7927", 0* Present Distance 0.0000"* to 1.2911"	Emulation Printek*, O'Neil, ZPL-II, Mt3, CPCL, Hex Dump Baud Rate 9600, 19200, 38400, 57600* Data Bits 7, 8* Stop Bits 1*, 2 Parity None*, Even, Odd XON/XOFF Off*, On ETX/ACK Off*, On RTS/CTS Off, On*	Emulation Printek*, O'Neil, ZPL-II, Mt3, CPCL, Hex Dump	Emulation Printek*, O'Neil, ZPL-II, Mt3, CPCL, Hex Dump Pairing Mode Paired*, Unpaired Role Policy Defer*, Master Discoverability On*/Off Pin 0*, Up to 16 Numeric Chars. Security Off*, On Local Name MtP300-Serial#* Address (Displayed Only)	Emulation Printek*, O'Neil, ZPL-II, Mt3, CPCL, Hex Dump WLAN Type Infrastructure*, Peer-to-Peer WLAN Channel 1* – 14 WLAN SSID any* WLAN WEP Bits 0*, 64, 128 WEP Key 1-4 10 or 26 Char. Hex String "000...0"* WLAN Auth Auto*, Open, Shared IP Address Assign DHCP*, Static IP Address 0.0.0.0* IP Subnet Mask 0.0.0.0* IP Gateway 0.0.0.0* Tunnel Port# 08023*	Max Format # 1* – 5 Auto Power Down Off*, 1 – 15 Minutes User Language English*, French, German Truncate Lines No*, Yes Print Promo No*, Yes

Format Menu

FORMAT MENU <i>Current Format</i>

The MtP300 supports five “Formats”, or sets of printing parameters that may be selected either through the control panel or by host application programs. These Formats include printing related features such as Form Length, Font, Character Pitch, Margins, etc. Each Format also includes the ability to name the Format with a name such as “Receipt”, “Routing Label”, or “Shipping Label”, etc.

Upon entering Setup as described earlier in “Setup Basics”, the Format Menu is the first menu that will appear.

The bottom line of the display shows the Format that is currently selected. If you wish to change to a different format, press the **+** Increment Button until the desired Format is displayed.

Note: If you wish to use more than one Format, you must first enable additional Formats. Please refer to the “Max Format” feature in the “Options Menu” on page 31.

Once the desired Format is displayed, you may do one of the following:

press the **↵** Enter Button to review and/or change the features related to the displayed Format, or

press the **▶** Advance Button to advance to the INTERFACE MENU

Pressing the **↵** Enter Button will advance through the following features for the selected Format in the order listed below.

Format Name

Format Name Format 1

Possible Values: Up to 16 characters of A through Z, 0 through 9, SPACE

When shipped from the factory, the name for each format will be “FORMAT 1”, “FORMAT 2”, etc. This name may be changed to any combination of capital letters (A-Z), numerals (0-9), or spaces. The name may be up to 16 characters in length.

To advance through the character positions of the name, press the **▶** Advance Button. To change the character at the current position, press the **+** Increment Button. The order of characters that may be selected is “ABCDEFGHIJKLMNOPQRSTUVWXYZ SPACE 0123456789”. The name will automatically be centered on the display after exiting Setup, so there is no need to try to center it with spaces.

Font

Font
16.9 cpi Courier

Possible Values: 4.2 cpi SnsSrfA 16.9 cpi SnsSrfA
 5.5 cpi SnsSrfA 16.9 cpi Courier*
 10.2 cpi SnsSrfA 18.5 cpi SnsSrfA
 10.7 cpi SnsSrfA 18.5 cpi Courier
 12.7 cpi Courier 20.3 cpi SnsSrfA
 13.5 cpi Courier 20.3 cpi Courier
 14.5 cpi Courier 22.6 cpi Courier
 15.6 cpi Courier 25.4 cpi Courier

Any downloaded fonts will also be displayed.

This feature selects the default font and character pitch.

Spacing

Spacing
3 Lines

Possible Values: 0 ... 3* ... 10 Lines

When printing text, this feature sets spacing between lines. The height of a complete line, or line pitch, is determined by adding the vertical size of the current font to the Spacing. With Spacing set to the default value of “3” and using a font that is 23 rows high, the line pitch would be 3 + 23, or 26 dot rows. Since each dot row is 0.125mm, 26 x 0.125 yields a line pitch of 3.25mm. or 7.8 lines per inch. This line pitch value also determines the amount of paper motion performed when an ASCII Line Feed character is received by the printer.

When printing PC Line drawing characters, Spacing should be set to “0” to avoid space between rows of characters used to draw vertical lines.

When printing graphic data, Spacing has no affect so that multiple lines of graphics may print adjacent to each other.

Left Margin

Left Margin
0.0000”

Possible Values: 0.0000”* ... 1.0244” in increments of 0.0394”

This feature sets the left margin in inches relative to the leftmost printing position. The left margin must be less than the right margin.

Right Margin

Right Margin
0.0000”

Possible Values: 0.0000”* ... 1.2608” in increments of 0.0394”

This feature sets the right margin in inches relative to the rightmost printing position.

Text characters that would have printed to the right of the margin will either be “wrapped around” and printed on the next line, or will be discarded based on the setting for “Truncate Lines” in the Options Menu.

Graphic data that would have printed to the right of the margin will be truncated.

Printer Configuration

Print Contrast

Print Contrast
0

Possible Values: -75 ... 0* ... +125 in increments of 5 (+35* for LP Models)

The printer automatically adjusts the amount energy used in order to maintain constant print quality as the battery discharges during use. The Print Contrast setting modifies the value that is determined to be needed by the printer and may be used to obtain improved print quality on different qualities of thermal print media.

Note: By affecting the relative amount of battery energy that is used when printing, the Print Contrast setting affects both print speed and battery life. Setting a lower value will result in faster printing and will extend normal battery life. Setting a higher value may allow the use of poorer quality media and will result in slower printing and a shorter battery life.

Maximum Paper Speed

Max Paper Speed
3.30 ips

Possible Values: 0.32 ... 3.30* ips (2.30* for LP Models)

This feature may be used to reduce the maximum paper speed if necessary to allow the printer to use heavier papers, labels, narrow paper or labels, or some coated papers that have a more slippery finish.

Form Feed Distance

FFeed Distance
1.2608"

Possible Values: 1.0000" ... 1.2608"* ... 2.5216"

This feature sets the distance that paper is to be moved whenever the user presses the  Paper Feed Button or a Form Feed character is received from a host system.

Mark Sensing

Mark Sensing
Front

Possible Values: Front*, Back, Gap (Back* for LP Models)

Mark Sensing is used to identify form or label position marking and must be set to match the media being used. The use of Black Mark or Gap sensing is associated with the design of the application program that is controlling the printer. For more information on Black Mark or Gap sensing, please refer to the *MtP Series & FieldPro Programmer's Manual*.

Note: This feature is only available in MtP300 LP models.

Mark Sensitivity

Mark Sensitivity 0

Possible Values: -10 ...0* ...+10

This feature allows the Black Mark/Paper sensor to be adjusted to allow for variations in media materials and Black Mark printing methods. The following list will help determine if, and how, the Mark Sensitivity should be adjusted.

- If the printer is not detecting black marks reliably, set the Mark Sensitivity to a lower value.
- If the printer is detecting false Check Paper errors, set the Mark Sensitivity to a higher value.
- If the printer is detecting black marks where none exist, set the Mark Sensitivity to a higher value.

Gap Sensitivity

Gap Sensitivity 0

Possible Values: -10 ...0* ...+10

This feature is used to adjust the sensing of gaps between labels when using precut labels that are provided on a removable backing. The following method should be used to adjust the gap sensor.

- If the printer is not detecting gaps between labels reliably, set the Gap Sensitivity to a higher value.
- If the printer is detecting gaps where none exist, set the Gap Sensitivity to a lower value.

Note: This feature is only available in MtP300 LP models.

Tear to Mark Distance

Tear to Mark Dst 0.0000"

Possible Values: -0.7092" ...0.0000"* ...1.7927"

This feature is used to set the distance from the tear position on the paper/labels to the black mark. If the tear position is above the black mark, the value is negative. If the tear position is below the black mark, the value is positive.

Present Distance

Present Distance 0.0000"

Possible Values: 0.0000"* ...1.2911"

This feature sets the distance the paper is moved forward after the black mark is sensed. When the black mark is sensed, the paper will be fed forward by this amount to allow for tearing or peeling of a label. When the next print job begins, the paper will be reverse fed this same amount before printing begins.

When the Tear to Mark Distance is a negative value, this is typically set to the inverse of that value.

Interface Menu

```
INTERFACE MENU
Current Host I/O
```

After entering Setup as described earlier in “Setup Basics”, press the ► Advance Button until “INTERFACE MENU” is displayed on the top line.

The bottom line displays the currently selected host interface. The Interface Menu provides access to the features that may be configured for the currently selected interface.

Note that the Serial interface is standard in all MtP300 Series printers. If another, optional interface such as IrDA, Bluetooth, or Wi-Fi is installed, you may select between the Serial interface and the optional interface by pressing the + Arrow Button. Once the desired interface is displayed, you may do one of the following:

- press the ◀ Enter Button to review and/or change the features related to the selected interface, or
- press the ► Advance Button to advance to the OPTIONS MENU

Pressing the ◀ Enter Button will advance through the following features for the selected Interface in the order listed below.

Please refer to “Interfacing To A Host Computer” on page 33 for additional information.

Serial Interface

```
INTERFACE MENU
Serial
```

Note that “Serial” must be displayed on the bottom line of the display in order to access the following features and for this interface to be active when Setup is exited.

Emulation

```
Emulation
Printek
```

Possible Values: Printek*, O’Neil, ZPL-II, Mt3, CPCL, Hex Dump

This feature sets the family of printer commands that may be used by a host application program to control the various capabilities of the printer. The printer will only respond to commands valid for the currently selected emulation. For more information, please refer to the *MtP Series & FieldPro Programmer’s Manual*.

Baud Rate

Baud Rate
57600

Possible Values: 9600, 19200, 38400, 57600*

This feature sets the baud rate for the Serial interface. The value must match the setting used on the host system.

Data Bits

Data Bits
8

Possible Values: 7, 8*

This feature sets the number of data bits in the serial character frame. The value must match the setting used on the host system.

Stop Bits

Stop Bits
1

Possible Values: 1*, 2

This feature sets the number of stop bits included in the serial character frame. The value must match the setting used on the host system.

Parity

Parity
None

Possible Values: None*, Even, Odd

This feature sets the parity checking requirements for the data bits in the serial character frame. The value must match the setting used on the host system.

XON/XOFF Handshaking

XON/XOFF
Off

Possible Values: Off*, On

This feature enables or disables the XON/XOFF (DC1/DC3) character handshaking method used to control data flow from the host system to the printer. When enabled, an XOFF character will be sent by the printer whenever the printer's input buffer is nearly full. An XON character will be sent whenever the printer's input buffer becomes nearly empty or if the control panel Setup Mode has been exited.

Printer Configuration

ETX/ACK Handshaking

ETX/ACK
Off

Possible Values: Off*, On

This feature enables or disables the ETX/ACK character handshaking method used to control data flow from the host system to the printer. When enabled, an ACK character will be sent by the printer after an ETX character has been received and processed out of the input buffer. ETX characters used for handshaking cannot be part of an escape sequence.

RTS/CTS Handshaking

RTS/CTS
On

Possible Values: Off, On*

This feature enables or disables the RTS/CTS hardware handshaking method used to control data flow from the host system to the printer. When enabled, the printer will activate the RTS signal whenever the printer's input buffer becomes nearly empty or when the printer's control panel Setup Menus are active. The RTS signal will be deasserted whenever the printer's input buffer becomes nearly empty or Setup Mode has been exited.

Likewise, the printer will not send data to the host system if the host has asserted the CTS signal.

IrDA Interface

INTERFACE MENU
IrDA

Note that "IrDA" must be displayed on the bottom line of the display in order to access the following features and for this interface to be active when Setup is exited.

Emulation

Emulation
Printek

Possible Values: Printek*, O'Neil, ZPL-II, Mt3, CPCL, Hex Dump

This feature sets the family of printer commands that may be used by a host application program to control the various capabilities of the printer. The printer will only respond to commands valid for the currently selected emulation. For more information, please refer to the *MtP Series & FieldPro Programmer's Manual*.

Bluetooth Interface

INTERFACE MENU
 Bluetooth

Note that “Bluetooth” must be displayed on the bottom line of the display in order to access the following features and for this interface to be active when Setup is exited.

Emulation

Emulation
 Printek

Possible Values: Printek*, O’Neil, ZPL-II, Mt3, CPCL, Hex Dump

This feature sets the family of printer commands that may be used by a host application program to control the various capabilities of the printer. The printer will only respond to commands valid for the currently selected emulation. For more information, please refer to the *MtP Series & FieldPro Programmer’s Manual*.

Note: After pressing the **↵** Enter Button to move from Emulation to Pairing Mode, the printer will pause and display “Waiting for Bluetooth” while reading the current configuration from the Bluetooth interface module.

Pairing Mode

Pairing Mode
 Paired

Possible Values: Paired*, Unpaired

This feature allows Bluetooth pairing to occur between the printer and the connecting device whenever Security is required by either device. Pairing requires that the PIN on the printer and the connecting exactly match each other.

Role Policy

Role Policy
 Defer

Possible Values: Defer*, Master

Note that this feature is only available in firmware version 2.8 or later.

This feature selects the role of the printer’s interface in the Bluetooth network.

If the device attempting to communicate with the printer is having trouble discovering the printer, setting the value to Master may correct the problem.

Printer Configuration

Discoverability

Discoverability
On

Possible Values: Off, On*

This feature is used to set whether the printer may be discovered by other Bluetooth devices.

PIN

PIN
0

Possible Values: 0*, Up to 16 Numeric Characters.

Note that this feature is only available if Pairing Mode is set to Paired.

To advance through the character positions, press the ► Advance Button. To change the character at the current position, press the + Increment Button. The characters that may be selected are “0123456789” and SPACE. Setting a character to SPACE will terminate the value being set.

Security

Security
Off

Possible Values: Off*, On

Setting Security to On forces the printer and the remote device to use pairing. Setting Security On requires that Pairing is set to Paired and that a PIN has been entered that matches the PIN in the remote device.

Local Name

Local Name
MtP300-AAANNNNN

Possible Values: MtP300-*aaannnnn**

Up to 16 characters of “0” through “9”, “A” through “Z”, “a” through “z”, “-”, “_”, SPACE

This feature sets the name that will be displayed by most host systems when “discovering” the printer. When shipped from the factory, the default value for the Bluetooth Local Name is “MtP300-*aaannnnn*” where “*aaannnnn*” is the printer’s serial number. This name may be changed to any combination of letters, numbers, dashes, underscores, and SPACES. The name may be up to 16 characters in length.

To advance through the character positions of the name, press the ► Advance Button. To change the character at the current position, press the + Increment Button. The order of characters that may be selected is “0123456789 ABCDEFGHIJKLMNOPQRSTUVWXYZ abcdefghijklmnopqrstuvwxyz - _ SPACE”.

Address

Address
0080371B8F32

Possible Values: Twelve digit hexadecimal string.

This feature displays the unique hardware value associated with the particular Bluetooth interface installed in the printer. This value is set by the hardware manufacturer, is guaranteed to be unique for each interface, and may not be changed.

Wi-Fi Interface

INTERFACE MENU
Wi-Fi

Note that “Wi-Fi” must be displayed on the bottom line of the display in order to access the following features and for this interface to be active when Setup is exited.

Emulation

Emulation
Printek

Possible Values: Printek*, O’Neil, ZPL-II, Mt3, CPCL, Hex Dump

This feature sets the family of printer commands that may be used by a host application program to control the various capabilities of the printer. The printer will only respond to commands valid for the currently selected emulation. For more information, please refer to the *MtP Series & FieldPro Programmer’s Manual*.

Note: After pressing the **↵** Enter Button to move from Emulation to WLAN Type, the printer will pause and display “Waiting for Wi-Fi” while reading the current configuration from the Bluetooth interface module.

WLAN Type

WLAN Type
Infrastructure

Possible Values: Infrastructure*, Peer-to-Peer

This feature specifies the type of wireless network the printer will be attached to. An Infrastructure network consists of nodes that connect to each other and/or a wired network through an Access Point. A Peer-to-Peer, or Ad-Hoc, network consists of nodes that connect directly to each other without the control of an access point.

Printer Configuration

WLAN Channel

WLAN Channel
1

Possible Values: 1* ... 14

Note that this feature is only available if the WLAN Type is set to Peer-to-Peer.

This feature sets the radio channel to be used when communicating in a Peer-to-Peer network. When in an Infrastructure network, the radio channel is automatically assigned by the interface and Access Point.

WLAN SSID

WLAN SSID
any

Possible Values: any*,

Up to 16 characters of “0” through “9”, “A” through “Z”, “a” through “z”,

This feature specifies the “name” of the network the printer will connect to. This allows communications to be controlled, or routed to the appropriate nodes when multiple wireless networks are present. When set to “any”, the printer may connect to any available network(s).

To advance through the character positions, press the ► Advance Button. To change the character at the current position, press the + Increment Button. The order of characters that may be selected is “0123456789 ABCDEFGHIJKLMNOPQRSTUVWXYZ abcdefghijklmnopqrstuvwxyz”.

WLAN WEP Bits

WLAN WEP Bits
0

Possible Values: 0*, 64, 128

This feature specifies the level of Wired Equivalent Security to use. If set to “0”, security is turned off. If set to a “64” or “128” bit encryption level, a WEP Key must be entered that matches the key on the other nodes on the network.

WEP Key 1
WEP Key 2
WEP Key 3
WEP Key 4

Key1: 1234567890

– OR –

Key1: 0123456789
01234567890ABCDE

Possible Values: 10 or 26 character user specified hexadecimal string

Note that this feature is only available if WLAN WEP Bits is set to 64 or 128.

This feature specifies an encryption “key” or password that is used to encrypt/decrypt data on the network. If WLAN WEP Bits is set to “64”, a ten character hexadecimal string must be entered that matches the key on the other nodes the printer will be communicating with. If WLAN WEP Bits is set to “128”, a 26 character hexadecimal string must be entered.

WLAN Auth

WLAN Auth
Auto

Possible Values: Auto*, Open, Shared

This feature specifies the authentication method that will be used when establishing connections on the network. The method may be to use an open key or a shared key. If set to “Auto”, the printer will automatically match itself to the method used by other nodes.

IP Address Assign

IP Addr Assign
DHCP

Possible Values: DHCP*, Static

This features specifies whether the printer will obtain an IP address from a DHCP server, or if a an IP address will be manually assigned.

IP Address

IP Address
0.0.0.0

Possible Values: 0.0.0.0*, User specified

This feature specifies the IP address for the printer.

Note that this feature has no effect if IP Address Method is not set to “Static”.

IP Subnet Mask

IP Subnet Mask
0.0.0.0

Possible Values: 0.0.0.0*, User specified

This feature specifies the range of addresses, or the size of the network, that the printer’s IP address belongs to.

Note that this feature has no effect if IP Address Method is not set to “Static”.

IP Gateway

IP Gateway
0.0.0.0

Possible Values: 0.0.0.0*, User specified

This feature specifies the network node where data destined for a node outside of the LAN should be directed.

Note that this feature has no effect if IP Address Method is not set to “Static”.

Printer Configuration

Tunnel Port Number

Tunnel Port# 08023

Possible Values: 00000 ... 08023* ... 65384

This feature specifies the TCP/IP port to be used for data that is to be printed..

To advance through the character positions, press the ► Advance Button. To change the character at the current position, press the + Increment Button.

Options Menu

OPTIONS MENU

The **OPTIONS MENU** contains features that affect how the printer operates regardless of how features in other menus have been set.

After entering Setup as described earlier in “Setup Basics”, press the ► Advance Button until “**OPTIONS MENU**” is displayed on the top line. You may now do one of the following:

- press the ◀ Enter Button to review and/or change the features available, or
- press the ► Advance Button to advance to the **TEST MENU**

Pressing the ◀ Enter Button will advance through the following features in the order shown below.

Maximum Format Number

Max Formats
Format 1

Possible Values: Format 1* ... Format 5

This feature sets the highest Format number to be displayed in the Format Menu. This allows the operator to see only the formats that are in use rather than having to potentially sort through several unused formats.

Note that when changing the value of this feature, you may not select a value less than the value currently set in the Format Menu.

Auto Power Down

Auto Power Down
Off

Possible Values: Off*, 1 Minute Delay ... 15 Minute Delay

This feature sets whether the printer will automatically power down and if so, after what period of time of inactivity. If set to a value other than “Off”, the printer will automatically turn itself off after the specified number of minutes have passed since the printer last received data or last printed, whichever is longer.

User Language

User Language
English

Possible Values: English*, French, German

This feature specifies the language to be used when presenting information on the control panel’s LCD Display.

Printer Configuration

Truncate Lines

Truncate Lines No

Possible Values: No*, Yes

This feature specifies what is to be done with data that will not fit within the printable area of the current Format. The printable area is defined as the printable line length of the print head (approximately 4.1 inches) minus the area specified by the left and right margin.

When printing text, a value of “No” will cause excess data to be “wrapped around” and printed at the beginning of the next line. A value of “Yes” will cause the excess data to be discarded.

When printing graphics, excess data will always be discarded.

Print Promotion

Print Promo No

Possible Values: No*, Yes

This feature is only available in firmware version 2.8 or later.

When set to “Yes” this feature causes a previously stored graphic image with an ID value of “\$” to be printed at the end of each print job.

This feature may be used to print a special logo or graphic image of a special sales promotion or other event, that also needs to be enabled/disabled by the user in the field.

Note: In firmware version 2.9 and later, multiple graphic images may be stored with the ID values of “!”, “@”, “#”, “\$”, “%”, “^”, “&”, “*”, “(”, and/or “)”. In this case, the printer will automatically cycle through each of these images printing one at the end of each print job.

Please refer to the *MtP Series & FieldPro Programmer’s Manual* for more information on storing graphics and logos.

Interfacing To A Host Computer

Every MtP300 is equipped with an RS-232C Serial Interface. Optional factory installed interfaces are also available for IrDA (Infrared), Bluetooth®, and Wi-Fi®. When the printer is equipped with one of the optional interfaces, the interface that is selected in the Interface Menu as described on page 22 is the one that will be active and the other interface will be ignored.

Note: To print out configuration information for the currently selected interface, you may press and hold the **↵** Enter Button until “Printing Setup” is displayed.

Note: To switch back-and-forth between the RS-232C Serial interface and an optional interface (if installed), you may continue to the **↵** Enter Button until “Interface Now ‘*interface*’” is displayed. After the **↵** Enter Button is released, the alternate ‘*interface*’ will be selected and the setup information for the newly selected interface will be printed. (This is merely a shortcut method and accomplishes the same result as using the Interface Configuration Menu.)

RS-232C Serial Interface

To communicate using the Serial interface, “Serial” must be selected in the Interface Menu as described on page 22. If there is no optional interface installed, Serial will be the only interface available. When using the Serial interface, the baud rate, data bits, parity, stop bit(s), and handshaking method (XON/XOFF, ETX/ACK, RTS/CTS) must be set to match the settings on the host computer. If these settings do not match, errors and/or lost data may occur. The serial connector is an “RJ” type connector located on the side of the printer. The pin assignments are shown below.

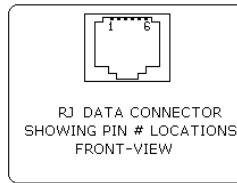

Pin #	Signal	Description
1	COM	Logic Common
2	TXD	Transmit Data (From Printer)
3	RXD	Receive Data (From Host)
4	CTS	Clear To Send (From Printer)
5	COM	Logic Common
6	RTS	Request To Send (From Host)

Figure 10 - Serial Interface

IrDA Interface

In addition to the standard Serial interface, your MtP300 may be equipped with an optional IrDA interface. IrDA interfaces are commonly found on many PDA's and notebook computers. To communicate using the IrDA interface, "IrDA" must be selected in the Interface Menu as described on page 24.

The IrDA interface uses infrared light to provide a cable free, short range interface. Since the communications medium is light, it is "line-of-sight" and requires that the interfaces on the printer and the host device be aligned with, or pointed at, each other. The printer's transmitter and receiver are located behind an "IrDA Window" as indicated in Figure 11.

Whenever a host computer has established a connection with the printer, the  Wireless Indicator will illuminate.

Note: The printer's IrDA implementation makes use of IrCOMM rather than IrLPT. As a result, some host systems will require that the printer connection be established using a "COM" port rather than selecting "IrDA". In most PDA's, for instance, this will be "COM3".

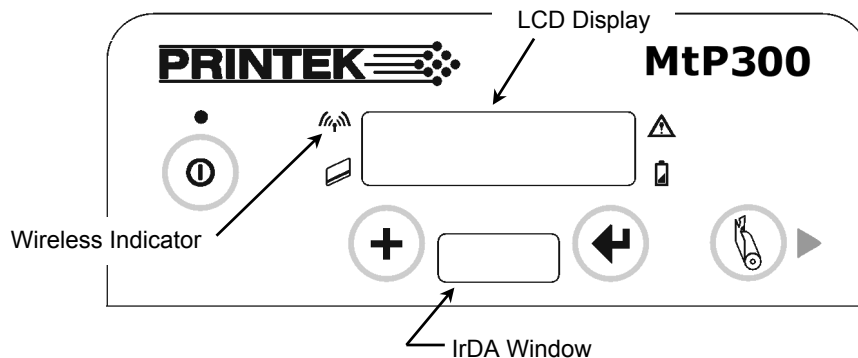

Figure 11 – Wireless Indicator & IrDA Window

Bluetooth® Interface

In addition to the standard Serial interface, your MtP300 may be equipped with an optional Bluetooth interface. Bluetooth interfaces are built into some PDA's and may be added to most others. Bluetooth interfaces may also be added to notebook or desktop computers. To communicate using the Bluetooth® interface, "Bluetooth" must be selected in the Interface Menu as described on page 25.

The Bluetooth interface uses wireless, radio frequency signals to communicate, which eliminates the line-of-sight requirement imposed by the IrDA interface.

The MtP300 Bluetooth interface acts as a "serial port adapter" operating as a "server". Being a serial port adapter means that the printer may appear as a "Serial Device" when discovered, rather than as a "Printer". Operating as a server, other devices such as a PDA or other host computer may initiate the connection to the printer.

When discovered, the default name that will appear will be "MtP300-aaannnnn" where "aaannnnn" is the printer's serial number. To obtain the printer's Bluetooth name, you may use the printer's Setup menus or you

may have the printer print it out. To print all the configuration for the interface, press and hold the  Enter Button until “Printing Setup” is displayed.

Whenever a host device has established a connection to the printer, the  Wireless Indicator will be lit. When the host closes the connection, the indicator will turn off. To conserve battery power, application programs should disconnect from the printer whenever possible.

Wi-Fi[®] Interface

In addition to the standard RS-232C Serial interface, your MtP300 may be equipped with an optional Wi-Fi interface. Wi-Fi interfaces are built into some PDA's and may be added to most others. Wi-Fi interfaces may also be added to notebook or desktop computers and as an “access point” to a wired network. To communicate using the Wi-Fi interface, “Wi-Fi” must be selected in the Interface Menu as described on page 27.

The Wi-Fi interface uses wireless, radio frequency signals to communicate, which eliminates the line-of-sight requirement imposed by the optional IrDA interface.

The MtP300 Wi-Fi interface acts as a server and will accept connections from a host device such as a PDA, notebook computer, or a network server.

The MtP300 Wi-Fi interface conforms to the IEEE 802.11b standard. The factory default settings for this interface are:

WLAN Type: Infrastructure
 WLAN SSID: any
 WLAN WEP Bits: 0 (Off)
 WLAN Auth: Auto
 IP Address Assign: DHCP (The DHCP name will be “MtP300-*aaannnnn*”
 where “*aaannnnn*” is the printer's serial number.)
 Port: 8023

These settings for the Wi-Fi interface features may be modified using the Interface Setup Menu as described beginning on page 27 with the exclusion of the IP Port. Note that changing the values of some of these features may cause additional features to be displayed. For instance, changing WLAN WEP Bits from “0”, or Off, to “64” or “128” will cause the “WEP Key 1-4” features to be displayed so that the appropriate sized encryption key(s) may be entered.

To print out the current Wi-Fi configuration details, you may press and hold  Enter Button until “Printing Setup” is displayed. This feature is especially useful for obtaining the current IP address when assigning addresses via DHCP. When doing so, be sure to wait several seconds after turning the printer on to allow it to establish a connection with the network and be served an address.

The  Wireless Indicator will light whenever the printer is currently receiving a print job.

When operating in Infrastructure mode, the printer will attempt to conserve battery power whenever possible by placing the Wi-Fi interface into a low power mode when not communicating. However, according to the IEEE 802.11b standard, the printer must be granted “permission” from the network's Access Point before operating in the low power mode. Since different Access Point manufacturers implement this feature differently, the amount of power saving actually achieved varies. The actual power saving also varies with the amount of network traffic.

Power Considerations

MtP300 printers are designed to provide superior output using as little power as necessary. This provides the longest possible battery life. The printers may also be operated from an external power supply when used in a more permanent installation in a vehicle or office. The following discussions indicate how the printer accomplishes this power conservation using features such as Standby and Auto Power Down. For more information on battery charging, please refer to “Charging the Battery” on page 40.

Standby Operation

When operating on battery power, the printer automatically enters a Standby mode one minute after last receiving data, printing, a front panel button is pressed, or a magnetic card reader swipe operation. When in Standby, the printer will flash the  Power Indicator.

While in Standby the printer turns off as many power consuming components as possible. However, the printer remains fully capable of receiving data or responding to a control panel button. The printer will automatically “wake up” when it begins to receive data from a host system, or when any front panel Button is pressed.

Auto Power Down

To conserve even more battery power, the printer may also be configured to turn itself off after a specified number of minutes of inactivity. When the printer powers down, this is equivalent to turning the printer off using the  Power Button and the printer will no longer respond to incoming data.

To enable the Auto Power Down feature, please refer to the Options Menu settings beginning on page 31.

Operation Without A Battery

MtP300 printers may be operated with an optional power supply and without a battery installed. Power supplies are available for use with 100-240VAC/50-60Hz and for 12/24VDC vehicle applications.

Caution: Use only Printek power supplies designed specifically for your MtP300 printer. Using a different power supply may cause damage to the printer and will not be covered by the printer’s warranty.

Note: When the printer is connected to an external power supply, the printer will not enter Standby as described above.

Maintenance and Troubleshooting

Cleaning

In normal environments, the printer should be cleaned after printing a few rolls of paper or if there are voids in the printout. For optimum performance and life, you should clean the Print Head and Platen Roller whenever you load new paper.

To clean the printer areas as described below, use a Thermal Head Cleaning Pen available from Printek, or you may use cotton swabs moistened with isopropyl alcohol. Please refer to Figure 12 for the following instructions.

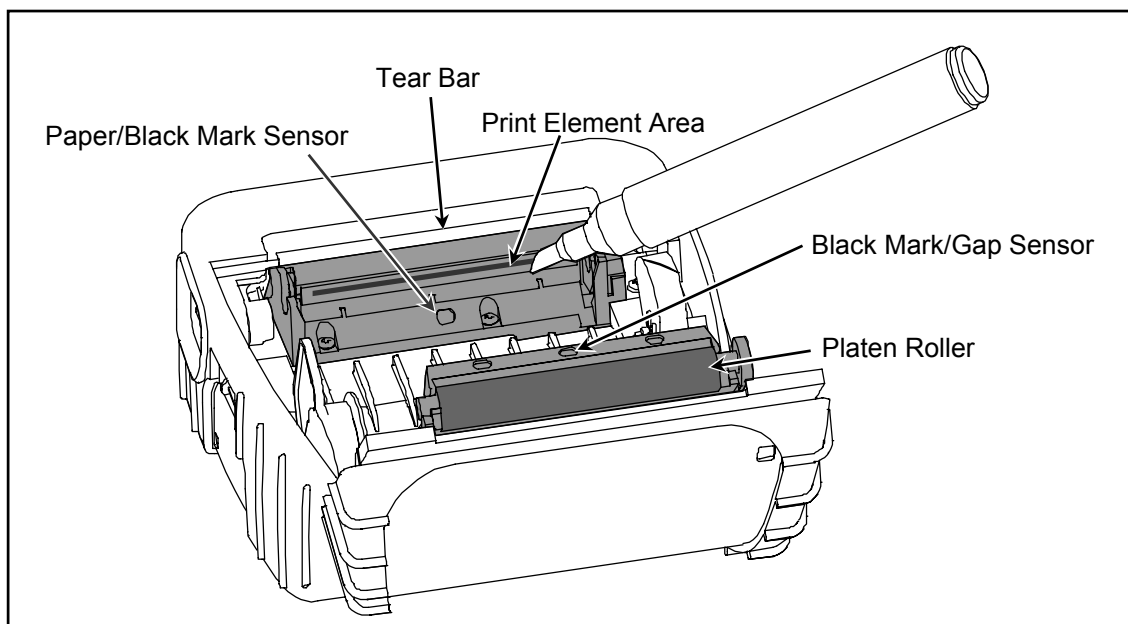

Figure 12 - Printer Cleaning Areas

- Turn the printer off. Open the Paper Door and remove the paper.
- Using a Thermal Head Cleaning Pen, clean the Print Element Area on the Print Head.
Caution: Do not use sharp objects to clean the print head. This may damage the printer and require service. Such damage is not covered under warranty.
- Clean the Paper/Black Mark Sensor in the lower part of the print head.
- Clean the Tear Bar
- If a Magnetic Card Reader is installed, pass an MCR Cleaning Card through the MCR slot to clean the head.
- Clean the Platen Roller. Turn the platen roller with your finger to clean the entire surface.
- If your printer is an MtP300 LP model, clean the Back Black Mark/Gap Sensor Near the Platen Roller.



You may also experience a build up of paper dust in the printer. This may be removed using a can of compressed air or by vacuuming.

To clean the exterior of the printer, turn the printer off and use a soft cloth moistened with a mild detergent.

Battery Care

Charging the Battery

The printer's battery is charged in the printer using an optional power supply. Power supplies are available for 100-240VAC/50-60Hz and for 12/24VDC vehicle applications. Follow the steps listed below to charge the battery. An optional external two-bay charger is also available.

- Plug the power supply into a power source appropriate for the adapter being used.
- Plug the power supply into the power connector on the side of the printer. The printer's battery charging circuitry will analyze the condition of the battery and begin charging it if necessary.
- If the battery is not fully charged, charging will begin and the  Battery Indicator will illuminate.
- When the battery is fully charged, the  Battery Indicator will turn off. Charging may take up to 2½ hours depending on the condition of the battery.
- The printer may be used while the battery is charging, but this will extend the time required to fully charge the battery.
- The power supply may remain connected to the printer to keep the battery fully charged and will not cause damage to the printer or battery.

The printer's battery status is displayed in the lower right corner of the front panel LCD Display. The status is displayed as a battery shape which indicates the relative capacity that remains as indicated below.

Fully Charged  Discharged







Additional Battery and Safety Information

- All MtP300 Series printers use a 7.4 volt 2200mAh Lithium Ion battery.
- The recommended ambient temperature for charging is 68-77° Fahrenheit (20-25° Centigrade).
- Take the battery out of the printer when storing the printer for long periods of time. The battery storage temperature is 40-104° Fahrenheit (4-40° Centigrade). Do not store a fully charged battery at temperatures above this range for long periods of time or the battery may permanently lose charge capacity.
- Do not disassemble, short circuit, heat above 80°C, or incinerate the battery. The battery may explode.
- Only dispose of used batteries according to your local regulations. If you do not know your local regulations, the Rechargeable Battery Recycling Corporation (RBRC) is a non-profit organization created to promote recycling of rechargeable batteries. For more information visit www.rbrc.org.



Testing the Power Supply and Battery

To verify that the printer's internal battery charger is functioning properly, perform the following steps.

- Test the power adapter (100-240VAC/50-60Hz, 12/24VDC adapter) with a voltmeter to verify that its output voltage is 9 VDC.
- Connect the power supply to a power source and then connect it to the printer.
- Verify that the printer's  Battery Indicator is illuminated. If illuminated, the charging circuit is functioning properly.
 - **Note:** that if the battery is already fully charged, the  Battery Indicator will turn off after a short time.
- After the battery has been charged for five minutes, disconnect the power supply.
- Perform a printer Self-Test.
 - Make sure the printer is turned off. The power indicator will be off and the LCD Display will be blank.
 - Press and hold the  Paper Feed Button.
 - Continue holding the  Paper Feed Button and turn the printer on using the  Power Button until "Printing Current Menu Values" is displayed.
- If the printer successfully prints the Self-Test, the battery is functional. If the Self-Test does not complete and the printer turns itself off, repeat this test with a known good battery.
- Once this test has completed successfully, allow the battery to fully charge. At the end of this time the  Battery Indicator will turn off.

Note: If the printer is turned on, the battery status shown in the bottom right corner of the LCD display will always show a "full" battery whenever the printer is connected to the power supply.

If the printer and battery do not appear to successfully pass these tests, refer to the Troubleshooting section for possible causes and solutions.

Note: This test only verifies that the power adapter, the internal charging circuit, and the battery are functioning properly. This test does not provide a valid indication of the relative capacity of the battery or how long it may hold a charge.

Troubleshooting

When encountering problems, the cause may be the printer or may sometimes be due to other problems with your system. Please review the following tables to solve common problems you may encounter with your printer. You may also visit www.printek.com for additional “FAQ’s” that may assist you.

If you are still unable to solve your problem, please contact the company where you purchased your printer since they are most familiar with your systems. If they are unable to help you, you may contact Printek Technical Support at (800) 368-4636.



Error Messages

Whenever the printer detects an error condition, the  Error Indicator will either flash or go to a steady on condition. The indicator flashes for errors that can be easily corrected such as Check Paper or Paper Door Open.

The indicator will stay on without flashing for errors that cannot be recovered without loss of data. These are typically caused by interface configuration errors such as serial handshaking, or baud rate, and will require that the printer be turned off to clear the error.

Message	Possible Cause	Solution
Check Paper	Media supply is empty.	Install new roll.
	Paper/Black Mark sensor is dirty.	Clean the Black Mark sensor. Refer to “Cleaning” on page 39.
Paper Door Open	Paper door not fully closed.	Make sure the door is fully closed by opening the door and closing it again until the door “clicks” closed. Check the platen roller for damage.
Parity Error	Serial I/O not configured correctly.	Verify that the parity selection made in the Serial Interface Setup Menu matches the setting on the host system.
I/O Overflow	Serial I/O not configured correctly.	Verify that the handshaking selections (ETX/ACK, XON/XOFF, RTS/CTS) selections made in the Serial Interface Setup Menu match the settings on the host system.
I/O Error	Optional interface – IrDA, Bluetooth, or Wi-Fi not responding.	Try turning the printer off and on again. If the error repeats, the printer requires service.

Other Problems

Problem	Possible Cause	Solution
Printer will not turn on.	Battery not installed properly.	Remove and reinstall battery making sure the battery release lever “clicks” when fully installed.
	Discharged battery.	Recharge battery.
Printer turns itself off.	Auto Power Down is enabled.	Change setting in Options Menu as described on page 31.
	Battery discharged.	Replace or recharge battery.
	Electrostatic discharge.	May occur in extreme low humidity conditions. Turn printer back on with power button.
❑ Battery Indicator does not light or does not stay lit when power supply is connected.	Battery already fully charged.	No action required.
	Power supply not receiving power.	Check building/vehicle circuit breakers/fuses.
	Faulty power supply.	Check output of power supply with voltmeter. 9 VDC.
	Battery not installed properly.	Remove and reinstall battery making sure the battery release lever “clicks” when fully installed.
Battery not charging.	Faulty power supply or battery.	Refer to “Testing the Power Supply and Battery” on page 41.
Poor print quality.	Low battery.	Check and recharge battery.
	Print head dirty.	Clean print head. Refer to page 39.
	Poor quality or “old” paper.	Verify paper from approved source. Try new roll of paper.
Paper not feeding.	Obstruction in paper path or paper improperly installed.	Check paper path and reinstall paper.
	Poor quality paper.	Verify paper from approved source.
Paper not feeding reliably or print is compressed vertically	Poor quality paper.	Verify paper from approved source.
	Heavy or thick forms or labels. Specialty paper with slick finish.	Lower the Max Paper Speed as described on page 20.
Print Garbled.	Low Battery.	Check and recharge battery.
	Improper Serial interface configuration.	Verify printer and host settings match.
Printer will not print.	Low Battery.	Check and recharge battery.
	Paper not loaded correctly.	Check paper path and reinstall paper.
	Improper interface configuration.	Verify printer and host settings match. Use test print to verify printer setting and to verify printer is functioning properly.
Cannot print via optional interface,  Wireless Indicator does not light.	Interface not configured correctly.	With printer on, press and hold the  Enter Button to print out current configuration. Make sure the interface is selected and Make sure printer and host set ups match.

Obtaining Service

If service is required for your printer, please contact the company where you purchased your printer. If they are unable to assist you, contact Printek Customer Service at (800) 368-4636 to obtain the name of the nearest Printek Authorized Service Center.

If you wish to return your printer to Printek for service, please contact Printek Customer Service at (800) 368-4636 to obtain a Return Authorization Number. Units returned without a Return Authorization will not be accepted.

Advanced Setup Features

An additional security menu is available for system administrators who prefer to “lock out” operator changes to the various menus. This method of security can be set independently for the Format Menu, the Interface Menu, or the Options Menu.

When set to **Edit Allowed**, the user is allowed to make changes to any item in the menu specified. When set to **View**, the operator can review the settings, but cannot edit, or change, the values. When set to **Initialize**, the printer will reset all values in that menu and any associated submenus to the factory default values and security will be reset to **Edit Allowed**.

To be able to access the Security Menu, you must press and hold the **+** Increment Button rather than use the normal “hold the **↵** Enter Button during power on” method. Once Setup is entered, press the **▶** Advance Button to cycle through the menus until “**Security Menu**” is displayed. You may then press the **↵** Enter Button to advance through the items as listed below.

SECURITY MENU

Format Menu

Format Menu
Edit Allowed

Possible Values: **Edit Allowed***, **view only**, **Initialize**

This feature selects whether the items in the **Format Menu** can be edited, or only viewed by the operator. **Initialize** will reset all the features for all formats to factory default values.

Interface Menu

Interface Menu
Edit Allowed

Possible Values: **Edit Allowed***, **view only**, **Initialize**

This feature selects whether the items in the **Interface Menu** can be edited, or only viewed by the operator. **Initialize** will reset all the features for all interfaces to factory default values, including the optional Bluetooth and Wi-Fi interfaces.

Options Menu

Options Menu
Edit Allowed

Possible Values: **Edit Allowed***, **view only**, **Initialize**

This feature selects whether the items in the **Options Menu** can be edited, or only viewed by the operator. **Initialize** will reset all the options to factory default values.

Print & Font Samples

Print Samples

Sans Serif
5.5 cpi
012345 ABCDEF
abcdef

Sans Serif 10.2 cpi
012345 ABCDEF abcdef

Sans Serif 10.7 cpi
012345 ABCDEF abcdef

Courier 12.7 cpi
012345 ABCDEF abcdef

Courier 13.5 cpi
012345 ABCDEF abcdef

Courier 14.5 cpi
012345 ABCDEF abcdef

Courier 15.6 cpi
012345 ABCDEF abcdef

Courier 16.9 cpi
012345 ABCDEF abcdef

Courier 18.5 cpi
012345 ABCDEF abcdef

Courier 20.3 cpi
012345 ABCDEF abcdef

Courier 22.3 cpi
012345 ABCDEF abcdef

Courier 25.4 cpi
012345 ABCDEF abcdef

Courier 12.7 cpi

Courier 12.7 cpi Emphasized

Courier 12.7 cpi 2xHigh

Courier 12.7 cpi 2xHigh & Emphasized

Courier Font With International Extended Character Set

	0	1	2	3	4	5	6	7	8	9	A	B	C	D	E	F
2	!	"	#	\$	%	&	'	()	*	+	,	-	.	/	
3	Ø	1	2	3	4	5	6	7	8	9	:	;	<	=	>	?
4	@	A	B	C	D	E	F	G	H	I	J	K	L	M	N	O
5	P	Q	R	S	T	U	U	W	X	Y	Z	[\]	^	_
6	`	a	b	c	d	e	f	g	h	i	j	k	l	m	n	o
7	p	q	r	s	t	u	v	w	x	y	z	{		}	~	
8	ç	ü	é	â	ä	à	ã	ç	ê	ë	è	í	î	ì	ñ	ñ
9	è	æ	œ	ô	ö	ò	û	ù	ÿ	ö	Ü	ø	ε	Ø	×	f
A	á	í	ó	ú	ñ	Ñ	æ	ø	¿	↑	↓	½	¼	¡	«	»
B	Ş	ş	Ć	ċ	İ	ı	Ĥ	ĥ	Ħ	ħ	ı	ı	ı	ı	ı	ı
C	ϕ	ψ	α	γ	δ	ε	ä	ã	ç	η	θ	κ	λ	ξ	σ	ς
D	τ	ν	ê	ë	è	ψ	í	î	ï	ω	ó	é	ñ	á	ì	□
E	ó	β	ô	ò	ö	ö	μ	ρ	√	·	Ù	Ù	ϕ	ϕ	ú	ú
F	ƒ	±	θ	∞	Ω	Σ	π	f	♥	♦	♣	♠	÷			█

Courier Font PC Line Drawing Extended Character Set

	0	1	2	3	4	5	6	7	8	9	A	B	C	D	E	F
8	ç	ü	é	â	ä	à	ã	ç	ê	ë	è	í	î	ì	ñ	ñ
9	è	æ	œ	ô	ö	ò	û	ù	ÿ	ö	Ü	ø	ε	Ø	×	f
A	á	í	ó	ú	ñ	Ñ	æ	ø	¿	↑	↓	½	¼	¡	«	»
B	Ş	ş	Ć		†	‡	†	‡	†	‡	†	‡	†	‡	†	‡
C	⌞	⌞	⌞	⌞	⌞	⌞	⌞	⌞	⌞	⌞	⌞	⌞	⌞	⌞	⌞	⌞
D	⌞	⌞	⌞	⌞	⌞	⌞	⌞	⌞	⌞	⌞	⌞	⌞	⌞	⌞	⌞	⌞
E	ó	β	ô	ò	ö	ö	μ	ρ	√	·	Ù	Ù	ϕ	ϕ	ú	ú
F	ƒ	±	θ	∞	Ω	Σ	π	f	♥	♦	♣	♠	÷			█

Sans Serif Font

	0	1	2	3	4	5	6	7	8	9	A	B	C	D	E	F
2	!	"	#	\$	%	&	'	()	*	+	,	-	.	/	
3	0	1	2	3	4	5	6	7	8	9	:	;	<	=	>	?
4	@	A	B	C	D	E	F	G	H	I	J	K	L	M	N	O
5	P	Q	R	S	T	U	V	W	X	Y	Z	[\]	^	_
6	`	a	b	c	d	e	f	g	h	i	j	k	l	m	n	o
7	p	q	r	s	t	u	v	w	x	y	z	{		}	~	□
8	€	□	,	f	„	…	†	‡	^	%	Š	◁	œ	□	Ž	□
9	□	'	'	“	”	•	—	~	™	š	›	œ	□	ž	ÿ	
A	ı	¢	£	¤	¥	¦	§	¨	©	ª	«	¬	-	®	¯	
B	°	±	²	³	´	µ	¶	·	,	¹	º	»	¼	½	¾	¿
C	À	Á	Â	Ã	Ä	Å	Æ	Ç	È	É	Ê	Ë	Ì	Í	Î	Ï
D	Ð	Ñ	Ò	Ó	Ô	Õ	Ö	×	Ø	Ù	Ú	Û	Ü	Ý	Þ	ß
E	à	á	â	ã	ä	å	æ	ç	è	é	ê	ë	ì	í	î	ï
F	ò	ñ	ò	ó	ô	õ	ö	÷	ø	ù	ú	û	ü	ý	þ	

Specifications

Printer Specifications

Printing Specifications

Printing Method: Direct Thermal, Up To 3.3 Inches Per Second
Printing Resolution: 203 dots per inch (8 dots per mm)
Printing Width: 576 Printing Elements for up to 2.84" (7.21 cm)

Fonts/Characters/Bar codes

Fonts: A wide range of font types and sizes, from ~ 6 cpi to 34 cpi plus scaling depending on emulation chosen
International Characters: Arab-T, Arab-S, Arab-E, Asian fonts and an expanding catalog available for download
Bar Codes: Code 39, Code 128, UCC/EAN-128, UPC/EAN/JAN, Interleaved 2 of 5, CODABAR, EAN08 & 13, PDF-417, UPC
Downloads: Downloadable fonts, graphics, and logos

Connectivity

Serial: RS-232C (Standard)
Wireless: IrDA, Bluetooth, Wi-Fi, Custom RF (Options)
Emulations: Printek, Printek Mt3, O'Neil, ZPL-II, CPCL
Software Available: Drivers for Windows 98/2000/XP
Print Utilities for Pocket PC and Palm OS
SDK's for Pocket PC and Palm OS
MtP Setup Remote Configuration Utility for Windows 98/2000/XP

Data Input

Magnetic Card Reader: 3 Track, Simultaneous Read (Option)

Power Management

Battery: 7.4 V, 2200mAH rechargeable 2 cell Lithium Ion
Endurance: 500 pages or more than 2000 inches of print per charge
Internal Charging: 2½ hours (requires optional power supply)
Battery Free Operation: Printer may be used with optional external power supply, with or without battery

Specifications

Physical Specifications

Size: 6.5 x 5.3 x 3.1 inches, 19.56 x 16.76 x 7.87 cm (LxWxH)
Weight: 1.96 lbs. (0.89 kg) with battery

Environmental Specifications

Operating Temp: 10° to 122°F (-12° to 50°C)
Storage Temp: -4° to 140°F (-20° to 60°C)
Humidity: 10% to 90% RH (non-condensing)
Rating: IP54 per IEC 529, without optional environmental case

Operator Controls and Indicators

Display: 2 line x 16 character LCD
Indicators: Power, Wireless Connection, Magnetic Card Reader Ready, Battery Status, Fault
Controls: Power, Paper Feed, and two Configuration Buttons
Sensors: Paper, Paper Door Open, Black Mark Detection, and Label Gap Detection (LP Models Only)

Memory Capacity

Flash: 1MB Program Memory; 1MB Font, Logo and Graphic Storage
RAM: 1MB
EEPROM: For Nonvolatile Configuration Storage

Durability and Reliability

Drop Test: Survives multiple 4 foot drops to concrete (each face), conforms to IEC 68-2
MTBF: 10,000 hours @100% duty cycle in normal use

Regulatory Approvals

Approvals/Markings: FCC Class B
CE Mark
UL listed AC adapters
E-mark on In-Vehicle adapters

Warranty

Printer: One year including print head and battery.

Media Specifications

Receipt Paper

General Specifications: 0.0022 to 0.0065" (0.056 to 0.089mm) Thick
Black Mark Sensing On Printed Side
2.00 to 3.12" (50.8 to 79.25mm) Wide
0.750" (19.05mm) Inside Diameter Core
2.625" (66.68mm) Maximum Outside Diameter
(Black Mark Sensing On Back Side and Gap Sensing On MtP300 LP Models)

Approved Vendors: Kansaki: P300, P310, P350, P354, P390*, P530UV, TO281CA,
OP200, TO381N, F180, F380, F550
Jujo: TF-50KS-E2C
Honshu: FH65BV-3
*Standard Printek Offering

Labels

MtP300: 0.0022 to 0.0065" (0.056 to 0.089mm) Thick
0.750" Inside Diameter Core
Black Mark Sensing On Printed Side
2.625" Maximum Outside Diameter
3.12" Maximum Width (carrier)

MtP300 LP: 0.0022 to 0.0065" (0.056 to 0.089mm) Thick
0.750" Inside Diameter Core
Black Mark Sensing On Printed Side Or Back Side
Gap Sensing Between Labels
2.625" Maximum Outside Diameter
3.12" Maximum Width (carrier)

Specifications

Black Mark Position

The vertical position of a Black Mark is dependent on the application program that will be used to search for and print relative to the mark. The following diagram shows the optimum position when seeking the Black Mark at the beginning of a print job and will require little, if any, reverse paper motion.

The Black Mark must be printed on the front side of the paper for the MtP300. It may optionally be printed on the back side of the paper for use with the MtP300 LP models

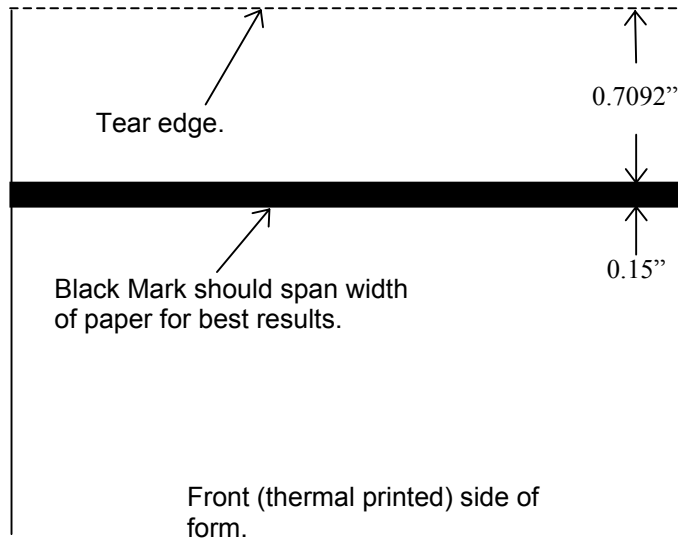

Figure 13 - Black Mark Position

Gap Sensing Specifications

Gap Sensing is only available for MtP300 LP models. The minimum gap between labels is 0.125" (3.2mm).

Supplies and Accessories

Supplies

- Battery: 7.4V, 2200 mAH Li-Ion
Available separately or in 5 or 20 packs.
- Receipt Paper: 3.12" Width *
Available in cases of 36.
- Labels: 2 x 1.25", 3 x 1.75", or 2.9375 x 4.9275" *
Available in cases of 36.

* Other sizes available on request.

Accessories

- Power Supplies: 100-240VAC/50-60Hz Wall Adapter
12/24VDC Vehicle Adapter
- Battery Charger: Four Bay Fast Charger
- Carrying Options: Shoulder Strap
- Cables: Serial RJ to DB-9F
Serial RJ to Pigtail

Glossary of Terms

802.11	Wireless networking communication standards created by IEEE.
access point	An interface between a wireless network and a wired network.
Ad-Hoc	A Wi-Fi network consisting of only stations (no access point). Same as Peer-to-Peer.
ASCII	American Standard Code for Information Interchange.
authentication	The process a Wi-Fi station uses to identify itself to another station.
bandwidth	The amount of data that be transferred in a given period of time.
baud rate	The rate at which characters are transmitted over a serial interface. This is also often referred to as bits per second.
binary	Base two numbering system. Digits are represented by the characters 0 and 1.
bit	A single binary digit.
Bluetooth	A definition for short range radio frequency communications.
client	Any node on a network that requests services from another node (server).
control code	A single, non-printing character which is used to control the configuration or operation of the printer.
character pitch	The horizontal spacing of characters. Measured in cpi.
cpi	Characters per inch.
current line	The line upon which the next character will be printed.
current print position	The column on the current line where the next character will be printed.
default	Value or configuration assumed when the printer is powered on or reset.
DHCP	Dynamic Host Configuration Protocol. A method used to centrally control the assignment of IP addresses on a network.
dpi	Dots per inch. Generally used to refer to graphics density or resolution.
escape sequence	String of characters beginning with the escape (ESC) character which is used to control the configuration or operation of the printer. The characters which are part of this string are not printed.
font	A group of characters of a given shape or style.
hexadecimal	Base sixteen numbering system. Digits are represented by the characters 0 through 9 and a through f.
IEEE	Institute of Electrical and Electronic Engineers
infrastructure	A Wi-Fi network consisting of stations connecting to a wired network or other stations via an access point.
interface	The connection between the printer and the host computer.

Glossary

IP	Internet Protocol. A specification for packets, or datagrams, of data and an addressing method to allow the exchange of data with another system. Must be combined with another protocol such as TCP to create a complete connection with the other system.
LAN	Local Area Network.
LCD	Liquid crystal display.
LED	Light emitting diode.
line pitch	The vertical spacing of rows of characters. Measured in lpi.
lpi	Lines per inch.
margin	An area along any edge of a form where data may not be printed.
MSB	Most significant bit. In a character, this refers to bit seven (of 0 to 7).
node	Any device connected to a network.
parity	A method used for detecting errors within a single character transmitted or received via an interface.
Peer-to-Peer	A network consisting of only stations (no access point or central server). Same as Ad-Hoc.
reset	Initialization of various operating parameters of the printer to the value or state assumed when the printer is powered on.
RS-232C	An EIA standard for serial data transmission.
server	Any node on a network that provides services to another node (client).
SSID	Service Set Identifier. An identifier attached to packets on a Wi-Fi network that identify the particular network the packets are intended for.
TCP	Transmission Control Protocol. A specification that controls the connection between systems on a network.
top of form	The vertical position where the first line is printed on the paper. Also the position the paper is advanced to when a form feed (FF) character is received from the host or the Form Feed button is pressed on the printer's control panel.
WAN	Wide Area Network. Refers to connections that allow one LAN to communicate with another LAN(s).
WEP	Wired Equivalent Privacy. A security protocol for wireless LANs designed to provide data security similar to a wired LAN.
Wi-Fi	Refers to any of the IEEE 802.11 standards.
WLAN	Wireless Local Area Network. A LAN made up of wireless nodes.

Free Manuals Download Website

<http://myh66.com>

<http://usermanuals.us>

<http://www.somanuals.com>

<http://www.4manuals.cc>

<http://www.manual-lib.com>

<http://www.404manual.com>

<http://www.luxmanual.com>

<http://aubethermostatmanual.com>

Golf course search by state

<http://golfingnear.com>

Email search by domain

<http://emailbydomain.com>

Auto manuals search

<http://auto.somanuals.com>

TV manuals search

<http://tv.somanuals.com>