



PRINTEKMOBILE™

FieldPro RT43 Series

Operator's Manual

Printek, Inc.
1517 Townline Road
Benton Harbor, MI 49022
269-925-3200
www.printek.com

Printek Part Number 6360 Rev. B

FCC Part 15 Class B

This device complies with Part 15 of the FCC Rules. Operation is subject to the following two conditions: (1) this device may not cause harmful interference, and (2) this device must accept any interference received, including interference that may cause undesired operation.

This equipment has been tested and found to comply with the limits for a Class B digital device, pursuant to Part 15 of the FCC rules. These limits are designed to provide reasonable protection against harmful interference in a residential installation. This equipment generates, uses and can radiate radio frequency energy and, if not installed and used in accordance with the instructions, may cause harmful interference to radio communications. However, there is no guarantee that interference will not occur in a particular installation. If this equipment does cause harmful interference to radio or television reception, which can be determined by turning the equipment off and on, the user is encouraged to try to correct the interference by one or more of the following measures:

- Reorient or relocate the receiving antenna.
- Increase the separation between the equipment and the receiver.
- Connect the equipment into an outlet on a circuit different from that to which the receiver is connected.
- Consult the dealer or an experienced radio/TV technician for help.

This equipment complies with Canadian and FCC radiation exposure limits set forth for an uncontrolled environment. This equipment is in direct contact with the body of the user under normal operating conditions. This transmitter must not be co-located or operating in conjunction with any other antenna or transmitter.

Part 15.21 Caution: Changes or modifications not expressly approved by Printek, Inc. could void the user's authority to operate the equipment.

Bluetooth Equipped Models:

For units equipped with an OEM Serial Port Adapter from connectBlue, reference FCC ID: PVH070101. For units equipped with a Printek, Inc. Bluetooth module, reference FCC ID: B9J-0213900444.

Wi-Fi Equipped Models:

This equipment contains an OEM Wireless LAN Node Module from DPAC Technologies with FCC ID: RTTABDB-SEDP. This device has shown compliance with the conducted emissions limits in 15.107, 15.207, or 18.307 adopted under FCC 02-157 (ET Docket 98-80).

Battery Disposal

Only dispose of used batteries according to your local regulations. If you do not know your local regulations, the Rechargeable Battery Recycling Corporation (RBRC) is a non-profit organization created to promote recycling of rechargeable batteries. For more information visit www.rbrc.org.



Acknowledgments:

Printek is a registered trademark of Printek, Inc.

Bluetooth is registered trademark of Bluetooth SIG, Inc.
O'Neil is a trademark of O'Neil Product Development, Inc.
Zebra and ZPL-II are registered trademarks of Zebra Technologies
Palm OS is a trademark of PalmSource, Inc.
PrintBoy is a registered trademark of Bachmann Software
PrinterCE is a registered trademark of Fieldsoftware Products
Wi-Fi is a registered trademark of the Wi-Fi Alliance
Windows is a registered trademark of Microsoft Corporation
All other trademarks are the property of their respective owners.

© 2004 By Printek, Inc., 1517 Townline Road, Benton Harbor, MI 49022. All rights reserved.

This manual is based on printer firmware version 3.2. Specifications are subject to change without notice.



Read all setup and operating instructions before proceeding with operation.

Do not operate in an enclosure unless properly ventilated. Make sure no ventilation openings are blocked or obstructed, which may result in the printer overheating.

Do not operate near a heat source.



Lesen Sie vor der Inbetriebnahme die Aufbau- und Bedienungsanleitung.

Betreiben Sie den Drucker nicht in einem kleinen, geschlossenen Raum, es sei denn dieser wird ordnungsgemäß belüftet. Achten Sie darauf, dass die Lüftungen nicht blockiert oder versperrt sind, denn dies kann zum Überhitzen des Druckers führen.

Nehmen Sie den Drucker nicht in der Nähe einer Wärmequelle in Betrieb.



No user-serviceable parts inside. Refer service or repairs to a qualified service professional.

Use of genuine Printek replacement parts is required to warrant proper, safe operation.

Any alteration or modification of this device voids the user warranty and may make the product unsafe to operate.

The print head and motors get hot during use. Wait until they cool before touching them.

Make certain the printer is disconnected from AC power before removing any covers or performing any required cleaning or maintenance.

Connecting this printer to an ungrounded receptacle can result in electrical shock.

Never place the printer near inflammable or explosive substances. Do not operate near liquid or spill liquid into the printer at any time.



Enthält keine Teile, die vom Bediener instandgesetzt werden können. Bitte wenden Sie sich bei Instandsetzung oder Reparatur an qualifiziertes Kundendienstpersonal.

Die Verwendung von echten Printek Ersatzteilen ist notwendig, um ordnungsgemäßen, sicheren Betrieb zu gewährleisten.

Änderungen oder Modifikationen dieses Geräts machen die Garantie ungültig und können den sicheren Betrieb des Produkts gefährden.

Während des Druckens werden Druckerkopf und Motoren heiß. Warten Sie, bis sich die Teile abgekühlt haben, bevor Sie sie berühren.

Vergewissern Sie sich, dass der Drucker nicht mehr an die Stromquelle angeschlossen ist, bevor Sie Abdeckungen abnehmen oder das Gerät reinigen bzw. warten.

Schließen Sie diesen Drucker nicht an eine ungeerdete Steckdose an; dies kann zum Elektroschock führen.

Setzen Sie den Drucker niemals in die Nähe von feuer- oder explosionsgefährlichen Stoffen. Betreiben Sie den Drucker nicht in der Nähe von Flüssigkeiten und lassen Sie keine Flüssigkeiten in den Drucker gelangen.

TABLE OF CONTENTS

Introduction	1
Getting Started	3
Printer Features	3
Battery Installation and Charging	3
Installing Media	5
Turning the Printer On and Off	6
Performing A Printer Self Test	6
Removing Printer Output	7
Host Interface Set Up	7
Using The Carrying Strap	8
Daily Operation	9
Introduction	9
Control Panel	9
Battery Charging	11
Using the Magnetic Card Reader	12
Printer Configuration	13
Introduction	13
Setup Menu Summary	13
Interface Menu	15
Serial Interface	16
Bluetooth Interface	17
Wi-Fi Interface	18
Format Menu	21
Print All Logos In Memory	23
Options Menu	23
Hardware Menu	25
Control Panel Setup	25
Entering Setup	25
Using Setup	26
Exiting Setup	26
Interfacing To A Host Computer	27
Serial Interface	27
Bluetooth® Interface	28
Wi-Fi® Interface	29
Power Considerations	31
Standby Operation	31
Auto Power Down	31
Operation Without A Battery	31
Maintenance and Troubleshooting	33
Cleaning	33
Battery Care	34
Charging the Battery	34
Additional Battery and Safety Information	34
Testing the Power Supply and Battery	35
Troubleshooting	36
Error Conditions	36
Other Problems	36
Obtaining Service	37

Table of Contents

Print & Font Samples	39
Specifications	43
Printer Specifications.....	43
Media Specifications.....	45
Supplies and Accessories.....	46
Glossary of Terms	47

Introduction

Thank you for purchasing a Printek FieldPro RT43 Series mobile thermal printer. The FieldPro series offers a variety of configurations to suit any printing environment.

The RT43 prints on receipt paper supplied in roll form up to 4.125 inches wide and includes “black mark” sensing capabilities on the printed side of the media. All models are equipped with a “Universal Port” which supports cabled, serial communications using an optional RS-232C or USB cable. All models also support an optional internal Bluetooth or Wi-Fi interface.

Each printer is shipped with a battery, a carrying strap, a Quick Start Guide, and one roll of receipt paper.

This manual has been written for systems administrators and end users and contains information needed for the set up and everyday use of the printer. It also contains information regarding preventative maintenance and how to obtain service if needed.

The information in this manual is arranged in the following sections:

Getting Started contains the minimum steps required to get the printer set up and able to communicate with your host system.

Daily Operation describes additional activities that are likely to be encountered under normal operation.

Printer Configuration contains detailed information on all the features available in the Setup menus.

Interfacing To A Host Computer provides basic information related to connecting the printer to a computer via a cabled serial connection or the optional Bluetooth or Wi-Fi interfaces.

Power Considerations provides information regarding operation on the internal battery or from an external supply.

Maintenance and Troubleshooting contains information on how to care for your printer to keep it working at peak performance. This section also includes a list of printer error conditions and suggestions on how to solve problems.

Print & Font Samples offers examples of printed output and character mapping for standard fonts.

Specifications provides detailed information regarding performance, media specifications, and options available for your FieldPro series printer.

Glossary of Terms is a reference for terminology used within this manual and in the computer and printer industry.

Getting Started

Printer Features

Before preparing your new FieldPro RT43 for use, please refer to Figure 1 and familiarize yourself with the locations of the various features of the printer.

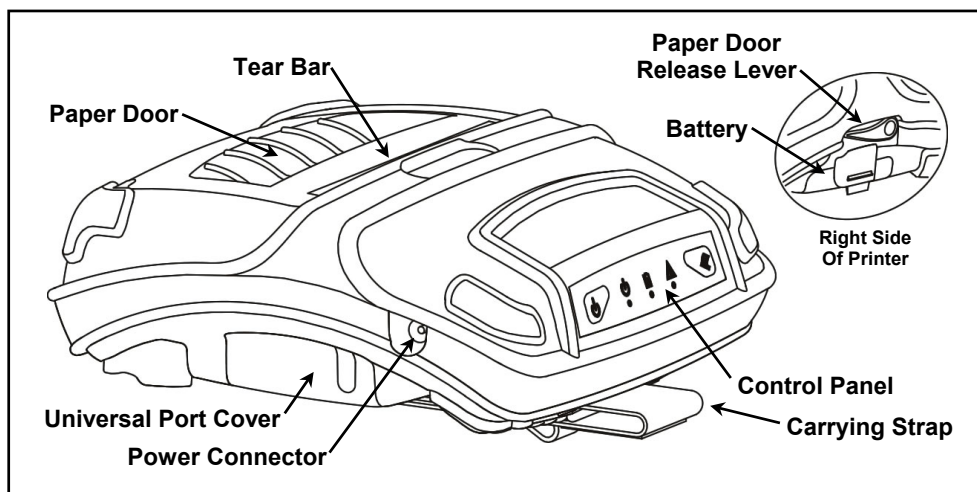

Figure 1 - Printer Features

Battery Installation and Charging

The battery for your FieldPro printer is shipped in an “uncharged” state. The battery must be charged using the following instructions prior to using the printer for the first time. Maximum battery capacity is not reached until after completing a minimum of three complete charge and discharge cycles.

Please refer to Figure 2. Install the battery by first placing the end of the battery where the battery contacts are located into the printer, and then press down on the end where the release lever is located until the lever “snaps” into place.

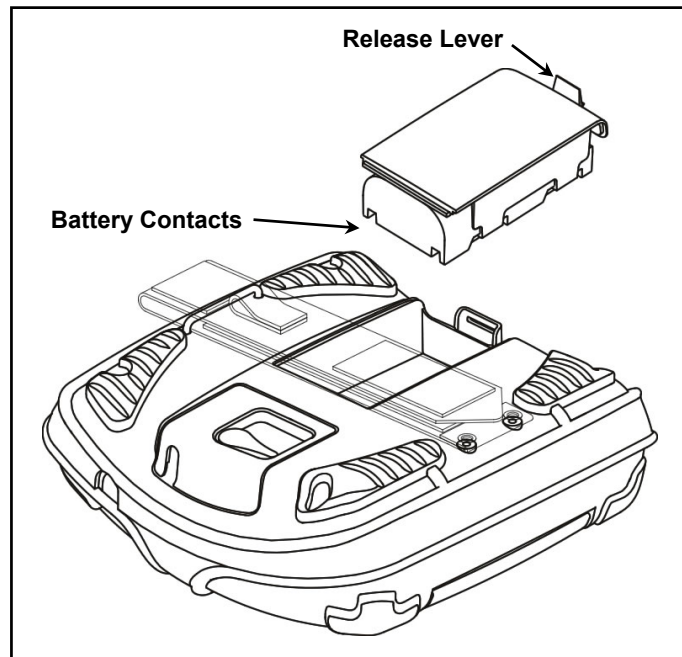

Figure 2 - Battery Installation

To charge the battery, connect an optional power supply to the appropriate input source, and then connect the output of the power supply to the printer's Power Connector at the location shown in Figure 3. The Battery Indicator will turn on and remain on until the battery is fully charged. This may take up to 2½ hours.

Note: You must charge the battery for at least 2½ hours prior to the first use.

Caution: Use only Printek power supplies designed specifically for your FieldPro printer. Using a different power supply may cause damage to the printer and will not be covered by the printer's warranty. Printek power supplies are available for use with 100-240VAC/50-60Hz and for 12/24VDC vehicle applications.

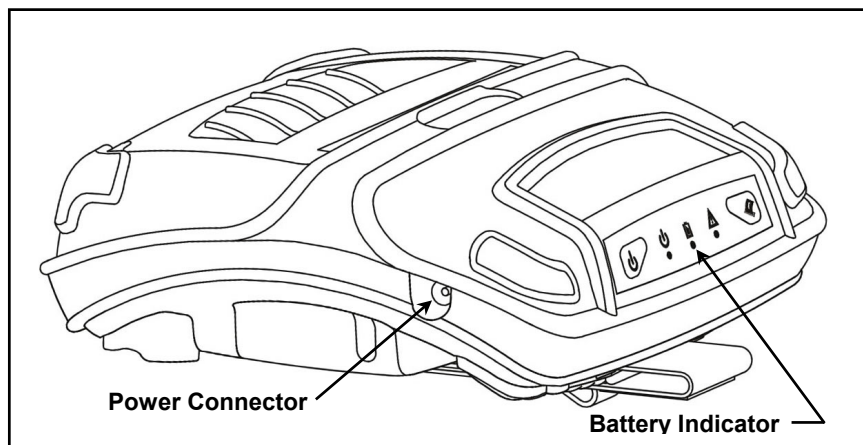

Figure 3 - Power Connector & Battery Indicator

Installing Media

Each printer comes supplied with a roll of receipt paper.

Note: For maximum performance and optimum print quality, use only genuine Printek media in your FieldPro printer.

To install media, you must release the paper door by moving the Paper Door Release Lever in the direction shown in Figure 4 and then lift the paper door to expose the paper compartment.

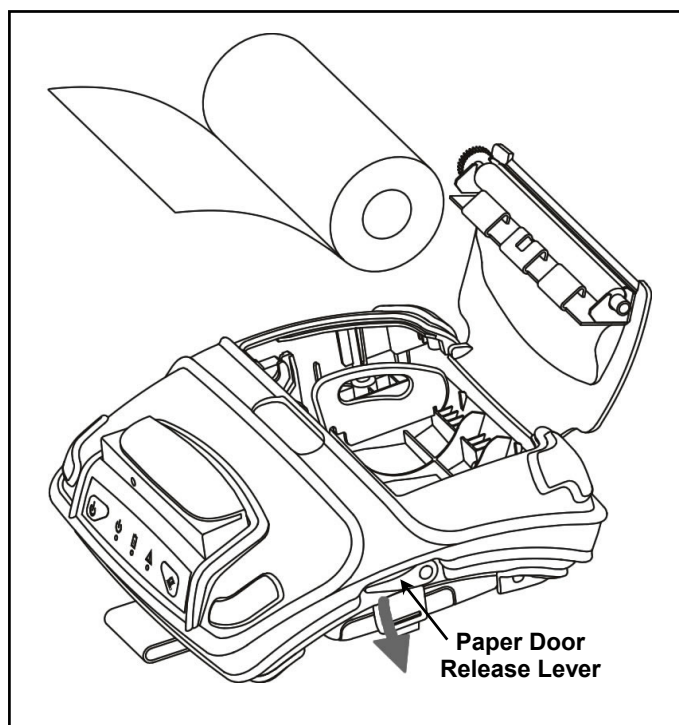

Figure 4 - Opening Paper Door

Unroll a small portion of the paper as shown, place the roll into the printer, and close the Paper Door. If the printer is turned on, you may now press the Paper Feed Button to advance the paper and then tear it off in preparation for printing.

Note: If you need to use a paper width other than what was supplied with your printer, please refer to Media Specifications in the Specifications section of this manual.

Turning the Printer On and Off

Refer to Figure 5 and locate the printer's Power Button. To turn the printer on, simply press and release the Power Button. To turn the printer off, press and hold the Power Button. The printer will "beep" and then power down after the button is released.

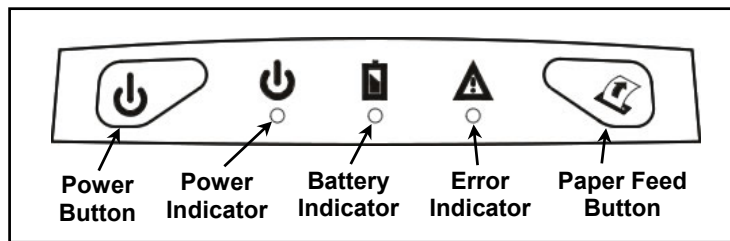

Figure 5 - Printer Control Panel

Performing A Printer Self Test

To perform a self test, press and hold the Paper Feed Button while turning on the printer with the Power Button. The printer will print a test page with the following information:

- The printer's firmware revision level and release date.
- Printer serial number.
- The current values for items in the Format menu.
- The current values for items in the Options menu.
- The type of optional interface, if installed, and which interface is currently selected.
- The presence of the optional Magnetic Card Reader, if installed.
- The current battery voltage.
- A list of additional fonts, if installed.
- A list of logos, if installed.
- A print head test pattern.

Note: At the bottom of the test page the message "Press Feed For Setup Menu" will be printed. Do not press any buttons at this time. After approximately four seconds, "Setup Not Requested" will be printed and the printer is ready for normal use.

The internal setup menus allow changes to be made to the printer's interface and printing features. Improper changes may make your printer perform poorly or not at all. These menus should only be used under the direction of your technical support staff. For more information, please refer to the Printer Configuration section on page 13 of this manual.

Removing Printer Output

To tear the paper, pull the paper against the tear bar (a sharp edge on the paper door) at a slight angle as shown in Figure 6, and then continue to pull the paper in the direction shown to tear it off.

If all the printing is not yet out of the printer and the host has finished sending data to the printer, the paper may be positioned for tearing by simply pressing the Paper Feed Button.

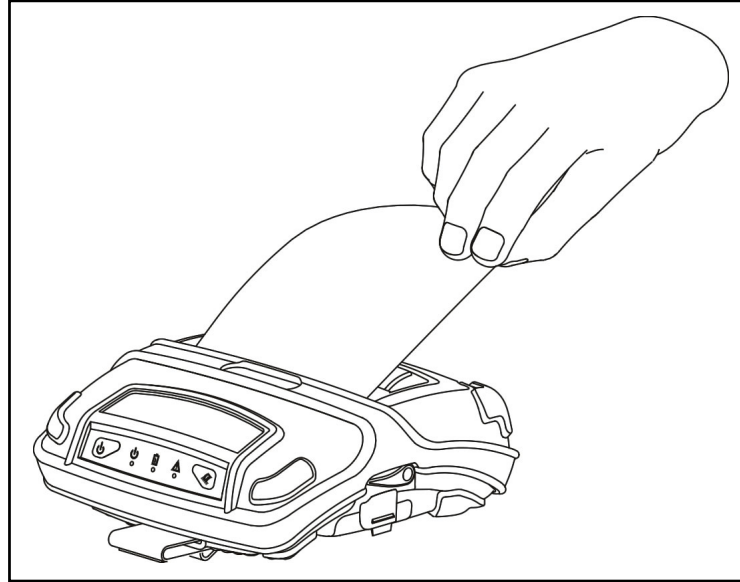

Figure 6 - Tearing Off Printer Output

Host Interface Set Up

Prior to using your printer with a computer application, the printer's interface settings must match those required by your host system.

Each printer is equipped with a Serial interface which may be used as either RS-232C or USB depending on which optional cable is attached to the printer. Additionally, the printer may also be equipped with either a Bluetooth interface or Wi-Fi interface. The model description on the serial number label will indicate if one of the optional interfaces is installed. The factory defaults for the basic settings for each interface are listed below.

Interface	Factory Default Interface Settings
Serial	Printek Emulation, 57,600 Baud, 8 Data Bits, 1 Stop Bit, No Parity, RTS/CTS Handshaking
Bluetooth	Printek Emulation, Pairing Mode = Paired, Security Disabled, PIN = "0", Bluetooth Name = "FP-SerialNumber".
Wi-Fi	Printek Emulation, Connect to any SSID, Infrastructure, WEP = None, DHCP enabled, TCP tunnel port 8023, Channel = 1, DHCP Name = "FP-SerialNumber".

If the above settings do not sufficiently match your host system requirements, please refer to the Printer Configuration and the Interfacing To A Host Computer sections of this manual.

Using The Carrying Strap

The printer's flexible carrying strap with multiple hook-and-loop fasteners is designed to be used in a variety of ways to carry or mount the printer. The most common use will be to hang the printer from a belt or from the optional shoulder strap as shown in Figure 7. To use the strap in this way, simply pull the end of the strap from the bottom of the printer, route it around the back side of your belt and fasten the strap back on itself as shown. You may also use this method with the Shoulder Strap or keep the Carrying Strap in its original position.

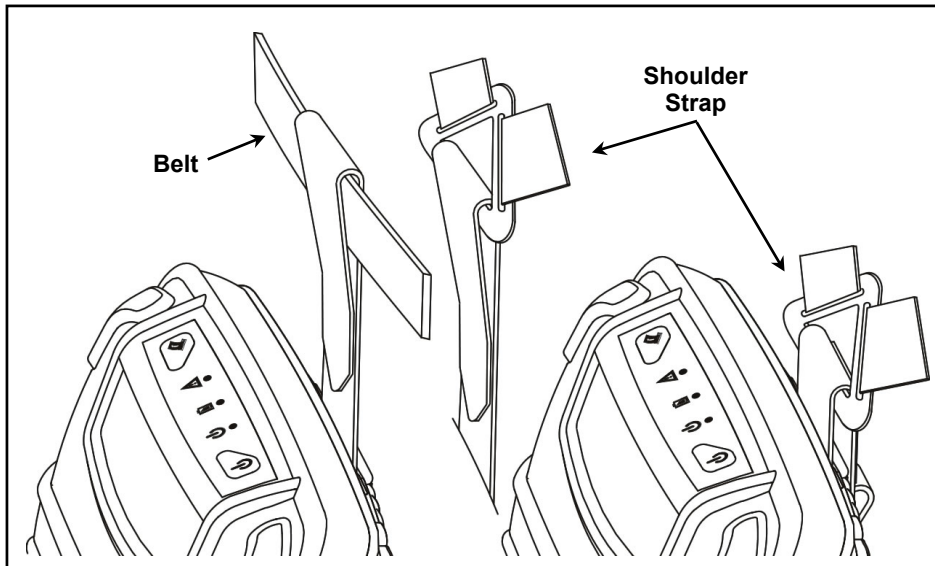

Figure 7 - Carrying Strap on Belt or Shoulder Strap

Daily Operation

Introduction

For normal daily use, most users will only need to turn the printer on and off, tear off printed output, load paper, and charge the battery as described in the Getting Started section of this manual. This section of the manual provides additional detail regarding the printer's control panel and for recharging the battery. Use of the optional Magnetic Card Reader is also described.

Control Panel

The FieldPro series printers are designed for simple operation with an easy to use control panel. As shown in Figure 8, the control panel consists of three indicators and two pushbuttons. An audible tone is also used to indicate button presses and certain error conditions.

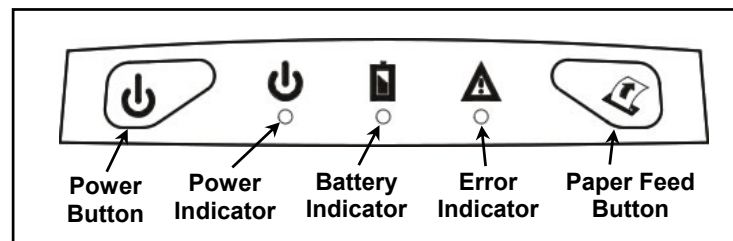



















Figure 8 - Control Panel

The purpose and functionality of all of the buttons and indicators are described in Figure 9.

Symbol	Function	Status
	Power Button	Used to turn the printer on or off.
	Paper Feed Button	Advances paper a preset distance or to the next black mark. Also used to clear paper error conditions.
	Power Indicator	 Printer is Off.
		 Printer is On.
		 Printer is in Standby. (Will wake on receipt of data.)
		 Printer is receiving data and/or printing, or is in the Control Panel Setup mode.
	Battery Indicator	 Battery is fully charged.
		 or  Battery needs to be charged.
		 Battery is being charged.
	Error Indicator	 No error.
		 With Alarm Paper out. (Load paper and press Paper Feed to clear.)
		 Paper Door is open.
		 With Alarm Communications error. (Power off to clear.)

○ = On ● = Off ✖ = Slow Blink ⚡ = Rapid Flash

Figure 9 - Control Panel Buttons & Indicators

Battery Charging

The FieldPro RT43 contains battery monitoring and charging circuitry so that the battery may be charged while in the printer. Charging the battery in the printer requires an optional power supply. Printek offers power supplies for use with 100-240VAC/50-60Hz and 12/24VDC for vehicle applications.

The printer's Battery Indicator flashes whenever the battery needs recharging.

To charge the battery, connect the power supply to the appropriate source, and connect the output of the supply to the printer's power connector shown in Figure 10.

Caution: Use only Printek power supplies to power your printer and charge batteries. Other power supplies may damage the electronics and printing mechanism. Damage caused by use of a non-Printek power supply will not be covered by the printer's warranty.

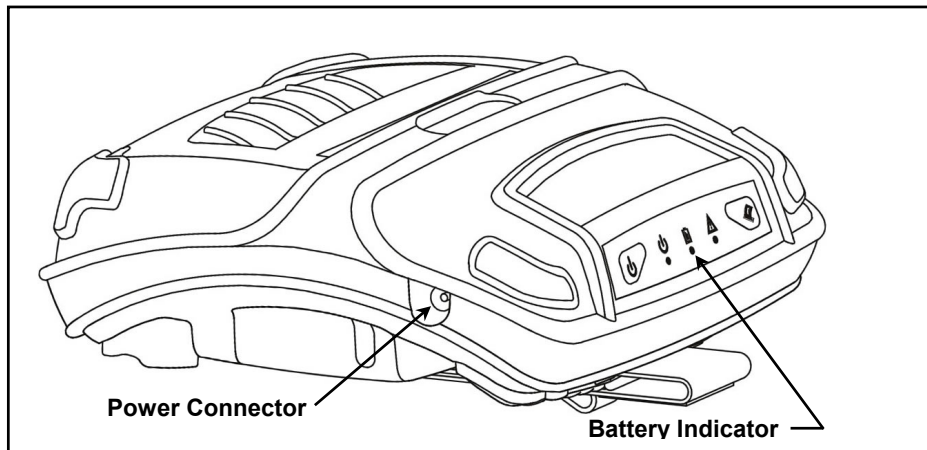

Figure 10 - Power Connector & Battery Indicator

When the power supply is connected, the printer's charging circuitry will determine if the battery currently requires charging and if so, will turn on the Battery Indicator until the battery has reached sufficient charge. Depending on the condition of the battery, charging may take up to 2½ hours to complete. When fully charged, the Battery Indicator will turn off.

Leaving the power supply connected to the printer will cause the printer to continuously monitor the condition of the battery and keep the battery charged.

For more information regarding battery charging, battery life, and battery disposal, refer to "Battery Care" on page 34.

Using the Magnetic Card Reader

The optional Magnetic Card Reader (MCR) may be used by some applications to read information from credit cards, drivers licenses, etc.

When the host system sends a request to the printer to enable the Magnetic Card Reader, the MCR Indicator will light to indicate that the card may now be passed through the MCR slot, or “swiped”. Refer to Figure 11 for the card orientation.

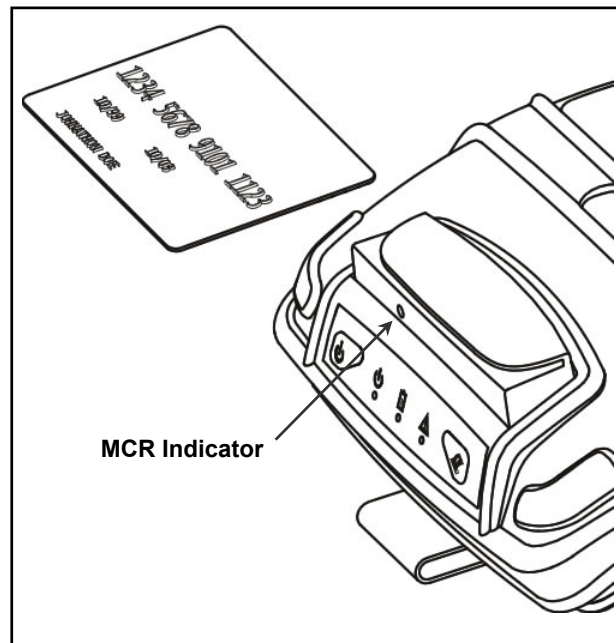

Figure 11 - Using The Magnetic Card Reader

If the card is read successfully, a short beep will sound and the MCR Indicator will turn off to indicate success as the data is sent to the host system.

If the card is not read successfully, a longer error tone will sound, the Error Indicator will light momentarily and the reader will be re-enabled to allow the card to be swiped again to attempt a successful read.

The length of time allowed before the timeout occurs is specified by the host application program. Once a timeout occurs, the Error Indicator will turn on momentarily and the reader will be disabled.

Printer Configuration

Introduction

This section describes printer operating features that may be configured to allow FieldPro series printers to communicate and operate with your computer and applications. These features are grouped into logical groupings as “menus”.

Two methods are available to change the configuration features of the printer. The preferred method is to use the Printek Mobile Setup Utility, a Windows® based program which may be downloaded from a Printek web site. The other is to use the built in Control Panel Setup which is described on page 25. Depending on what feature needs to be changed, you may need to use either one, or both, of these methods.

The tables below list the features available in each setup menu. Which setup method may be used to change the values of these features is indicated by a checkmark. Items marked with an asterisk (*) for one of the setup methods will have some restrictions on the values that may be set using that method. Following the tables are detailed descriptions of each setup feature.

Setup Menu Summary

INTERFACE MENU – All Interfaces

Menu Item	Values	Default Value	Modify From	
			Control Panel	Setup Utility
Switch to Serial Interface	Press Power to switch.	n/a	✓	
Switch to Bluetooth Interface (If installed)	Press Power to switch.	n/a	✓	
Switch to Wi-Fi Interface (if installed)	Press Power to switch.	n/a	✓	
Print Interface Settings	n/a	n/a	✓	

INTERFACE MENU – Serial Selected

Menu Item	Values	Default Value	Modify From	
			Control Panel	Setup Utility
Emulation	Printek, O’Neil, ZPL-II, Mt3, CPCL	Printek	✓	✓
Baud Rate	9600, 19200, 38400, 57600	57600	✓	✓
Data Bits	7, 8	8	✓	✓
Stop Bits	1, 2	1	✓	✓
Parity	None, Even, Odd	None	✓	✓
XON/XOFF	On, Off	Off	✓	✓
ETX/ACK	On, Off	Off	✓	✓
RTS/CTS	On, Off	On	✓	✓

Printer Configuration

INTERFACE MENU – Bluetooth Selected

Menu Item	Values	Default Value	Modify From	
			Control Panel	Setup Utility
Emulation	Printek, O'Neil, ZPL-II, Mt3, CPCL	Printek	✓	✓
Paired Mode	Paired, Unpaired	Paired	✓	✓
Role Policy	Defer, Master	Defer	✓	✓
Discoverability	On, Off	On	✓	✓
Pin	Up to 16 Numeric Characters	0		✓
Security	On, Off	Off	✓	✓
Local Name	Up to 16 Alphanumeric Characters	FP-Serial #		✓

INTERFACE MENU – Wi-Fi Selected

Menu Item	Values	Default Value	Modify From	
			Control Panel	Setup Utility
Emulation	Printek, O'Neil, ZPL-II, Mt3, CPCL	Printek	✓	✓
WLAN Type	Peer-to-Peer, Infrastructure	Infrastructure	✓*	✓
WLAN Channel	1 to 14	1		✓
WLAN SSID		any		✓
WLAN WEP Bits	0, 64, 128	0		✓
WEP Key 1-4	10 or 26 Char. Hex String	(Blank)		✓
WLAN Auth	Auto, Open, Shared	Auto		✓
IP Address Assign	DHCP, Static	DHCP		✓
IP Address		0.0.0.0		✓
IP Subnet Mask		0.0.0.0		✓
IP Gateway		0.0.0.0		✓
Tunnel Port		8023		✓

FORMAT MENU

Menu Item	Values	Default Value	Modify From	
			Control Panel	Setup Utility
Font	SansSerifA at 4.2, 5.5, 10.2, 10.7, 18.5, 20.3 cpi; Courier at 12.7, 13.5, 14.5, 15.6, 16.9, 18.5, 20.3, 22.6, 25.4 cpi; or Downloaded fonts if present.	16.9 Courier	✓	✓
Spacing	0 to 10 Dot Rows	3		✓
Left Margin	0 to 1.0244"	0	✓	✓
Right Margin	0 to 1.0244"	0	✓	✓
Print Contrast	-35% to 35%	0%	✓	✓
Max Paper Speed	0.32, 1.36, 1.92, 2.35, 2.72, 2.81 ips	2.81 ips	✓	✓
FFeed Distance	0 to 2.5216", Mark Sensing	1.26"	✓	✓
Mark Sensitivity	-10 to +10	0	✓	✓
Tearbar Adjust	-0.295 to 0.315"	0.000"	✓	✓
Top of Form Adjust	-0.295 to 0.295"	0.000"	✓	✓

PRINT ALL LOGOS IN MEMORY

Menu Item	Values	Default Value	Modify From	
			Control Panel	Setup Utility
Print All Logos in Memory	n/a	n/a	✓*	

OPTIONS MENU

Menu Item	Values	Default Value	Modify From	
			Control Panel	Setup Utility
Left Paper Guide Adjust	A – G	A	✓	✓
Right Paper Guide Adjust	None, 1 – 9	None	✓	✓
Auto Power Down	Off, 1 – 15 Minutes	Off	✓	✓
Print Promo	Off, On	Off	✓	✓
Print Header	Off, On	Off	✓	✓

HARDWARE MENU

Menu Item	Values	Default Value	Modify From	
			Control Panel	Setup Utility
Enter Hex Dump Mode	Off, On	Off	✓	
Burnin Mode	Off, On	Off	✓	
Reset to Factory Defaults	Hold Power 10 Sec.	n/a	✓	✓

Interface Menu

The Interface Menu is actually a series of menus. These menus are used to match the printer to the host system or device that will be used to send and/or receive data to/from the printer. Which Interface Menu affects the printer is dependent upon whether an optional Bluetooth or Wi-Fi interface is installed, and if so, which interface is currently selected as the active interface. Switching the active interface from one interface to the other is only available through Control Panel Setup and is described on page 25. The menu features for the Serial, Bluetooth, and Wi-Fi interfaces are described below.

Note: When using Control Panel Setup, you may select “Print Interface Settings” to obtain all the features and their values for the currently selected interface.

Serial Interface

The following Serial Interface Menu features are only available and/or only take affect when the Serial Interface is currently selected as the active interface. For information on how to select the active interface, please refer to Control Panel Setup on page 25.

Note: Factory default values are indicated by an asterisk (*).

Emulation

Possible Values: Printek*, O'Neil, ZPL-II, Mt3, CPCL

This feature sets the family of printer commands that may be used by a host application program to control the various capabilities of the printer. The printer will only respond to commands valid for the currently selected emulation. For more information, please refer to the *MtP Series & FieldPro Programmer's Manual*.

Baud Rate

Possible Values: 9600, 19200, 38400, 57600*

This feature sets the baud rate for the Serial interface. The value must match the setting used on the host system.

Data Bits

Possible Values: 7, 8*

This feature sets the number of data bits in the serial character frame. The value must match the setting used on the host system.

Stop Bits

Possible Values: 1*, 2

This feature sets the number of stop bits included in the serial character frame. The value must match the setting used on the host system.

Parity

Possible Values: None*, Even, Odd

This feature sets the parity checking requirements for the data bits in the serial character frame. The value must match the setting used on the host system.

XON/XOFF Handshaking

Possible Values: Off*, On

This feature enables or disables the XON/XOFF (DC1/DC3) character handshaking method used to control data flow from the host system to the printer. When enabled, an XOFF character will be sent by the printer whenever the printer's input buffer is nearly full. An XON character will be sent whenever the printer's input buffer becomes nearly empty.

ETX/ACK Handshaking

Possible Values: Off*, On

This feature enables or disables the ETX/ACK character handshaking method used to control data flow from the host system to the printer. When enabled, an ACK character will be sent by the printer after an ETX character has been received and processed out of the input buffer. ETX characters used for handshaking cannot be part of an escape sequence.

RTS/CTS Handshaking

Possible Values: Off, On*

This feature enables or disables the RTS/CTS hardware handshaking method used to control data flow from the host system to the printer. When enabled, the printer will activate the RTS signal whenever the printer's input buffer becomes nearly empty or when the printer's control panel Setup Menus are active. The RTS signal will be deasserted whenever the printer's input buffer becomes nearly empty.

Likewise, the printer will not send data to the host system if the host has asserted the CTS signal.

Bluetooth Interface

The following Bluetooth Interface menu features are only available and/or only take affect when the Bluetooth Interface is currently selected as the active interface. For information on how to select the active interface, please refer to Control Panel Setup on page 25.

Note: Factory default values are indicated by an asterisk (*).

Emulation

Possible Values: Printek*, O'Neil, ZPL-II, Mt3, CPCL

This feature sets the family of printer commands that may be used by a host application program to control the various capabilities of the printer. The printer will only respond to commands valid for the currently selected emulation. For more information, please refer to the *MtP Series & FieldPro Programmer's Manual*.

Pairing Mode

Possible Values: Paired*, Unpaired

This feature allows Bluetooth pairing to occur between the printer and the connecting device whenever Security is required by either device. Pairing requires that the PIN on the printer and the connecting device exactly match each other.

Role Policy

Possible Values: Defer*, Master

This feature selects the role of the printer's interface in the Bluetooth network.

If the device attempting to communicate with the printer is having trouble discovering the printer, setting the value to Master may correct the problem.

Printer Configuration

Discoverability

Possible Values: Off, On*

This feature is used to set whether the printer may be discovered by other Bluetooth devices. It should only be set to “Off” after the printer has been discovered and paired with a host computer.

PIN

Possible Values: 0*, Up to 16 Numeric Characters.

Note that this feature is only available if Pairing Mode is set to Paired. The PIN value must exactly match the PIN value set on the host computer.

Security

Possible Values: Off*, On

Setting Security to On forces the printer and the remote device to use pairing. Setting Security On requires that Pairing is set to Paired and that a PIN has been entered that matches the PIN in the remote device.

Local Name

Possible Values: FP-*aaannnnn**

Up to 16 characters of “0” through “9”, “A” through “Z”, “a” through “z”, “-”, “_”, SPACE

This feature sets the name that will be displayed by most host systems when “discovering” the printer. When shipped from the factory, the default value for the Bluetooth Local Name is “FP-*aaannnnn*” where “*aaannnnn*” is the printer’s serial number. This name may be changed to any combination of letters, numbers, dashes, underscores, and SPACES. The name may be up to 16 characters in length.

Wi-Fi Interface

The following Wi-Fi Interface Menu features are only available and/or only take affect when the Wi-Fi Interface is currently selected as the active interface. For information on how to select the active interface, please refer to Control Panel Setup on page 25.

Note: Factory default values are indicated by an asterisk (*).

Emulation

Possible Values: Printek*, O’Neil, ZPL-II, Mt3, CPCL

This feature sets the family of printer commands that may be used by a host application program to control the various capabilities of the printer. The printer will only respond to commands valid for the currently selected emulation. For more information, please refer to the *MtP Series & FieldPro Programmer’s Manual*.

WLAN Type

Possible Values: Infrastructure*, Peer-to-Peer

This feature specifies the type of wireless network the printer will be attached to. An Infrastructure network consists of nodes that connect to each other and/or a wired network through an Access Point. A Peer-to-Peer, or Ad-Hoc, network consists of nodes that connect directly to each other without the control of an access point.

Note: When using Control Panel Setup to change the WLAN Type to Peer-to-Peer, the following features will also be changed. To change these features back to their original settings will require the use of the Printek Mobile Setup Utility.

- IP Address Assign will be set to "Static"
- IP Address will be set to "192.168.0.2"
- WLAN Channel will be set to "1"
- WLAN WEP will be set to "Disabled"

WLAN Channel

Possible Values: 1* ... 14

Note that this feature is only available if the WLAN Type is set to Peer-to-Peer.

This feature sets the radio channel to be used when communicating in a Peer-to-Peer network. When in an Infrastructure network, the radio channel is automatically assigned by the interface and Access Point.

WLAN SSID

Possible Values: any*,
Up to 16 characters of "0" through "9", "A" through "Z", "a" through "z",

This feature specifies the "name" of the network the printer will connect to. This allows communications to be controlled, or routed to the appropriate nodes when multiple wireless networks are present. When set to "any", the printer may connect to any available network(s).

WLAN WEP Bits

Possible Values: 0*, 64, 128

This feature specifies the level of Wired Equivalent Security to use. If set to "0", security is turned off. If set to a "64" or "128" bit encryption level, a WEP Key must be entered that matches the key on the other nodes on the network.

WEP Key 1, WEP Key 2, WEP Key 3, WEP Key 4

Possible Values: 10 or 26 character user specified hexadecimal string

Note that this feature is only available if WLAN WEP Bits is set to 64 or 128.

This feature specifies an encryption "key" or password that is used to encrypt/decrypt data on the network. If WLAN WEP Bits is set to "64", a ten character hexadecimal string must be entered that matches the key on the other nodes the printer will be communicating with. If WLAN WEP Bits is set to "128", a 26 character hexadecimal string must be entered.

Printer Configuration

WLAN Auth

Possible Values: Auto*, Open, Shared

This feature specifies the authentication method that will be used when establishing connections on the network. The method may be to use an open key or a shared key. If set to “Auto”, the printer will automatically match itself to the method used by other nodes.

IP Address Assign

Possible Values: DHCP*, Static

This feature specifies whether the printer will obtain an IP address from a DHCP server, or if an IP address will be manually assigned.

IP Address

Possible Values: 0.0.0.0*, User specified

This feature specifies the IP address for the printer.

Note that this feature has no effect if IP Address Method is not set to “Static”.

IP Subnet Mask

Possible Values: 0.0.0.0*, User specified

This feature specifies the range of addresses, or the size of the network, that the printer’s IP address belongs to.

Note that this feature has no effect if IP Address Method is not set to “Static”.

IP Gateway

Possible Values: 0.0.0.0*, User specified

This feature specifies the network node where data destined for a node outside of the LAN should be directed.

Note that this feature has no effect if IP Address Method is not set to “Static”.

Tunnel Port Number

Possible Values: 00000 ... 08023* ... 65384

This feature specifies the TCP/IP port to be used for data that is to be printed..

Format Menu

The features contained in the Format Menu affect the location and appearance of the data printed.

Note: Factory default values are indicated by an asterisk (*).

Font

Possible Values:	4.2 cpi SnsSrfA	16.9 cpi SnsSrfA
	5.5 cpi SnsSrfA	16.9 cpi Courier*
	10.2 cpi SnsSrfA	18.5 cpi SnsSrfA
	10.7 cpi SnsSrfA	18.5 cpi Courier
	12.7 cpi Courier	20.3 cpi SnsSrfA
	13.5 cpi Courier	20.3 cpi Courier
	14.5 cpi Courier	22.6 cpi Courier
	15.6 cpi Courier	25.4 cpi Courier

Any downloaded fonts will also be displayed.

This feature selects the default font and character pitch.

Spacing

Possible Values: 0 ... 3* ... 10 Lines

When printing text, this feature sets spacing between lines. The height of a complete line, or line pitch, is determined by adding the vertical size of the current font to the Spacing. With Spacing set to the default value of "3" and using a font that is 23 rows high, the line pitch would be 3 + 23, or 26 dot rows. Since each dot row is 0.125mm, 26 x 0.125 yields a line pitch of 3.25mm. or 7.8 lines per inch. This line pitch value also determines the amount of paper motion performed when an ASCII Line Feed character is received by the printer.

When printing graphic data, Spacing has no affect so that multiple lines of graphics may print adjacent to each other.

Left Margin

Possible Values: 0.0000"* ... 1.0244" in increments of 0.0394"

This feature sets the left margin in inches relative to the leftmost printing position. (The leftmost print position is determined by the Left Paper Guide position as described in the Options Menu on page 23.) The left margin must be less than the right margin.

Right Margin

Possible Values: 0.0000"* ... 1.2608" in increments of 0.0394"

This feature sets the right margin in inches relative to the rightmost printing position. (The rightmost print position is determined by the Right Paper Guide position as described in the Options Menu on page 23.)

Text characters and graphic data that would have printed to the right of the margin will be truncated.

Note: The FieldPro RT43 has a maximum print width of 4.1". However, when Mt3 Emulation has been selected, the Right Margin will begin indenting from a maximum print width of 2.84" to match the characteristics of the Printek Mt3 Series printers.

Printer Configuration

Print Contrast

Possible Values: -35% ... 0* ... +35% in increments of 5%

The printer automatically adjusts the amount of energy used in order to maintain constant print quality as the battery discharges during use. The Print Contrast setting modifies the value that is determined to be needed by the printer and may be used to obtain improved print quality on different qualities of thermal print media. A higher value will result in a darker image.

Note: By affecting the relative amount of battery energy that is used when printing, the Print Contrast setting affects both print speed and battery life. Setting a lower value will result in faster printing and will extend normal battery life. Setting a higher value may allow the use of poorer quality media and will result in slower printing and a shorter battery life.

Maximum Paper Speed

Possible Values: 0.32, 1.36, 1.92, 2.35, 2.72, 2.81* ips

This feature may be used to reduce the maximum paper speed if necessary to allow the printer to use heavier papers, narrow paper, or some coated papers that have a more slippery finish.

FFeed Distance

Possible Values: 0.0000 ... 1.2608* ... 2.5216 inches, or Mark Sensing

This feature sets the distance that paper is to be moved whenever the user presses the Paper Feed Button or a Form Feed character is received from a host system.

Note: If Mark Sensing is selected, the paper will be advanced to the next Black Mark. When Mark Sensing is used, the values of the Mark Sensitivity, Tearbar Adjust, and Top of Form Adjust features are available for adjustment.

Mark Sensitivity

Possible Values: -10 ... 0* ... +10

This feature allows the Black Mark/Paper sensor to be adjusted to allow for variations in media materials and Black Mark printing methods. The following list will help determine if, and how, the Mark Sensitivity should be adjusted.

- If the printer is not detecting black marks reliably, set the Mark Sensitivity to a lower value.
- If the printer is detecting false Check Paper conditions, set the Mark Sensitivity to a higher value.
- If the printer is detecting black marks where none exist, set the Mark Sensitivity to a higher value.

Tearbar Adjust

Possible Values: -0.295'' ... 0.000''* ... 0.315''

This feature is used to adjust the tear position when black mark sensing is used.

Top of Form Adjust

Possible Values: -0.295'' ... 0.000'' ... 0.295''

This feature is used to adjust the location of the top line of printing when black mark sensing is used.

Print All Logos In Memory

This menu item is only available using Control Panel Setup and is only available if downloaded fonts and/or logos are currently stored in the printer's memory. Selecting this item causes the printer to print out a directory of all fonts and logos, and to print a copy of all logos.

Options Menu

The Options Menu contains features that affect the overall operation of the printer.

Note: Factory default values are indicated by an asterisk (*).

Left Paper Guide Adjust

Possible Values: A*, B through G

This feature is used to match the leftmost print position with the location of the Left Paper Guide. For a complete description, please refer to the Right Paper Guide, below.

Right Paper Guide Adjust

Possible Values: None*, 1 through 9

Similar to the Left Paper Guide, this feature is used to match the rightmost print position with the right edge of the paper.

The positions of the paper guides are used to adapt the FieldPro RT43 to be used with different widths of paper. To provide maximum flexibility for various paper widths and black mark positions, any combination of left and right guide positions may be used. Paper widths less than 2.9" are not recommended.

For instance, to use the standard four inch paper (4.125"), the Left Paper Guide would be located at position "A" as shown in Figure 12, below, and the Right Paper Guide would not be installed (None). To use standard three inch paper (3.125") the Left Paper Guide would be installed at "A" and the Right Paper Guide would be installed at position "7".

To remove a paper guide, simply pull the guide out of the printer's paper compartment. To install a paper guide, insert the end toward the rear of the printer first as shown in Figure 12 and then "snap" in the end toward the front of the printer. When selecting guide positions, select positions that are as close to the end of the paper roll as possible, but not so tight that the paper cannot unroll easily.

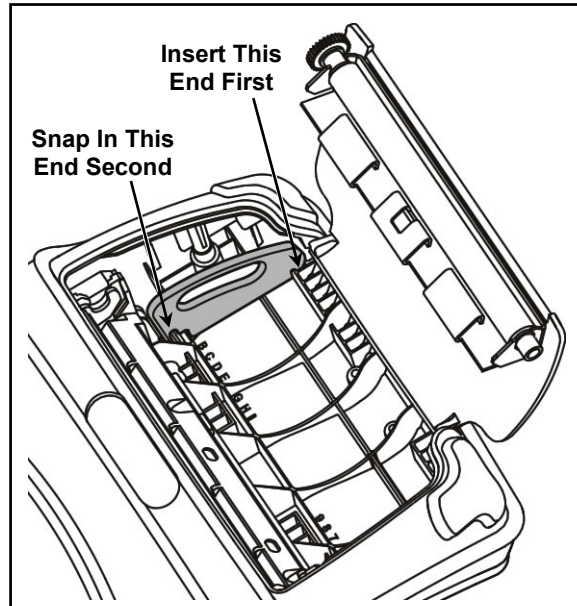

Figure 12 - Paper Guides

Auto Power Down

Possible Values: Off*, 1 Minute Delay ... 15 Minute Delay

This feature sets whether the printer will automatically power down and if so, after what period of time of inactivity. If set to a value other than "Off", the printer will automatically turn itself off after the specified number of minutes have passed since the printer last received data or last printed, whichever is longer.

Print Promo

Possible Values: No*, Yes

When set to "Yes" this feature causes a previously stored graphic image with an ID value of "\$" to be printed at the end of each print job.

This feature may be used to print a special logo or graphic image of a special sales promotion or other event.

Please refer to the *MtP Series & FieldPro Programmer's Manual* for more information on storing graphics and logos.

Print Header

Possible Values: No*, Yes

When set to "Yes" this feature causes a previously stored graphic image with an ID value of "?" to be printed at the beginning of each print job.

Please refer to the *MtP Series & FieldPro Programmer's Manual* for more information on storing graphics and logos.

Hardware Menu

Features in the Hardware Menu are used for software development/debugging and/or printer configuration. These features should not be changed unless directed by Technical Support personnel.

Note: Factory default values are indicated by an asterisk (*).

Enter Hex Dump Mode

Possible Values: No*, Yes

This feature is used to assist software programmers in determining the actual data values being received by the printer. In this mode, printer commands are not processed, but are printed along with their hexadecimal value. For more information, please refer to the *MtP Series & FieldPro Programmer's Manual*.

Burnin Mode

Possible Values: Off*, On

This feature is for factory use only. Do not change this value.

Reset to Factory Defaults

Possible Value: Hold Power 10 Sec.

When this feature is displayed, holding the Power Button will cause all setup features in all menus to return to their factory default values. Do not use this feature unless instructed by Printek Technical Support.

Control Panel Setup

Control Panel Setup allows the user to configure *some* features of the FieldPro RT43. Other features may be configured using the Printek Mobile Setup Utility. For a complete list of features and which method may be used to configure them, please refer to the Setup Menu Summary on page 13.

Control Panel Setup makes use of the control panel Power and Paper Feed buttons and printing to step through the menus of features and values that may be changed. Install plain receipt paper for this task.

Entering Setup

To enter Setup, press and hold the Paper Feed Button while turning on the printer with the Power Button. The printer will print a test page which shows most of the menu features and their current values. At the end of the test page, "PRESS FEED FOR SETUP MENU" will be printed. Pressing the Paper Feed within the next four seconds will cause the Setup mode to be entered. If the button is not pressed within four seconds, the printer will return to normal operation.

Using Setup

After the Setup mode is entered, instructions will be printed indicating that the Power Button may be used as a “Select” button and that the Paper Feed Button may be used as a “Next Menu” button.

As instructed, press the Power to select each menu or item, and press the Paper Feed to skip to the next menu or item. Upon selecting an Item inside a Menu and pressing Power, the displayed setting will change.

Press Paper Feed to skip to the next item in the menu. When EXIT MENU is displayed, press Power to go to the next menu.

When in a menu, you may press and hold Paper Feed until it beeps to skip to the next menu.

You may press and hold the Power Button until the printer beeps once to set an item to its default value.

The Interface Menu is the first menu of features displayed. If an optional Bluetooth or Wi-Fi Interface is installed in the printer, the first option presented will be to switch to the interface that is not currently the active interface. This feature will typically only be used when needing to switch from the optional interface to Serial so that the Printek Mobile Setup Utility can be used. After completing any changes with the setup utility, this same process may be used to switch back to the previously selected interface.

Exiting Setup

To save the changes you have made, press Power when the EXIT SETUP SAVE CHANGES Menu selection appears.

To exit without saving changes, press Power when the EXIT SETUP DISCARD CHANGES Menu selection appears, or at any time you may press and hold the Power Button until the printer beeps and turns off.

Interfacing To A Host Computer

Every FieldPro printer is equipped with a Universal Port which contains a Serial Interface. The Serial Interface may be used for either RS-232C or USB communications depending upon which optional cable is used. Optional factory installed interfaces are also available for Bluetooth® and Wi-Fi®. When the printer is equipped with one of the optional interfaces, only one of the interfaces may be “active” at any time. For information on switching the active interface, please refer to Control Panel Setup on page 25 of the Printer Configuration section of this manual.

Note: To print out configuration information for the currently selected interface, you may press and hold the Paper Feed Button while turning the printer on.

Serial Interface

The Serial Interface contained in the Universal Port may be used for either an RS-232C or a USB connection. For either of these connections, the Serial Interface must be the currently active interface. If there is no optional interface installed, Serial will be the only interface available.

When using the Serial Interface for RS-232C communications, the baud rate, data bits, parity, stop bit(s), and handshaking method (XON/XOFF, ETX/ACK, RTS/CTS) must be set to match the settings on the host computer. If these settings do not match, errors and/or lost data may occur.

When using the Serial Interface for USB communications, the printer’s default values of 57,600 Baud, 8 Data Bits, 1 Stop Bit, No Parity, and RTS/CTS = Yes must be used.

To access the Universal Port connector, refer to Figure 13 and move the lever in the direction shown to unlock and remove the cover.

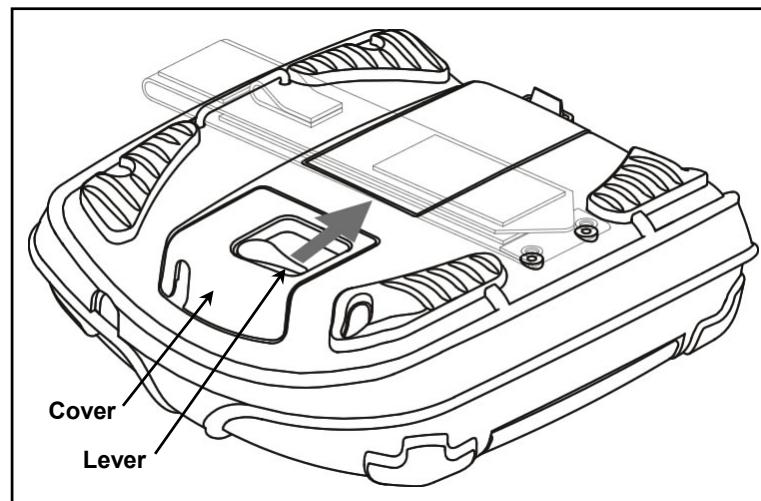

Figure 13 - Removing The Universal Port Cover

Interfacing to a Host Computer

Figure 14 and Figure 15 show the location of the Universal Port Connector and the connector pin assignments.

Caution: Do not make any connection to pins 4 or 8. These pins are used only for Printek accessories and improper connections with these contacts may cause severe damage to the printer. Such damage will not be covered by the printer's warranty.

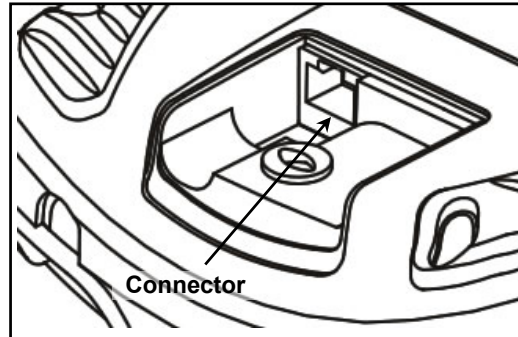
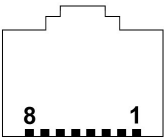

Figure 14 - Universal Port Connector



<u>Pin #</u>	<u>Signal</u>	<u>Description</u>
1	COM	Logic Common
2	TXD	Transmit Data (From Printer)
3	RXD	Receive Data (From Host)
4	Reserved	Do Not Connect
5	CTS	Clear To Send (From Printer)
6	COM	Logic Common
7	RTS	Request To Send (From Host)
8	Reserved	Do Not Connect

Figure 15 - Connector Pin Assignments

Bluetooth® Interface

In addition to the standard Serial Interface, your FieldPro RT43 may be equipped with an optional Bluetooth Interface. Bluetooth interfaces are built into some Smartphones and PDA's and may be added to most others. Bluetooth interfaces may also be added to notebook or desktop computers. To communicate using the Bluetooth Interface, it must be selected as the currently active interface.

The Bluetooth Interface uses wireless, radio frequency signals to communicate.

The FieldPro Bluetooth Interface acts as a "serial port adapter" operating as a "server". Being a serial port adapter means that the printer may appear as a "Serial Device" when discovered, rather than as a "Printer".

Operating as a server, other devices such as a PDA or other host computer may initiate the connection to the printer.

When discovered, the default name that will appear will be “FP-*aaannnnn*” where “*aaannnnn*” is the printer’s serial number. To obtain the printer’s Bluetooth name, you may print the printer’s test page by holding the Paper Feed button while turning the printer on.

To conserve battery power, application programs should disconnect from the printer whenever possible.

Wi-Fi[®] Interface

In addition to the standard Serial Interface, your FieldPro RT43 may be equipped with an optional Wi-Fi Interface. Wi-Fi interfaces are built into some PDA’s and may be added to most others. Wi-Fi interfaces may also be added to notebook or desktop computers and as an “access point” to a wired network. To communicate using the Wi-Fi Interface, it must be selected as the currently active interface.

The Wi-Fi interface uses wireless, radio frequency signals to communicate.

The FieldPro Wi-Fi interface acts as a server and will accept connections from a host device such as a PDA, notebook computer, or a network server.

The FieldPro Wi-Fi interface conforms to the IEEE 802.11b standard. The factory default settings for this interface are:

WLAN Type: Infrastructure
WLAN SSID: any
WLAN WEP Bits: 0 (Off)
WLAN Auth: Auto
IP Address Assign: DHCP (The DHCP name will be “FP-*aaannnnn*”
where “*aaannnnn*” is the printer’s serial number.)
Tunnel Port: 8023

These settings for the Wi-Fi interface features may be modified as described in the Printer Configuration section of this manual on page 13.

To print out the current Wi-Fi configuration details, you may print the printer’s test page by holding the Paper Feed button while turning the printer on. Enter Control Panel Setup and use the “Print Interface Settings” feature to obtain the current IP address when assigning addresses via DHCP. When doing so, be sure to wait several seconds after turning the printer on to allow it to establish a connection with the network and be served an address.

When operating in Infrastructure mode, the printer will attempt to conserve battery power whenever possible by placing the Wi-Fi interface into a low power mode when not communicating. However, according to the IEEE 802.11b standard, the printer must be granted “permission” from the network’s Access Point before operating in the low power mode. Since different Access Point manufacturers implement this feature differently, the amount of power saving actually achieved varies. The actual power saving also varies with the amount of network traffic.

Power Considerations

FieldPro printers are designed to provide superior output using as little power as necessary. This provides the longest possible battery life. The printers may also be operated from an external power supply when used in a more permanent installation in a vehicle or office. The following discussions indicate how the printer accomplishes this power conservation using features such as Standby and Auto Power Down. For more information on battery charging, please refer to “Charging the Battery” on page 34.

Standby Operation

When operating on battery power, the printer automatically enters a Standby mode one minute after the last computing event (i.e., receiving data, printing, a front panel button is pressed, or a magnetic card reader swipe operation). When in Standby, the printer will flash the Power Indicator.

While in Standby the printer turns off as many power consuming components as possible. However, the printer remains fully capable of receiving data or responding to a control panel button. The printer will automatically “wake up” when it begins to receive data from a host system, or when any front panel Button is pressed.

Auto Power Down

To conserve even more battery power, the printer may also be configured to turn itself off after a specified number of minutes of inactivity. When the printer powers down, this is equivalent to turning the printer off using the Power Button and the printer will no longer respond to incoming data.

To enable the Auto Power Down feature, please refer to the Options Menu settings on page 23.

Operation Without A Battery

FieldPro printers may be operated with an optional power supply and without a battery installed. Power supplies are available for use with 100-240VAC/50-60Hz and for 12/24VDC vehicle applications.

Caution: Use only Printek power supplies designed specifically for your FieldPro RT43 printer. Using a different power supply may cause damage to the printer and will not be covered by the printer’s warranty.

Maintenance and Troubleshooting

Cleaning

In normal environments, the printer should be cleaned after printing a few rolls of paper or if there are voids in the printout. For optimum performance and life, you should clean the Print Head and Platen Roller whenever you load new paper.

To clean the printer areas as described below, use a Thermal Head Cleaning Pen and MCR Cleaning Card available from Printek, or you may use cotton swabs moistened with isopropyl alcohol. Please refer to Figure 16 for the following instructions.

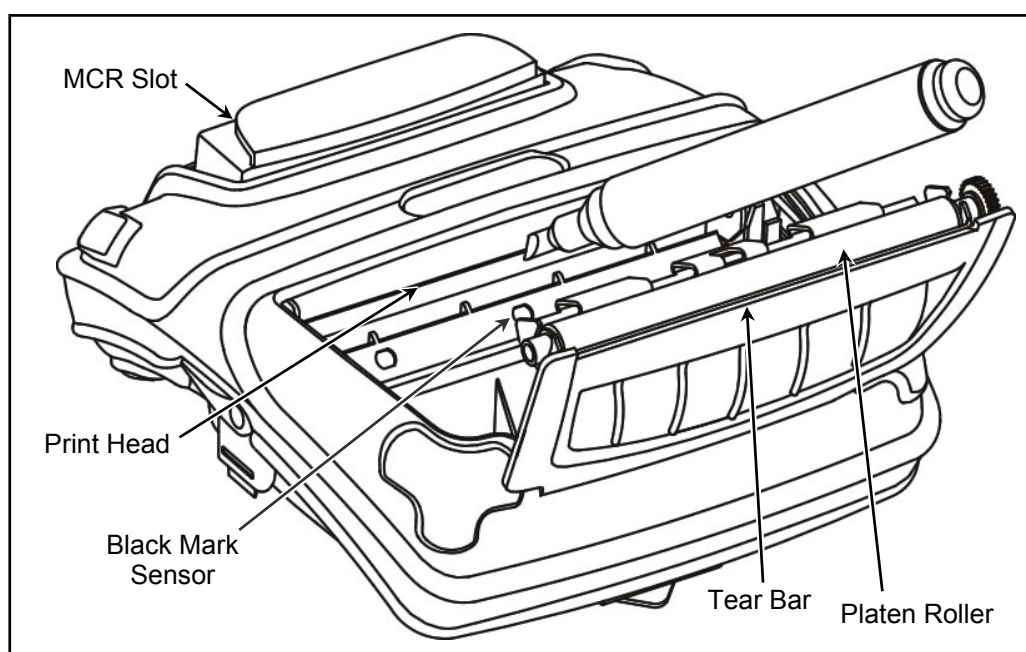

Figure 16 - Printer Cleaning Areas

- Turn the printer off. Open the Paper Door and remove the paper.
- Using a Thermal Head Cleaning Pen, clean the surface indicated on the Print Head.
Caution: Do not use sharp objects to clean the print head. This may damage the printer and require service. Such damage is not covered under warranty.
- Clean the Black Mark Sensor below the print head.
- Clean the Tear Bar
- Clean the Platen Roller. Turn the platen roller with your finger to clean the entire surface.
- If a Magnetic Card Reader is installed, pass an MCR Cleaning Card through the MCR slot to clean the head.

You may also experience a build up of paper dust in the printer. This may be removed using a can of compressed air or by vacuuming.

To clean the exterior of the printer, turn the printer off and use a soft cloth moistened with a mild detergent.

Battery Care

Charging the Battery

The printer's battery is charged in the printer using an optional power supply. Power supplies are available for 100-240VAC/50-60Hz and for 12/24VDC vehicle applications. Follow the steps listed below to charge the battery.

- Plug the power supply into a power source appropriate for the adapter being used.
- Plug the power supply into the power connector on the side of the printer. The printer's battery charging circuitry will analyze the condition of the battery and begin charging it if necessary.
- If the battery is not fully charged, charging will begin and the Battery Indicator will illuminate.
- When the battery is fully charged, the Battery Indicator will turn off. Charging may take up to 2½ hours depending on the condition of the battery.
- The printer may be used while the battery is charging, but this will extend the time required to fully charge the battery.
- The power supply may remain connected to the printer to keep the battery fully charged and will not cause damage to the printer or battery.

Additional Battery and Safety Information

- All FieldPro series printers use a 7.4 volt 2200mAh Lithium Ion battery.
- The recommended ambient temperature for charging is 68-77° Fahrenheit (20-25° Centigrade).
- Take the battery out of the printer when storing the printer for long periods of time. The battery storage temperature is 40-104° Fahrenheit (4-40° Centigrade). Do not store a fully charged battery at temperatures above this range for long periods of time or the battery may permanently lose charge capacity.
- Do not disassemble, short circuit, heat above 80°C, or incinerate the battery. The battery may explode.
- Only dispose of used batteries according to your local regulations. If you do not know your local regulations, the Rechargeable Battery Recycling Corporation (RBRC) is a non-profit organization created to promote recycling of rechargeable batteries. For more information visit www.rbrc.org.



Testing the Power Supply and Battery

To verify that the printer's internal battery charger is functioning properly, perform the following steps.

- Test the power adapter (100-240VAC/50-60Hz, 12/24VDC adapter) with a voltmeter to verify that its output voltage is 9 VDC.
- Connect the power supply to a power source and then connect it to the printer.
- Verify that the printer's Battery Indicator is illuminated. If illuminated, the charging circuit is functioning properly.
 - **Note:** that if the battery is already fully charged, the Battery Indicator will turn off after a short time.
- After the battery has been charged for five minutes, disconnect the power supply.
- Perform a printer Self-Test.
 - Make sure the printer is turned off.
 - Press and hold the Paper Feed Button while turning the printer on.
- If the printer successfully prints the Self-Test, the battery is functional. If the Self-Test does not complete and the printer turns itself off, repeat this test with a known good battery.
- Once this test has completed successfully, allow the battery to fully charge. At the end of this time the Battery Indicator will turn off.

If the printer and battery do not appear to successfully pass these tests, refer to the Troubleshooting section for possible causes and solutions.

Note: This test only verifies that the power adapter, the internal charging circuit, and the battery are functioning properly. This test does not provide a valid indication of the relative capacity of the battery or how long it may hold a charge.

Troubleshooting

When encountering problems, the cause may be the printer or may sometimes be due to other problems with your system. Please review the following tables to solve common problems you may encounter with your printer. You may also visit www.printek.com for additional “FAQ’s” that may assist you.

If you are still unable to solve your problem, please contact the company where you purchased your printer since they are most familiar with your systems. If they are unable to help you, you may contact Printek Technical Support at (800) 368-4636.

Error Conditions

Whenever the printer detects an error condition, the Error Indicator will either flash or stay on. In some cases the audible alarm will also sound. Please refer to the following table for a list of what causes these conditions and how they may be corrected.

Error Indicator	Possible Cause	Solution
Flashes, With Alarm	Paper Out	Install paper and press the Paper Feed Button to clear the error.
Stays On, No Alarm	Paper door not fully closed.	Make sure the door is fully closed by opening the door and closing it again until the door “clicks” closed. Check the platen roller for damage.
Stays On, With Alarm	Communications error.	Verify communications settings in the Interface Menu. Printer must be turned off to clear error.

Other Problems

Problem	Possible Cause	Solution
Printer will not turn on.	Battery not installed properly.	Remove and reinstall battery making sure the battery release lever “clicks” when fully installed.
	Discharged battery.	Recharge battery.
Printer turns itself off.	Auto Power Down is enabled.	Change setting in Options Menu as described on page 23.
	Battery discharged.	Replace or recharge battery.
	Electrostatic discharge.	May occur in extreme low humidity conditions. Turn printer back on with power button.
Battery Indicator does not light or does not stay lit when power supply is connected.	Battery already fully charged.	No action required.
	Power supply not receiving power.	Check building/vehicle circuit breakers/fuses.
	Faulty power supply.	Check output of power supply with voltmeter. 9 VDC.
	Battery not installed properly.	Remove and reinstall battery making sure the battery release lever “clicks” when fully installed.

Problem	Possible Cause	Solution
Battery not charging.	Faulty power supply or battery.	Refer to “Testing the Power Supply and Battery” on page 35.
Poor print quality.	Low battery.	Check and recharge battery.
	Print head dirty.	Clean print head. Refer to page 33.
	Poor quality or “old” paper.	Verify paper from approved source. Try new roll of paper.
Paper not feeding.	Obstruction in paper path or paper improperly installed.	Check paper path and reinstall paper.
	Poor quality paper.	Verify paper from approved source.
	Paper Door not fully closed.	Verify door is closed.
Paper not feeding reliably or print is compressed vertically	Poor quality paper.	Verify paper from approved source.
	Heavy or thick forms. Specialty paper with slick finish.	Lower the Max Paper Speed as described in Format Menu on page 21.
	Paper Door not fully closed.	Verify door is closed.
Print Garbled.	Low Battery.	Check and recharge battery.
	Improper Serial Interface configuration.	Verify printer and host settings match.
	Paper Door not fully closed.	Verify door is closed.
Printer will not print.	Low Battery.	Check and recharge battery.
	Paper not loaded correctly.	Check paper path and reinstall paper.
	Improper interface configuration.	Verify printer and host settings match. Print a self test to verify printer settings and to verify printer is functioning properly.
Cannot print via optional interface.	Interface not configured correctly.	Print a self test to verify printer settings. Make sure the interface is selected and make sure printer and host set ups match.

Obtaining Service

If service is required for your printer, please contact the company where you purchased your printer. If they are unable to assist you, contact Printek Customer Service at (800) 368-4636 to obtain the name of the nearest Printek Authorized Service Center.

If you wish to return your printer to Printek for service, please contact Printek Customer Service at (800) 368-4636 to obtain a Return Authorization Number. Units returned without a Return Authorization will not be accepted.

Print & Font Samples

Print Samples

Sans Serif 5.5 cpi
0 1 2 3 4 5 A B C D E F a b c d e f

Sans Serif 10.2 cpi
0 1 2 3 4 5 A B C D E F a b c d e f

Sans Serif 10.7 cpi
0 1 2 3 4 5 A B C D E F a b c d e f

Courier 12.7 cpi
0 1 2 3 4 5 A B C D E F a b c d e f

Courier 13.5 cpi
0 1 2 3 4 5 A B C D E F a b c d e f

Courier 14.5 cpi
0 1 2 3 4 5 A B C D E F a b c d e f

Courier 15.6 cpi
0 1 2 3 4 5 A B C D E F a b c d e f

Courier 16.9 cpi
0 1 2 3 4 5 A B C D E F a b c d e f

Courier 18.5 cpi
0 1 2 3 4 5 A B C D E F a b c d e f

Courier 20.3 cpi
0 1 2 3 4 5 A B C D E F a b c d e f

Courier 22.3 cpi
0 1 2 3 4 5 A B C D E F a b c d e f

Courier 25.4 cpi
0 1 2 3 4 5 A B C D E F a b c d e f

Courier 12.7 cpi

Courier 12.7 cpi **Emphasized**

Courier 12.7 cpi **Double High**

Courier 12.7 cpi **Double High Emphasized**

Courier Font With International Extended Character Set

	0	1	2	3	4	5	6	7	8	9	A	B	C	D	E	F
2	!	"	#	\$	%	&	'	()	*	+	,	-	.	/	
3	Ø	1	2	3	4	5	6	7	8	9	:	;	<	=	>	?
4	@	A	B	C	D	E	F	G	H	I	J	K	L	M	N	O
5	P	Q	R	S	T	U	U	W	X	Y	Z	[\]	^	_
6	`	a	b	c	d	e	f	g	h	i	j	k	l	m	n	o
7	p	q	r	s	t	u	v	w	x	y	z	{		}	~	
8	ç	ü	é	â	ä	à	ã	ç	ê	ë	è	í	î	ì	ñ	ñ
9	è	æ	œ	ô	ö	ò	û	ù	ÿ	ö	Ü	ø	ε	Ø	×	f
A	á	í	ó	ú	ñ	Ñ	æ	ø	¿	↑	↓	½	¼	¡	«	»
B	Ş	ş	Ć	ċ	İ	ı	Ĥ	ĥ	Ħ	ħ	ı	ƒ	€	¥	Π	
C	ϕ	ψ	α	γ	δ	ε	ä	ã	ζ	η	θ	κ	λ	ξ	σ	ς
D	τ	ν	Ê	Ë	È	Ψ	Í	Î	Ï	Ω	Á	É	Ŋ	Á	Ì	□
E	ó	β	ô	ò	ö	ö	μ	ρ	√	¹	Ú	Ù	ϕ	ϕ	ú	ú
F	ƒ	±	ø	∞	Ω	Σ	π	f	♥	♦	♣	♠	÷			█

Courier Font PC Line Drawing Extended Character Set

	0	1	2	3	4	5	6	7	8	9	A	B	C	D	E	F
8	ç	ü	é	â	ä	à	ã	ç	ê	ë	è	í	î	ì	ñ	ñ
9	è	æ	œ	ô	ö	ò	û	ù	ÿ	ö	Ü	ø	ε	Ø	×	f
A	á	í	ó	ú	ñ	Ñ	æ	ø	¿	↑	↓	½	¼	¡	«	»
B	Ş	ş	Ć		†	‡	†	‡	†	‡	†	‡	†	‡	†	‡
C	⌞	⌞	⌞	⌞	⌞	⌞	⌞	⌞	⌞	⌞	⌞	⌞	⌞	⌞	⌞	⌞
D	⌞	⌞	⌞	⌞	⌞	⌞	⌞	⌞	⌞	⌞	⌞	⌞	⌞	⌞	⌞	⌞
E	ó	β	ô	ò	ö	ö	μ	ρ	√	¹	Ú	Ù	ϕ	ϕ	ú	ú
F	ƒ	±	ø	∞	Ω	Σ	π	f	♥	♦	♣	♠	÷			█

Sans Serif Font

	0	1	2	3	4	5	6	7	8	9	A	B	C	D	E	F
2	!	"	#	\$	%	&	'	()	*	+	,	-	.	/	
3	0	1	2	3	4	5	6	7	8	9	:	;	<	=	>	?
4	@	A	B	C	D	E	F	G	H	I	J	K	L	M	N	O
5	P	Q	R	S	T	U	V	W	X	Y	Z	[\]	^	_
6	`	a	b	c	d	e	f	g	h	i	j	k	l	m	n	o
7	p	q	r	s	t	u	v	w	x	y	z	{		}	~	□
8	€	□	,	f	„	...	†	‡	^	%	Š	◊	◊	Ž	□	
9	□	'	'	“	”	•	—	~	™	š	›	œ	□	ž	ÿ	
A	ı	¢	£	¤	¥	¦	§	¨	©	ª	«	¬	-	®	¯	
B	°	±	²	³	´	µ	¶	·	¸	¹	º	»	¼	½	¾	¿
C	À	Á	Â	Ã	Ä	Å	Æ	Ç	È	É	Ê	Ë	Ì	Í	Î	Ï
D	Ð	Ñ	Ò	Ó	Ô	Õ	Ö	×	Ø	Ù	Ú	Û	Ü	Ý	Þ	ß
E	à	á	â	ã	ä	å	æ	ç	è	é	ê	ë	ì	í	î	ï
F	ò	ñ	ò	ó	ô	õ	ö	÷	ø	ù	ú	û	ü	ý	þ	

Specifications

Printer Specifications

Printing Specifications

Printing Method: Direct Thermal, Up To 2.8 Inches Per Second
Printing Resolution: 203 dots per inch (8 dots per mm)
Printing Width: 832 Printing Elements for up to 4.1" (10.41 cm)

Fonts/Characters/Bar codes

Fonts: A wide range of font types and sizes, from ~ 6 cpi to 34 cpi plus scaling depending on emulation chosen
International Characters: Arab-T, Arab-S, Arab-E, Asian fonts and an expanding catalog available for download
Bar Codes: Code 39, Code 128, UCC/EAN-128, UPC/EAN/JAN, Interleaved 2 of 5, CODABAR, EAN08 & 13, PDF-417, UPC
Downloads: Downloadable fonts, graphics, logos, and additional bar codes

Connectivity

Serial: RS-232C (Standard), USB (Optional cable required)
Wireless: Bluetooth, Wi-Fi 801.11b (Options)
Universal Port: Data and power port allows connection of external devices such as Printek barcode scanners, signature capture pads
Emulations: Printek, Printek Mt3, O'Neil, ZPL-II, CPCL, Exttech
Software Available: Drivers for Windows 98/2000/XP.
Print Utilities for Palm OS.
SDK's for Palm OS.
Setup utility for configuration from Windows 98/2000/XP.

Data Input

Magnetic Card Reader: 3 Track, Simultaneous Read (Option)

Power Management

Battery: 7.4 V, 2200mAH rechargeable 2 cell Lithium Ion
Endurance: 500 pages or more than 3,5000 inches of print per charge
Internal Charging: 2½ hours (requires optional power supply)
Battery Free Operation: Printer may be used with optional external power supply, with or without battery

Specifications

Physical Specifications

Size: 6.1 x 5.9 x 2.7 inches, 15.5 x 15.0 x 6.9 cm (LxWxH)
Weight: 20 Ounces (.57 kg) with battery

Environmental Specifications

Operating Temp: -4° to 122°F (-20° to 50°C)
Storage Temp: -4° to 140°F (-20° to 60°C)
Humidity: 10% to 90% RH (non-condensing)
Rating: IP54 per IEC 529, without optional environmental case

Operator Controls and Indicators

Indicators: Power/Wireless Connection, Battery Status, Fault
Controls: Power, Paper Feed
Sensors: Paper, Paper Door Open, Black Mark Detection

Memory Capacity

Flash: 1MB Program Memory; 1MB Font, Logo and Graphic Storage
RAM: 1MB
EEPROM: For Nonvolatile Configuration Storage

Durability and Reliability

Drop Test: Survives multiple 4 foot drops to concrete (each face), conforms to IEC 68-2
MTBF: 10,000 hours in normal use

Regulatory Approvals

Approvals/Markings: FCC Class B
CE Mark
RoHS
WEEE
UL listed AC adapters
E-mark on In-Vehicle adapters

Warranty

Printer: One year including print head and battery

Media Specifications

Receipt Paper

General Specifications: 0.0022 to 0.0065" (0.056 to 0.089mm) Thick
2.9 to 4.125" (73.66 to 104.78mm) Wide
1.75" (44.45mm) Maximum Outside Diameter
0.750" (19.05mm) Core Diameter Recommended
Black Mark Sensing On Printed Side

Approved Vendors: Kansaki: P300, P310, P350, P354, P390*, P530UV, TO281CA,
OP200, TO381N, F180, F380, F550

Jujo: TF-50KS-E2C

Honshu: FH65BV-3

Appleton: Resiste 900-3.0*

*Standard Printek Offering

Black Mark Position

For automatic ticket printing, the black mark should be positioned as shown in the figure below. When using Mark Sensing mode, FieldPro printers will automatically position the output for tear-off and printing following a Form Feed command or by pressing the Paper Feed button.

For non-automatic paper positioning, refer to the *MtP Series & FieldPro Programmer's Manual* for sensing and positioning commands.

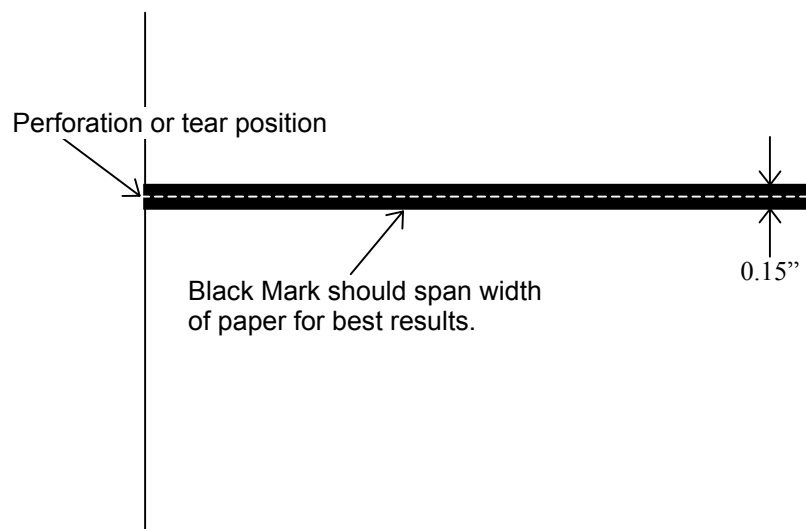

Figure 17 - Black Mark Position

Supplies and Accessories

Supplies

- Battery: 7.4V, 2200 mAH Li-Ion
Available separately or in 5 or 20 packs.
- Media: 3.125" and 4.125" wide standard receipt paper
3.125" and 4.125" wide premium receipt paper
Available in cases of 36. Other sizes available on request.
- Cleaning Supplies: Print head cleaning pens
Magnetic Card Reader cleaning cards

Accessories

- Power Supplies: 100-240VAC/50-60Hz Wall Adapter
12/24VDC Vehicle Adapter
- Carrying Options: Shoulder Strap
- Cables: RS-232C – RJ to DB-9F
USB – RJ to USB-A

Glossary of Terms

802.11	Wireless networking communication standards created by IEEE.
access point	An interface between a wireless network and a wired network.
Ad-Hoc	A Wi-Fi network consisting of only stations (no access point). Same as Peer-to-Peer.
ASCII	American Standard Code for Information Interchange.
authentication	The process a Wi-Fi station uses to identify itself to another station.
bandwidth	The amount of data that be transferred in a given period of time.
baud rate	The rate at which characters are transmitted over a serial interface. This is also often referred to as bits per second.
binary	Base two numbering system. Digits are represented by the characters 0 and 1.
bit	A single binary digit.
Bluetooth	A definition for short range radio frequency communications.
client	Any node on a network that requests services from another node (server).
control code	A single, non-printing character which is used to control the configuration or operation of the printer.
character pitch	The horizontal spacing of characters. Measured in cpi.
cpi	Characters per inch.
current line	The line upon which the next character will be printed.
current print position	The column on the current line where the next character will be printed.
default	Value or configuration assumed when the printer is powered on or reset.
DHCP	Dynamic Host Configuration Protocol. A method used to centrally control the assignment of IP addresses on a network.
dpi	Dots per inch. Generally used to refer to graphics density or resolution.
escape sequence	String of characters beginning with the escape (ESC) character which is used to control the configuration or operation of the printer. The characters which are part of this string are not printed.
font	A group of characters of a given shape or style.
hexadecimal	Base sixteen numbering system. Digits are represented by the characters 0 through 9 and a through f.
IEEE	Institute of Electrical and Electronic Engineers
infrastructure	A Wi-Fi network consisting of stations connecting to a wired network or other stations via an access point.
interface	The connection between the printer and the host computer.

Glossary

IP	Internet Protocol. A specification for packets, or datagrams, of data and an addressing method to allow the exchange of data with another system. Must be combined with another protocol such as TCP to create a complete connection with the other system.
LAN	Local Area Network.
LCD	Liquid crystal display.
LED	Light emitting diode.
line pitch	The vertical spacing of rows of characters. Measured in lpi.
lpi	Lines per inch.
margin	An area along any edge of a form where data may not be printed.
MSB	Most significant bit. In a character, this refers to bit seven (of 0 to 7).
node	Any device connected to a network.
parity	A method used for detecting errors within a single character transmitted or received via an interface.
Peer-to-Peer	A network consisting of only stations (no access point or central server). Same as Ad-Hoc.
reset	Initialization of various operating features of the printer to the value or state assumed when the printer is powered on.
RS-232C	An EIA standard for serial data transmission.
server	Any node on a network that provides services to another node (client).
SSID	Service Set Identifier. An identifier attached to packets on a Wi-Fi network that identify the particular network the packets are intended for.
TCP	Transmission Control Protocol. A specification that controls the connection between systems on a network.
top of form	The vertical position where the first line is printed on the paper. Also the position the paper is advanced to when a form feed (FF) character is received from the host or the Form Feed button is pressed on the printer's control panel.
USB	Universal Serial Bus.
WAN	Wide Area Network. Refers to connections that allow one LAN to communicate with another LAN(s).
WEP	Wired Equivalent Privacy. A security protocol for wireless LANs designed to provide data security similar to a wired LAN.
Wi-Fi	Refers to any of the IEEE 802.11 standards.
WLAN	Wireless Local Area Network. A LAN made up of wireless nodes.

Free Manuals Download Website

<http://myh66.com>

<http://usermanuals.us>

<http://www.somanuals.com>

<http://www.4manuals.cc>

<http://www.manual-lib.com>

<http://www.404manual.com>

<http://www.luxmanual.com>

<http://aubethermostatmanual.com>

Golf course search by state

<http://golfingnear.com>

Email search by domain

<http://emailbydomain.com>

Auto manuals search

<http://auto.somanuals.com>

TV manuals search

<http://tv.somanuals.com>