

PRO-FORM[®]

RESTORATION 3100

Model No. PFRX31071
Serial No. _____

The serial number can be found in the location shown below. Write the serial number in the space above.

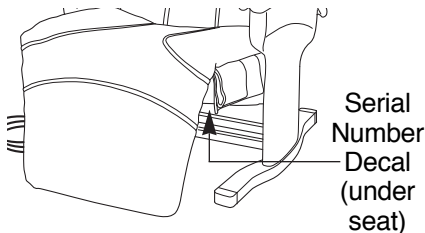

USER'S MANUAL

QUESTIONS?

As a manufacturer, we are committed to providing complete customer satisfaction. If you have questions, or if there are missing or damaged parts, we will guarantee complete satisfaction through direct assistance from our factory.

TO AVOID UNNECESSARY DELAYS, PLEASE CALL DIRECT TO OUR TOLL-FREE CUSTOMER HOT LINE.

CUSTOMER HOT LINE:
1-800-999-3756
Mon.-Fri., 6 a.m.-6 p.m. MST



CAUTION

Read all precautions and instructions in this manual before using this equipment. Save this manual for future reference.



Visit our website at

www.proform.com

new products, prizes,
fitness tips, and much more!

Table of Contents

Limited Warranty	3
Important Precautions	4
Before You Begin	5
Assembly	6
How to Operate the Massage Chair	8
Maintenance	11
Ordering Replacement Parts	Back Cover

Note: A PART LIST/EXPLODED DRAWING and a PART IDENTIFICATION CHART are attached in the center of this manual. Remove the PART LIST/EXPLODED DRAWING and the PART IDENTIFICATION CHART before beginning assembly.

Limited Warranty

ICON Health & Fitness, Inc. (ICON), warrants this product to be free from defects in workmanship and material, under normal use and service conditions, for a period of ninety (90) days from the date of purchase. This warranty extends only to the original purchaser. ICON's obligation under this warranty is limited to replacing or repairing, at ICON's option, the product at one of its authorized service centers. All products for which warranty claim is made must be received by ICON at one of its authorized service centers with all freight and other transportation charges prepaid, accompanied by sufficient proof of purchase. All returns must be pre-authorized by ICON. This warranty does not extend to any product or damage to a product caused by or attributable to freight damage, abuse, misuse, improper or abnormal usage or repairs not provided by an ICON authorized service center, products used for commercial or rental purposes, or products used as store display models. No other warranty beyond that specifically set forth above is authorized by ICON.

ICON is not responsible or liable for indirect, special or consequential damages arising out of or in connection with the use or performance of the product or damages with respect to any economic loss, loss of property, loss of revenues or profits, loss of enjoyment or use, costs of removal, installation or other consequential damages of whatsoever nature. Some states do not allow the exclusion or limitation of incidental or consequential damages. Accordingly, the above limitation may not apply to you.

The warranty extended hereunder is in lieu of any and all other warranties and any implied warranties of merchantability or fitness for a particular purpose is limited in its scope and duration to the terms set forth herein. Some states do not allow limitations on how long an implied warranty lasts. Accordingly, the above limitation may not apply to you.

This warranty gives you specific legal rights. You may also have other rights which vary from state to state.

ICON HEALTH & FITNESS, INC., 1500 S. 1000 W., LOGAN, UT 84321-9813

PROFORM is a registered trademark of ICON Health & Fitness, Inc.

Important Precautions

WARNING: To reduce the risk of burns, fire, electric shock or serious injury to persons, read all important precautions before using the massage chair.

READ AND FOLLOW ALL INSTRUCTIONS

1. Read all precautions and instructions in this manual before using the massage chair.
2. It is the responsibility of the owner to ensure that all users of the massage chair are adequately informed of all precautions.

WARNING

To reduce the risk of burns, fire, electric shock, or injury to persons:

3. Never leave the massage chair unattended while it is plugged in.
4. Close supervision is necessary when the massage chair is used by, on or near invalids or disabled persons.
5. Keep children under the age of 12 away from the massage chair.
6. Use the massage chair only for its intended use as described in this manual.
7. Never operate the massage chair if it is not working properly, if it is damaged or if the power cord or plug is damaged. If any of these conditions exists, please call the toll-free telephone number on the front of this manual.
8. Keep the power cord away from heated surfaces.
9. Use the massage chair indoors. Never use the massage chair outdoors.
10. The massage chair is intended for home use only. Do not use the massage chair in a commercial, rental or institutional setting.

WARNING: Read all instructions before using this product. ICON assumes no responsibility for personal injury or property damage sustained by or through the use of this product.

DANGER

To reduce the risk of electric shock:

11. When connecting the power cord (see page 8), plug the power cord into a surge suppressor (not included) and plug the surge suppressor into a grounded circuit capable of carrying 15 or more amps. No other appliance should be on the same circuit. Do not use an extension cord.
12. Use only a single-outlet surge suppressor that is UL 1449 listed as a transient voltage surge suppressor (TVSS). The surge suppressor must have a UL suppressed voltage rating of 400 volts or less and a minimum surge dissipation of 450 joules. The surge suppressor must be electrically rated for 120 volts AC and 15 amps.
13. Keep the power cord and the surge suppressor away from heated surfaces.
14. Always turn off the hand control and unplug the power cord from the outlet immediately after using and before cleaning the massage chair.

DANGER

15. Keep pins and other sharp objects away from the massage chair.
16. Carefully examine the massage chair before each use. If there are any signs of deterioration, call the toll-free telephone number on the front of this manual.
17. Keep the massage chair dry, away from water and moisture.

SAVE THESE INSTRUCTIONS

Before You Begin

Congratulations for selecting the PROFORM® RESTORATION 3100 massage chair. The innovative RESTORATION 3100 massage chair is designed to melt away stress—relaxing you, stimulating circulation and reducing muscle fatigue—any time you choose. The convenient hand control allows you to choose upper-back, lower-back or whole-back massage. You can also choose between six massage programs.

For your benefit, read this manual carefully before using the massage chair. If you have additional questions, please call our Customer Service

Department toll-free at 1-800-999-3756, Monday through Friday, 6 a.m. until 6 p.m. Mountain Time (excluding holidays). To help us assist you, please note the product model number and serial number before calling. The model number is PFRX31071. The serial number can be found on a decal attached to the massage chair (see the front cover of this manual for the location).

Before assembling the massage chair, please look at the drawing below and familiarize yourself with the parts that are labeled.

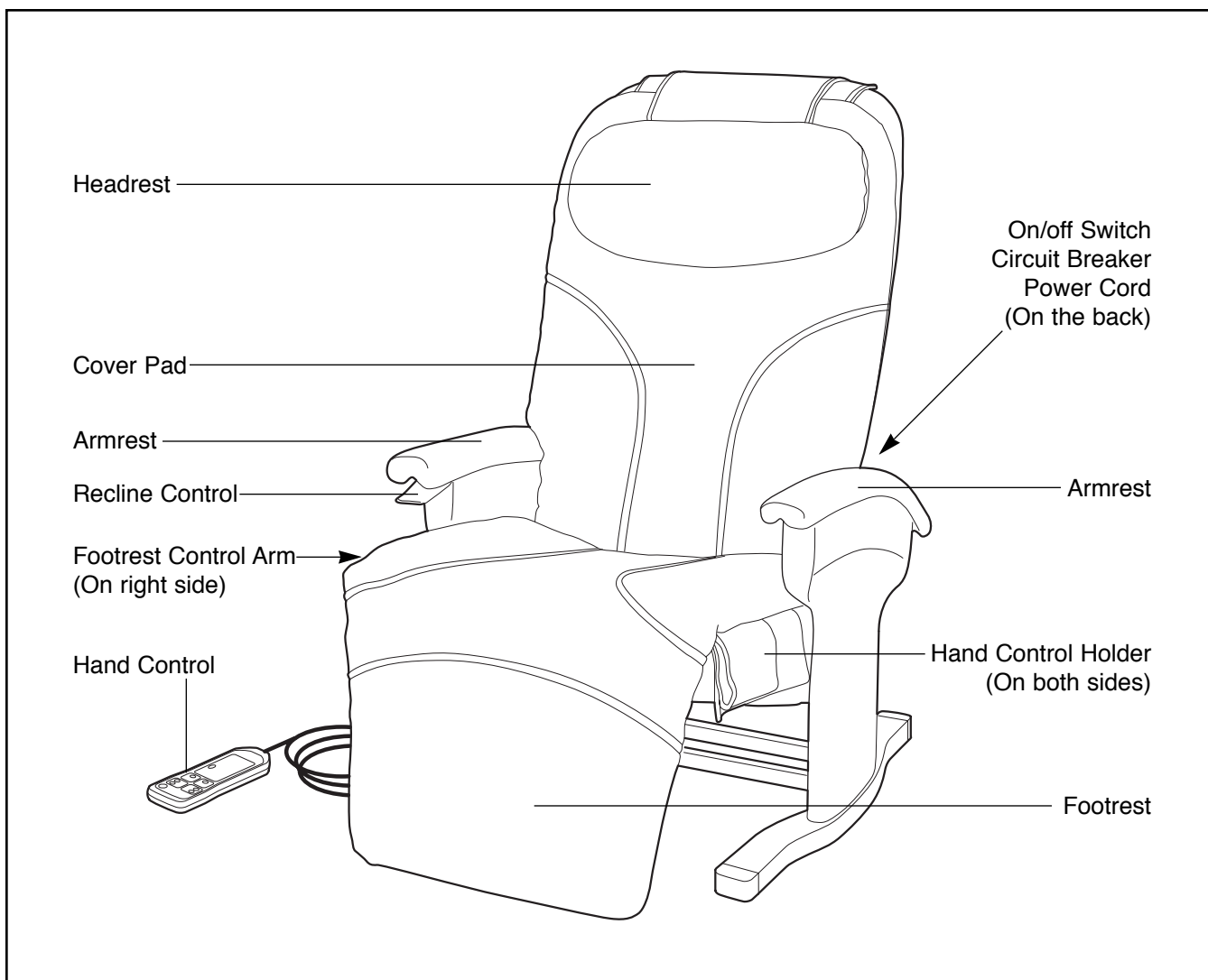

Assembly

Place all parts of the massage chair in a cleared area and remove the packing materials. Do not dispose of the packing materials until the massage chair is fully assembled. **Assembly requires only the included allen wrench.**

1. Feed the Recline Shock (20) and the attached cable between the tubes on the Base (1).

See the inset drawing. Remove the rubber bands from the screws in the Base (1). Be sure that the Arm Brackets (31) inside the tubes on the Base are pressed against the indicated sides of the tubes.

Align the posts on the Right Armrest (5) with the tubes on the Base (1). Slide the Right Armrest onto the Base. **Make sure the posts go inside the tubes on the Base. Make sure the cable is between the posts. Note: You may need to flex the posts away from the Right Side Shield (7) to assemble it past the Bracket Screws (see step 4) in the Base.**

2. Tip the chair onto its right side. Remove the shipping bracket from the Seat Frame (2) and the Back Frame (4) by removing the Cotter Pins (26) and Hairpin Cotters (27). **Save the Cotter Pins and Hairpin Cotters; you will need them for step 3.**

3. Attach the indicated end of the Recline Shock (20) to the Back Frame (4) with a Cotter Pin (26) and a Hairpin Cotter (27).

Attach the other end of the Recline Shock (20) to the Seat Frame (2) with a Cotter Pin (26) and a Hairpin Cotter (27). **Make sure that the cable is under the Recline Shock, as shown in the drawing. Note: You may need to raise the Back Frame (4) to the upright position in order to attach the Recline Shock.**

Lift the chair back onto its base.

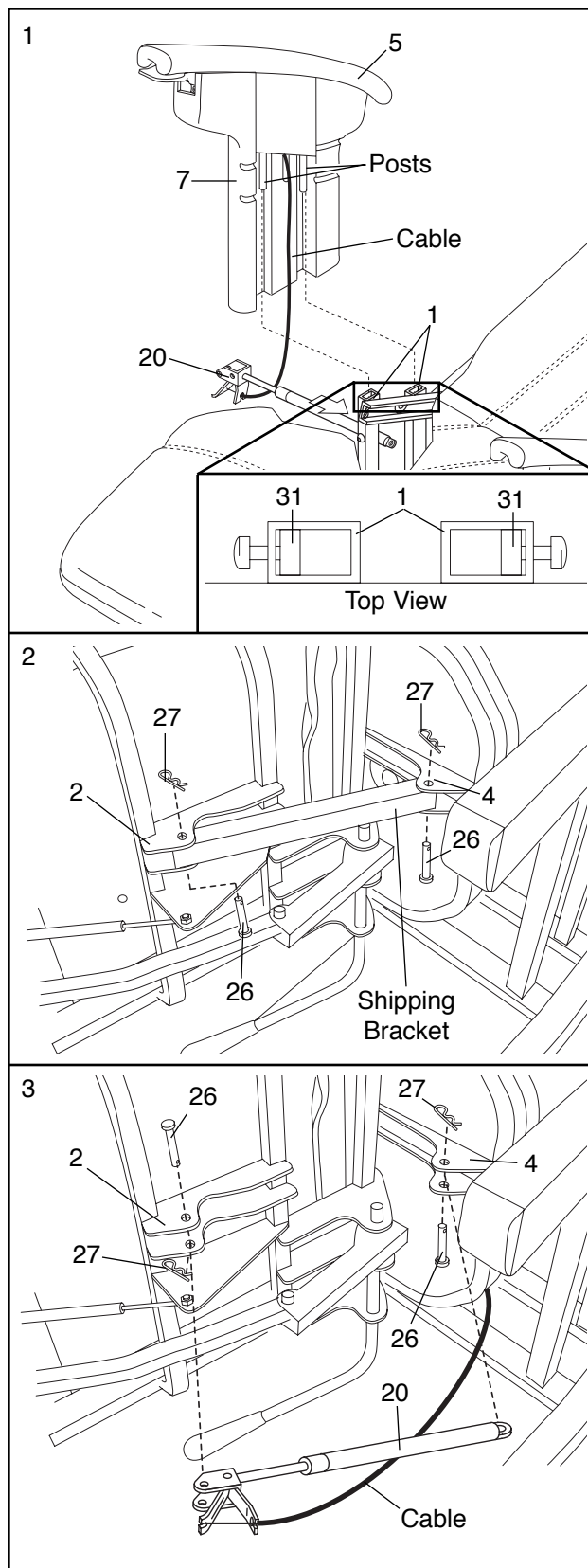

- See the inset drawing. Remove the rubber bands from the screws. Be sure that the Arm Brackets (31) inside the tubes on the left side of the Base (1) are pressed against the indicated sides of the tubes.

Align the posts on the Left Armrest (6) with the tubes on the Base (1). Slide the Left Armrest onto the Base. You may need to flex the posts away from the Left Side Shield (8) to assemble it past the Bracket Screws (32) in the Base.

Attach the Pillow (13) to the fastener strip.

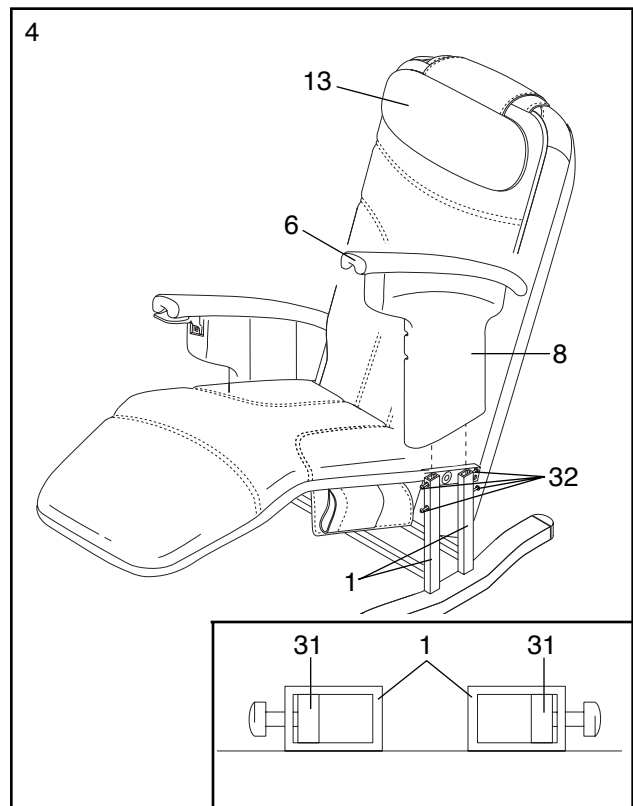

- Raise the footrest by pulling on the Footrest Control Arm (23, not shown). Attach the lower end of the Right Side Shield (7) to the right side of the Base (1) with two Arm Cover Screws (35) and two M6 Washers (95).

Attach the lower end of the Left Side Shield (not shown) in the same manner.

Using the included allen wrench, tighten the four Bracket Screws (32) in the right side of the Base (1).

Tighten the four Bracket Screws (not shown) in the left side of the Base in the same manner.

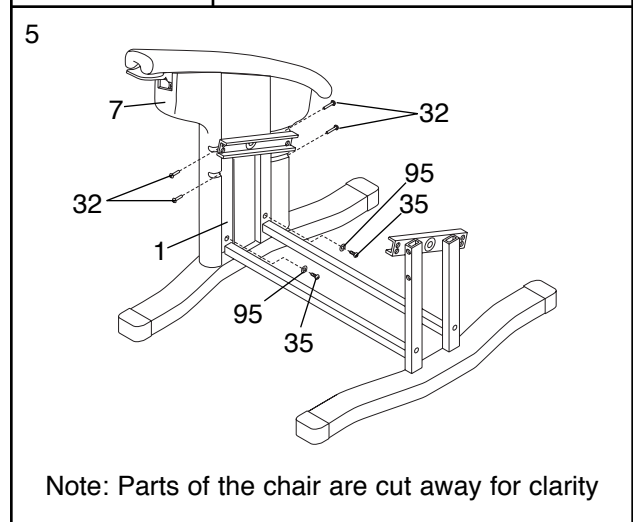

- Plug the cord from the Hand Control (22) into the socket on the back of the massage chair. **Be sure to align the indicated tabs.**

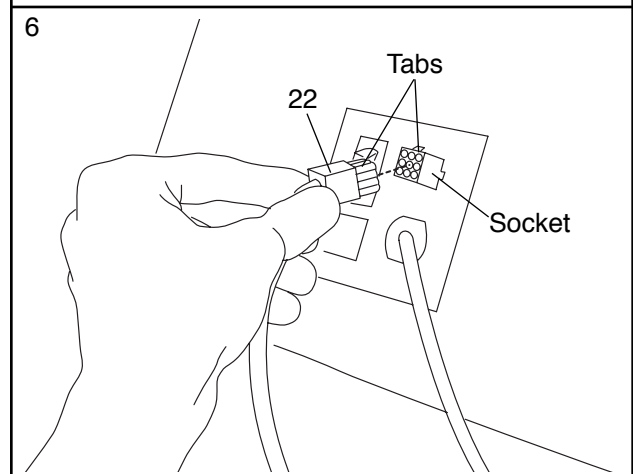

How to Operate the Massage Chair

HOW TO PLUG IN THE POWER CORD

⚠ DANGER: Improper connection of the equipment-grounding conductor can result in an increased risk of electric shock. Check with a qualified electrician or serviceman if you are in doubt as to whether the product is properly grounded. Do not modify the plug provided with the product—if it will not fit the outlet, have a proper outlet installed by a qualified electrician.

Your massage chair, like any other type of sophisticated electronic equipment, can be seriously damaged by sudden voltage changes in your home's power. Voltage surges, spikes, and noise interference can result from weather conditions or from other appliances being turned on or off. **To decrease the possibility of your massage chair being damaged, always use a surge suppressor with your massage chair (see drawing 1 below).**

Surge suppressors are sold at most hardware stores and department stores. Use only a single-outlet surge suppressor that is UL 1449 listed as a transient voltage surge suppressor (TVSS). The surge suppressor must have a UL suppressed voltage rating of 400 volts or less and a minimum surge dissipation of 450 joules. The surge suppressor must be electrically rated for 120 volts AC and 15 amps.

This product must be grounded. If it should malfunction or break down, grounding provides a path of least resistance for electric current to reduce the risk of electric shock. This product is equipped with a cord having an equipment-grounding conductor and a grounding plug. **Plug the power cord into a surge suppressor, and plug the surge suppressor into an appropriate outlet that is properly installed and grounded in accordance with all local codes and ordinances.**

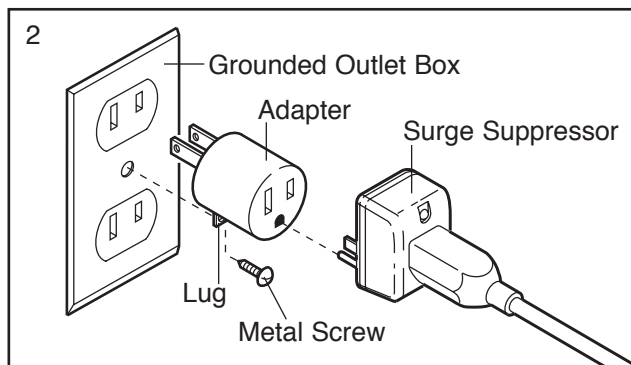
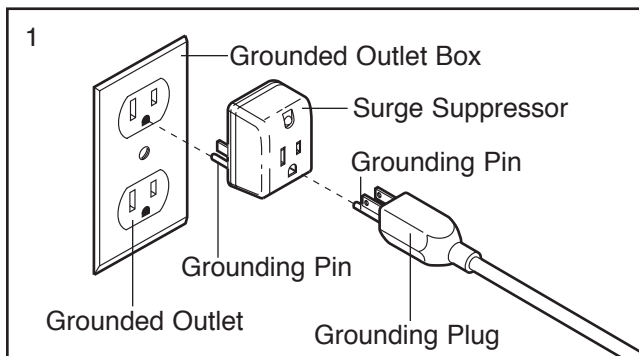

This product is for use on a nominal 120-volt circuit, and has a grounding plug that looks like the plug illustrated in drawing 1. A temporary adapter that looks like the adapter illustrated in drawing 2 may be used to connect the surge suppressor to a 2-pole receptacle as shown in drawing 2 if a properly grounded outlet is not available.

The temporary adapter should be used only until a properly grounded outlet (drawing 1) can be installed by a qualified electrician.

The green-colored rigid ear, lug or the like extending from the adapter must be connected to a permanent ground such as a properly grounded outlet box cover. Whenever the adapter is used it must be held in place by a metal screw. **Some 2-pole receptacle outlet box covers are not grounded. Contact a qualified electrician to determine if the outlet box cover is grounded before using an adapter.**

HOW TO TURN ON THE POWER

Make sure the power switch on the back of the chair is in the "on" position.

Next, press the power button on the hand control; an indicator will light. Note: If there is a thin sheet of plastic on the face of the hand control, remove it.

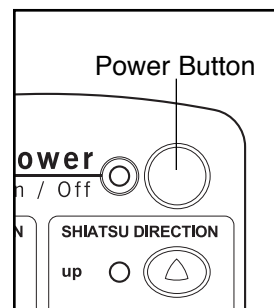

HOW TO TURN OFF THE POWER

To turn off the power, press the power button on the hand control. The power indicator will darken. Return the power switch on the back of the chair to the "off" position.

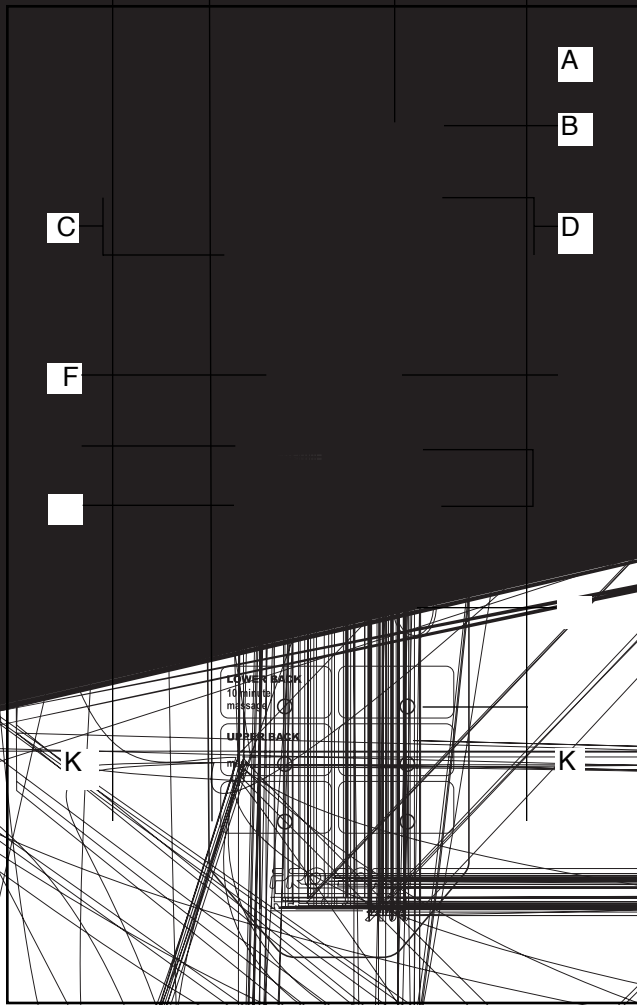

FEATURES OF THE MASSAGE CHAIR

The convenient hand control lets you customize the type of massage you get each time you use the massage chair. In the manual mode, you can choose any combination of upper-back, lower-back and whole back massage action. If desired, you can also position the massage carriage to target a specific area of your back for a specialized massage.

The control also offers several preset programs: 10-Minute Lower Back, 10-Minute Upper Back, 10-Minute Whole Back, 20-Minute Whole Back, 20-Minute Whole Back—Firm Massage and 20-Minute Whole Back—Hard Massage.

HOW TO USE THE MANUAL MODE

When the power is turned on, the hand control will be in the manual mode. The power indicator should be the only indicator that is lit.

1. Use the Carriage Position buttons to move the massage carriage to the location you wish to massage.
2. Use the Shiatsu Direction buttons to begin massaging your back. You may want to try alternating the shiatsu directions during your massage.
3. If you like, you can use the Carriage Position buttons to move the carriage up and down during the massage.

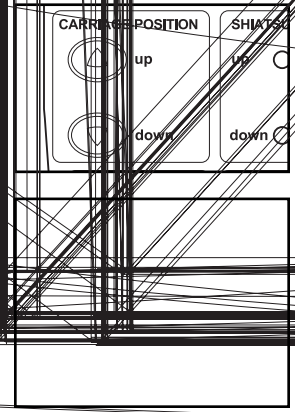

- A. Power Indicator—Lights when the power is on.
- B. Power Button—Turns the power on and off.
- C. Carriage Position Buttons—Manually move the massage mechanism up and down to target specific areas of the back for a localized massage.
- D. Shiatsu Direction Buttons and Indicators—These buttons control the rotational direction of the massage when the Carriage Position Buttons (C) are used.
- E. Back Zones Button and Whole, Lower, and Upper Indicators—The Back Zones button selects the three massage zones. When the “Whole” indicator is lit, the massage mechanism will move up and down, massaging your entire back. When the “Lower” indicator is lit, the massage mechanism will move up and down, massaging your lower back. When the “Upper” indicator is lit, the massage mechanism will move up and down, massaging your upper back.

HOW TO USE THE MESSAGE ZONES

The massage chair also features three massage zones: upper back, lower back and whole back. The massage zones are controlled with the Back Zones button.

1. Press the button once. The indicator above "whole" will light, activating the whole massage zone. Press the button again and the indicator above "lower" will light, activating the lower massage zone. Press the button again and the indicator above "upper" will light, activating the upper massage zone. Pressing the button again will end the massage. Press the button once more to reactivate the "whole" massage zone.

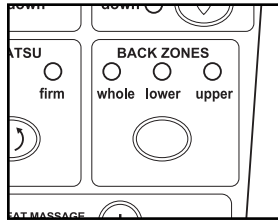

2. While you are using the massage zones, you can modify the intensity of the massage by using the Shiatsu button to select a soft or firm massage.

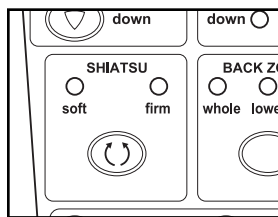

Note: The massage action will automatically stop if no buttons on the hand control are pressed for twenty minutes. This applies to both the manual mode and the message zones. To restart the massage action, simply press the power button on the hand control and select the desired massage option.

HOW TO USE THE VIBRATION ZONES

The massage chair features vibration zones for the seat and leg area. The vibration zones can be turned on and off by using the Seat Massage

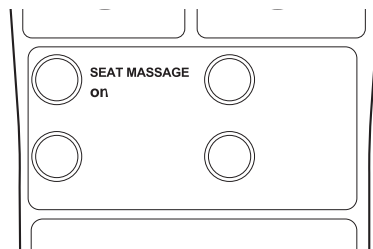

on/off and Leg Massage on/off buttons. You can regulate the intensity of the vibration zones by pressing the up and down buttons until you feel the desired intensity.

HOW TO USE THE MESSAGE PROGRAMS

In addition to the manual mode and message zones, the massage chair offers six message programs.

1. Press the Program button repeatedly to select the desired mode. A program indicator will light to show which program is selected. If the program you selected targets the lower back, the lower back zone indicator will also light. If the program you selected targets the upper back, the upper back zone indicator will also light. If the program you selected targets the whole back, the whole back zone indicator will also light.
2. Once you have selected a program, sit back, relax and enjoy the massage. You can change to a different program at any time.

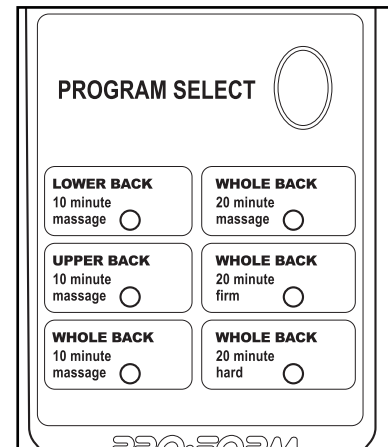

The message programs and their functions are:

LOWER BACK 1. This program offers a ten-minute lower back massage.

UPPER BACK 2. This program offers a ten-minute upper back massage.

WHOLE BACK 3. This program offers a ten-minute massage of your whole back.

WHOLE BACK 4. This program offers a twenty-minute massage of your whole back.

WHOLE BACK 5. This program offers a twenty-minute firm massage of your whole back.

WHOLE BACK 6. This program offers a twenty-minute hard massage of your whole back.

Note: If no buttons on the hand control are pressed while a program is running, the massage chair will shut off once the program is finished. To restart the massage action, simply press the power button on the hand control and select the desired message option.

HOW TO USE THE RECLINE CONTROL

To recline the chair, simply pull up on the recline control on the right armrest. Lean back in the chair until you have reached the desired position. Release the recline control.

To return the chair to the upright position, sit up in the chair and pull up on the recline control. The chair back will return to the upright position.

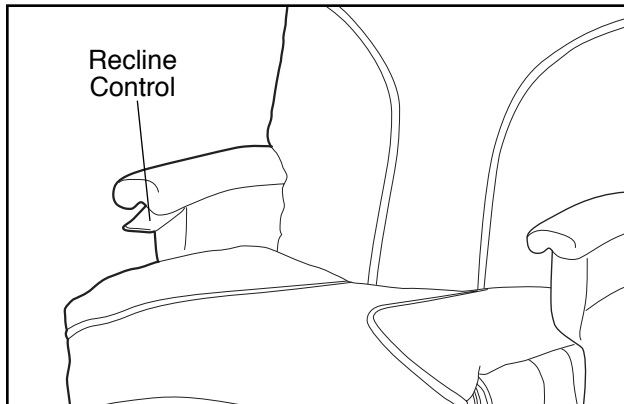

HOW TO USE THE FOOTREST

To extend the footrest, pull back on the footrest control arm on the right side of the chair, until you feel the control arm lock into place. The footrest will extend.

To lower the footrest, simply push the control arm forward.

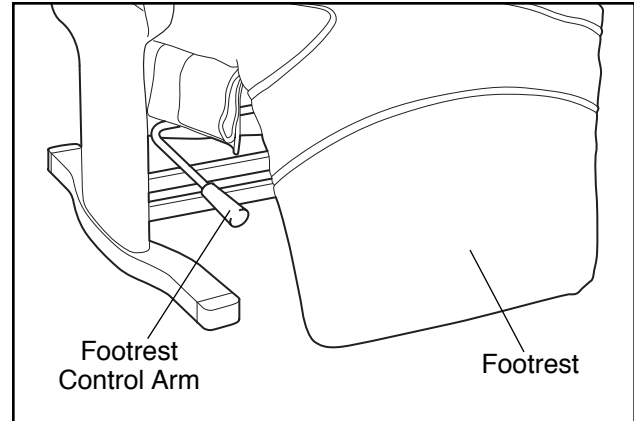

Maintenance

Check the massage chair periodically to make sure that all parts are properly tightened.

If the hand control does not function properly, check the following things:

- Is the power cord plugged into a 120-volt outlet?
- Is the power switch on the back of the chair in the "ON" position?

- Is the hand control properly connected to the massage chair? (See assembly step 6 on page 7.)

The massage chair can be cleaned with a low-power hand-held vacuum or a dry cloth. **IMPORTANT: Never use water or solvents to clean the massage chair.**

Ordering Replacement Parts

To order replacement parts, simply call our Customer Service Department toll-free at 1-800-999-3756, Monday through Friday, 6 a.m. until 6 p.m. Mountain Time (excluding holidays). To help us assist you, please be prepared to give the following information when calling:

- The MODEL NUMBER of the product (PFRX31071)
- The NAME of the product (PROFORM RESTORATION 3100 massage chair)
- The SERIAL NUMBER of the product (see the front cover of this manual)
- The KEY NUMBER and DESCRIPTION of the desired part(s) (see the PART LIST and EXPLODED DRAWING in the center of this manual).

Part List - Model No. PFRX31071

R0999A

Key No.	Qty.	Description	Key No.	Qty.	Description
1	1	Base	49	4	Massage Screw
2	1	Seat Frame	50	18	Roller Washer
3	1	Leg Frame	51	8	Roller Bolt
4	1	Back Frame	52	6	Roller Nut
5	1	Right Armrest	53	4	Spring Pin
6	1	Left Armrest	54	1	Circuit Board
7	1	Right Side Shield	55	4	Board Spacer
8	1	Left Side Shield	56	4	Board Nut
9	1	Right Panel	57	4	Board Screw
10	1	Left Panel	58	2	Flat-sided Washer
11	1	Seat Support	59	4	Brace Washer
12	10	Support Hook	60	4	Brace Nut
13	1	Pillow	61	2	Brace Screw
14	1	Cover Pad	62	6	Wire Tie
15	1	Chair Back Cover	63	2	Limit Switch
16	1	Cover	64	1	Four-wire Coil
17	1	Back Brace	65	2	Rear Wheel Axle
18	1	Back Cover	66	2	Jumper Wire
19	2	Front Endcap	67	1	Power Cord
20	1	Recline Shock	68	1	Power Switch
21	1	Shock Actuator	69	1	Fuse
22	1	Hand Control	70	2	Wire Mount
23	1	Footrest Control Arm	71	4	Bearing Screw
24	1	Leg Link	72	1	Sensor
25	1	Link Arm	73	6	Sensor Screw
26	6	Cotter Pin	74	6	Sensor Nut
27	6	Hairpin Cotter	75	1	Sensor Bracket
28	1	Shock Nut	76	1	Motor
29	3	Set Screw	77	1	Fan
30	2	Seat Pin	78	1	Drive Capacitor
31	4	Arm Bracket	79	1	Belt
32	10	Bracket Screw	80	4	Star Washer
33	4	Arm Screw	81	4	Motor Washer
34	4	Arm Washer	82	4	Motor Screw
35	4	Arm Cover Screw	83	1	Lift Assist Shock
36	4	Pad Frame Screw	84	4	Endcap Screw
37	4	Back Cover Screw	85	2	Rear Endcap
38	2	Straight Massage Arm	86	2	Long Massage Spring
39	2	Rear Wheel	87	2	Seat Frame Endcap
40	4	Short Massage Spacer	88	1	Sensor Wire
41	4	Long Massage Spacer	89	1	Shiatsu Capacitor
42	4	Massage Motor Nut	90	1	Cover Bracket
43	1	Massage Motor	91	1	Upper Switch Cover Bracket
44	2	Roll Pin	92	1	Lower Switch Cover Bracket
45	2	Short Massage Spring	93	3	Tec Screw
46	1	Right Bent Massage Arm	94	2	M8 Nut
47	1	Left Bent Massage Arm	95	4	M6 Washer
48	4	Massage Roller	#	1	User's Manual

Note: “#” indicates a non-illustrated part. Specifications are subject to change without notice. To order replacement parts, see the back cover of this manual.

Free Manuals Download Website

<http://myh66.com>

<http://usermanuals.us>

<http://www.somanuals.com>

<http://www.4manuals.cc>

<http://www.manual-lib.com>

<http://www.404manual.com>

<http://www.luxmanual.com>

<http://aubethermostatmanual.com>

Golf course search by state

<http://golfingnear.com>

Email search by domain

<http://emailbydomain.com>

Auto manuals search

<http://auto.somanuals.com>

TV manuals search

<http://tv.somanuals.com>