



ROHDE&SCHWARZ

User Manual

VOR/ILS Analyzer EVS200

0796.1800.02



0798.1988.12-08



ROHDE & SCHWARZ

VOR/ILS Analyzer EVS200

Issue: 01.2002

Version: E8

©

Copying of this document as well as any other utilization and communication of its content are only admissible with the permission of the originator or other authorized persons.

Any disregard will be prosecuted and is subject to restitution (UrhG, UWG, BGB). For the case a patent is issued or the design is officially registered all rights are reserved.

ROHDE & SCHWARZ GmbH & Co. KG

Werk Köln

D-51147 Köln · Graf-Zeppelin-Straße 18

Telefon: (02203) 49-0 · Int. +49220349-0

Telefax: (02203) 49-51364

Telex: 8874525

Printed in Federal Republic of Germany · Subject to change · Data without tolerances: order of magnitude only

0102

0798.1988.12-08



Certificate No.: **0201**

This is to certify that

Equipment type: **EVS200**

Designation: **VOR/ILS Analyzer**

Order No.: **796.1800.02**

complies with the provisions of the Directive of the Council of the European Union on the approximation of the laws of the Member States

- relating to electrical equipment for use within defined voltage limits (73/23/EEC revised by 93/68/EEC)
- relating to electromagnetic compatibility (89/336/EEC revised by 91/263/EEC, 92/31/EEC, 93/68/EEC)

Conformity is proven by compliance with the following standards:

- EN61010-1 : 1994 + A2 : 1996 + A2Ber : 1998 + Ber1 : 1998
- EN50081-1 : 1992
- EN50082-1 : 1992

Affixing the EC conformity mark as from 2002-01

Cologne, 2002-01-17







ROHDE & SCHWARZ GmbH & Co. KG
Werk Köln
Graf-Zeppelin-Str. 18, D-51147 Cologne
Quality management 5C-Q / Norres

Safety Instructions

This unit has been designed and tested in accordance with the EC Certificate of Conformity and has left the manufacturer's plant in a condition fully complying with safety standards.

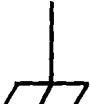
To maintain this condition and to ensure safe operation, the user must observe all instructions and warnings given in this operating manual.

Safety-related symbols used on equipment and documentation from R&S:

							
Observe operating instructions	Weight indication for units >18 kg	PE terminal	Ground terminal	Danger! Shock hazard	Warning! Hot surfaces	Ground	Attention! Electrostatic sensitive devices require special care

- The unit may be used only in the operating conditions and positions specified by the manufacturer. Unless otherwise agreed, the following applies to R&S products:
Pollution severity 2, overvoltage category 2, IP degree of protection 2X, altitude max. 2000 m.
The unit may be operated only from supply networks fused with max. 16 A.
- For measurements in circuits with voltages $V_{rms} > 30$ V, suitable measures should be taken to avoid any hazards.
(using, for example, appropriate measuring equipment, fusing, current limiting, electrical separation, insulation).
- If the unit is to be permanently wired, the PE terminal of the unit must first be connected to the PE conductor on site before any other connections are made (installation and cabling of the unit to be performed only by qualified technical personnel).
- For permanently installed units without built-in fuses, circuit breakers or similar protective devices, the supply circuit must be fused such as to provide suitable protection for the users and equipment.
- Prior to switching on the unit, it must be ensured that the nominal voltage set on the unit matches the nominal voltage of the AC supply network.
If a different voltage is to be set, the power fuse of the unit may have to be changed accordingly.
- Units of protection class I with disconnectible AC supply cable and appliance connector may be operated only from a power socket with earthing contact and with the PE conductor connected.
- It is not permissible to interrupt the PE conductor intentionally, neither in the incoming cable nor on the unit itself as this may cause the unit to become electrically hazardous.
Any extension lines or multiple socket outlets used must be checked for compliance with relevant safety standards at regular intervals.
- If the unit has no power switch for disconnection from the AC supply, the plug of the connecting cable is regarded as the disconnecting device. In such cases it must be ensured that the power plug is easily reachable and accessible at all times (length of connecting cable approx. 2 m). Functional or electronic switches are not suitable for providing disconnection from the AC supply.
If units without power switches are integrated in racks or systems, a disconnecting device must be provided at system level.
- Applicable local or national safety regulations and rules for the prevention of accidents must be observed in all work performed.
Prior to performing any work on the unit or opening the unit, the latter must be disconnected from the supply network.
Any adjustments, replacements of parts, maintenance or repair may be carried out only by authorized R&S technical personnel.
Only original parts may be used for replacing parts relevant to safety (eg power switches, power transformers, fuses). A safety test must be performed after each replacement of parts relevant to safety.
(visual inspection, PE conductor test, insulation-resistance, leakage-current measurement, functional test).

continued overleaf

Safety Instructions

Ensure that the connections with information technology equipment comply with IEC950/EN60950.

11. Lithium batteries must not be exposed to high temperatures or fire.

Keep batteries away from children.

If the battery is replaced improperly, there is danger of explosion. Only replace the battery by R&S type (see spare part list)

Lithium batteries are suitable for environmentally-friendly disposal or specialized recycling. Dispose them into appropriate containers, only.

Do not short-circuit the battery.

12. Equipment returned or sent in for repair must be packed in the original packing or in packing with electrostatic and mechanical protection.
13. Electrostatics via the connectors may damage the equipment. For the safe handling and operation of the equipment, appropriate measures against electrostatics should be implemented.
14. Any additional safety instructions given in this manual are also to be observed.

Contents

<u>Chapter</u>	<u>Page</u>
1. Operator Information	
- Important operator information	1
- Unpacking	2
- Application of the unit	3
- Characteristics of the unit	4
- Unit layout frontview	5
- Unit layout rearview	6
 2. Preparation for Operation	
- Placing the unit	7
- Mains operation	7
- Mains connection	7
- DC connection	8
- Assembling the FO Cable Jack	8
- Finishing and connection to the Vehicle Board Supply	8
- Connection of Signal/Control Inputs/Outputs	9
- Antenna connection	9
- AF OUT	9
- RS-232-Interface	9
- External AF input	10
- DSP output	10
 3. Operation	
- Switch On/switch Off the unit at mains supply	11
- Switch On/switch Off the unit at VDC supply	11
- Switch on procedure	11
- Selftest (BITE)	12
- Battery operation	12
- Operation of the unit	13
- General operating instructions of the VOR/ILS Analyzer EVS200	13
- SETUP-Mode	14
- Operating instructions of SETUP-Mode	15

<u>Chapter</u>	<u>Page</u>
- ILS-Mode	16
- Operating instructions of ILS-Mode	16
- Operating instructions of Y / t setup menu	17
- Operating instructions of STORE DDM menu	18
- Signal parameters on ILS Display	20
- VOR-Mode	21
- Operating instructions of VOR-Mode	21
- Signal parameters on VOR Display	22
- BEACON-Mode	23
- Operating instructions of BEACON-Mode	23
- Signal parameters on BEACON Display	24
- Δ LEVEL-Mode	25
- Operating instructions of Δ Level-Mode	25
- Storing and recalling reference levels	26
- Signal parameters on Δ Level Display	28
- SPECTRUM-Mode	29
- Operating instructions of Spectrum-Mode	29
- RS-232-Interface operation	30
- COM-Parameter	30
- Handshake	30
- Control commands	30
- Unit related control commands	31
- Mode related control commands	35
- ILS-Mode	35
- VOR-Mode	44
- Δ Level-Mode	49
- Beacon-Mode	50
4. Interfaces	
- Antenna input	53
- AF output	53
- Headphone connection	53
- XY-Tracer connection	53
- External AF input	54
- RS-232-Interface	54
- External VDC connection	54
- Mains connection	54

<u>Chapter</u>	<u>Page</u>
5. Service	
- Service	55
- Warranty	55
6. Technical Specification	
- Technical data	56
- General data	58
- Accessories	59

Important operator information

The symbols used in this description have the following meaning.



Attention: increased vigilance!



Indexfinger: indicates important details



Workstep, alphanumeric sequence definition of a workstep!



Before connecting the unit to a vehicle's 12-VDC board supply, pay attention that the battery's negative pole is connected to ground (GROUND \oplus) of the vehicle!

Finishing and connection of the auxiliary FO cable jack is described in chapter „VDC connection" in section 2 "Preparation for Operating".



Whilst time of warranty a defective internal battery (option) may only be changed by Rohde & Schwarz service personnel!



Also after the warranty time it is recommended that only specialists change the internal battery.

Unpacking

1. Unpack the **VOR/ILS Analyzer EVS200**.
2. Remove the protective covers.
3. Inspect the unit for evident damage (visual check).
4. Check the auxiliary accessory!
 - **FO-cabel jack (0018.6700.00)**
 - **power cable**
 - **operating instructions (0798.1988.12-07)**



Keep the packing material for reusing!

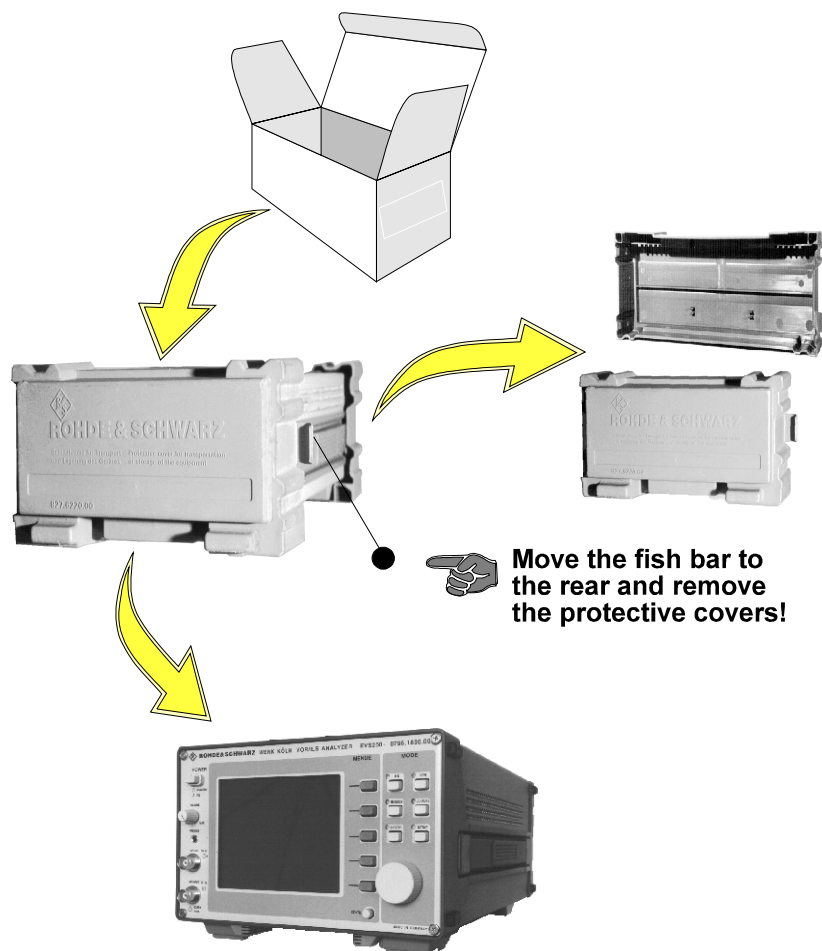

Application of the unit



The **VOR/ILS Analyzer EVS200** is used for checking terrestrial radio navigation facilities at airports. Following components of ILS- and VOR-systems can be checked:

- approach to land ILS (Instrument Landing System)
 - direction localizer LLZ (Localizer) 108 to 118 MHz
 - glideslope system GS (Glideslope) 320 to 340 MHz
 - OM (Outer Marker) 75 MHz
 - MM (Middle Marker) 75 MHz
 - IM (Inner Marker) 75 MHz

- short and medium range navigation
 - VOR (VHF Omni Range) omnidirectional beacon 108 to 118 MHz

The following measurements can be carried out:

- DDM (indication also in 1 / μ A / %), SDM, modulation factor
- absolute level
- delta level (Δ level)
- VOR parameter
- ILS parameter
- 75-MHz beacon parameter

Ranges for measurements are e.g:

- dynamic runway surveying (limited through high measurement speed (90 measurements/s))
- static distant field surveying
- function monitoring of transmitting field stations with data tele-transmitting
- surveying of transmitting antenna characteristics through " **Δ level-mode**"
- Clearance & Glidepath (common parameter analysis **without** disconnecting the transmitting station)
- measuring and evaluating of corresponding parameters at high interference intensity

Due to versatile power supply facilities the **VOR/ILS Analyzer EVS200** is suitable for operation in field (battery supply), in vehicles (12-V board supply), and in the lab (AC supply). Among others it is possible to remote control the unit via the RS-232-Interface and recalling all obtained data. Further more the corresponding parameters of the DSP can be taken at the multifunction output (DSP OUT) for further analysis (e.g. XY-tracer).

Characteristics of the unit



Remarkable characteristics of the **VOR/ILS Analyzer EVS200** are:

- high accuracy
- easy handling
- low power consumption
- very compact and light design for mobile operation
- battery operation (option) for mobile operation
- external DC operation for mobile operation
- remote control through RS-232-Interface
- selftest facility (BITE)
- digital signal processing (DSP) on ILS and VOR analysis
- high rapidity of measurement (ILS = **90** measurements/s)
- immediately display of all measurement data
- DDM-/SDM-measurements
- calibration of Y / t recorder (DDM = 0)
- Δ level measurements (**4** reference levels can be stored)
- installed loudspeaker and headphone output
- suitable for 19" rack assembly

Unit layout frontview

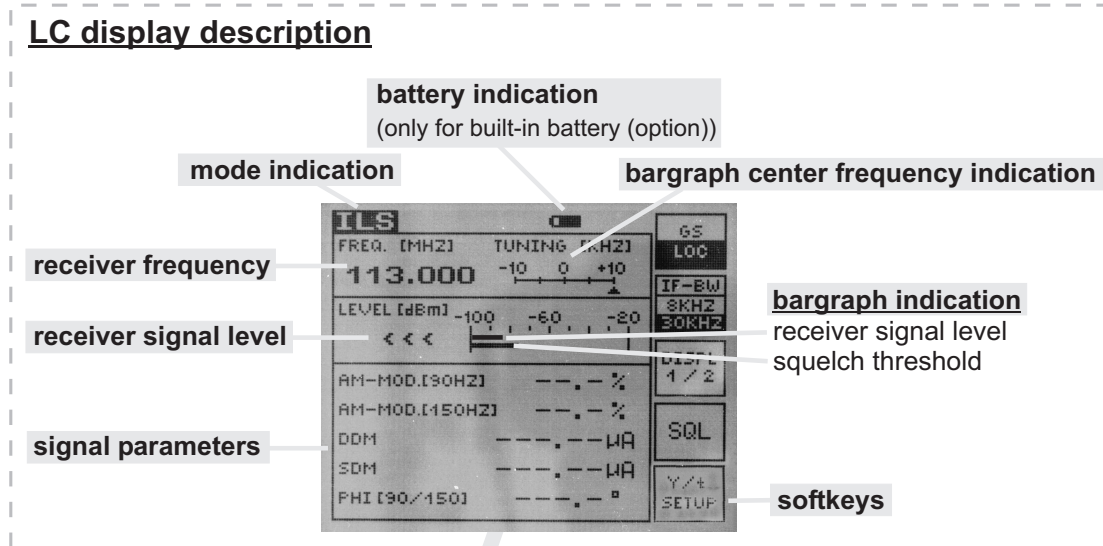

LC display
(illuminated dot matrix display)

POWER
Set the unit into operation, on mains supply and in position "Standby" the installed battery (Option) will be charged.

volume control
With the potentiometer "Volume" the loudspeaker's and headphone's volume can be set.

headphone connector
⚠ only for connecting headphones with soundproofing!
e.g. R&S order no.0708.9010.00

AF output
BNC socket
output level: 200 mV_{rms} / 50 Ω
by 50 % AM part

antenna input
BNC socket
input level: max. +15 dBm / 50 Ω
VSWR: <1.5

contrast control
adjustment of display contrast

Softkeys
Softkeys (program dependent functional keys) are allocated to the conforming operation mode. The softkey function is indicated on the display.
⤵ **On the display all active modes are sensitive (grey background)!**

mode keys
The mode keys select the corresponding measurement and setting mode which will be indicated by the yellow LED.
A selected mode will be indicated on the display. Mode settings will be performed with the softkeys.

rollkey
On principle all possible menu settings will be performed with the rollkey.
An exception is the "Setup-Menu" where settings must be performed with the designated softkeys.
turning direction ↻ for increasing values
turning direction ↺ for decreasing values

frequency setting

The frequency changes depending on the rollkey's turning speed in following steps:

- turn rollkey slow ⇒ 5-kHz-steps (depending upon the setup-settings)
- turn rollkey fast ⇒ 100-kHz-steps

⚠ **Rollkey operation is only possible when "VAR-LOCK" function is switched off!**

Unit layout rearview

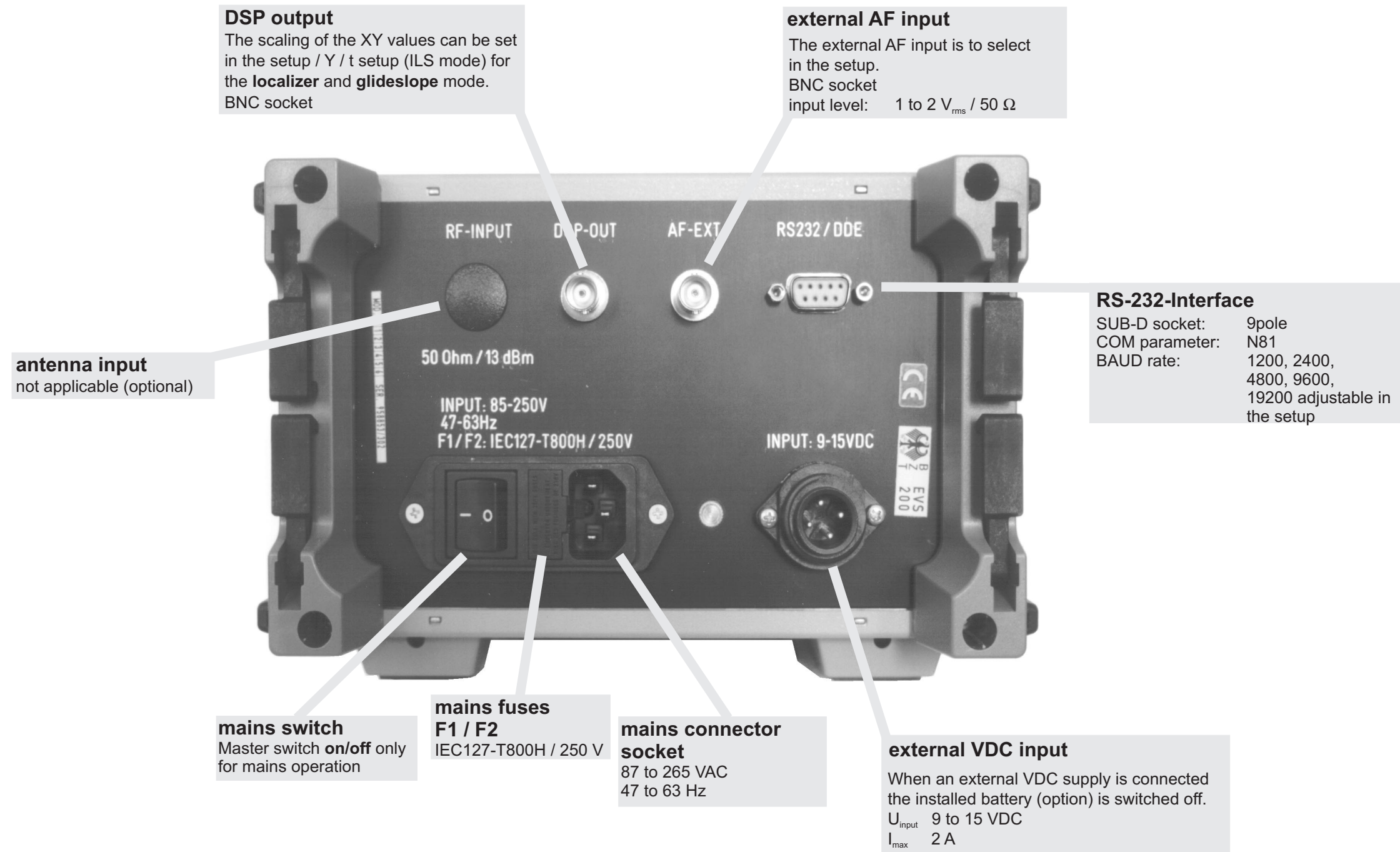

Preparation for operation

Placing the unit

The **VOR/ILS Analyzer EVS200** can be operated in any position without reduction in its function. Even shocks during normal transportation or on mobile operation don't reduce its function.

The unit works at ambient temperatures of -5 to +40°C.

Mains operation

Safety Rules

The **VOR/ILS Analyzer EVS200** meets the safety rules in agreement with VDE 0411 and VDE 0804 of safety class I. In agreement with safety class I all mains circuitry must be insulated and the requirement is a good conductive and durable together and ground wire connection of all touchable, conductive parts of the unit which can directly be alive in case of a failure.



Mains connector (earthed plug) put only into a protective contact socket. If there is a connector it must durable be connected with a ground wire. The ground wire must not be insulated.

Mains connection

Connect the **VOR/ILS Analyzer EVS200** with the supplied power cord to the AC supply (87 to 265 VAC / 47 to 63 Hz or corresponding to the technical data).

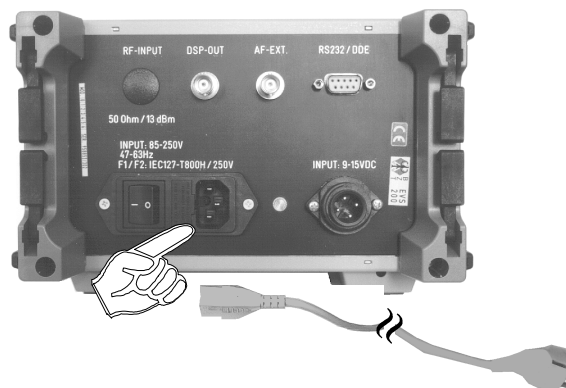

If the unit shall be connected to another AC supply the corresponding safety rules must be observed!

DC connection



**Only connect the unit when the minus pole of the battery is connected to vehicles ground (GROUND ⊕)!
input voltage: 9 to 15 VDC**

Assembling the FO Cable Jack

Finish the supplied FO cable jack (0018.6700) as following with commercial PVC cables.

cable specification

PVC wiring performance according VDE 0281
wire cross section **1.0 mm²** or more
colour **RED** for +VDC
colour **BLUE** for ground(⊕)

FO cable jack

order no.: 0018.6700



Pin connection of the FO cable jack

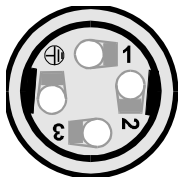

PIN 1 - +12 VDC
PIN 2 - nc
PIN 3 - Ground
PIN 4 - Ground ⊕

Assembling the FO cable jack

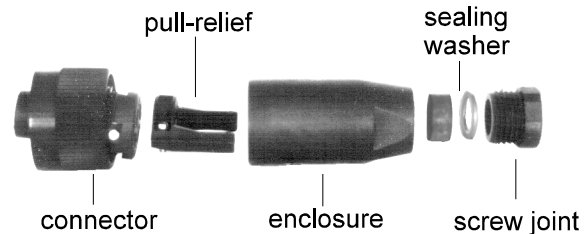

Finishing and connection to the Vehicle Board Supply

- ❶ Strip the cable end ca. **8 mm** and mount multicore.
Draw the cable through the enclosure and connect it according to the above pin connection of the FO cable jack.
Fit the pull-relief and assemble the FO cable jack.
Connect the cable to the vehicle board supply.



When connecting the finished cable to the 12-VDC vehicle board supply there is to perform a protection by a cable fuse (T2.0 A) or a fuse on board!

Connect and lock the FO cable jack in the VDC input at the rear of the unit.

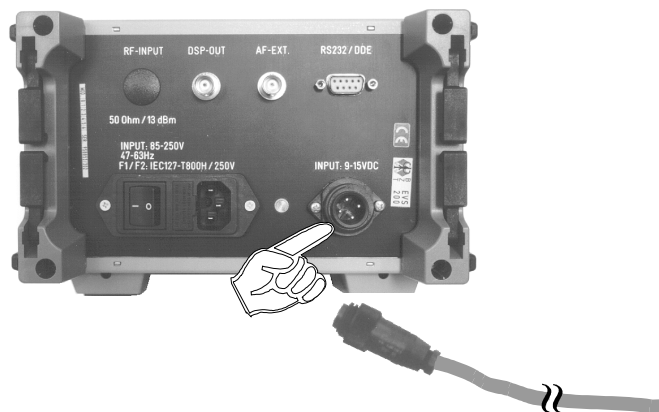

Chapter 2: Preparation for Operation

External AF input

Via the **AF input** (AF-EXT) at the rear side the unit can be fed with an AF signal for further analysis of typical AF parameters (e.g. level, frequency). This is very applicable for receivers which cannot perform AF analysis.

input level: approx.: 1 to 2 V_{rms} / 50 Ω
 e.g. **VOR/ILS Analyzer** \Rightarrow external receiver

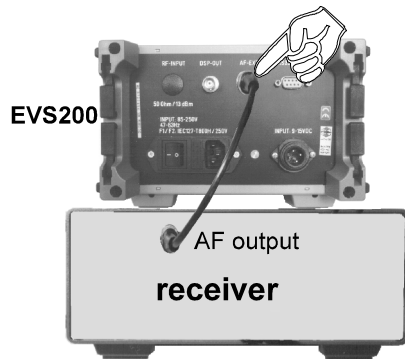

Connection **AF-EXT** of the VOR/ILS Analyzer EVS200 with the AF output of an external receiver

DSP output

On the DSP-OUT at the rearside e.g. a XY-tracer can be connected. The scaling of the XY values can be set for any mode (localizer/glideslope) in the setup (**DDM Y / t-RANGE**) or in ILS-Mode (**Y / t-SETUP**).

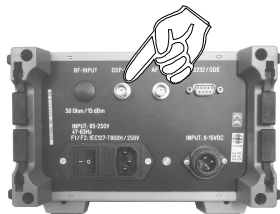

output signals in VOR- and ILS-Mode:

	ILS-Mode	VOR-Mode
Display 1	normalized DDM-values (DC-voltage) Range 1 to 4	no output
Display 2	voice-frequency (300 to 3000 Hz)	voice-frequency (300 to 3000 Hz)

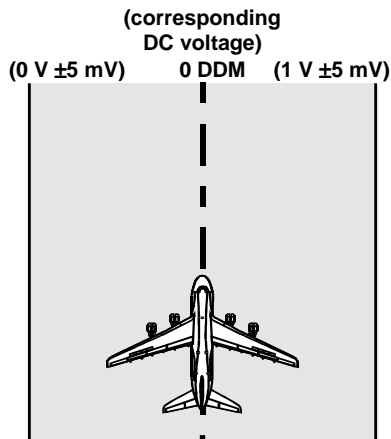

scaling in the setup:

	Localizer	Glideslope
Range 1	0.0 \pm 25% \triangleq 0 \pm 0.25 DDM	0.0 \pm 50% \triangleq 0.0 \pm 0.5 DDM
Range 2	0.0 \pm 2.5% \triangleq 0 \pm 0.025 DDM	0.0 \pm 5% \triangleq 0.0 \pm 0.05 DDM
Range 3	0.0 \pm 2.58% \triangleq 0.0 \pm 0.0258 DDM	8.75 \pm 5% \triangleq 0.0875 \pm 0.05 DDM
Range 4	0.0 \pm 50% \triangleq 0.0 \pm 0.5 DDM	17.5 \pm 5% \triangleq 0.175 \pm 0.05 DDM

Operation

Switch On/switch Off the unit at mains supply

- 1 With the mains switch at the rearside switch the unit **on** or **off**.

With the switch "POWER" at the front side switch the unit **on** or "STANDBY".

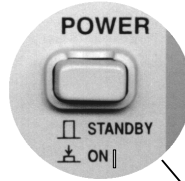

On switch position "STANDBY" the installed battery (option) will be charged. Details see item "Battery Operation" (page 12).

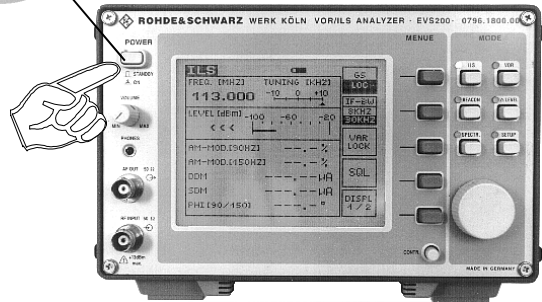

Switch On/switch Off the unit at VDC supply

When the unit is supplied from the **installed battery** (option) or through the **external DC input** it must be switched **on** or to "STANDBY" only with the Switch "POWER" at the frontside.



On external DC supply of the unit the installed battery (option) will not be charged!

Switch on procedure

During the switch on procedure the **VOR/ILS Analyzer EVS200** performs a selftest (BITE). The tested functions are indicated with "OK". This test takes approx. 5 s. After that automatically it is switched over to the startup mode which was set in the setup.



Because of the displayed battery voltage (U BATT) it is possible to value the charging state of the installed battery (option).

Malfunctions of the BITE will be indicated by "FAIL". In that case the unit does not switch over to the startup mode (see also item "Selftest").

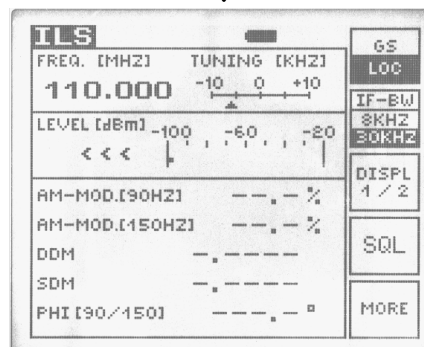
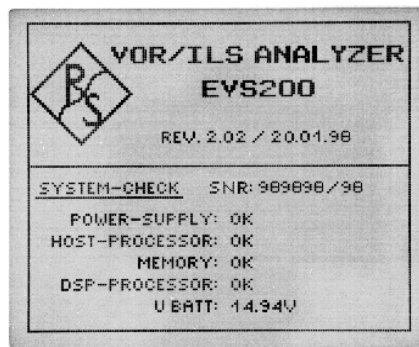

Selftest (BITE)

The selftest checks: all operating voltages,
host processor,
memory,
DSP processor.

In case of an error the determined functional unit will be indicated with a "FAIL". If the internal operating voltages totally fail or if they deviate extraordinary from the tolerances a selftest cannot be carried out.



Error:

In case of an error the unit generally should be switched off and after a few seconds it should be switched on again. If the error message is displayed again it is recommended to send the unit to the service, corresponding to Chapter 5 (Service).

Battery operation

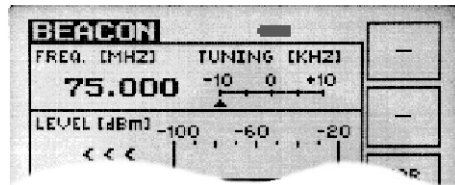

The battery operation of the **VOR/ILS Analyzer EVS200** is an optional component. It is always possible to retrofit the unit with this mode.

The unit automatically goes into battery operation when the external power supply (DC/AC) is switched or cut off. The battery operation is indicated on the display by the battery symbol () in each mode.



The operation time is **>100 minutes (max. brightness)** or **>150 minutes (at average brightness)** with a completely charged battery.

The charging state can be seen from the battery symbol on the display:

-  100% battery power
-  approx. 75 to 25% battery power
-  flashing symbol, approx. only **5** minutes operation is ensured. Battery must be charged.

The battery will be charged on **AC operation** (as well during operation as on "STANDBY") and should take at least **12 hours** (charging time).



After 4 to 5 years or when defect the battery must be changed according to Chapter 5 "Service".

Operation of the unit

Because of the many universal measuring functions of the VOR/ILS Analyzer EVS200 the operation has to be carried out according to the following instructions. Basically all measurement parameter settings are realized through **softkeys** and the **mode keys**. An activated **mode** is shown by a luminous LED (beside the belonging mode key). All important signal parameters are analyzed by the **DSP** (digital signal processor) and indicated on the display. Due to the variety of the analyzed parameters the indication in the **ILS** and **VOR** mode is subdivided into two display parts ("DISPL 1/2" and DISPL 2/2").



The RS-232-Interface operation of the VOR/ILS Analyzer EVS200 is described in section "Operating the VOR/ILS ANALYZER EVS200 via RS-232-Interface"

General operating instructions of the VOR/ILS Analyzer EVS200

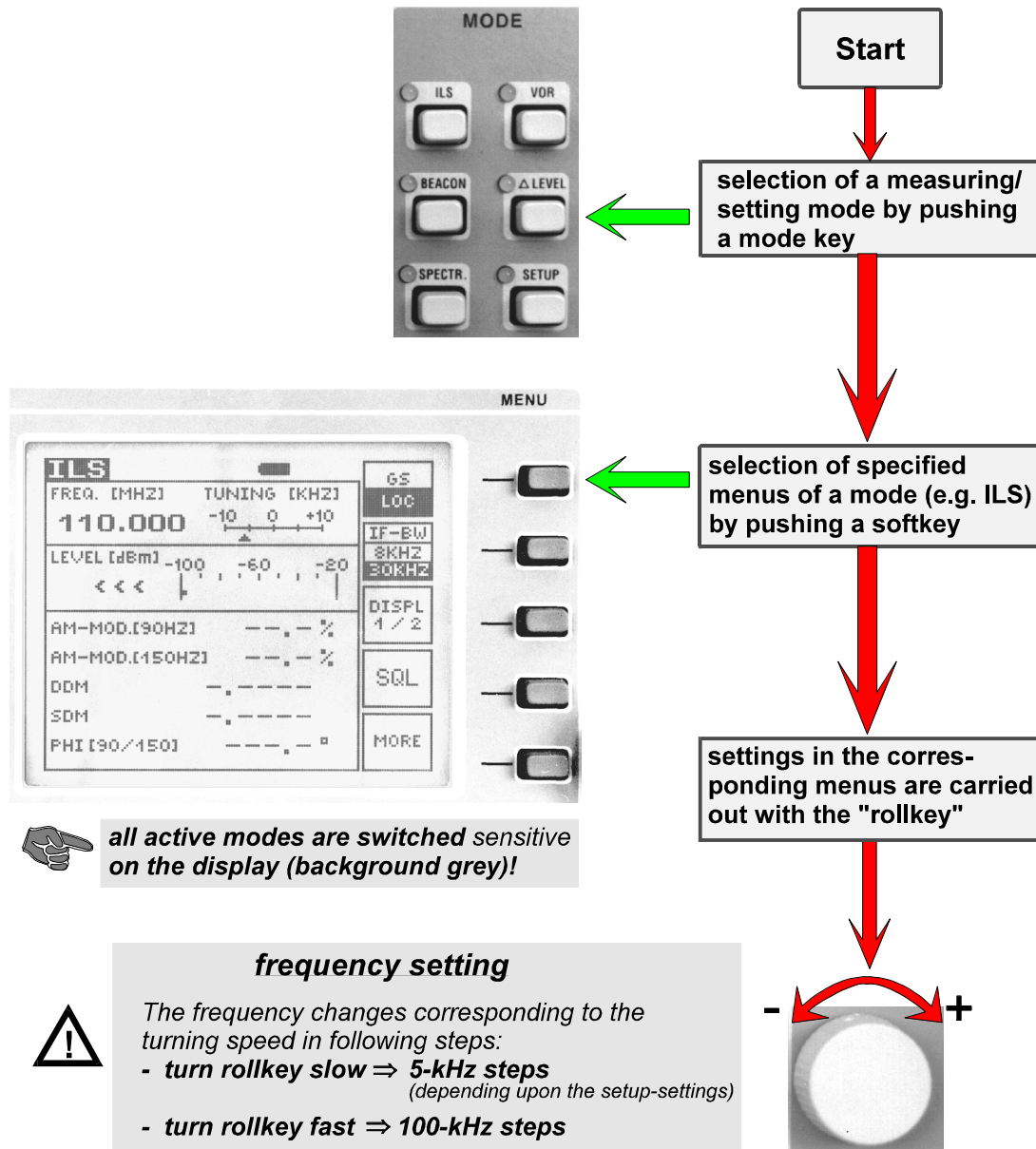



SETUP-Mode

In the following table all possible parameters are listed and its functions are described. Furthermore all possible setting values per parameter are shown. Next a sequence chart of the operating instructions in the **SETUP** mode is following.



Changes in the SETUP can be saved with the softkey "SAVE".

parameter	description	setting value
RS232 BAUDRATE	baud rate setting	1200, 2400, 4800, 9600, 19200
VOR ANGLE-RESOLUTION	BEARING-angle resolution	0,01° / 0,05°
DDM/SDM AVG-FACTOR	factor for determining the number of measurements which form the arithmetical average	1, 2, 4, 8, 16, 32, 64
DDM Y / t-RANGE [LOC]	XY value scaling in localizer mode at DSP-OUT (refer to page 10 DSP output)	RNG.1 to RNG.4
DDM Y / t-RANGE [GS]	XY value scaling in glideslope mode at DSP-OUT (refer to page 10)	RNG.1 to RNG.4
AF-INPUT-SOURCE	AF selection for valuation	INT = internal AF EXT = external AF via AF-EXT-input
STARTUP mode	startup mode setting at switching on the unit	VOR (VOR mode) ILS (ILS mode) BCN (Beacon mode) SPEC (Spectrum mode) LEVEL (Δ level mode)
SQUELCH	on/off switching squelch	ON / OFF
<p> setting valid for:</p> <ul style="list-style-type: none"> - Δ level mode - ILS mode - VOR mode <p>When the setting is "ON" an automatical quiet tuning is performed as soon as the threshold level < the receiver level is.</p> <p>When setting is "OFF" no quiet tuning will be performed.</p>		
DISPLAY ILLUM	display brightness setting	OFF ⇐ 1 to 6 ⇒ MAX
DDM/SDM DIMENSIONS	value of DDM/SDM indication	μA / % / 1 (1= value without dimension)
DISPLAY-INTERVALL	indication interval time	1 to 8
<p> setting is only valid for display indication.</p> <p style="text-align: center;"> $\frac{1 \quad \text{to} \quad 8}{\text{approx. } 0.4 \text{ s to approx. } 1.8 \text{ s}}$ </p>		
TUNING-STEP	tuning step rate setting	5 / 25 / 50 / 100 (kHz)

Operating instructions of SETUP-Mode

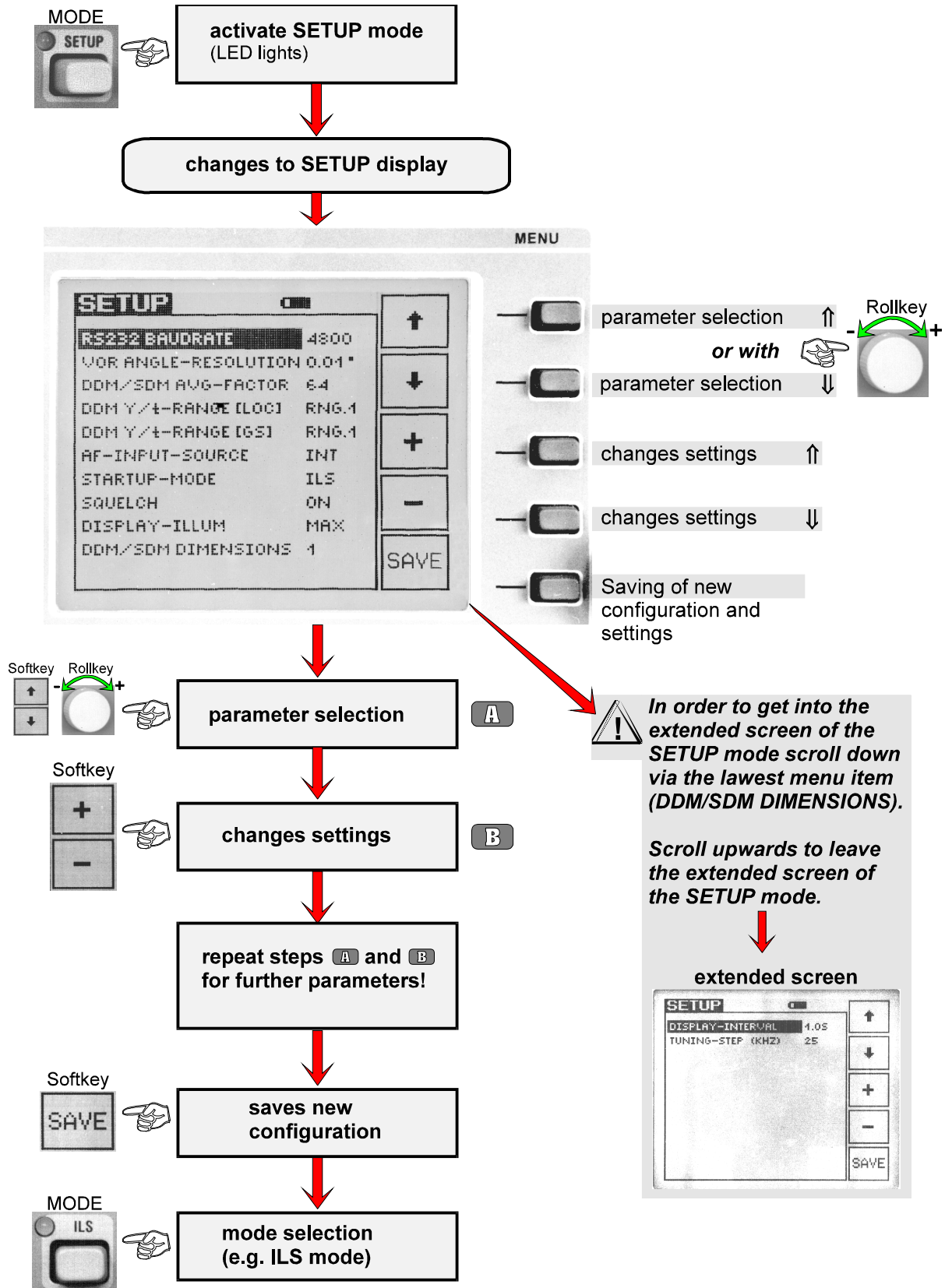

ILS-Mode

Operating instructions of ILS-Mode

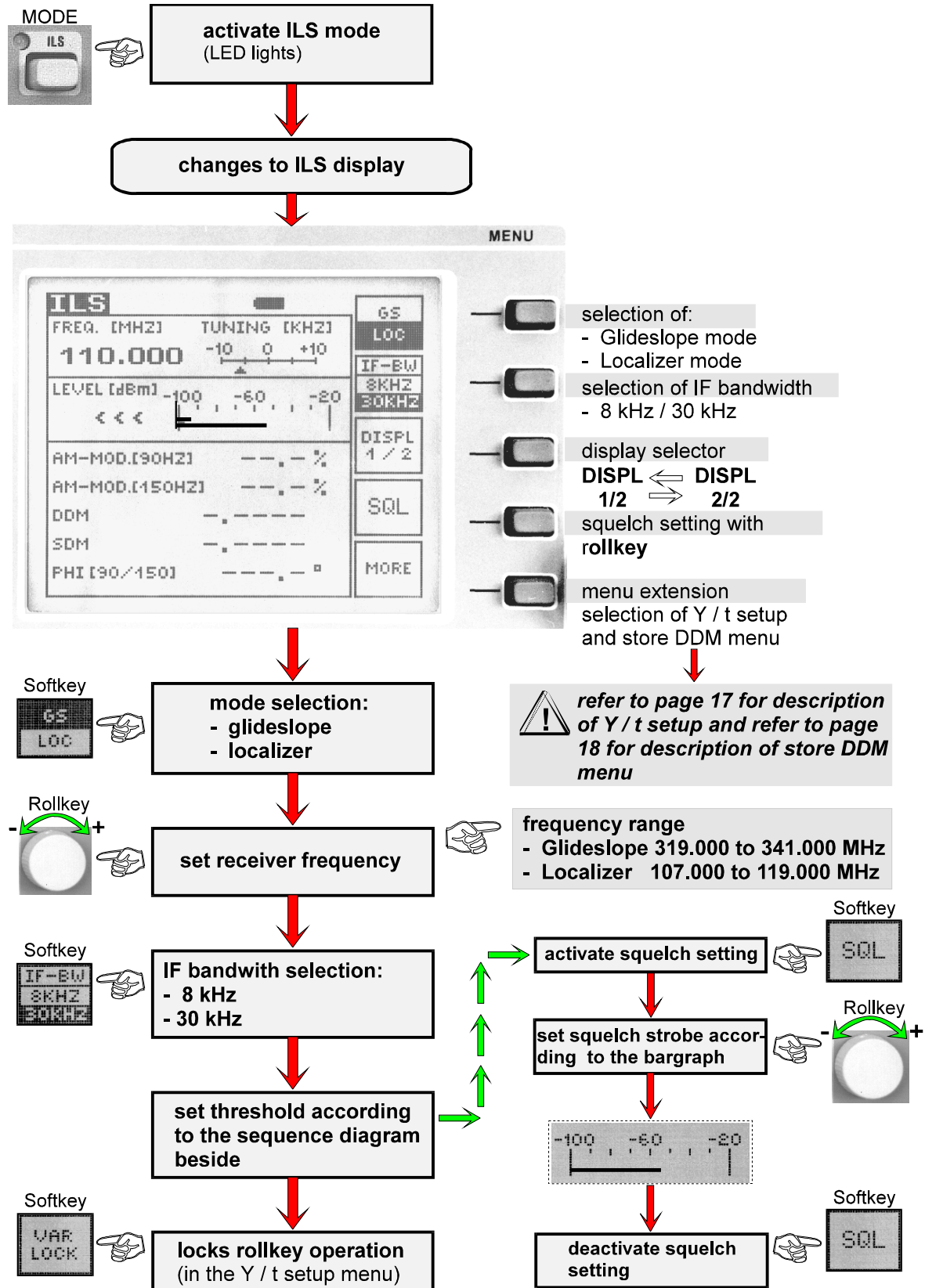

Operating instructions of Y / t setup menu

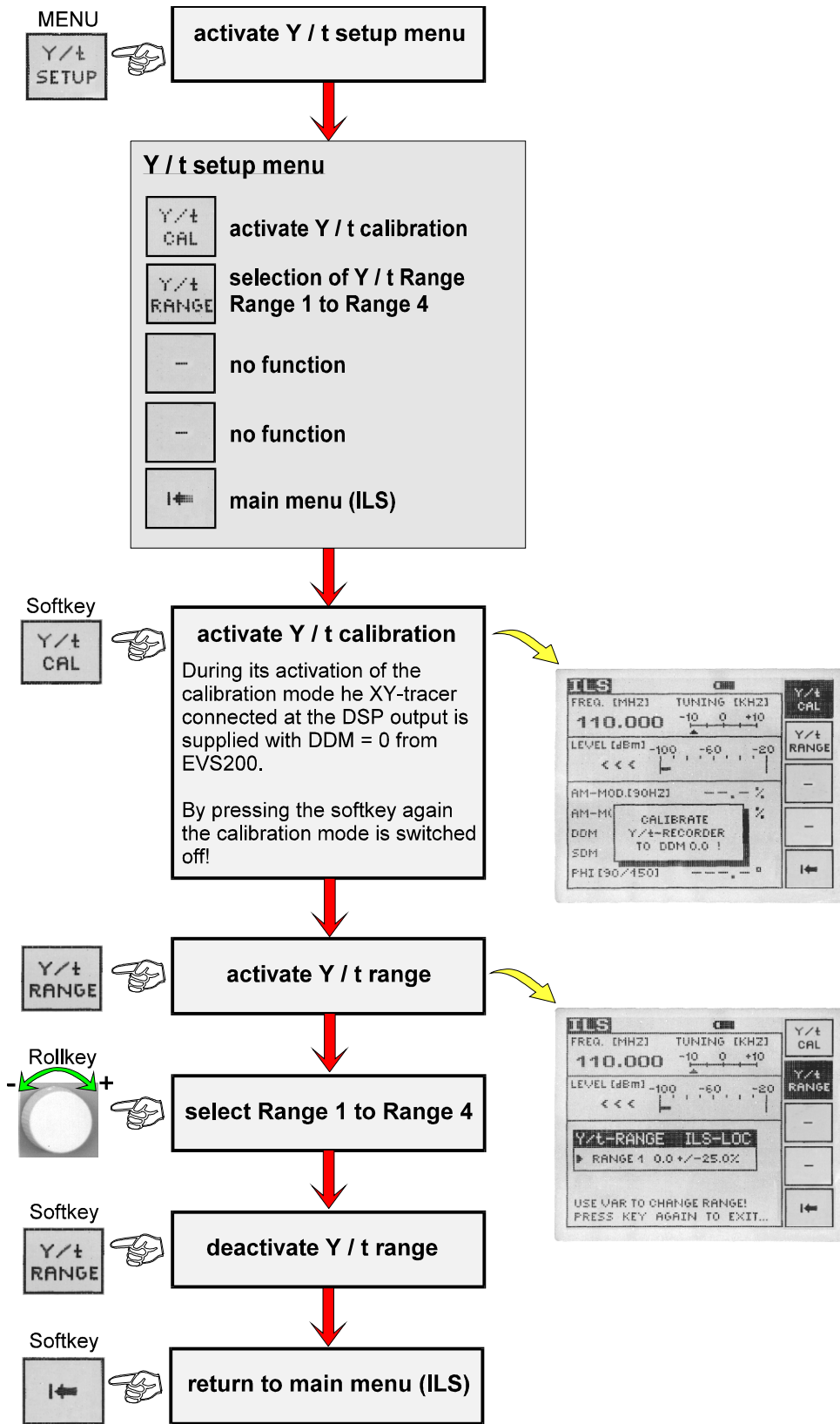

Operating instructions of STORE DDM menu

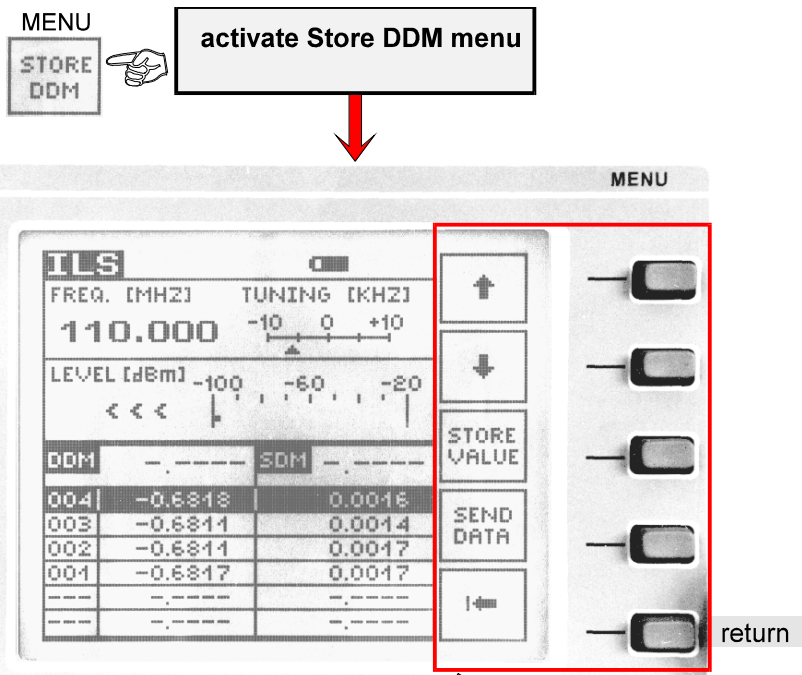

Softkey

↑

↓

description of button "↑up / ↓down"

selection of memory location (up, down)

Note: IF the key is permanently held down, the memory locations are called up in steps of 10.

Softkey

STORE VALUE

description of button "STORE VALUE"

Stores the current value in the selected memory locations.

Note: If a memory location is fully occupied, the next higher location is automatically selected!

If the key is held down for more than **2 seconds**, the menu for memory delete is activated.

The "Y" and "N" keys can be used to clear the total memory location or to abort the function.

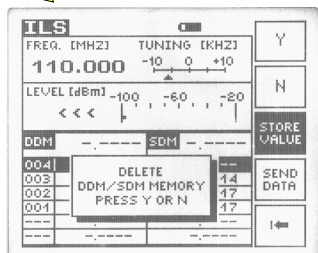

continue next page!



description of button "SEND DATA"

This key is used to transfer the complete memory contents (location 1 to 120, DDM and SDM results) in EXCEL format to a PC connected via the RS-232-Interface.

Note: *The memory location data are transferred according to the following table. Each data element is separated by a semicolon.*

The data of all memory locations (location 1 to 120; DDM; SDM) are transferred.



Memory location number	Memory location data	
	DDM	SDM
001	-0,4000	0,4000
•	•	•
•	•	•
•	•	•
•	•	•
120	-0,3990	0,2700

 **example:** 001;-0,4000;0,4000

Signal parameters on ILS display

Following **signal parameters** are indicated on the display:

	display indication	description	measuring value
	FREQ. (MHZ)	receiver frequency in MHz (numerical) and bargraph center frequency indication in kHz	MHz
	LEVEL (dBm)	receiver signal in dBm (numerical) and bargraph indication (the lower bargraph shows the set squelch threshold)	dBm
DISPL 1/2	AM-MOD.(90HZ)	AM modulation depth (90 Hz)	%
	AM-MOD.(150HZ)	AM modulation depth (150 Hz)	%
	DDM	differences in depth of modulation	DDM-value (non-dimension value) μA %
	SDM	total modulation factor	SDM-value (non-dimension value) μA %
	PHI (90/150)	phase shift (90 Hz/150 Hz)	degree
DISPL 2/2	ID AF-FREQ.	AF frequency (1020 Hz)	Hz
	ID AM-MOD.	AM modulation depth of AF frequency	%
	VOICE AM-MOD.	AM modulation depth in the range of 300 to 3000 Hz	%
Y / t Setup	Range 1 to 4	XY value scaling in localizer / glideslope mode at DSP-Out.	%
STORE DDM menu	Locations 1 to 120	DDM/SDM results	

VOR-Mode

Operating instructions of VOR-Mode

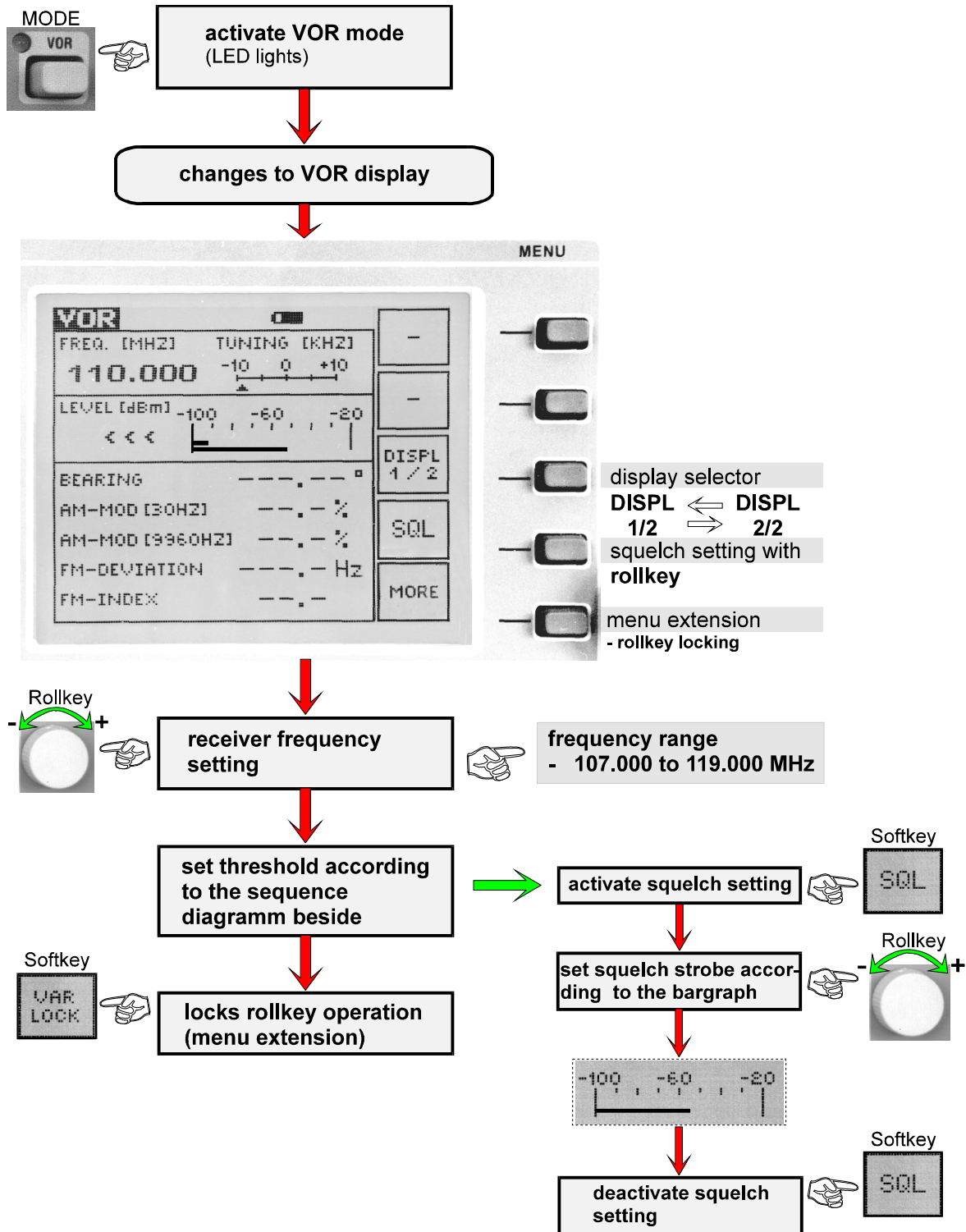

Signal parameters on VOR display

Following **signal parameters** are indicated on the display:

	display indication	description	measuring value
	FREQ. (MHZ)	receiver frequency in MHz (numerical) and bargraph center frequency indication in kHz	MHz
	LEVEL (dBm)	receiver signal in dBm (numerical) and bargraph indication (the lower bargraph shows the set squelch threshold)	dBm
DISPL 1/2	BEARING	BEARING angle	DEG
	AM-MOD.(30HZ)	AM modulation depth (30 Hz)	%
	AM-MOD.(9960HZ)	AM modulation depth (9960 Hz)	%
	FM-DEVIATION	frequency deviation	Hz
	FM-INDEX	FM index value	index value (non-dimension value)
DISPL 2/2	ID AF-FREQ.	AF frequency (1020 Hz)	Hz
	ID AM-MOD.	AM modulation depth of AF frequency	%
	VOICE AM-MOD.	AM modulation depth in the range of 300 to 3000 Hz	%

BEACON-Mode

Operating instructions of BEACON-Mode

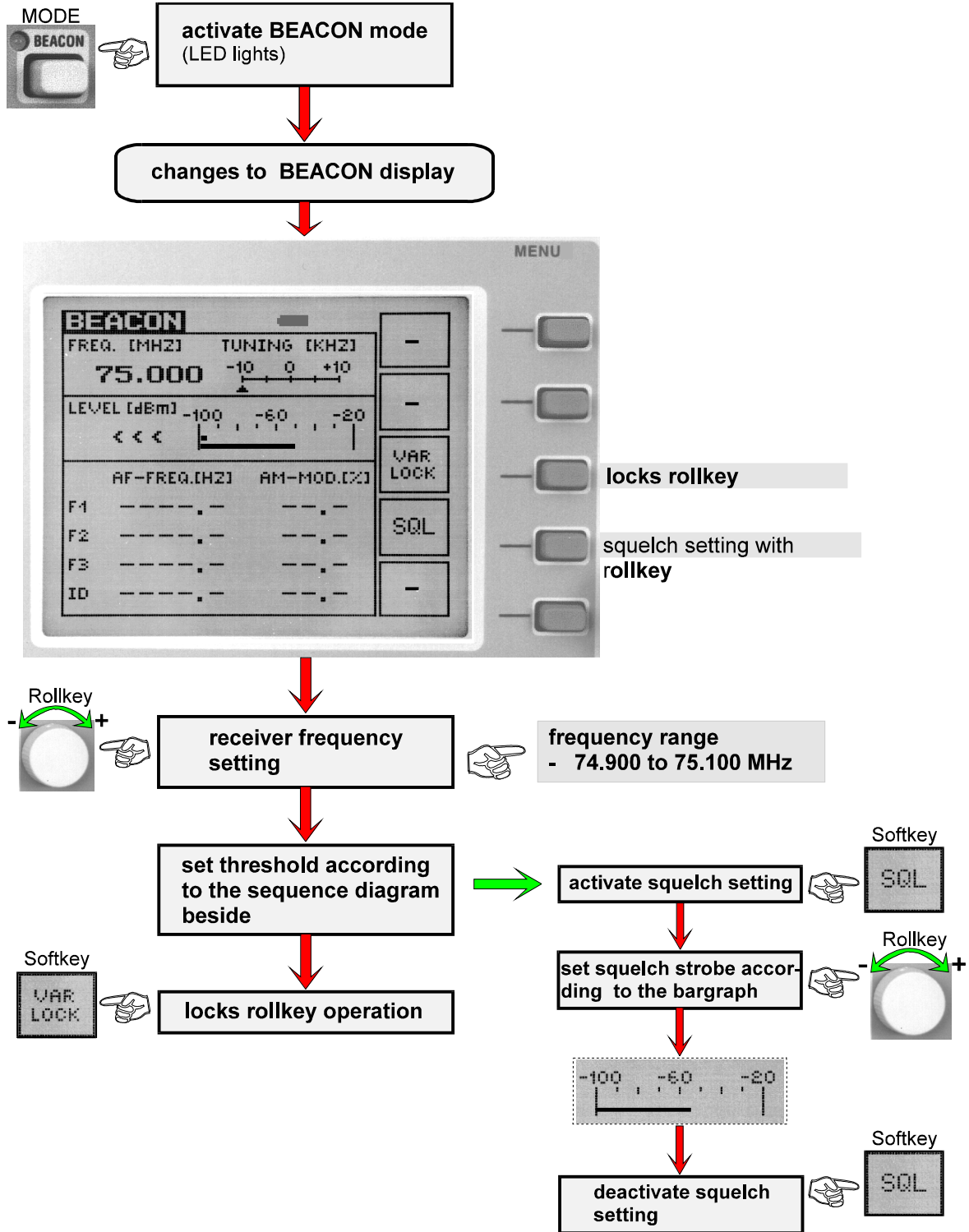

Signal parameters on BEACON display

Following **signal parameters** are indicated on the display:

display indication	description	measuring value
FREQ. (MHZ)	receiver frequency in MHz (numerical) and bargraph center frequency indication in kHz	MHz
LEVEL (dBm)	receiver signal in dBm (numerical) and bargraph indication (the lower bargraph shows the set squelch threshold)	dBm
F1	AF frequency and AM modulation depth at 3000 Hz (inner marker)	Hz and %
F2	AF frequency and AM modulation depth at 1300 Hz (middle marker)	Hz and %
F3	AF frequency and AM modulation depth at 400 Hz (outer marker)	Hz and %
ID	AF frequency and AM modulation depth of the identifier	Hz and %

Δ Level-Mode

Operating instructions of Δ Level-Mode

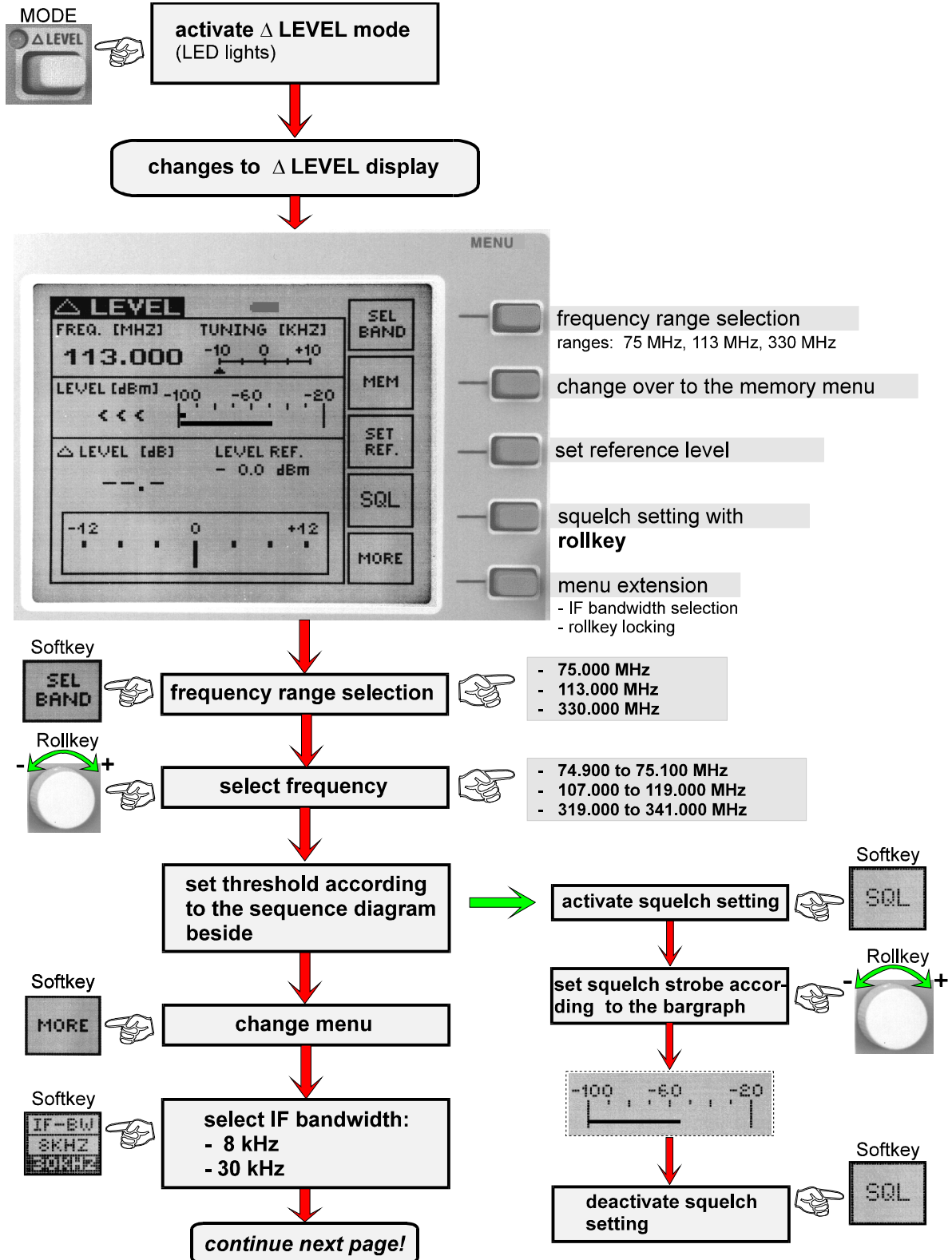

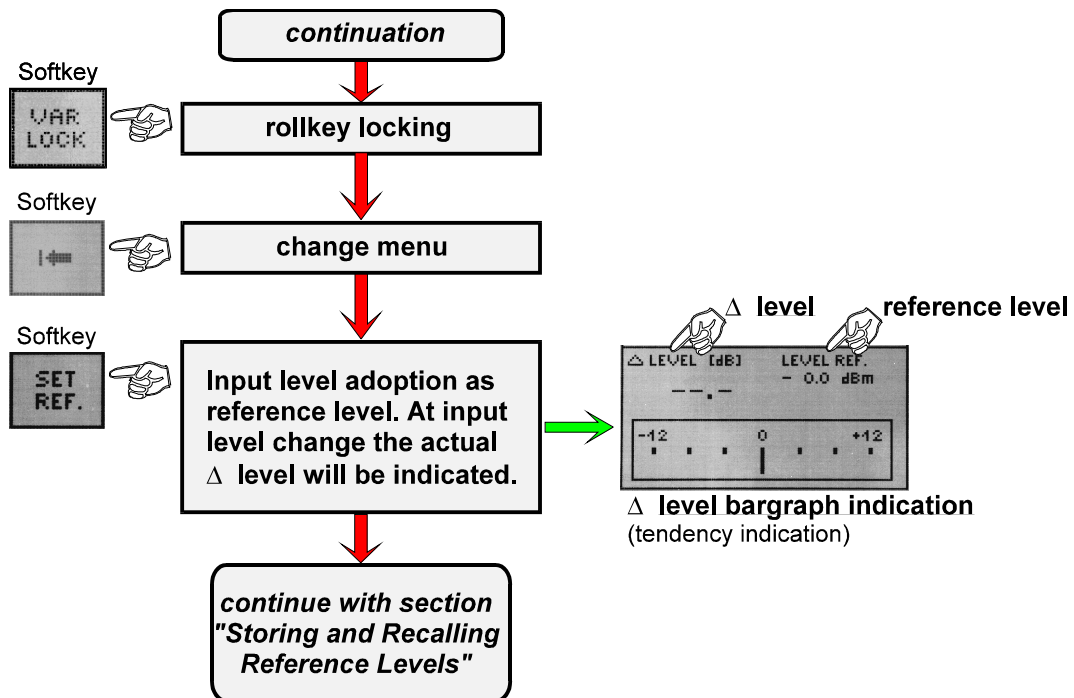

Storing and recalling reference levels

To occupy storage capacity or to call up memory the Δ level mode has a storage menu which will be called up by pushing the softkey "MEM".

Until four memory blocks M1 to M4 can be stored or called up. Following data will be allocated to a storage space:

- actual reference level,
- actual receiver frequency.

After storing or recalling of a memory the Δ level main window is updated with the relevant memory data. When the receiving level changes the update Δ level is permanently indicated in Δ level window.

Storage menu explanation:

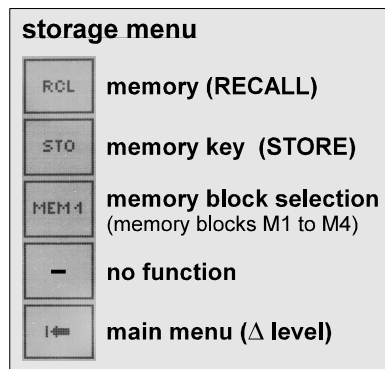

See next page for the operation diagram for "Storing Reference Levels" and "Recalling Single Memory".

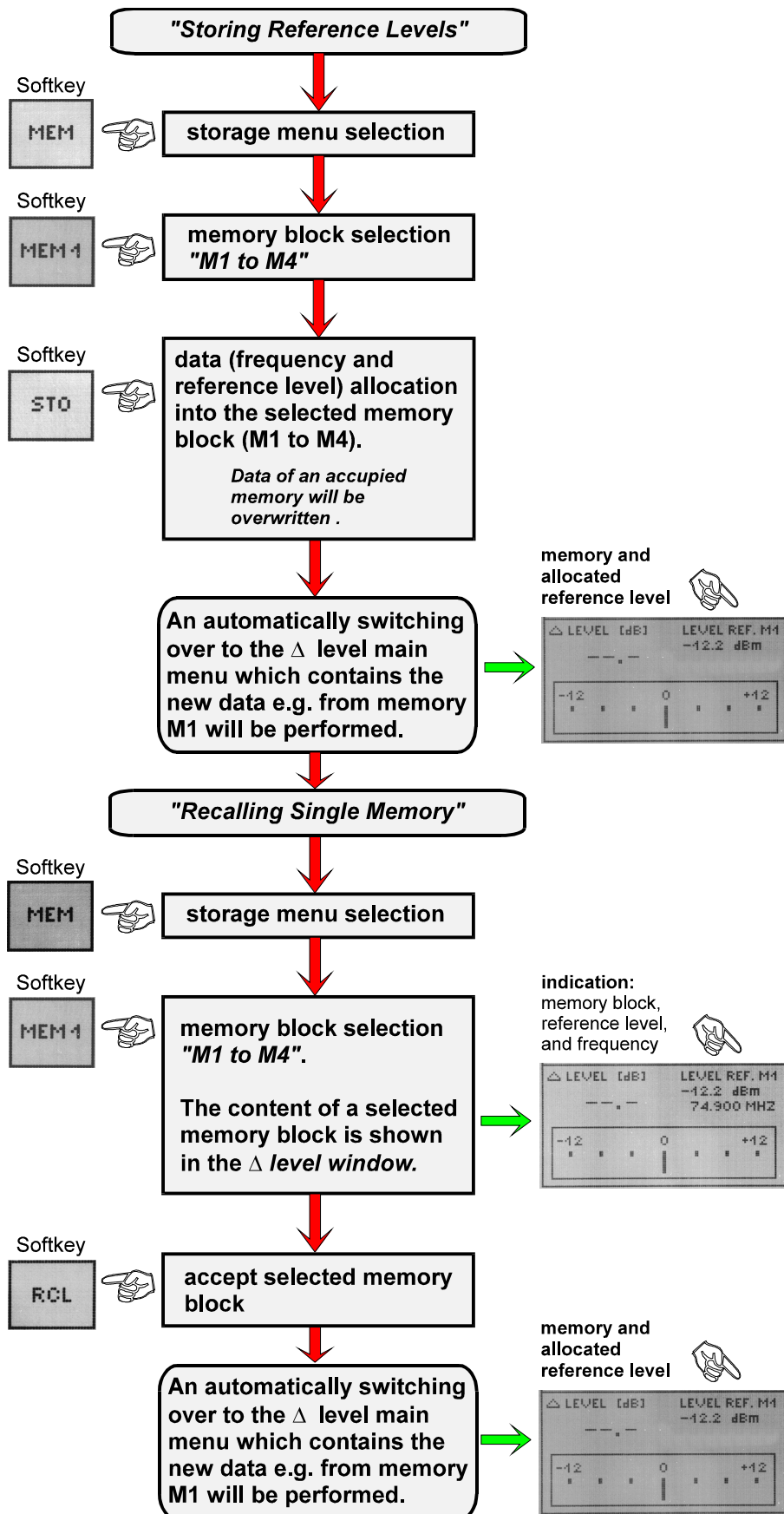

Signal parameters on Δ Level Display

Following **signal parameters** are indicated on the display::

display indication	description	measuring value
FREQ. (MHZ)	receiver frequency in MHz (numerical) and bargraph center frequency indication in kHz	MHz
LEVEL (dBm)	receiver signal in dBm (numerical) and bargraph indication (the lower bargraph shows the set squelch threshold)	dBm
Δ LEVEL (dB)	actual Δ level (difference between actual receiving level and set reference level) the bargraph indication shows the Δ level as a tendency indication	dB
LEVEL REF.	set reference level	dBm

Spectrum-Mode

Operating instructions of Spectrum-Mode



The spectrum analysis of the VOR/ILS Analyzer EVS200 is only for trend indication in the scanned range.



"Spectrum Mode" activation (LED lights)

changing over to spectrum display

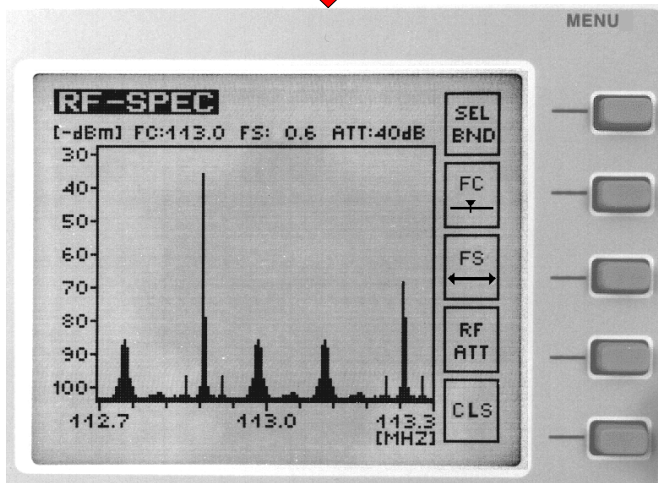

frequency range selection
ranges: 75 MHz, 113 MHz, 330 MHz

"Center" frequency setting

"Span" frequency setting

RF attenuation setting
ranges: 0 dB, 20 dB, 40 dB

deleting display content for generating another analysis

Softkey



receiver frequency setting

Softkey



center frequency setting
- 74.7 to 75.3 MHz
- 107.000 to 119.000 MHz
- 319.000 to 341.000 MHz

Softkey



span frequency setting
0.6 MHz 6.0 MHz
1.2 MHz 9.0 MHz
3.0 MHz 12 MHz

Softkey



RF attenuation setting
(1 attenuation step/key stroke)
0 dB 20 dB 40 dB

Softkey



generation of another analysis.

During the setting the softkey is sensitive and the running analysis stops!

The corresponding frequency is set with the rollkey.

Afterwards leave the menu "FC/FS" by pushing the softkey again.

Example

Resolution	
span frequency	IF bandwidth
0.6 MHz	8 kHz
1.2 MHz	30 kHz
3.0 MHz	30 kHz
6.0 MHz	30 kHz
9.0 MHz	30 kHz
12 MHz	30 kHz

RS-232-Interface operation

All important unit functions can be remote controlled via the RS-232-Interface (V24 standard) by a PC terminal which can be operated with commercial terminal programs (e.g. Telix, Procomm...). AS a data terminal (DDE) the **VOR/ILS Analyzer EVS200** must be connected with a **RS-232-1:1-Interface**. Also it is possible to control the unit with an user defined program. The necessary commands for that purpose are described below.

COM-Parameter

The com parameters parity, number of data bits, and stop bits cannot be changed and are defined as "firmware".

- non parity bit **(N)**,
- 8 data bits **(8)**,
- 1 stop bit **(1)**.

Handshake

Hardware handshake is renounced.

Handshake is performed by software as a transmitted **sequence** e.g. "READY" or as a **measuring value or a tuning value** e.g. "RF107000".

Control commands

There are two categories of control commands.

- super commands (mode independant, unit related)
- mode dependant commands (specified mode must first be selected)

The following table makes clear the control commands structure.

unit related control commands	mode dependant control commands			
	ILS-Mode	VOR-Mode	Δ Level-Mode	BEACON-Mode
BI	AF8	AF8	BW0	AF4
EC0	AM2	AM0	BW1	AF5
EC1	AM3	AM1	LR	AF6
LA	AM8	AM8	LD	AF7
LO	AM9	AM9	SR	AM4
MB	BW0	BE		AM5
MI	BW1	D1		AM6
ML	D1	D2		AM7
MV	D2	FA0		
RES	DD0	FA2		
RF(Freq. kHz)	DD1	FA3		
RF	FA0	FM0		
TEST	FA1	FM1		
VER	FA2			
	FA3			
	PH			
	SD0			
	SD1			

Unit related control commands

Command RF (frequency in kHz)

command	function
RF (frequency in kHz) <frequency information>	setting or scanning receiving frequency

With the command **RF (frequency in kHz)** a frequency input is possible in the ranges of 107000 to 119000 kHz and 319000 to 341000 kHz. With this command it is also possible to scan the tuned frequency when the command RF is transmitted to the EVS200 without additionally parameters. The unit responds with the **frequency information**.

Example:

	<u>command from the controller</u>	<u>response of the VOR/ILS Analyzer EVS200</u>
input:	RF107000 <CR> rf107000 <CR>	READY <CR/LF> READY <CR/LF>
query:	RF<CR> rf<CR>	107000kHz <CR/LF> 107000kHz <CR/LF>

Command LO

command	function
LO <Local>	set unit local mode

Because local operation is automatically locked when the unit is controlled by a controller, the command **LO** (local) performs further local operation at the unit.

Example:

	<u>command from the controller</u>	<u>response of the VOR/ILS Analyzer EVS200</u>
input:	LO<CR> lo<CR>	READY <CR/LF> READY <CR/LF>

Command EC0

command	function
EC0 <echo off >	selection of communication

EVS200 does not retransmit the received control string.

Example:

	<u>command from the controller</u>	<u>response of the VOR/ILS Analyzer EVS200</u>
query:	EC0 <CR> ec0 <CR>	READY <CR/LF> READY <CR/LF>

Command EC1

command	function
EC1 <echo on >	selection of communication

EVS200 retransmits the received control string.

Example:

	<u>command from the controller</u>	<u>response of the VOR/ILS Analyzer EVS200</u>
query:	EC1 <CR> ec1 <CR>	READY <CR/LF> READY <CR/LF>

Command test

command	function
TEST < >	RS232 test section output

The command **TEST** initiates a RS232 test section. All ASCII characters 20h to FF will be supplied.

Example:

	<u>command from the controller</u>	<u>response of the VOR/ILS Analyzer EVS200</u>
query:	EC1 <CR> ec1 <CR>	READY <CR/LF> READY <CR/LF>

Command LA

command	function
LA <Level Absolute>	query of receiving level

The command **LA** reads the actual receiving signal level in "Δ Level"-mode.

Example:

	<u>command from the controller</u>	<u>response of the VOR/ILS Analyzer EVS200</u>
query:	LA <CR> la <CR>	e.g. -48.1dBm <CR/LF> e.g. -48.1dBm <CR/LF>

Command RES

command	function
RES <RESET>	Master-RESET

With the command **RES** a unit master reset is possible. It works like a **restart of the unit**.

Example:

	<u>command from the controller</u>	<u>response of the VOR/ILS Analyzer EVS200</u>
input:	RES<CR> res<CR>	READY <CR/LF> READY <CR/LF> EVS200 REMOTE-SYSTEM READY <CR/LF>

Command BI

command	function
BI <BITE-test information>	BITE (Build In Test) -asking for result

The EVS200 performs approx. every 500 ms a self test (**BITE**) and makes the result available as a **9bit binary form**. During this test the following voltages and functionally subunits of the units are checked.

- all operating voltages,
- hostprocessor
- memory,
- DSP-processor,
- battery capacity (%)

explanation of BITE information

B8	B7	B6	B5	B4	B3	B2	B1	B0
SYNTH 1	SYNTH 2	EXT-DC	PS-DC	+12 VDC	-12 VDC	Batt2	Batt1	Batt0
X	X	X	X	X	X	X	X	X

- X = 1 is function in tolerance (ok)
- X = 0 is function out of tolerance (failure)

Example:

	<u>command from the controller</u>	<u>response of the VOR/ILS Analyzer EVS200</u>
query:	BI <CR>	BI110111101 <CR/LF>

Command VER

command	function
VER <Version>	query of version number and date of the EVS200 firmware

The command **VER** initializes the display of the software version number and its issue date.

Example:

	<u>command from the controller</u>	<u>response of the VOR/ILS Analyzer EVS200</u>
query:	VER <CR> ver <CR>	EVS200 - VERSION < No. > from < Date > Copyright (C) Rohde & Schwarz Werk Köln <CR/LF>

Command ML

command	function
ML <Mode-Delta Level>	Δ level mode setting

The command **ML** enables a switching over to the "Δ level" mode.

Exampel:

	<u>command from the controller</u>	<u>response of the VOR/ILS Analyzer EVS200</u>
input:	ML <CR> ml <CR>	READY <CR/LF> READY <CR/LF>

Command MV

command	function
MV <Mode-VOR>	VOR mode setting

The command **MV** enables a switching over to the "VOR" mode.

Example:

	<u>command from the controller</u>	<u>response of the VOR/ILS Analyzer EVS200</u>
input:	MV <CR> mv <CR>	READY <CR/LF> READY <CR/LF>

Command MI

command	function
MI <Mode-ILS>	ILS mode setting

The command MI enables the switching over to the "ILS" mode.

Example:

	<u>command from the controller</u>	<u>response of the VOR/ILS Analyzer EVS200</u>
input:	MI <CR> mi <CR>	READY <CR/LF> READY <CR/LF>

Command MB

command	function
MB <Mode-BEACON>	BEACON mode setting

The command MB enables the switching over to the "BEACON mode".

Example:

	<u>command from the controller</u>	<u>response of the VOR/ILS Analyzer EVS200</u>
input:	MB <CR> mb <CR>	READY <CR/LF> READY <CR/LF>

Mode related control commands

ILS-Mode

Command DD0

command	function
DD0 <DDM information>	DDM value query

The command DD0 reads the actual DDM value (value without dimension) in the ILS mode.

Example:

	<u>command from the controller</u>	<u>response of the VOR/ILS Analyzer EVS200</u>
query:	DD0 <CR> dd0 <CR>	e.g. 0.2008 <CR/LF> e.g. 0.2008 <CR/LF>

Command DD1

command	function
DD1 <DDM information>	query of the DDM value in μA

The command **DD1** reads the actual DDM value in μA in the **ILS** mode.

Example:

	<u>command from the controller</u>	<u>response of the VOR/ILS Analyzer EVS200</u>
query:	DD1 <CR> dd1 <CR>	e.g. 194.32uA <CR/LF> e.g. 194.32uA <CR/LF>

Command SD0

command	function
SD0 <SDM information>	SDM value query

The command **SD0** reads the actual SDM value (value without dimension) in the **ILS** mode.

Example:

	<u>command from the controller</u>	<u>response of the VOR/ILS Analyzer EVS200</u>
query:	SD0 <CR> sd0 <CR>	e.g. 0.8006 <CR/LF> e.g. 0.8006 <CR/LF>

Command SD1

Command	function
SD1 <SDM information>	query of SDM value in μA

The command **SD1** reads the actual DDM value in μA in the **ILS** mode.

Example:

	<u>command from the controller</u>	<u>response of the VOR/ILS Analyzer EVS200</u>
query:	SD1 <CR> sd1 <CR>	e.g. 774.87uA <CR/LF> e.g. 774.87uA <CR/LF>

Command AM2

command	function
AM2 <AM modulation depth (90 Hz)>	query of AM modulation depth (90 Hz)

The command **AM2** reads the actual AM modulation depth (90 Hz) in the **ILS** mode.

Example:

	<u>command from the controller</u>	<u>response of the VOR/ILS Analyzer EVS200</u>
query:	AM2 <CR> am2 <CR>	e.g. 50% <CR/LF> e.g. 50% <CR/LF>

Command AM3

command	function
AM3 <AM modulation depth (150 Hz)>	query of AM modulation depth (150 Hz)

The command **AM3** reads the actual AM modulation depth (150 Hz) in the **ILS** mode.

Example:

	<u>command from the controller</u>	<u>response of the VOR/ILS Analyzer EVS200</u>
Query:	AM3 <CR> am3 <CR>	e.g. 29.9% <CR/LF> e.g. 29.9% <CR/LF>

Command PH

command	function
PH <Phase 90/150 Hz>	query of Phase angle 90/150 Hz

The command **PH** reads the actual PHI value between 90 Hz and 150 Hz in the **ILS** mode.

Example:

	<u>command from the controller</u>	<u>response of the VOR/ILS Analyzer EVS200</u>
query:	PH <CR> ph <CR>	e.g. 119.9DEG <CR/LF> e.g. 119.9DEG <CR/LF>

Command BW0

command	function
BW0 <bandwidth information >	8-kHz bandwidth setting

The command **BW0** enables the switching over to the 8-kHz bandwidth in the **ILS** mode and in the "**Δ level**" mode.

Example:

	<u>command from the controller</u>	<u>response of the VOR/ILS Analyzer EVS200</u>
input:	BW0 <CR> bw0 <CR>	READY <CR/LF> READY <CR/LF>

Command BW1

command	function
BW1 <bandwidth information>	30-kHz bandwidth setting

The command **BW1** enables the switching over to the 30-kHz-IF bandwidth in the **ILS** mode and in the "**Δ level**" mode.

Example:

	<u>command from the controller</u>	<u>response of the VOR/ILS Analyzer EVS200</u>
input:	BW1 <CR> bw1 <CR>	READY <CR/LF> READY <CR/LF>

Command FA1

command	function
FA1 <Fast DDM measuring on>	Activating the Fast DDM measurement

The command **FA1** switches on the fast DDM measurement. The measuring, used only for landing path measurement can only be activated through a controller. The output is performed as **DDM** value with **RF** level (see example) and can be processed accordingly with calculation programs e.g. like Excel etc. A capacity of **34 measurements /s** at a baud rate set to **19200 baud** will be reached. This conforms to a time interval of **30 ms**. The measurement values (**DDM, RF level**) can be read in and output as a text file corresponding to the terminal program.

 **To reach 34 meas/s the baud rate must be set to 19200 baud in the Setup of the VOR/ILS Analyzer EVS200. It must be attended the acceptance of the data transferring rate by the terminal program.**

★ **The measurement can be stopped through the command FA0 (refer to Command FA0).**

Example:

	<u>command from the controller</u>	<u>response of the VOR/ILS Analyzer EVS200</u>
input:	FA1 <CR> fa1 <CR>	0.2008 -48.2 <CR/LF> 0.2008 -48.2 <CR/LF>
	 With the command FA1 the echo mode is automatically switched OFF.	Both values are separated through a tabulator ASCII 9.

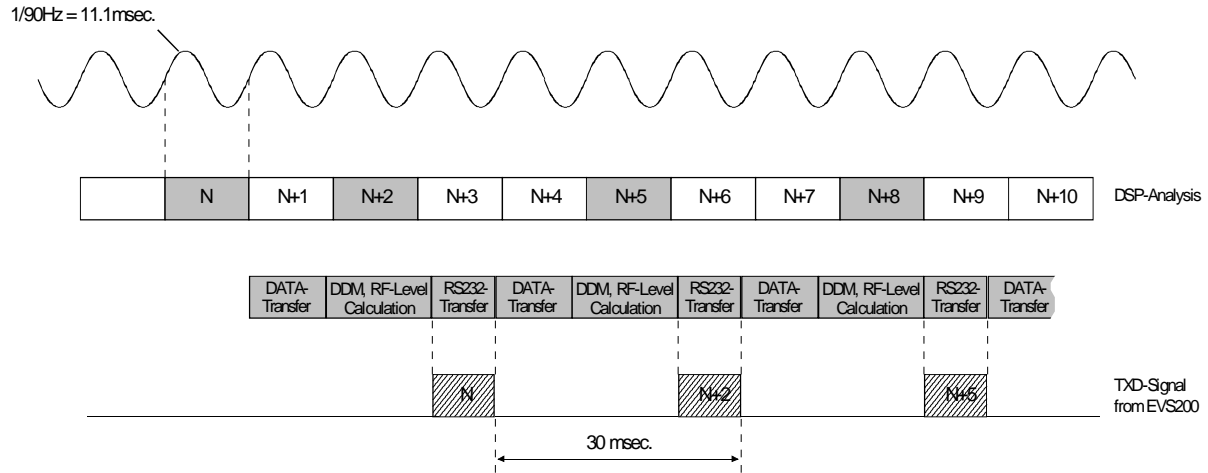

Command FA2

command	function
FA2 <Fast DDM measuring on>	Activating the Fast DDM measurement

The command **FA2** switches on the fast DDM measurement. The measuring, used only for landing path measurement can only be activated through a controller.

The command **FA2** performs the continuous measurement and output of the **DDM, RF level, Modfactor 90 Hz** and **Modfactor 150 Hz** with a transmission speed of about 20 measurement value sets (**DDM, RF level, AM90, AM150**) per second. This conforms to a time interval of **50 ms**. The stated **RS-232-transmission times** are related to **19.200 Baud**.

The measurement values can be read in and output as a text file corresponding to the terminal program.

 **To reach 20 meas/s the baud rate must be set to 19200 baud in the Setup of the VOR/ILS Analyzer EVS200. It must be attended the acceptance of the data transferring rate by the terminal program.**

★ **The measurement can be stopped through the command FA0 (refer to Command FA0).**

Example:

	<u>command from the controller</u>	<u>response of the VOR/ILS Analyzer EVS200</u>
input:	FA2 <CR> fa2 <CR>	output form: (DDM <CR >, RF level <CR >, AM90 <CR >, AM 150 <CR >)
	With the command FA2 the echo mode is automatically switched OFF.	DDM: four-digit with indication (dimensionless) example: -1000 <CR > (-0.1000 DDM) five-digit with indication (µA) example: -09890 <CR > (-98.90 µA)
		RF level: three-digit with indication (dBm) example: -400 <CR > (-40.0dBm) 122 <CR > (12.2dBm)
		Modulation depth: three-digit (%) example: 202 <CR > (20.2 %) 004 <CR > (0.4 %)

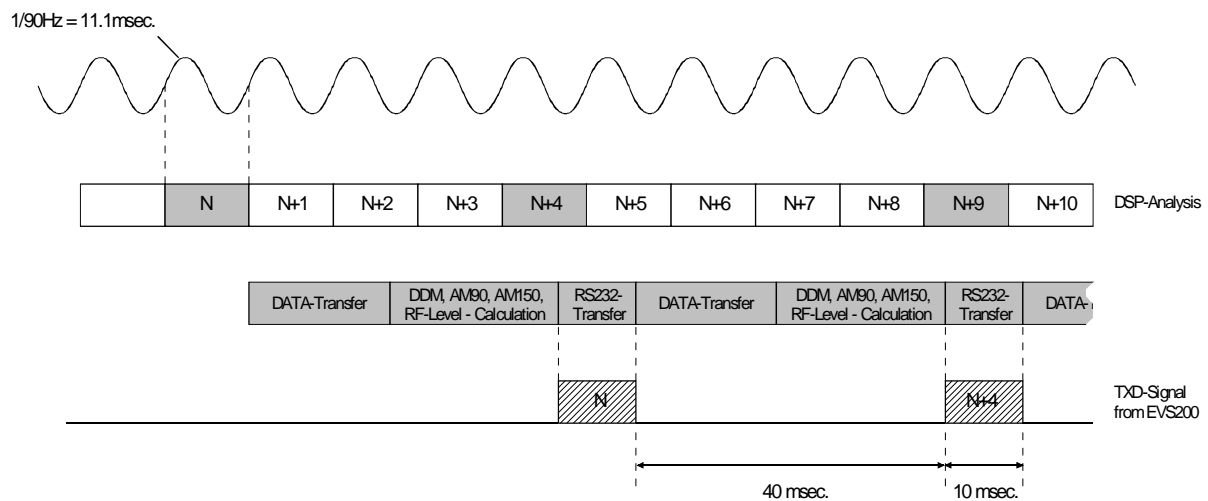

Command FA0

command	function
FA0 <fast DDM measuring off>	deactivating the fast DDM measurement

The command **FA0** switches off the fast DDM measurement.

Example:

	<u>command from the controller</u>	<u>response of the VOR/ILS Analyzer EVS200</u>
input:	FA0 <CR> fa0 <CR>	READY <CR/LF> READY <CR/LF>

Command D1

command	function
D1 <display information>	switch over to display1

The command **D1** enables the switching over to the content of **display1** in the **VOR / ILS mode**.



This is prediction for reading out the data of the corresponding mode (VOR/ILS).

Example:

	<u>command from the controller</u>	<u>response of the VOR/ILS Analyzer EVS200</u>
input:	D1 <CR> d1 <CR>	READY <CR/LF> READY <CR/LF>

Command D2

command	function
D2 <display information>	switch over to display2

The command **D2** enables the switching over to the content of **display2** in the **VOR / ILS mode**.



This is prediction for reading out the data of the corresponding mode (VOR/ILS).

Example:

	<u>command from the controller</u>	<u>response of the VOR/ILS Analyzer EVS200</u>
input:	D2 <CR> d2 <CR>	READY <CR/LF> READY <CR/LF>

Command AF8

command	function
AF8 <AF-frequency ID>	AF-frequency ID query

The command **AF8** reads the actual AF frequency (ID) in the **ILS /VOR mode**.



Prediction for reading out the data of the corresponding mode (VOR/ILS) is the switching over to display2.

Example:

	<u>command from the controller</u>	<u>response of the VOR/ILS Analyzer EVS200</u>
query:	AF8 <CR> af8 <CR>	e.g. 1020.0Hz <CR/LF> e.g.. 1020.0Hz <CR/LF>

Command AM8

command	function
AM8 <AM-modulation depth (ID)>	query of AM-modulation depth (ID)

The command **AM8** reads the actual AM-modulation depth (ID) in the **ILS / VOR mode**.



Prediction for reading out the data of the corresponding mode (VOR/ILS) is the switching over to display2.

Example:

	<u>command from the controller</u>	<u>response of the VOR/ILS Analyzer EVS200</u>
query:	AM8 <CR> am8 <CR>	e.g. 10.0% <CR/LF> e.g. 10.0% <CR/LF>

Command AM9

command	function
AM9 <AM-modulation depth (voice)>	query of AM-modulation depth (voice)

The command **AM9** reads the actual AM-modulation **depth** (voice 300 Hz to 3kHz) in the **ILS / VOR mode**.



Prediction for reading out the data of the corresponding mode (VOR/ILS) is the switching over to display2.

Example:

	<u>command from the controller</u>	<u>response of the VOR/ILS Analyzer EVS200</u>
query:	AM9 <CR> am9 <CR>	e.g. 09.6% <CR/LF> e.g. 09.6% <CR/LF>

VOR-Mode

Command BE

command	funcion
BE <Bearing Angle>	bearing angle query

The command **BE** reads the actual bearing angle (indicated in degree) in the **VOR** mode.

Example:

	<u>command from the controller</u>	<u>response of the VOR/ILS Analyzer EVS200</u>
query:	BE <CR> be <CR>	e.g. 299.97DEG <CR/LF> e.g. 299.97DEG <CR/LF>

Command AM0

command	function
AM0 <AM-modulation depth (30 Hz)>	query of AM-modulation depth (30 Hz)

The command **AM0** reads the actual AM-modulation depth (30 Hz) in the **VOR** mode.

Example:

	<u>command from the controller</u>	<u>response of the VOR/ILS Analyzer EVS200</u>
query:	AM0 <CR> am0 <CR>	e.g. 30.1% <CR/LF> e.g. 30.1% <CR/LF>

Command AM1

command	function
AM1 <AM-modulation depth (9960 Hz)>	query of AM-modulation depth (9960 Hz)

The command **AM1** reads the actual AM-modulation depth (9960 Hz) in the **VOR** mode.

Example:

	<u>command from the controller</u>	<u>response of the VOR/ILS Analyzer EVS200</u>
query:	AM1 <CR> am1 <CR>	e.g. 30.1% <CR/LF> e.g. 30.1% <CR/LF>

Command FM0

command	function
FM0 <FM-deviation>	FM-deviation query

The command **FM0** reads the actual FM-deviation value in the **VOR** mode.

Example:

	<u>command from the controller</u>	<u>response of the VOR/ILS Analyzer EVS200</u>
query:	FM0 <CR> fm0 <CR>	e.g. 479.1Hz <CR/LF> e.g. 479.1Hz <CR/LF>

Command FM1

command	function
FM1 <FM-Index>	query of FM-index value

The command **FM1** reads the actual FM-index value in the **VOR** mode.

Example:

	<u>command from the controller</u>	<u>response of the VOR/ILS Analyzer EVS200</u>
query:	FM1 <CR> fm1 <CR>	e.g. 15.9 <CR/LF> e.g. 15.9 <CR/LF>

Command D1

command	function
D1 <Display-information>	switching over to Display1

The command **D1** enables the switching over to the content of **display1** in the **VOR / ILS** mode.



This is the prediction for reading out the data of the corresponding mode (VOR/ILS).

Example:

	<u>command from the controller</u>	<u>response of the VOR/ILS Analyzer EVS200</u>
input:	D1 <CR> d1 <CR>	READY <CR/LF> READY <CR/LF>

Command D2

command	function
D2 <Display-information>	switching over to Display2

The command **D2** enables the switching over to the content of **display2** in the **VOR / ILS mode**.



This is the prediction for reading out the data of the corresponding mode (VOR/ILS).

Example:

	<u>command from the controller</u>	<u>response of the VOR/ILS Analyzer EVS200</u>
input:	D2 <CR> d2 <CR>	READY <CR/LF> READY <CR/LF>

Command AF8

command	function
AF8 <AF-frequency ID>	AF-frequency ID query

The command **AM8** reads the actual AF frequency (ID) in the **ILS / VOR mode**.



Prediction for reading out the data of the corresponding mode (VOR/ILS) is the switching over to display2.

Example:

	<u>command from the controller</u>	<u>response of the VOR/ILS Analyzer EVS200</u>
query:	AF8 <CR> af8 <CR>	e.g. 1020.0Hz <CR/LF> e.g. 1020.0Hz <CR/LF>

Command AM8

command	function
AM8 <AM-modulation depth (ID)>	query of AM-modulation depth (ID)

The command **AM8** reads the actual AM-modulation depth (ID) in the **ILS / VOR mode**.



Prediction for reading out the data of the corresponding mode (VOR/ILS) is the switching over to display2.

Example:

	<u>command from the controller</u>	<u>response of the VOR/ILS Analyzer EVS200</u>
query:	AM8 <CR> am8 <CR>	e.g. 10.0% <CR/LF> e.g. 10.0% <CR/LF>

Command AM9

command	function
AM9 <AM-modulation depth (voice)>	query AM-modulation depth (voice)

The command **AM9** reads the actual AM-modulation depth (voice 300 Hz to 3 kHz) in the ILS / VOR mode.



Prediction for reading out the data of the corresponding mode (VOR/ILS) is the switching over to display2.

Example:

	command from the controller	response of the VOR/ILS Analyzer EVS200
query:	AM9 <CR> am9 <CR>	e.g. 09.6% <CR/LF> e.g. 09.6% <CR/LF>

Command FA2

command	function
FA2 <Fast measuring on>	Activating the Fast measurement mode

The command **FA2** switches on the fast measurement mode. The command **FA2** performs the continuous measurement and output of the **RF level, Bearing, AM30, AM9960, FM-deviation, FM-Index** with transmission speed of 15 measurement value sets (**RF level, Bearing, AM30, AM9960, FM-deviation, FM-Index**) per second. This conforms to a time interval of **66 ms**. The stated **RS-232-transmission times** are related to **19.200 Baud**.

The measurement values can be read in and output as a text file corresponding to the terminal program.



The baud rate must be set to 19200 baud in the Setup of the VOR/ILS Analyzer EVS200. It must be attended the acceptance of the data transferring rate by the terminal program.

★ *The measurement can be stopped through the command FA0 (refer to Command FA0).*

Example:

	command from the controller	response of the VOR/ILS Analyzer EVS200
input:	FA2 <CR> fa2 <CR>	output form: (RF level <CR >, Bearing <CR >, AM30 <CR >, AM 9960 <CR >), FM-deviation<CR >, FM-Index <CR >),
	<i>With the command FA2 the echo mode is automatically switched OFF.</i>	RF level: three-digit with indication (dBm) example: -400 <CR > (-40.0dBm) 122 <CR > (12.2dBm)
		Modulation depth: three-digit (%) example: 304 <CR > (30.4 %) 004 <CR > (0.4 %)
		FM-deviation: four-digit (Hz) example: 4800<CR > (480,0Hz) 0004 <CR > (0.4 Hz)
		FM-Index: three-digit example: 160<CR > (16,0)

Command FA3

command	function
FA3 <Fast measuring on>	Activating the Fast measurement mode

The command **FA3** switches on the fast measurement mode. The command **FA3** performs the continuous measurement and output of the **RF level, Bearing, AM30, AM9960, FM-deviation, FM-Index**. The **33 to 66-ms measurement interval** consists of DSP analysis, DSP data transmission to the host processor and conversion of the DSP raw measurement value into **dBm, Bearing °, AM % and FM Hz**. The measurement values output is performed in this mode as **interrupt operation** via RS232 interface.



In this Fast-Mode (FA3) a measurement value set will only be transmitted to the PC if it is demanded by a short command (1 ASCII-Character). The response from the EVS200 is performed without a longer delay within about **15 to 20 ms between measurement value demand and measurement value transmission**. The stated **RS-232-transmission times** are related to **19.200 Baud**.

The measurement values can be read in and output as a text file corresponding to the terminal program.

 **The baud rate must be set to 19200 baud in the Setup of the VOR/ILS Analyzer EVS200. It must be attended the acceptance of the data transferring rate by the terminal program.**

★ **The measurement can be stopped through the command FA0 (refer to Command FA0) or <CR>.**

Example:

	<u>command from the controller</u>	<u>response of the VOR/ILS Analyzer EVS200</u>
input:	e.g. A ★ Demand for measurement values output: all ASCII characters without: CR (0Dh), LF (0Ah), # (23h), @ (40h)	output form: (RF level <CR >, Bearing <CR >, AM30 <CR >, AM 9960 <CR >), FM-deviation<CR >, FM-Index <CR >),
	 With the command FA3 the echo mode is automatically switched OFF.	 output form as FA2 example: -412 <CR > (RF level), 35506 <CR > (Bearing), 304 <CR > (AM30), 302 <CR > (AM9960), 4800 <CR > (FM-deviation), 160 <CR > (FM-Index),

Command FA0

command	function
FA0 <fast DDM measuring off>	deactivating the fast DDM measurement

The command **FA0** switches off the fast DDM measurement.

Example:

	<u>command from the controller</u>	<u>response of the VOR/ILS Analyzer EVS200</u>
input:	FA0 <CR> fa0 <CR>	READY <CR/LF> READY <CR/LF>

Δ Level-Mode

Command SR

command	function
SR <Set REF>	reference level setting

The command **SR** is for setting the actual receiver level as a reference level in the reference level window "**Δ level**"-mode.

Example:

	<u>command from the controller</u>	<u>response of the VOR/ILS Analyzer EVS200</u>
input:	SR <CR> sr <CR>	READY <CR/LF> READY <CR/LF>

Command LR

command	function
LR <level reference>	reference level query

The command **LR** reads the actual set reference level in the "**Δ Level**" mode.

Example:

	<u>command from the controller</u>	<u>response of the VOR/ILS Analyzer EVS200</u>
query:	LR <CR> lr <CR>	e.g. -48.1dBm <CR/LF> e.g. -48.1dBm <CR/LF>

Command LD

command	function
LR <level delta>	Δ-Level query

The command **LD** reads the actual **Δ-Level** in the "**Δ Level**" mode.

Example:

	<u>command from the controller</u>	<u>response of the VOR/ILS Analyzer EVS200</u>
query:	LD <CR> ld <CR>	e.g. -000.0dBm <CR/LF> e.g. -000.0dBm <CR/LF>

Beacon-Mode

Command AM4

command	function
AM4 <AM-modulation depth (F1-range)>	query of AM-modulation depth (F1)

The command **AM4** reads the actual AM-modulation depth (F1 3000 Hz) in the **BEACON** mode.

Example:

	<u>command from the controller</u>	<u>response of the VOR/ILS Analyzer EVS200</u>
query:	AM4 <CR> am4 <CR>	e.g. 29.3% <CR/LF> e.g. 29.3% <CR/LF>

Command AM5

command	function
AM5 <AM-modulation depth (F2-range)>	query of AM-modulation depth (F2)

The command **AM5** reads the actual AM-modulation depth (F2 1300 Hz) in the **BEACON** mode.

Example:

	<u>command from the controller</u>	<u>response of the VOR/ILS Analyzer EVS200</u>
query:	AM5 <CR> am5 <CR>	e.g. 30.5% <CR/LF> e.g. 30.5% <CR/LF>

Command AM6

command	function
AM6 <AM-modulation depth (F3-range)>	query of AM-modulation depth (F3)

The command **AM6** reads the actual AM-modulation depth (F3 400 Hz) in the **BEACON** mode.

Example:

	<u>command from the controller</u>	<u>response of the VOR/ILS Analyzer EVS200</u>
query:	AM6 <CR> am6 <CR>	e.g. 29.8% <CR/LF> e.g. 29.8% <CR/LF>

Command AM7

Kommando	Funktion
AM6 <AM-modulation depth ID>	query of AM-modulation depth ID

The command **AM7** reads the actual AM-modulation depth (ID) in the **BEACON** mode.

Example:

	<u>command from the controller</u>	<u>response of the VOR/ILS Analyzer EVS200</u>
query:	AM7 <CR> am7 <CR>	e.g. 10.2% <CR/LF> e.g. 10.2% <CR/LF>

Command AF4

command	function
AF4 <AF-frequency range F1>	query of AF-frequency 3000 Hz

The command **AF4** reads the actual AF frequency (F1) in the **BEACON** mode.

Example:

	<u>command from the controller</u>	<u>response of the VOR/ILS Analyzer EVS200</u>
query:	AF4 <CR> af4 <CR>	e.g. 3000.0Hz <CR/LF> e.g. 3000.0Hz <CR/LF>

Command AF5

command	function
AF5 <AF-frequency range F2>	query of AF-frequency 1300 Hz

The command **AF5** reads the actual AF frequency (F2) in the **BEACON** mode.

Example:

	<u>command from the controller</u>	<u>response of the VOR/ILS Analyzer EVS200</u>
query:	AF5 <CR> af5 <CR>	e.g. 1300.0Hz <CR/LF> e.g. 1300.0Hz <CR/LF>

Command AF6

command	function
AF6 <AF-frequency range F3>	query of AF-frequency 400 Hz

The command **AF6** reads the actual AM frequency (F3) in the **BEACON** mode.

Example:

	<u>command from the controller</u>	<u>response of the VOR/ILS Analyzer EVS200</u>
query:	AF6 <CR> af6 <CR>	e.g. 400.0Hz <CR/LF> e.g. 400.0Hz <CR/LF>

Command AF7

command	Funktion
AF7 <AF-Frequenz ID>	query of AF-frequency ID



The command **AF7** reads the actual AF frequency (ID) in the **BEACON** mode.

Example:

	<u>command from the controller</u>	<u>response of the VOR/ILS Analyzer EVS200</u>
query:	AF7 <CR> af7 <CR>	e.g. 1020.0Hz <CR/LF> e.g. 1020.0Hz <CR/LF>

Interfaces

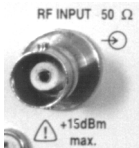

Antenna input

labeling	figure	description
RF INPUT 50 Ω 		input level: 0 dBm / 50 Ω <div style="text-align: center;">  <p>max. +15 dBm (Data safety up to 10 dBm is ensured)</p> </div> frequency range: 74 to 341 MHz VSWR: <1.5

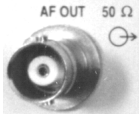
AF output

labeling	figure	description
AF OUT 50 Ω 		output level: 200 mV _{rms} / 50 Ω frequency range: 0.3 to 3.4 kHz

Headphone connection

labeling	figure	description
PHONES		<div style="text-align: center;">  </div> Only for connecting headphones with soundproofing. e.g. R&S order no. 0708.9010.00

XY-Tracer connection

labeling	figure	description
DSP-OUT		The scaling of the XY values can be set in the setup / IIs mode (Y / t setup) for the localizer and glideslope mode.

External AF input

labeling	figure	description
AF EXT.		input level: 1 to 2 V _{rms} / 50 Ω frequency range: 30 Hz to 10 kHz

RS-232-Interface

labeling	figure	description
RS232/DDE		standard RS-232-Interface COM parameter: N81 baud rate: 1200, 2400, 4800, 9600, 19200 adjustable in the setup

External VDC connection

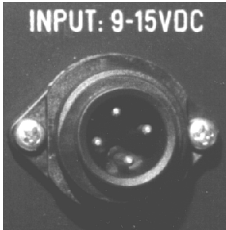
labeling	figure	description
INPUT: 9-15 VDC		DC connection: 12 VDC / 30 W tolerance max. 9 to 15 VDC

Mains connection

labeling	figure	description
INPUT: 85-250 V/ 47-63Hz F1/F2: IEC127- T800H/250V		mains connection: 87 to 265 VAC 47 to 63 Hz

Service

To ensure a unit's repair **as quick as possible** a defect **VOR/ILS Analyzer EVS200** must be send to the service place named in the following.

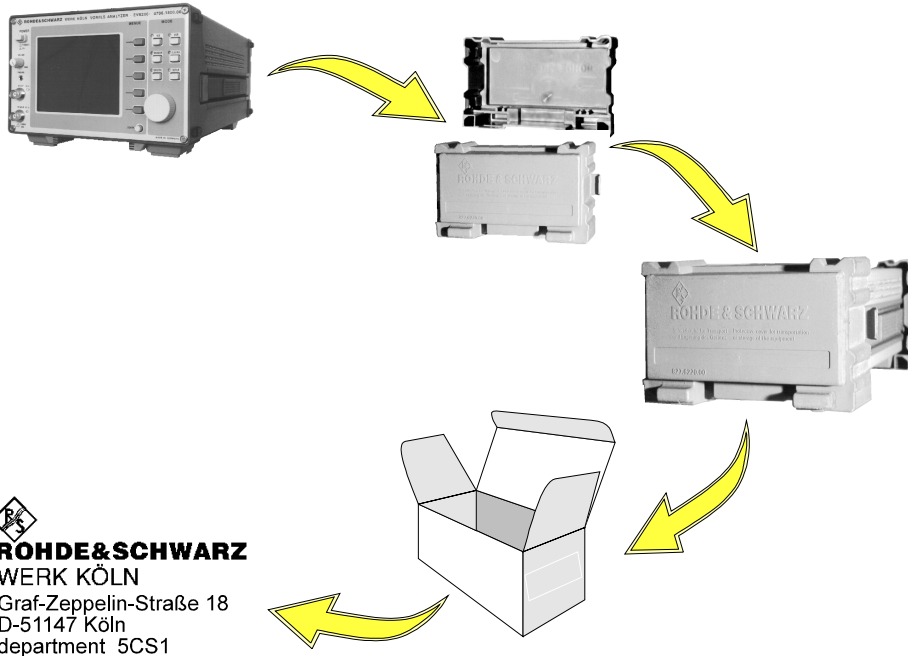

ROHDE & SCHWARZ
WERK KÖLN
 Graf-Zeppelin-Straße 18
 D-51147 Köln
 department 5CS1



In case of service questions please contact us over phone or FAX.

	(49) / 2203 / 49-266
	(49) / 2203 / 49-336

Warranty

Warranty conditions are stated in the general terms of business.



Whilst time of warranty a defective internal battery (option) may only be changed by Rohde & Schwarz service personnel!

Technical data



Receiver section

Frequency range	74.7 to 75.3 MHz 107 to 119 MHz 319 to 341 MHz
Accuracy	≤2 ppm
Resolution	5 kHz
Input voltage	15 dBm max./ 50 Ω (data safety up to 10 dBm is ensured)
VSWR	<1.5
Sensitivity	-96 dBm ≥18 dB (IF bandwidth 8 kHz)
IF bandwidth	min. ±15 kHz (-3 dB), max. ±40 kHz (-60dB) min. ±4 kHz (-3 dB), max. ±12 kHz (-60dB) or optional: min. ±19 kHz (-6 dB), max. ±38 kHz (-60dB) min. ±8 kHz (-6 dB), max. ±20 kHz (-60dB)
Demodulation	AM
RF-Input	BNC

Absolute-level receiver

Display range	-96 to +10 dBm
Accuracy	< ±2 dB

Difference-level receiver

Bargraph (quasi analog)	±12 dB to reference level
Resolution	0.1 dB
Accuracy indication	≤ ±1 dB

ILS signal analysis



The given values are valid only for the 30 kHz- or 38 kHz- IF-filter

RF level	-70 to -30 dBm
Frequency range	108 to 118 MHz 328 to 336 MHz

Modulation depth (10 to 80 %)

90 / 150 Hz ±2%	accuracy 0.5%
300 Hz to 4 kHz (identifier)	≤1.2% of reading

Phase angle 90/150 Hz

Measurement range	±60°
Measurement error	≤0.2°
Resolution	0.1°

DDM measurement

Localizer mode

Measurement error at		
15 to 25% modulation	≤ ±0.0004 DDM ±0.1% of reading
10 to 30% modulation	≤ ±0.0004 DDM ±0.2% of reading

Glideslope mode

Measurement error at 30 to 50% modulation.....	≤ ±0.0008 DDM ±0.1% of reading
Resolution (LOC / GS)	0.0001 DDM



DSP out

<u>Localizer:</u>	Range 1	0.0 ±25% ±0 ±0.25 DDM
	Range 2	0.0 ±2.5% ±0 ±0.025 DDM
	Range 3	0.0 ±2.58% ±0 ±0.0258 DDM
	Range 4	0.0 ±50% ±0 ±0.5 DDM
 <u>Glideslope:</u>	Range 1	0.0 ±50% ±0 ±0.5 DDM
	Range 2	0.0 ±5% ±0 ±0.05 DDM
	Range 3	8.75 ±5% ±0.0875 ±0.05 DDM
	Range 4	17.5 ±5% ±0.175 ±0.05 DDM

SDM measurement

SDM 10 to 80%	accuracy 1% absolute
Resolution	0.0001 SDM

VOR signal analysis

Bearing

Accuracy	±0.1°
Resolution	0.05° / 0.01° (Setup)

AM modulation depth

30 Hz and 9,96 kHz

Accuracy	≤1%
Resolution	0.1%

FM deviation

Accuracy	0.5%, ±0.1 Hz
Resolution	0.1 Hz

RS-232-Interface

.....	8N1, adjustable baud rate 1200, 2400, 4800, 9600, 19200
-------	--

General data



Power supply	100 to 240 VAC
(with build-in charger)	50 to 60 Hz (440 Hz option)
	9 to 15 VDC (typ. 12 VDC 1.4 A)
	120 VA max.
built-in battery (option)	12V / 3.2 Ah
	charging while mains is connected
Operating time	>100 min (max. brightness)
	>150 min (at average brightness)
Mechanical resistance	shock-tested to MIL-810D
	vibration-tested to
	DIN-IEC 68-2-36 & 68-2-6

EMC

RF Emissions	complies with EN 50081-1
RF Immisions	complies with EN 50082-1

Temperature range

Operating temp. range	-5°C to +45°C
Storage temp. range	-20°C to +60°C

Dimensions and Weight

Dimensions (WxHxD).....	219 x 147 x 350 mm
Weight	4.9 kg (without battery)
	6.5 kg (with battery)

Order notification

Order-No. EVS200	0796.1800.00
Battery (option)	0796.2012.00

Accessories

Description	Ident No.
Bag for EVS200	TEVS 0798-4264
Alu-tripod for antenna and measuring unit, Notebook, inclusively alignment level	ST1 0798-4270
Rigging set for tripod	AM 0798-4293
Bag for tripod, plate and rigging set	TST 0798-4306
Set halfwave measuring dipoles screened for: 75 MHz and 115 MHz or 335 MHz $\pm 15\%$	MA1 0798-4312
Coaxialcable 50 Ω , RG58 with 1xN/BNC-Connector, 5 m length	KK1 0798-4235
Coaxialcable 50 Ω , RG58 with 1xN/BNC-Connector, 10 m length	KK2 0798-4235
Batterybelt for ext. supply at the EVS200 with internal battery charger (12 V/5 Ah, for approx. 190 min operation time, weight: 2150 g)	BG01 0798-4335
Batterybelt for ext. supply at the EVS200 with internal battery charger (12 V/7 Ah, for approx. 260 min operation time, weight: 2850 g)	BG02 0798-4341
Spiral connecting cable for batterybelt 1.50 m / 2 m for cable BG1 / BG2	KBG1-2 0798-4329
Remote control software for EVS200	SW-EVS 0798-4358

Free Manuals Download Website

<http://myh66.com>

<http://usermanuals.us>

<http://www.somanuals.com>

<http://www.4manuals.cc>

<http://www.manual-lib.com>

<http://www.404manual.com>

<http://www.luxmanual.com>

<http://aubethermostatmanual.com>

Golf course search by state

<http://golfingnear.com>

Email search by domain

<http://emailbydomain.com>

Auto manuals search

<http://auto.somanuals.com>

TV manuals search

<http://tv.somanuals.com>