

Proson

DC DOLBY
DIGITAL
VIRTUAL SPEAKER

DC DOLBY
DIGITAL EX
PRO LOGIC EX

RV2600 DTS

AV Digital Home Theater Receiver

OWNER'S MANUAL

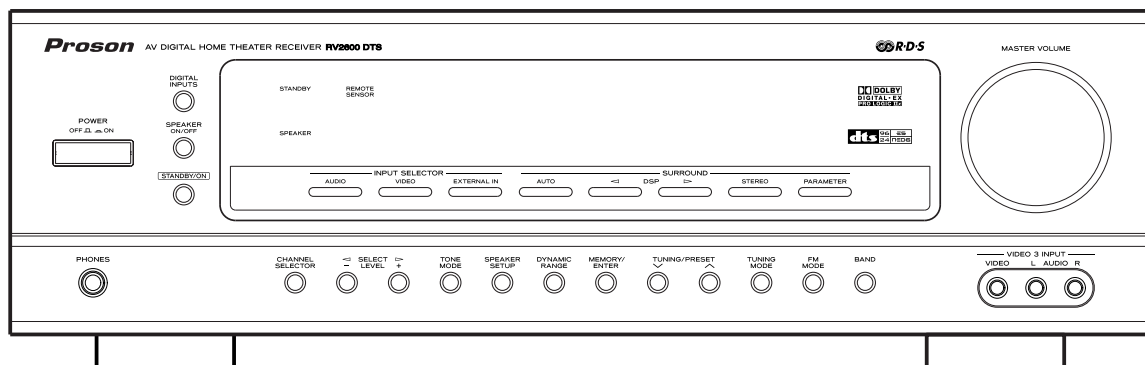

Contents

Thank you for choosing TEAC. Read this manual carefully to get the best performance from this unit.

Contents	2
Before Use	3
How to Reset the Settings to the FACTORY DEFAULTS.....	3
Connection (FM antenna)	4
Connection (AM antenna)	5
Connection	6
Speaker Connections	10
Positioning of the Speakers.....	11
Names of Each Control	12
Battery Installation	15
Speaker Configuration.....	16
Basic Operation.....	20
Dubbing from VIDEO 2 or 3 to VIDEO 1	24
Dubbing the audio and video signals separately.....	24
Surround Mode	25
DOLBY PRO LOGIC IIx MUSIC parameters	29
Dynamic Range Compression.....	30
Tuner	31
Preset Tuning	32
RDS	34
RDS Search.....	35
PTY Programs	36
Troubleshooting.....	37
Specifications	38

“DTS”, “DTS-ES” and “Neo:6” are trademarks of Digital Theater Systems, Inc.

Manufactured under license from Dolby Laboratories. “Dolby”, “Pro Logic” and the double-D symbol are trademarks of Dolby Laboratories.

CAUTION Regarding Placement

To maintain proper ventilation, be sure to leave a space around the unit (from the largest outer dimensions including projections) equal to, or greater than, shown below.

Left and Right Panels: 10 cm
Rear Panel : 10 cm
Top Panel : 50 cm

CAUTION

The product shall not be exposed to dripping or splashing and that no object filled with liquids, such as vases, shall be placed on the product.

Do not install this equipment in a confined space such as a book case or similar unit.

Before Use

Read this before operation

- As the unit may become warm during operation, always leave sufficient space around the unit for ventilation. The ventilation holes should not be covered. Make sure there is at least 50 cm of space above and at least 10 cm of space on each side of the unit. Do NOT place anything on top of the unit.
- The voltage supplied to the unit should match the voltage as printed on the rear panel. If you are in any doubt regarding this matter, consult an electrician.
- Choose the installation location of your unit carefully. Avoid placing it in direct sunlight or close to a source of heat. Also avoid locations subject to vibrations and excessive dust, heat, cold or moisture.
- Do not place the unit on the amplifier/receiver.
- Do not open the cabinet as this might result in damage to the circuitry or electrical shock. If a foreign object should get into the unit, contact your dealer or service company.
- When removing the power plug from the wall outlet, always pull directly on the plug, never yank the cord.
- Do not attempt to clean the unit with chemical solvents as this might damage the finish. Use a clean, dry or slightly damp cloth.
- Keep this manual in a safe place for future reference.

How to Reset the Settings to the FACTORY DEFAULTS

Memory Backup

If the power supply is interrupted for 14 days or longer, the settings kept in memory (such as preset stations and speaker settings) will be erased.

Restoring factory settings

If you have made a lot of changes to the setup, and want to restart from a known set of options, restore the unit to the factory settings as follows:

1. With the unit in the standby mode, briefly press the STANDBY/ON switch while holding down the MEMORY/ENTER button.
 - Release the MEMORY/ENTER button immediately after pressing the STANDBY/ON switch. The model name, etc. appears on the display.
2. Press the MEMORY/ENTER button. The unit turns standby.
3. Press the POWER switch to turn the unit off. All memories are erased, and the unit returns to the factory settings.

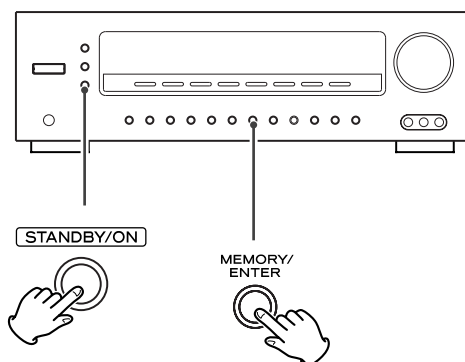

Connection (FM antenna)

CAUTION:

- Switch off the power to all equipment before making connections.
- Read the instructions of each component you intend to use with this unit.
- Be sure to insert each plug securely. To prevent hum and noise, avoid bundling the signal interconnection cables together with the AC power cord or speaker cables.

A FM Indoor Antenna

In an area with strong FM signals, the T-type FM antenna provided with this unit is sufficient.

Extend the antenna into a "T" shape and connect the two wires at the base of the "T" to the provided matching transformer, as shown.

After completing connection, plug the transformer into the "FM 75Ω" socket. Extend the top of the "T" and tune the tuner to your favorite station (see page 31). Adjust the antenna in a suitable location like a window frame or wall until the reception is best and then affix the antenna in that position using thumb tacks, push pins or any other suitable means.

B FM Outdoor Antenna

In an area where FM signals are weak, it will be necessary to use an 75-ohm unbalanced-type outdoor FM antenna. Generally, a 3-element antenna will be sufficient; if you live in an area where the FM signals are particularly weak, it may be necessary to use one with 5 or more elements.

- Disconnect the FM indoor antenna when using an outdoor antenna.

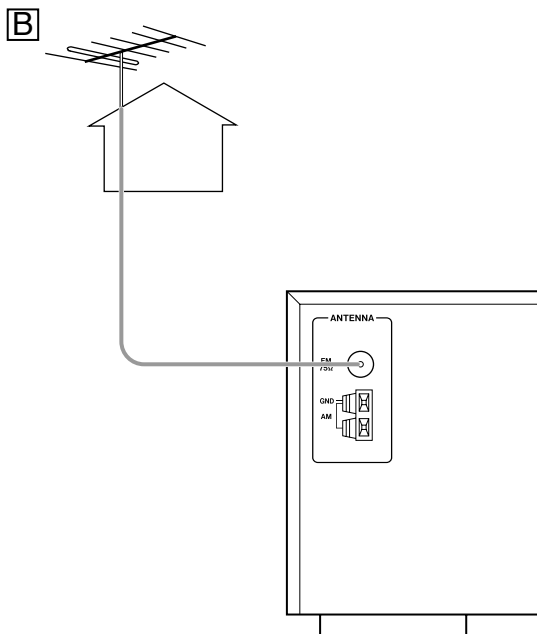
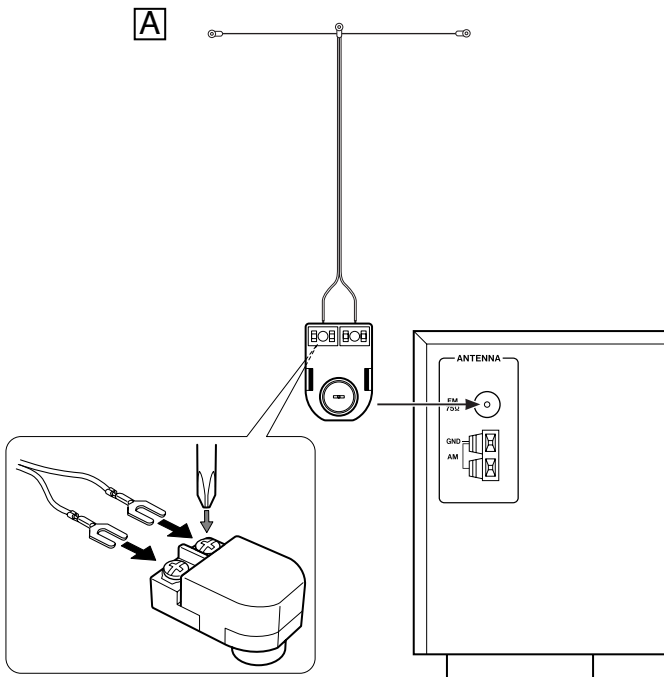

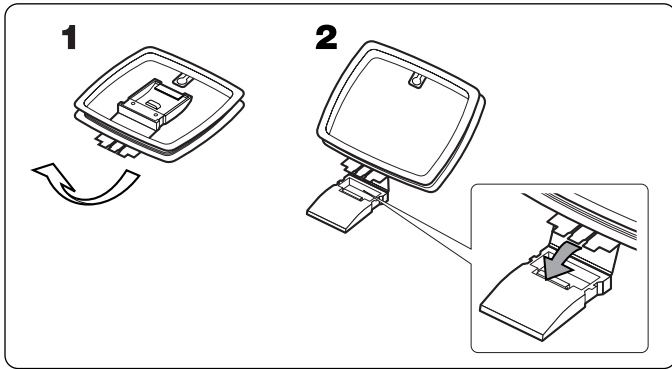

AM Outdoor Antenna
Antenne AM extérieure
Antena exterior AM

AM Loop Antenna
Antenne-cadre AM intérieure
Antena de cuadro de AM interior

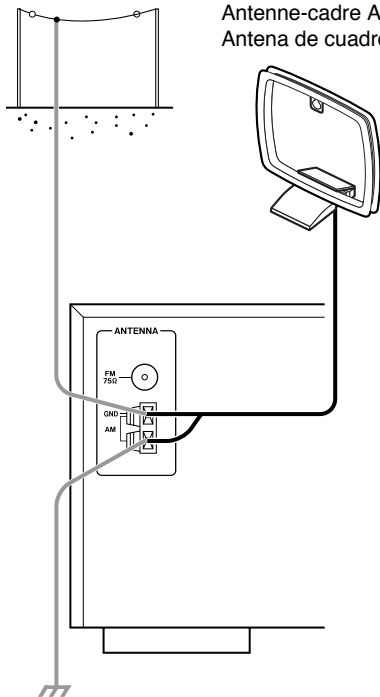

AM Indoor Loop Antenna

The high-performance AM loop antenna provided with this unit is sufficient for good reception in most areas.

To stand the loop antenna on a surface, fix the claw to the slot in the antenna base.

Connect the loop antenna's wires to the AM antenna terminals.

How to connect:

Press the lever, insert the end of the cord, then release the lever. Make sure it is fastened securely by pulling the cord lightly. Make sure only the bare, stripped wire is inserted in the jack and that no plastic insulation is preventing contact between the antenna wire and terminal.

Place the antenna on a shelf or hang it on a window frame, etc., in the direction which gives the best reception. Keep all other wires such as power cords, speaker wires or interconnect wires as far away as possible from the antenna.

- If the AM loop antenna provided does not deliver sufficient reception (often due to being too far from the transmitter or in a concrete building, etc.), it may be necessary to use an outdoor AM antenna.

Use either a high quality commercial AM antenna or, if not available, an insulated wire more than 5 m long, strip one end, and connect this to the terminal as shown.

The antenna wire should be strung outdoors or indoors near a window. For better reception, connect the GND terminal to a reliable ground.

Note:

Even when using an outdoor AM antenna, do not disconnect the AM loop antenna.

Connection 1

CAUTION:

- Switch off the power to all equipment before making connections.
- Read the instructions of each component you intend to use with this unit.
- Be sure to insert each plug securely. To prevent hum and noise, avoid bundling the signal interconnection cables together with the AC power cord or speaker cables.

Connection to audio/video components

A DIGITAL IN terminals

Used for the input of digital audio signals. Connect these digital input terminals to the appropriate digital output terminals of the digital audio source unit such as a DVD or CD player.

Use a good quality RCA coaxial cable or optical digital cable.

B DIGITAL OUT terminal

The digital signals coming in through the DIGITAL IN terminals are sent out through this terminal.

Connect to the digital input terminal of a digital recording device such as a CD recorder using a commercially-available optical digital cable.

When inserting the plug of the optical cable, the protective shutter of the terminal will open and you should hear it click into position when fully inserted. Be careful that you do not force the plug, because this could result in damage to the protective shutter, the cable, or the unit itself.

C AUDIO IN/OUT jacks

Analog 2-channel audio signal is input or output from these jacks. Connect the component with commercially-available RCA cables.

Make sure to connect:

- white plug → white jack (L: left channel)
- red plug → red jack (R: right channel)

D EXTERNAL IN jacks

If your DVD player or decoder has 6 or 7-channel analog audio outputs, connect them with good quality RCA cables.

If the component to be connected has only 6 channel outputs, do not use the SURROUND BACK jack.

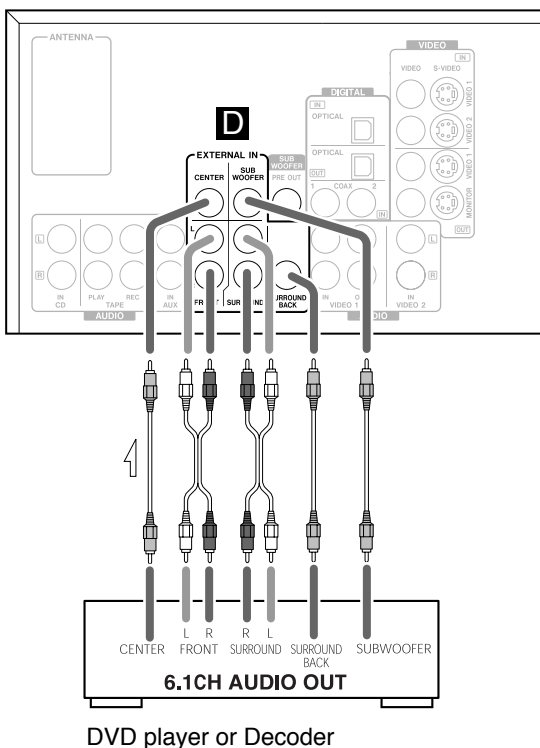
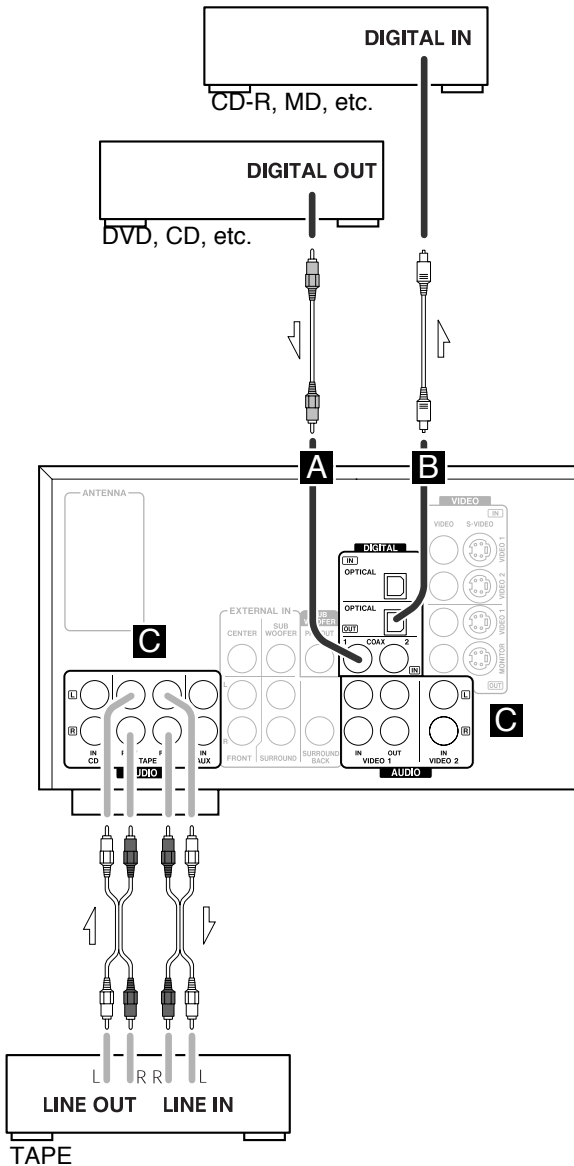

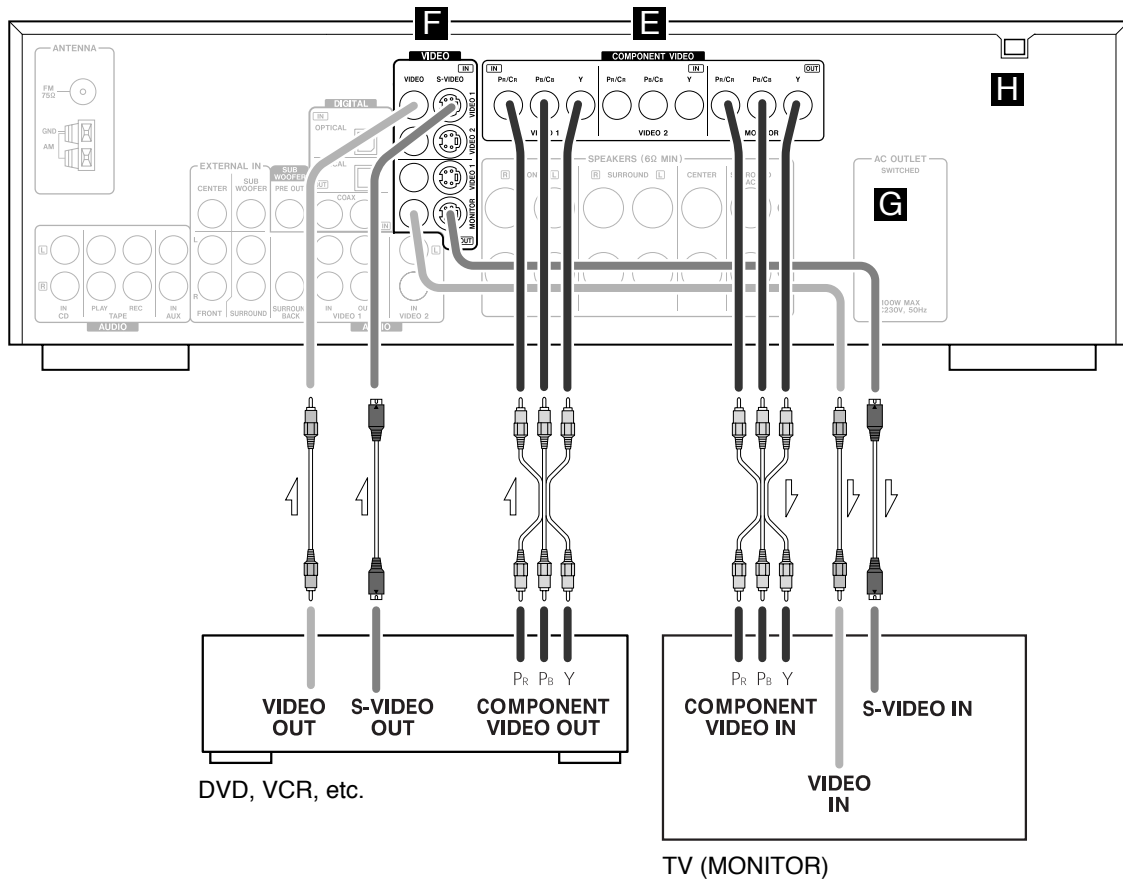

Connection 2

Connection to a TV and video components

E COMPONENT IN/OUT jacks

COMPONENT VIDEO provides the best video quality and should be used as your first choice.

If your DVD player and TV (or monitor) have COMPONENT VIDEO jacks, connect them with quality component video cables.

F S-VIDEO or VIDEO jacks

S-VIDEO connection is your second choice and is superior to the standard composite video connection. If the component has an S-VIDEO jack, connect it with a high quality S-VIDEO cable.

If neither COMPONENT VIDEO nor S-VIDEO is available, connect the component with a high quality RCA cable designed for video applications.

The video signal from COMPONENT, S-VIDEO or VIDEO jacks cannot be mixed.

For example, the signal input into the COMPONENT IN jacks is output from the COMPONENT OUT jacks only. Be sure to connect all the components via the same kind of jacks.

G AC OUTLET (switched)

Not available for AUSTRALIA, UK model. This outlet is active only when the unit is on.

Caution:

Make sure that the total power consumption of all equipment connected to the outlet(s) does not exceed 100 watts.

H AC Power Cord

After all other connections are complete, connect the plug to the AC wall socket.

If you are not going to use the unit for some time, disconnect the power cord from the wall socket. (Leaving the power cord unconnected for longer than 14 days will cause the tuner memory presets to be lost.)

Be sure to connect the power cord to an AC outlet which supplies the correct voltage.

Hold the power plug when plugging or unplugging the power cord.

Example: Connection to Video Cassette Recorders

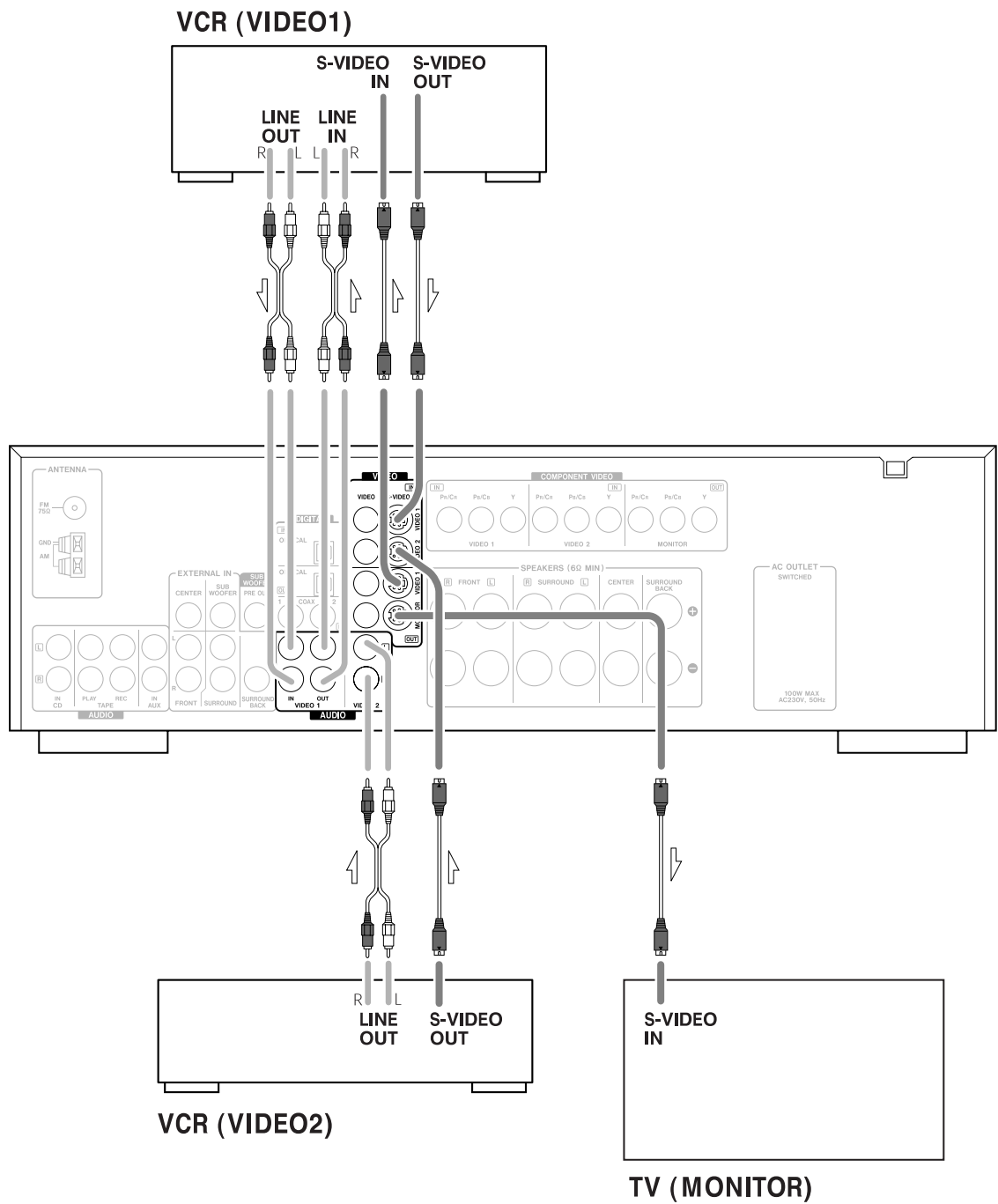

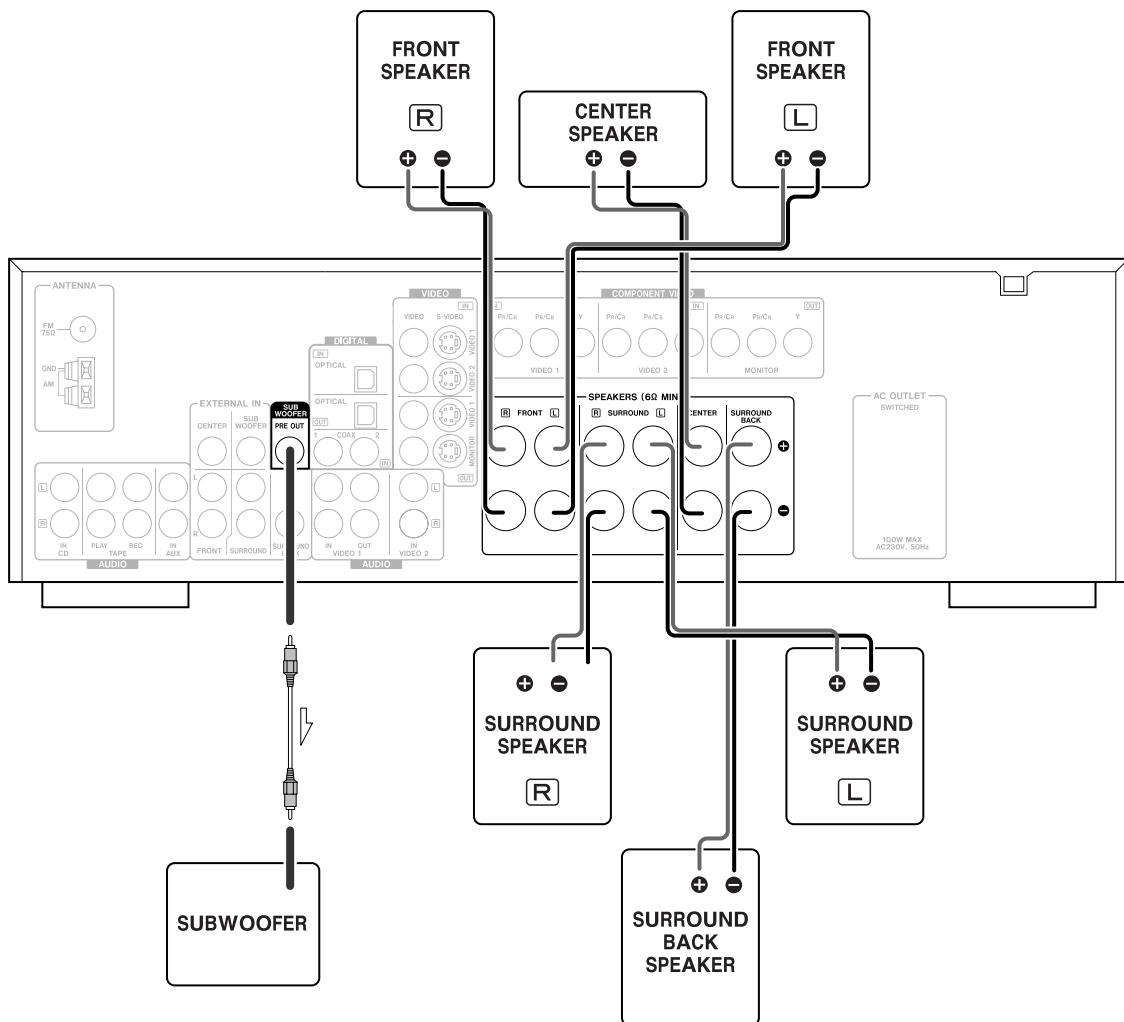

Speaker Connections

Caution:

To avoid damaging the speakers with a sudden high-level signal, be sure to switch the power off before connecting the speakers.

Check the impedance of your speakers. Connect speaker with an impedance of 6 ohms or more.

The black speaker terminals are \ominus (negative). Generally, the \oplus side of the speaker cable is marked to make it distinguishable from the \ominus side of the cable. Connect this marked side to the \oplus terminal and the unmarked side to the black \ominus terminal.

Prepare the speaker cables for connection by stripping off approximately 10 mm or less of the outer insulation. (Removing too much insulation may lead to a short circuit if the bared wires should come in contact with each other.) Twist the strands of the stripped wires tightly together :

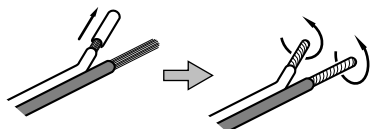

Caution:

The metal portions of the two separate wires should not touch or an electrical short can occur. Shorted wires can create a fire hazard or induce a failure in your equipment.

How to connect:

1. Turn the terminal cap counterclockwise to loosen it. The speaker terminal caps cannot be fully removed from the base.
2. Insert the wire into the terminal fully and turn the terminal cap clockwise to securely connect it:

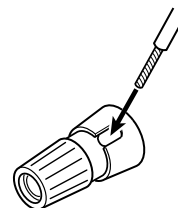

Make sure none of the wire insulation is under the terminal, only the bare, stripped wire.

3. Make sure it is fastened firmly by pulling the cable lightly.

Positioning of the Speakers

The positioning of speakers differs according to the size and acoustics of the listening room. While actually listening to a program source, try various speaker positions to determine which layout provides the best surround effect.

- Ideally, position all the speakers in a circle, with the same distance from your listening position.
- Place the speakers connected to “L” to your left, and “R” to your right.

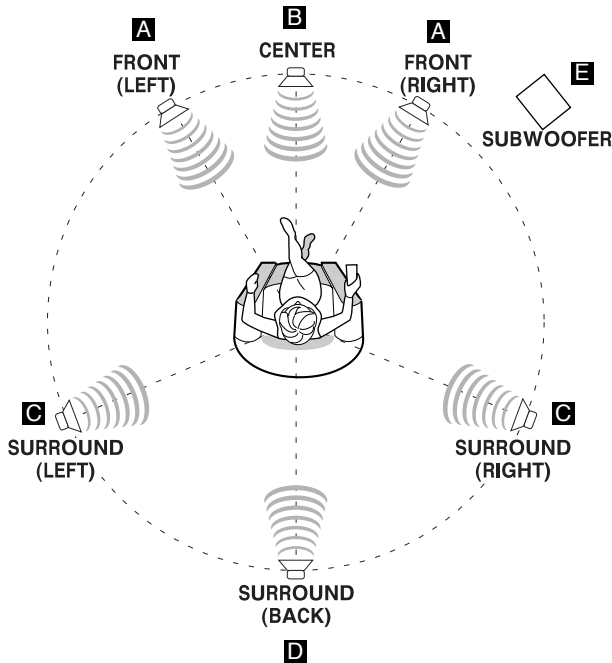

A Front speakers

Use magnetically shielded speakers, if you are using them near your TV.

Place the front speakers in front of the listening position, to the left and right of a TV.

Front speakers are required for all surround modes.

B Center speaker

Use a magnetically shielded speaker if you are using it near your TV. Place a center speaker between the front speakers, on or below the TV. This speaker stabilizes the sound image.

C Surround Left and Right speakers

Install these speakers above the level of the listener's ears, directly to the left and right (or slightly behind) of your listening position.

D Surround Back speaker

Place the surround back speaker at the back of the listening position facing the front at a slightly higher position than the surround left and right speakers. Point slightly downward.

E Subwoofer

Reproduces powerful and deep bass sounds.

Use a sub-woofer with built-in amplifier referred to as a “powered sub-woofer”. Subwoofers are most effective when placed on or near the floor and in a corner of the room. Refer to the instructions that came with your sub-woofer for placement suggestions.

Names of Each Control 1

Front Panel

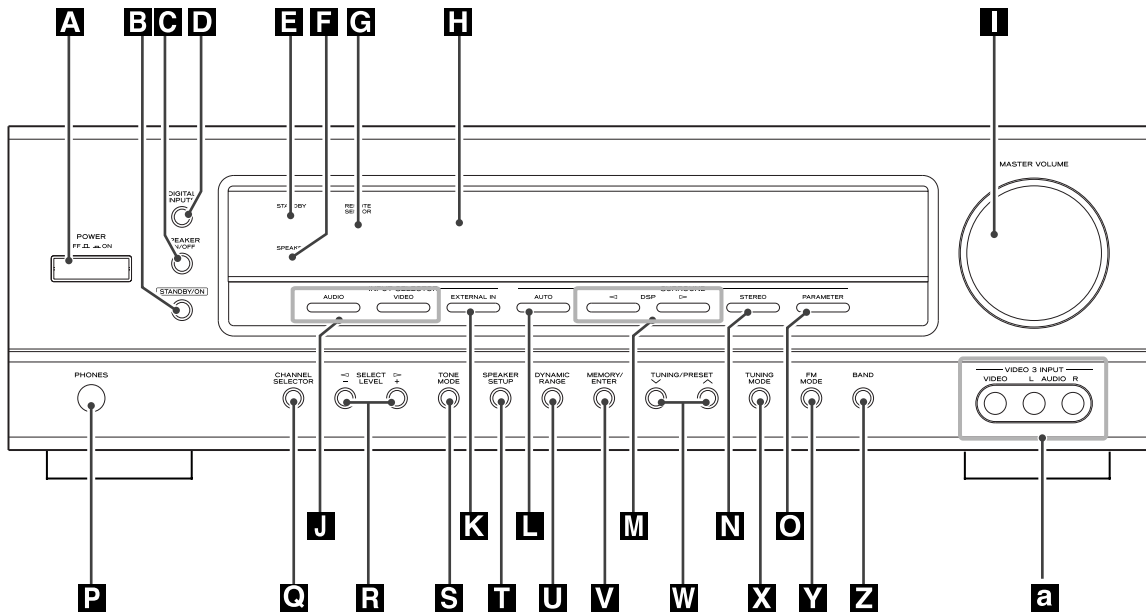

Remote Control Unit

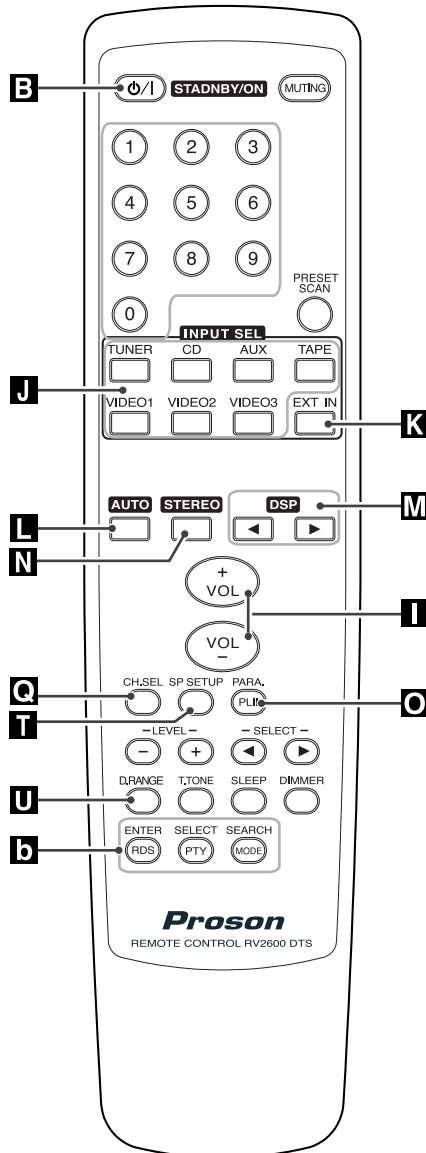

A POWER

Press this switch to turn the unit standby or off.

The equipment draws nominal non-operating power from the AC outlet with its POWER switch in the OFF position.

B STANDBY/ON

When the POWER switch of the main unit is depressed, use this button to turn the unit on or standby.

C SPEAKER

Use this button to turn on or off the speakers.
 on : Sound is output from the speakers.
 off : No sound is output from the speakers.

D DIGITAL INPUTS

Use this button to select one of the digital input terminals.

E Standby indicator

This indicator lights when the unit is in the standby mode. When the unit is turned on, it goes off.

F Speaker indicator

This indicator lights when the SPEAKER button is set to on.

G Remote Sensor

When operating the remote control unit, point it towards the remote sensor.

H Display

When the unit is on, the current status of the unit is displayed.

I MASTER VOLUME

Turn this knob (or press the VOLUME buttons of the remote control unit) to adjust the master volume.

J INPUT SELECTOR

Use this buttons to select a source.

K EXTERNAL IN

Use this button to select the source connected to the EXTERNAL IN jacks.

L AUTO

Use this button to change the decoding mode of digital signals.

M DSP

Use these buttons to select a surround mode.

N STEREO

Use this button to select stereo mode. Sound is output only from the front speakers (and the sub-woofer).

O PARAMETER

Use this button to change parameters of DOLBY PRO LOGIC IIx MUSIC.

P PHONES

For private listening, insert the headphones plug into this jack, and adjust the volume by turning the MASTER VOLUME knob.

Q CHANNEL SELECTOR

Select a speaker by pressing this button repeatedly, and adjust the level using the LEVEL buttons.

R SELECT/LEVEL

Use these buttons to adjust the level of each speaker, etc.

S TONE MODE

Use this button to select a tone mode.

T SPEAKER SETUP

Use this button to start speaker configuration.

U DYNAMIC RANGE

Use this button to compress the dynamic range during playback of a disc recorded in Dolby Digital.

V MEMORY/ENTER

Use this button to store preset channels into memory.

W TUNING/PRESET

In the manual tuning mode, use these buttons to tune in a station.

In the preset tuning mode, use these buttons to select a preset channel.

X TUNING MODE

Use this button to select a tuning mode.

Y FM MODE

In FM tuner mode, use this button to select stereo or monaural.

Z BAND

Use this button to select FM or AM.

a VIDEO 3 INPUT jacks

You can connect a component such as a portable CD, game player, etc. to these jacks.

When using these jacks, remove the cap. When you don't use them, leave the cap in place.

b Buttons for RDS function (European models only)

In FM tuner mode, use these buttons for RDS function.

RDS is available in European countries only.

Names of Each Control 2

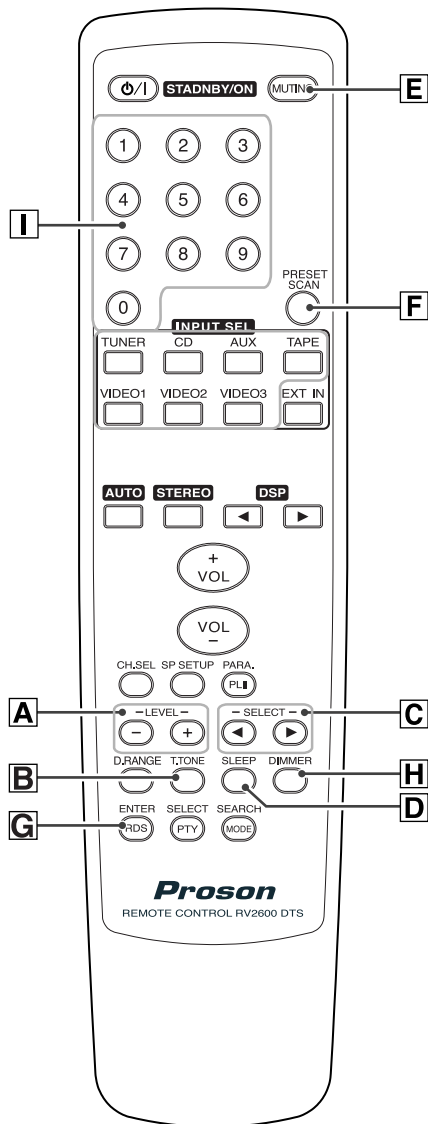

Remote Control Unit

A LEVEL

Use these buttons to adjust the level of each speaker.

B T.TONE

Use this button to output the test tone.

C SELECT

After pressing the SP SETUP or the PARAMETER button, use these buttons to change the setting.

D SLEEP

Use this button to set sleep timer.

E MUTING

Use this button to mute the sound temporarily.

F PRESET SCAN

Use this button to scan preset channels.

G ENTER

Use this button to save speaker setup.

H DIMMER

Use this button to dim or turn off the display.

I Numeric buttons

In tuner mode, use these buttons to select a preset channel.

Note:

- To simplify explanations, instructions refer to names of buttons and controls on the front panel, making no mention of the use of remote control unit.

Front Panel Display

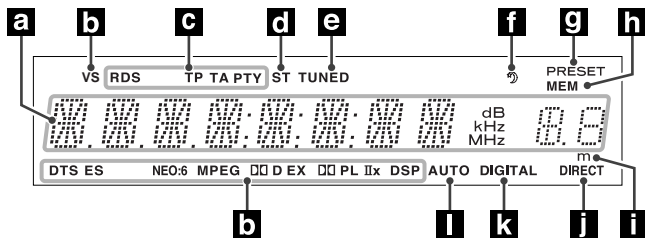

- a** displays current status.
- b** surround mode
- c** illuminates when RDS function is active.
- d** illuminates when the multi-channel sound is downmixed to stereo, or when an FM stereo broadcast is tuned.
- e** illuminates when a station is tuned.
- f** illuminates when sleep timer is set.
- g** illuminates when preset tuning mode is selected.
- h** blinks when the MEMORY/ENTER button is pressed.
- i** meter
- j** illuminates when tone control is set to off.
- k** illuminates or blinks when a digital source is selected.
- l** illuminates when the decoding mode is set to "IN-AUTO".

1. Remove the battery compartment cover.

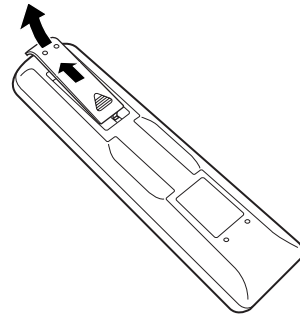

2. Insert two "AAA" (R03, UM-4) dry batteries. Make sure that the batteries are inserted with their positive " \oplus " and negative " \ominus " poles positioned correctly.

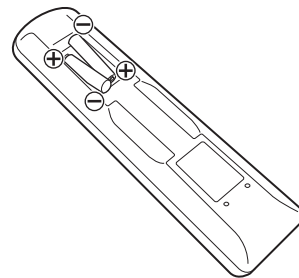

3. Close the cover.

Battery Replacement

If the distance required between the remote control unit and main unit decreases, the batteries are exhausted. In this case replace the batteries with new ones.

Precautions concerning batteries

- Be sure to insert the batteries with correct positive " \oplus " and negative " \ominus " polarities.
- Use batteries of the same type. Never use different types of batteries together.
- Rechargeable and non-rechargeable batteries can be used. Refer to the precautions on their labels.
- When the remote control unit is not to be used for a long time (more than a month), remove the batteries from the remote control unit to prevent them from leaking. If they leak, wipe away the liquid inside the battery compartment and replace the batteries with new ones.
- Do not heat or disassemble batteries and never dispose of old batteries by throwing them in a fire.

Speaker Configuration 1

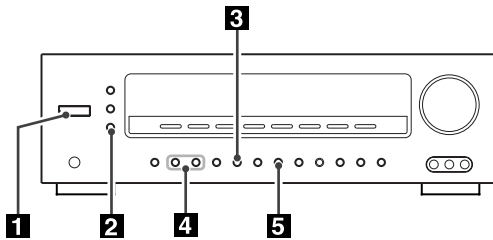

1

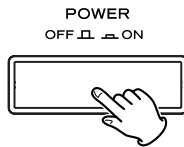

2

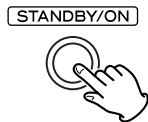

3



4

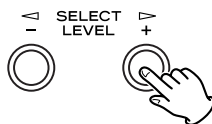

5



It is important to perform speaker configuration prior to using the unit.

To enjoy multi-channel surround sound, such as 5.1, you need 5 speakers (Front Left, Center, Front Right, Surround Right, Surround Left) and a powered sub-woofer.

In addition to above, you will need a surround back speaker for 6.1 channel surround sound.

- When no action is taken for 8 seconds, the Speaker Setup mode will be cancelled.

1 Press the POWER button.

The unit enters standby mode, and the STANDBY indicator lights.

2 Press the STANDBY/ON switch to turn the unit on.

The STANDBY indicator goes off.

3 Press the SPEAKER SETUP button.

“SUB-W Y” or “SUB-W N” appears on the display.

Each time the SPEAKER SETUP button is pressed, the mode is changed as follows:

- sub-woofer setting
- speaker size setting (Front)
- speaker size setting (Center)
- speaker size setting (Surround)
- speaker size setting (Surround Back)
- distance (Front Left)
- distance (Front Right)
- distance (Center)
- distance (Surround Left)
- distance (Surround Right)
- distance (Surround Back)
- Crossover Frequency

- The SPEAKER SETUP button will not work when the SPEAKER button is set to off. In that case, press the SPEAKER button to turn the speakers on and then press the SPEAKER SETUP button.

- The SPEAKER SETUP button will not work when EXTERNAL IN is selected. In that case, press the EXTERNAL IN button to turn it off and then press the SPEAKER SETUP button.

4 Press the SELECT buttons to change the setting.

For details of each setting, see page 17 to 19.

Repeat step **3** and **4** to set other configurations.

5 When all the configurations has been finished, press the MEMORY/ENTER button to save the changes and exit the Speaker Setup mode.

Be sure to press the MEMORY/ENTER button within 8 seconds, or the changes will be cancelled.

Abbreviations

FRONT L: front left
FRONT R: front right
CENTER: center
SURR L: surround left
SURR R: surround right
SURR-B: surround back

Subwoofer Setting

SUB W-Y (Subwoofer-Yes):

Select this when a powered sub-woofer is connected.

SUB W-N (Subwoofer-No):

Select this when no sub-woofer is connected.

- If you select “SUB-W N (no subwoofer)”, the front speaker is automatically set to “L”.
- To enjoy the full home theater experience, we recommend the use of a powered sub-woofer.

Speaker Size Setting

Each time the SELECT button is pressed, the setting is changed as follows:

L (Large):

Select this when the connected speakers can fully reproduce sounds below the Crossover Frequency.

S (Small):

Select this when the connected speakers are rather small and cannot reproduce sounds below the crossover frequency.

When this setting is selected, bass frequencies below the crossover frequency are output from the sub-woofer (if no sub-woofer is connected, from the front speakers).

N (None):

Select this when no speaker is connected. The sound is output from the front (or surround) speakers.

- Depending on your selection, settings available for each speaker changes.
- When the surround left and right speakers are set to “SURR N (none)”, the surround back speaker is also set to “SURR-B N (none)” automatically.

Distance (front, center, surround)

Input the distance from your listening position to front, center and surround speakers. The delay time is automatically adjusted to improve the surround effect.

You can change the setting from 0.1 to 9 meters, at 0.1 meter's step.

Crossover Frequency

You can change the setting from 40 to 130 Hz in 10 Hz steps.

When the speaker size is set to “Small”, bass frequencies below the crossover frequency you set here are output from the sub-woofer (if no sub-woofer is connected, from the front speakers).

The default setting is 80 Hz.

Balancing relative volume between speakers using Test Tone

The test tone function is useful to adjust the relative volume between speakers.

Once the balance is set, you don't have to change the balance as long as the speakers aren't moved.

- It is also possible to adjust the relative volume during playback of DVD. See 19 page for details.
- Use the remote control from your listening position.
- The T.TONE button will not work when the SPEAKER button is set to off. In that case, press the SPEAKER button to turn the speakers on.
- The T.TONE button will not work when EXTERNAL IN is selected. In that case, press the EXTERNAL IN button to turn it off.

1 Press the T.TONE button.

The test tone is emitted from each speaker in the following order at 2.5-second intervals.

FL, C, FR, SR, SB, SL, SW

- If certain speakers are not being used, (for example, no center speaker) the noise sequencer will automatically skip over that channel.

2 Adjust the master volume to the normal listening level.

3 Adjust the volume of each speaker so that the test tone from each speakers sounds the same.

- The level of the speaker emitting the test tone can be changed by pressing the LEVEL buttons.
- The level can be adjusted in 1 dB steps from -15 dB to +15 dB.
- If you press the CH.SEL (CHANNEL SELECTOR) button, the test tone stays there. To go to the next speaker, press the CH. SEL button again.

4 When the setting has been finished, press the T.TONE button to stop the test tone.

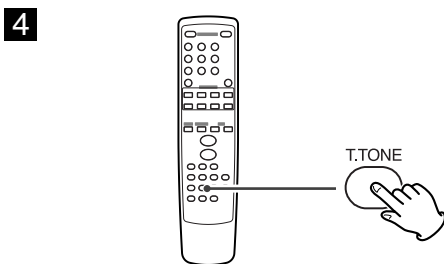
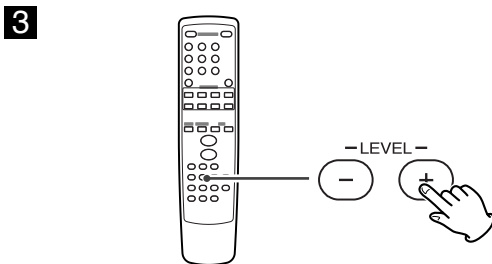
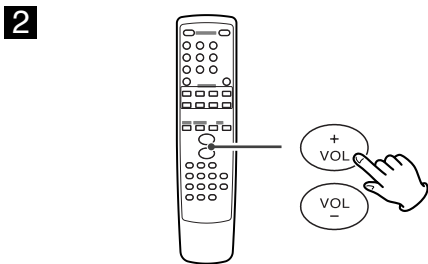
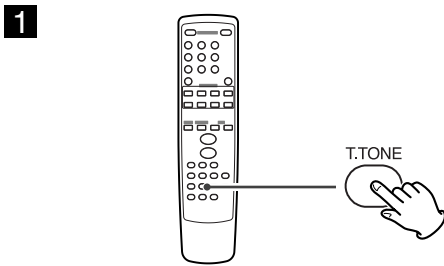

Balancing relative volume between speakers during playback of DVD

1

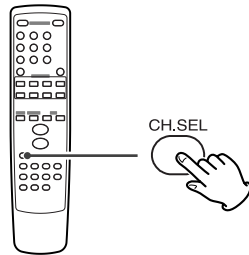

1 (During playback of DVD,) press the CH.SEL (CHANNEL SELECTOR) button.

Each time the CH.SEL button is pressed, the channel is changed as follows:

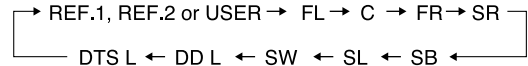

REF.1 or REF.2: stored setting

USER: "USER" appears only when the current setting is different from REF.1 or REF.2.

If the balance has already been set using the test tone function, you don't have to change the setting of speakers.

If you want to change the LFE level for Dolby Digital or DTS, press the CH.SEL button repeatedly until "DD L (Dolby Digital LFE)" or "DTS L (DTS LFE)" appears on the display.

(LFE: Low Frequency Effect)

- A speaker set to "None" or "No" will not appear on the display.
- When STEREO or Virtual Surround is selected, or when the SPEAKER button is set to off, only the front speakers will appear on the display.

2

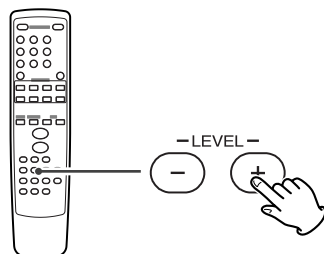

2 Within 5 seconds, press the LEVEL buttons to change the level.

- The level of speakers can be adjusted in 1 dB steps from -15 dB to +15 dB.
- The LFE level can be adjusted in 1 dB steps from -10 dB to 0 dB. The default setting is 0 dB. Lower the LFE level if necessary.

Repeat step **1** and **2** to change other settings.

When all the configurations have been finished, leave the unit idle for 5 seconds to exit the Channel Select mode.

How to store your channel level setting

1. When all the settings have been finished in step 2, press the MEMORY/ENTER button of the main unit. "1" blinks on the display.
2. Within 5 seconds, press the LEVEL button to select "REF.1" or "REF.2".
3. Within 3 seconds, press the MEMORY/ENTER button to save and exit.

How to call the stored setting

1. Press the CH.SEL button to display USER, REF.1 or REF.2.
2. Press the LEVEL button to select "REF.1" or "REF.2".

Basic Operation 1

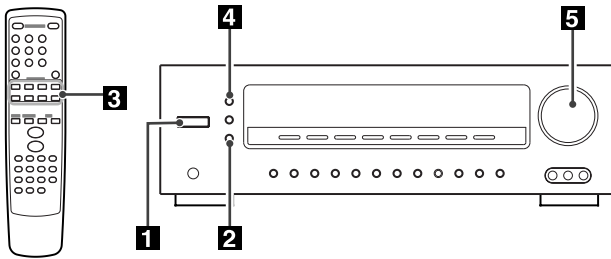

1

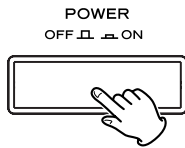

2

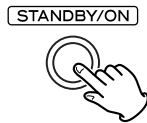

3

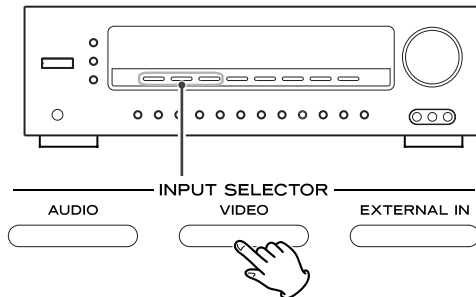

- Each time the “AUDIO” button is pressed, the input source changes as follows;

→ TUNER → CD → TAPE → AUX
(frequency display)

- Each time the “VIDEO” button is pressed, the input source changes as follows;

→ VIDEO 1 → VIDEO 2 → VIDEO 3

4



5

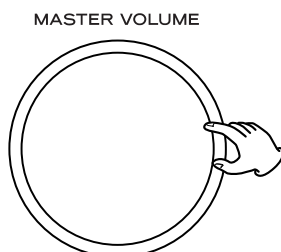

- 1** Press the POWER switch.

The unit enters standby mode, and the standby indicator lights.

- 2** Press the STANDBY/ON switch to turn the unit on.

The power indicator lights, and the standby indicator goes off.

- 3** Select a source by pressing one of the INPUT SELECTOR buttons (or pressing one of the INPUT SEL buttons of the remote control unit).

The selected source is shown on the front panel's display.

- If one of the INPUT SELECTOR buttons or EXT IN button of the remote control unit is pressed in the standby mode, the unit is turned on with the selected source automatically.

- If the source is connected to EXTERNAL IN jacks, press the EXTERNAL IN button and proceed to step **5**.

- 4** When you selected VIDEO(1, 2 or 3) or CD in step **3**, press the DIGITAL INPUTS button repeatedly to select the terminal.

o1: Select this when the source is connected to DIGITAL IN (OPTICAL 1) terminal.

c1: Select this when the source is connected to DIGITAL IN (COAXIAL 1) terminal.

c2: Select this when the source is connected to DIGITAL IN (COAXIAL 2) terminal.

A: Select this when the source is connected to analog AUDIO IN jacks.

- DIGITAL indicator blinks when the unit cannot perceive the digital signal. In that case, connect a digital device to the DIGITAL IN terminal, switch it on, and select the terminal by pressing the DIGITAL INPUTS button.

- You can hear the sound from the selected DIGITAL IN terminal as far as VIDEO (1,2 or 3) or CD has been selected in step **3**.

- 5** Play the source, and gradually turn up the volume to the required level by turning the VOLUME knob.

Recording a Source

1. Select a source to be recorded by pressing the INPUT SELECTOR buttons (or pressing one of the INPUT SEL buttons of the remote control unit).
2. Start recording.

- The volume and tone control have no effect on the recording signals.

- The analog signals input from the EXTERNAL IN jacks cannot be recorded.

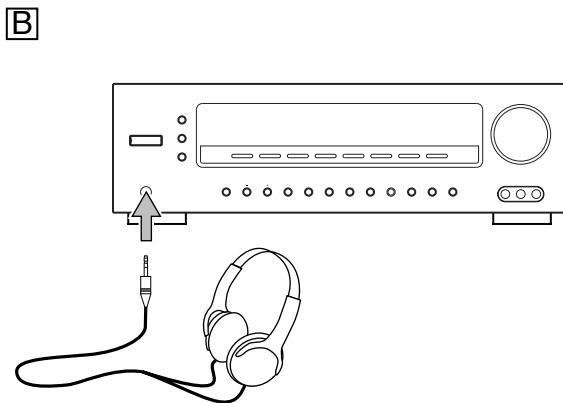
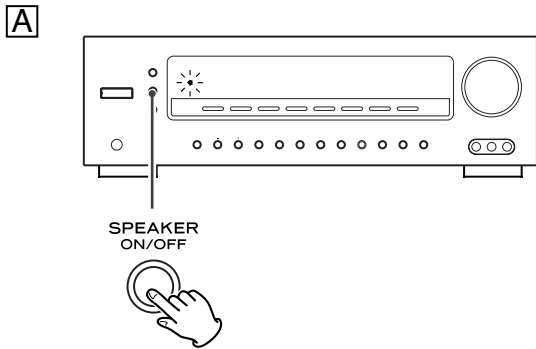

A Speaker On/Off

Press the SPEAKER button to turn the speakers on or off. When ON is selected, the SPEAKER indicator lights.

B Headphones

For private listening, first reduce the volume level on the receiver to minimum. Then insert the plug from your headphones into the PHONES jack, and adjust the volume by turning the VOLUME knob.

If you want to cut off the sound from speakers, press the SPEAKER button to turn it off.

- When the SPEAKER button is set to off, the multi-channel sound is downmixed to 2 channel automatically.
- When EXTERNAL IN is selected, only the front left and right channels are output from the PHONES jack.

C

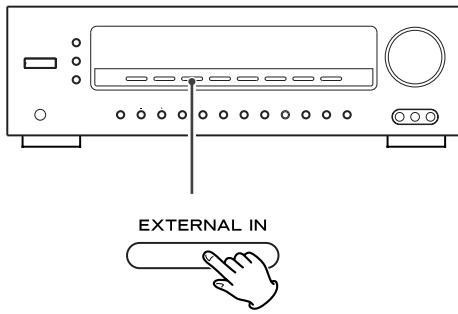

C EXTERNAL IN (7 channel direct input)

If the source is connected to EXTERNAL IN jacks, press the EXTERNAL IN button. "EXT IN" appears on the display, and up to 7 discrete analog signals can be heard from speakers.

Press the EXTERNAL IN button again (or select any other source by turning the INPUT SELECTOR button) to cancel the EXTERNAL IN function.

D

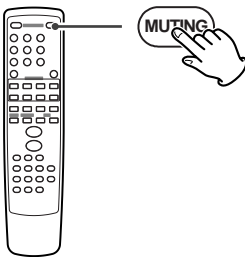

D Muting

To mute the sound temporarily, press the MUTING button. Press the MUTING button again to restore the sound. If you change the volume during the muting, the muting will be cancelled.

- While muting is engaged, "MUTE" blinks on the display.

E

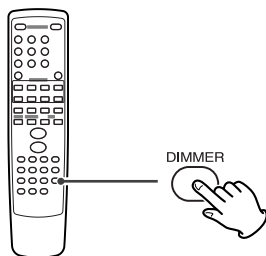

E Dimmer

You can dim or turn off the front panel's display by pressing the DIMMER button:

- When the display is turned off, pressing any button will turn the display on.
- This function will be cancelled when the STANDBY/ON or the POWER switch is pressed.
- When you set the sleep timer, the display is dimmed automatically.

F

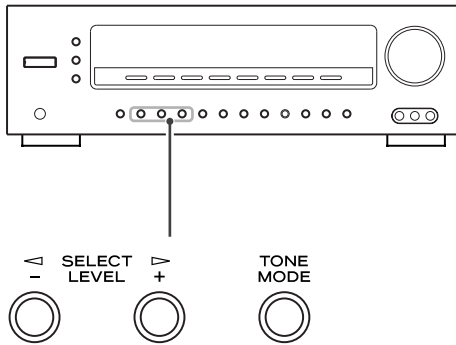

F Tone Control

1. Press the TONE MODE button.
"TONE OFF" or "TONE ON" appears on the display.
 - If no button is pressed for 5 seconds, the tone mode will be cancelled.
 - The TONE MODE button will not work when EXTERNAL IN is selected.
2. If the tone mode is off, press the LEVEL button to turn it on.
3. Press the TONE MODE button to select "BASS" or "TRBL".
Each time the TONE MODE button is pressed, the mode is changed as follows:

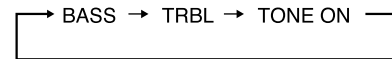

To adjust the level of low frequency sound range, select "BASS".

To adjust the level of high frequency sound range, select "TRBL (treble)".

4. Press the LEVEL buttons to change the setting.
The level can be adjusted in 1 dB steps from -10 to +10.
 - If you want to turn off the tone mode, select "TONE ON" and press the LEVEL button to turn it off. "DIRECT" indicator lights.
 - Tone control does not work when the digital signals of DTS or Dolby Digital are input, or when EXTERNAL IN is selected.

G

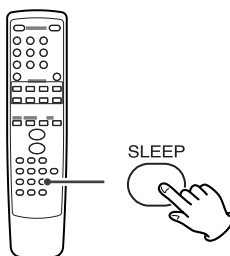

G Sleep Timer

The power can be switched off after a specified amount of time.

Press the SLEEP button repeatedly until desired time appears on the display.

SLEEP 10 (20 ... 90):

The power will be switched off 10 (20 ... or 90) minutes later.

Normal display: the sleep timer is off.

When you set the sleep timer, the display is dimmed, and the remaining time is displayed.

Dubbing from VIDEO 2 or 3 to VIDEO 1

- 1 Select VIDEO 2 or 3 by pressing the VIDEO button.
- 2 Start recording on the VCR connected to VIDEO 1 REC jacks.
- 3 Start playback on the VCR connected to VIDEO 2 or 3 INPUT jacks.

The audio and video signals input from VIDEO 2 or 3 are output from VIDEO 1 REC jacks.

- Copy protected DVD discs cannot be dubbed.
- The video signal from S-VIDEO or VIDEO jacks cannot be mixed. Be sure to connect all the components via the same kind of jacks.

Dubbing the audio and video signals separately

While dubbing the video signal of VIDEO 2 or 3, you can replace the sound from VCR with the sound from an audio source such as CD.

- 1 Select the video source to be recorded (VIDEO 2 or 3) using the INPUT SELECTOR buttons of the remote control unit.
- 2 Select the audio source to be recorded (CD, TAPE, etc.) using the INPUT SELECTOR buttons of the remote control unit. Do not turn the INPUT SELECTOR buttons of the main unit, or the video source selection in step 1 might be cancelled.
- 3 Start recording on the VCR connected to VIDEO 1 REC jacks.
- 4 Start playback of the video and audio source to be recorded.
The picture from the video component appears on the TV, and the sound from the audio component is output from the speakers.

1

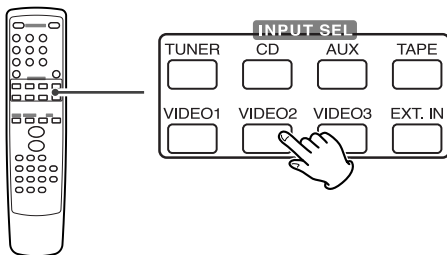

2

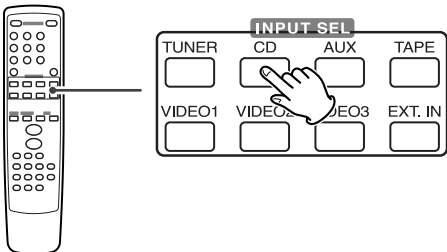

Surround Mode 1

1

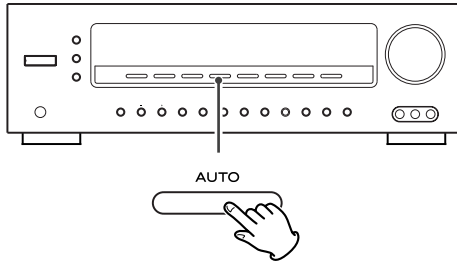

2

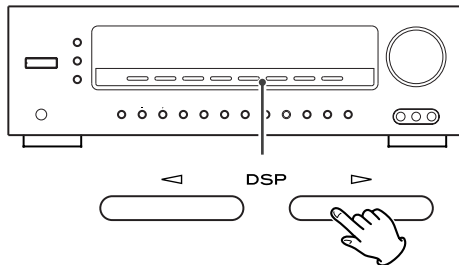

- When EXTERNAL IN is selected, the DSP and the AUTO button do not work.

1 If a digital device is connected to DIGITAL IN terminals, select desired decoding mode by pressing the AUTO button.

Each time the AUTO button is pressed, the decoding mode is changed as follows:

IN-AUTO (default):

The appropriate decoding mode is selected automatically. Usually, select this.

IN-DTS:

Select this only when the input signal is DTS.

IN-PCM:

Select this only when the input signal is PCM.

- The AUTO button works only when the function is set to VIDEO or CD and the digital input is selected.
- When IN-AUTO is selected, noise may be heard during playback of a DVD recorded in DTS format. In this case, select IN-DTS.
- If the selected decoding mode does not match with the input signal, "DIGITAL" indicator will blink and no sound will be heard.

2 Select the desired surround mode by pressing the DSP button.

Each time the DSP button is pressed, the surround mode changes.

A When Dolby Digital signals are input and IN-AUTO is selected, the surround mode is set to DOLBY DIGITAL automatically.

If you press the DSP button, you can select one of the following surround modes:

When the source is Dolby Digital EX:

DOLBY DIGITAL EX, VIRTUAL NARROW, VIRTUAL WIDE

When the source is Dolby Digital 5.1:

DOLBY DIGITAL, VIRTUAL NARROW, VIRTUAL WIDE, DOLBY PRO LOGIC IIx MOVIE, DOLBY PRO LOGIC IIx MUSIC

When the source is Dolby Digital 2-channel:

DOLBY PRO LOGIC IIx MOVIE, DOLBY PRO LOGIC IIx MUSIC, DOLBY PRO LOGIC, VIRTUAL NARROW, VIRTUAL WIDE

B When DTS signals are input and IN-AUTO or IN-DTS is selected, the surround mode is set to DTS or DTS-ES automatically.

If you press the DSP button, you can select one of the following surround modes:

When the source is DTS-ES:

DTS-ES

When the source is DTS:

DTS, DTS+NEO:6

☐ When MPEG signals are input and IN-AUTO is selected, the surround mode is set to MPEG automatically. The DSP button doesn't work.

☐ When the source is PCM (2-channel stereo) and IN-AUTO or IN-PCM is selected, or when analog stereo signals are input, you can select one of the following surround modes:

DOLBY PRO LOGIC IIx MOVIE, DOLBY PRO LOGIC IIx MUSIC, DOLBY PRO LOGIC, VIRTUAL NARROW, VIRTUAL WIDE, DTS NEO:6 CINEMA, DTS NEO:6 MUSIC, THEATER, HALL, STADIUM

- When the DSP button is pressed once, the current surround mode is displayed. Press the DSP button repeatedly to select any other surround mode.
- When you press the DSP button, the sound is cut off for a moment.
- When the surround back speaker is set to "None", Dolby Pro Logic II appears instead of Dolby Pro Logic IIx.
- DOLBY DIGITAL or DOLBY DIGITAL EX can be selected only during playback of a DVD disc recorded in DOLBY DIGITAL format.
- The DSP indicator lights when THEATER, HALL or STADIUM is selected.
(DSP: Digital Signal Processor)

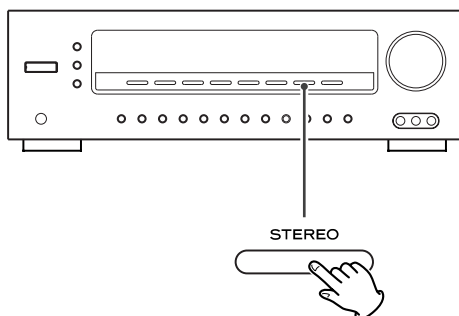

STEREO

Press the STEREO button to select the stereo mode. "STEREO" is scrolled, and sound is output from front speakers (and the sub-woofer if connected).

To cancel the stereo mode, select any other surround mode by pressing the DSP button.

- If you select the stereo mode while the digital signal of DOLBY DIGITAL or DTS are being input, the multi-channel sound is downmixed to 2-channel.
- If the SPEAKER button is set to off while the digital signal of DOLBY DIGITAL or DTS are being input, the multi-channel sound is downmixed to 2-channel automatically. And when the SPEAKER button is set to on, it will return to the previous surround mode.

DTS (DTS Digital Surround)

During playback of a DVD disc recorded in DTS format, the surround mode is set to DTS automatically.

DTS Digital Surround delivers up to 5.1 channels with lower audio compression than Dolby Digital. It provides the clarity and dynamics of the original master soundtrack.

DTS-ES (Extended Surround)

This is a new multi channel digital signal format that greatly improves the 360-degree surround impression and space expression thanks to further expanded surround signals. This format is compatible with the conventional DTS format. In addition to the 5.1 channels of DTS, DTS-ES also offers the surround back (sometimes also referred to as "surround center") channel for surround playback with a total of 6.1 channels. For the optimum playback of DTS-ES, you need 6 speakers and a powered sub-woofer.

- The surround back channel information is matrixed into the surround left and right channels. When played with 5 speakers, the surround back channel signals are output from the surround left and right speakers so that none of the signal components are lost.

There are two formats for DTS-ES:

DTS-ES Discrete 6.1

Because the signals for 6.1 channels (including the surround back channel) are fully independent, it is possible to achieve a sense that the acoustic image are moving about freely among the background sounds surrounding the listener from 360 degrees.

DTS-ES Matrix 6.1

With this format, the additional surround back channel signals undergo matrix encoding and are input to the surround left and surround right channels beforehand. During playback, they are decoded to the surround left, surround right and surround back channels.

When DTS-ES Discrete 6.1 or Matrix 6.1 sources are decoded with a DTS-ES decoder, the format is automatically detected upon decoding and the optimum surround mode is selected.

DTS NEO:6

With the high precision digital matrix decoder used for DTS-ES Matrix 6.1, DTS NEO:6 gives you 6.1 multi-channel surround sound from any stereo source.

- DTS NEO:6 will not work on monaural source.

DTS NEO:6 Cinema

This mode is optimized for movies.

Decoding is performed with emphasis on separation performance to achieve the same atmosphere with 2-channel sources as with 6.1-channel sources.

DTS NEO:6 Music

This mode is suitable for music.

The front left and front right signals bypass the decoder and are played directly so there is no loss of sound quality, and the effect of the surround signals from the center, surround left, surround right and surround back channels adds a natural sense of expansion to the sound field.

Dolby Digital

During playback of a DVD disc recorded in DOLBY DIGITAL format, the surround mode is set to DOLBY DIGITAL or DOLBY DIGITAL EX automatically.

Dolby Digital delivers up to 5 totally discrete, full frequency audio channels (front left and right, center, and surround left and right), plus 0.1 channel called LFE (Low-Frequency Effects). LFE delivers a separate non-directional bass signal to the sub-woofer for more dynamic deep bass sound effects.

Dolby Digital Surround EX

This mode creates the back (sometimes also referred to as "surround center") signals from the surround left and right signals in Dolby Digital 5.1 channel source using a matrix decoder and provides 6.1 channel surround playback. With this additional channel, you can experience more dynamic and realistic moving sound.

- As the surround back channel is matrix-encoded onto the left and right surround channels, no information is lost when played with 5 speakers.
- When Dolby Digital EX sources are decoded with a Dolby Digital EX decoder, the format is automatically detected upon decoding and the Dolby Digital EX mode is selected. However, some Dolby Digital EX sources may be detected as Dolby Digital sources. In this case, the Dolby Digital EX mode should be selected manually to play these sources.

Dolby Pro Logic IIx and Dolby Pro Logic II

Dolby Pro Logic IIx technology processes any native stereo or 5.1 signal into a 6.1- or 7.1-channel output, creating a seamless, natural surround soundfield that immerses you in the entertainment experience.

Dolby Pro Logic II technology gives you 5.1-channel surround sound from any stereo program material, as well as Dolby Surround encoded material.

- When the surround back speaker is set to "None", Dolby Pro Logic II appears instead of Dolby Pro Logic IIx.

MOVIE mode:

This mode is optimized for movies or Dolby Surround encoded materials. This mode is also appropriate for use with video games.

MUSIC mode:

The Music mode creates a rich and enveloping surround ambience from stereo sources such as music CDs.

Music mode also features three additional user controls:

Dolby Center Width adjusts the balance of the main vocals in the center and front channels.

Dolby Panorama creates a seamless, wraparound surround effect.

Dolby Dimension creates a deeper or shallower surround sound field.

- DOLBY PRO LOGIC IIx and DOLBY PRO LOGIC II will not work on monaural source.

Dolby Pro Logic

Dolby Pro Logic is a matrix decoder that decodes the four channels of surround sound (front left, center, front right and surround) that have been encoded onto the stereo soundtracks of Dolby Surround encoded material such as VHS movies. The surround channel is monaural, but is played through two surround speakers.

Dolby Virtual

This mode employs sophisticated digital processing to create the illusion of "phantom" speaker, this mode allows you to experience surround sound effects from Dolby Digital, Dolby Surround or 2-channel (recorded in digital PCM or analog stereo) source, through just a single pair of front speakers.

THEATER

This mode provides a three dimensional surround effect similar to that of movie theater.

HALL

This mode is suitable for orchestral music such as classical music or opera.

STADIUM

This mode provides the expansive sound field to achieve the true stadium effect when watching baseball or soccer games.

DOLBY PRO LOGIC IIx MUSIC parameters

You can adjust the parameters for DOLBY PRO LOGIC IIx MUSIC.

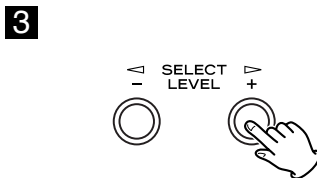
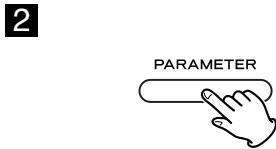
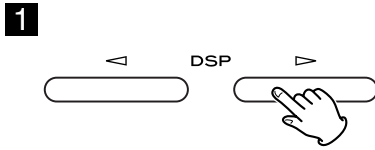
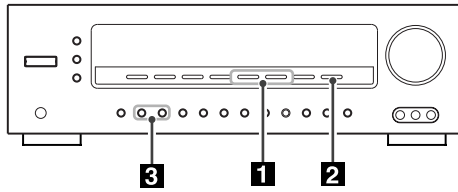

1 Select DOLBY PRO LOGIC IIx MUSIC mode by pressing the DSP button.

2 Select the parameter to be changed by pressing the PARAMETER button.

Each time the PARAMETER button is pressed, the parameter is changed as follows:

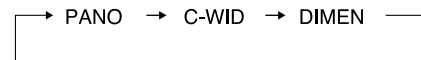

3 Within 8 seconds, press the SELECT button to change the value.

PANO (panorama):

This mode extends the front stereo image to include the surround speakers for an exciting wraparound effect with side wall imaging. Select "ON" or "OFF".

The default setting is "OFF".

C-WID (center width control):

This adjusts the center image so it may be heard only from the center speaker, only from the left/right speakers as a phantom image, or from all three front speakers to varying degrees.

The adjustable range is from 0 to 7. The default setting is "0".

DIMEN (dimension control):

This adjusts the sound-field either towards the front or towards the rear. The adjustable range is from -4 to +2.

The default setting is "-1".

Repeat step **2** and **3** to adjust other parameters.

When all the configurations have been finished, leave the unit for 8 seconds to exit.

Dynamic Range Compression

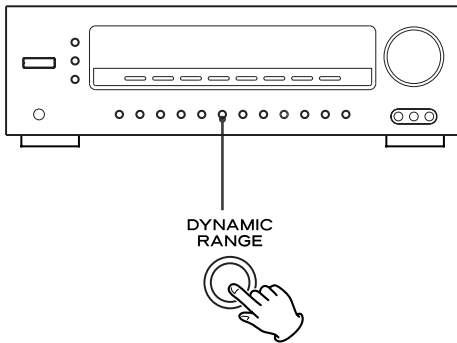

In many listening situations, you may find loud passages objectionable. Adjusting this setting allows you to compress the sounds into a range that you may find more suitable for a particular listening situation. Dolby Digital satisfies these needs through the dynamic range controlling. Select one of the followings to fit the individual listening situation of the audience.

During playback of DVD, press the DYNAMIC RANGE button repeatedly until desired setting appears on the display.

DYNR 0.0 (off):

Audio with uncompressed dynamic range. Select this when you don't want to compress the dynamic range.

DYNR 0.5:

Audio with partially compressed dynamic range.

DYNR 1.0:

Audio with fully compressed dynamic range.

- The default setting is "DYNR 0.0".
- This function is effective only when playing back a DVD disc recorded in Dolby Digital format on the DVD player connected via DIGITAL IN terminal. This control has no effect on other discs.
- This function may not work with some discs.

Tuner 1

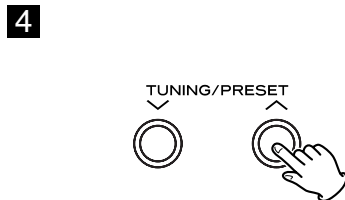
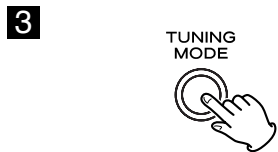
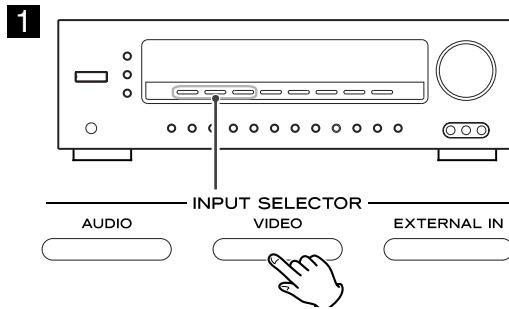
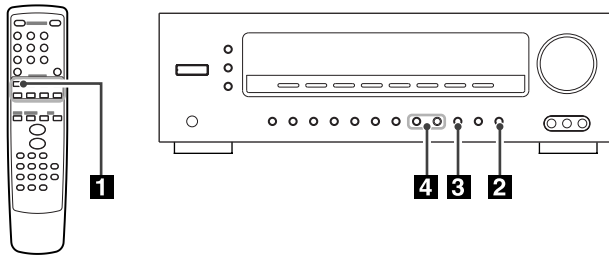

1 Select TUNER by press the AUDIO button (or press the TUNER button of the remote control unit).
Make sure the antennas have been connected (see page 4).

2 Select AM or FM by pressing the BAND button (or press the TUNER button of the remote control unit).
• If the BAND button is pressed while the source other than TUNER was selected, the source will be switched to TUNER automatically.

3 Press the TUNING MODE button to select the tuning mode. Each time the TUNING MODE button is pressed, the tuning mode changes as follows:

Automatic tuning mode
("AUTO" indicator lights on the display.)

Manual tuning mode
(no indicator)

Preset tuning mode
("PRESET" indicator lights.)

Select the Manual tuning mode or the Automatic tuning mode.

• When using the remote control unit, you can skip this step.

4 Press the TUNING/PRESET button to tune in a station. In the Automatic tuning mode, the unit starts searching for a station. When a station is tuned in, the tuning process will stop automatically.

If you want to stop the tuning process, press the TUNING MODE button.

In the Manual tuning mode, hold down the TUNING/PRESET button and release it when the station is tuned in.

When the TUNING/PRESET button is pressed momentarily, the frequency changes by a fixed step (FM: 50 kHz steps, AM: 9 kHz steps).

Tuner 2

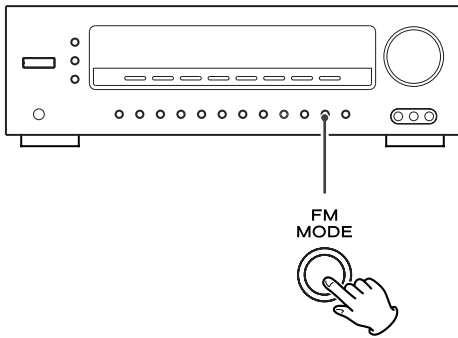

FM MODE Button

Pressing this button alternates between Stereo mode and Mono mode.

Stereo:

FM stereo broadcasts are received in stereo and the "ST" indicator lights in the display.

Mono:

To compensate for weak FM stereo reception, select this mode. Reception will now be forced monaural, reducing unwanted noise.

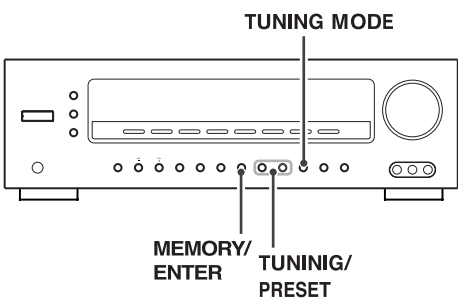

2



3

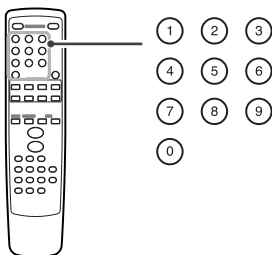
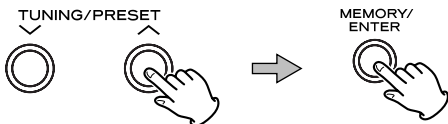

Preset Tuning 1

You can store up to 30 stations.

Manual Memory Presetting

1 Tune in a station you want to listen to (see steps **1** to **4** of page 31).

2 Press the MEMORY/ENTER button.

3 While the "MEM" indicator is blinking, select a preset channel to store the station using the TUNING/PRESET buttons (or the PRESET buttons of the remote control unit), and then press the MEMORY/ENTER button.

You can also use the numeric buttons to select a preset channel.

Example:

To select channel No. 3: 0 → 3

To select channel No. 16: 1 → 6

To select channel No. 30: 3 → 0

For instance, to select preset number 25, press "2" and "5".

To select numbers less than 10, press "0" and then the number. As an example, to select number 5, press "0" and "5". (Optionally, you may press just the number "5" and then wait a few seconds.)

When using the numeric buttons, the station is stored automatically without pressing the MEMORY/ENTER button.

To store more stations, repeat steps **1** to **3**.

1



2

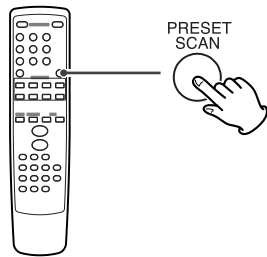
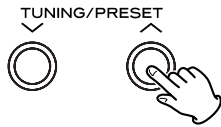

How to select preset stations

- 1 If "PRESET" indicator isn't lit, press the TUNING MODE button to select the preset tuning mode.
 - When using the remote control unit, you can skip this step.
- 2 Select a preset channel using the TUNING/PRESET buttons (or the numeric buttons of the remote control unit).

Scanning preset stations

Press the PRESET SCAN button of the remote control unit. Preset stations stored in memory are scanned at 5 seconds intervals.

When the station you want to listen to is found, press the PRESET SCAN button again to stop scanning.

1

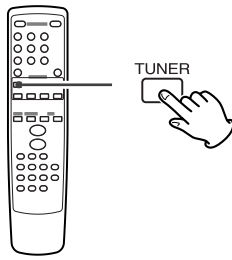

2

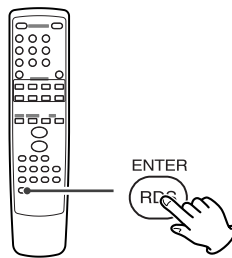

The Radio Data System(RDS) is a broadcasting service which allows stations to send additional information along with the regular radio programme signal.

RDS works on the FM waveband in Europe only.

- 1 Select FM by press the TUNER button of the remote control unit.

Each time the TUNER button is pressed, the FM or AM changed.

- 2 Press the RDS button.

Each time the RDS button is pressed, the RDS mode is changed as follows:

PS (Programme Service name)

displays PS or a station's name. If there is no PS data, "NO NAME" will be displayed.

PTY (Programme Type)

displays the programme type. If there is no PTY data, "NO PTY" will be displayed.

CT (Clock Time)

displays the information about times provided from the station.

If there is no time data, "NO TIME" will be displayed.

RT (Radio Text)

displays the news of stations composed of up to 64 symbols.

If there is no RT data, "NO TEXT" will be displayed.

1

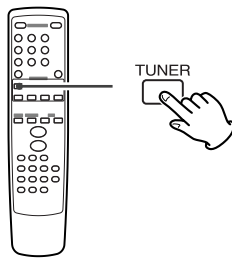

2

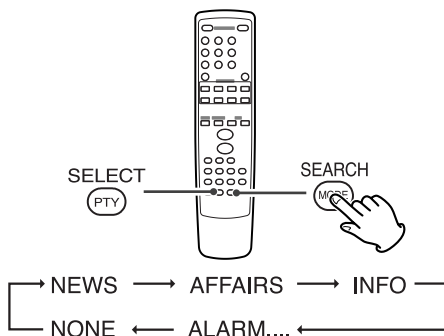
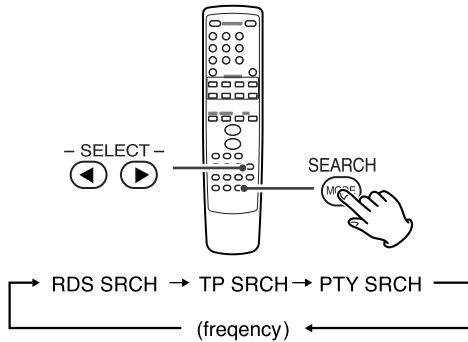

A station can be searched by this function.

- 1 Select FM by press the TUNER button of the remote control unit.
- 2 Press the SEARCH MODE button.
Each time the SEARCH MODE button is pressed, the search mode is changed as follows:

RDS search

Select "RDS SRCH" by pressing the SEARCH MODE button, and within 8 seconds press the SELECT button. The unit starts searching and "RDS SRCH" blinks. When a station offering RDS services is found, the station's name will be displayed. If the station found is not the desired one, press the SELECT button again while the RDS indicator is blinking. If no RDS station is found, "NO RDS" will be displayed.

TP search

Select "TP SRCH" by pressing the SEACH MODE button, and within 8 seconds press the SELECT button. The unit starts searching for a station offering the traffic programme, and "TP SRCH" blinks. If no station is found or the signal is too weak, "NO TRAFF" will be displayed.

PTY search

1. Select "PTY SRCH" by pressing the SEACH MODE button.
2. Within 8 seconds, select the desired PTY programme by pressing the PTY SELECT button.
You can select from 31 kinds (see page 36).
3. Press the SELECT button.
The unit starts searching.
When the programme that you have selected is found, searching will stop and the programme type will be displayed.
If no station is found or if the signal is too weak, "NO PROG" will be displayed.

PTY Programs

- NEWS : brief announcements, events, public opinion, reports, actual situations.
- AFFAIRS : a kind of suggestion including practical announcements other than news, documents, discussion, analysis and so on.
- INFO : daily information or reference such as weather forecast, consumer guide, medical assistance and so on.
- SPORT : sports related programs.
- EDUCATE : educational and cultural information.
- DRAMA : all kinds of radio concert and serial drama.
- CULTURE : all aspects of national or local culture including religious events, philosophy, social science, language, theatre, and so on.
- SCIENCE : programs on natural science and technology
- VARIED : popular programs such as quiz, entertainment, private interview, comedy, satire and so on.
- POP M : program on commercial, practical and popular songs, and sale volume of discs, etc.
- ROCK M : practical modern music generally composed and played by young musicians.
- EASY M : popular music usually lasting for less than 5 minutes.
- LIGHT M : classical music, instrumental music, chorus, and light music favored by non-professionals.
- CLASSICS: orchestra including great operas, symphony, chamber music and so on.
- OTHER M : other music styles(Rhythm & Blues, Reggae, etc.)
- WEATHER: weather reports, forecast
- FINANCE : financial reports, commerce, trading
- CHILDREN : children's programs
- SOCIAL : social affairs
- RELIGION : religious programs
- PHONE IN: program in which the public expresses its view by phone.
- TRAVEL : travel reports
- LEISURE : programs concerning recreational activities
- JAZZ : jazz music
- COUNTRY: country music
- NATION M: national music
- OLDIES : music from the so-called golden of popular music
- FOLK M : folk music
- DOCUMENT : documentaries
- TEST
- ALARM : a program notifying an emergency or a natural disaster.
- NONE : No programme type or undefined.

If you experience any problems with the unit, please take a moment to look through this chart and see if you can solve the problem yourself before you call your dealer or a TEAC service center.

No power

- ➔ Check the connection to the AC power supply. Check and make sure the AC source is not a switched outlet and that, if it is, the switch is turned on. Make sure there is power to the AC outlet by plugging another item such as a lamp or fan.

There is no sound or only a very low-level sound is heard.

- ➔ Adjust the volume by turning the MASTER VOLUME knob.
- ➔ If the SPEAKER indicator isn't lit, press the SPEAKER button to turn it on.
- ➔ Check that the speakers and components are connected securely.
- ➔ Check the operation of the connected component.
- ➔ Check the audio output setting of your DVD player.
- ➔ Select the proper source using the INPUT SELECTOR buttons and the DIGITAL INPUTS button.
- ➔ Select the proper surround mode (see page 25).
- ➔ If "MUTE" is blinking on the display, press the MUTING button to restore the sound.

No sound from surround or center speakers.

- ➔ Check the speaker setting (see page 16).
- ➔ Check the channel level setting (see page 18-19).
- ➔ Select the proper surround mode (see page 25).
- ➔ Check the audio output setting of your DVD player. Play a multi-channel source.

Severe hum or noise is heard.

- ➔ Check that the speakers are connected securely.
- ➔ Make sure the line cords and speaker cables are as far away from the AC supply as possible.

"DIGITAL" indicator blinks.

- ➔ The unit cannot perceive the digital signal (see page 20).
- ➔ Select the proper decoding mode by pressing the AUTO button (see page 25).

No picture.

- ➔ Check that the system is connected properly.
- ➔ Turn on the TV.
- ➔ Make sure you have selected the proper video input on the TV so that you can view the pictures.
- ➔ Select the proper video source using the INPUT SELECTOR buttons.

Cannot view the on-screen display as it rolls rapidly.

- ➔ The color system of the receiver does not match your TV.

Cannot listen to any station, or signal is too weak.

- ➔ Make sure the antenna is properly connected.
- ➔ Tune in the station properly.
- ➔ If a TV is near the unit, turn it off.
- ➔ Install the antenna again after relocating it to a better reception position.
- ➔ An external antenna may be required.

Though the broadcast is stereo, it sounds monaural.

- ➔ Press the FM MODE button.

Remote control doesn't work.

- ➔ Press the POWER switch of the main unit to turn it standby.
- ➔ If the batteries are dead, change the batteries.
- ➔ Use remote control unit within the range (5m) and point at the front panel.
- ➔ Clear obstacles between the remote control unit and the main unit.
- ➔ If a strong light is near the unit, turn it off.

If normal operation cannot be recovered, unplug the power cord from the outlet and plug it again.

Maintenance

If the surface of the unit gets dirty, wipe with a soft cloth or use diluted mild liquid soap. Be sure to remove any excess completely. Do not use thinner, benzine or alcohol as they may damage the surface of the unit.

Proson

Free Manuals Download Website

<http://myh66.com>

<http://usermanuals.us>

<http://www.somanuals.com>

<http://www.4manuals.cc>

<http://www.manual-lib.com>

<http://www.404manual.com>

<http://www.luxmanual.com>

<http://aubethermostatmanual.com>

Golf course search by state

<http://golfingnear.com>

Email search by domain

<http://emailbydomain.com>

Auto manuals search

<http://auto.somanuals.com>

TV manuals search

<http://tv.somanuals.com>