

WAN



Tsunami MP.11a

Antenna Installation Guide



CPN 65756B
Issue Date: August 2003

COPYRIGHT

©2003 Proxim Corporation, Sunnyvale, CA. All rights reserved. Covered by one or more of the following U.S. patents: 5,231,634; 5,875,179; 6,006,090; 5,809,060; 6,075,812; 5,077,753. This manual and the software described herein are copyrighted with all rights reserved. No part of this publications may be reproduced, transmitted, transcribed, stored in a retrieval system, or translated into any language in any form by any means without the written permission of Proxim Corporation.

TRADEMARKS

Tsunami, Proxim, and the Proxim logo are trademarks of Proxim Corporation. All other trademarks mentioned herein are the property of their respective owners.

REGULATORY INFORMATION

The Tsunami outdoor antenna solution must be installed and used in strict accordance with the instructions as described in this *Antenna Installation Guide*.

Note: Radio approvals for the Tsunami outdoor antenna solution are valid only when using the exact combination of outdoor antenna cabling components and antennas as listed in this *Tsunami MP.11a Antenna Installation Guide*.

Using other combinations of parts and components in outdoor antenna solutions will void the radio type approval and may be in violation of local radio regulations.

Proxim Corporation and its authorized resellers or distributors are not liable for any damage or violation of government regulations that may arise from failing to comply with these guidelines.

This document provides regulatory information for the following wireless products:

- Tsunami MP.11a Base Station Unit, Subscriber Unit, Residential Subscriber Unit

This device complies with Part 15 of the FCC Rules. Operation is subject to the following two conditions:

- (1) This device may not cause harmful interference
- (2) This device must accept any interference received, including interference that may cause undesired operation.

Changes or modifications not expressly approved by Proxim Corporation could void the user's authority to operate the equipment.

This equipment has been tested and found to comply with the limits for a Class B digital device, pursuant to Part 15 of the FCC Rules. These limits are designed to provide reasonable protection against harmful interference in a residential installation.

This equipment generates, uses, and can radiate radio frequency energy and, if not installed and used in accordance with the instructions, may cause harmful interference to radio communications. However, there is no guarantee that interference will not occur in a particular installation. If this equipment does cause harmful interference to radio or television reception (which can be determined by turning the equipment off and on), the user is encouraged to attempt to correct the interference by one or more of the following measures:

- Reorient or relocate the receiving antenna.
- Increase the separation between the equipment and receiver.
- Connect the equipment into an outlet on a circuit different from that to which the receiver is connected.
- Consult the dealer or an experienced radio or television technician for help.

This product must be fixed/mounted on permanent structures with a separation distance of at least two meters from all persons during normal operation.

Contents

Copyright	2
Trademarks.....	2
Regulatory Information.....	2
CONTENTS	3
ABOUT THIS BOOK	5
Who Should Use This Guide.....	5
Finding Additional Information	5
About the Tsunami MP.11a	6
Point-to-Point Link	6
Point-to-Multipoint Network.....	7
CHAPTER 1. PREPARING FOR INSTALLATION.....	8
Site Prerequisites.....	8
Overview of the Indoor Installation.....	8
Tsunami MP.11a Hardware	8
Cable System	10
Placement of the Surge Arrestor	10
Antenna Cable Route	11
Overview of the Outdoor Installation.....	12
Antenna Placement	12
Antenna Mounting.....	15
CHAPTER 2. DETERMINING RANGE AND CLEARANCE.....	16
Determining the Outdoor Range	16
Maximum Range.....	17
Cable Factor	17
Clearance Factor	18
Calculations	20
Calculating Received Signal Level and Link Budget.....	21
CHAPTER 3. INSTALLING THE ANTENNA.....	26
Planning Antenna Installation	26
Safety Precautions.....	26
Installation Overview.....	27
Mounting the Antenna.....	28
Connecting the Antenna Cable.....	28
Sealing the Cable Connectors	29
Grounding System.....	29
Antenna Alignment	30
Antenna Polarization.....	30
Antenna Cable Routing.....	31
Before Climbing the Roof.....	31
APPENDIX A. OUTDOOR ANTENNA EQUIPMENT	32
Antenna List.....	33
APPENDIX B. ANTENNA CABLING SYSTEM.....	34
Outdoor Cabling Components	34
Selecting the Correct Connector Type	34
Surge Arrestor	36
Low-Loss Antenna Cable.....	37
APPENDIX C. RECOMMENDED ANTENNAS	40
18 dBi HIGH GAIN DIRECTIONAL PANEL ANTENNA for 5.25 to 5.875 GHz	40
Specifications	40
Dimensions.....	41
Pattern.....	41
15 dBi HIGH GAIN DIRECTIONAL PANEL ANTENNA for 5 GHz.....	44

General Description	44
Mounting Instructions.....	44
Specifications	45
Pattern	45
23 dBi HIGH GAIN DIRECTIONAL PANEL ANTENNA for 5.8 GHz.....	46
Package Contents	46
Mounting	46
Specifications	47
Pattern	48
APPENDIX D. CERTIFIED OUTDOOR SOLUTIONS	50
Introduction	50
Selecting the Correct Cables	50
APPENDIX E. CHANNEL FREQUENCIES	51
SUPPORT AND WARRANTY	52
Technical Support.....	52
Warranty and Repair.....	53
Figure 1. Point-to-Point Link	6
Figure 2. Point-to-Multipoint Network	7
Figure 3. Cable Setup for Indoor Installation	9
Figure 4. Potential Obstacles for a Directional Antenna	13
Figure 5. Fresnel Zone	18
Figure 6. Clearance Factor Diagram	20
Figure 7. Surge Arrestor	36
Table 1. Cable Factor	17
Table 2. Receiver Sensitivity and Minimum SNR for a Good Link	23
Table 3. Output Power Table for FCC	23
Table 4. Output Power Table for ETSI	24
Table 5. Examples of Antenna Cable Loss Required per Regulatory Domain and Antenna Type.....	24
Table 6. Distance and Link Budget.....	25
Table 7. Antenna List.....	33
Table 8. Standard N-Type Connector Diagram.....	34
Table 9. Reverse Polarity-N Cabling Diagram	35
Table 10. Specifications: Surge Arrestor.....	37
Table 11. Specifications 6 m (20 ft) Antenna Cable	38
Table 12. Specifications 15 m (50 ft) Antenna Cable	38
Table 13. Specifications 22 m (75 ft) Antenna Cable	39
Table 14. Specifications 15 m (50 ft) Extra Low Loss Antenna Cable	39

About This Book

This *Tsunami MP.11a Antenna Installation Guide* explains how to install and set up an outdoor antenna with the Tsunami MP.11a hardware.

This guide does not explain how to erect antenna masts, nor how to install a safety grounding system. These prerequisites must be in place before installing the directional antenna.

WHO SHOULD USE THIS GUIDE

The installation of outdoor wireless links requires technical expertise. At the very least, you should be able to:

- Install and configure the network components, such as the Tsunami MP.11a hardware.
- Understand, or have a working knowledge of, installation procedures for network operating systems using Microsoft Windows.
- Mount the outdoor antenna and surge arrestor. Antenna installation must be provided by professional installers.

WARNING!

The Tsunami outdoor antennas are intended for mounting on a roof or on the side of a building. Installation is not to be attempted by someone who is not trained or experienced in this type of work. The antenna must be installed by a suitably trained professional installation technician. The site prerequisites must be checked by a person familiar with the national electrical code and other regulations governing this type of installation.

FINDING ADDITIONAL INFORMATION

Installing Tsunami MP.11a Hardware

Tsunami outdoor antennas typically are used in combination with Tsunami MP.11a systems. The hardware installation of these devices is described in the installation guide included with each product.

Configuration and Management

The configuration and management of outdoor wireless links is done with management tools which come with the Tsunami MP.11a systems. Some examples of management tools are:

- Web-based management
- Telnet
- Wireless Network Manager

Hardware Specifications

Tsunami MP.11a hardware and radio frequency specifications are described in the documentation that comes with the product. Hardware specifications for the outdoor antennas, the cabling system, and the surge arrestor are listed in Appendixes of this guide.

Additional Files on Your Software CD-ROM

All software CD-ROMs that come with your Tsunami products, include a **readme.txt** file. This file contains information about the software version and drivers. You are advised to print and read the **readme.txt** file prior to installing your Tsunami products, as it may contain additional information that was not available when this document was printed.

Other Sources of Information

All documentation listed above can be downloaded from the Proxim Support website: <http://www.expressresponse.com/proxim02>. Visit the website regularly for the latest available information and documentation, software updates and other Proxim news.

ABOUT THE TSUNAMI MP.11A

The Tsunami MP.11a lets you set up a wireless system based upon two basic topologies:

- Point-to-point link to connect one location to another
- Point-to-multipoint link to connect one location to two or more other locations.

A link between two locations always consists of a Base Station Unit and a Subscriber Unit. A Base Station Unit can, depending upon its configuration, connect to one or more Subscriber Units; a Subscriber Unit, however, can connect to only one Base Station Unit at any given time.

Point-to-Point Link

With a Base Station Unit and a Subscriber Unit, it is easy to set up a wireless point-to-point link as depicted in the following figure.

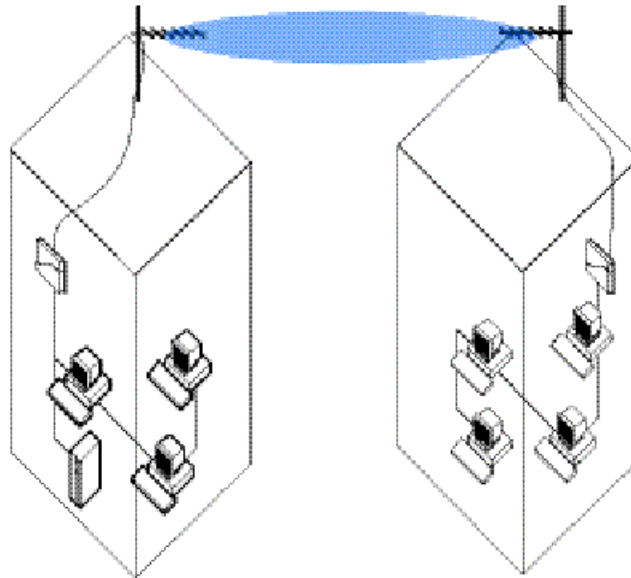

Figure 1. Point-to-Point Link

The point-to-point link function lets you set up a connection between two locations as an alternative to:

- Leased lines in building-to-building connections
- Wired Ethernet backbones between wireless access points in hard-to-wire environments

Point-to-Multipoint Network

To connect more than two buildings, you can choose to:

- Set up multiple point-to-point links, using multiple pairs of Base Station and Subscriber Units
- Set up a single point-to-multipoint network using a single Base Station Unit and multiple Subscriber Units, as depicted in the following figure.

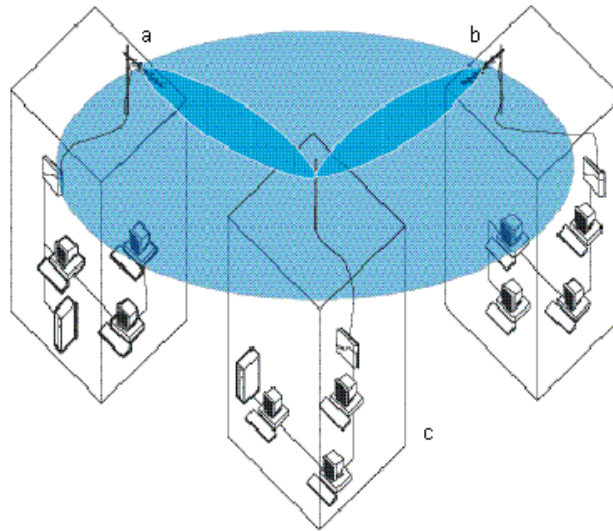

Figure 2. Point-to-Multipoint Network

The system in this figure is designed as follows:

- The central building (c) is equipped with the Base Station Unit, connected to either an omni-directional or a wide angle antenna.
- The two other buildings (a and b) are both equipped with a Subscriber Unit connected to a directional antenna.

Note: Depending upon local radio regulations and legislation, the outdoor antenna solutions described in this document may not be available in all parts of the world. Consult "Appendix C. Certified Outdoor Solutions" for more information.

Chapter 1. Preparing for Installation

SITE PREREQUISITES

Review all requirements outlined within the following sections before starting the installation procedure:

- Overview of the Indoor Installation
- Overview of the Outdoor Installation
- Climbing the Roof

Prior to climbing on the roof or any other area where you intend to install the outdoor antenna, you are advised to:

- Verify that you have arranged all safety measures for outdoor or rooftop installation.
- Verify that you have all equipment and tools required to install the outdoor antennas.
- Install and verify proper operation of the equipment.

OVERVIEW OF THE INDOOR INSTALLATION

The indoor installation of the link consists of the following components:

- The Tsunami MP.11a hardware
- A cable system

Tsunami MP.11a Hardware

There are three types of hardware devices to setup a wireless link:

- Tsunami MP.11a Base Station Unit (BSU)
- Tsunami MP.11a Subscriber Unit (SU)
- Tsunami MP.11a Residential Subscriber Unit (RSU)

Tsunami MP.11a

The following figure shows an overview of the cable setup for this outdoor antenna. When the MP.11a is not mounted close to the entrance of the antenna cable into the building (where the surge arrestor must be mounted), an additional cable between the MP.11a and the surge arrestor is needed, plus a female-female converter connector. If the MP.11a is mounted close to the surge arrestor, the MP.11a can be connected directly to the surge arrestor.

The deviation to the rule is the MP.11a RSU when the Window antenna is installed in an indoor location. This does not require the use of a Surge Arrestor. The antenna can be connected directly to the MP.11a.

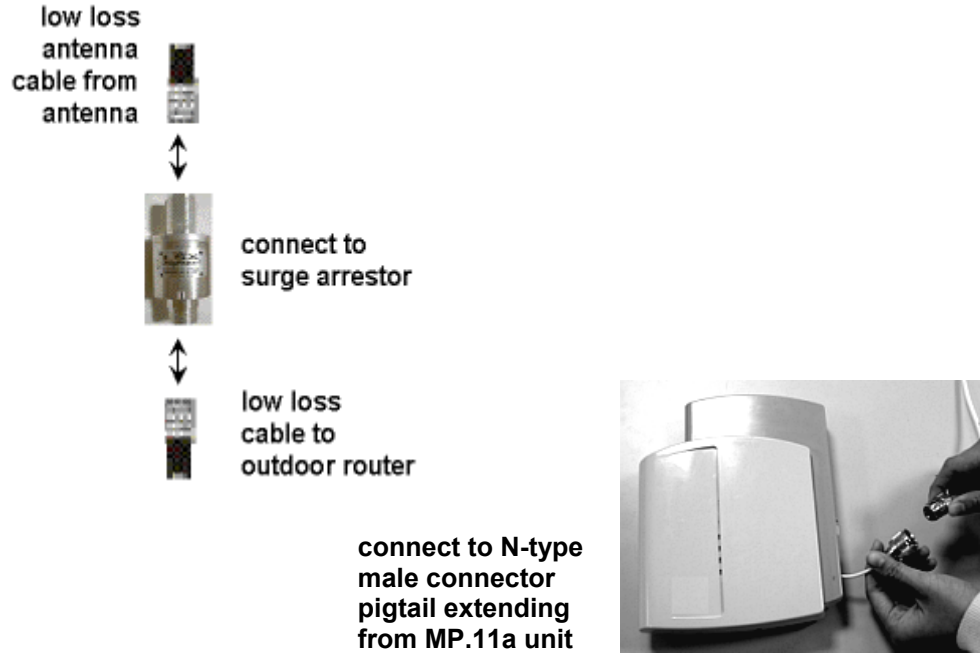

Figure 3. Cable Setup for Indoor Installation

On each end of the wireless link you will require the following items:

- A Tsunami MP.11a Base Station or Subscriber Unit
- A low-loss antenna cable to connect the indoor installation to the surge arrester (optional)
- Female-female converter connector (optional)
- A surge arrester to protect your sensitive Tsunami MP.11a equipment from static discharge and transients from the outdoor antenna system
- A low-loss antenna cable to connect the surge arrester to the outdoor antenna
- Outdoor antenna
- A grounding system as described in “Grounding System” on page 16.

Placement of the Tsunami MP.11a Hardware

The electronics (power supply and unit) are designed for indoor mounting and operation. The ideal location must satisfy the following requirements:

- The location provides a connection to a grounding type AC wall outlet (100-240 VAC), using the standard power cord supplied with the unit. (Alternative power can be provided through Power over Ethernet.)
- The ground of the AC wall outlet must be connected to the same grounding system as the surge arrester and antenna mast (see “Grounding System” on page 16).
- The location must allow for easy disconnection of the Tsunami MP.11a hardware from the AC wall outlet.

- The location provides a connection to the network backbone (an Ethernet LAN cable that is connected to a hub, bridge, or directly into a patch panel)
- The location is as close as possible to the point where the antenna cable will enter the building (see “Placement of the Surge Arrestor” below).
- The ideal location has a temperature of 0-55 degrees Celsius and a maximum relative humidity (non-condensing) of 95%.

CAUTION! *The Tsunami MP.11a hardware, the surge arrestor, and the antenna mast must be connected to the same grounding system.*

Cable System

CAUTION! *The Tsunami MP.11a products are designed for indoor installation. At all times the location of the Tsunami MP.11a radio unit and power supply must be indoors, to protect the unit from extreme weather conditions, excessive heat and humidity, and to keep the unit free from vibration and dust. The antenna and surge arrestor can be placed outdoors.*

Prior to mounting the Tsunami MP.11a, you are advised to calculate carefully:

- The distance between the intended location of your Tsunami MP.11a hardware and the location of the antenna mast
- The height of the antenna on the mast.

If the low-loss antenna cable is not long enough to cover this distance you can select another:

- Cable length from the Proxim Systems low-loss cable offering
- Location that satisfies the requirements listed previously to mount your Tsunami MP.11a hardware

As the length of the antenna cable may affect the actual range of your outdoor antenna installation, the last option is preferred.

WARNING! *You must not change the length of the low-loss antenna cable to a length shorter than allowed by the radio's certifications (see “Appendix C. Certified Outdoor Solutions” on page 48. Shortening the cable will void the Proxim Corporation warranty and may conflict with radio certifications or approvals.*

How to install the Tsunami MP.11a hardware is described in *Tsunami MP.11a Installation and Management*, which comes on the Tsunami MP.11a product CD.

Placement of the Surge Arrestor

The surge arrestor is an indispensable part of your outdoor antenna installation. It protects your sensitive electronic equipment from transients or electro-static discharges at the antenna.

For optimal protection, the surge arrestor must be installed at a location that satisfies the following requirements:

- A location as close to the location where the antenna cable will enter the building (see “Placement of the Tsunami MP.11a Hardware” on page 9).

- The location allows for easy disconnection of the surge arrester from the cable connected to the unit.
- The location provides a connection to the same grounding system as the Tsunami MP.11a hardware and the outdoor antenna mast (as described in “Grounding System” on page 16).

Antenna Cable Route

The antenna cable must be connected from the antenna through the surge arrester to the pigtail connector of the MP.11a unit. To plan the route of the antenna cable, consider the following:

- Does the cable route require drilling through a wall or ceiling?
- Do you have a building plan of the desired location showing other cabling routes like electricity, telephone or networking?
- Does the type of building materials require special drilling tools?

The cable should not be installed into tight positions, as bending or applying excessive force to the connectors can damage the antenna cable. Always allow the cable to bend naturally around corners. The recommended bend radius is at least 100 mm (4 in) or more for the low-loss cable of 10 mm (0.4 in) diameter.

The cable must be secured along the complete distance between attachment points. No part of the antenna cable should be allowed to hang free. This is particularly important for outdoor cable parts.

CAUTION!

- ***The antenna cable and cable connectors are not designed to withstand excessive force:***
 - ***Do not use the connectors as ‘cable grips’ to pull cable through raceways or conduits.***
 - ***Do not use the cable connector to support the weight of the cable during or after installation.***
 - ***Do not use any tool to tighten the connectors.***
 - ***Always seal the connectors using weatherproofing tape.***
 - ***Avoid any water or moisture entering the cable as that impacts the performance of the wireless link.***
 - ***Prior to sealing the outdoor connectors and permanently securing the cable to the wall with cable ties and wall hooks, you may want to verify whether the installation and all components functions properly.***
-

OVERVIEW OF THE OUTDOOR INSTALLATION

The outdoor installation of the link (point-to-point or point-to-multipoint) requires the following:

- An antenna
- A low-loss antenna cable (available in three lengths)
- Antenna mast or wall bracket for the antenna
- An adequate grounding system that meets the requirements described in “Grounding System.”
- Waterproofing of all connections

Note: All outdoor cable connectors must be sealed with weatherproofing stretch tape to make the coax connectors permanently waterproof. See “Sealing the Cable Connectors” on page 29.

DANGER! *For your own safety, the antenna mast and the grounding system should only be installed by experienced installation professionals who are familiar with local building and safety codes and the national electrical codes.*

Read carefully the instructions described in “Grounding System” on page 16 and verify that your installation complies with the appropriate regulations and codes before installing the antenna.

Antenna Placement

To achieve maximum performance of your wireless outdoor link, the outdoor antenna must have clear line-of-sight to the antenna of the other Tsunami MP.11a unit. Although the MP.11a radio signal can work well without line-of-sight in urban environments, where the signal is transported by reflection instead of being direct, the best results are achieved in line-of-sight conditions.

Line-of-sight can be defined as:

- No obstacles in the direct path between the antennas (antenna beam).
- No obstacles within a defined zone around the antenna beam.

You should be aware that the shape of an antenna beam is not straight and narrow like a laser beam. The antenna beam, also referred to as Fresnel¹ Zone, is rather “bulged” in the middle, such as, for example, a rugby ball.

The exact shape and width of the Fresnel Zone is determined by the path length and frequency of the radio signal. The width as distance from the direct antenna beam is approximately 6 m (21 ft) in the middle of the wireless link for a distance of 6.5 Km (4 mi) and a frequency of 5.8 GHz. This width also is the required clearance of the antenna beam from obstacles in its path, to avoid loss of radio signal.

¹Pronounced as ‘Fray-Nell’

If any significant part of this zone is obstructed, a portion of the radio energy will be lost, resulting in reduced performance. Reduced performance can also occur when obstacles close to the antenna beam cause signal reflections or noise that interfere with the radio signal.

The following figure shows some typical examples of obstacles that you must avoid for the directional antenna to operate effectively:

- Neighboring buildings
- Trees or other obstructions
- Power lines

To allow optimal performance you must ensure that the type and placement of the antennas leave sufficient clearance of the Fresnel Zone at the maximum width of the bulge, which is typically at the mid-point between the antennas.

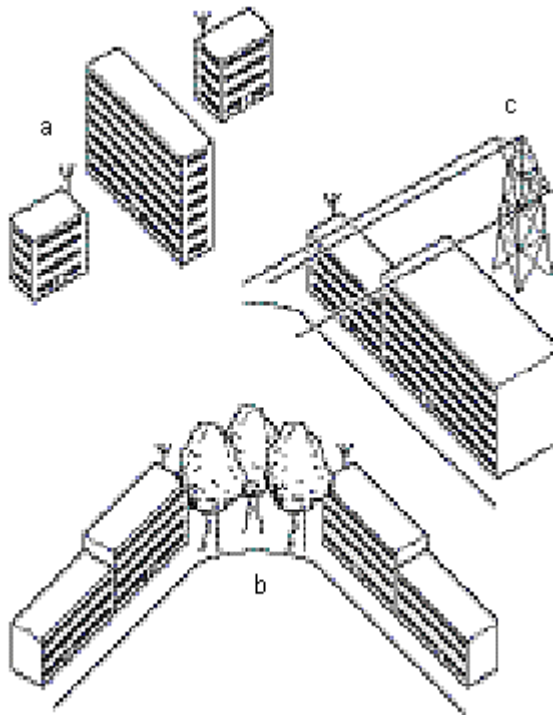

Figure 4. Potential Obstacles for a Directional Antenna

To minimize the influence of obstacles, signal interference, or reflections, note the following guidelines:

- Mount the antenna as high as possible above the “ground” to allow maximum clearance:
 - In open areas, “ground” is the actual surface of the earth.
 - In dense urban areas, “ground” is to be interpreted as the height of the highest obstacle in the signal path between the two antenna sites.
- Avoid trees in the signal path to avoid signal absorption due to seasonal changes (leaves or ice).
- Install the antenna at least 2 m (6 ft) away from all other antennas.

Other situations, in which reflections of the radio signal may cause interference, are environments where large reflecting surfaces exist in parallel or partly perpendicular to the antenna beam.

Environments with large reflective surfaces include:

- Mirror-glass buildings
- Crowded parking lots
- Water or moist earth and moist vegetation
- Above ground power and telephone lines

Note: The use of reflective surfaces can be used to improve a link, especially if the direct line-of-sight is impaired or absent.

Weather conditions such as rain or snow usually do not have much impact on the performance of your Tsunami MP.11a product, provided you have sealed all cable connectors with weatherproofing tape.

Seasonal influence on signal propagation can occur in the following situations:

- A marginal communications quality in late fall (with no leaves on the trees in the signal path) might fail in the summer.
- In winter, a wireless link may fail when the antenna is exposed to ice buildup, or when the antenna elements are covered with snow.

Radio paths over water or extremely flat ground may require optimization of antenna height at one end. This is due to in-phase or out-of-phase reflections. Adjustment of antenna height by 1 to 3 meters may move the signal from a null to a peak.

Long distance links may be obstructed by earth curvature, so the antenna height requirements must not only take the height of obstructions and Fresnel Zone into account, but also earth bulge. The earth bulge is approximately 5 m (16.4 ft) at a link distance of 16 Km (10 mi).

In these cases consult your supplier to take appropriate steps to maintain or optimize wireless link performance.

Antenna Mounting

There are two ways to erect an antenna mast: Tripod Mount and Wall (Side) Mount.

Tripod Mount

The tripod mount is primarily used on peaked and flat roofs. The antenna mast must be secured to the roof using 3 or 4 guy wires equally spaced around the mast. When the height of the antenna mast is more than 3 meters (10 ft), you are advised to use at least three guy wires for each 3 meters (10 ft) section of the mast.

Wall (Side) Mount

A wall (side) mount allows for mounting an antenna (mast) on the side of a building or on the side of an elevator penthouse. This will provide a convenient mounting location when the roof overhang is not excessive or the location is high enough to provide a clear line-of-sight.

In most situations mounting an antenna directly to the wall will not let you align the antenna properly with the corresponding antenna at the opposite end of your wireless link. As poor alignment typically results in poor performance, Proxim recommends always mounting the antennas to a mast. An exception to this rule is the wide-angle window antenna that can be mounted on a window or wall facing the nearest Base Station with line of sight.

Antenna Mast Requirements

To accommodate the antennas, the antenna mast must satisfy the following requirements:

- The construction of the mast must consist of sturdy, weatherproof, and non-corrosive material such as, for example, galvanized or stainless steel construction pipe.
- Typical diameter of the mast should be between 35 mm (1.4 in) and 41 mm (1.6 in). Depending upon the type of antenna you intend to install, other diameters also may be possible.
- The height of the antenna mast must be sufficient to allow the antenna to be installed at least 1.5 m (5 ft) above the peak of the roof. If the roof is of metal, the height of the antenna should be at least 3 m (10 ft) above the roof.
- The mast or wall bracket must be free from any substance that may prevent a good electrical connection with the antenna such as, for example, paint.

Chapter 2. Determining Range and Clearance

When you read about wireless outdoor products, you often encounter the terms *output power* of the radio and *gain* of the antenna equipment as measures for the *strength* of the transmitted signal.

- Output power of radio equipment often depends on maximum limits as defined by local radio regulations; consequently, output power is, by definition, not the way to enhance wireless performance.
- High gain antennas are larger in size than low gain antennas and are characterized by a narrow focus of the antenna beam. These two characteristics make it more difficult to aim the antennas and adjust antenna alignment to optimize the performance of the wireless point-to-point link.

The Tsunami outdoor solution is based upon the following principles:

- An output power and antenna gain that comply with the maximum limits as defined by local governing bodies concerning radio transmissions.
- Enhanced radio sensitivity for optimal receive quality of radio signals transmitted by remote antennas.

DETERMINING THE OUTDOOR RANGE

The range of your outdoor antenna installation is closely related to a number of different factors. To let you determine the range of the Tsunami MP.11a antenna system in your situation, we have defined the following formula:

$$\text{Range} = \text{Maximum Range} \times \text{Cable Factor} \times \text{Clearance Factor}$$

where:

Maximum Range	Identifies the theoretical maximum that could be achieved under optimal circumstances using the available Tsunami MP.11a products according to their specifications and in compliance with local radio regulations.
Cable Factor	Identifies a correction value (percentage) that compensates for additional cable losses related to the type of cables used at both ends of the wireless link. (See "Cable Factor" on page 17.)
Clearance Factor	Identifies a correction value (in percentage) that should be used in case the signal path of your wireless link does not provide the minimum clearance as listed in the Maximum Range table. (See "Clearance Factor" on page 18.)

Maximum Range

The maximum range of your Tsunami MP.11a system is based upon:

- The Type of Outdoor Antenna Equipment
- The Data Speed of the Wireless Link
- The clearance of the signal path (see “Clearance Factor” on page 18).

The values in this section are based on calculations that assume optimal radio conditions. They do not represent a guarantee that the same maximum distance can be achieved at your location. Differences in performance figures may result from:

- Incorrect alignment of antennas (see “Antenna Alignment” on page 30).
- Polarization mismatch of the antennas.
- Sources of interference or unexpected reflections in the signal path that affect the communications quality (see “Antenna Placement” on page 12).
- Severe weather conditions such as heavy rain or snow fall, or strong winds.
- Seasonal influences such as leaves on trees, or icing on the antennas.

Cable Factor

Determine the Cable Factor from the following table to calculate the probable range for your installation.

Table 1. Cable Factor

One side of link	Other side of link	Cable Factor
6 m (20 ft) / 10 mm (0.4 in)	6 m (20 ft) / 10 mm (0.4 in)	100%
	6 m (20 ft) / 5 mm (0.2 in)	71%
	15 m (50 ft) / 15 mm (0.59 in)	89%
	15 m (50 ft) / 10 mm (0.4 in)	71%
	22 m (75 ft)	52%
6 m (20 ft) / 5 mm (0.2 in)	6 m (20 ft) / 5 mm (0.2 in)	50%
	15 m (50 ft) / 15 mm (0.59 in)	63%
	15 m (50 ft) / 10 mm (0.4 in)	50%
	22 m (75 ft)	37%
15 m (50 ft) / 15 mm (0.59 in)	15 m (50 ft) / 15 mm (0.59 in)	80%
	15 m (50 ft) / 10 mm (0.4 in)	63%
	22 m (75 ft)	46%
15 m (50 ft) / 10 mm (0.4 in)	15 m (50 ft)	50%
	22 m (75 ft)	37%
22 m (75 ft)	22 m (75 ft)	27%

Note: The allowed antenna cables depend upon local radio regulations, the frequency, and the antenna gain used as listed in Table 5 on page 24 “Minimum Antenna Cable Loss in 5 GHz Bands.”

Clearance Factor

For optimal performance of your outdoor wireless link, the signal path between the Base Station Unit and Subscriber Unit must provide sufficient clearance.

Note: A outdoor wireless link that lacks sufficient clearance will suffer from poor performance, which is typically perceived as slow network response times. Although your Tsunami MP.11a equipment automatically retransmits every lost data frame due to an out-of-range situation or frame collision, the larger the number of retransmissions, the lower the throughput efficiency of your wireless link.

This section explains how to determine the clearance that applies in your environment and (if applicable) the effect of insufficient clearance on the range of your outdoor wireless link.

In “Chapter 1. Preparing for Installation” on page 8, we described the shape of the antenna beam as being “bulged” in the middle.

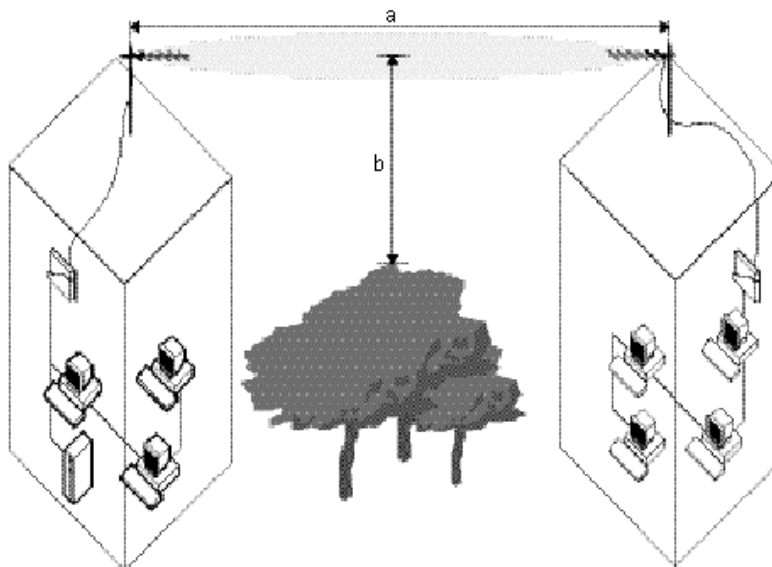

Figure 5. Fresnel Zone

If any significant part of this bulged zone is obstructed, a portion of the radio energy is lost, which can affect the performance of your wireless link in terms of maximum range and transmit rate.

In Figure 5, you see two variables that determine the shape of the antenna beam, also referred to as Fresnel Zone:

- The distance between the antennas (a)
- The clearance required for optimal performance (b), where clearance should be interpreted as:
 - Vertical clearance above the ground and the highest buildings or objects in the signal path
 - Horizontal clearance from neighboring buildings and objects in the signal path.

For optimal range and throughput performance, you must ensure that your antenna installation provides maximum clearance in both horizontal and vertical direction.

Clearance should be interpreted as follows:

- In open areas without obstacles in the signal path, clearance is measured as height above the surface of the earth. For example, if the antenna is mounted on the roof, this height includes the height of the building plus the height of the mast above the rooftop.
- In areas with obstacles in the signal path between the two antennas, clearance should be measured as height above the highest obstacle in the signal path.
- In dense urban areas, the clearance should be measured as height above the highest rooftop or any other obstacles in the signal path between the two antennas.

For situations in which local authorities, the proprietor of the premises, or other factors do not let you set up an antenna mast that lets you meet the listed clearance requirements, you may be unable to achieve a full line-of-sight clearance. At the same time, however, when the distance that your wireless outdoor installation must cover is less than the listed maximum range, you may not even need full clearance.

To determine the effect of insufficient signal path clearance, you must determine the Clearance Factor as described below, and calculate its effect on the range for your antenna installation using the formula described in “Determining the Outdoor Range” on page 16.

- If the clearance for your antenna installation is equal to or better than the minimum clearance requirement, the Clearance Factor for your installation is 100%.
- If your actual clearance is less than the minimum clearance, use the diagram depicted in the following figure to determine the actual range that applies in your situation.

Note: The Clearance Factor Diagram should be used as a rule-of-thumb for estimating the probable range in case the clearance requirements are not fully met. In real life, using FCC approved products, you will also find it almost impossible to achieve the level of clearance for maximum range.

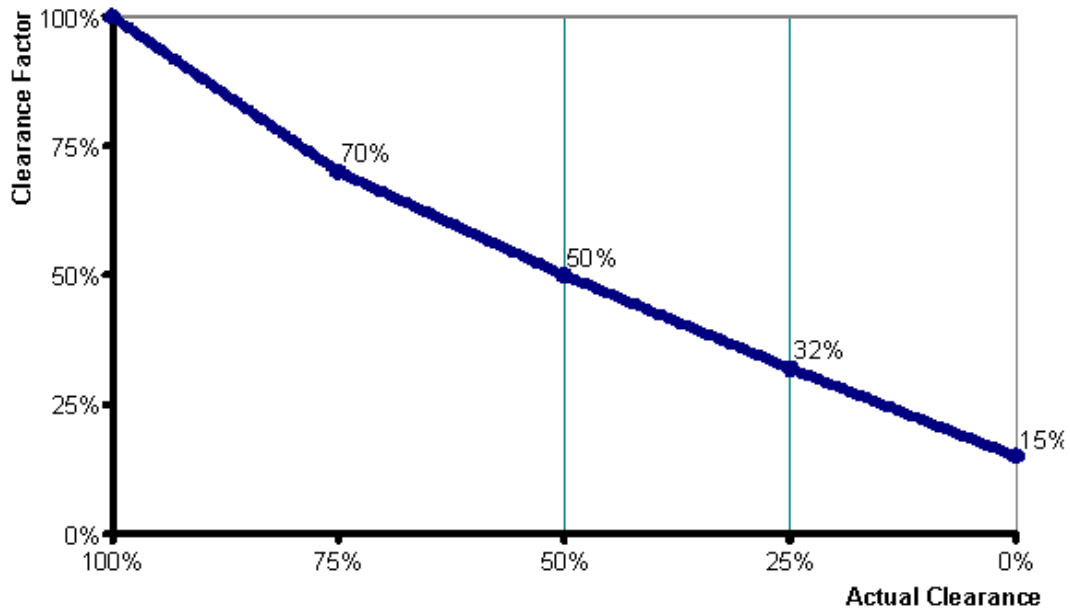

Figure 6. Clearance Factor Diagram

CALCULATIONS

Availability of the microwave path is a prediction of the percent of time that the link operates without producing an excessive bit error rate (BER) due to multipath fading. In the absence of direct interference, availability is affected by the following:

- Path length
- Fade margin
- Frequency
- Terrain (smooth, average, mountainous)
- Climate (dry, temperate, humid)

Depending upon the type of information carried over the link and the overall network design redundancy, you may want to design for a specific availability rate. For example, if the data or voice traffic carried by the radio is critical, the link can be designed for a very high availability rate (for example, 99.999% or 5.3 minutes of predicted outage per year).

Availability can be improved by increasing the fade margin either by making the path shorter or by using the higher gain antennas in conjunction with lower loss transmission line (using a higher quality transmission line, shortening the length, or both).

Calculating Received Signal Level and Link Budget

Use the following formula to estimate the received signal level (RSL):

$$\text{RSL (dBm)} = P_{\text{out}} - L_1 + G_1 + G_2 - L_2 - L_p$$

where:

- P_{out} is the transmitter output power (in dBm)
- L_1 is the total loss of all transmission elements between the antenna and the RF Unit on one side of the link (in dB)
- G_1 is the gain of the antenna on one side of the link (in dB)
- G_2 is the gain of the antenna on the opposite side of the link (in dB)
- L_2 is the total loss of all transmission elements between the antenna and the RF Unit on the opposite side of the link (in dB)
- L_p is the Path loss, defined by: $L_p \text{ (dB)} = 96.6 + 20 \log_{10} F + 20 \log_{10} D$

where:

F is the Frequency of the radio system in GHz (5.8 in the case of this model)

D is the Distance of the path in miles

See the following figure for a visual representation of the elements of this equation.

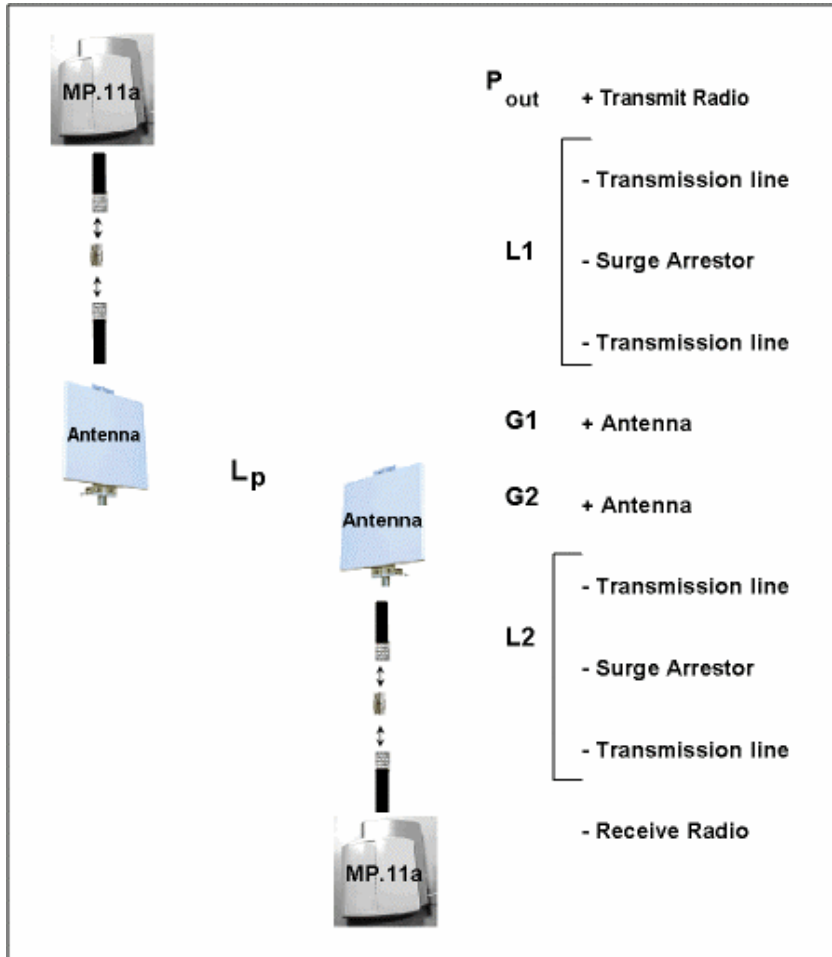

Procedure:

1. Start with the transmit power and the number of the channel to be used. From the *output power tables* (on page 23) find the dBm associated with this output power and channel.
2. Subtract the total loss of all transmission elements between the antenna and the radio on one side of the link (dB). (See “Minimum Antenna Cable Loss in 5 GHz Bands” on page 24.)
3. Add the dBi of the antenna you will be using. The total is the **EIRP** (equivalent isotropically radiated power).
4. Determine your link budget from the *Distance and Path Loss* table. For example, if the distance between the two radios is approximately 5 km, the link budget would be 121. (Note that this is the value for 4.8 km, which is closest to the actual value.)
5. Add the gain of the antenna on the second side of the link.
6. Subtract the total loss of all transmission elements between the antenna and the radio on the second side of the link. The result is the **Received Signal Level (RSL)**.
7. From the Receiver Sensitivity in Table 2 on page 23, find the dBm value for the data rate used for the link.
8. Add the “Minimum SNR for a Good Link” value of the data rate in use to the Receiver Sensitivity level.
9. Subtract this value from the Received Signal Level; this is the **Fade Margin**.

Notes:

- The RSL must be higher than the Receiver Sensitivity plus the minimum SNR for a good link. See Table 3 on page 23, to have a working link with no excessive errors. The amount of Fade Margin indicates the reliability of the link; the more Fade Margin, the more reliable the link.
- The path loss must be smaller than the link budget minus the minimum required fade margin. The maximum ranges cause the path loss plus the fade margin to be the same as the link budget.

The results of this link budget calculation are very important for determining any potential problems during installation. If you have calculated the expected RSL, you can verify that it has been achieved during installation and troubleshooting, if necessary.

In the USA and Canada, this model radio can be installed with any gain directional antennas, as there is no Effective Isotropic Radiated Power (EIRP) limit for the application of these systems for fixed point-to-point applications. In other countries, EIRP limits may apply.

In the case of EIRP limits, use the lesser of either $(P_{out} - L_1 + G_1)$ or the EIRP limit within the previous equation. You should check this equation in both directions to assure legal application.

An EIRP limit is the maximum RF energy that can be transmitted, as measured at the transmitting antenna, and is usually determined by government regulations.

Table 2. Receiver Sensitivity and Minimum SNR for a Good Link

Normal Mode (Mbps)	Receiver Sensitivity	Minimum SNR for a Good Link	Turbo Mode* (Mbps)	Receiver Sensitivity	Minimum SNR for a Good Link
54	- 69 dBm	21	108	- 66 dBm	21
48	- 73 dBm	20	96	- 70 dBm	20
36	- 77 dBm	16	72	- 74 dBm	16
24	- 81 dBm	12	48	- 78 dBm	12
18	- 84 dBm	9	36	- 81 dBm	9
12	- 86 dBm	7	24	- 83 dBm	7
9	- 87 dBm	5	18	- 84 dBm	5
6	- 88 dBm	4	12	- 85 dBm	4

* allowed in FCC regulatory domain only

The first Fresnel zone size is a list; Proxim's recommendation is to keep at least 60-70% of this zone free. If the clearance is lower than this percentage, the *link budget* and achieved *fade margin* are affected.

Clearances more than 100% of the Fresnel zone can cause reflections that are 180 degrees out of phase and can cancel out the signal. The Fresnel zone works in both the horizontal and vertical paths.

Table 3. Output Power Table for FCC

Frequency Band	Channels	54 Mbps	48 Mbps	36 Mbps	6-24 Mbps
5.25 – 5.35 GHz	52, 56, 60	14.5	15.5	17.5*	18.5*
5.25 – 5.35 GHz	64	12.5	12.5	12.5	12.5
5.745 – 5.850 GHz	149, 153	13.5	15.5	17.5	18.5
5.745 – 5.850 GHz	157, 161	13.5	15.5	17.5	17.5
5.745 – 5.850 GHz	165	12.5	15.5	17.5	17.5

* 17.4dBm is the FCC certified peak output power of Tsunami MP.11a product at 5.25-5.35GHz band

** 20.8dBm is the FCC certified peak output power of Tsunami MP.11a product at 5.725-5.850 GHz band

These power levels are the levels at the antenna connector of the MP.11, so where the MP.11 has a higher output power than certified, the TPC needs to be used to reduce the output power.

Table 4. Output Power Table for ETSI

Frequency Band	Channels	54 Mbps	48 Mbps	36 Mbps	6-24 Mbps
5.47 – 5.70 GHz	100, 104, 108, 112, 116, 120, 124, 128, 132, 136	14.5	15.5	17.5	18.5

Table 5. Examples of Antenna Cable Loss Required per Regulatory Domain and Antenna Type

Frequency Band	Antenna Gain	TPC Setting	Minimum Cable Loss for Data up to 24 Mbps*	EIRP	Deployment
5.25-5.35 GHz	10	0	0	28.5	USA
5.25-5.35 GHz	17	-6	0	29.5	USA
5.25-5.35 GHz	23	-10	1.5	30	USA
5.25-5.35 GHz	31	-10	9.5	30	USA
5.725-5.85 GHz	10	0	0	28.5	USA, PtMP
5.725-5.85 GHz	17	0	0	35.5	USA, PtMP
5.725-5.85 GHz	23	-6	0	35.5	USA, PtMP
5.725-5.85 GHz	31	-10	3.5	36	USA, PtMP
5.725-5.85 GHz	10	0	0	28.5	USA, PtP
5.725-5.85 GHz	17	0	0	35.5	USA, PtP
5.725-5.85 GHz	23	0	0	41.5	USA, PtP
5.725-5.85 GHz	31	0	0	49.5	USA, PtP
5.47-5.725 GHz	10	0	0	28.5	ETSI
5.47-5.725 GHz	17	-6	0	29.5	ETSI
5.47-5.725 GHz	23	-10	1.5	30	ETSI
5.47-5.725 GHz	31	-10	9.5	30	ETSI

* Note that higher data rates use lower output power, so less cable loss is required to meet the maximum EIRP limit.

Table 6. Distance and Link Budget

Reference Frequency: 5600 MHz Center Frequency for Europe								
Link Budget (dB)	Distance (m)	Fresnel Zone (m)	Link Budget (dB)	Distance (m)	Fresnel Zone (m)	Link Budget (dB)	Distance (km)	Fresnel Zone (m)
61	4.8	0.3	91	151	1.4	121	4.8	8.0
62	5.4	0.3	92	170	1.5	122	5.4	8.5
63	6.0	0.3	93	190	1.6	123	6.0	9.0
64	6.8	0.3	94	214	1.7	124	6.8	9.5
65	7.6	0.3	95	240	1.8	125	7.6	10.1
66	8.5	0.3	96	269	1.9	126	8.5	10.7
67	9.5	0.4	97	302	2.0	127	9.5	11.3
68	11	0.4	98	339	2.1	128	10.7	12.0
69	12	0.4	99	380	2.3	129	12.0	12.7
70	13	0.4	100	426	2.4	130	13.5	13.4
71	15	0.5	101	478	2.5	131	15.1	14.2
72	17	0.5	102	537	2.7	132	17.0	15.1
73	19	0.5	103	602	2.8	133	19.0	16.0
74	21	0.5	104	676	3.0	134	21.4	16.9
75	24	0.6	105	758	3.2	135	24.0	17.9
76	27	0.6	106	850	3.4	136	26.9	19.0
77	30	0.6	107	954	3.6	137	30.2	20.1
78	34	0.7	108	1071	3.8	138	33.9	21.3
79	38	0.7	109	1201	4.0	139	38.0	22.6
80	43	0.8	110	1348	4.2	140	42.6	23.9
81	48	0.8	111	1512	4.5	141	47.8	25.3
82	54	0.8	112	1697	4.8	142	53.7	26.8
83	60	0.9	113	1904	5.0	143	60.2	28.4
84	68	1.0	114	2136	5.3	144	67.6	30.1
85	76	1.0	115	2397	5.7	145	75.8	31.9
86	85	1.1	116	2689	6.0	146	85.0	33.7
87	95	1.1	117	3018	6.4	147	95.4	35.7
88	107	1.2	118	3386	6.7	148	107.1	37.9
89	120	1.3	119	3799	7.1	149	120.1	40.1
90	135	1.3	120	4263	7.6	150	134.8	42.5

The distance is based upon the assumption that 60% of the 1st Fresnel is clear.

Chapter 3. Installing the Antenna

PLANNING ANTENNA INSTALLATION

Plan the day for your outdoor antenna installation carefully. Do not install the antenna in wet or windy conditions, during a thunderstorm, or when the area in which the equipment is to be installed is covered with ice or snow.

The grounding system for the antenna mast, Tsunami MP.11a hardware, and surge arrestor should be installed before the cable from the antenna is connected to the surge arrestor. This protects your system against lightning strikes during installation.

Familiarize yourself with the antenna and the antenna-specific mounting instructions prior to climbing any roof or ladder. Installing and testing all equipment before beginning the actual rooftop installation will help you to determine whether all required equipment and items are available and are functioning properly.

To verify the equipment prior to installation, you may need to follow the guidelines as described in the documentation that comes with the Tsunami MP.11a first.

SAFETY PRECAUTIONS

Read this section carefully before beginning the installation. All of the following requirements should be satisfied prior to starting installation of your outdoor antennas.

DANGER!

The Tsunami outdoor antennas are intended for mounting on a roof, or on the side of a building. Installation shall not be attempted by someone who is not trained or experienced in this type of work. The antenna has to be installed by a suitably trained professional installation technician. The site prerequisites have to be checked by a person familiar with the national electrical code, and other regulations governing this type of installation.

Outdoor antennas and antenna cables are electrical conductors. Transients or electrostatic discharges that may occur at the antenna (for example a lightning strike during thunderstorms) may damage your electronic equipment and cause personal injury or death to persons touching the exposed metal connectors of the antenna cable.

When installing, disconnecting or replacing one of the cabling components, you must ensure at all times that each exposed metal connectors of the antenna cabling system will be grounded locally during the work.

Do not install this antenna where there is any possibility of contact with high-voltage arc-over from power cables or service drops to buildings. The antenna, supporting mast or tower must not be close to any power lines during installation, removal or in the event of part of the system should accidentally fail. Apply a 'Danger' label to a plainly visible area of the antenna support structure.

Do not climb rooftops in wet or windy conditions, during a thunderstorm or when the area where the equipment will be installed is covered with ice or snow.

Do not touch antennas, surge arrestors and antenna cables during a thunderstorm.

The location where you will install the antenna(s) must be at a safe distance from power lines or telephone lines. The safe distance should be at least twice the height of the antenna mast plus the height of the antenna.

Antennas shall be mounted in such a manner to minimize the potential for human contact during normal operation. In order to avoid the possibility of exceeding the FCC radio frequency exposure limits, human proximity to the antenna shall not be less than 20 cm (8 inches) during normal operation.

The low-loss antenna cable that will connect the antenna with the surge arrester must be at least 1 m (3 ft) away from any high voltage or high current cable.

Check whether the antenna mast and its guy wires or wall bracket are positioned correctly and secured properly to the roof or wall(s).

Check whether the grounding system for the antenna mast, the Tsunami MP.11a hardware and surge arrester have been installed. The grounding system must comply with the requirements as described in "Grounding System."

Always consult a qualified electrician if you are in doubt as to whether the antenna mast, the surge arrester and Tsunami MP.11a hardware are properly grounded.

The antenna cable between the antenna and the surge arrester must be grounded at all times. If the cable is disconnected at one end for some reason (for example, to replace the surge arrester) then you must ensure that the exposed metal connector of the cable is grounded locally during the work.

INSTALLATION OVERVIEW

The installation process can be summarized in the following steps:

1. Verify that the support structure for the antenna has been connected to the grounding system. If this is not the case, you should do so now.
2. Connect the exposed metal connectors of the low-loss antenna cable to the grounding system.
3. Mount the antenna to the support structure, following the guidelines as described for your antenna.
4. Connect the antenna cable to the antenna.
5. Route the antenna cable to the surge arrester that has been installed indoors.
6. Connect the antenna cable to the surge arrester.
7. Attach the surge arrester to the N-type male connector pigtail hanging from the cable opening in the Tsunami MP.11.
8. Run the Link Test diagnostics of the management tools that come with the Tsunami MP.11a to aim the antenna and verify optimal placement.
9. Once the antenna is correctly positioned, and you have verified the installation works properly, secure all cables and use weatherproofing tape to seal all outdoor connectors.

Note: When you must remove or relocate the antenna, follow the Safety Precautions at the beginning of this chapter and follow the steps listed above in exactly the reverse order.

MOUNTING THE ANTENNA

Proxim Corporation offers multiple antennas to set up a wireless link. As the mounting procedures for the various antennas differ from one another, consult the documentation you received from the antenna manufacturer for mounting procedures.

When mounting multiple antennas on a single mast, use the following methods to minimize the influence of cross-talk interference between the antennas:

- Place your antennas as far apart as you can.
- Alternate the mounting of directional antennas for vertical and horizontal polarization.

Connecting the Antenna Cable

Once the antenna is properly installed, you can connect the antenna to the Base Station or Subscriber Unit by way of the surge arrester:

1. Connect the antenna cable to the antenna.
2. Secure the antenna cable to the mast so that the cable connectors do not support the full weight of the cable.
3. Connect the opposite end of the antenna cable to the surge arrester.

CAUTION! *To avoid damage to the antenna cable and connectors, refrain from using tools to tighten the cable connectors.*

4. Prior to securing the cable along its complete length, run the Link Test diagnostics of the management tools that comes with Tsunami MP.11a to analyze wireless performance and optimal placement of the outdoor antenna. How to use this tools is described in the documentation that comes with the Tsunami MP.11a or can be from the Proxim website at <http://www.expressresponse.com/proxim02/>.
5. If required, adjust the direction of the antenna.
6. Once the installation has been fully tested, tighten the nuts of the antenna to “lock” the antenna into its position.

CAUTION! *Avoid over-tightening of the connector, and nuts and screws used to mount the antenna, to prevent damage to your Tsunami MP.11a hardware.*

7. Secure the cable along its complete length with cable ties or electrical tape to relieve strain on the antenna connector properly. No part of the cable should be allowed to hang free. This is especially important for those parts that are routed outside the building.
8. Proceed as described in the next section to weatherproof all outdoor coax connectors.

Sealing the Cable Connectors

Most problems associated with wireless outdoor installations are related to degrading performance due to corrosion of the antenna cable and cable connectors. To avoid this type of problem, you must always seal the cable connectors that are located outdoors using the weatherproofing tape provided.

You are advised to seal the connectors only after you have verified optimal alignment of the antennas using the Link Test as described in the documentation that comes with the Tsunami MP.11. Doing so lets you adjust antenna placement and cable routing without removing the tape.

1. Prepare the cable and connectors so that they are free from dust, dirt and grease.
2. Attach the tip of the weatherproofing tape to the cable just above the connector. Holding the tape in its position, now stretch the tape and wind it half-overlapped around the cable and connectors to form a void-free joint. The degree of stretch may vary in different sections of the joint, as long as the overlaps accomplish a void-free application.

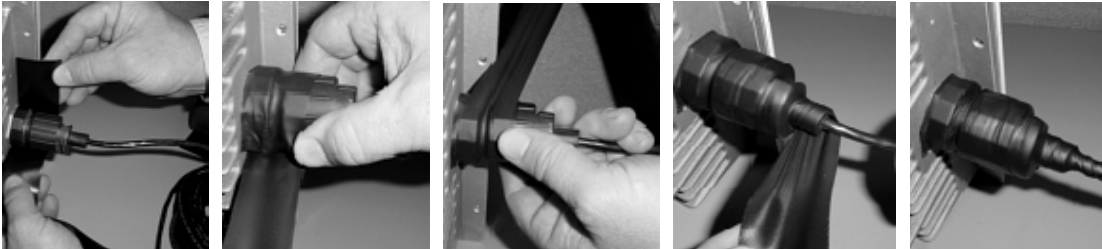

3. To protect the weatherproofing stretch tape from the effects of Ultra-Violet (UV) radiation (for example, from direct sunlight), you should protect the joint with two half-overlapped layers of any vinyl plastic electrical tape. Alternatively, you can apply silicone sealer to protect the weatherproofing tape from sunlight, rain and other weather conditions.

Grounding System

Direct grounding of the antenna mast, Tsunami MP.11a hardware and surge arrestor is very important.

Note: A safety grounding system is necessary to protect your Tsunami MP.11a hardware from lightning strikes and the build-up of static electricity.

WARNING! *The antenna mast, Tsunami MP.11a hardware and surge arrestor must be connected to the same ground, using an equi-potential bonding conductor.*

A good electrical connection should be made to one or more ground rods, using at least a 10AWG ground wire and non-corrosive hardware. The grounding system must comply with the National Electrical Code and safety standards that apply in your country. Always check with a qualified electrician if you are in doubt whether your Tsunami MP.11a hardware installation is properly grounded or not.

Antenna Alignment

For optimal performance of your wireless link, make sure the antennas are properly aligned (facing one another “eye-to-eye”). To align the antennas:

- Use a pair of binoculars or a map of the area and a compass to point the antennas to one another.
- Use the **Link Test** option of the management tools that come with the Tsunami MP.11a to analyze the radio link quality.
- The Link Test option lets you display the radio signal strength in relation to the noise in the signal path.
- If required, you can interactively optimize the antenna alignment with the Link Test, by making small modifications in the antenna orientation.
- Alternatively, consult a professional Antenna Installation Service to optimize the antenna alignment.

Omni-directional antennas are characterized by a wide radiation pattern. Therefore, alignment of this type of antennas is less critical than alignment of directional antennas.

Antenna Polarization

Tsunami outdoor antennas are standard mounted for vertical polarization.

In some cases, you might consider mounting the antenna for horizontal polarization. For example, to minimize the influence of cross-talk between antennas when:

- You plan to mount multiple directional antennas to the same mast.
- Your wireless link receives interference from a vertically polarized neighboring installation.

Mounting for horizontal polarization is not supported for omni-directional grid antennas.

Note: For optimal wireless link performance, you must always verify that the antenna polarization on both ends of the wireless link is the same. Consult the corresponding instruction appendixes for changing the antenna polarization.

Antenna Cable Routing

The antenna cable must be routed and fixed in such a way that installation technicians have a clear passage area. All connectors that are located outdoors must have a weatherproof seal. You are advised to seal connectors only after you have completed the final radio tests.

BEFORE CLIMBING THE ROOF...

Before you start installing, check whether you have all the required components to set up an outdoor wireless link. For each side of a wireless outdoor wireless link you need:

- One or two low-loss antenna cables
- A female-female converter N-connector in case you want to use two antenna cables
- Tools and material to mount the antenna
- Tape or wraps to attach the antenna cable, for example to the mast
- Grounding material such as cable and connector

If an item is missing or damaged during shipment, inform your supplier.

Appendix A. Outdoor Antenna Equipment

As described previously, Proxim Corporation offers different types of outdoor antennas and cable lengths for your network design.

The directional antennas provide maximum range, but due to their narrow beamwidth, these antennas require precise antenna alignment to achieve optimal performance. The higher the antenna gain, the more precise the alignment should be.

Directional antennas are typically used to connect:

- A Base Station Unit and a Subscriber Unit in a point-to-point link
- A Subscriber Unit in a point-to-multipoint network

The omni-directional antennas have, by nature, an omni-directional azimuth pattern that makes them easy to install. There is also a gain beamwidth relation for omni-antennas: The higher the gain of the omni-antenna, the narrower the vertical beamwidth. In a hilly terrain, a 7dBi omni-directional antenna can be a better solution than the 10 dBi omni-directional antenna.

The 12 dBi wide-angle antenna is a good Base Station antenna for hilly terrain. It combines a wide opening angle with relatively high gain. The mounting brackets allow tilting of the antenna. This antenna also is used when the amount of traffic in a cell is too high for a single Base Station with an omni-directional antenna. The wide-angle antenna allows dividing the cell into three sectors that each can be serviced by a Base Station.

For beamwidth and gain characteristics of the various antennas, consult the appendixes of this manual, which describe each antenna in more detail.

The length of the antenna cable also has an impact on the maximum range that can be achieved with the antenna combination (see "Cable Factor" on page 17).

Depending upon local radio regulations in a number of countries that limit the maximum output power, Proxim Corporation offers different outdoor antenna products in the various countries around the world.

Data Speed of the Wireless Link

By default, the radio of Tsunami MP.11a products transmits at the highest available transmit rate.

As data transmissions at lower speeds can travel larger distances than transmissions at the highest transmit rate, the system lets you choose a lower data rate to increase the maximum range. For information about customizing the transmit rate of your system, consult the *Tsunami MP.11 and MP.11a Installation and Management Guide* (which is shipped with the Tsunami MP.11a).

ANTENNA LIST

Table 7. Antenna List

Type	Manufacturer	Model Number	Frequency Range	Mid-Band Gain
Omni	Stella Doradus	52 2360	5.200 – 5.300 MHz	10 dBi
	Stella Doradus	52 3360	5.200 – 5.300 MHz	13 dBi
	Stella Doradus	58 2360	5.700 – 5.900 MHz	10 dBi
	Stella Doradus	58 3360	5.700 – 5.900 MHz	13 dBi
Sector	SmartAnt	R0320-057	5.15 – 5.875 MHz	11 dBi
	Mars	MA-WC50-5X	5.15 – 5.875 MHz	17 dBi
Panel	SmartAnt	R0320-056	5.15 – 5.875 MHz	8 dBi
	SmartAnt	R0320-091	5.15 – 5.85 MHz	15 dBi
	SmartAnt	R0209-116	5.25 – 5.875 MHz	18 dBi
	SmartAnt	R0209-149	5.725 – 5.875 MHz	23 dBi
1-Foot Flat Panel	Gabriel	DFPD1-52	5.25 – 5.85 MHz	23.5 dBi
	Andrew	FPA5250D12-N	5.25 – 5.85 MHz	23.6 dBi
	Mars	MA-WA-58-1X	5.725 – 5.85 MHz	23 dBi
2-Foot Flat Panel	Gabriel	DFPD2-52	5.25 – 5.85 MHz	28 dBi
	Andrew	FPA5250D24-N	5.25 – 5.86 MHz	28.2 dBi
	RSI	A57A24-U	5.725 – 5.85 MHz	26.5 dBi
2-Foot Parabolic	Gabriel	SSP2-52B	5.25 – 5.85 MHz	28.5 dBi
	Gabriel	SSD2-52A	5.25 – 5.85 MHz	28.4 dBi
	Gabriel	HSSP2-52	5.25 – 5.85 MHz	28.1 dBi
	Radio Waves	SP2-5.2	5.25 – 5.85 MHz	28.3 dBi
	Radio Waves	SPD2-5.2	5.25 – 5.85 MHz	28.1 dBi
	Andrew	P2F-52	5.25 – 5.85 MHz	29.4 dBi
	Andrew	PX2F-52	5.25 – 5.85 MHz	29.4 dBi
	RSI	P-57C24	5.75 – 5.85 MHz	29 dBi
3-Foot Parabolic	Radio Waves	SP3-5.2	5.25 – 5.85 MHz	31.4 dBi
	Radio Waves	SPD3-5.2	5.25 – 5.85 MHz	31.1 dBi
	Andrew	P3F-52	5.25 – 5.85 MHz	33.4 dBi
	Andrew	PX3F-52	5.25 – 5.85 MHz	33.4 dBi

Notes:

- All Proxim radios require professional installation.
 - Antennas with gain less than 8 dBi are not allowed.
 - Antennas of other makes can be used with the HZB-US5358-11A device (Tsunami MP.11a), but must be of the same type, dimensions, and gain as those listed.
-

Appendix B. Antenna Cabling System

OUTDOOR CABLING COMPONENTS

To connect your Tsunami MP.11a hardware to an outdoor antenna installation, you will need the following cabling components:

- Surge arrestor
- Low-loss antenna cables
- One of the outdoor antennas described in Appendix C.

When purchasing new Tsunami MP.11a products, each of these components will be equipped with standard N-type connectors.

When ordering separate components, for example as a spare part or replacement to previously purchased Tsunami outdoor antenna equipment, carefully read the note on the following page to ensure that you order components with an N-type connector that matches the other parts of your outdoor antenna cabling system.

SELECTING THE CORRECT CONNECTOR TYPE

All cabling components of the Tsunami outdoor antenna system come with standard-N type connectors as depicted in the following table.

Table 8. Standard N-Type Connector Diagram



Cabling Component	Standard-N Cabling Systems
a Pigtail attached to MP.11	1 Proprietary connector 2 Stand-N male
b Surge arrestor	Reverse polarity-N female on both ends
c Low-loss cable	Reverse Polarity-N male on both ends
d Outdoor antenna	Reverse polarity-N female

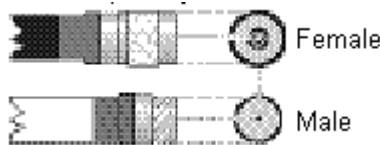

Note that the gender of the connector is not determined by the connector's thread, but by its center pin; a solid center pin = male, a hollow pin = female.

Note: Previously marketed Tsunami outdoor antenna systems in FCC regulated countries (such as the USA and Canada) were shipped with a different cabling system, identified by reverse polarity-N connectors (depicted in the following table).

Table 9. Reverse Polarity-N Cabling Diagram



Cabling Component	Reverse Polarity-N Cabling Systems
a Pigtail attached to MP.11	1 Proprietary connector 2 Reverse polarity-N male
b Surge arrester	Reverse polarity-N female on both ends
c Low-loss cable	Reverse Polarity-N male on both ends
d Outdoor antenna	Reverse polarity-N female



Note that the gender of the connector is not determined by the connector's thread, but by its center pin; a solid center pin = male, a hollow pin = female.

DANGER!

Outdoor antennas and antenna cables are electrical conductors. Transients or electrostatic discharges that may occur at the antenna (for example a lightning strike during thunderstorms) may damage your electronic equipment and cause personal injury or death to persons touching the exposed metal connectors of the antenna cable.

To avoid damage and personal injury, the entire antenna cabling system must be grounded at all times.

When installing, disconnecting or replacing one of the cabling components, you must ensure at all times that each exposed metal connectors of the antenna cabling system will be grounded locally during the work.

For example when mounting or replacing the surge arrester:

1. First connect each of the connectors of the low-loss antenna cables to the grounding system.
2. Next connect the cable connector to the grounding system.
3. Finally connect the surge arrester to the grounding system.

Before you proceed, verify that each of the items is properly grounded and that the ground will not interrupted when disconnecting one of the antenna system components.

Check with a qualified electrician if you are in doubt whether the surge arrester and cable connectors are properly grounded.

Only after you have verified that each of the items is properly grounded, replace the surge arrester and disconnect the cables from the grounding system in exactly the reverse order of the previous steps.

SURGE ARRESTOR

The surge arrester (sometimes referred to as a Lightning Protector) can protect your sensitive outdoor router equipment from high-voltage surges caused by discharges and transients at the antenna.

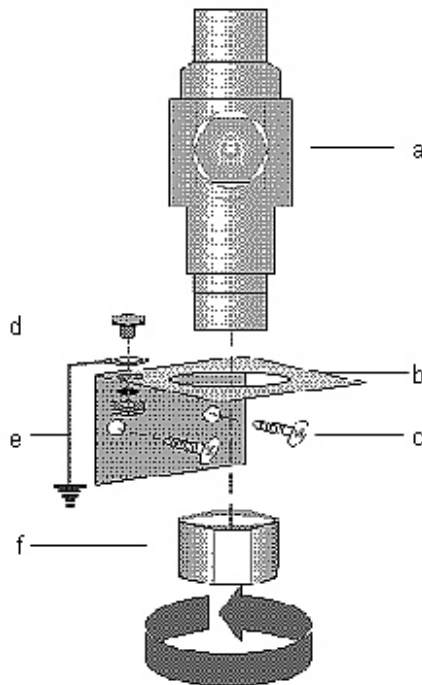

Figure 7. Surge Arrester

To mount the surge arrester:

1. Determine a suitable location for the bracket (item b) as described in “Chapter 1. Preparing for Installation” on page 8.
2. Use the screws (item c) to attach the bracket to the wall.
3. Apply a ring-terminal to the ground wire. Use the bolt, lock-washer, and nut (item d) to connect the ground wire (item e) to the mounting bracket.
4. The ring-terminal and ground wire are not included, but must be installed by a certified electrician familiar with national electricity and safety codes, according to the instructions described in “Grounding System” on page 16.
5. Insert the surge arrester (item a) into the bracket as depicted in the preceding figure.

6. Use the hex-nut (item f) to secure the surge arrestor in its position. Ensure that the surge arrestor is properly connected to the grounding system.

CAUTION!

To avoid damage to electronic equipment and your Tsunami MP.11a equipment always apply the surge arrestor between the outdoor antenna installation and the Tsunami MP.11a hardware or other computing device that is connected to the outdoor antennas.

Table 10. Specifications: Surge Arrestor

Mechanical	
Size	
Height	61 mm (2.4 in)
Diameter	23 x 27.5 mm (0.9 x 1.1 in)
Weight	133 g (4.7 oz.)
Connectors (1)	Standard-N (female on both ends)
Operating Temperature	-40°C (-40°F) to +85°C (+185° F)
Electrical	
Frequency Range	6 GHz
Insertion Loss	0.4 dB
Surge Current	5 kA
Nominal Impedance	50 ohms

LOW-LOSS ANTENNA CABLE

The low-loss antenna cable is available in three standard lengths:

- 6 m (20 ft)
- 15 m (50 ft)
- 22 m (75 ft)

To ensure that you order the right cable length, determine the distance between the intended locations of the Tsunami MP.11a hardware and outdoor antenna carefully.

Table 11. Specifications 6 m (20 ft) Antenna Cable

Mechanical		
Length	6 meter (20 ft)	
Connectors	Standard-N (male on both ends)	
Operating Temperature	-40°C (-40°F) to +85°C (+185° F)	
Diameter (1)	5 mm (0.2 in)	10 mm (0.4 in)
Weight	32.75 g/m (0.022 lbs/ft)	101.2 g/m (0.068 lbs/ft)
Bend Radius	50 mm (2 in)	100 mm (4 in)
Electrical		
Insertion Loss at 5.8 GHz	0.80 dB/m (26.4 dB/100 ft)	0.33 dB/m (10.8 dB/100 ft)
Total for this cable	<6.0 dB	< 3.0 dB
(1) Use of the 10 mm diameter version of this cable is subject to local radio regulations. See "Appendix C. Certified Outdoor Solutions" for information about whether you can use this cable in your country.		

Table 12. Specifications 15 m (50 ft) Antenna Cable

Mechanical	
Length	15 meter (50 ft)
Connectors (1)	Standard-N (male on both ends)
Operating Temperature	-40°C (-40°F) to +85°C (+185° F)
Diameter	10 mm (0.4 in)
Weight	101.2 g/m (0.068 lbs/ft)
Bend Radius	100 mm (4 in)
Electrical	
Insertion Loss	0.33 dB/m (10.8 dB/100 ft) at 5.8 GHz
Total for this cable	< 6.0 dB

Table 13. Specifications 22 m (75 ft) Antenna Cable

Mechanical	
Length	22 m (75 ft)
Connectors (1)	Standard-N (male on both ends)
Operating Temperature	-40°C (-40°F) to +85°C (+185° F)
Diameter	10 mm (0.4 in)
Weight	101.2 g/m (0.068 lbs/ft)
Bend Radius	100 mm (4 in)
Electrical	
Insertion Loss	0.33 dB/m (10.8 dB/100 ft) at 5.8 GHz
Total for this cable	< 8.7 dB

Table 14. Specifications 15 m (50 ft) Extra Low Loss Antenna Cable

Mechanical	
Length	15 meter (50 ft)
Connectors (1)	Standard-N (male on both ends)
Operating Temperature	-40°C (-40°F) to +85°C (+185° F)
Diameter	15 mm (0.59 in)
Weight	194.6 g/m (0.131 lbs/ft)
Bend Radius	150 mm (6 in)
Electrical	
Insertion Loss	0.22 dB/m (7.3 dB/100 ft) at 5.8 GHz
Total for this cable	< 4.0 dB

Appendix C. Recommended Antennas



18 DBI HIGH GAIN DIRECTIONAL PANEL ANTENNA FOR 5.25 TO 5.875 GHZ

Pictured: SmartAnt antenna

Specifications

Electrical	
Frequency Range	5.25-5825 MHz
VSWR	1.5: 1 maximum
Nominal Impedance	50 ohms
Gain	18 dBi
HPBW/horizontal	18 degrees
HPBW/vertical	18 degrees
Polarization	Linear, vertical
Downtilt	0 degrees
Power handling	10W (cw)
Connector	Standard N female
Front-to-back ratio	30 dB

Environmental and Mechanical	
Wind Survival (per EIA-222-F at 100' height)	216 km/hr
Temperature range	-40 to +80 degrees C
Humidity	95% @ 25 degrees C
Lightning protection	DC ground
Size	200 x 200 x 50 mm
Radome color	Black
Radome material	ABS, UV resistant
Weight	0.825 kgw

Dimensions

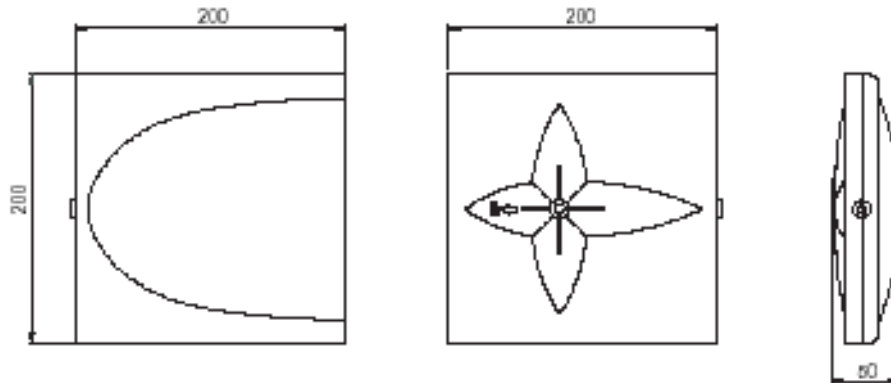

Pattern

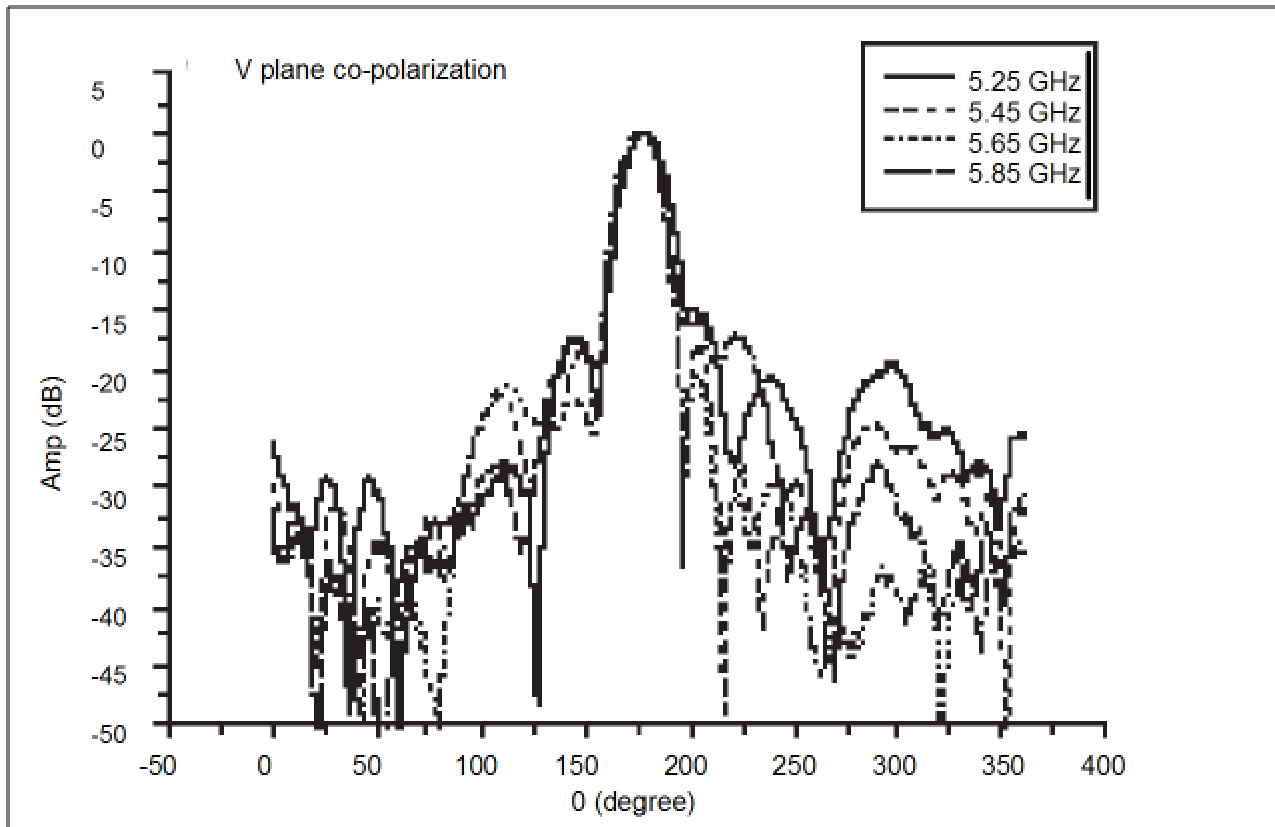

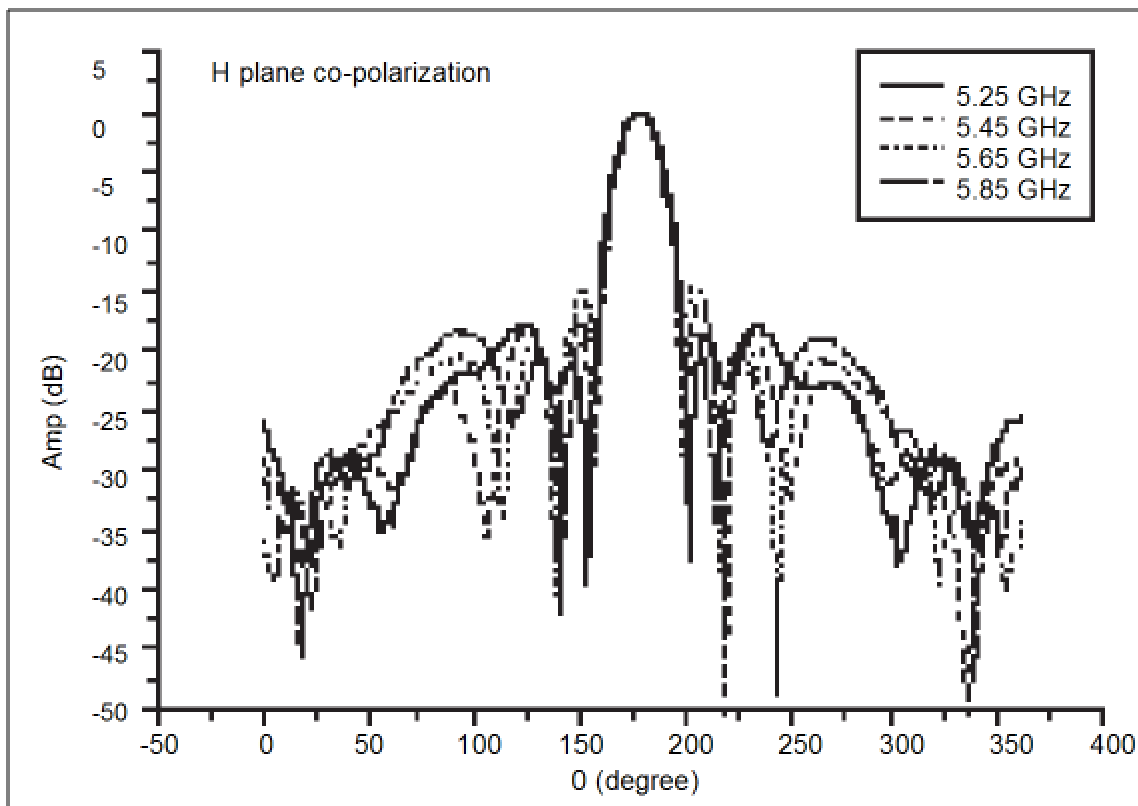
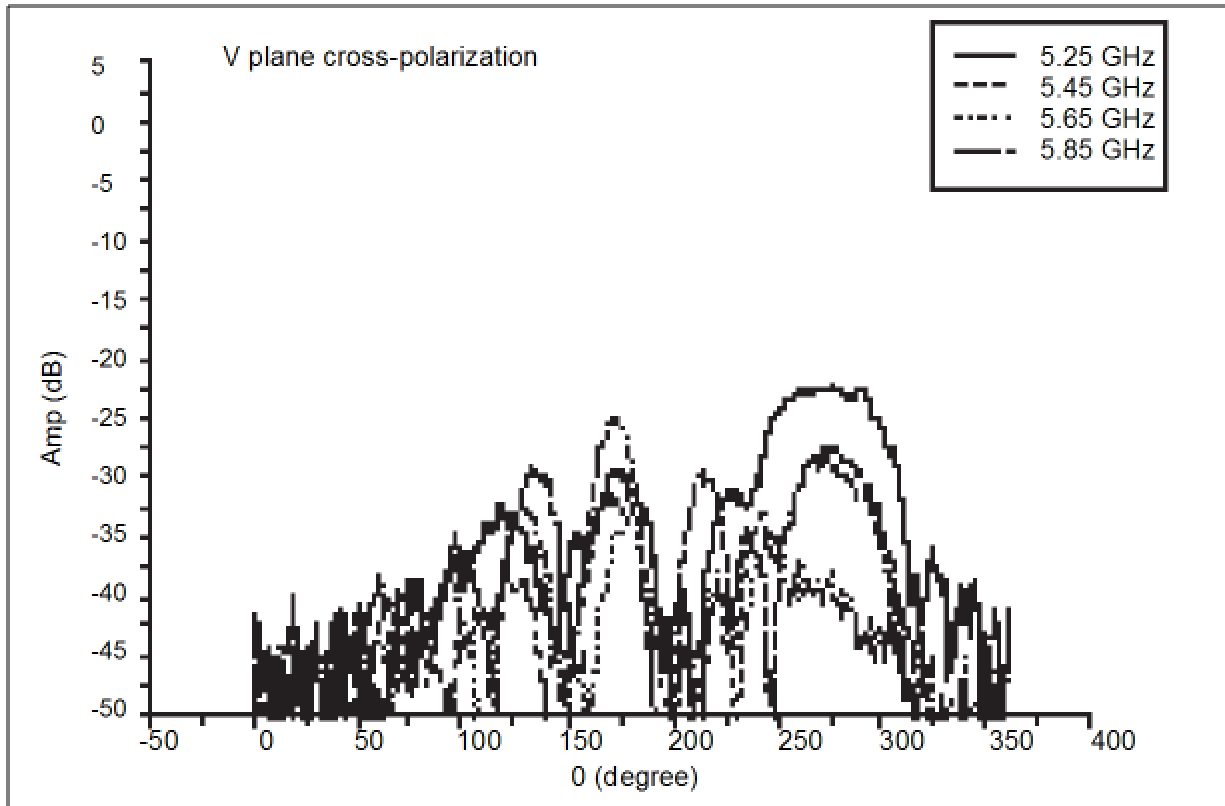

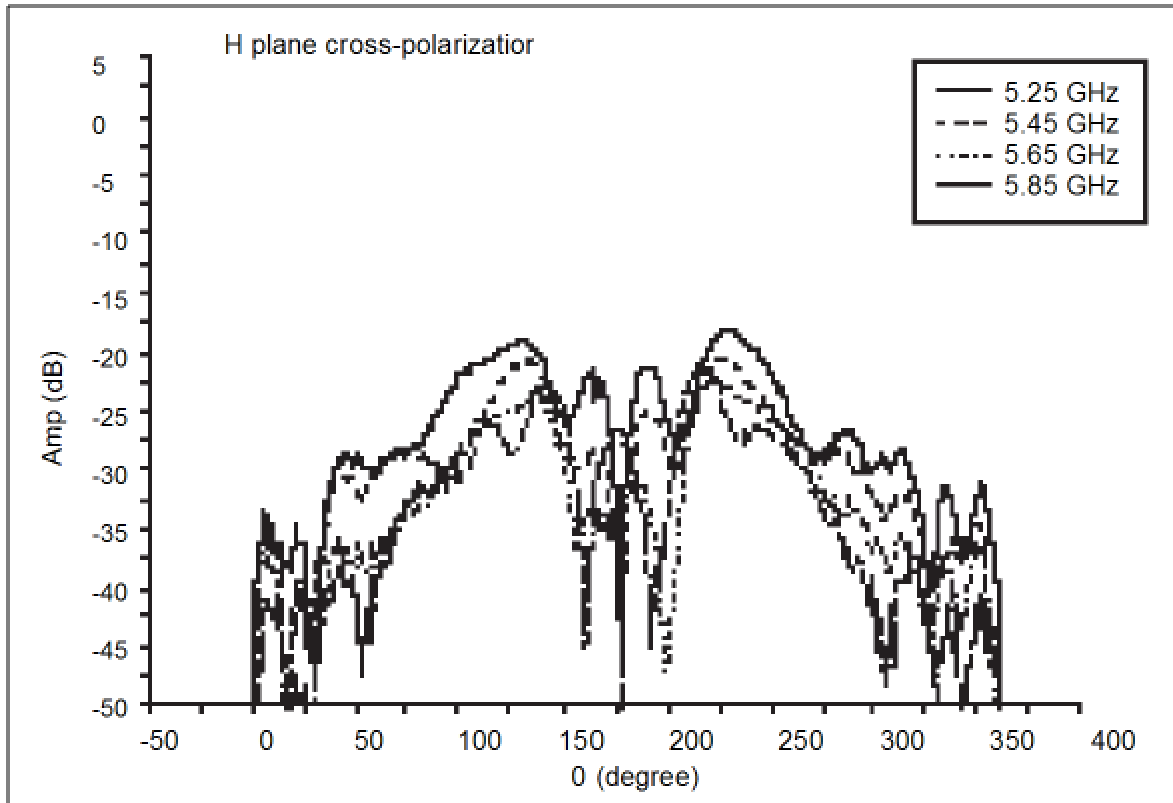

15 DBI HIGH GAIN DIRECTIONAL PANEL ANTENNA FOR 5 GHZ

Pictured: SmartAnt antenna

General Description

This window antenna is a high-gain antenna for the 5 GHz frequency band. This antenna is typically used in combination with a Subscriber Unit. The red heat-shrink tube at the antenna connector of this antenna matches the red heat-shrink tube at the MP.11a antenna connector to easily locate and distinguish the 5 GHz antenna components from their look-alikes operating at 2.4 GHz which do not have red heat-shrink tube.



Mounting Instructions

Package contents:

- Antenna
- Extension Cable (3m)
- Mounting Kit
- Quick Installation Guide

Wall Mount for Outdoor/Indoor Application

- A. Insert the plastic wall plug (2) into the wall
- B. Insert the screw (3) into the plastic wall plug through the antenna mounting hole and tighten

Window Suction Mount for Indoor Application

- A. Insert the window suction cup through the antenna mounting hole.
- B. Turn the suction cup one quarter to lock it into position.
- C. Press the window suction cup onto the window glass.

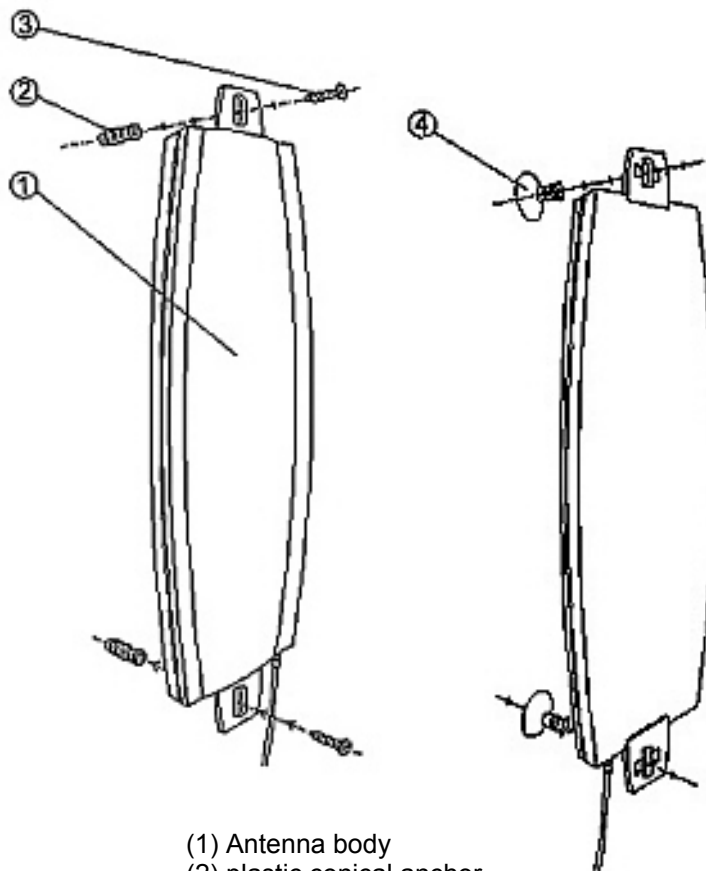

- (1) Antenna body
- (2) plastic conical anchor
- (3) screw
- (4) window suction cup

Specifications

Electrical	
Frequency range	5150 MHz – 5850 MHz
Gain*	15 dBi
VSWR	2.0 : 1 Max.
Polarization	Linear, vertical
HPBW / horizontal	45 degrees
HPBW / vertical	10 degrees
Front to back ratio	18 dB
Downtilt	0 degrees
Power handling	20 W (cw)
Impedance	50 Ohms
Connector	Standard N-female
Cable	ULA-168; 200 cm
Cable loss	2 dB
*exclusive of cable loss	

Environmental and Mechanical	
Survival wind speed	180 km/hr
Temperature	-40° C to +80° C
Humidity	95% @ 25° C
Lightning Protection	DC ground
Radome color	white
Radome material	ABS, UV resistant
Weight	0.6 kgw
Dimensions	330 x 93 x 21 mm

Pattern

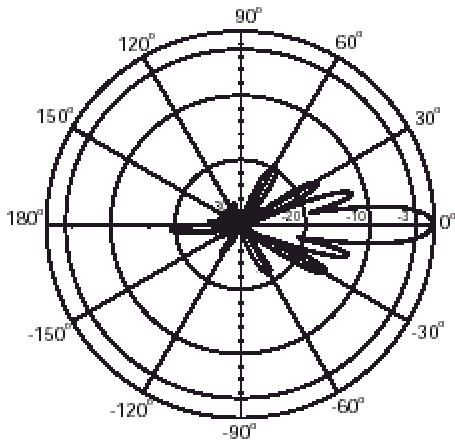

Vertical

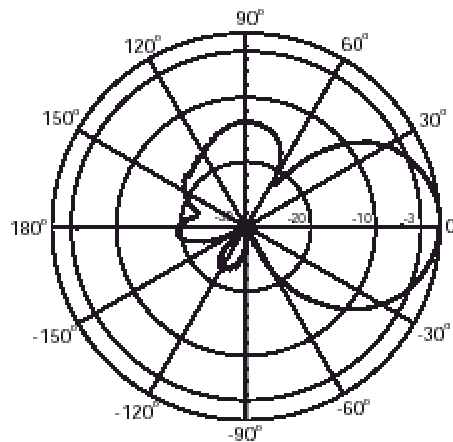

Horizontal

23 DBI HIGH GAIN DIRECTIONAL PANEL ANTENNA FOR 5.8 GHZ

Pictured: SmartAnt antenna

Package Contents

- Antenna
- Extension Cable (50cm)
- Mounting Kit
- Surge Protector
- Water-proof tape
- Quick Installation Guide



Mounting

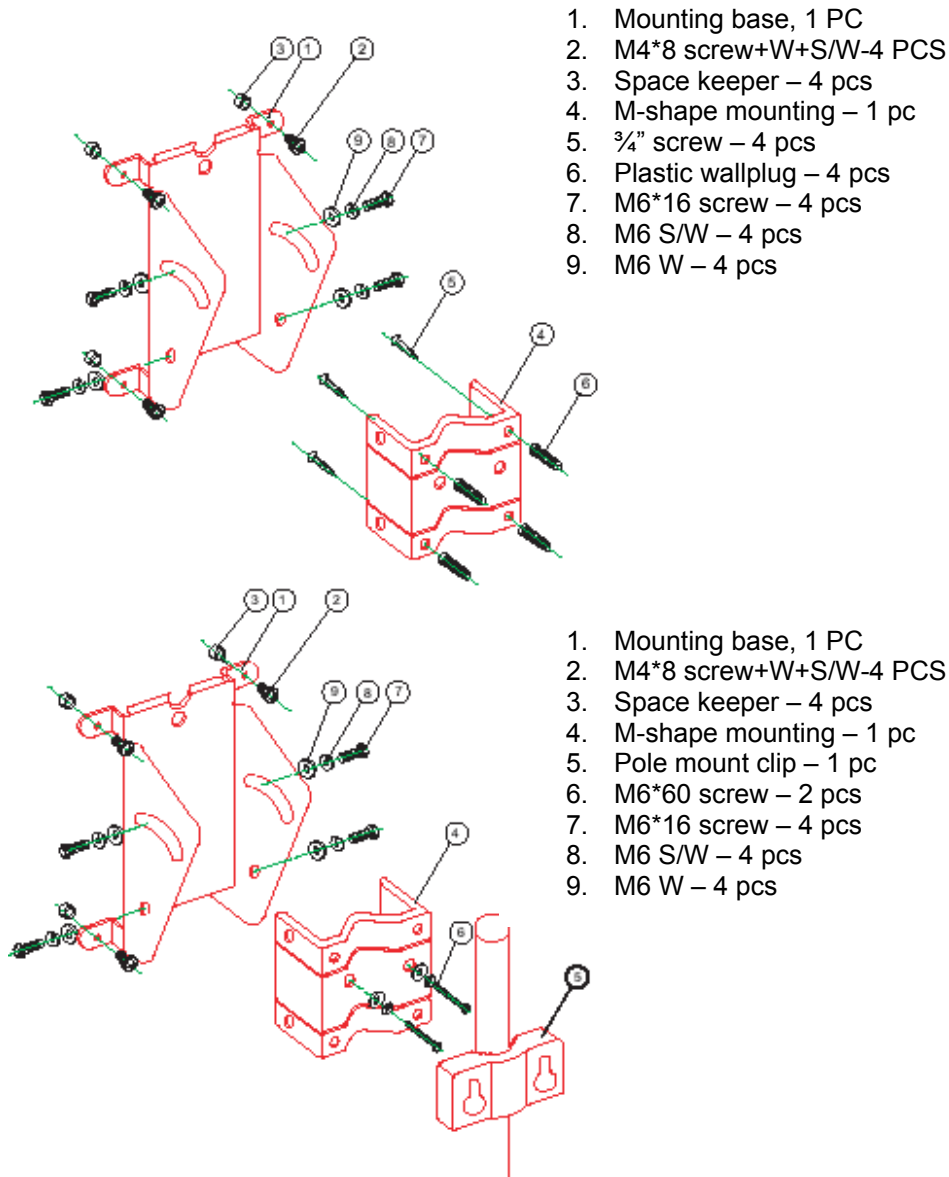

1. Mounting base, 1 PC
2. M4*8 screw+W+S/W-4 PCS
3. Space keeper – 4 pcs
4. M-shape mounting – 1 pc
5. 3/4" screw – 4 pcs
6. Plastic wallplug – 4 pcs
7. M6*16 screw – 4 pcs
8. M6 S/W – 4 pcs
9. M6 W – 4 pcs

1. Mounting base, 1 PC
2. M4*8 screw+W+S/W-4 PCS
3. Space keeper – 4 pcs
4. M-shape mounting – 1 pc
5. Pole mount clip – 1 pc
6. M6*60 screw – 2 pcs
7. M6*16 screw – 4 pcs
8. M6 S/W – 4 pcs
9. M6 W – 4 pcs

Specifications

Electrical

Frequency Range	5725 - 5875 MHz
Nominal Impedance	50 ohms
Gain	23 dBi
Front-to-Back Ratio	40 dB
HPBW/vertical	9 degrees
HPBW/horizontal	9 degrees
Cross Polarization	25 dB
Power handling	20 W (cw)
Connector	Standard N female
VSWR	1.5: 1 maximum

Environmental and Mechanical

Wind Survival (per EIA-222-F at 100' height)	216 km/hr
Temperature range	-40 to +80 degrees C
Humidity	95% @ 25 degrees C
Lightning protection	DC ground
Size	360 x 360 x 16 mm
Weight	1.6 kgw
Radome material	ABS, UV resistant
Housing material	Powder-coating tron
Radome color	white

Pattern

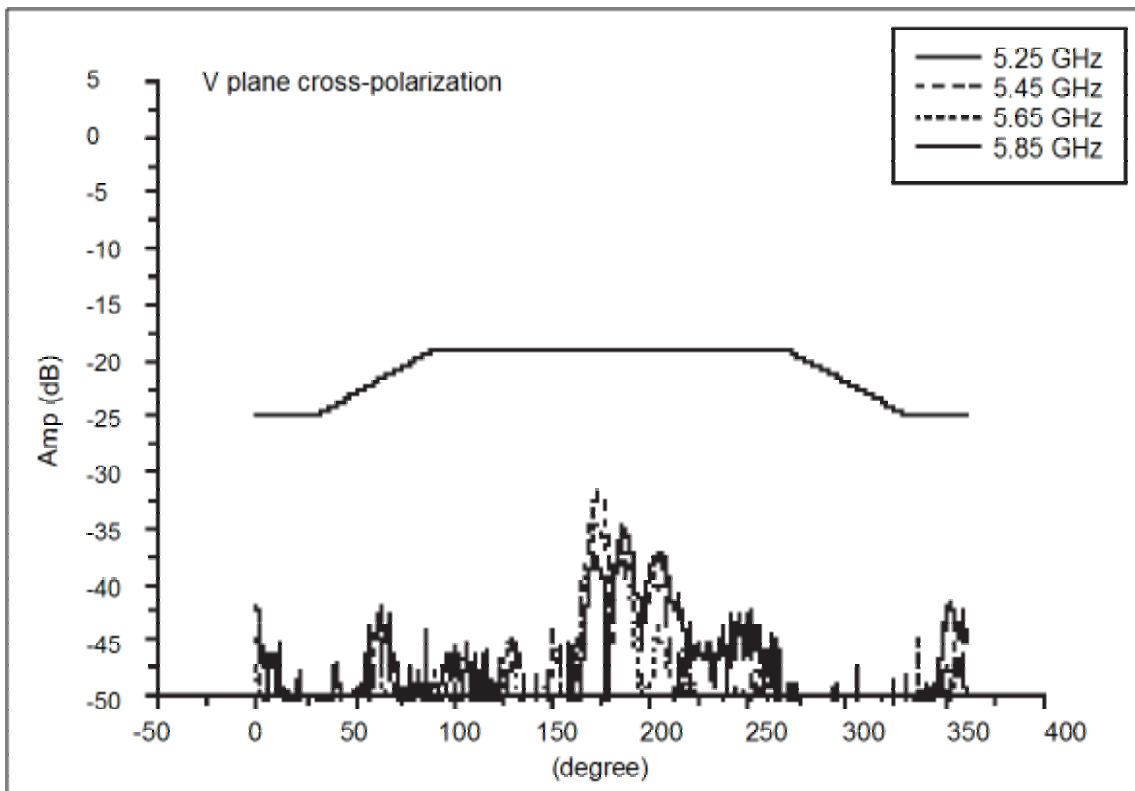
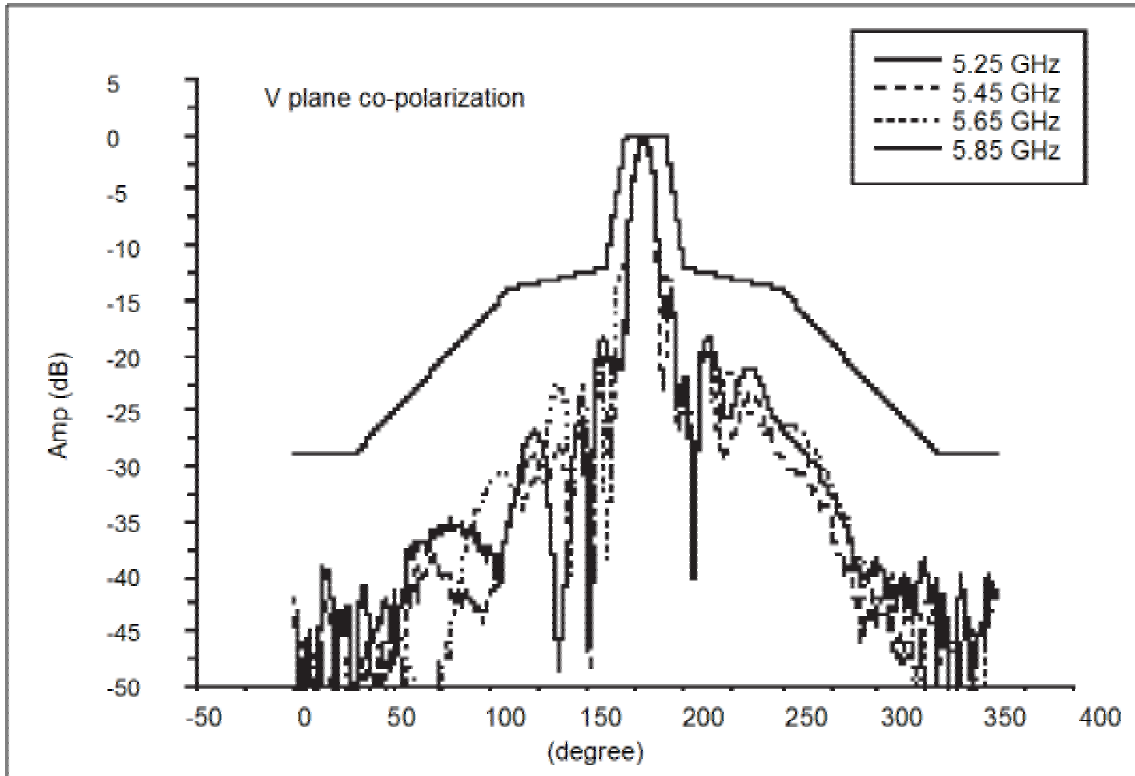

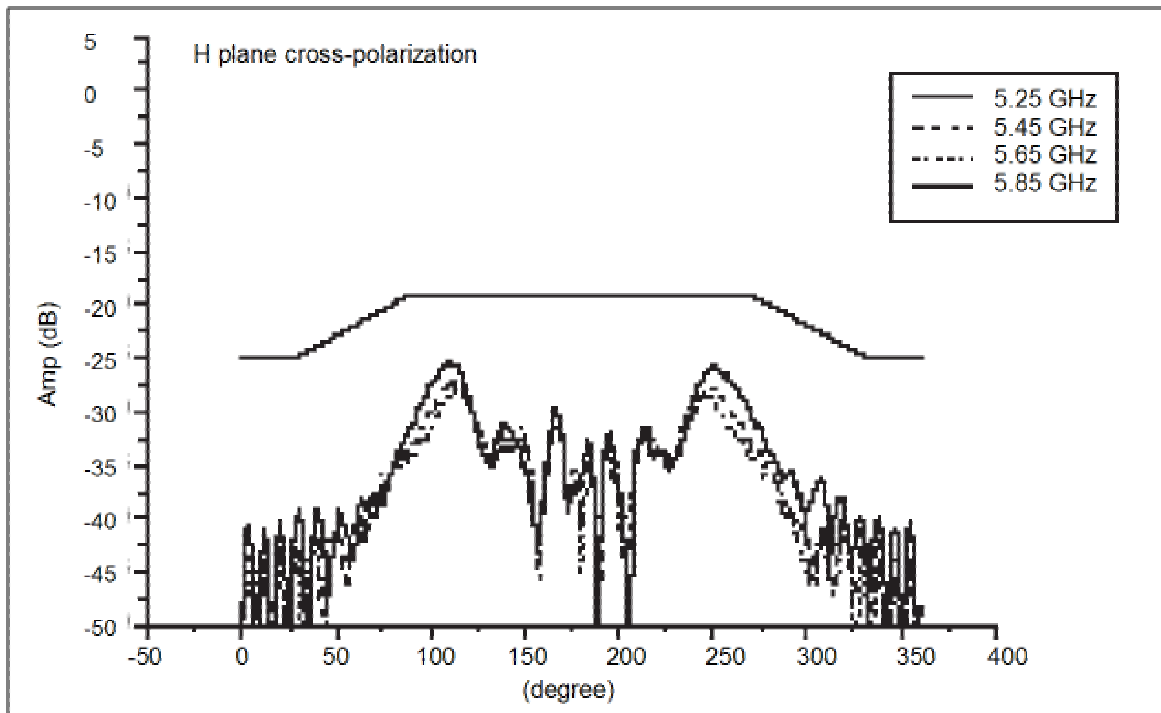
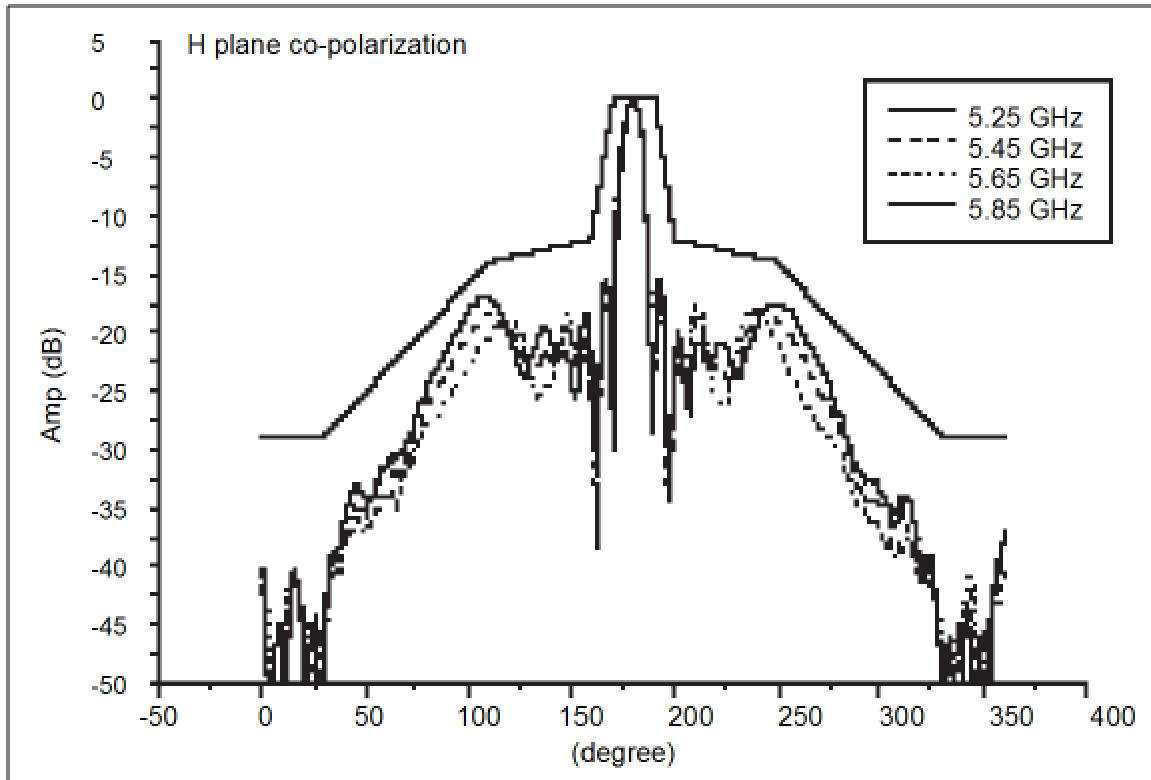

Appendix D. Certified Outdoor Solutions

INTRODUCTION

As radio regulations differ between the various countries world-wide, not all of the outdoor solutions described in this Tsunami Outdoor Antenna Installation Guide may be allowed in the country where you plan to install this equipment.

Local radio regulations or legislation may impose restrictions on the use of specific combinations of:

- Low-loss antenna cables and outdoor antennas.
- Radio channels selected at the Outdoor Routers that are connected to specific outdoor antennas.

Note: Basic rule for selecting a combination of cables and antennas is that no combination is allowed unless explicitly approved in this *Tsunami Outdoor Antenna Installation Guide*. Therefore, always use this Appendix in combination with “Chapter 2. Determining Range and Clearance” on page 16 of this document to select the right type of antenna equipment and to inform your antenna installer and LAN administrator about the impact of regulatory constraints on their job or activities.

SELECTING THE CORRECT CABLES

To comply with local radio regulations, the MP.11a Base Station and Subscriber units have a selectable radio power output level. It can be selected through the TPC (Transmit Power Control) parameter in the user Interface.

The low-loss antenna cables are available in various lengths and diameters:

- 6 m (15 ft) with a diameter of 5 mm (0.2 in) (The cable-loss of this cable is equal to the loss of the 15 m (50 ft) cable.)
- 6 m (15 ft) with a diameter of 10 mm (0.4 in)
- 15 m (50 ft) with a diameter of 15 mm (0.6 in)
- 15 m (50 ft) with a diameter of 10 mm (0.4 in)
- 22 m (75 ft) with a diameter of 10 mm (0.4 in)

When you order the Tsunami MP.11a antenna equipment, make sure that you order cables that comply with the regulations that apply in your country. (See Table 5 on page 24 for the minimum required antenna cable attenuation and corresponding TPC setting.) In case of doubt, consult the Proxim Corporation Sales office for more information.

Appendix E. Channel Frequencies

The following table shows MP.11 (802.11b) channel allocations that vary from country to country. Values listed in bold indicate default channels and frequencies.

Channel ID	FCC/World (GHz)	ETSI (GHz)	France (GHz)	Japan (GHz)
1	2.412	2.412	--	2.412
2	2.417	2.417	--	2.417
3 (default in most countries)	2.422	2.422	--	2.422
4	2.427	2.427	--	2.427
5	2.432	2.432	--	2.432
6	2.437	2.437	--	2.437
7	2.442	2.442	--	2.442
8	2.447	2.447	--	2.447
9	2.452	2.452	--	2.452
10	2.457	2.457	2.457	2.457
11 (default in France)	2.462	2.462	2.462	2.462
12	--	2.467	2.467	2.467
13	--	2.472	2.472	2.472
14				2.484

The following table shows MP.11a (802.11a) channel allocations that vary from country to country. Values listed in bold indicate default channels and frequencies.

Channel ID	FCC	ETSI
56	5.280	—
60	5.300	—
64	5.320	—
100	—	5.500
104	—	5.520
108	—	5.540
112	—	5.560
116	—	5.580
120	—	5.600
124	—	5.620
128	—	5.640
132	—	5.660
136	—	5.680
149	5.745	—
153	5.765	—
157	5.785	—
161	5.805	—
165	5.825	—

Turbo Mode Channels	
Channel ID	FCC
1	5.290*
2	5.300
3	5.760
4	5.800

* Turbo channel ID 1, 5.290 – The MP.11a firmware limits the upper limit of this channel to be below 12.13 dBm for release in the United States and Canada.

Support and Warranty

TECHNICAL SUPPORT

If you are having a problem using a Proxim WAN product and cannot resolve it with the information in the product documentation, gather the following information and contact Proxim Technical Support:

- What kind of network are you using?
- What were you doing when the error occurred?
- What error message did you see?
- Can you reproduce the problem?

Be sure to obtain an RMA number before sending any equipment to Proxim for repair.

To receive E-mail technical support, be sure to include the serial number of the products in question. The serial number can be found on the product and has the following format: ##AT#####. We will be unable to respond to your inquiry without this information.

Access Knowledgebase: Ask a Wireless WAN Product question and get an express response:

WANsupport@proxim.com

E-mail Technical Support: WANtechnicalsupport@proxim.com

Call Technical Support: Toll Free +1-866-674-6626 or +1-408-542-5390

Hours: 6:00 a.m. to 5:00 p.m. M-F Pacific Time

You can find the latest software and documentation at: <http://www.expressresponse.com/proxim02/>.

WARRANTY AND REPAIR

If it appears that your unit needs a repair or replacement, return the unit to your Dealer or Distributor in its original packaging. When returning a defective product for Warranty, always include the following documents:

- The Warranty Repair card (last page of this appendix)
- A copy of the invoice or proof of purchase
- Problem Report Form

Proxim Corporation extends a limited warranty from date of purchase of:

- Twelve (12) months for the Tsunami MP.11a hardware
- Twelve (12) months for the media on which the software is furnished and the reproduction of the software on the media.

Upon proof-of-purchase Proxim Corporation shall, at its discretion, repair or replace the defective item at no cost to the buyer.

Defective items shall be returned to the dealer or distributor:

- Freight prepaid.
- Accompanied by a copy of proof-of-purchase.
- Accompanied by a filled out Warranty and Repair card.

This warranty is contingent upon proper use in the application for which the products are intended and does not cover products which have been modified without the seller's approval or which have been subjected to unusual physical or electrical demands or damaged in any way.

This Warranty constitutes the sole and exclusive remedy of any buyer or seller's equipment and the sole and exclusive liability of Proxim Corporation in connection with the products and is in lieu of all other warranties, express, implied or statutory, including, but not limited to, any implied warranty of merchantability of fitness for a particular use and all other obligations or liabilities of Proxim Corporation.

In no event will Proxim Corporation or any other party or person be liable to you or anyone else for any damages, including lost profits, lost savings or other incidental or consequential damages, or inability to use the software provided on the software media even if Proxim Corporation or the other party person has been advised of the possibility of such damages.

TO BE FILLED OUT BY USER:

Product Description _____
 COMCODE (Product ID) _____
 Serial Number _____
 Invoice Date (dd/mm/yyyy): _____
 Name: _____
 Title _____
 Company _____
 Address _____
 City/State/Zip Code _____
 Country _____
 Telephone _____
 Fax _____

TO BE FILLED OUT BY THE DEALER OR DISTRIBUTOR

Dealer Name _____
 City/State/Zip Code _____
 Country _____
 Telephone _____
 Fax _____
 Warranty (Yes / No) _____
 Comment _____
 Return Approval Reference _____

Reported Problem	Problem Description

Free Manuals Download Website

<http://myh66.com>

<http://usermanuals.us>

<http://www.somanuals.com>

<http://www.4manuals.cc>

<http://www.manual-lib.com>

<http://www.404manual.com>

<http://www.luxmanual.com>

<http://aubethermostatmanual.com>

Golf course search by state

<http://golfingnear.com>

Email search by domain

<http://emailbydomain.com>

Auto manuals search

<http://auto.somanuals.com>

TV manuals search

<http://tv.somanuals.com>